

FCC TEST REPORT	
FCC Part 22 /Part 24	
Report Reference No.	LCS201224030AEG
FCC ID	2AYKD-TB8
Date of Issue.	January 28, 2021
Testing Laboratory Name	Shenzhen LCS Compliance Testing Laboratory Ltd.
Address	101, 201 Bldg A & 301 Bldg C, Juji Industrial Park Yabianxueziwei, Shajing Street, Baoan District, Shenzhen, 518000, China
Applicant's name	Shanghai Armour Technology Co., Ltd.
Address	Room 411, building 10, 471 Guiping Road, Xuhui District, Shanghai, China
Test specification	
Standard	FCC Part 22: Public Mobile Services
	FCC Part 24: Personal Communication Services
Test Report Form No	LCSEMC-1.0
TRF Originator	Shenzhen LCS Compliance Testing Laboratory Ltd.
Master TRF	Dated 2011-03
Shenzhen LCS Compliance Testing Laboratory Ltd. All rights reserved.	
This publication may be reproduced in whole or in part for non-commercial purposes as long as the Shenzhen LCS Compliance Testing Laboratory Ltd. is acknowledged as copyright owner and source of the material. Shenzhen LCS Compliance Testing Laboratory Ltd. takes no responsibility for and will not assume liability for damages resulting from the reader's interpretation of the reproduced material due to its placement and context.	
Test item description	TABLET
Trade Mark	armourphone
Model/Type reference	TB8
	DC 3.8V by Rechargeable Li-ion Battery, 9000mAh
Ratings	For Adapter Input: AC 100-240V, 50/60Hz, 0.35A Max
	Adapter Output: DC 5.0V, 2A
Hardware version	HW_V1.0
Software version	Android10_TB8_V1_0
Frequency	GSM 850MHz; PCS 1900MHz
Result	PASS

Compiled by:

Jin Wang

Jin Wang/ File administrator

Supervised by:

Linda He

Linda He / Technique principal

Approved by:

Gavin Liang

Gavin Liang/ Manager

TEST REPORT

Test Report No. : LCS201224030AEG	January 28, 2021 Date of issue
--	-----------------------------------

Equipment under Test : TABLET

Model /Type : TB8

Applicant : Shanghai Armour Technology Co., Ltd.

Address : Room 411, building 10, 471 Guiping Road, Xuhui District, Shanghai, China

Manufacturer : Shanghai Armour Technology Co., Ltd.

Address : Room 411, building 10, 471 Guiping Road, Xuhui District, Shanghai, China

Factory : /

Address : /

Test Result:	PASS
---------------------	-------------

The test report merely corresponds to the test sample.
It is not permitted to copy extracts of these test result without the written permission of the test laboratory.

Revision History

Revision	Issue Date	Revisions	Revised By
000	January 28, 2021	Initial Issue	Gavin Liang

Contents

1	<u>TEST STANDARDS</u>	<u>5</u>
2	<u>SUMMARY</u>	<u>6</u>
2.1	General Remarks	6
2.2	Product Description	6
2.3	Equipment under Test	9
2.4	Short description of the Equipment under Test (EUT)	9
2.5	Internal Identification of AE used during the test	9
2.6	Normal Accessory setting	9
2.7	EUT configuration	10
2.8	Related Submittal(s) / Grant (s)	10
2.9	Modifications	10
2.10	General Test Conditions/Configurations	10
3	<u>TEST ENVIRONMENT</u>	<u>11</u>
3.1	Address of the test laboratory	11
3.2	Test Facility	11
3.3	Environmental conditions	11
3.4	Test Description	11
3.5	Equipment Used during the Test	13
3.6	Measurement uncertainty	14
4	<u>TEST CONDITIONS AND RESULTS</u>	<u>15</u>
4.1	Output Power	15
4.2	Radiated Spurious Emission	19
4.3	Occupied Bandwidth and Emission Bandwidth	23
4.4	Band Edge Complicance	26
4.5	Spurious Emission on Antenna Port	29
4.6	Frequency Stability Test	39
4.7	Peak-to-Average Ratio (PAR)	42
5	<u>TEST SETUP PHOTOGRAPHS OF EUT</u>	<u>45</u>
6	<u>EXTERIOR PHOTOGRAPHS OF THE EUT</u>	<u>45</u>
7	<u>INTERIOR PHOTOGRAPHS OF THE EUT</u>	<u>45</u>

1 TEST STANDARDS

The tests were performed according to following standards:

[FCC Part 22 \(10-1-16 Edition\)](#): Cellular Radiotelephone Service.

[FCC Part 24\(10-1-16 Edition\)](#): Broadband PCS.

[ANSI/TIA-603-E-2016](#): Land Mobile FM or PM Communications Equipment Measurement and Performance Standards.

[47 CFR FCC Part 15 Subpart B](#): Unintentional Radiators.

[FCC Part 2](#): Frequency Allocations And Radio Treaty Matters: General Rules And Regulations.

[ANSI C63.4:2014](#): Methods of Measurement of Radio-Noise Emissions from Low-Voltage Electrical and Electronic Equipment in the Range of 9 kHz to 40 GHz.

2 SUMMARY

2.1 General Remarks

Date of receipt of test sample	:	December 29, 2020
Testing commenced on	:	December 29, 2020 ~ January 27, 2021
Date of Report	:	January 28, 2021

2.2 Product Description

The **Shanghai Armour Technology Co., Ltd.**'s Model: TB8 or the "EUT" as referred to in this report; more general information as follows, for more details, refer to the user's manual of the EUT.

EUT	:	TABLET
Test Model	:	TB8
Power Supply	:	DC 3.8V by Rechargeable Li-ion Battery, 9000mAh For Adapter Input: AC 100-240V, 50/60Hz, 0.35A Max Adapter Output: DC 5.0V, 2A
Hardware Version	:	HW_V1.0
Software Version	:	Android10_TB8_V1_0

Bluetooth

Frequency Range	:	2402MHz ~ 2480MHz
Bluetooth Version	:	V4.0
Channel Number	:	79 channels for Bluetooth V4.0(BDR/EDR) 40 channels for Bluetooth V4.0(BT LE)
Channel Spacing	:	1MHz for Bluetooth V4.0(BDR/EDR) 2MHz for Bluetooth V4.0(BT LE)
Modulation Type	:	GFSK, $\pi/4$ -DQPSK, 8-DPSK for Bluetooth V4.0(BDR/EDR) GFSK for Bluetooth V4.0(BT LE)
Antenna Description	:	Internal Antenna, 1.5dBi(Max.)

WIFI(2.4G Band)

Frequency Range	:	2412MHz ~ 2462MHz
Channel Spacing	:	5MHz
Channel Number	:	11 Channels for 20MHz bandwidth (2412~2462MHz) 7 Channels for 40MHz bandwidth (2422~2452MHz)
Modulation Type	:	IEEE 802.11b: DSSS (CCK, DQPSK, DBPSK) IEEE 802.11g: OFDM (64QAM, 16QAM, QPSK, BPSK) IEEE 802.11n: OFDM (64QAM, 16QAM, QPSK, BPSK)
Antenna Description	:	Internal Antenna, 1.5dBi(Max.)

5.2G WLAN

Frequency Range	:	5180MHz-5240MHz
Channel Number	:	4 channels for 20MHz bandwidth(5180MHz-5240MHz) 2 channels for 40MHz bandwidth(5190MHz~5230MHz) 1 channels for 80MHz bandwidth(5210MHz)
Modulation Type	:	IEEE 802.11a/n20/n40/ac20/ac40/ac80: OFDM (64QAM, 16QAM, QPSK, BPSK)

Antenna Description : Internal Antenna, 1.5dBi(Max.)

5.8G WLAN

Frequency Range : 5745MHz-5825MHz

Channel Number : 5 channels for 20MHz bandwidth(5745MHz-5825MHz)
2 channels for 40MHz bandwidth(5755MHz~5795MHz)
1 channels for 80MHz bandwidth(5775MHz)

Modulation Type : IEEE 802.11a/n20/ac20/n40/ac40/ac80: OFDM (64QAM, 16QAM, QPSK, BPSK)

Antenna Description : Internal Antenna, 1.5dBi(Max.)

2G

Support Band : GSM 900 (EU-Band) DCS 1800 (EU-Band)
 GSM 850 (U.S.-Band) PCS 1900 (U.S.-Band)

Release Version : R99

GPRS Class : Class 12

EGPRS Class : Class 12

Type Of Modulation : GMSK for GSM/GPRS; 8PSK for EGPRS

Antenna Description : Internal Antenna
1.5dBi (max.) For GSM 850
1.5dBi (max.) For PCS 1900

3G

Support Band : WCDMA Band II (U.S.-Band)
 WCDMA Band V (U.S.-Band)
 WCDMA Band IV (U.S.-Band)
 WCDMA Band I (EU-Band)
 WCDMA Band VIII (EU-Band)

Release Version : R6

Type Of Modulation : WCDMA: QPSK; HSDPA/HSUPA: QPSK

Antenna Description : Internal Antenna
1.5dBi (max.) For WCDMA Band II
1.5dBi (max.) For WCDMA Band V

LTE

Support Band : E-UTRA Band 2(U.S.-Band)
 E-UTRA Band 4(U.S.-Band)
 E-UTRA Band 5(U.S.-Band)
 E-UTRA Band 17(U.S.-Band)
 E-UTRA Band 39(Non U.S.-Band)
 E-UTRA Band 41(U.S.-Band)

LTE Release Version : R9

Type Of Modulation : QPSK/16QAM

Antenna Description : Internal Antenna
1.5dBi (max.) For E-UTRA Band 2
1.5dBi (max.) For E-UTRA Band 4
1.5dBi (max.) For E-UTRA Band 5
1.5dBi (max.) For E-UTRA Band 17
1.5dBi (max.) For E-UTRA Band 41

Power Class : Class 3
GPS function : Support and only RX
NFC :
Operating Frequency: : 13.56MHz;
Modulation Type : ASK
Antenna Description : Internal Antenna, 1.5dBi (Max.)

Extreme temp. Tolerance : -30°C to +50°C
Extreme vol. Limits : 3.6VDC to 4.35VDC (nominal: 3.8VDC)

2.3 Equipment under Test

Power supply system utilised

Power supply voltage	:	<input type="radio"/> 120V / 60 Hz	<input type="radio"/> 115V / 60Hz
		<input type="radio"/> 12 V DC	<input type="radio"/> 24 V DC
		<input checked="" type="radio"/> Other (specified in blank below) 3.8 V DC	

Test frequency list

Test Mode	TX/RX	RF Channel		
		Low(L)	Middle (M)	High (H)
GSM850	TX	Channel 128	Channel 190	Channel 251
		824.2 MHz	836.6 MHz	848.8 MHz
	RX	Channel 128	Channel 190	Channel 251
		869.2 MHz	881.6 MHz	893.8 MHz
Test Mode	TX/RX	RF Channel		
PCS1900	TX	Low(L)	Middle (M)	High (H)
		Channel 512	Channel 661	Channel 810
	1850.2 MHz	1880.0 MHz	1909.8 MHz	
	RX	Channel 512	Channel 661	Channel 810
		1930.2 MHz	1960.0 MHz	1989.8 MHz

2.4 Short description of the Equipment under Test (EUT)

2.4.1 General Description

TABLET is subscriber equipment in the BT / BLE / 2.4WIFI / 5.2WIFI / 5.8WIFI / NFC / GSM / WCDMA / LTE system. GSM/GPRS/EGPRS frequency bands are GSM 850 and PCS 1900.

2.5 Internal Identification of AE used during the test

AE ID*	Description
AE1	Rechargeable Li-Polymer Battery
AE2	Adapter

AE2

Adapter Model: UC13US

For Adapter Input: AC 100-240V, 50/60Hz, 0.35A Max

Adapter Output: DC 5.0V, 2A

2.6 Normal Accessory setting

Fully charged battery was used during the test.

2.7 EUT configuration

The following peripheral devices and interface cables were connected during the measurement:

● - supplied by the manufacturer

○ - supplied by the lab

○ Power Cable	Length (m) :	/
	Shield :	/
	Detachable :	/
○ Multimeter	Manufacturer :	/
	Model No. :	/

2.8 Related Submittal(s) / Grant (s)

This submittal(s) (test report) is intended for **FCC ID: 2AYKD-TB8** filing to comply with FCC Part 22 and Part 24 Rules.

2.9 Modifications

No modifications were implemented to meet testing criteria.

2.10 General Test Conditions/Configurations

2.10.1 Test Modes

NOTE: The test mode(s) are selected according to relevant radio technology specifications.

Test Mode	Test Modes Description
GSM/TM1	GSM system, GSM, GMSK modulation
GSM/TM2	GSM system, GPRS, GMSK modulation
GSM/TM3	GSM system, EDGE, 8PSK modulation

Note:

- As GSM and GPRS with the same emission designator, test result recorded in this report at the worst case GSM/TM1 only after exploratory scan.

2.10.2 Test Environment

Environment Parameter	Selected Values During Tests	
Relative Humidity	Ambient	
Temperature	TN	Ambient
Voltage	VL	DC 3.6V
	VN	DC 3.8V
	VH	DC 4.35V

NOTE: VL=lower extreme test voltage VN=nominal voltage
VH=upper extreme test voltage TN=normal temperature

3 TEST ENVIRONMENT

3.1 Address of the test laboratory

Shenzhen LCS Compliance Testing Laboratory Ltd

101, 201 Bldg A & 301 Bldg C, Juji Industrial Park Yabianxueziwei, Shajing Street, Baoan District, Shenzhen, 518000, China

The sites are constructed in conformance with the requirements of ANSI C63.4 (2014) and CISPR Publication 22.

3.2 Test Facility

The test facility is recognized, certified, or accredited by the following organizations:

NVLAP Accreditation Code is 600167-0.

FCC Designation Number is CN5024.

CAB identifier is CN0071.

CNAS Registration Number is L4595.

3.3 Environmental conditions

During the measurement the environmental conditions were within the listed ranges:

Temperature:	15-35 ° C
Humidity:	30-60 %
Atmospheric pressure:	950-1050mbar

3.4 Test Description

3.4.1 Cellular Band (824-849MHz paired with 869-894MHz)

Test Item	FCC Rule No.	Requirements	Verdict
Effective(Isotropic) Radiated Output Power	§2.1046, §22.913	FCC: ERP ≤ 7W. ISED: ERP ≤ 11.5W.	Pass
Modulation Characteristics	§2.1047	Digital modulation	N/A
Bandwidth	§2.1049	OBW: No limit. EBW: No limit.	Pass
Band Edges Compliance	§2.1051, §22.917	≤-13dBm/1%*EBW, in 1MHz bands immediately outside and adjacent to The frequency block.	Pass
Spurious Emission at Antenna Terminals	§2.1051, §22.917	≤ -13dBm/100kHz, from 9kHz to 10th harmonics but outside authorized operating frequency ranges.	Pass
Field Strength of Spurious Radiation	§2.1053, §22.917	≤ -13dBm/100kHz.	Pass
Frequency Stability	§2.1055, §22.355	≤ ±2.5ppm.	Pass
Peak-Average Ratio	§22.913	IC:Limit≤13dB	Pass
Receiver Spurious Emissions	N/A	--	Pass

NOTE 1: For the verdict, the "N/A" denotes "not applicable", the "N/T" de notes "not tested".

3.4.2 PCS Band (1850-1910MHz paired with 1930-1990MHz)

Test Item	FCC Rule No.	Requirements	Verdict
Effective(Isotropic) Radiated Output Power	§2.1046, §24.232	EIRP ≤ 2W	Pass
Peak-Average Ratio	§2.1046, §24.232	≤13dB	Pass
Modulation Characteristics	§2.1047	Digital modulation	N/A
Bandwidth	§2.1049	OBW: No limit. EBW: No limit.	Pass
Band Edges Compliance	§2.1051, §24.238	≤ -13dBm/1%*EBW, In 1MHz bands immediately outside and adjacent to The frequency block.	Pass
Spurious Emission at Antenna Terminals	§2.1051, §24.238	≤-13dBm/1MHz, from 9kHz to10th harmonics but outside authorized Operating frequency ranges.	Pass
Field Strength of Spurious Radiation	§2.1053, §24.238	≤ -13dBm/1MHz.	Pass
Frequency Stability	§2.1055, §24.235	≤ ±2.5ppm.	Pass
Peak-Average Ratio	§24.232	IC:Limit≤13dB	Pass
Receiver Spurious Emissions	N/A	--	Pass

NOTE 1: For the verdict, the "N/A" denotes "not applicable", the "N/T" de notes "not tested".

Remark: The measurement uncertainty is not included in the test result.

3.5 Equipment Used during the Test

Item	Equipment	Manufacturer	Model No.	Serial No.	Cal Date	Due Date
1	LTE Test Software	Tonscend	JS1120-1	N/A	N/A	N/A
2	RF Control Unit	Tonscend	JS0806	158060009	2020-06-22	2021-06-21
3	MXA Signal Analyzer	Agilent	N9020A	MY51250905	2020-11-21	2021-11-20
4	DC Power Supply	Agilent	E3642A	N/A	2020-11-13	2021-11-12
5	MXG Vector Signal Generator	Agilent	N5182A	MY47071151	2020-06-22	2021-06-21
6	PSG Analog Signal Generator	Agilent	E8257D	MY4520521	2020-06-22	2021-06-21
7	Temperature & Humidity Chamber	GUANGZHOU GOGN WEN	GDS-100	70932	2020-10-08	2021-10-07
8	EMI Test Software	AUDIX	E3	/	N/A	N/A
9	3m Semi Anechoic Chamber	SIDT FRANKONIA	SAC-3M	03CH03-HY	2020-06-22	2021-06-21
10	Positioning Controller	MF	MF7082	MF78020803	2020-06-22	2021-06-21
11	Active Loop Antenna	SCHWARZBECK	FMZB 1519B	00005	2018-07-26	2021-07-25
12	By-log Antenna	SCHWARZBECK	VULB9163	9163-470	2018-07-26	2021-07-25
13	Horn Antenna	SCHWARZBECK	BBHA 9120D	9120D-1925	2018-07-02	2021-07-01
14	Broadband Horn Antenna	SCHWARZBECK	BBHA 9170	791	2020-09-20	2023-09-19
15	Broadband Preamplifier	SCHWARZBECK	BBV9745	9719-025	2020-06-22	2021-06-21
16	EMI Test Receiver	R&S	ESR 7	101181	2020-06-22	2021-06-21
17	RS SPECTRUM ANALYZER	R&S	FSP40	100503	2020-11-21	2021-11-20
18	Broadband Preamplifier	/	BP-01M18G	P190501	2020-06-22	2021-06-21
19	RF Cable-R03m	Jye Bao	RG142	CB021	2020-06-22	2021-06-21
20	RF Cable-HIGH	SUHNER	SUCOFLEX 106	03CH03-HY	2020-06-22	2021-06-21
21	WIDEBAND RADIO COMMUNICATION TESTER	R&S	CMW 500	103818	2020-06-22	2021-06-21
22	RF Filter	Micro-Tronics	BRC50718	S/N-017	2020-11-21	2021-11-20
23	RF Filter	Micro-Tronics	BRC50719	S/N-011	2020-11-21	2021-11-20
24	RF Filter	Micro-Tronics	BRC50720	S/N-011	2020-11-21	2021-11-20
25	RF Filter	Micro-Tronics	BRC50721	S/N-013	2020-11-21	2021-11-20
26	RF Filter	Micro-Tronics	BRM50702	S/N-195	2020-06-22	2021-06-21
27	6dB Attenuator	/	100W/6dB	1172040	2020-06-22	2021-06-21
28	3dB Attenuator	/	2N-3dB	/	2020-06-22	2021-06-21
29	RS SPECTRUM ANALYZER	R&S	FSP40	100503	2020-11-21	2021-11-20

3.6 Measurement uncertainty

The data and results referenced in this document are true and accurate. The reader is cautioned that there may be errors within the calibration limits of the equipment and facilities. The measurement uncertainty was calculated for all measurements listed in this test report acc. to ETSI TR 100 028 “ Electromagnetic compatibility and Radio spectrum Matters (ERM); Uncertainties in the measurement of mobile radio equipment characteristics” and is documented in the Shenzhen LCS Compliance Testing Laboratory Ltd. quality system acc. to DIN EN ISO/IEC 17025. Furthermore, component and process variability of devices similar to that tested may result in additional deviation. The manufacturer has the sole responsibility of continued compliance of the device.

Hereafter the best measurement capability for Shenzhen LCS Compliance Testing Laboratory Ltd. is reported:

Test	Range	Measurement Uncertainty	Notes
Radiated Emission	30~1000MHz	3.10 dB	(1)
Radiated Emission	1~18GHz	3.80 dB	(1)
Radiated Emission	18-40GHz	3.90 dB	(1)
Conducted Disturbance	0.15~30MHz	1.63 dB	(1)
Conducted Power	9KHz~18GHz	0.61 dB	(1)
Spurious RF Conducted Emission	9KHz~40GHz	1.22 dB	(1)
Band Edge Compliance of RF Emission	9KHz~40GHz	1.22 dB	(1)
Occuiped Bandwidth	9KHz~40GHz	-	(1)

This uncertainty represents an expanded uncertainty expressed at approximately the 95% confidence level using a coverage factor of k=1.96.

4 TEST CONDITIONS AND RESULTS

4.1 Output Power

TEST APPLICABLE

During the process of testing, the EUT was controlled via R&S Digital Radio Communication tester (CMW 500) to ensure max power transmission and proper modulation. This result contains output power and EIRP measurements for the EUT. In all cases, output power is within the specified limits.

4.1.1 Conducted Output Power

TEST CONFIGURATION

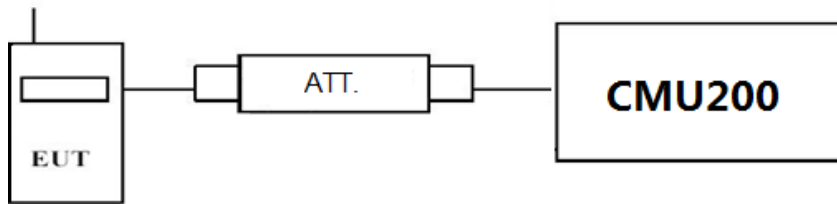

TEST PROCEDURE

Conducted Power Measurement:

- Place the EUT on a bench and set it in transmitting mode.
- Connect a low loss RF cable from the antenna port to a CMW 500 by an Att.
- EUT Communicate with CMW 500 then selects a channel for testing.
- Add a correction factor to the display CMW 500, and then test.

TEST RESULTS

GSM 850		Burst Average Conducted power (dBm)		
		Channel/Frequency(MHz)		
		128/824.2	190/836.6	251/848.8
GSM		32.66	32.68	32.68
GPRS (GMSK)	1TX slot	32.51	32.53	32.49
	2TX slot	30.96	30.97	30.94
	3TX slot	29.46	29.51	29.46
	4TX slot	28.00	27.98	27.96
EDGE (8PSK)	1TX slot	25.95	26.01	25.98
	2TX slot	24.47	24.51	24.46
	3TX slot	23.00	23.01	22.93
	4TX slot	21.50	21.51	21.45

PCS 1900		Burst Average Conducted power (dBm)		
		Channel/Frequency(MHz)		
		512/1850.2	661/1880	810/1909.8
GSM		32.71	32.71	32.64
GPRS (GMSK)	1TX slot	32.53	32.53	32.50
	2TX slot	31.00	31.00	30.94
	3TX slot	29.48	29.48	29.48
	4TX slot	27.97	28.01	27.97
EDGE (8PSK)	1TX slot	25.98	26.02	25.95
	2TX slot	24.50	24.50	24.44
	3TX slot	22.99	23.00	22.94
	4TX slot	21.50	21.51	21.45

4.1.2 Radiated Output Power

TEST DESCRIPTION

This is the test for the maximum radiated power from the EUT.

Per rule Part 24.232(c) specifies, "Mobile/portable stations are limited to 2 watts e.i.r.p. Peak power" and 24.232(e) specifies that "Peak transmit power must be measured over any interval of continuous transmission using instrumentation calibrated in terms of an rms-equivalent voltage."

Per rule Part 22.913(a) specifies "The ERP of mobile transmitters and auxiliary test transmitters must not exceed 7 Watts."

TEST CONFIGURATION

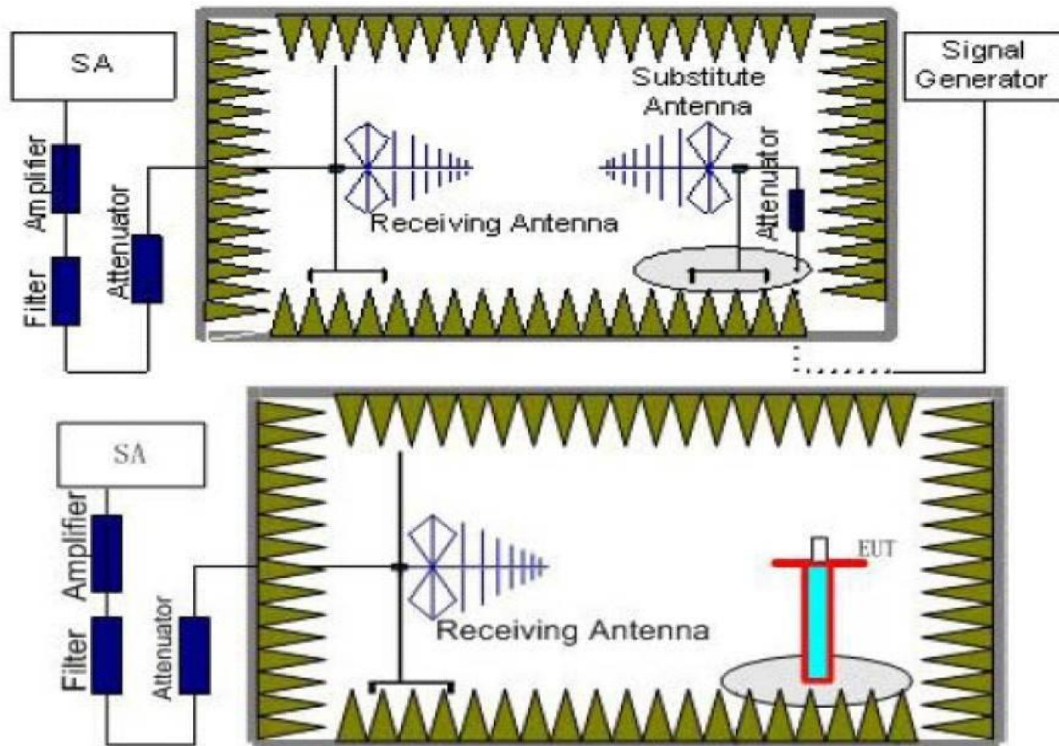

TEST PROCEDURE

1. EUT was placed on a 1.50 meter high non-conductive stand at a 3 meter test distance from the receive antenna. A receiving antenna was placed on the antenna mast 3 meters from the EUT for emission measurements. The height of receiving antenna is 1.50 m. Detected emissions were maximized at each frequency by rotating the EUT through 360° and adjusting the receiving antenna polarization. The radiated emission measurements of all transmit frequencies in three channels (High, Middle, Low) were measured with peak detector.
2. A log-periodic antenna or double-ridged waveguide horn antenna shall be substituted in place of the EUT. The log-periodic antenna will be driven by a signal generator and the level will be adjusted till the same power value on the spectrum analyzer or receiver. The level of the spurious emissions can be calculated through the level of the signal generator, cable loss, the gain of the substitution antenna and the reading of the spectrum analyzer or receiver.
3. The EUT is then put into continuously transmitting mode at its maximum power level during the test. Set Test Receiver or Spectrum RBW=1MHz, VBW=3MHz, And the maximum value of the receiver should be recorded as (P_i).
4. The EUT shall be replaced by a substitution antenna. In the chamber, an substitution antenna for the frequency band of interest is placed at the reference point of the chamber. An RF Signal source for the frequency band of interest is connected to the substitution antenna with a cable that has been constructed to not interfere with the radiation pattern of the antenna. A power (P_{Mea}) is applied to the input of the substitution antenna, and adjust the level of the signal generator output until the value of the receiver reach the

previously recorded (P_r). The power of signal source (P_{Mea}) is recorded. The test should be performed by rotating the test item and adjusting the receiving antenna polarization.

5. A amplifier should be connected to the Signal Source output port. And the cable should be connect between the Amplifier and the Substitution Antenna. The cable loss (P_{cl}), the Substitution Antenna Gain (G_a) and the Amplifier Gain (P_{Ag}) should be recorded after test.

The measurement results are obtained as described below:

$$\text{Power(EIRP)} = P_{Mea} + P_{Ag} - P_{cl} + G_a$$

6. This value is EIRP since the measurement is calibrated using an antenna of known gain (2.15 dBi) and known input power.
7. ERP can be calculated from EIRP by subtracting the gain of the dipole, $\text{ERP} = \text{EIRP} - 2.15\text{dBi}$.

TEST LIMIT

According to 22.913(a), 24.232(c), the ERP should be not exceed following table limits:

GSM850(GPRS850,EDGE850)		
Function	Power Step	Burst Peak ERP (dBm)
GSM	5	FCC: $\leq 38.45\text{dBm}$ (7W)
GPRS	3	FCC: $\leq 38.45\text{dBm}$ (7W)
EDGE	8	FCC: $\leq 38.45\text{dBm}$ (7W)

PCS1900(GPRS1900,EDGE1900)		
Function	Power Step	Burst Peak EIRP (dBm)
GSM	0	$\leq 33.01\text{dBm}$ (2W)
GPRS	3	$\leq 33.01\text{dBm}$ (2W)
EDGE	2	$\leq 33.01\text{dBm}$ (2W)

TEST RESULTS

Remark:

- We were tested all Configuration refer 3GPP TS151 010.
- $\text{EIRP} = P_{Mea}(\text{dBm}) - P_{cl}(\text{dB}) + P_{Ag}(\text{dB}) + G_a(\text{dBi})$
- $\text{ERP} = \text{EIRP} - 2.15\text{dBi}$ as EIRP by subtracting the gain of the dipole.
- Margin = Emission Level - Limit
- We test the H direction and V direction recorded worst case.

GSM/TM1/GSM850

Frequency (MHz)	P_{Mea} (dBm)	P_{cl} (dB)	G_a Antenna Gain(dB)	Correction (dB)	P_{Ag} (dB)	Burst Average ERP (dBm)	Limit (dBm)	Margin (dB)	Polarization
824.20	-6.92	3.45	8.45	2.15	33.79	29.72	38.45	-8.73	V
836.60	-7.08	3.49	8.45	2.15	33.85	29.58	38.45	-8.87	V
848.80	-6.93	3.55	8.36	2.15	33.88	29.61	38.45	-8.84	V

GSM/TM3/EDGE850

Frequency (MHz)	P_{Mea} (dBm)	P_{cl} (dB)	G_a Antenna Gain(dB)	Correction (dB)	P_{Ag} (dB)	Burst Average ERP (dBm)	Limit (dBm)	Margin (dB)	Polarization
824.20	-11.97	3.45	8.45	2.15	33.79	24.67	38.45	-13.78	V
836.60	-12.04	3.49	8.45	2.15	33.85	24.62	38.45	-13.83	V
848.80	-11.96	3.55	8.36	2.15	33.88	24.58	38.45	-13.87	V

GSM/TM1/GSM1900

Frequency (MHz)	P_{Mea} (dBm)	P_{cl} (dB)	G_a Antenna Gain(dB)	P_{Ag} (dB)	Burst Average EIRP (dBm)	Limit (dBm)	Margin (dB)	Polarization
1850.20	-11.96	4.03	8.38	35.51	27.90	33.01	-5.11	V
1880.00	-12.08	4.08	8.33	35.56	27.73	33.01	-5.28	V
1909.80	-12.09	4.14	8.26	35.63	27.66	33.01	-5.35	V

GSM/TM3/EDGE1900

Frequency (MHz)	P _{Mea} (dBm)	P _{cl} (dB)	G _a Antenna Gain(dB)	P _{Aq} (dB)	Burst Average EIRP (dBm)	Limit (dBm)	Margin (dB)	Polarization
1850.20	-17.08	4.03	8.38	35.51	22.78	33.01	-10.23	V
1880.00	-17.02	4.08	8.33	35.56	22.79	33.01	-10.22	V
1909.80	-17.05	4.14	8.26	35.63	22.70	33.01	-10.31	V

4.2 Radiated Spurious Emission

TEST APPLICABLE

According to the TIA/EIA 603D:2010 and FCC Part 2.1033 test method, The Receiver or Spectrum was scanned from lowest frequency generated within the equipment to the 10th harmonic of the highest frequency generated within the equipment, which is the transmitted carrier that can be as high as 1910 MHz. The resolution bandwidth is set as outlined in Part 24.238, Part 22.917, RSS-132 §5.5 and RSS-133 §6.5. The spectrum is scanned with the mobile station transmitting at carrier frequencies that pertain to low, mid and high channels of PCS1900 and GSM850.

TEST CONFIGURATION

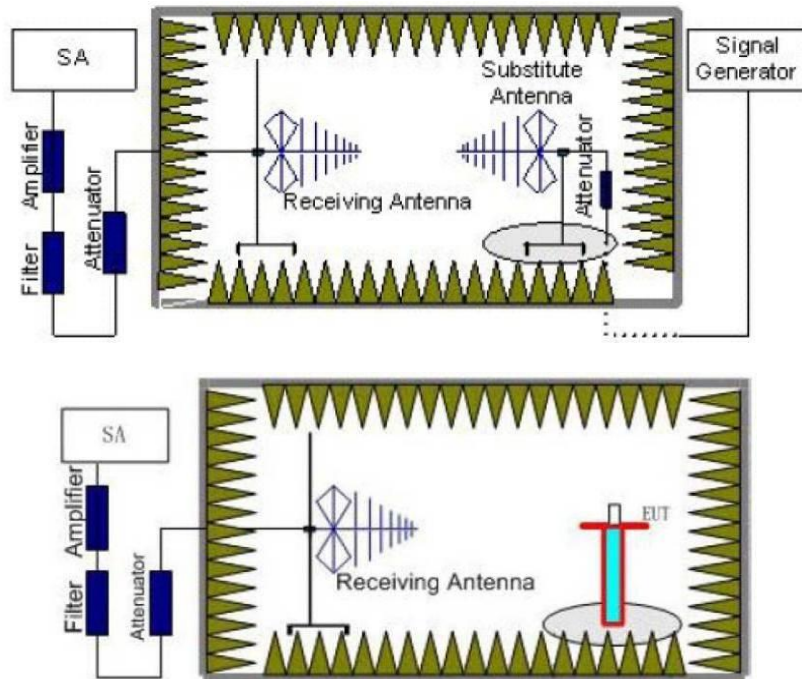

TEST PROCEDURE

1. EUT was placed on a 1.50 meter high non-conductive stand at a 3 meter test distance from the receive antenna. A receiving antenna was placed on the antenna mast 3 meters from the EUT for emission measurements. The height of receiving antenna is 1.50 m. Detected emissions were maximized at each frequency by rotating the EUT through 360° and adjusting the receiving antenna polarization. The radiated emission measurements of all transmit frequencies in three channels (High, Middle, Low) were measured with peak detector.
2. A log-periodic antenna or double-ridged waveguide horn antenna shall be substituted in place of the EUT. The log-periodic antenna will be driven by a signal generator and the level will be adjusted till the same power value on the spectrum analyzer or receiver. The level of the spurious emissions can be calculated through the level of the signal generator, cable loss, the gain of the substitution antenna and the reading of the spectrum analyzer or receiver.
3. The EUT is then put into continuously transmitting mode at its maximum power level during the test. Set Test Receiver or Spectrum RBW=1MHz, VBW=3MHz, And the maximum value of the receiver should be recorded as (P_r).
4. The EUT shall be replaced by a substitution antenna. In the chamber, an substitution antenna for the frequency band of interest is placed at the reference point of the chamber. An RF Signal source for the frequency band of interest is connected to the substitution antenna with a cable that has been constructed to not interfere with the radiation pattern of the antenna. A power (P_{Mea}) is applied to the input of the substitution antenna, and adjust the level of the signal generator output until the value of the receiver reach the previously recorded (P_r). The power of signal source (P_{Mea}) is recorded. The test should be performed by rotating the test item and adjusting the receiving antenna polarization.

5. An amplifier should be connected to the Signal Source output port. And the cable should be connect between the Amplifier and the Substitution Antenna. The cable loss (P_{cl}), the Substitution Antenna Gain (G_a) and the Amplifier Gain (P_{Ag}) should be recorded after test.

The measurement results are obtained as described below:

$$\text{Power(EIRP)} = P_{\text{Mea}} + P_{\text{Ag}} - P_{\text{cl}} + G_a$$

6. This value is EIRP since the measurement is calibrated using an antenna of known gain (2.15 dBi) and known input power.
7. ERP can be calculated from EIRP by subtracting the gain of the dipole, $\text{ERP} = \text{EIRP} - 2.15\text{dBi}$.
8. In order to make sure test results more clearly, we set frequency range and sweep time for difference frequency range as follows table:

Working Frequency	Subrange (GHz)	RBW	VBW	Sweep time (s)
TM1/GSM 850	0.00009~0.15	1KHz	3KHz	30
	0.00015~0.03	10KHz	30KHz	10
	0.03~1	100KHz	300KHz	10
	1~2	1 MHz	3 MHz	2
	2~5	1 MHz	3 MHz	3
	5~8	1 MHz	3 MHz	3
	8~10	1 MHz	3 MHz	3
TM1/GSM 1900	0.00009~0.15	1KHz	3KHz	30
	0.00015~0.03	10KHz	30KHz	10
	0.03~1	100KHz	300KHz	10
	1~2	1 MHz	3 MHz	2
	2~5	1 MHz	3 MHz	3
	5~8	1 MHz	3 MHz	3
	8~11	1 MHz	3 MHz	3
	11~14	1 MHz	3 MHz	3
	14~18	1 MHz	3 MHz	3
	18~20	1 MHz	3 MHz	2

TEST LIMITS

According to 24.238 and 22.917 specify that the power of any emission outside of the authorized operating frequency ranges must be attenuated below the transmitting power (P) by a factor of at least $43 + 10 \log(P)$ dB. The specification that emissions shall be attenuated below the transmitter power (P) by at least $43 + 10 \log(P)$ dB, translates in the relevant power range (1 to 0.001 W) to -13 dBm. At 1 W the specified minimum attenuation becomes 43 dB and relative to a 30 dBm (1 W) carrier becomes a limit of -13 dBm. At 0.001 W (0 dBm) the minimum attenuation is 13 dB, which again yields a limit of -13 dBm. In this way a translation of the specification from relative to absolute terms is carried out.

Frequency	Channel	Frequency Range	Verdict
TM1/GSM 850	Low	9KHz -10GHz	PASS
	Middle	9KHz -10GHz	PASS
	High	9KHz -10GHz	PASS
TM1/GSM 1900	Low	9KHz -20GHz	PASS
	Middle	9KHz -20GHz	PASS
	High	9KHz -20GHz	PASS

TEST RESULTS

Remark:

- We were tested all refer 3GPP TS151 010.
- $\text{EIRP} = P_{\text{Mea}}(\text{dBm}) - P_{\text{cl}}(\text{dB}) + G_a(\text{dBi})$
- We were not recorded other points as values lower than limits.
- $\text{Margin} = \text{EIRP} - \text{Limit}$

GSM/TM1/GSM850_ Low Channel

Frequency (MHz)	P _{Mea} (dBm)	P _{cl} (dB)	Diatance	G _a Antenna Gain(dB)	Peak EIRP (dBm)	Limit (dBm)	Margin (dB)	Polarization
1648.40	-42.91	3.86	3.00	8.56	-38.21	-13.00	-25.21	H
2472.60	-44.17	4.29	3.00	6.98	-41.48	-13.00	-28.48	H
1648.40	-40.07	3.86	3.00	8.56	-35.37	-13.00	-22.37	V
2472.60	-41.67	4.29	3.00	6.98	-38.98	-13.00	-25.98	V

GSM/TM1/GSM850_ Middle Channel

Frequency (MHz)	P _{Mea} (dBm)	P _{cl} (dB)	Diatance	G _a Antenna Gain(dB)	Peak EIRP (dBm)	Limit (dBm)	Margin (dB)	Polarization
1673.20	-41.96	3.9	3.00	8.58	-37.28	-13.00	-24.28	H
2509.80	-46.13	4.32	3.00	6.8	-43.65	-13.00	-30.65	H
1673.20	-37.81	3.9	3.00	8.58	-33.13	-13.00	-20.13	V
2509.80	-42.84	4.32	3.00	6.8	-40.36	-13.00	-27.36	V

GSM/TM1/GSM850_ High Channel

Frequency (MHz)	P _{Mea} (dBm)	P _{cl} (dB)	Diatance	G _a Antenna Gain(dB)	Peak EIRP (dBm)	Limit (dBm)	Margin (dB)	Polarization
1697.60	-47.08	3.91	3.00	9.06	-41.93	-13.00	-28.93	H
2546.40	-49.52	4.32	3.00	6.65	-47.19	-13.00	-34.19	H
1697.60	-43.07	3.91	3.00	9.06	-37.92	-13.00	-24.92	V
2546.40	-45.37	4.32	3.00	6.65	-43.04	-13.00	-30.04	V

GSM/TM3/GSM850_ Low Channel

Frequency (MHz)	P _{Mea} (dBm)	P _{cl} (dB)	Diatance	G _a Antenna Gain(dB)	Peak EIRP (dBm)	Limit (dBm)	Margin (dB)	Polarization
1648.40	-45.45	3.86	3.00	8.56	-40.75	-13.00	-27.75	H
2472.60	-46.71	4.29	3.00	6.98	-44.02	-13.00	-31.02	H
1648.40	-42.03	3.86	3.00	8.56	-37.33	-13.00	-24.33	V
2472.60	-43.86	4.29	3.00	6.98	-41.17	-13.00	-28.17	V

GSM/TM3/GSM850_ Middle Channel

Frequency (MHz)	P _{Mea} (dBm)	P _{cl} (dB)	Diatance	G _a Antenna Gain(dB)	Peak EIRP (dBm)	Limit (dBm)	Margin (dB)	Polarization
1673.20	-43.46	3.9	3.00	8.58	-38.78	-13.00	-25.78	H
2509.80	-48.80	4.32	3.00	6.8	-46.32	-13.00	-33.32	H
1673.20	-39.69	3.9	3.00	8.58	-35.01	-13.00	-22.01	V
2509.80	-45.30	4.32	3.00	6.8	-42.82	-13.00	-29.82	V

GSM/TM3/GSM850_ High Channel

Frequency (MHz)	P _{Mea} (dBm)	P _{cl} (dB)	Diatance	G _a Antenna Gain(dB)	Peak EIRP (dBm)	Limit (dBm)	Margin (dB)	Polarization
1697.60	-49.23	3.91	3.00	9.06	-44.08	-13.00	-31.08	H
2546.40	-51.42	4.32	3.00	6.65	-49.09	-13.00	-36.09	H
1697.60	-45.43	3.91	3.00	9.06	-40.28	-13.00	-27.28	V
2546.40	-47.09	4.32	3.00	6.65	-44.76	-13.00	-31.76	V

GSM/TM1/GSM1900_ Low Channel

Frequency (MHz)	P _{Mea} (dBm)	P _{cl} (dB)	Diatance	G _a Antenna Gain(dB)	Peak EIRP (dBm)	Limit (dBm)	Margin (dB)	Polarization
3700.40	-45.11	5.26	3.00	9.88	-40.49	-13.00	-27.49	H
5550.60	-46.20	6.11	3.00	11.36	-40.95	-13.00	-27.95	H
3700.40	-41.40	5.26	3.00	9.88	-36.78	-13.00	-23.78	V
5550.60	-44.34	6.11	3.00	11.36	-39.09	-13.00	-26.09	V

GSM/TM1/GSM1900_ Middle Channel

Frequency (MHz)	P _{Mea} (dBm)	P _{cl} (dB)	Diatance	G _a Antenna Gain(dB)	Peak EIRP (dBm)	Limit (dBm)	Margin (dB)	Polarization
3760.00	-44.16	5.32	3.00	10.03	-39.45	-13.00	-26.45	H
5640.00	-48.12	6.19	3.00	11.41	-42.90	-13.00	-29.90	H
3760.00	-39.41	5.32	3.00	10.03	-34.70	-13.00	-21.70	V
5640.00	-44.79	6.19	3.00	11.41	-39.57	-13.00	-26.57	V

GSM/TM1/GSM1900_ High Channel

Frequency (MHz)	P _{Mea} (dBm)	P _{cl} (dB)	Diatance	G _a Antenna Gain(dB)	Peak EIRP (dBm)	Limit (dBm)	Margin (dB)	Polarization
3819.60	-48.55	5.36	3.00	9.62	-44.29	-13.00	-31.29	H
5729.40	-51.38	6.24	3.00	11.46	-46.16	-13.00	-33.16	H
3819.60	-45.29	5.36	3.00	9.62	-41.03	-13.00	-28.03	V
5729.40	-47.34	6.24	3.00	11.46	-42.12	-13.00	-29.12	V

GSM/TM3/GSM1900_ Low Channel

Frequency (MHz)	P _{Mea} (dBm)	P _{cl} (dB)	Diatance	G _a Antenna Gain(dB)	Peak EIRP (dBm)	Limit (dBm)	Margin (dB)	Polarization
3700.40	-47.43	5.26	3.00	9.88	-42.81	-13.00	-29.81	H
5550.60	-48.10	6.11	3.00	11.36	-42.85	-13.00	-29.85	H
3700.40	-43.99	5.26	3.00	9.88	-39.37	-13.00	-26.37	V
5550.60	-46.33	6.11	3.00	11.36	-41.08	-13.00	-28.08	V

GSM/TM3/GSM1900_ Middle Channel

Frequency (MHz)	P _{Mea} (dBm)	P _{cl} (dB)	Diatance	G _a Antenna Gain(dB)	Peak EIRP (dBm)	Limit (dBm)	Margin (dB)	Polarization
3760.00	-45.72	5.32	3.00	10.03	-41.01	-13.00	-28.01	H
5640.00	-50.60	6.19	3.00	11.41	-45.38	-13.00	-32.38	H
3760.00	-41.56	5.32	3.00	10.03	-36.85	-13.00	-23.85	V
5640.00	-46.92	6.19	3.00	11.41	-41.70	-13.00	-28.70	V

GSM/TM3/GSM1900_ High Channel

Frequency (MHz)	P _{Mea} (dBm)	P _{cl} (dB)	Diatance	G _a Antenna Gain(dB)	Peak EIRP (dBm)	Limit (dBm)	Margin (dB)	Polarization
3819.60	-51.17	5.36	3.00	9.62	-46.91	-13.00	-33.91	H
5729.40	-53.54	6.24	3.00	11.46	-48.32	-13.00	-35.32	H
3819.60	-47.66	5.36	3.00	9.62	-43.40	-13.00	-30.40	V
5729.40	-48.97	6.24	3.00	11.46	-43.75	-13.00	-30.75	V

4.3 Occupied Bandwidth and Emission Bandwidth

TEST APPLICABLE

Similar to conducted emissions; occupied bandwidth measurements are only provided for selected frequencies in order to reduce the amount of submitted data. Data were taken at the extreme and mid frequencies of PCS1900 band and GSM850 band. The table below lists the measured 99% Bandwidth and -26dBc Bandwidth.

TEST CONFIGURATION

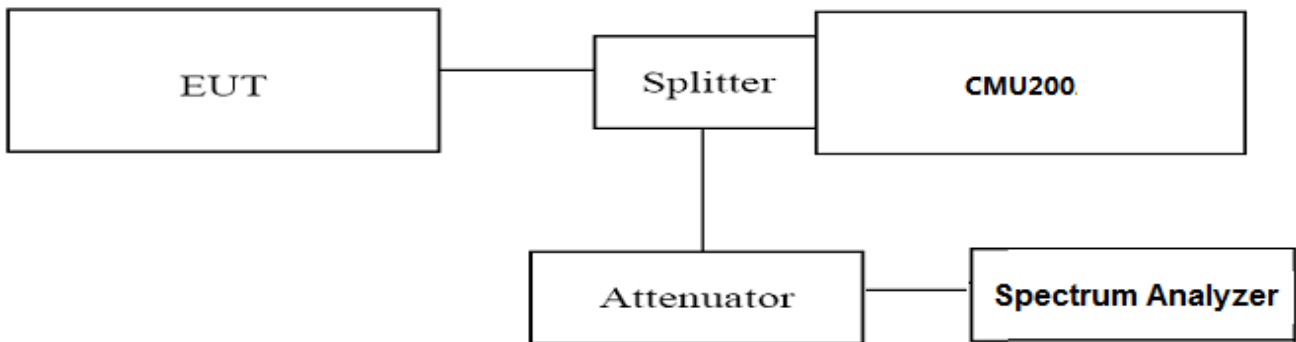

TEST PROCEDURE

1. The EUT was set up for the max output power with pseudo random data modulation;
2. The Occupied bandwidth and Emission Bandwidth were measured with Spectrum AnalyzerN9020A;
3. Set RBW=5.1KHz,VBW=51KHz,Span=1MHz,SWT=Auto;
4. Set SPA Max hold and View, Set 99% Occupied Bandwidth/ Set -26dBc Occupied Bandwidth
5. These measurements were done at 3 frequencies, 1850.20 MHz, 1880.00 MHz and 1909.80 MHz for PCS1900 band; 824.20MHz, 836.60 MHz and 848.80 MHz for GSM850 band. (Low, middle and high of operational frequency range).

TEST RESULTS

Test Mode	Channel	Frequency (MHz)	Occupied Bandwidth (99% BW) (KHz)	Emission Bandwidth (-26 dBc BW) (KHz)	Verdict
GSM/TM1 /GSM850	128	824.2	247.16	317.6	PASS
	190	836.6	242.76	308.2	PASS
	251	848.8	241.46	311.4	PASS
GSM/TM3 /EDGE850	128	824.2	246.12	313.6	PASS
	190	836.6	244.34	304.8	PASS
	251	848.8	247.13	318.2	PASS
GSM/TM1 /GSM1900	512	1850.2	246.04	310.6	PASS
	661	1880.0	246.74	310.5	PASS
	810	1909.8	243.84	315.5	PASS
GSM/TM3 /EDGE1900	512	1850.2	246.49	302.2	PASS
	661	1880.0	246.65	296.8	PASS
	810	1909.8	241.36	305.5	PASS

Remark:

1. Test results including cable loss;
2. Please refer to following plots;

Occupied Bandwidth and Emission Bandwidth

GSM/TM1/GSM850

GSM/TM3/EDGE850

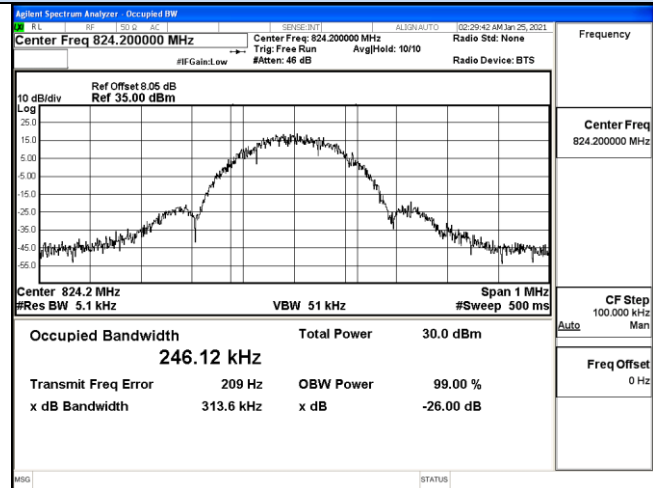
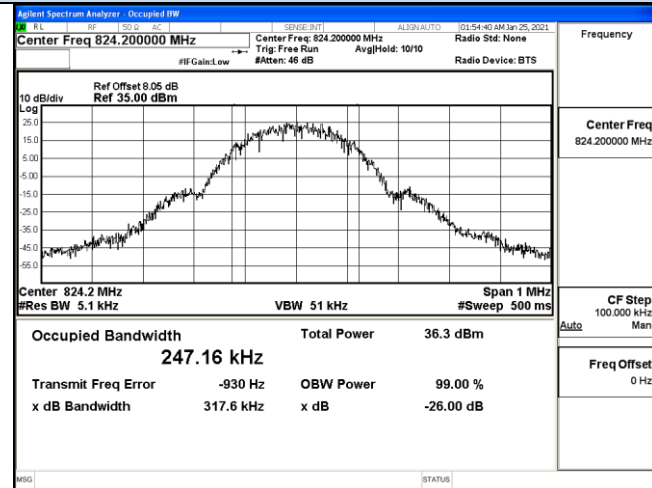

Channel 128 / 824.2 MHz

Channel 128 / 824.2 MHz

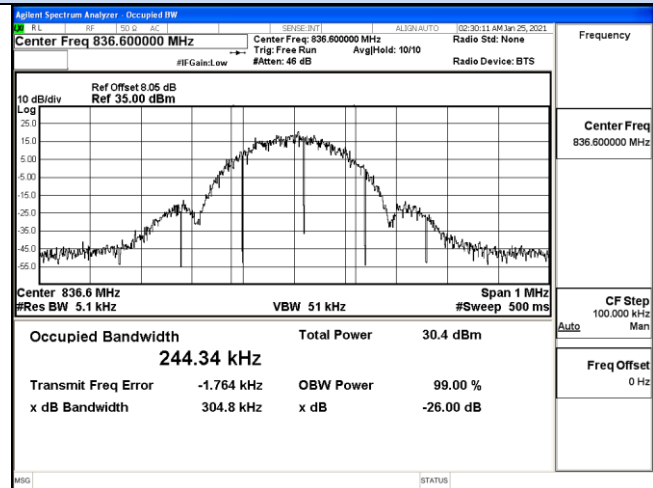
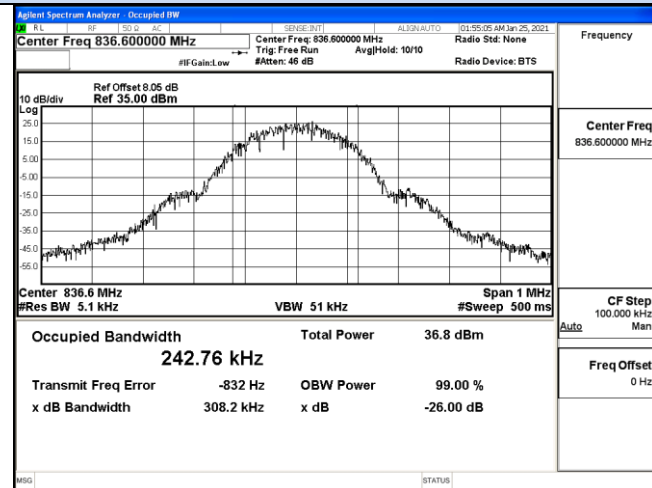

Channel 190 / 836.6 MHz

Channel 190 / 836.6 MHz

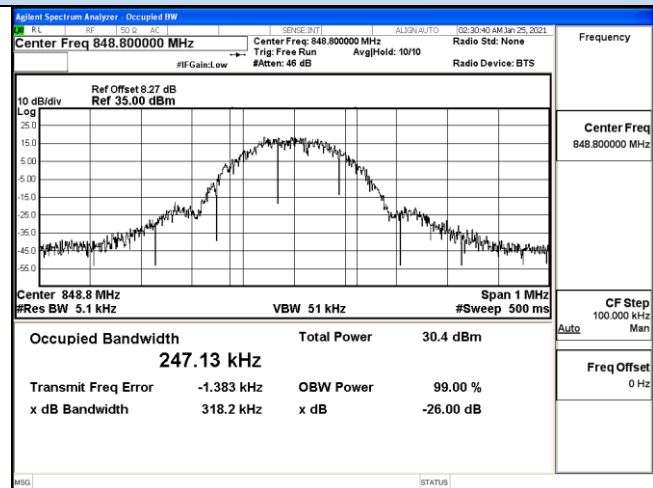
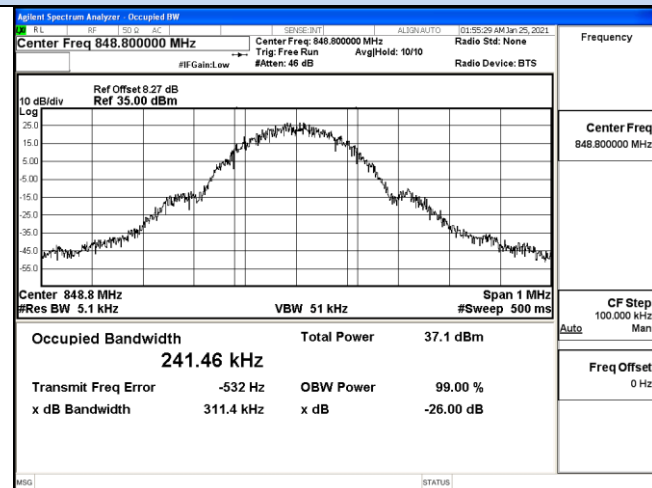

Channel 251 / 848.8 MHz

Channel 251 / 848.8 MHz

Occupied Bandwidth and Emission Bandwidth

GSM/TM1/GSM1900

GSM/TM3/EDGE1900

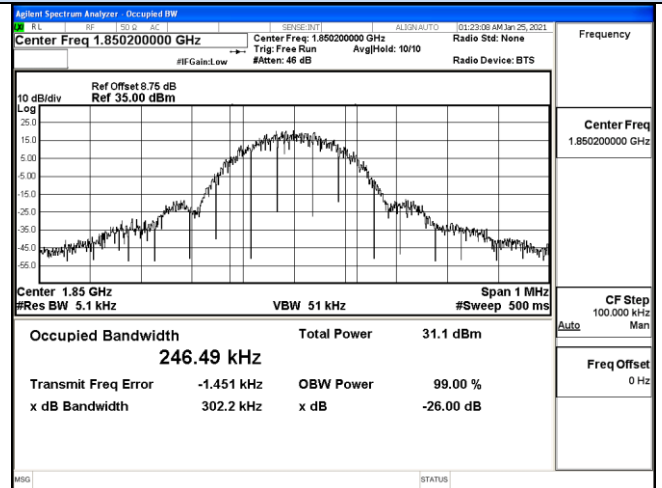
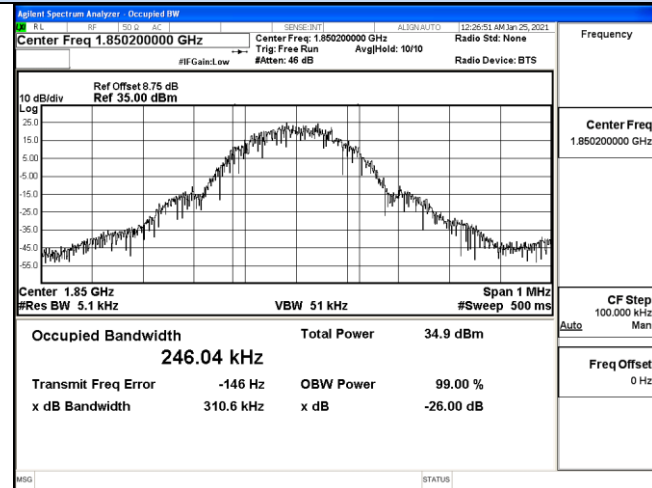

Channel 512 / 1850.2 MHz

Channel 512 / 1850.2 MHz

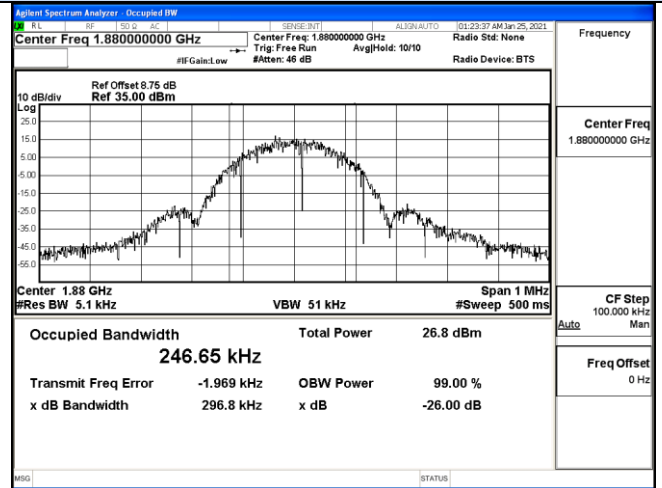
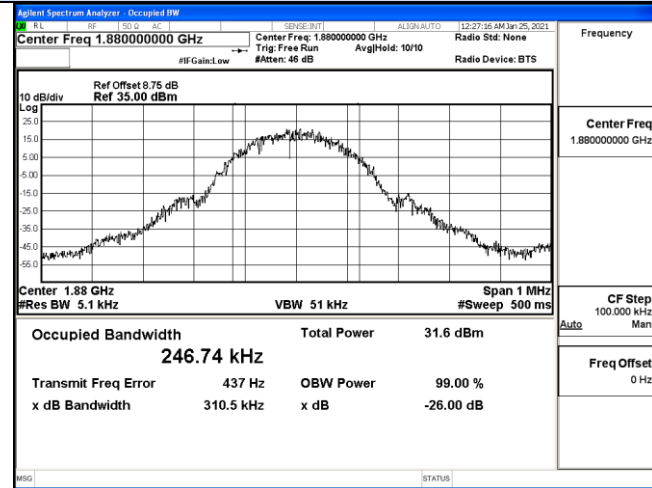

Channel 661 / 1880.0MHz

Channel 661 / 1880.0MHz

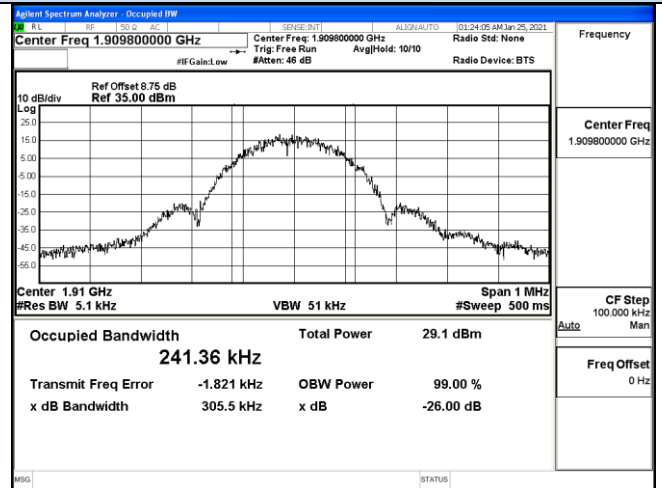
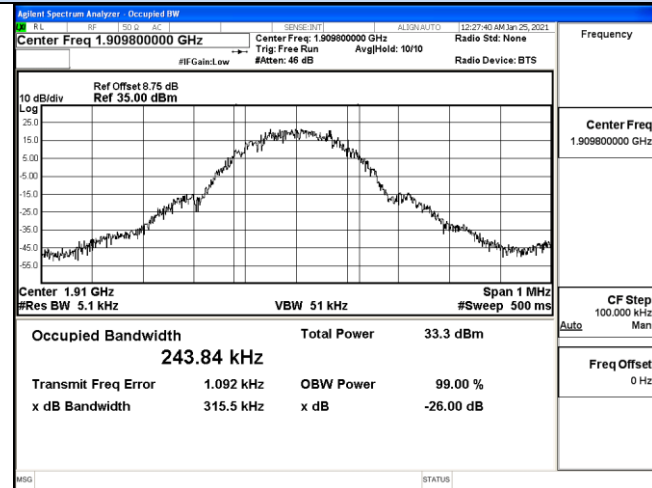

Channel 810 / 1909.8 MHz

Channel 810 / 1909.8 MHz

4.4 Band Edge Compliance

TEST APPLICABLE

During the process of testing, the EUT was controlled via Digital Radio Communication tester (CMW 500) to ensure max power transmission and proper modulation.

TEST CONFIGURATION

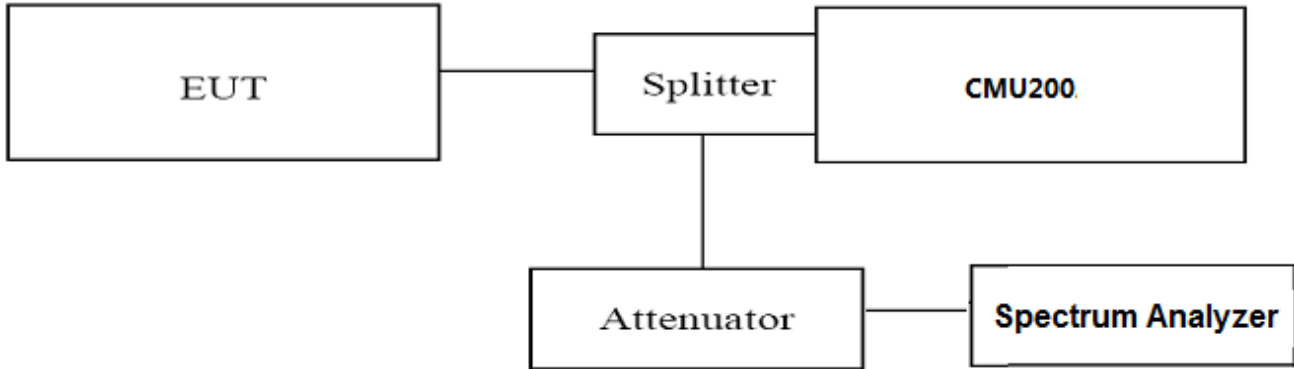

TEST PROCEDURE

1. The EUT was set up for the max output power with pseudo random data modulation;
2. The power was measured with Spectrum Analyzer N9020A;
3. Set RBW=5.1KHz,VBW=51KHz,Span=1MHz,SWT=Auto, Dector: RMS;
1. These measurements were done at 2 frequencies, 1850.20 MHz and 1909.80 MHz for PCS1900 band; 824.20 MHz and 848.80 MHz for GSM850 band. (bottom and top of operational frequency range).

TEST RESULTS

Test Mode	Channel	Frequency (MHz)	Band Edge Compliance (dBm)	Limits (dBm)	Verdict
GSM/TM1/GSM850	128	824.2	<-13dBm	-13dBm	PASS
	251	848.8	<-13dBm	-13dBm	
GSM/TM3/EDGE850	128	824.2	<-13dBm	-13dBm	PASS
	251	848.8	<-13dBm	-13dBm	
GSM/TM1/GSM1900	512	1850.2	<-13dBm	-13dBm	PASS
	810	1909.8	<-13dBm	-13dBm	
GSM/TM3/EDGE1900	512	1850.2	<-13dBm	-13dBm	PASS
	810	1909.8	<-13dBm	-13dBm	

Remark:

1. Test results including cable loss;
2. Please refer to following plots;

Band-edge Compliance

GSM/TM1/GSM850

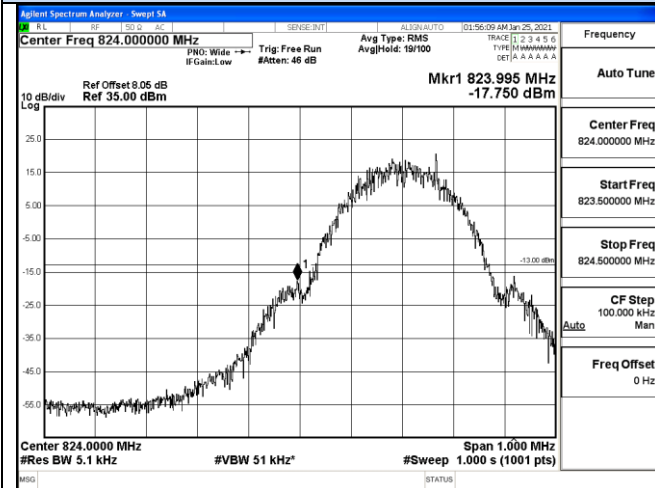

GSM/TM3/EDGE850

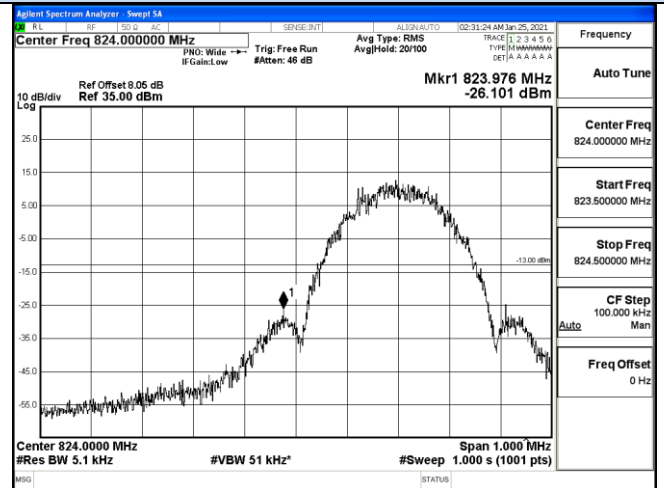

Channel 128 / 824.2 MHz

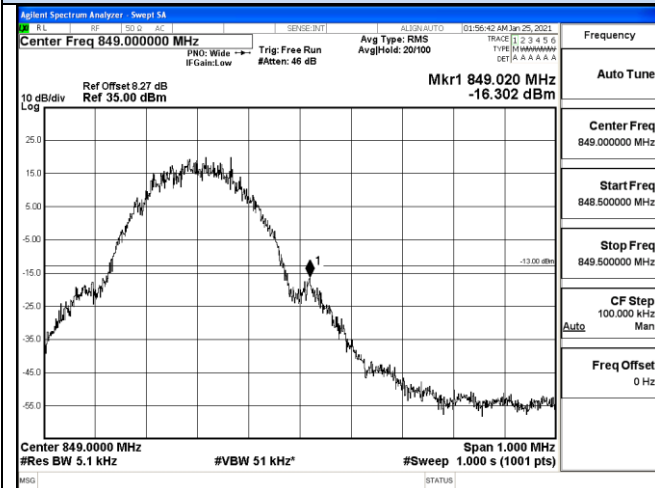

Channel 128 / 824.2 MHz

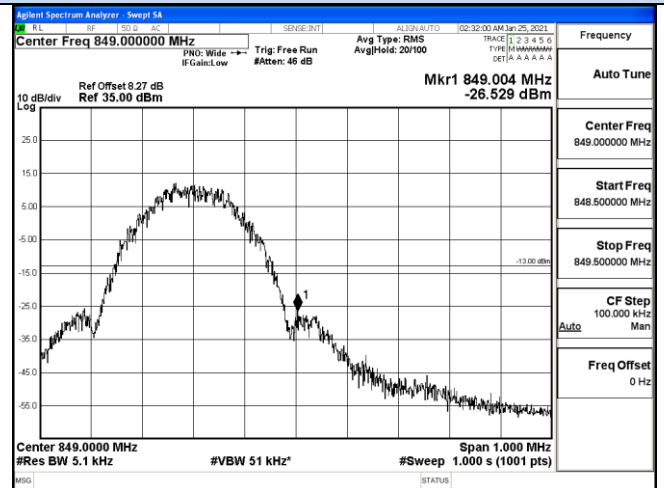

Channel 251 / 848.8 MHz

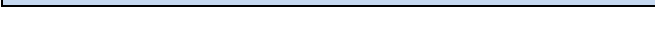

Channel 251 / 848.8 MHz

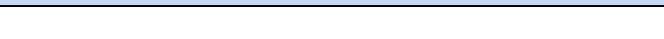

Band-edge Compliance

GSM/TM1/GSM1900

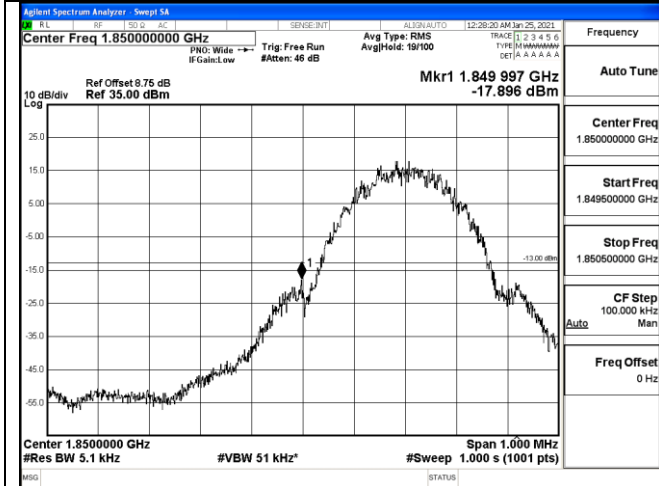

GSM/TM3/EDGE1900

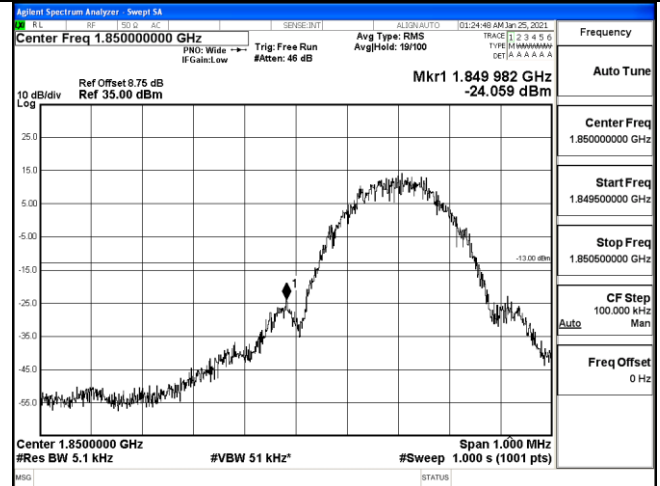

Channel 512 / 1850.2 MHz

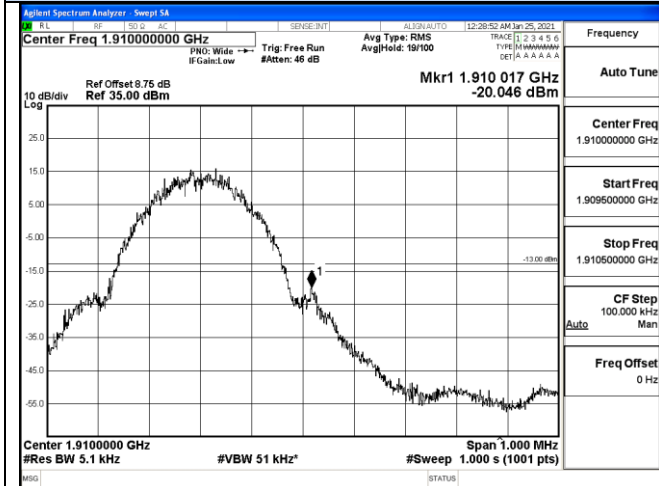

Channel 512 / 1850.2 MHz

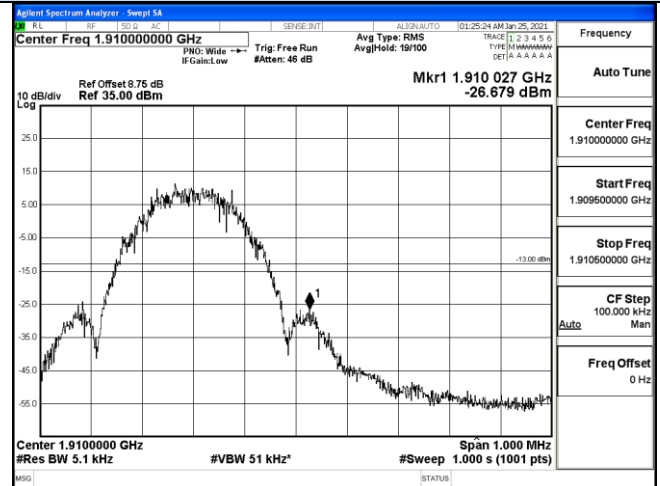

Channel 810 / 1909.8 MHz

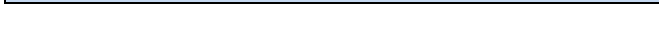

Channel 810 / 1909.8 MHz

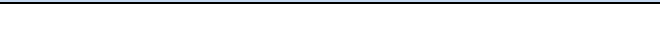

4.5 Spurious Emission on Antenna Port

TEST APPLICABLE

The following steps outline the procedure used to measure the conducted emissions from the EUT.

1. Determine frequency range for measurements: From CFR 2.1057 and RSS-GEN the spectrum should be investigated from the lowest radio frequency generated in the equipment up to at least the 10th harmonic of the carrier frequency. For the equipment of PCS1900 band, this equates to a frequency range of 9 KHz to 20 GHz, data taken from 30 MHz to 20 GHz. For GSM850, this equates to a frequency range of 9 KHz to 9 GHz data taken from 30 MHz to 9 GHz.
2. The sweep time is set automatically by instrument itself. That should be the optimal sweep time for the span and the RBW. If the sweep time is too short, that is sweep is too fast, the sweep result is not accurate; if the sweep time is too long, that is sweep is too low, some frequency components may be lost. The instrument will give an optimal sweep time according the selected span and RBW.
3. The procedure to get the conducted spurious emission is as follows:
The trace mode is set to MaxHold to get the highest signal at each frequency;
Wait 25 seconds;
Get the result.
4. Determine EUT transmit frequencies: below outlines the band edge frequencies pertinent to conducted emissions testing.

TEST CONFIGURATION

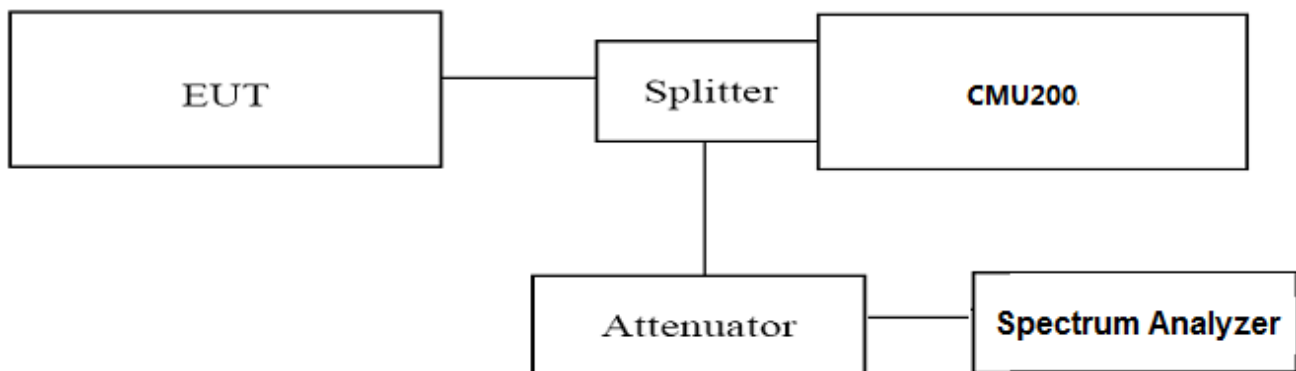

TEST PROCEDURE

1. The EUT was set up for the max output power with pseudo random data modulation;
2. The power was measured with Spectrum Analyzer N9020A;
3. These measurements were done at 3 frequencies, 1850.20 MHz, 1880.00 MHz and 1909.80 MHz for PCS1900 band; 824.20 MHz, 836.60 MHz and 848.80 MHz for GSM850 band. (Low, middle and high of operational frequency range).

TEST LIMIT

Part 24.238, Part 22.917 specify that the power of any emission outside of the authorized operating frequency ranges must be attenuated below the transmitting power (P) by a factor of at least $43 + 10 \log(P)$ dB. The specification that emissions shall be attenuated below the transmitter power (P) by at least $43 + 10 \log(P)$ dB, translates in the relevant power range (1 to 0.001 W) to -13 dBm. At 1 W the specified minimum attenuation becomes 43 dB and relative to a 30 dBm (1 W) carrier becomes a limit of -13 dBm. At 0.001 W (0 dBm) the minimum attenuation is 13 dB, which again yields a limit of -13 dBm. In this way a translation of the specification from relative to absolute terms is carried out.

TEST RESULTS

Test Mode	Channel	Frequency (MHz)	Spurious RF Conducted Emission (dBm)	Limits (dBm)	Verdict
GSM/TM1/GSM850	128	824.2	<-13dBm	-13dBm	PASS
	190	836.6	<-13dBm	-13dBm	
	251	848.8	<-13dBm	-13dBm	
GSM/TM3/EDGE850	128	824.2	<-13dBm	-13dBm	PASS
	190	836.6	<-13dBm	-13dBm	
	251	848.8	<-13dBm	-13dBm	
GSM/TM1/GSM1900	512	1850.2	<-13dBm	-13dBm	PASS
	661	1880.0	<-13dBm	-13dBm	
	810	1909.8	<-13dBm	-13dBm	
GSM/TM3/EDGE1900	512	1850.2	<-13dBm	-13dBm	PASS
	661	1880.0	<-13dBm	-13dBm	
	810	1909.8	<-13dBm	-13dBm	

Remark:

1. Test results including cable loss;
2. Please refer to following plots;
3. Not reorded test plots from 9 KHz to 30 MHz as emission levels 20dB lower than emission limit;

Spurious Emission on Antenna Port

GSM/TM1/GSM850

Channel 128 / 824.2 MHz

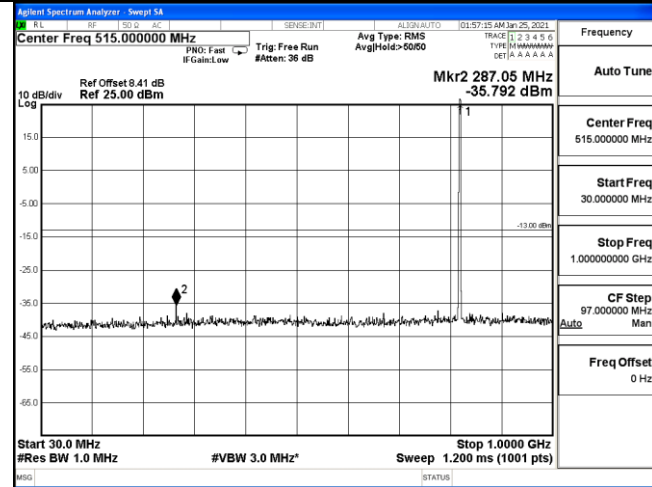

GSM/TM3/EDGE850

Channel 128 / 824.2 MHz

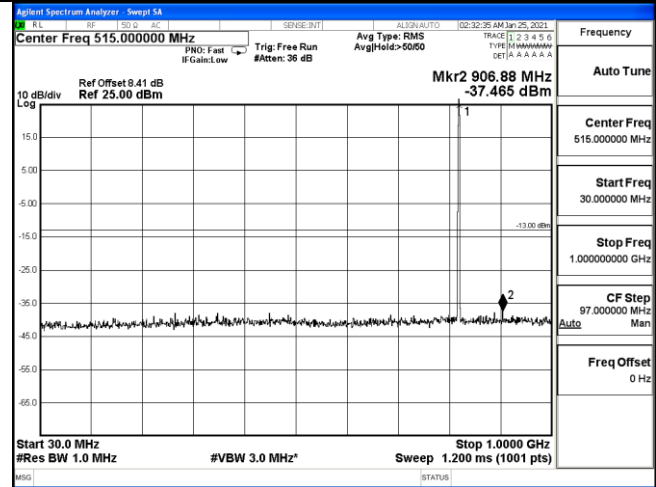

30 MHz – 1000 MHz

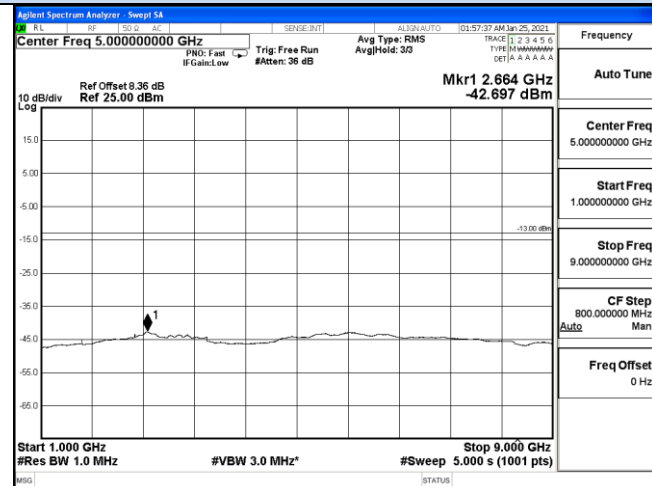

30 MHz – 1000 MHz

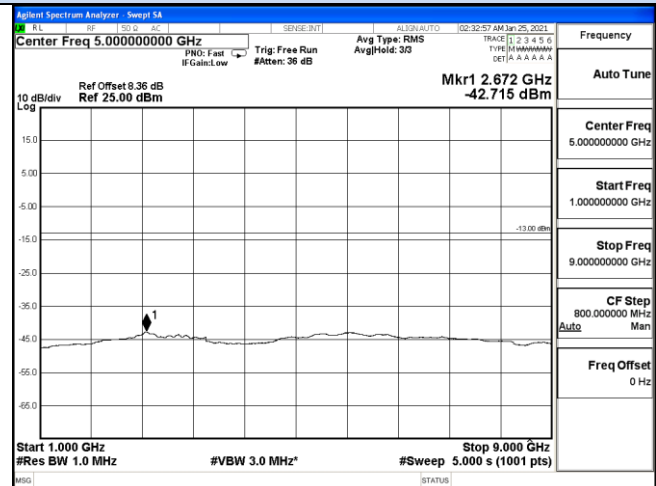

1 GHz – 9 GHz

Channel 190 / 836.6 MHz

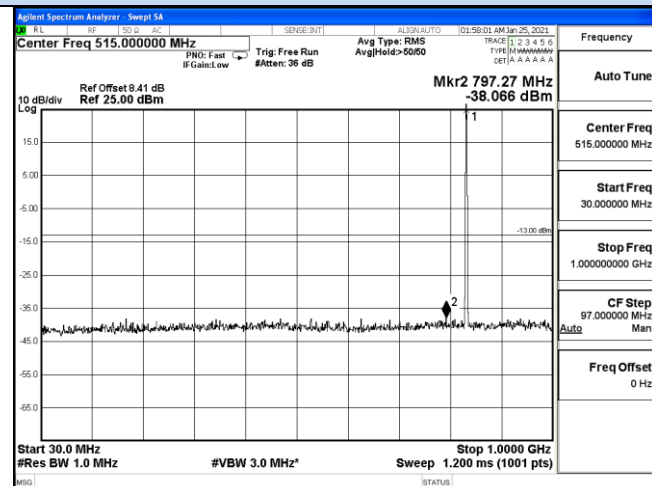

1 GHz – 9 GHz

Channel 190 / 836.6 MHz

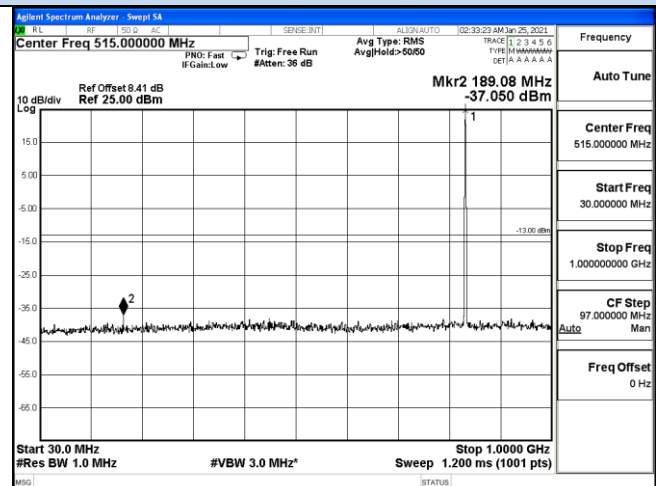

30 MHz – 1000 MHz

30 MHz – 1000 MHz

Spurious Emission on Antenna Port

GSM/TM1/GSM850

Channel 190 / 836.6 MHz

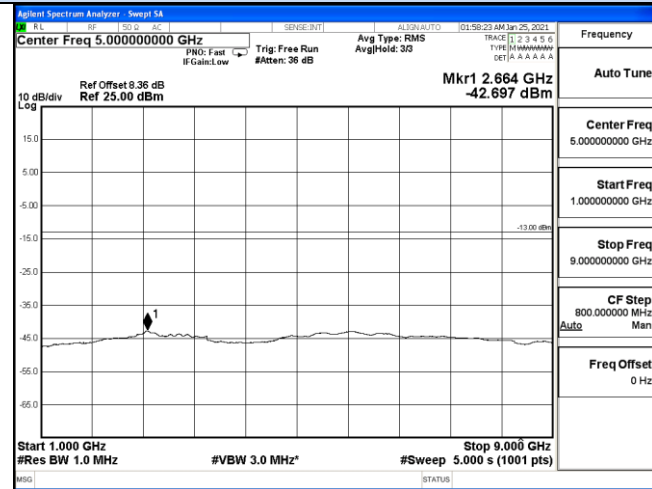

1 GHz – 9 GHz

GSM/TM3/EDGE850

Channel 190 / 836.6 MHz

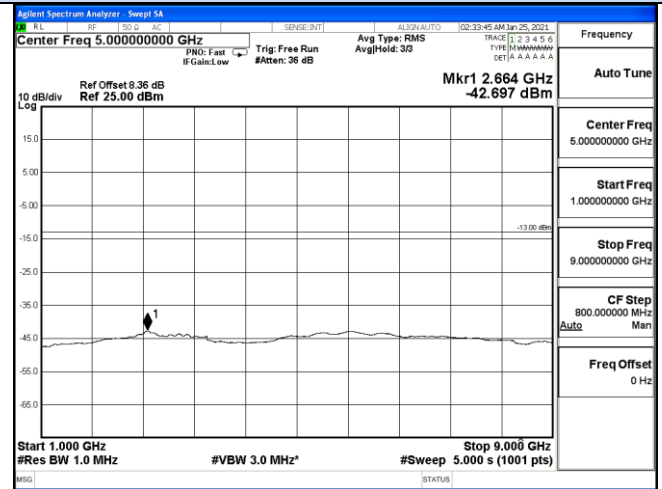

1 GHz – 9 GHz

Channel 251 / 848.8 MHz

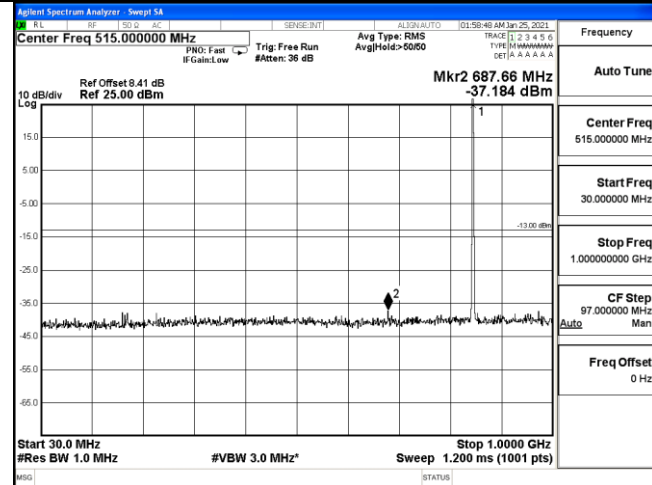

30 MHz – 1000 MHz

Channel 251 / 848.8 MHz

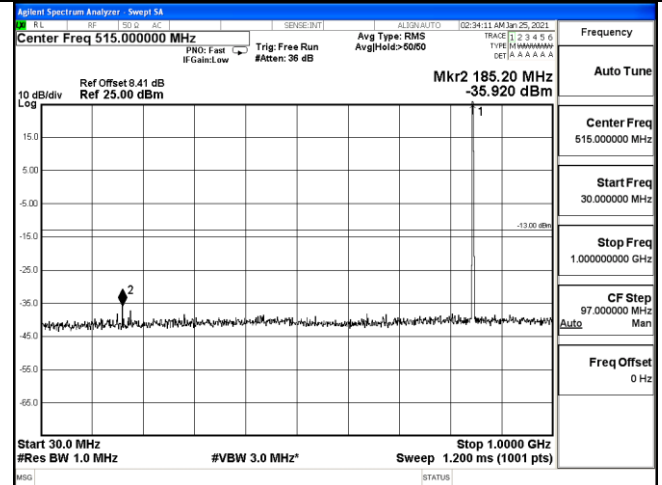

30 MHz – 1000 MHz

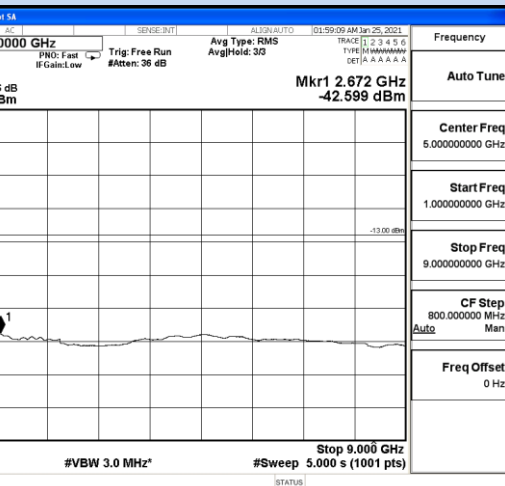

1 GHz – 9 GHz

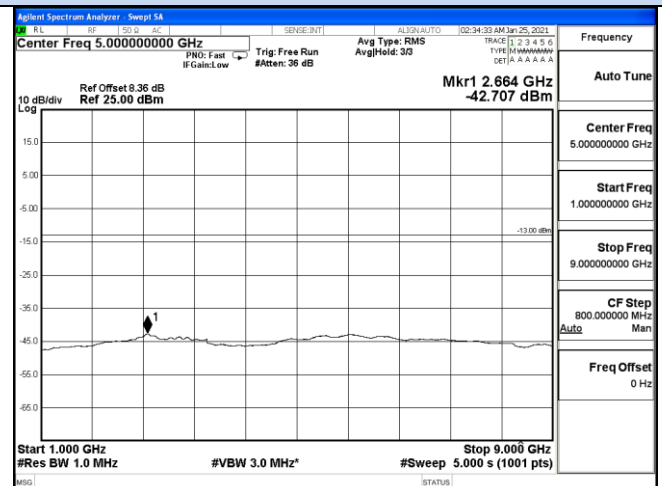

1 GHz – 9 GHz

Spurious Emission on Antenna Port
GSM/TM1/GSM1900
Channel 512 / 1850.2 MHz

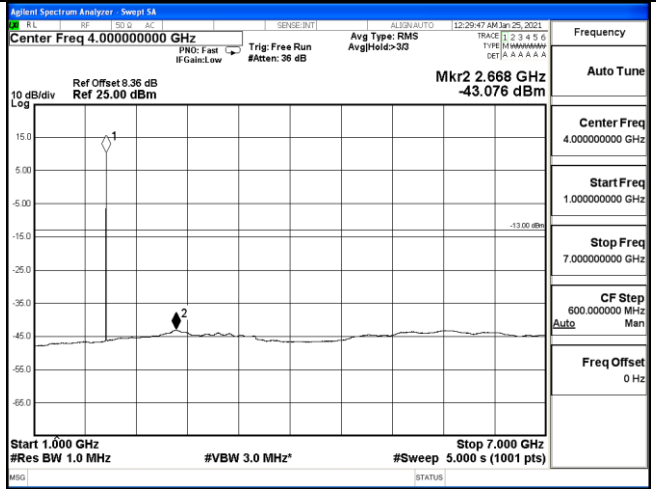
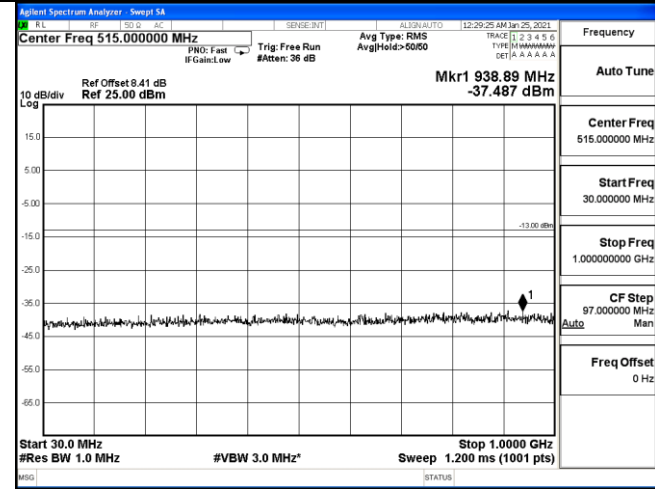

30 MHz – 1000 MHz

1 GHz – 7 GHz

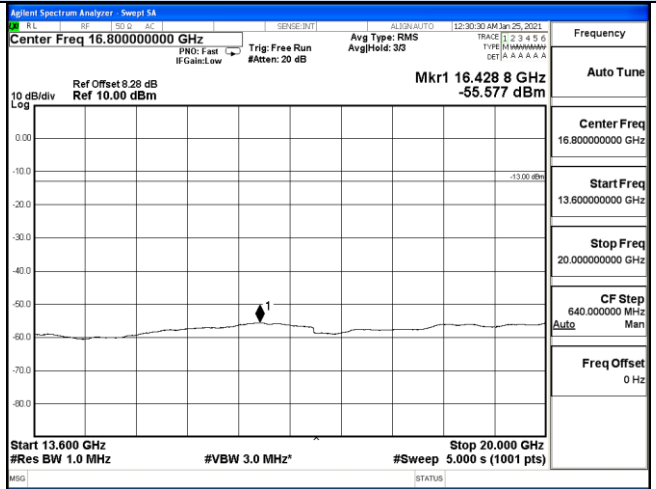
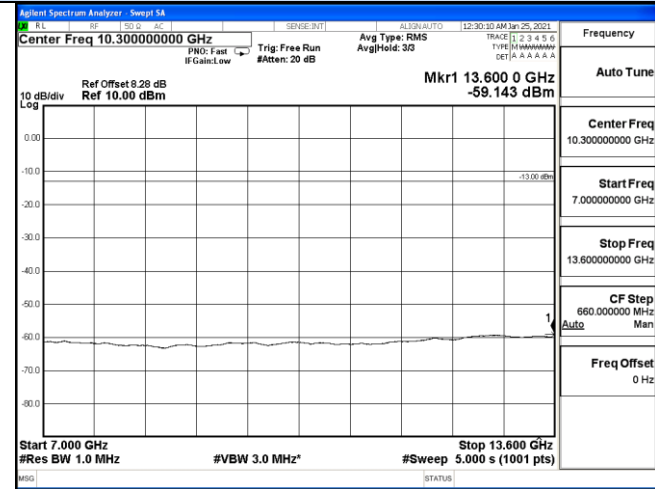

7 GHz – 13.6 GHz

13.6 GHz – 20 GHz

Spurious Emission on Antenna Port
GSM/TM1/GSM1900
Channel 661 / 1880 MHz

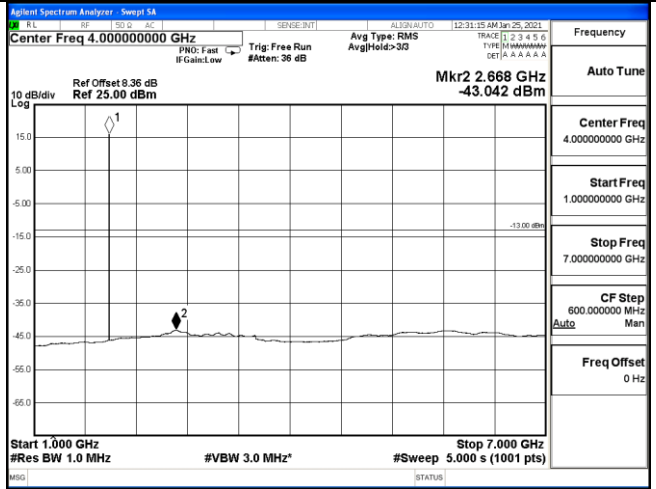
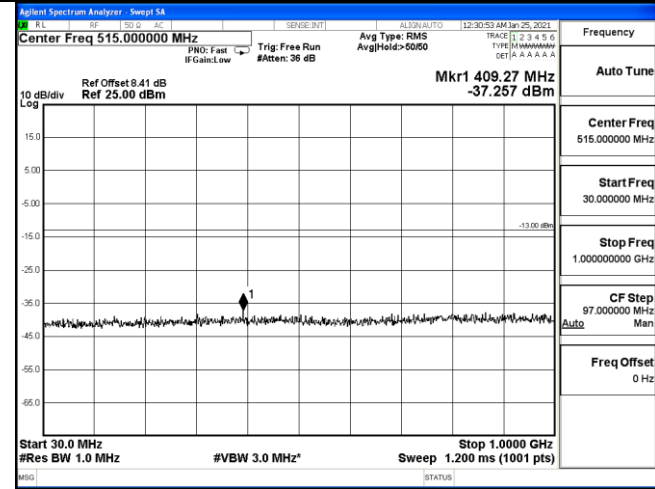

30 MHz – 1000 MHz

1 GHz – 7 GHz

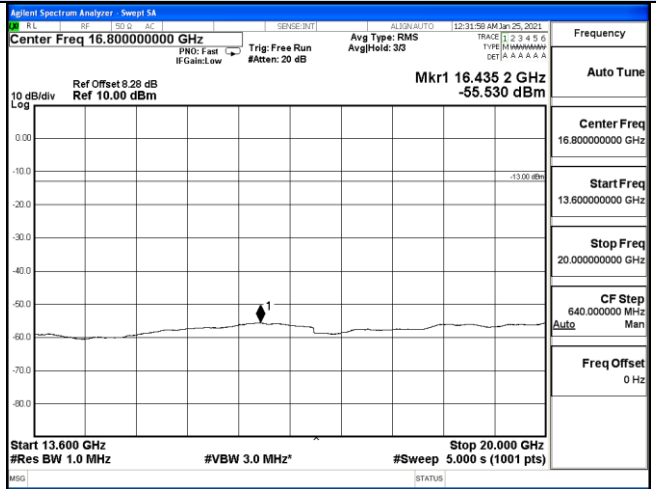
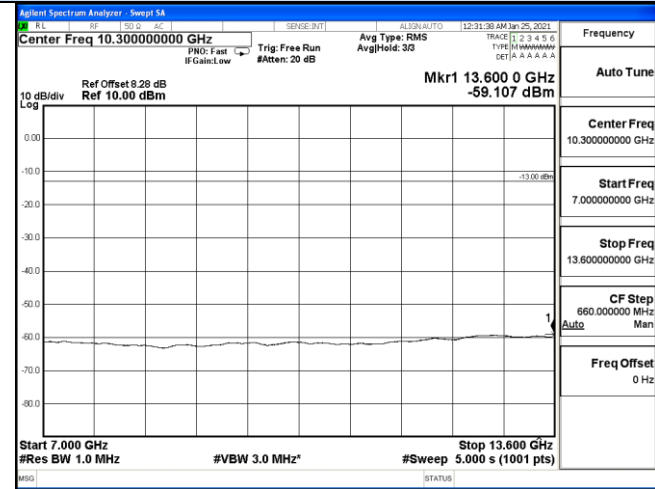

7 GHz – 13.6 GHz

13.6 GHz – 20 GHz

Spurious Emission on Antenna Port
GSM/TM1/GSM1900
Channel 810 / 1909.8 MHz

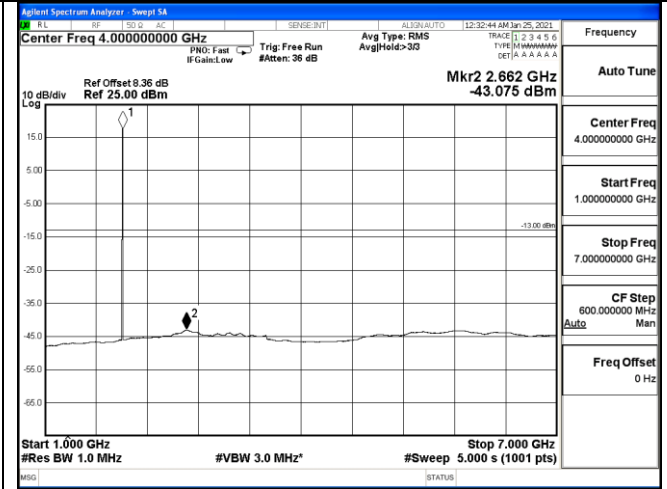
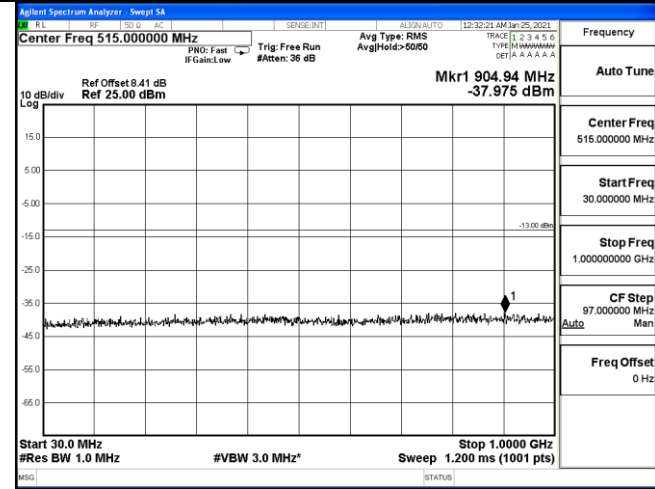

30 MHz – 1000 MHz

1 GHz – 7 GHz

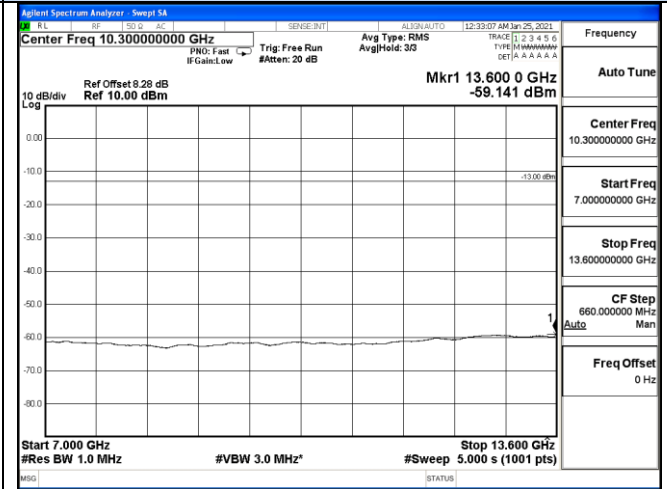
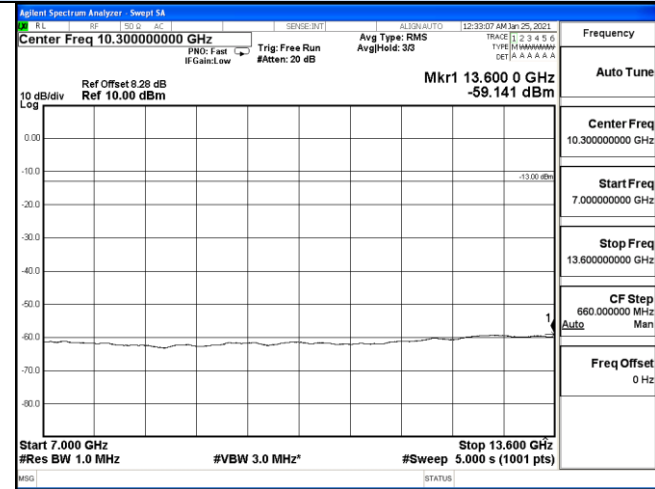

7 GHz – 13.6 GHz

13.6 GHz – 20 GHz

Spurious Emission on Antenna Port
GSM/TM3/EDGE1900
Channel 512 / 1850.2 MHz

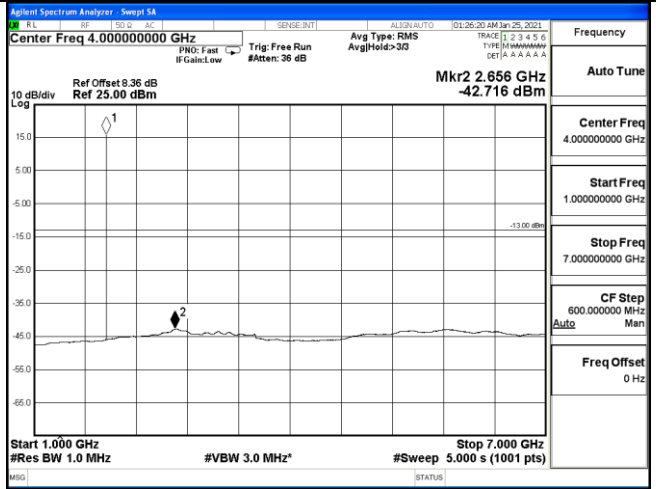
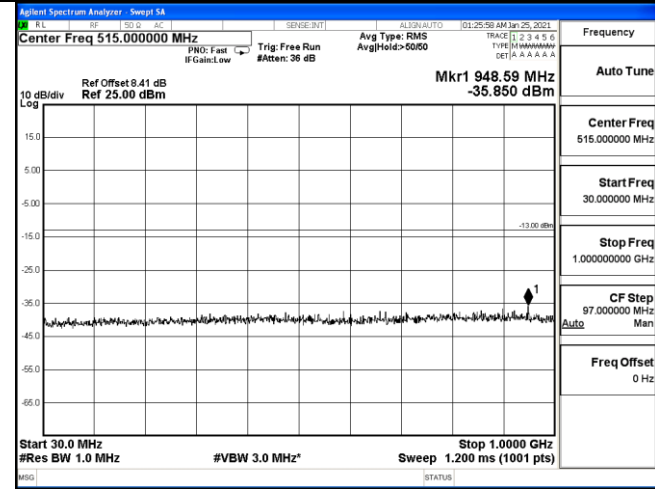

30 MHz – 1000 MHz

1 GHz – 7 GHz

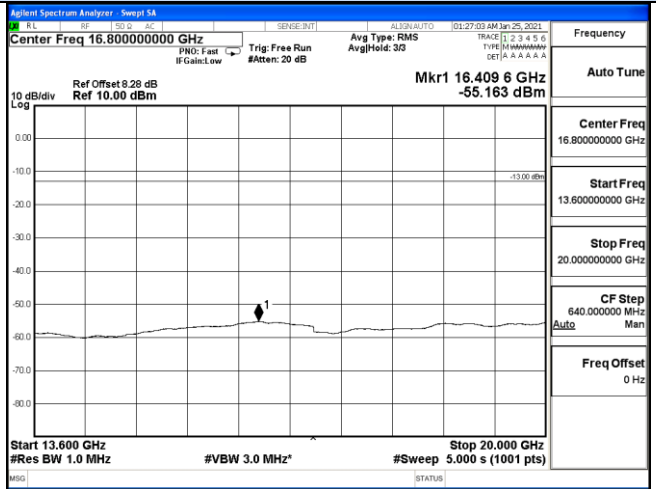
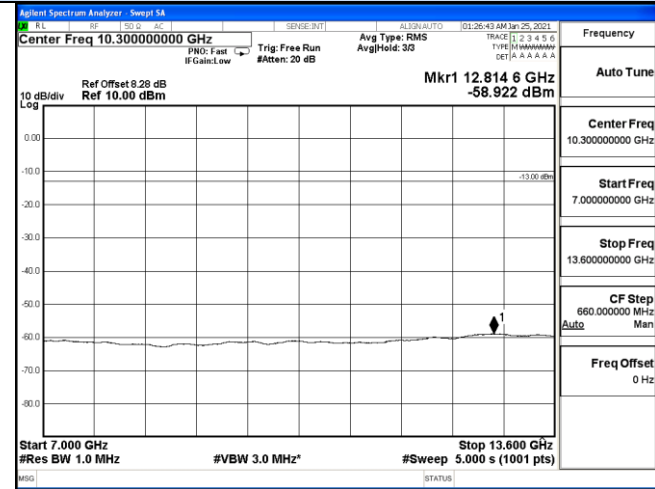

7 GHz – 13.6 GHz

13.6 GHz – 20 GHz

Spurious Emission on Antenna Port
GSM/TM3/EDGE1900
Channel 661 / 1880 MHz

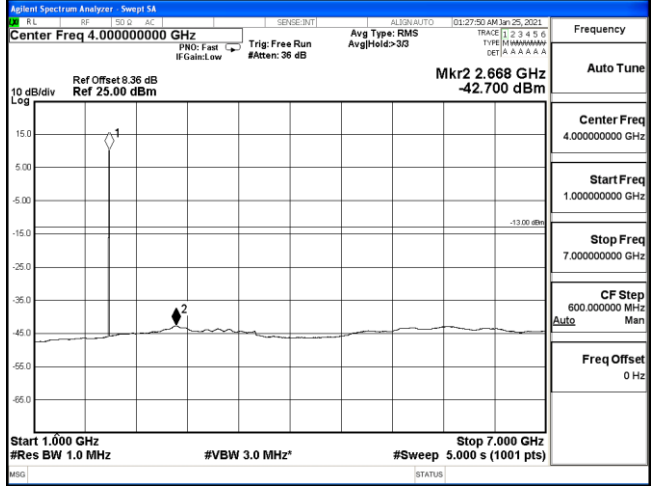
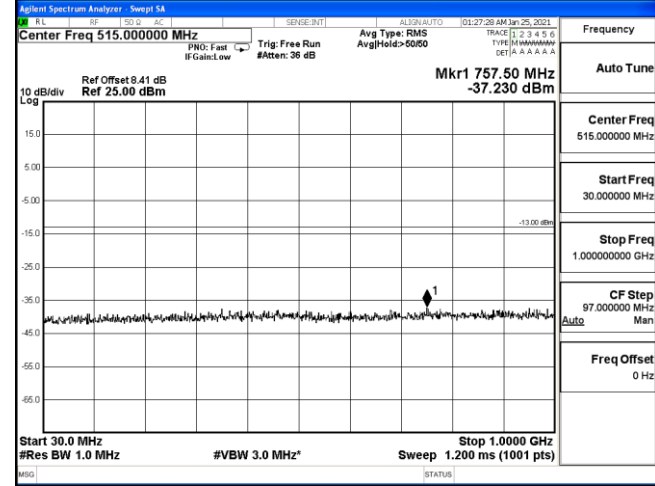

30 MHz – 1000 MHz

1 GHz – 7 GHz

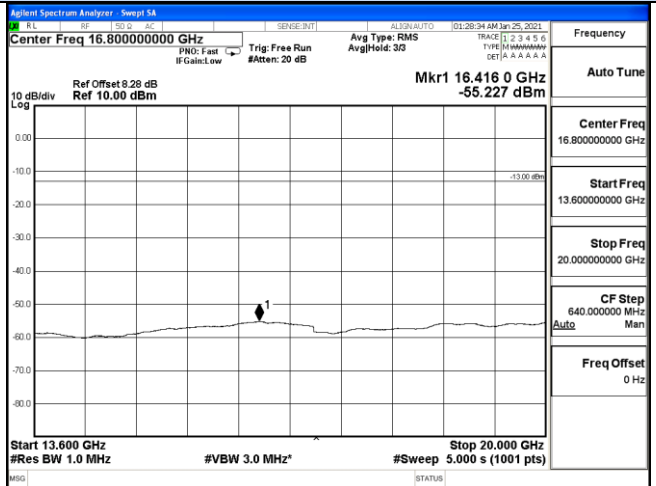
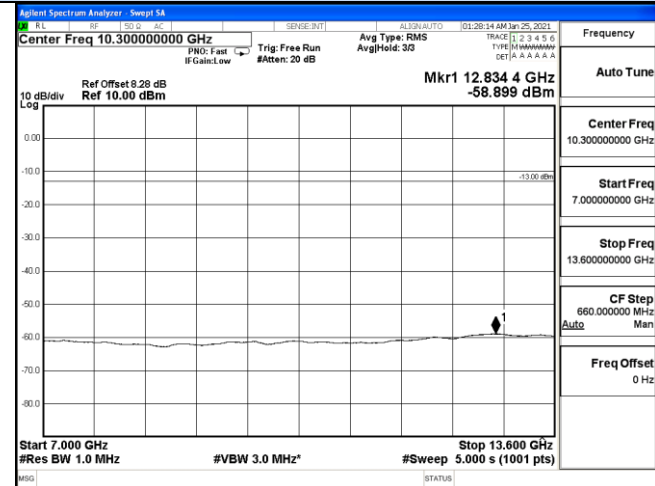

7 GHz – 13.6 GHz

13.6 GHz – 20 GHz

Spurious Emission on Antenna Port
GSM/TM3/EDGE1900
Channel 810 / 1909.8 MHz

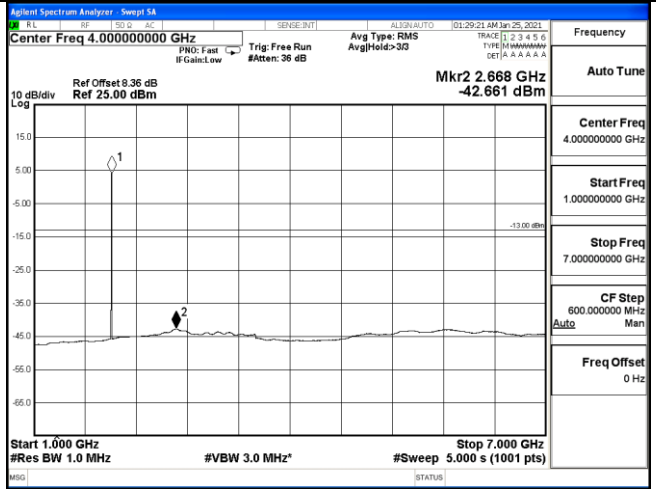
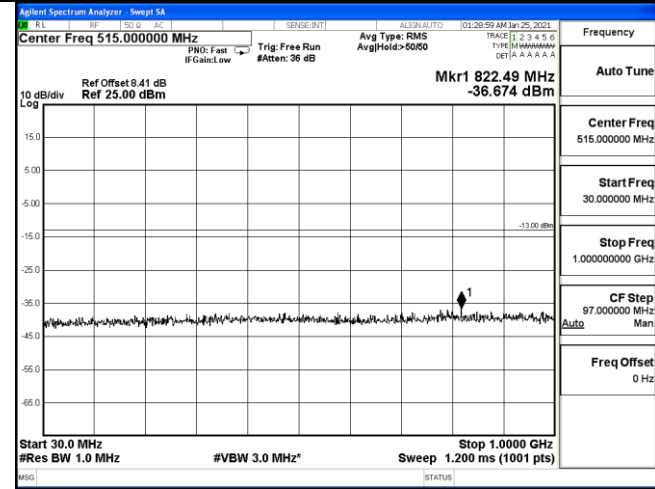

30 MHz – 1000 MHz

1 GHz – 7 GHz

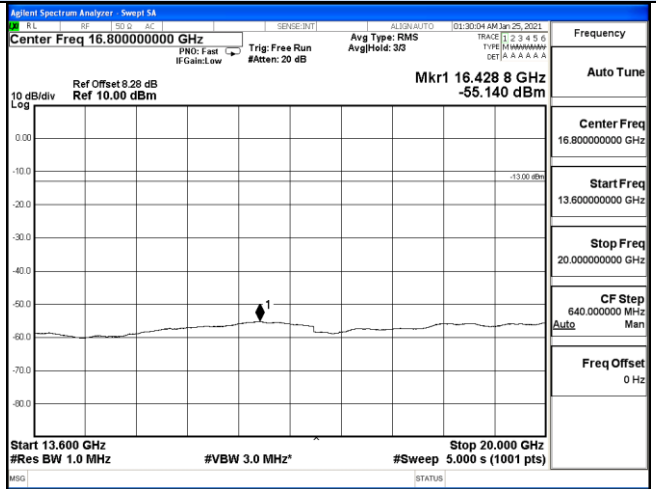
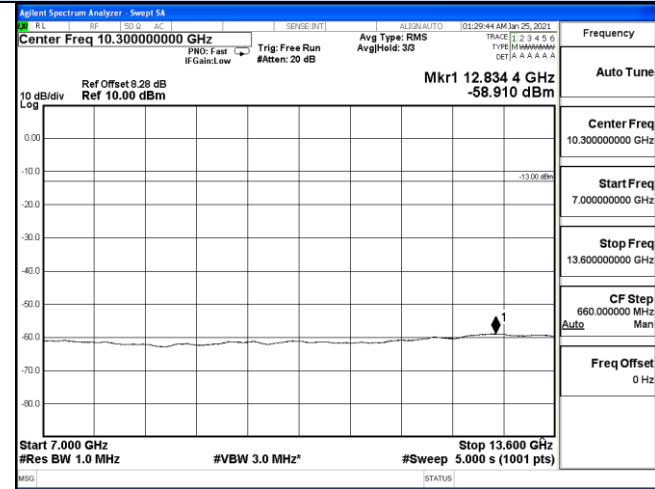

7 GHz – 13.6 GHz

13.6 GHz – 20 GHz

4.6 Frequency Stability Test

TEST APPLICABLE

1. According to FCC Part 2 Section 2.1055 (a)(1), the frequency stability shall be measured with variation of ambient temperature from -30°C to $+50^{\circ}\text{C}$ centigrade.
2. According to FCC Part 2 Section 2.1055 (E) (2), for hand carried, battery powered equipment, the frequency stability shall be measured with reducing primary supply voltage to the battery operating end point, which is specified by the manufacture.
3. Vary primary supply voltage from 85 to 115 percent of the nominal value for other than hand carried voltage equipment.

TEST PROCEDURE

In order to measure the carrier frequency under the condition of AFC lock, it is necessary to make measurements with the EUT in a "call mode". This is accomplished with the use of R&S CMW 500 DIGITAL RADIO COMMUNICATION TESTER.

1. Measure the carrier frequency at room temperature;
2. Subject the EUT to overnight soak at -30°C ;
3. With the EUT, powered via nominal voltage, connected to the CMW 500 and in a simulated call on middle channel of PCS 1900 and GSM850, measure the carrier frequency. These measurements should be made within 2 minutes of Powering up the EUT, to prevent significant self-warming;
4. Repeat the above measurements at 10°C increments from -30°C to $+50^{\circ}\text{C}$. Allow at least 0.5 hours at each temperature, unpowered, before making measurements;
5. Remeasure carrier frequency at room temperature with nominal voltage. Vary supply voltage from minimum voltage to maximum voltage, in 0.1Volt increments remeasuring carrier frequency at each voltage. Pause at nominal voltage for 0.5 hours unpowered, to allow any self-heating to stabilize, before continuing;
6. Subject the EUT to overnight soak at $+50^{\circ}\text{C}$;
7. With the EUT, powered via nominal voltage, connected to the CMW 500 and in a simulated call on the centre channel, measure the carrier frequency. These measurements should be made within 2 minutes of Powering up the EUT, to prevent significant self-warming;
8. Repeat the above measurements at 10°C increments from $+50^{\circ}\text{C}$ to -30°C . Allow at least 0.5 hours at each temperature, unpowered, before making measurements;
9. At all temperature levels hold the temperature to $\pm 0.5^{\circ}\text{C}$ during the measurement procedure;

TEST CONFIGURATION

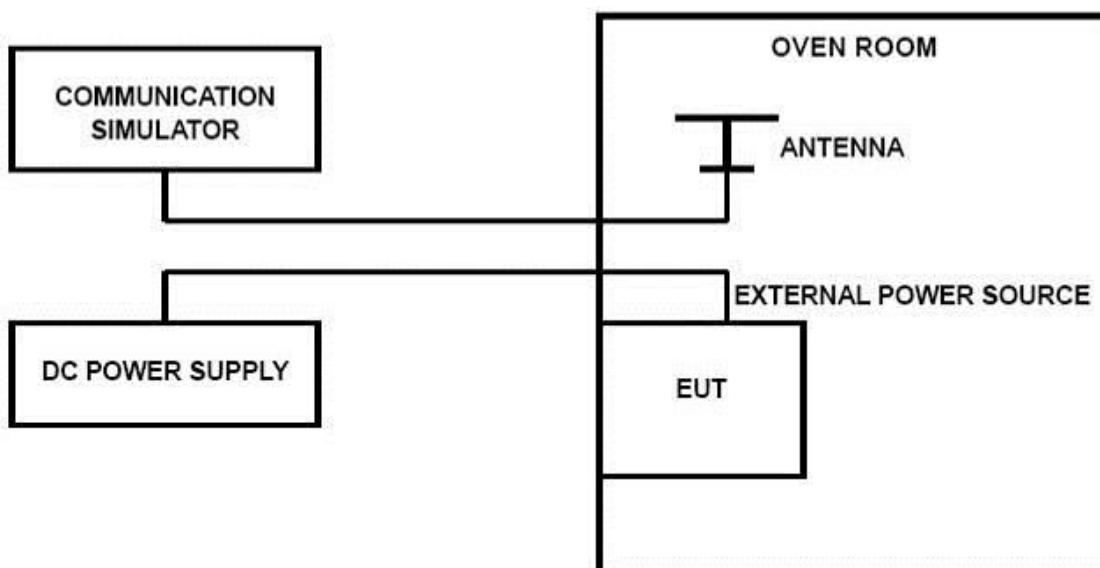

TEST LIMITS

- § 2.1055(a), 2.1055(d),

- § 22.355, the carrier frequency of each transmitter in the Public Mobile Services must be maintained within the tolerances given in Table C-1 of this section.

For Mobile devices operating in the 824 to 849 MHz band at a power level less than or equal to 3 Watts, the limit specified in Table C-1 is +/- 2.5 ppm.

- § 24.235, the frequency stability shall be sufficient to ensure that the fundamental emission stays within the authorized frequency block.

TEST RESULTS

GSM/TM1/GSM850					
DC Power	Temperature (°C)	Frequency error(Hz)	Frequency error(ppm)	Limit (ppm)	Verdict
3.6	25	-5	-0.006	2.50	PASS
3.8	25	-20	-0.024	2.50	PASS
4.35	25	48	0.058	2.50	PASS
3.8	-30	6	0.007	2.50	PASS
3.8	-20	-20	-0.024	2.50	PASS
3.8	-10	10	0.012	2.50	PASS
3.8	0	10	0.012	2.50	PASS
3.8	10	-44	-0.053	2.50	PASS
3.8	20	8	0.010	2.50	PASS
3.8	30	-32	-0.039	2.50	PASS
3.8	40	-41	-0.050	2.50	PASS
3.8	50	-46	-0.056	2.50	PASS

GSM/TM3/EDGE850					
DC Power	Temperature (°C)	Frequency error(Hz)	Frequency error(ppm)	Limit (ppm)	Verdict
3.6	25	-2	-0.002	2.50	PASS
3.8	25	43	0.052	2.50	PASS
4.35	25	11	0.013	2.50	PASS
3.8	-30	30	0.036	2.50	PASS
3.8	-20	43	0.052	2.50	PASS
3.8	-10	-13	-0.016	2.50	PASS
3.8	0	20	0.024	2.50	PASS
3.8	10	48	0.058	2.50	PASS
3.8	20	47	0.057	2.50	PASS
3.8	30	7	0.008	2.50	PASS
3.8	40	39	0.047	2.50	PASS
3.8	50	-3	-0.004	2.50	PASS

GSM/TM1/GSM1900					
DC Power	Temperature (°C)	Frequency error(Hz)	Frequency error(ppm)	Limit (ppm)	Verdict
3.6	25	5	0.003	2.50	PASS
3.8	25	41	0.022	2.50	PASS
4.35	25	-2	-0.001	2.50	PASS
3.8	-30	39	0.021	2.50	PASS
3.8	-20	-23	-0.012	2.50	PASS
3.8	-10	-38	-0.020	2.50	PASS
3.8	0	-21	-0.011	2.50	PASS
3.8	10	-30	-0.016	2.50	PASS
3.8	20	43	0.023	2.50	PASS
3.8	30	19	0.010	2.50	PASS
3.8	40	-14	-0.007	2.50	PASS
3.8	50	-15	-0.008	2.50	PASS

GSM/TM3/EDGE1900					
DC Power	Temperature (°C)	Frequency error(Hz)	Frequency error(ppm)	Limit (ppm)	Verdict
3.6	25	5	0.003	2.50	PASS
3.8	25	48	0.026	2.50	PASS
4.35	25	10	0.005	2.50	PASS
3.8	-30	-25	-0.013	2.50	PASS
3.8	-20	1	0.001	2.50	PASS
3.8	-10	34	0.018	2.50	PASS
3.8	0	-46	-0.024	2.50	PASS
3.8	10	20	0.011	2.50	PASS
3.8	20	-42	-0.022	2.50	PASS
3.8	30	-16	-0.009	2.50	PASS
3.8	40	49	0.026	2.50	PASS
3.8	50	-39	-0.021	2.50	PASS

Note: The EUT is hand carried battery powered equipment.

4.7 Peak-to-Average Ratio (PAR)

LIMIT

The Peak-to-Average Ratio (PAR) of the transmission may not exceed 13 dB.

TEST CONFIGURATION

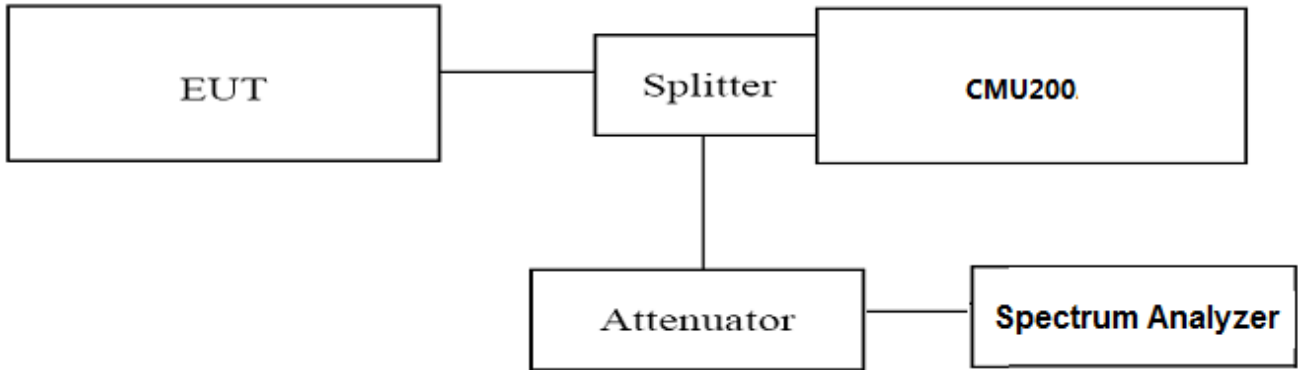

TEST PROCEDURE

Use spectrum to measure the total peak power and record as P_{Pk}. Use spectrum to measure the total average power and record as P_{Avg}. Both the peak and average power levels must be expressed in the same logarithmic units (e.g., dBm).

Determine the PAPR from:

$$PAPR (dB) = P_{Pk} (dBm) - P_{Avg} (dBm).$$

Record the maximum PAPR level associated with a probability of 0.1%.

TEST RESULTS

Test Mode	Channel	Frequency (MHz)	PAPR Value (dB)	Limits (dB)	Verdict
GSM/TM1/GSM850	128	824.2	2.82	13.0	PASS
	190	836.6	2.80	13.0	
	251	848.8	2.81	13.0	
GSM/TM3/EDGE850	128	824.2	5.88	13.0	PASS
	190	836.6	5.81	13.0	
	251	848.8	5.73	13.0	
GSM/TM1/GSM1900	512	1850.2	2.63	13.0	PASS
	661	1880.0	2.67	13.0	
	810	1909.8	2.67	13.0	
GSM/TM3/EDGE1900	512	1850.2	5.46	13.0	PASS
	661	1880.0	5.88	13.0	
	810	1909.8	5.85	13.0	

Peak-to-Average Ratio (PAR)

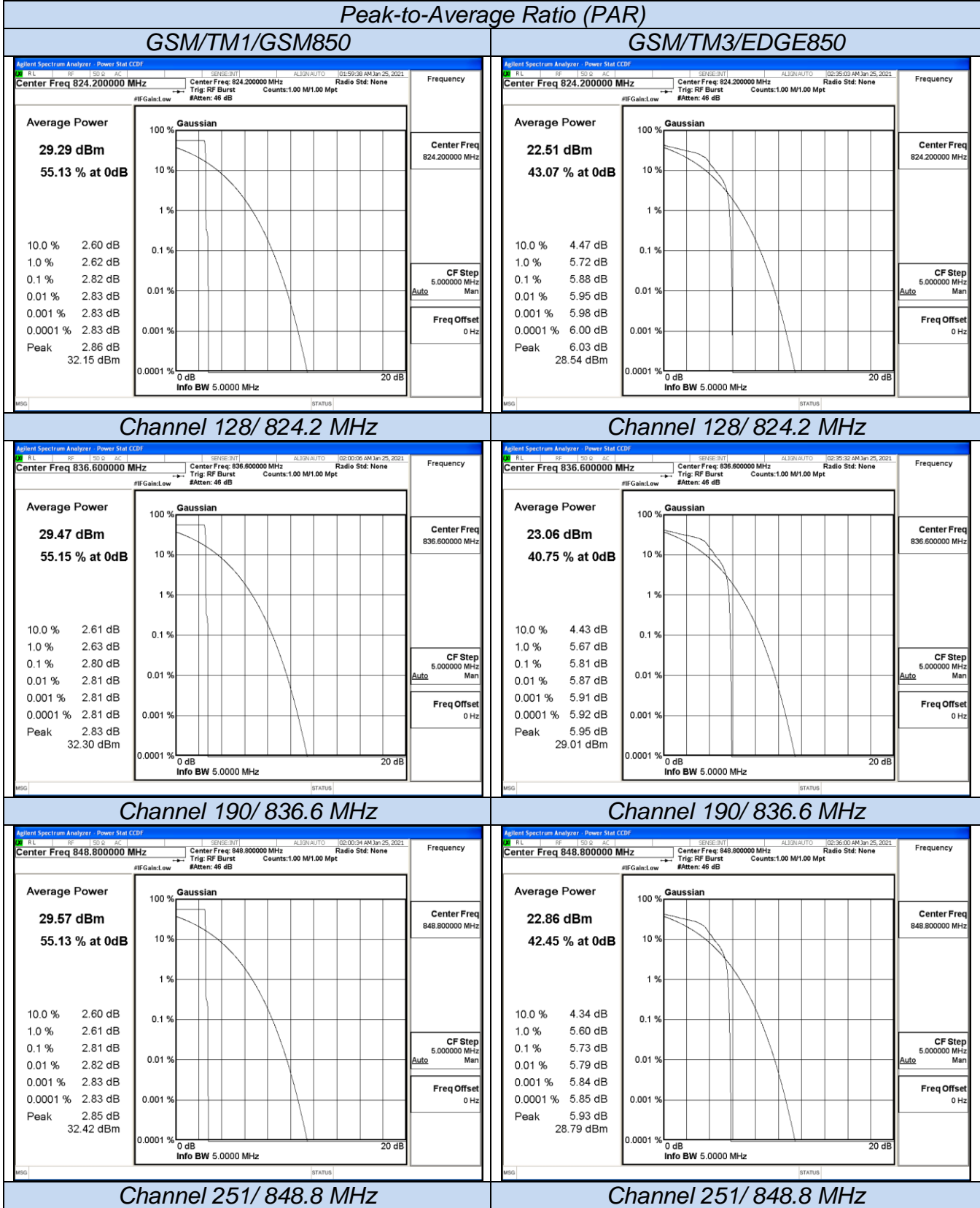

Peak-to-Average Ratio (PAR)

GSM/TM1/GSM1900

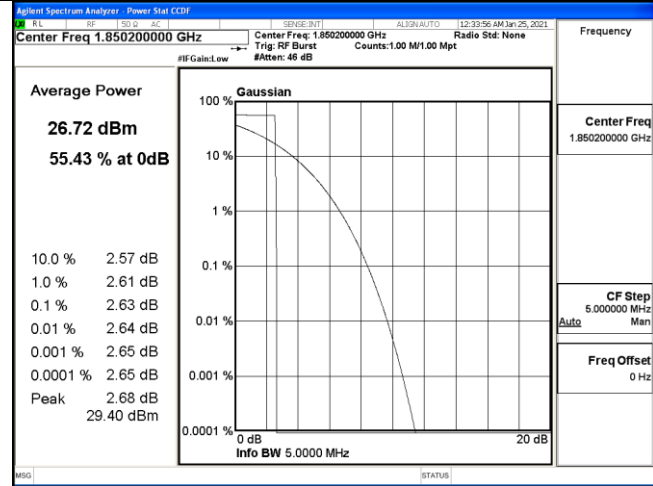

GSM/TM3/EDGE1900

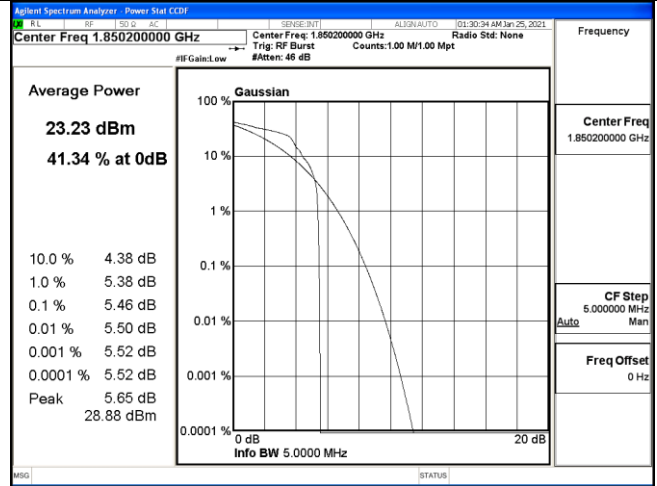

Channel 512/ 1850.2 MHz

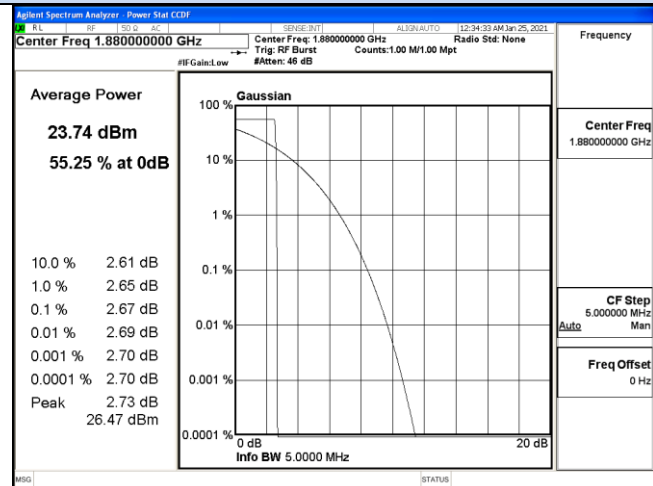

Channel 512/ 1850.2 MHz

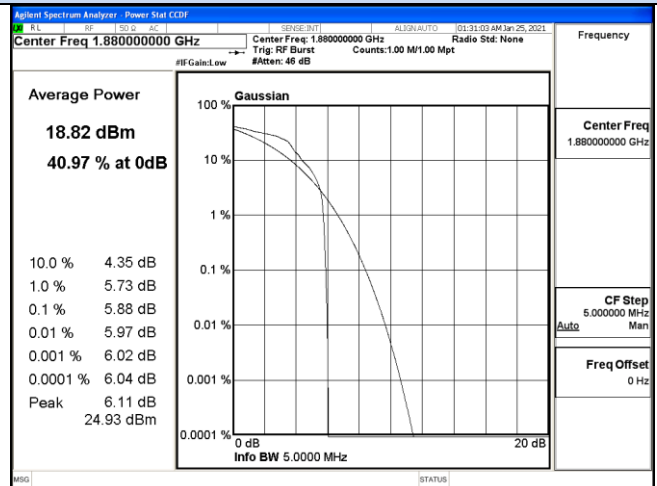

Channel 661/ 1880 MHz

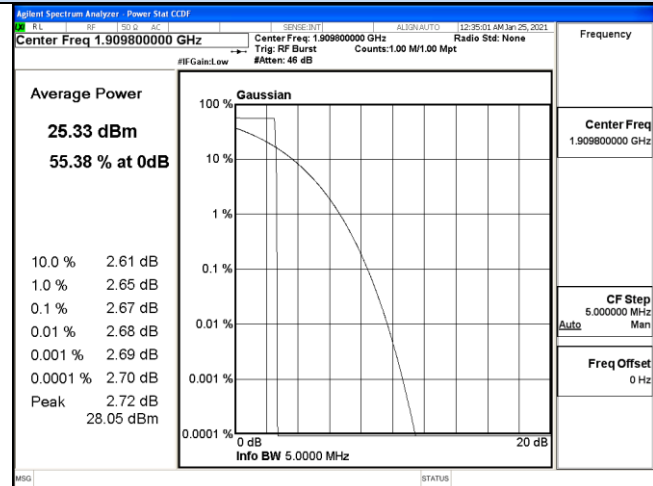

Channel 661/ 1880 MHz

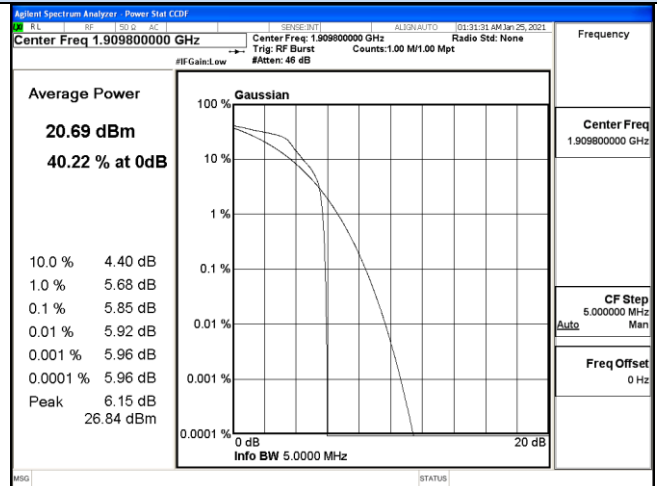

Channel 810/ 1909.8 MHz

Channel 810/ 1909.8 MHz

5 TEST SETUP PHOTOGRAPHS OF EUT

Please refer to separated files for Test Setup Photos of the EUT.

6 EXTERIOR PHOTOGRAPHS OF THE EUT

Please refer to separated files for External Photos of the EUT.

7 INTERIOR PHOTOGRAPHS OF THE EUT

Please refer to separated files for Internal Photos of the EUT.

.....**End of Report**.....