

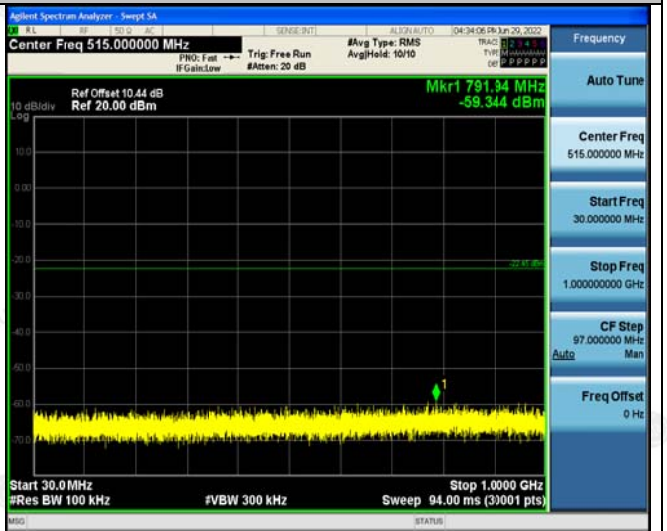

Spurious emission(2437MHz)



The results shown in this test report refer only to the sample(s) tested unless otherwise stated and the sample(s) are retained for 30 days only. The document is issued by HUAJ, this document cannot be reproduced except in full with our prior written permission. The more details and the authenticity of the report will be confirmed at <http://www.cer-mark.com>.

TEL : +86-755 2302 9901 FAX : +86-755 2302 9901 E-mail : service@cer-mark.com

Add: 1-2F., Building B2, Junfeng Zhongcheng Zhizao Innovation Park, Heping Community, Fuhai Street, Bao'an District, Shenzhen, Guangdong, China



802.11n (HT20) Modulation



The results shown in this test report refer only to the sample(s) tested unless otherwise stated and the sample(s) are retained for 30 days only. The document is issued by HUAK, this document cannot be reproduced except in full with our prior written permission. The more details and the authenticity of the report will be confirmed at <http://www.cer-mark.com>.

TEL : +86-755 2302 9901 FAX : +86-755 2302 9901 E-mail : service@cer-mark.com

Add: 1-2F., Building B2, Junfeng Zhongcheng Zhizao Innovation Park, Heping Community, Fuhai Street, Bao'an District, Shenzhen, Guangdong, China

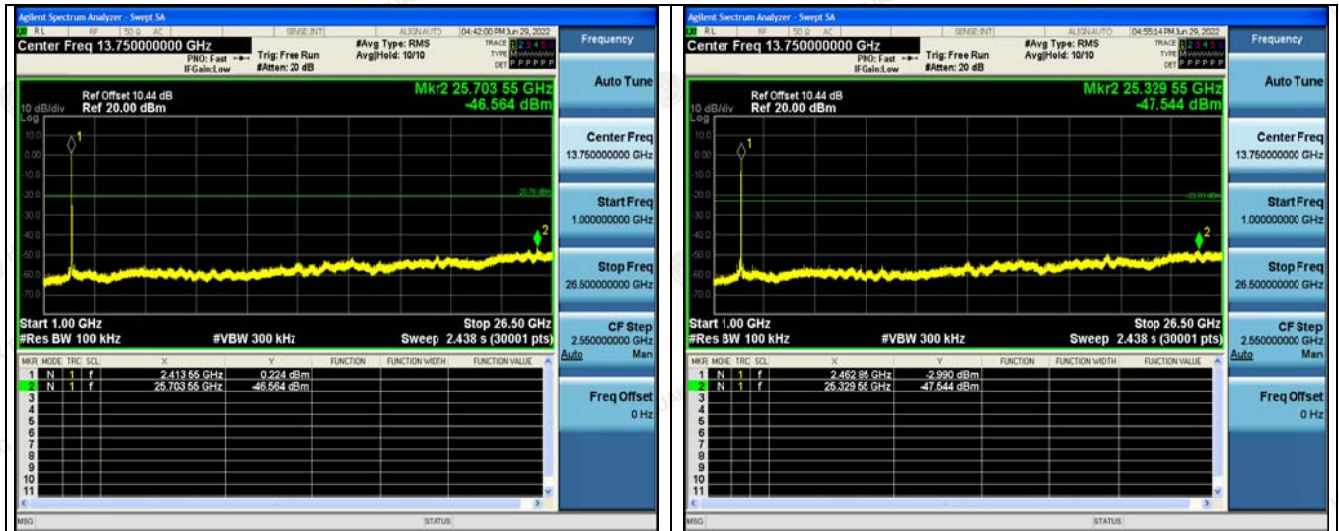

Spurious emission(2437MHz)

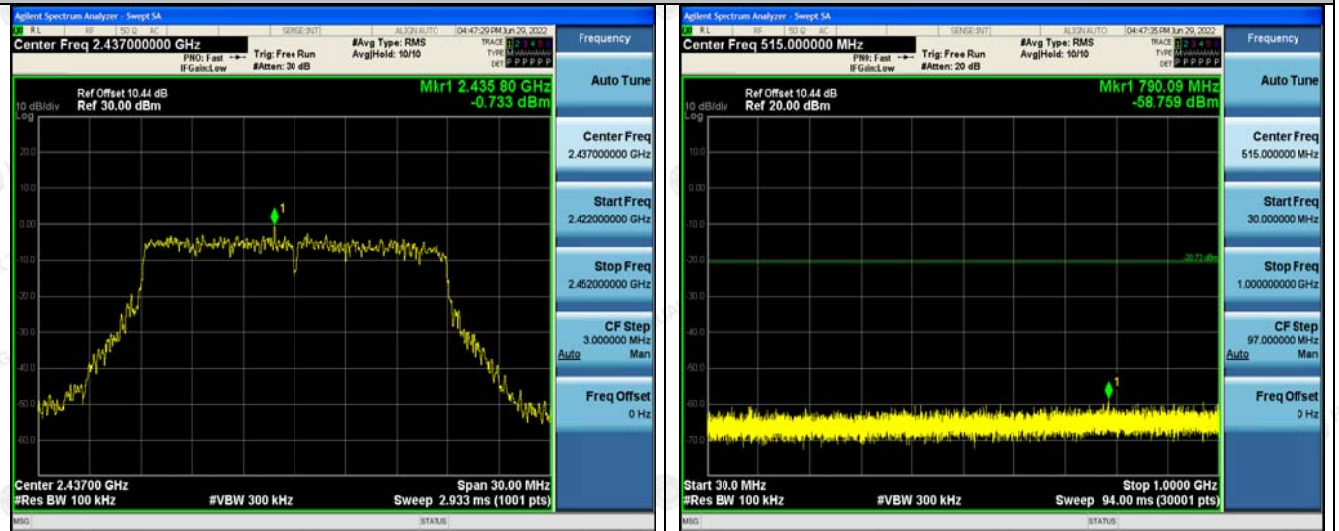

The results shown in this test report refer only to the sample(s) tested unless otherwise stated and the sample(s) are retained for 30 days only. The document is issued by HUAJ, this document cannot be reproduced except in full with our prior written permission. The more details and the authenticity of the report will be confirmed at <http://www.cer-mark.com>.

TEL : +86-755 2302 9901 FAX : +86-755 2302 9901 E-mail : service@cer-mark.com

Add: 1-2F., Building B2, Junfeng Zhongcheng Zhizao Innovation Park, Heping Community, Fuhai Street, Bao'an District, Shenzhen, Guangdong, China



802.11n (HT40) Modulation



The results shown in this report refer only to the sample(s) tested unless otherwise stated and the sample(s) are retained for 30 days only. The document is issued by HUAJ, this document cannot be reproduced except in full with our prior written permission. The more details and the authenticity of the report will be confirmed at <http://www.cer-mark.com>.

TEL : +86-755 2302 9901 FAX : +86-755 2302 9901 E-mail : service@cer-mark.com

Add: 1-2F., Building B2, Junfeng Zhongcheng Zhizao Innovation Park, Heping Community, Fuhai Street, Bao'an District, Shenzhen, Guangdong, China

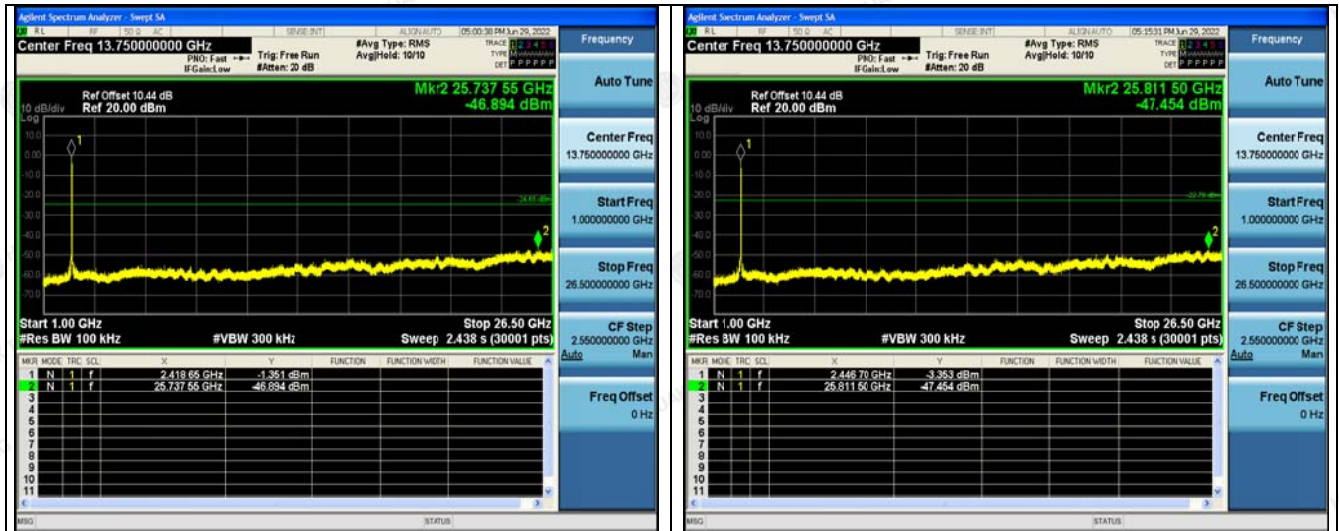

Spurious emission(2437MHz)

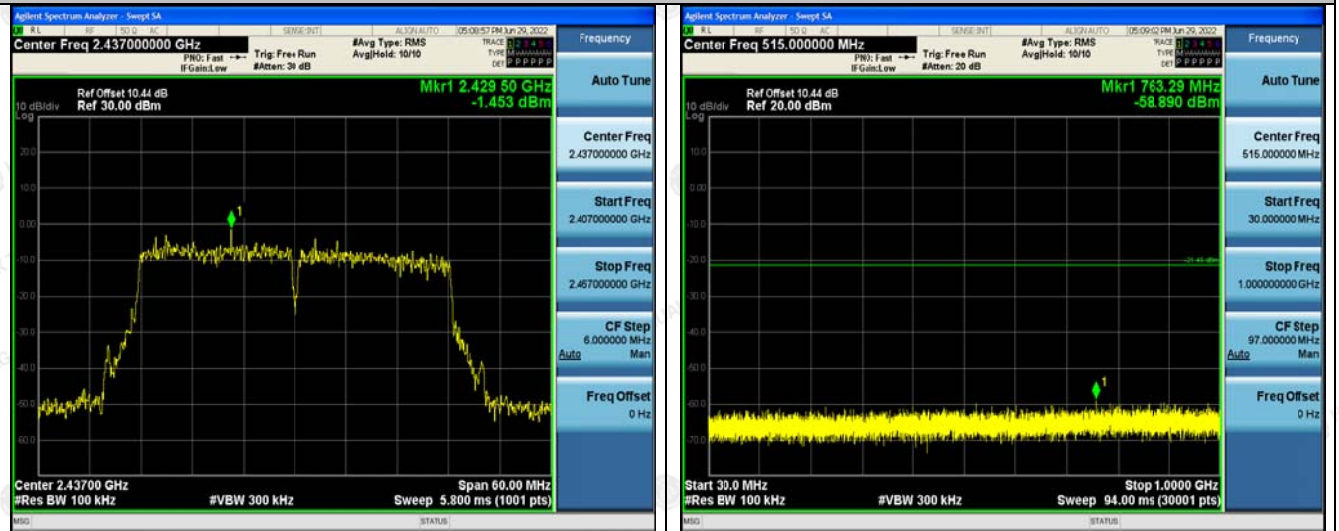

The results shown in this test report refer only to the sample(s) tested unless otherwise stated and the sample(s) are retained for 30 days only. The document is issued by HUAJ, this document cannot be reproduced except in full with our prior written permission. The more details and the authenticity of the report will be confirmed at <http://www.cer-mark.com>.

TEL : +86-755 2302 9901 FAX : +86-755 2302 9901 E-mail : service@cer-mark.com

Add: 1-2F., Building B2, Junfeng Zhongcheng Zhizao Innovation Park, Heping Community, Fuhai Street, Bao'an District, Shenzhen, Guangdong, China

### 4.7. RADIATED SPURIOUS EMISSION MEASUREMENT

#### Test Specification

<b>Test Requirement:</b>	FCC Part15 C Section 15.209					
<b>Test Method:</b>	ANSI C63.10: 2013					
<b>Frequency Range:</b>	9 kHz to 25 GHz					
<b>Measurement Distance:</b>	3 m					
<b>Antenna Polarization:</b>	Horizontal & Vertical					
<b>Operation mode:</b>	Transmitting mode with modulation					
<b>Receiver Setup:</b>	Frequency	Detector	RBW	VBW	Remark	
	9kHz- 150kHz	Quasi-peak	200Hz	1kHz	Quasi-peak Value	
	150kHz- 30MHz	Quasi-peak	9kHz	30kHz	Quasi-peak Value	
	30MHz-1GHz	Quasi-peak	120KHz	300KHz	Quasi-peak Value	
	Above 1GHz	Peak	1MHz	3MHz	Peak Value	
		Peak	1MHz	10Hz	Average Value	
<b>Limit:</b>	Frequency	Field Strength (microvolts/meter)	Measurement Distance (meters)			
	0.009-0.490	2400/F(KHz)	300			
	0.490-1.705	24000/F(KHz)	30			
	1.705-30	30	30			
	30-88	100	3			
	88-216	150	3			
	216-960	200	3			
	Above 960	500	3			
	Frequency	Field Strength (microvolts/meter)	Measurement Distance (meters)	Detector		
	Above 1GHz	500	3	Average		
	5000	3	Peak			
<b>Test setup:</b>	For radiated emissions below 30MHz					
	30MHz to 1GHz					

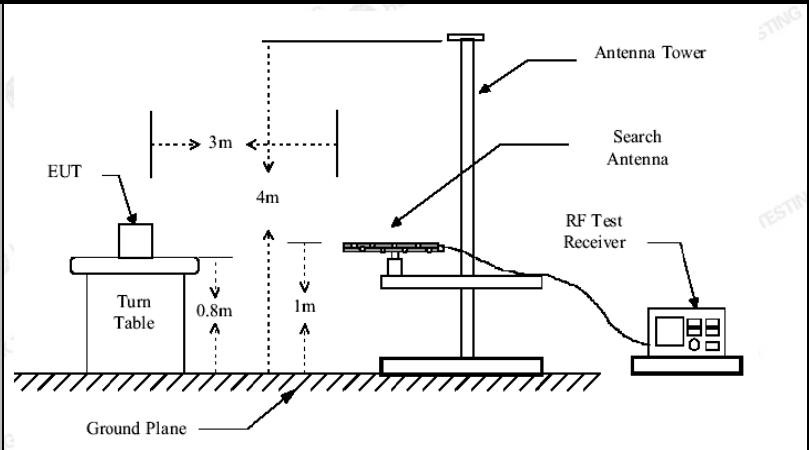

Above 1GHz

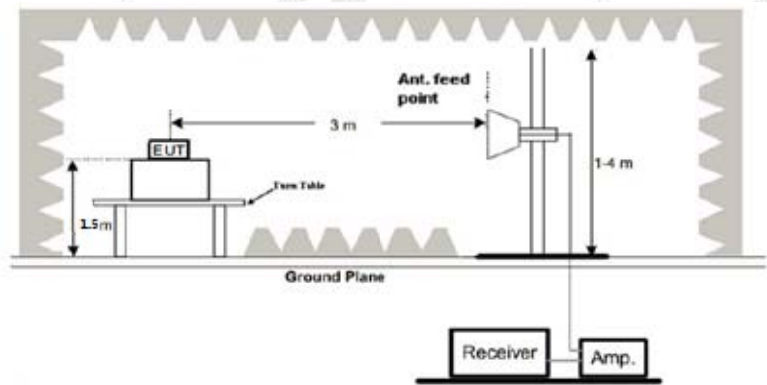

**Test Procedure:**

1. For the radiated emission test below 1GHz:  
The EUT was placed on a turntable with 0.8 meter above ground. The EUT was set 3 meters from the interference receiving antenna, which was mounted on the top of a variable height antenna tower. The EUT was arranged to its worst case and then tune the antenna tower (from 1 m to 4 m) and turntable (from 0 degree to 360 degrees) to find the maximum reading. A pre-amp and a high PASS filter are used for the test in order to get better signal level.
2. For the radiated emission test above 1GHz:  
Place the measurement antenna on a turntable with 1.5 meter above ground, which is away from each area of the EUT determined to be a source of emissions at the specified measurement distance, while keeping the measurement antenna aimed at the source of emissions at each frequency of significant emissions, with polarization oriented for maximum response. The measurement antenna may have to be higher or lower than the EUT, depending on the radiation pattern of the emission and staying aimed at the emission source for receiving the maximum signal.



	<p>The final measurement antenna elevation shall be that which maximizes the emissions. The measurement antenna elevation for maximum emissions shall be restricted to a range of heights of from 1 m to 4 m above the ground or reference ground plane.</p> <p>3. Corrected Reading: Antenna Factor + Cable Loss + Read Level - Preamp Factor = Level</p> <p>4. For measurement below 1GHz, If the emission level of the EUT measured by the peak detector is 3 dB lower than the applicable limit, the peak emission level will be reported. Otherwise, the emission measurement will be repeated using the quasi-peak detector and reported.</p> <p>5. Use the following spectrum analyzer settings:</p> <ul style="list-style-type: none"> <li>(1) Span shall wide enough to fully capture the emission being measured;</li> <li>(2) Set RBW=120 kHz for <math>f &lt; 1</math> GHz; VBW <math>\geq</math> RBW; Sweep = auto; Detector function = peak; Trace = max hold;</li> <li>(3) Set RBW = 1 MHz, VBW= 3MHz for <math>f \geq 1</math> GHz for peak measurement.</li> </ul> <p>6. For average measurement: VBW = 10 Hz, when duty cycle is no less than 98 percent. VBW <math>\geq 1/T</math>, when duty cycle is less than 98 percent where T is the minimum transmission duration over which the transmitter is on and is transmitting at its maximum power control level for the tested mode of operation.</p>
<b>Test results:</b>	<b>PASS</b>





**Test Instruments**

<b>Radiated Emission Test Site (966)</b>					
<b>Name of Equipment</b>	<b>Manufacturer</b>	<b>Model</b>	<b>Serial Number</b>	<b>Calibration Date</b>	<b>Calibration Due</b>
Receiver	R&S	ESCI-7	HKE-010	Feb. 18, 2022	Feb. 17, 2023
Spectrum analyzer	Agilent	N9020A	HKE-048	Feb. 18, 2022	Feb. 17, 2023
Spectrum analyzer	R&S	FSP40	HKE-025	Feb. 18, 2022	Feb. 17, 2023
High gain antenna	Schwarzbeck	LB-180400KF	HKE-054	Feb. 18, 2022	Feb. 17, 2023
Preamplifier	Schwarzbeck	BBV 9743	HKE-006	Feb. 18, 2022	Feb. 17, 2023
Preamplifier	EMCI	EMC051845S E	HKE-015	Feb. 18, 2022	Feb. 17, 2023
Preamplifier	Agilent	83051A	HKE-016	Feb. 18, 2022	Feb. 17, 2023
Loop antenna	Schwarzbeck	FMZB 1519 B	HKE-014	Feb. 18, 2022	Feb. 17, 2023
Broadband antenna	Schwarzbeck	VULB 9163	HKE-012	Feb. 18, 2022	Feb. 17, 2023
Horn antenna	Schwarzbeck	9120D	HKE-013	Feb. 18, 2022	Feb. 17, 2023
High pass filter unit	Tonscend	JS0806-F	HKE-055	Feb. 18, 2022	Feb. 17, 2023
Antenna Mast	Keleto	CC-A-4M	N/A	N/A	N/A
Position controller	Taiwan MF	MF7802	HKE-011	Feb. 18, 2022	Feb. 17, 2023
Radiated test software	Tonscend	TS+ Rev 2.5.0.0	HKE-082	N/A	N/A
RF cable	Times	9kHz-1GHz	HKE-117	Feb. 18, 2022	Feb. 17, 2023
RF cable	Times	1-40G	HKE-034	Feb. 18, 2022	Feb. 17, 2023
Horn Antenna	Schwarzbeck	BBHA 9170	HKE-017	Feb. 18, 2022	Feb. 17, 2023

**Note:** The calibration interval of the above test instruments is 12 months and the calibrations are traceable to international system unit (SI).



Test Data

All the test modes completed for test. only the worst result of (802.11b at 2412MHz) was reported as below:

Below 1GHz

Horizontal

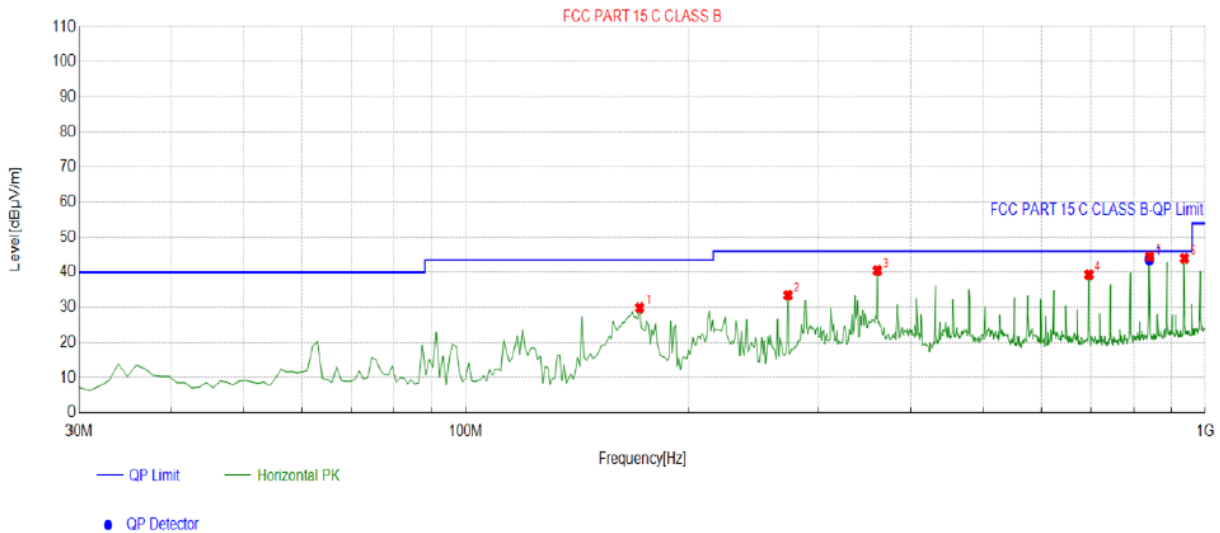

Suspected List									
NO.	Freq. [MHz]	Factor [dB]	Reading [dBµV/m]	Level [dBµV/m]	Limit [dBµV/m]	Margin [dB]	Height [cm]	Angle [°]	Polarity
1	171.7618	-16.64	46.53	29.89	43.50	13.61	100	60	Horizontal
2	272.7427	-12.31	45.82	33.51	46.00	12.49	100	87	Horizontal
3	360.1301	-10.69	51.19	40.50	46.00	5.50	100	328	Horizontal
4	696.0861	-3.64	43.01	39.37	46.00	6.63	100	29	Horizontal
5	840.7608	-1.09	45.55	44.46	46.00	1.54	100	103	Horizontal
6	936.8869	-0.23	44.24	44.01	46.00	1.99	100	58	Horizontal

Final Data List									
NO.	Freq. [MHz]	Factor [dB]	QP Reading [dBµV/m]	QP Value [dBµV/m]	QP Limit [dBµV/m]	QP Margin [dB]	Height [cm]	Angle [°]	Polarity
1	840.0312	-1.08	44.76	43.68	46.00	2.32	150	90.6	Horizontal

Remark: Factor = Cable loss + Antenna factor - Preamplifier; Level = Reading + Factor; Margin = Limit - Level



Vertical

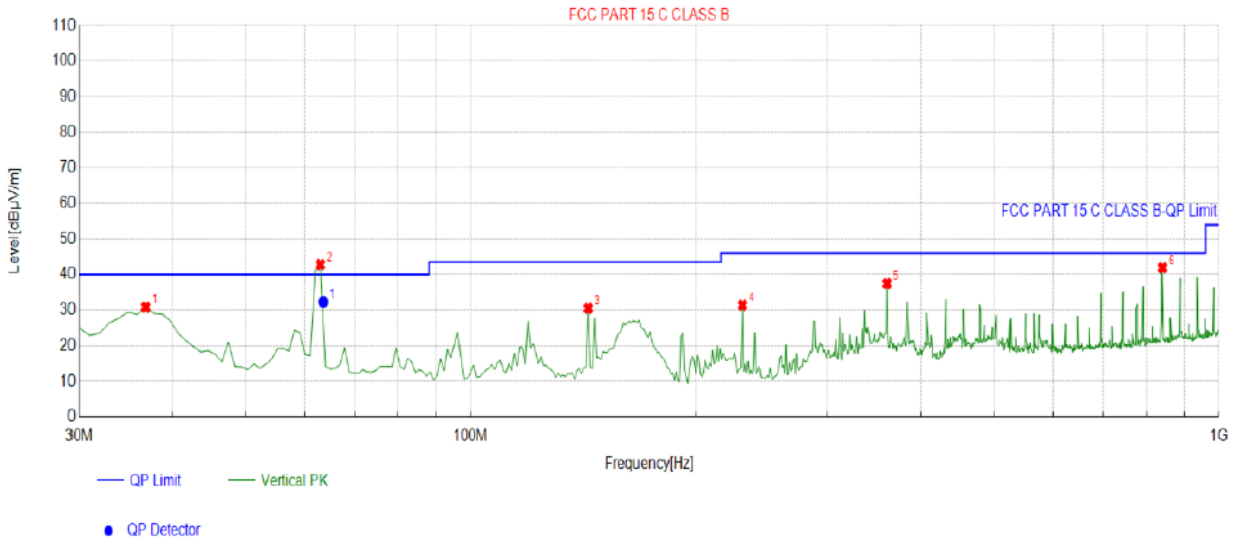

Suspected List									
NO.	Freq. [MHz]	Factor [dB]	Reading [dBµV/m]	Level [dBµV/m]	Limit [dBµV/m]	Margin [dB]	Height [cm]	Angle [°]	Polarity
1	36.7968	-15.57	46.39	30.82	40.00	9.18	100	326	Vertical
2	63.0130	-14.25	57.03	42.78	40.00	-2.78	100	149	Vertical
3	143.6036	-18.07	48.56	30.49	43.50	13.01	100	43	Vertical
4	230.9910	-13.55	44.94	31.39	46.00	14.61	100	35	Vertical
5	360.1301	-10.69	48.17	37.48	46.00	8.52	100	267	Vertical
6	840.7608	-1.09	43.02	41.93	46.00	4.07	100	69	Vertical

Final Data List									
NO.	Freq. [MHz]	Factor [dB]	QP Reading [dBµV/m]	QP Value [dBµV/m]	QP Limit [dBµV/m]	QP Margin [dB]	Height [cm]	Angle [°]	Polarity
1	63.5529	-14.24	46.56	32.32	40.00	7.68	190	259.4	Vertical

Remark: Factor = Cable loss + Antenna factor - Preamplifier; Level = Reading + Factor; Margin = Limit - Level

Harmonics and Spurious Emissions

Frequency Range (9kHz-30MHz)

Frequency (MHz)	Level@3m (dBµV/m)	Limit@3m (dBµV/m)
--	--	--
--	--	--
--	--	--
--	--	--

- Note:** 1. Emission Level=Reading+ Cable loss-Antenna factor-Amp factor.
- 2. The emission levels are 20 dB below the limit value, which are not reported. It is deemed to comply with the requirement.



Above 1GHz

RADIATED EMISSION TEST

LOW CH1 (802.11b Mode)/2412

Horizontal:

Frequency (MHz)	Meter Reading (dBμV)	Factor (dB)	Emission Level (dBμV/m)	Limits (dBμV/m)	Margin (dB)	Detector Type
4824	50.79	-3.64	47.15	74	-26.85	peak
4824	34.75	-3.64	31.11	54	-22.89	AVG
7236	51.44	-0.95	50.49	74	-23.51	peak
7236	30.94	-0.95	29.99	54	-24.01	AVG

Remark: Factor = Antenna Factor + Cable Loss – Pre-amplifier.

Vertical:

Frequency (MHz)	Meter Reading (dBμV)	Factor (dB)	Emission Level (dBμV/m)	Limits (dBμV/m)	Margin (dB)	Detector Type
4824	51.89	-3.64	48.25	74	-25.75	peak
4824	33.25	-3.64	29.61	54	-24.39	AVG
7236	50.48	-0.95	49.53	74	-24.47	peak
7236	29.16	-0.95	28.21	54	-25.79	AVG

Remark: Factor = Antenna Factor + Cable Loss – Pre-amplifier.



MID CH6 (802.11b Mode)/2437

Horizontal:

Frequency	Meter Reading	Factor	Emission Level	Limits	Margin	Detector Type
(MHz)	(dBμV)	(dB)	(dBμV/m)	(dBμV/m)	(dB)	
4874	52.03	-3.51	48.52	74	-25.48	peak
4874	34.64	-3.51	31.13	54	-22.87	AVG
7311	52.51	-0.82	51.69	74	-22.31	peak
7311	31.14	-0.82	30.32	54	-23.68	AVG

Remark: Factor = Antenna Factor + Cable Loss – Pre-amplifier.

Vertical:

Frequency	Meter Reading	Factor	Emission Level	Limits	Margin	Detector Type
(MHz)	(dBμV)	(dB)	(dBμV/m)	(dBμV/m)	(dB)	
4874	52.05	-3.51	48.54	74	-25.46	peak
4874	34.48	-3.51	30.97	54	-23.03	AVG
7311	51.16	-0.82	50.34	74	-23.66	peak
7311	31.60	-0.82	30.78	54	-23.22	AVG

Remark: Factor = Antenna Factor + Cable Loss – Pre-amplifier.



HIGH CH11 (802.11b Mode)/2462

Horizontal:

Frequency (MHz)	Meter Reading (dBμV)	Factor (dB)	Emission Level (dBμV/m)	Limits (dBμV/m)	Margin (dB)	Detector Type
4924	53.12	-3.43	49.69	74	-24.31	peak
4924	32.1	-3.43	28.67	54	-25.33	AVG
7386	50.62	-0.75	49.87	74	-24.13	peak
7386	31.55	-0.75	30.8	54	-23.2	AVG

Remark: Factor = Antenna Factor + Cable Loss – Pre-amplifier.

Vertical:

Frequency (MHz)	Meter Reading (dBμV)	Factor (dB)	Emission Level (dBμV/m)	Limits (dBμV/m)	Margin (dB)	Detector Type
4924	51.1	-3.43	47.67	74	-26.33	peak
4924	34.17	-3.43	30.74	54	-23.26	AVG
7386	51.36	-0.75	50.61	74	-23.39	peak
7386	31.14	-0.75	30.39	54	-23.61	AVG

Remark: Factor = Antenna Factor + Cable Loss – Pre-amplifier.

Remark:

- (1) Measuring frequencies from 1 GHz to the 25 GHz.
- (2) "F" denotes fundamental frequency; "H" denotes spurious frequency; "E" denotes band edge frequency.
- (3) \* denotes emission frequency which appearing within the Restricted Bands specified in provision of 15.205, then the general radiated emission limits in 15.209 apply.
- (4) The emissions are attenuated more than 20dB below the permissible limits are not recorded in the report.
- (5) The IF bandwidth of EMI Test Receiver between 30MHz to 1GHz was 120KHz, 1 MHz for measuring above 1 GHz, below 30MHz was 10KHz.
- (6) When the test results of Peak Detected below the limits of Average Detected, the Average Detected is not need completed. For example: Top Channel at Fundamental 73.16dBuV/m(PK Value) <93.98(AV Limit), at harmonic 53.20 dBuV/m(PK Value) <54dBuV/m(AV Limit), the Average Detected not need to completed.



LOW CH1 (802.11g Mode)/2412

Horizontal:

Frequency	Meter Reading	Factor	Emission Level	Limits	Margin	Detector Type
(MHz)	(dBμV)	(dB)	(dBμV/m)	(dBμV/m)	(dB)	
4824	53.32	-3.64	49.68	74	-24.32	peak
4824	33.24	-3.64	29.6	54	-24.4	AVG
7236	52.02	-0.95	51.07	74	-22.93	peak
7236	31.37	-0.95	30.42	54	-23.58	AVG

Remark: Factor = Antenna Factor + Cable Loss – Pre-amplifier.

Vertical:

Frequency	Meter Reading	Factor	Emission Level	Limits	Margin	Detector Type
(MHz)	(dBμV)	(dB)	(dBμV/m)	(dBμV/m)	(dB)	
4824	51.97	-3.64	48.33	74	-25.67	peak
4824	33.33	-3.64	29.69	54	-24.31	AVG
7236	52.21	-0.95	51.26	74	-22.74	peak
7236	30.19	-0.95	29.24	54	-24.76	AVG

Remark: Factor = Antenna Factor + Cable Loss – Pre-amplifier.



MID CH6 (802.11g Mode)/2437

Horizontal:

Frequency	Meter Reading	Factor	Emission Level	Limits	Margin	Detector Type
(MHz)	(dBμV)	(dB)	(dBμV/m)	(dBμV/m)	(dB)	
4874	51.12	-3.51	47.61	74	-26.39	peak
4874	33.4	-3.51	29.89	54	-24.11	AVG
7311	50.34	-0.82	49.52	74	-24.48	peak
7311	30.94	-0.82	30.12	54	-23.88	AVG

Remark: Factor = Antenna Factor + Cable Loss – Pre-amplifier.

Vertical:

Frequency	Meter Reading	Factor	Emission Level	Limits	Margin	Detector Type
(MHz)	(dBμV)	(dB)	(dBμV/m)	(dBμV/m)	(dB)	
4874	52.6	-3.51	49.09	74	-24.91	peak
4874	33.48	-3.51	29.97	54	-24.03	AVG
7311	50.69	-0.82	49.87	74	-24.13	peak
7311	30.8	-0.82	29.98	54	-24.02	AVG

Remark: Factor = Antenna Factor + Cable Loss – Pre-amplifier.





HIGH CH11 (802.11g Mode)/2462

Horizontal:

Frequency (MHz)	Meter Reading (dBμV)	Factor (dB)	Emission Level (dBμV/m)	Limits (dBμV/m)	Margin (dB)	Detector Type
4924	52.1	-3.43	48.67	74	-25.33	peak
4924	32.82	-3.43	29.39	54	-24.61	AVG
7386	51.19	-0.75	50.44	74	-23.56	peak
7386	29.26	-0.75	28.51	54	-25.49	AVG

Remark: Factor = Antenna Factor + Cable Loss – Pre-amplifier.

Vertical:

Frequency (MHz)	Meter Reading (dBμV)	Factor (dB)	Emission Level (dBμV/m)	Limits (dBμV/m)	Margin (dB)	Detector Type
4924	52.17	-3.43	48.74	74	-25.26	peak
4924	33.66	-3.43	30.23	54	-23.77	AVG
7386	50.15	-0.75	49.4	74	-24.6	peak
7386	30.11	-0.75	29.36	54	-24.64	AVG

Remark: Factor = Antenna Factor + Cable Loss – Pre-amplifier.

Remark:

- (1) Measuring frequencies from 1 GHz to the 25 GHz.
- (2) "F" denotes fundamental frequency; "H" denotes spurious frequency; "E" denotes band edge frequency.
- (3) \* denotes emission frequency which appearing within the Restricted Bands specified in provision of 15.205, then the general radiated emission limits in 15.209 apply.
- (4) The emissions are attenuated more than 20dB below the permissible limits are not recorded in the report.
- (5) The IF bandwidth of EMI Test Receiver between 30MHz to 1GHz was 120KHz, 1 MHz for measuring above 1 GHz, below 30MHz was 10KHz.
- (6) When the test results of Peak Detected below the limits of Average Detected, the Average Detected is not need completed. For example: Top Channel at Fundamental 73.16dBuV/m(PK Value) <93.98(AV Limit), at harmonic 53.20 dBuV/m(PK Value) <54dBuV/m(AV Limit), the Average Detected not need to completed.



LOW CH1 (802.11n/H20 Mode)/2412

Horizontal:

Frequency	Meter Reading	Factor	Emission Level	Limits	Margin	Detector Type
(MHz)	(dBμV)	(dB)	(dBμV/m)	(dBμV/m)	(dB)	
4824	50.81	-3.64	47.17	74	-26.83	peak
4824	34.66	-3.64	31.02	54	-22.98	AVG
7236	51.82	-0.95	50.87	74	-23.13	peak
7236	31.53	-0.95	30.58	54	-23.42	AVG

Remark: Factor = Antenna Factor + Cable Loss – Pre-amplifier.

Vertical:

Frequency	Meter Reading	Factor	Emission Level	Limits	Margin	Detector Type
(MHz)	(dBμV)	(dB)	(dBμV/m)	(dBμV/m)	(dB)	
4824	52.74	-3.64	49.1	74	-24.9	peak
4824	33.81	-3.64	30.17	54	-23.83	AVG
7236	51.25	-0.95	50.3	74	-23.7	peak
7236	29.5	-0.95	28.55	54	-25.45	AVG

Remark: Factor = Antenna Factor + Cable Loss – Pre-amplifier.



MID CH6 (802.11n/H20 Mode)/2437

Horizontal:

Frequency	Meter Reading	Factor	Emission Level	Limits	Margin	Detector Type
(MHz)	(dBµV)	(dB)	(dBµV/m)	(dBµV/m)	(dB)	
4874.00	53.32	-3.51	49.81	74.00	-24.19	peak
4874.00	32.52	-3.51	29.01	54.00	-24.99	AVG
7311.00	52.40	-0.82	51.58	74.00	-22.42	peak
7311.00	30.62	-0.82	29.80	54.00	-24.20	AVG

Remark: Factor = Antenna Factor + Cable Loss – Pre-amplifier.

Vertical:

Frequency	Meter Reading	Factor	Emission Level	Limits	Margin	Detector Type
(MHz)	(dBµV)	(dB)	(dBµV/m)	(dBµV/m)	(dB)	
4874.00	53.20	-3.51	49.69	74.00	-24.31	peak
4874.00	32.74	-3.51	29.23	54.00	-24.77	AVG
7311.00	50.17	-0.82	49.35	74.00	-24.65	peak
7311.00	31.41	-0.82	30.59	54.00	-23.41	AVG

Remark: Factor = Antenna Factor + Cable Loss – Pre-amplifier.



HIGH CH11 (802.11n/H20 Mode)/2462

Horizontal:

Frequency	Meter Reading	Factor	Emission Level	Limits	Margin	Detector Type
(MHz)	(dBμV)	(dB)	(dBμV/m)	(dBμV/m)	(dB)	
4924	51.72	-3.43	48.29	74	-25.71	peak
4924	33.71	-3.43	30.28	54	-23.72	AVG
7386	51.35	-0.75	50.6	74	-23.4	peak
7386	31.75	-0.75	31	54	-23	AVG

Remark: Factor = Antenna Factor + Cable Loss – Pre-amplifier.

Vertical:

Frequency	Meter Reading	Factor	Emission Level	Limits	Margin	Detector Type
(MHz)	(dBμV)	(dB)	(dBμV/m)	(dBμV/m)	(dB)	
4924	51.13	-3.43	47.7	74	-26.3	peak
4924	34.47	-3.43	31.04	54	-22.96	AVG
7386	52.43	-0.75	51.68	74	-22.32	peak
7386	31.7	-0.75	30.95	54	-23.05	AVG

Remark: Factor = Antenna Factor + Cable Loss – Pre-amplifier.

Remark:

- (1) Measuring frequencies from 1 GHz to the 25 GHz.
- (2) "F" denotes fundamental frequency; "H" denotes spurious frequency; "E" denotes band edge frequency.
- (3) \* denotes emission frequency which appearing within the Restricted Bands specified in provision of 15.205, then the general radiated emission limits in 15.209 apply.
- (4) The emissions are attenuated more than 20dB below the permissible limits are not recorded in the report.
- (5) The IF bandwidth of EMI Test Receiver between 30MHz to 1GHz was 120KHz, 1 MHz for measuring above 1 GHz, below 30MHz was 10KHz.
- (6) When the test results of Peak Detected below the limits of Average Detected, the Average Detected is not need completed. For example: Top Channel at Fundamental 73.16dBuV/m(PK Value) <93.98(AV Limit), at harmonic 53.20 dBuV/m(PK Value) <54 dBuV/m(AV Limit), the Average Detected not need to completed.



LOW CH3 (802.11n/H40 Mode)/2422

Horizontal:

Frequency (MHz)	Meter Reading (dBμV)	Factor (dB)	Emission Level (dBμV/m)	Limits (dBμV/m)	Margin (dB)	Detector Type
4844	52.13	-3.63	48.5	74	-25.5	peak
4844	34.95	-3.63	31.32	54	-22.68	AVG
7266	50.73	-0.94	49.79	74	-24.21	peak
7266	29.42	-0.94	28.48	54	-25.52	AVG

Remark: Factor = Antenna Factor + Cable Loss – Pre-amplifier.

Vertical:

Frequency (MHz)	Meter Reading (dBμV)	Factor (dB)	Emission Level (dBμV/m)	Limits (dBμV/m)	Margin (dB)	Detector Type
4844	52.62	-3.63	48.99	74	-25.01	peak
4844	33.44	-3.63	29.81	54	-24.19	AVG
7266	50.98	-0.94	50.04	74	-23.96	peak
7266	31.66	-0.94	30.72	54	-23.28	AVG

Remark: Factor = Antenna Factor + Cable Loss – Pre-amplifier.



MID CH6 (802.11n/H40 Mode)/2437

Horizontal:

Frequency	Meter Reading	Factor	Emission Level	Limits	Margin	Detector Type
(MHz)	(dBμV)	(dB)	(dBμV/m)	(dBμV/m)	(dB)	
4874	51.59	-3.51	48.08	74	-25.92	peak
4874	32.12	-3.51	28.61	54	-25.39	AVG
7311	51.25	-0.82	50.43	74	-23.57	peak
7311	29.56	-0.82	28.74	54	-25.26	AVG

Remark: Factor = Antenna Factor + Cable Loss – Pre-amplifier.

Vertical:

Frequency	Meter Reading	Factor	Emission Level	Limits	Margin	Detector Type
(MHz)	(dBμV)	(dB)	(dBμV/m)	(dBμV/m)	(dB)	
4874	50.83	-3.51	47.32	74	-26.68	peak
4874	32.68	-3.51	29.17	54	-24.83	AVG
7311	50.61	-0.82	49.79	74	-24.21	peak
7311	31.72	-0.82	30.9	54	-23.1	AVG

Remark: Factor = Antenna Factor + Cable Loss – Pre-amplifier.



HIGH CH9 (802.11n/H40 Mode)/2452  
Horizontal:

Frequency	Meter Reading	Factor	Emission Level	Limits	Margin	Detector Type
(MHz)	(dBμV)	(dB)	(dBμV/m)	(dBμV/m)	(dB)	
4904	51.52	-3.43	48.09	74	-25.91	peak
4904	34.87	-3.43	31.44	54	-22.56	AVG
7356	52.05	-0.75	51.3	74	-22.7	peak
7356	29.12	-0.75	28.37	54	-25.63	AVG

Remark: Factor = Antenna Factor + Cable Loss – Pre-amplifier.

Vertical:

Frequency	Meter Reading	Factor	Emission Level	Limits	Margin	Detector Type
(MHz)	(dBμV)	(dB)	(dBμV/m)	(dBμV/m)	(dB)	
4904	50.99	-3.43	47.56	74	-26.44	peak
4904	34.3	-3.43	30.87	54	-23.13	AVG
7356	49.77	-0.75	49.02	74	-24.98	peak
7356	31.26	-0.75	30.51	54	-23.49	AVG

Remark: Factor = Antenna Factor + Cable Loss – Pre-amplifier.

Remark:

- (1) Measuring frequencies from 1 GHz to the 25 GHz.
- (2) "F" denotes fundamental frequency; "H" denotes spurious frequency; "E" denotes band edge frequency.
- (3) \* denotes emission frequency which appearing within the Restricted Bands specified in provision of 15.205, then the general radiated emission limits in 15.209 apply.
- (4) The emissions are attenuated more than 20dB below the permissible limits are not recorded in the report.
- (5) The IF bandwidth of EMI Test Receiver between 30MHz to 1GHz was 120KHz, 1 MHz for measuring above 1 GHz, below 30MHz was 10KHz.
- (6) When the test results of Peak Detected below the limits of Average Detected, the Average Detected is not need completed. For example: Top Channel at Fundamental 73.16dBuV/m(PK Value) <93.98(AV Limit), at harmonic 53.20 dBuV/m(PK Value) <54 dBuV/m(AV Limit), the Average Detected not need to completed.



Test Result of Radiated Spurious at Band edges

Operation Mode:
802.11b Mode TX CH Low (2412MHz)

Horizontal

Table with 7 columns: Frequency (MHz), Meter Reading (dBµV), Factor (dB), Emission Level (dBµV/m), Limits (dBµV/m), Margin (dB), and Detector Type. Rows include data for frequencies 2310, 2390, and 2400 MHz.

Remark: Factor = Antenna Factor + Cable Loss – Pre-amplifier.

Vertical:

Table with 7 columns: Frequency (MHz), Meter Reading (dBµV), Factor (dB), Emission Level (dBµV/m), Limits (dBµV/m), Margin (dB), and Detector Type. Rows include data for frequencies 2310, 2390, and 2400 MHz.

Remark: Factor = Antenna Factor + Cable Loss – Pre-amplifier.





Operation Mode: TX CH High (2462MHz)

Horizontal

Frequency	Meter Reading	Factor	Emission Level	Limits	Margin	Detector Type
(MHz)	(dBµV)	(dB)	(dBµV/m)	(dBµV/m)	(dB)	
2483.50	54.21	-5.65	48.56	74	-25.44	peak
2483.50	/	-5.65	/	54	/	AVG
2500.00	55.28	-5.65	49.63	74	-24.37	peak
2500.00	/	-5.65	/	54	/	AVG

Remark: Factor = Antenna Factor + Cable Loss – Pre-amplifier.

Vertical:

Frequency	Meter Reading	Factor	Emission Level	Limits	Margin	Detector Type
(MHz)	(dBµV)	(dB)	(dBµV/m)	(dBµV/m)	(dB)	
2483.50	54.02	-5.65	48.37	74	-25.63	peak
2483.50	/	-5.65	/	54	/	AVG
2500.00	53.49	-5.65	47.84	74	-26.16	peak
2500.00	/	-5.65	/	54	/	AVG

Remark: Factor = Antenna Factor + Cable Loss – Pre-amplifier.

Remark: All the other emissions not reported were too low to read and deemed to comply with FCC limit.



Operation Mode: 802.11g Mode TX CH Low (2412MHz)

Horizontal

Frequency (MHz)	Meter Reading (dBμV)	Factor (dB)	Emission Level (dBμV/m)	Limits (dBμV/m)	Margin (dB)	Detector Type
2310	54.87	-5.81	49.06	74	-24.94	peak
2310	/	-5.81	/	54	/	AVG
2390	53.16	-5.84	47.32	74	-26.68	peak
2390	/	-5.84	/	54	/	AVG
2400	52.66	-5.84	46.82	74	-27.18	peak
2400	/	-5.84	/	54	/	AVG

Remark: Factor = Antenna Factor + Cable Loss – Pre-amplifier.

Vertical:

Frequency (MHz)	Meter Reading (dBμV)	Factor (dB)	Emission Level (dBμV/m)	Limits (dBμV/m)	Margin (dB)	Detector Type
2310	54.01	-5.81	48.2	74	-25.8	peak
2310	/	-5.81	/	54	/	AVG
2390	54.98	-5.84	49.14	74	-24.86	peak
2390	/	-5.84	/	54	/	AVG
2400	56.72	-5.84	50.88	74	-23.12	peak
2400	/	-5.84	/	54	/	AVG

Remark: Factor = Antenna Factor + Cable Loss – Pre-amplifier.



Operation Mode: TX CH High (2462MHz)

Horizontal

Frequency	Meter Reading	Factor	Emission Level	Limits	Margin	Detector Type
(MHz)	(dBµV)	(dB)	(dBµV/m)	(dBµV/m)	(dB)	
2483.50	53.14	-5.65	47.49	74	-26.51	peak
2483.50	/	-5.65	/	54	/	AVG
2500.00	55.66	-5.65	50.01	74	-23.99	peak
2500.00	/	-5.65	/	54	/	AVG

Remark: Factor = Antenna Factor + Cable Loss – Pre-amplifier.

Vertical:

Frequency	Meter Reading	Factor	Emission Level	Limits	Margin	Detector Type
(MHz)	(dBµV)	(dB)	(dBµV/m)	(dBµV/m)	(dB)	
2483.50	53.14	-5.65	47.49	74	-26.51	peak
2483.50	/	-5.65	/	54	/	AVG
2500.00	54.76	-5.65	49.11	74	-24.89	peak
2500.00	/	-5.65	/	54	/	AVG

Remark: Factor = Antenna Factor + Cable Loss – Pre-amplifier.

Remark: All the other emissions not reported were too low to read and deemed to comply with FCC limit.



Operation Mode: 802.11n/H20 Mode TX CH Low (2412MHz)

Horizontal

Frequency (MHz)	Meter Reading (dBµV)	Factor (dB)	Emission Level (dBµV/m)	Limits (dBµV/m)	Margin (dB)	Detector Type
2310	53.49	-5.81	47.68	74	-26.32	peak
2310	/	-5.81	/	54	/	AVG
2390	56.12	-5.84	50.28	74	-23.72	peak
2390	/	-5.84	/	54	/	AVG
2400	55.87	-5.84	50.03	74	-23.97	peak
2400	/	-5.84	/	54	/	AVG

Remark: Factor = Antenna Factor + Cable Loss – Pre-amplifier.

Vertical:

Frequency (MHz)	Meter Reading (dBµV)	Factor (dB)	Emission Level (dBµV/m)	Limits (dBµV/m)	Margin (dB)	Detector Type
2310	54.02	-5.81	48.21	74	-25.79	peak
2310	/	-5.81	/	54	/	AVG
2390	55.23	-5.84	49.39	74	-24.61	peak
2390	/	-5.84	/	54	/	AVG
2400	54.21	-5.84	48.37	74	-25.63	peak
2400	/	-5.84	/	54	/	AVG

Remark: Factor = Antenna Factor + Cable Loss – Pre-amplifier.



Operation Mode: TX CH High (2462MHz)

Horizontal

Frequency	Meter Reading	Factor	Emission Level	Limits	Margin	Detector Type
(MHz)	(dBµV)	(dB)	(dBµV/m)	(dBµV/m)	(dB)	
2483.50	53.14	-5.65	47.49	74	-26.51	peak
2483.50	/	-5.65	/	54	/	AVG
2500.00	56.12	-5.65	50.47	74	-23.53	peak
2500.00	/	-5.65	/	54	/	AVG

Remark: Factor = Antenna Factor + Cable Loss – Pre-amplifier.

Vertical:

Frequency	Meter Reading	Factor	Emission Level	Limits	Margin	Detector Type
(MHz)	(dBµV)	(dB)	(dBµV/m)	(dBµV/m)	(dB)	
2483.50	56.34	-5.65	50.69	74	-23.31	peak
2483.50	/	-5.65	/	54	/	AVG
2500.00	55.28	-5.65	49.63	74	-24.37	peak
2500.00	/	-5.65	/	54	/	AVG

Remark: Factor = Antenna Factor + Cable Loss – Pre-amplifier.

Remark: All the other emissions not reported were too low to read and deemed to comply with FCC limit.



Operation Mode: 802.11n/H40 Mode TX CH Low (2422MHz)

Horizontal

Frequency (MHz)	Meter Reading (dBμV)	Factor (dB)	Emission Level (dBμV/m)	Limits (dBμV/m)	Margin (dB)	Detector Type
2310	53.49	-5.81	47.68	74	-26.32	peak
2310	/	-5.81	/	54	/	AVG
2390	56.47	-5.84	50.63	74	-23.37	peak
2390	/	-5.84	/	54	/	AVG
2400	53.61	-5.84	47.77	74	-26.23	peak
2400	/	-5.84	/	54	/	AVG

Remark: Factor = Antenna Factor + Cable Loss – Pre-amplifier.

Vertical:

Frequency (MHz)	Meter Reading (dBμV)	Factor (dB)	Emission Level (dBμV/m)	Limits (dBμV/m)	Margin (dB)	Detector Type
2310	53.11	-5.81	47.3	74	-26.7	peak
2310	/	-5.81	/	54	/	AVG
2390	53.64	-5.84	47.8	74	-26.2	peak
2390	/	-5.84	/	54	/	AVG
2400	55.74	-5.84	49.9	74	-24.1	peak
2400	/	-5.84	/	54	/	AVG

Remark: Factor = Antenna Factor + Cable Loss – Pre-amplifier.



Operation Mode: TX CH High (2452MHz)

Horizontal

Frequency	Meter Reading	Factor	Emission Level	Limits	Margin	Detector Type
(MHz)	(dBµV)	(dB)	(dBµV/m)	(dBµV/m)	(dB)	
2483.50	56.12	-5.65	50.47	74	-23.53	peak
2483.50	/	-5.65	/	54	/	AVG
2500.00	55.02	-5.65	49.37	74	-24.63	peak
2500.00	/	-5.65	/	54	/	AVG

Remark: Factor = Antenna Factor + Cable Loss – Pre-amplifier.

Vertical:

Frequency	Meter Reading	Factor	Emission Level	Limits	Margin	Detector Type
(MHz)	(dBµV)	(dB)	(dBµV/m)	(dBµV/m)	(dB)	
2483.50	55.02	-5.65	49.37	74	-24.63	peak
2483.50	/	-5.65	/	54	/	AVG
2500.00	54.69	-5.65	49.04	74	-24.96	peak
2500.00	/	-5.65	/	54	/	AVG

Remark: Factor = Antenna Factor + Cable Loss – Pre-amplifier.

Remark: All the other emissions not reported were too low to read and deemed to comply with FCC limit.

## 4.8. ANTENNA REQUIREMENT

### Standard Applicable

For intentional device, according to FCC 47 CFR Section 15.203, an intentional radiator shall be designed to ensure that no antenna other than that furnished by the responsible party shall be used with the device. And according to FCC 47 CFR Section 15.247, if transmitting antennas of directional gain greater than 6dBi are used, the power shall be reduced by the amount in dB that the directional gain of the antenna exceeds 6dBi.

### Refer to statement below for compliance.

The manufacturer may design the unit so that the user can replace a broken antenna, but the use of a standard antenna jack or electrical connector is prohibited. Further, this requirement does not apply to intentional radiators that must be professionally installed.

### Antenna Connected Construction

The antenna used in this product is a Internal Antenna, need professional installation. It conforms to the standard requirements. The directional gains of antenna used for transmitting is 3.53dBi.

### WIFI ANTENNA

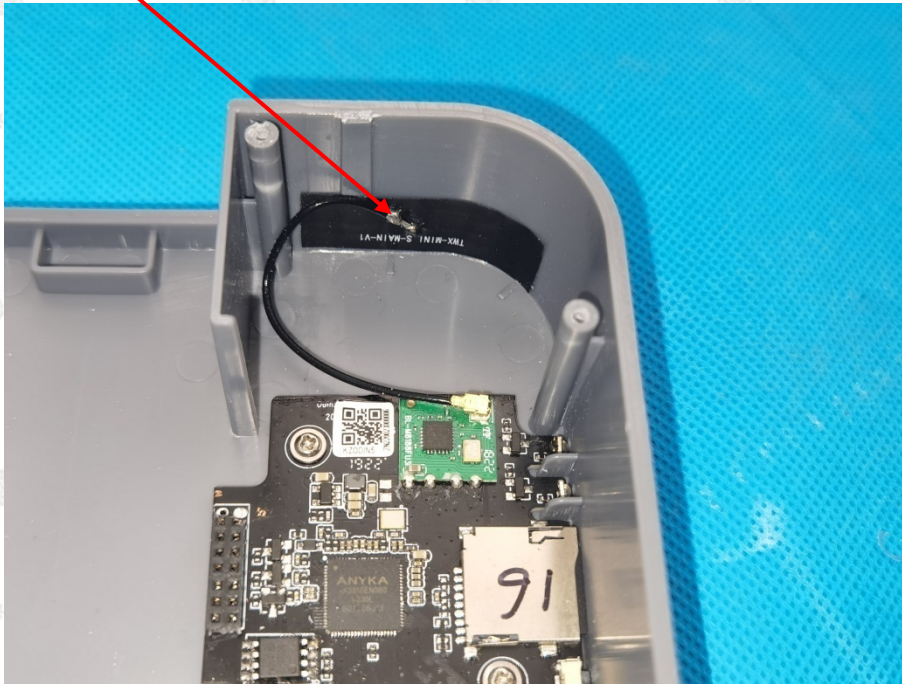





## 5. PHOTOGRAPH OF TEST

### Radiated Emissions

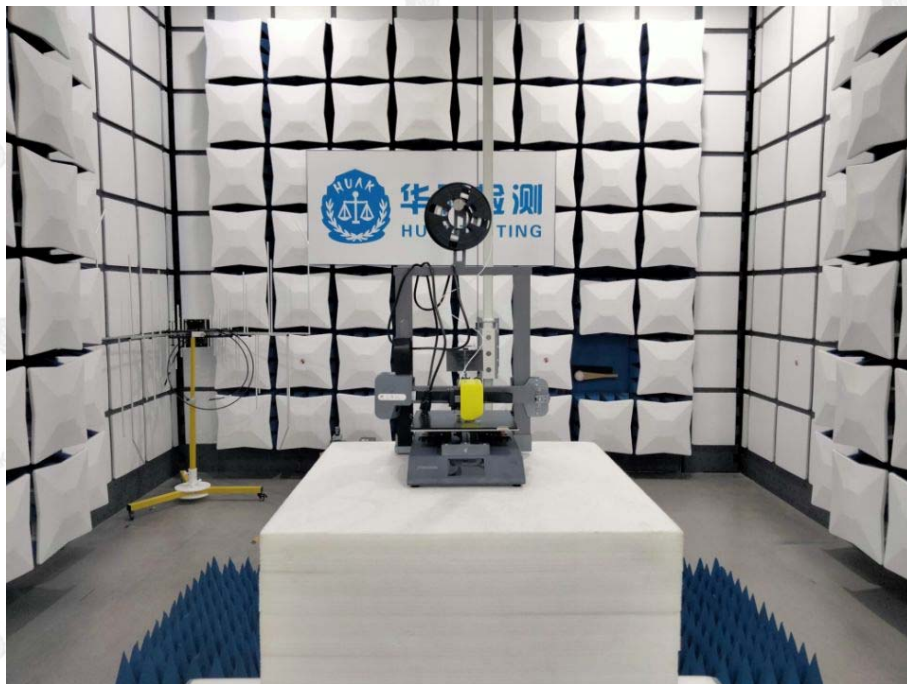
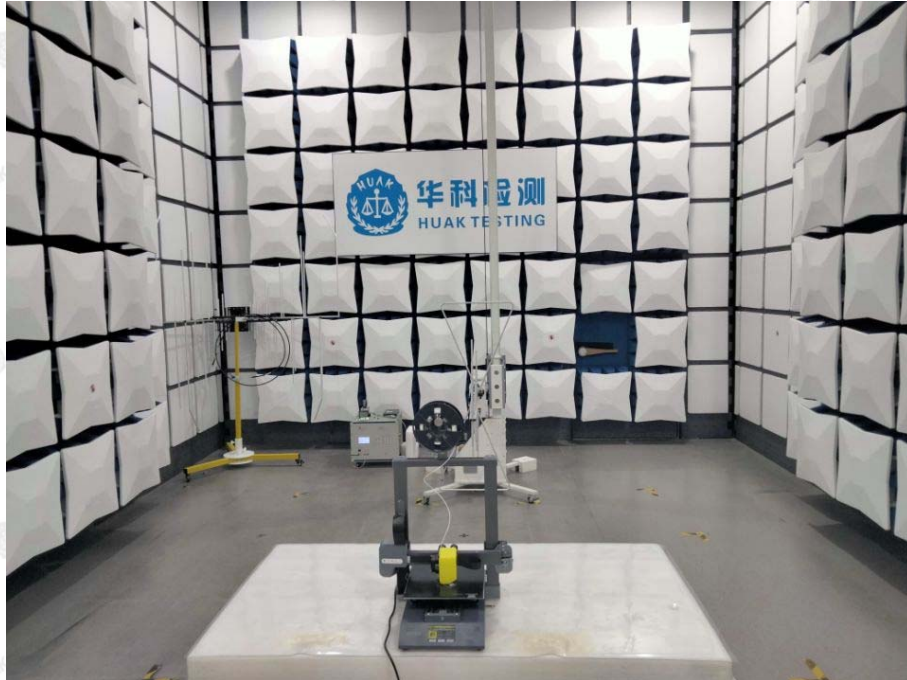

The results shown in this test report refer only to the sample(s) tested unless otherwise stated and the sample(s) are retained for 30 days only. The document is issued by HUAK, this document cannot be reproduced except in full with our prior written permission. The more details and the authenticity of the report will be confirmed at <http://www.cer-mark.com>.

TEL : +86-755 2302 9901 FAX : +86-755 2302 9901 E-mail : [service@cer-mark.com](mailto:service@cer-mark.com)

Add: 1-2F., Building B2, Junfeng Zhongcheng Zhizao Innovation Park, Heping Community, Fuhai Street, Bao'an District, Shenzhen, Guangdong, China



### Conducted Emission

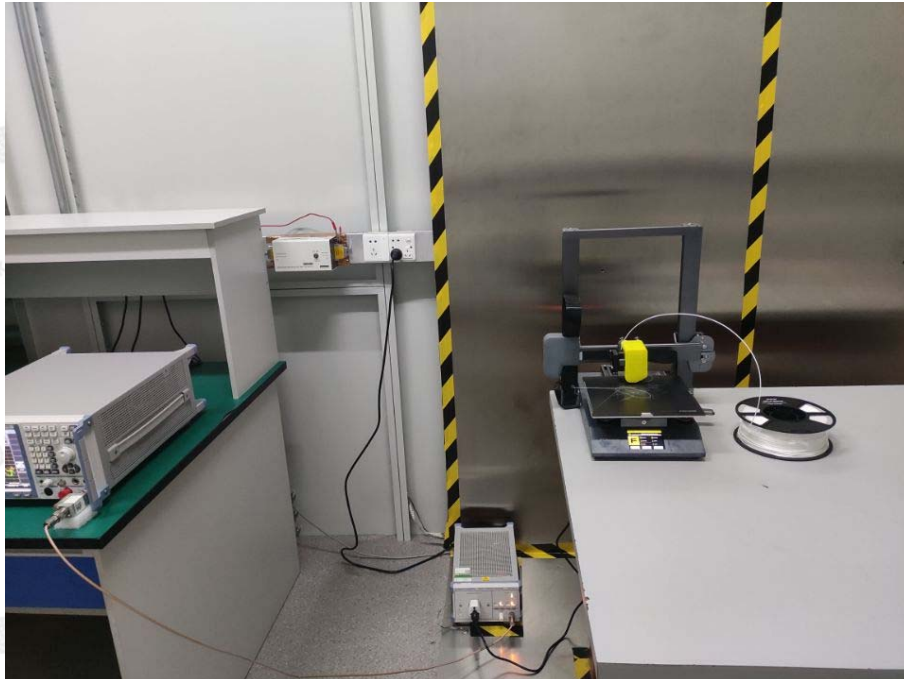

The results shown in this test report refer only to the sample(s) tested unless otherwise stated and the sample(s) are retained for 30 days only. The document is issued by HUAK, this document cannot be reproduced except in full with our prior written permission. The more details and the authenticity of the report will be confirmed at <http://www.cer-mark.com>.

TEL : +86-755 2302 9901 FAX : +86-755 2302 9901 E-mail : [service@cer-mark.com](mailto:service@cer-mark.com)

Addr: 1-2F., Building B2, Junfeng Zhongcheng Zhizao Innovation Park, Heping Community, Fuhai Street, Bao'an District, Shenzhen, Guangdong, China



## **6. PHOTOS OF THE EUT**

Reference to the report: ANNEX A of external photos and ANNEX B of internal photos.

-----End of test report-----

QUALIFICATION