

# AAN3216F0V01

## Applications

1. Bluetooth
2. Wireless LAN
3. ISMband 2.4GHz wireless applications
4. High stability and low tolerance.
5. Antenna Gain: 0dBi



### Evaluation Board Reference

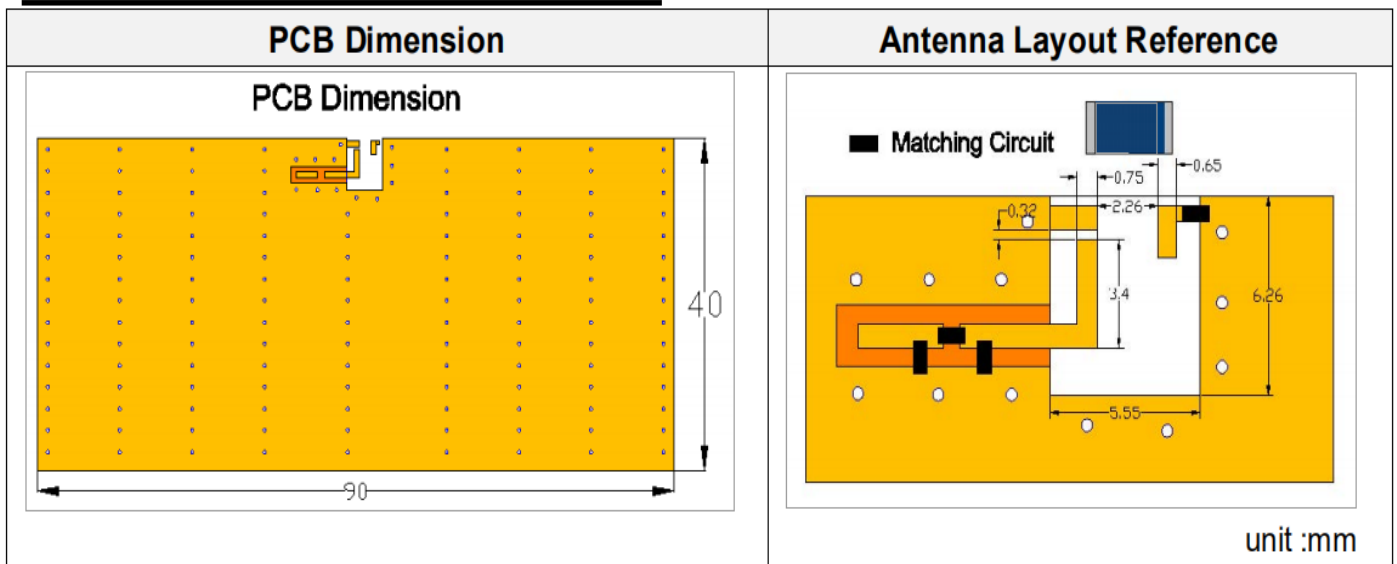

### Dimension and Terminal Configuration

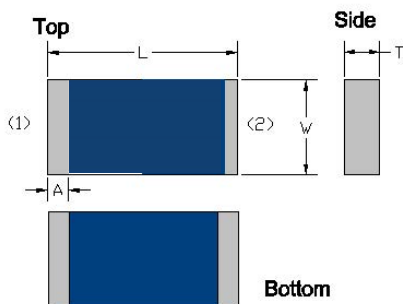

Dimension (mm)	
L	3.15 $\pm$ 0.15
W	1.55 $\pm$ 0.15
T	0.50 $\pm$ 0.10
A	0.35 $\pm$ 0.10

**Taping Specifications**

**Reel and Taping Specification**

**Reel Specification**

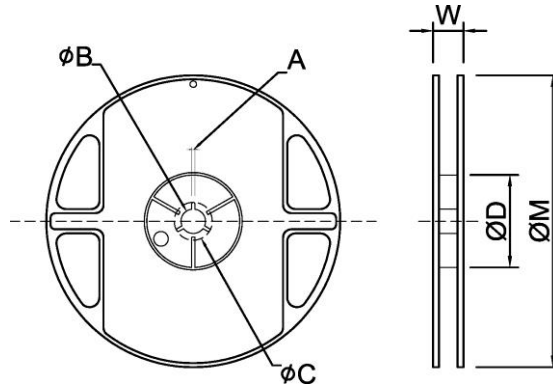

TYPE	SIZE		A	$\phi B$	$\phi C$	$\phi D$	W	$\phi M$
3216	7"	5K/Reel	2.0±0.5	13.5±1.0	21±1.0	60±1.0	11.5±2.0	178±2.0

**Taping Specification**

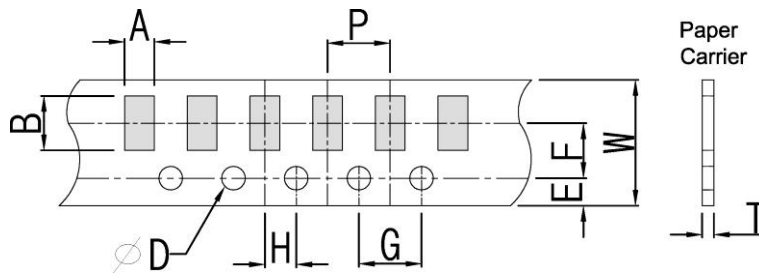

Packaging	Type	A	B	W	E	F	G	H	T	$\phi D$	P
Paper Type	3216	1.90±0.20	3.50±0.20	8.0±0.20	1.75±0.10	3.5±0.05	4.0±0.10	2.0±0.05	0.75±0.10	1.50 +0.10 -0	4.0±0.1

## Reliability Table

Test Item	Procedure	Requirements Ceramic Type	Remark (Reference)
<b>Electrical Characterization</b>		Fulfill the electrical specification	User Spec.
<b>Thermal Shock</b>	1. Preconditioning: $50 \pm 10^{\circ}\text{C}$ / 1 hr , then keep for $24 \pm 1$ hrs at room temp. 2. Initial measure: Spec: refer Initial spec. 3. Rapid change of temperature test: $-30^{\circ}\text{C}$ to $+85^{\circ}\text{C}$ ; 100 cycles; 15 minutes at Lower category temperature; 15 minutes at Upper category temperature.	No Visible Damage. Fulfill the electrical specification.	MIL-STD-202 107
<b>Temperature Cycling</b>	1. Initial measure: Spec: refer Initial spec. 2. 100 Cycles ( $-30^{\circ}\text{C}$ to $+85^{\circ}\text{C}$ ), Soak Mode=1 (2 Cycle/hours). 3. Measurement at $24 \pm 2$ Hours after test condition.	No Visible Damage. Fulfill the electrical specification.	JESD22 JA104
<b>High Temperature Exposure</b>	1. Initial measure: Spec: refer Initial spec. 2. Unpowered; 500hours @ $T=+85^{\circ}\text{C}$ . 3. Measurement at $24 \pm 2$ hours after test.	No Visible Damage. Fulfill the electrical specification.	MIL-STD-202 108
<b>Low Temperature Storage</b>	1. Initial measure: Spec: refer Initial spec. 2. Unpowered: 500hours @ $T= -30^{\circ}\text{C}$ . 3. Measurement at $24 \pm 2$ hours after test.	No Visible Damage. Fulfill the electrical specification.	MIL-STD-202 108
<b>Solderability (SMD Bottom Side)</b>	Dipping method: a. Temperature: $235 \pm 5^{\circ}\text{C}$ b. Dipping time: $3 \pm 0.5\text{s}$	The solder should cover over 95% of the critical area of bottom side.	IEC 60384-21/22 4.10
<b>Soldering Heat Resistance (RSH)</b>	Preheating temperature: $150 \pm 10^{\circ}\text{C}$ . Preheating time: 1~2 min. Solder temperature: $260 \pm 5^{\circ}\text{C}$ . Dipping time: $5 \pm 0.5\text{s}$	No Visible Damage.	IEC 60384-21/22 4.10
<b>Vibration</b>	5g's for 20 min., 12 cycles each of 3 orientations Note: Use 8"X5" PCB .031" thick 7 secure points on, one long side and 2 secure points at corners of opposite sides. Parts mounted within 2" from any secure point. Test from 10-2000 Hz.	No Visible Damage.	MIL-STD-202 Method 204
<b>Mechanical Shock</b>	Three shocks in each direction shall be applied along the three mutually perpendicular axes of the test specimen (18 shocks) Peak value: 1,500g's Duration: 0.5ms Velocity change: 15.4 ft/s Waveform: Half-sine	No Visible Damage.	MIL-STD-202 Method 213
<b>Humidity Bias</b>	1. Humidity: 85% R.H., Temperature: $85 \pm 2^{\circ}\text{C}$ . 2. Time: $500 \pm 24$ hours. 3. Measurement at $24 \pm 2$ hrs after test condition.	No Visible Damage. Fulfill the electrical specification.	MIL-STD-202 Method 106

<p><b>Board Flex (SMD)</b></p>	<p>1. Mounting method: IR-Reflow. PCB Size (L:100 × W:40 × T:1.6mm) 2. Apply the load in direction of the arrow until bending reaches 2 mm.</p>	<p>No Visible Damage.</p>	<p>AEC-Q200 005</p>
<p><b>Adhesion</b></p>	<p>Force of 1.8Kg for 60 seconds.</p>	<p>No Visible Damage Magnification of 20X or greater may be employed for inspection of the mechanical integrity of the device body terminals and body/terminal junction.</p>	<p>AEC-Q200 006</p>
<p><b>Physical Dimension</b></p>	<p>Any applicable method using x10 magnification, micrometers, calipers, gauges, contour projectors, or other measuring equipment, capable of determining the actual specimen dimensions.</p>	<p>In accordance with specification.</p>	<p>JESD22 JB100</p>

**Electrical Characteristics**

### Return Loss & Radiation

Frequency (MHz)	S11 (dB)
2400	-11.0
2441	-20.2
2480	-10.6

Frequency (MHz)	S11 (dB)
2400	-11.0
2441	-20.2
2480	-10.6

---

#### Radiation

3D 增益模式 3D Gain Pattern (2400 MHz)

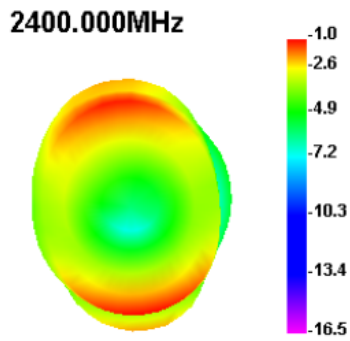

2D 增益模式 2D Gain Pattern (2400 MHz)

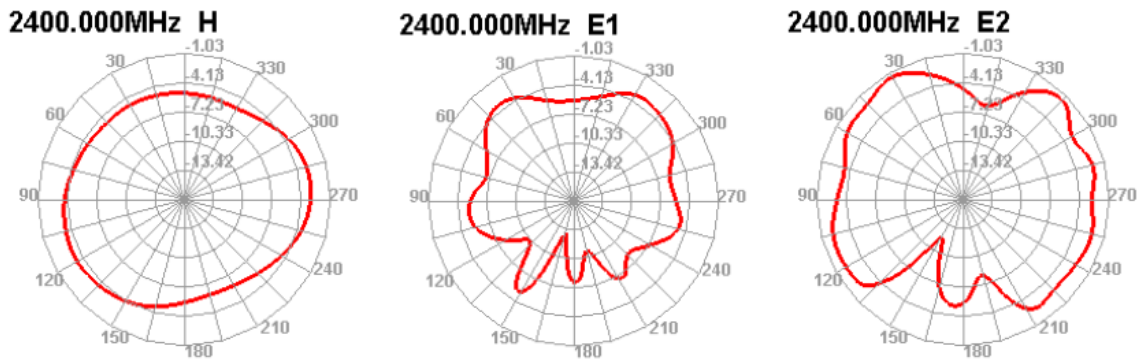

3D 增益模式 3D Gain Pattern (2450 MHz)

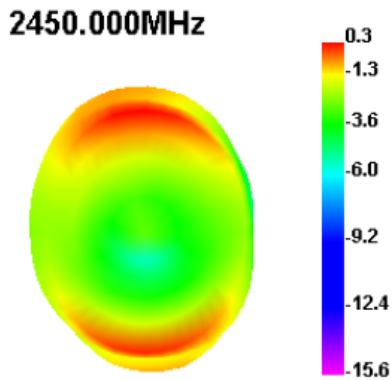

2D 增益模式 2D Gain Pattern (2450 MHz)

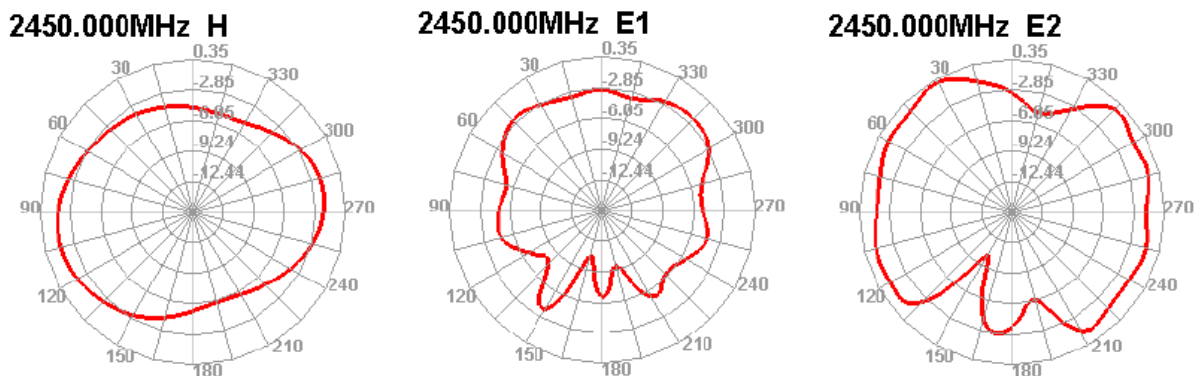

3D 增益模式 3D Gain Pattern (2500 MHz)

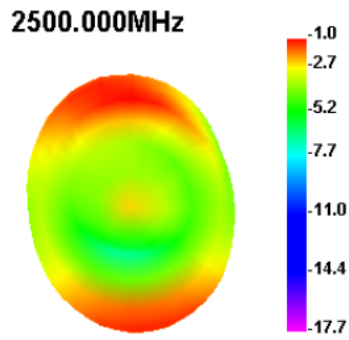

2D 增益模式 2D Gain Pattern (2500 MHz)

2500.000MHz H

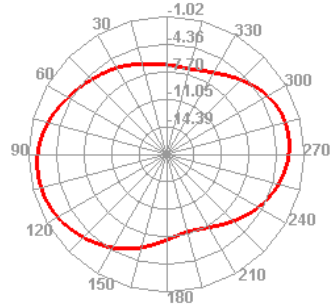

2500.000MHz E1

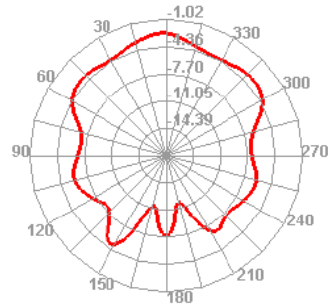

2500.000MHz E2

