

# Antenna Specifications

**Antenna gain: -2.79dBi max**

**Model Name:F0021**

**Antenna type:PCB Antenna**

**Frequency range:2.4GHZ-2.5GHZ**

**Manufacture:Shenzhen Warsong Technology Co., Ltd.**

**Address: D3.Tongfuyu Industrial Area , Street Community of Shajing Town,  
BaoAn,ShenZhen, China**

# 报告目录/Report Table of Contents

- ▶ 测试条件/Test conditions
- ▶ 天线&样机外观/Appearance of antenna and prototype
- ▶ 天线S参数/Antenna S parameters
- ▶ 天线无源效率/Antenna passive efficiency
- ▶ 天线辐射场型/Antenna radiation pattern

# 测试条件/Test conditions

测试项目 <small>Test items</small>	测试仪器 <small>instrument</small>	厂商 <small>manufacturer</small>
S参数 / <small>s-parameter</small>	E5062A	Agilent
无源效率 <small>Passive efficiency</small>	E5071C/RayZone 1800	Keysight/GTS

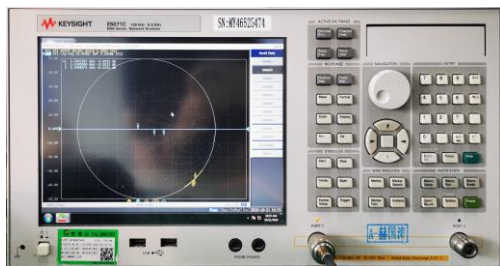

# 样机外观/Prototype appearance

天线位置/Antenna position

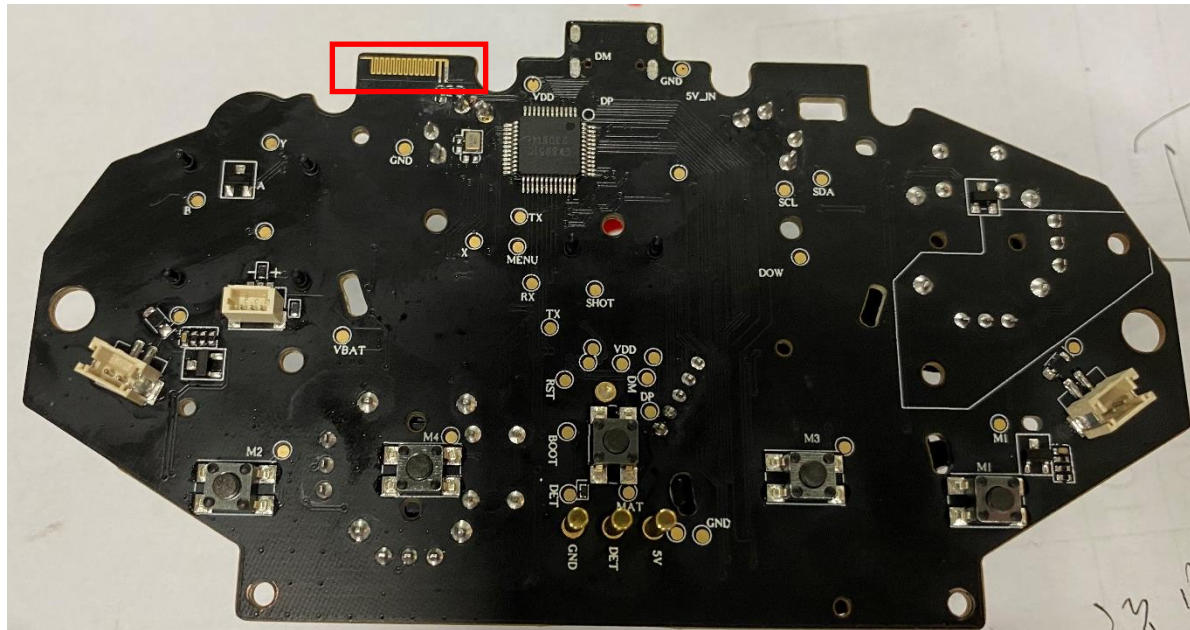

# 天线S参数 Antenna parameters

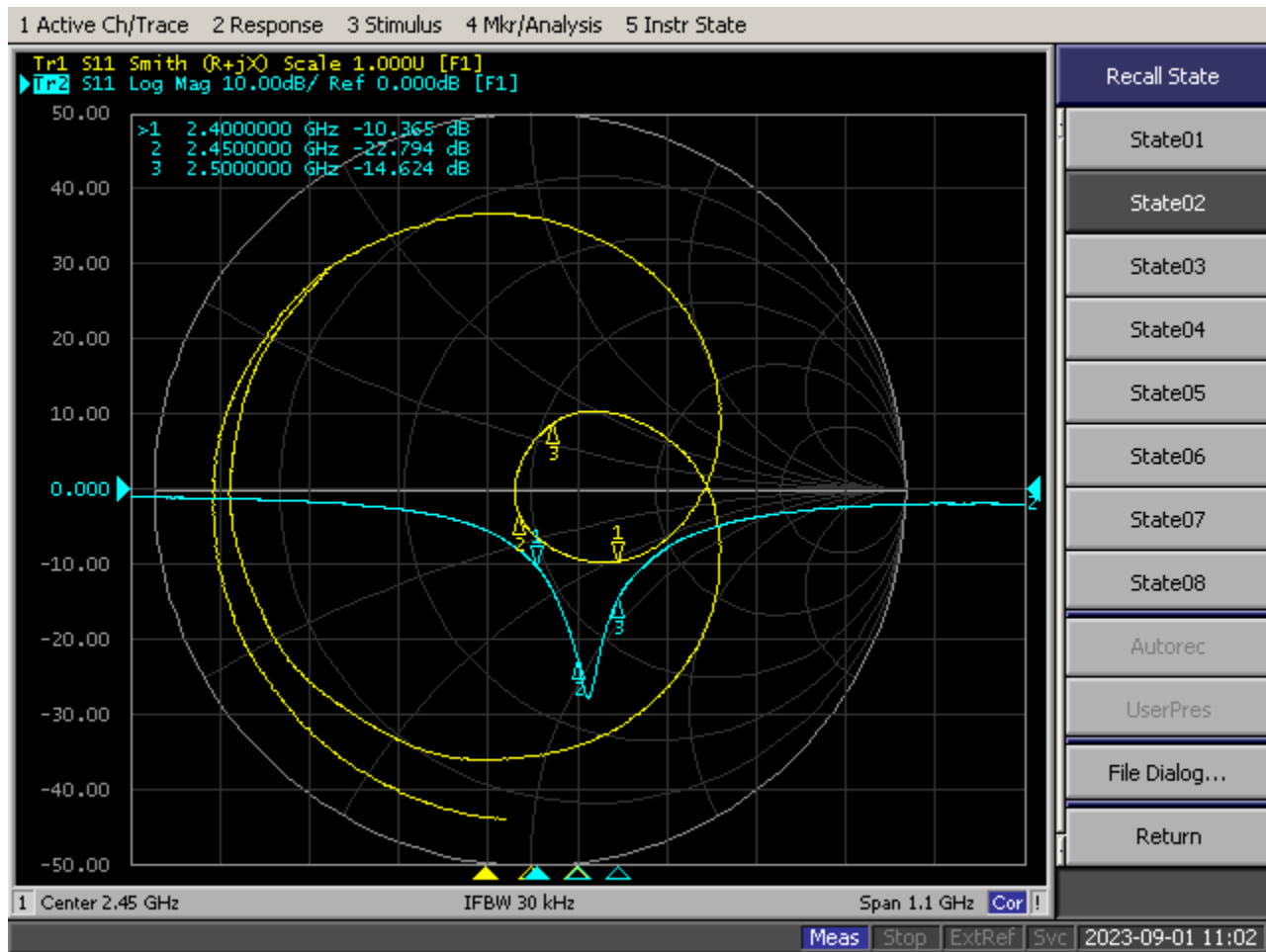

# 匹配参数/Matching parameters

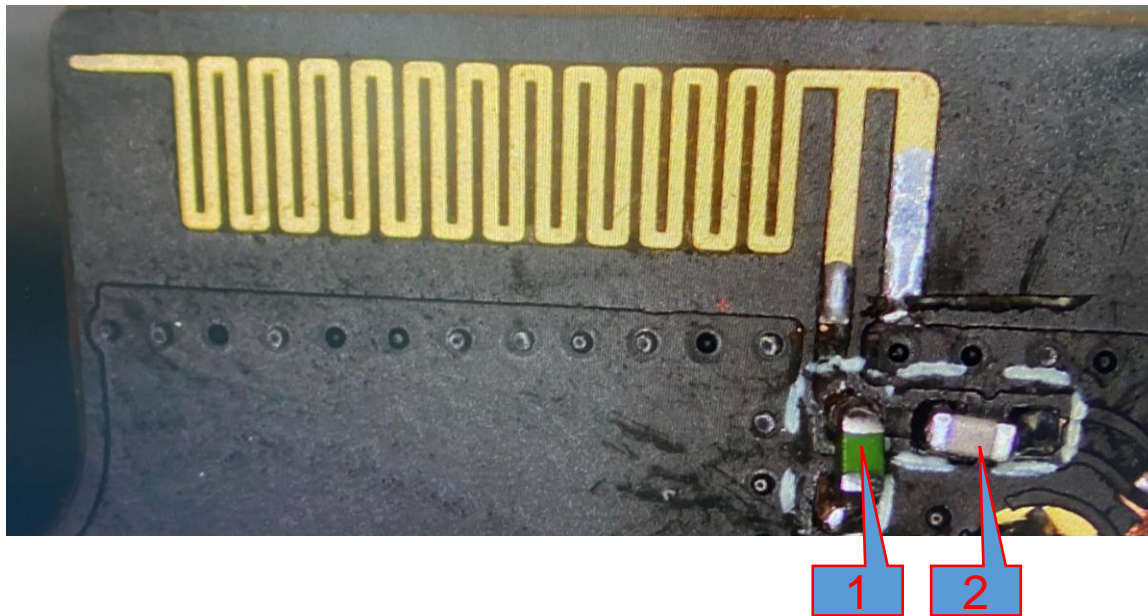

编号Number	规格Specifications	厂商Manufacturer	公差public errand	备注notes
1	L=6.8nH/0402	MURATA	±5%	
2	C=1.0pF/0402	MURATA	±0.1pF	

# 天线尺寸/Antenna size

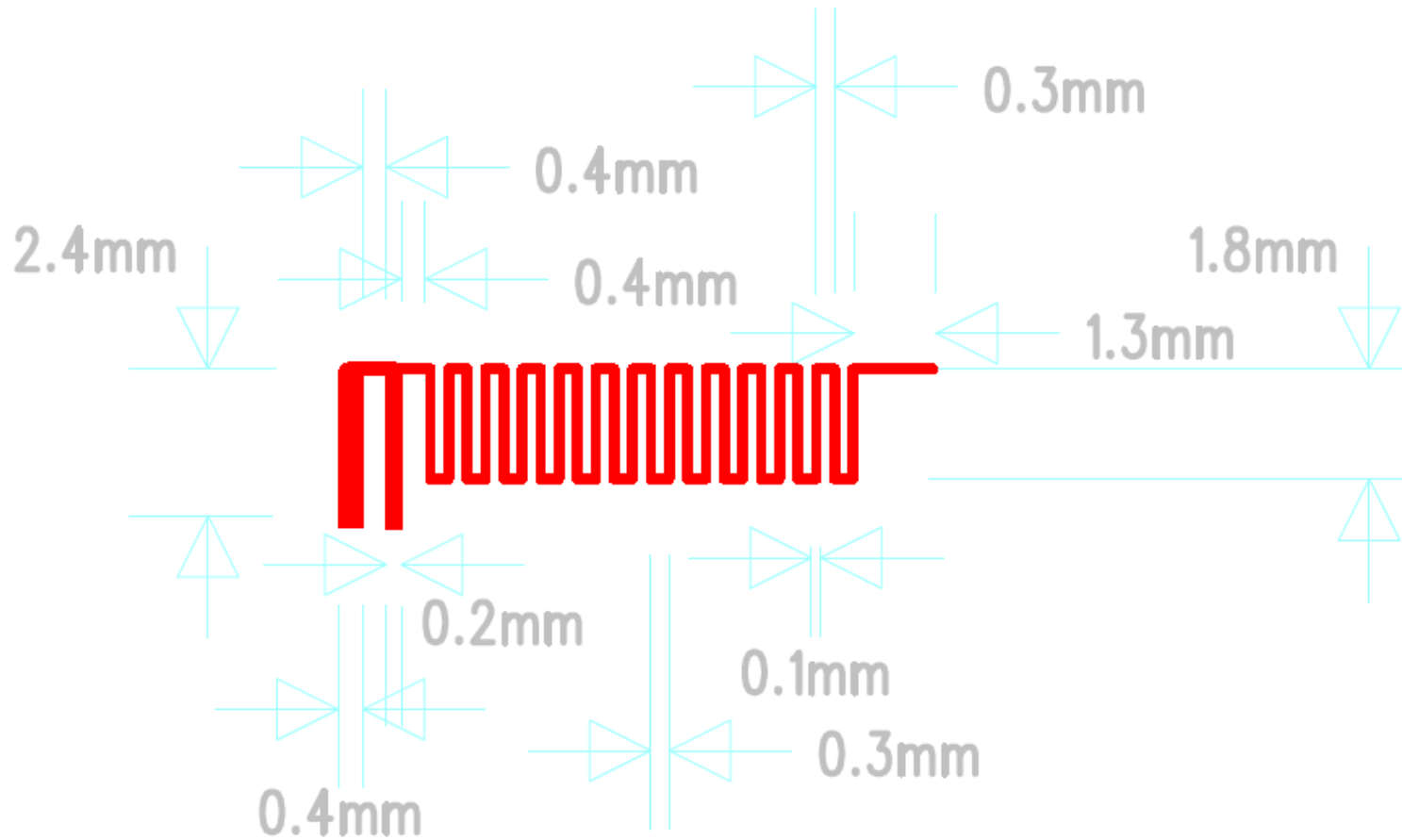

# 天线无源效率 / Antenna passive efficiency

Freq(MHz)	Gain(dB)	Efficiency(dB)	Efficiency(%)
2400	-3.45	-7.57	17.48
2410	-3.25	-7.49	17.81
2420	-3.13	-7.43	18.09
2430	-2.98	-7.31	18.59
2440	-2.85	-7.21	19.02
2450	-2.79	-7.16	19.22
2460	-2.79	-7.14	19.31
2470	-2.85	-7.17	19.20
2480	-2.92	-7.23	18.94
2490	-3.05	-7.31	18.56
2500	-3.12	-7.40	18.21



# 天线辐射场型 / Antenna radiation pattern

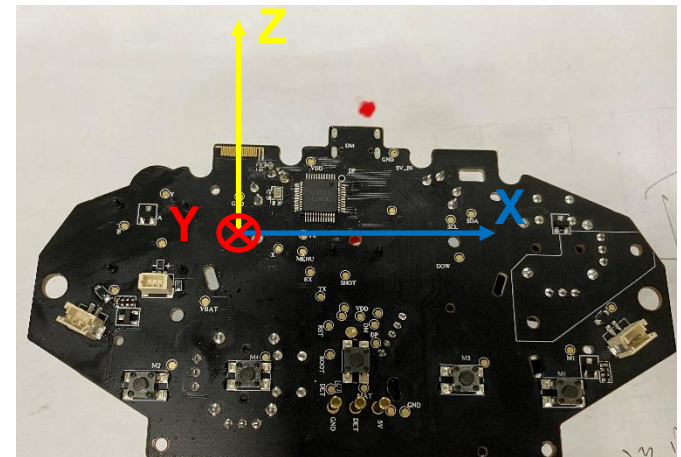
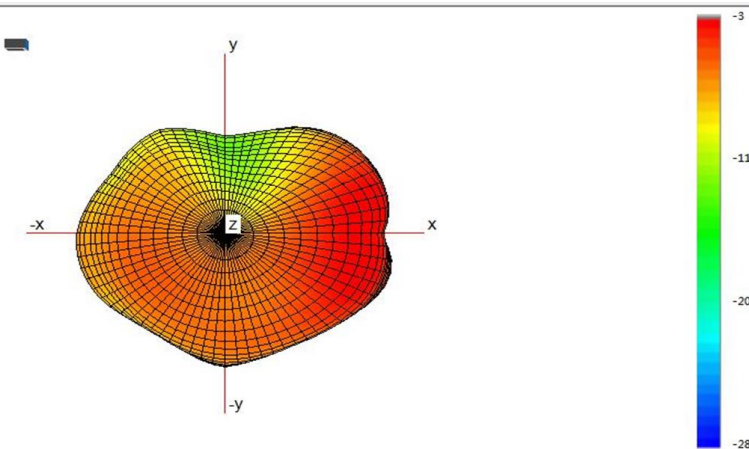
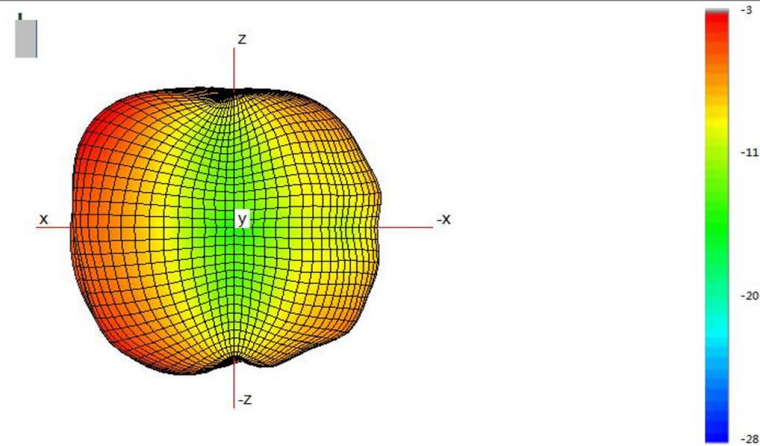
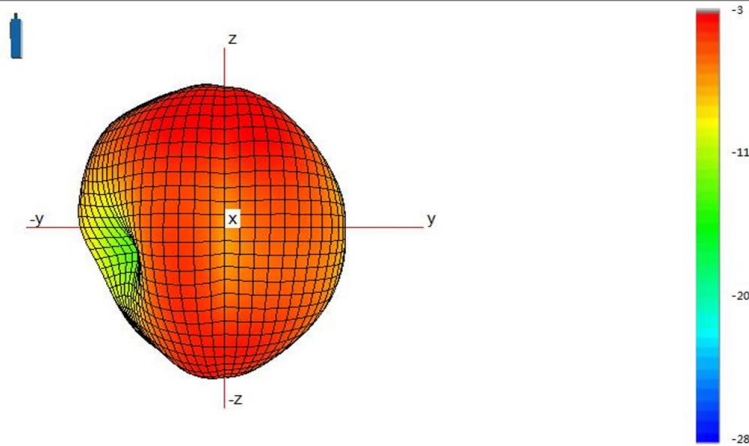

*Thanks for Your Attention*