

RF

TEST REPORT

ISSUED BY
Shenzhen BALUN Technology Co., Ltd.



FOR
Translation Pen

ISSUED TO
GUANGDONG GENIUS TECHNOLOGY CO., LTD.

No.168, Middle Road Of East Gate, Xiaobian Community, Chang'an
Town, Dongguan City, Guangdong, China



Tested by:

Ye Hongji

Date

Nov. 26, 2021

Approved by:

Mao Jianming
(Technical Director)

Date

Nov. 26, 2021

Report No.: BL-SZ21A0826-603

EUT Name: Translation Pen

Model Name: D21X3AO

Brand Name: imoo

Test Standard: 47 CFR Part 15 Subpart C
(refer section 3.1)

FCC ID: 2AYJFX3

Test Conclusion: Pass

Test Date: Nov. 03, 2021 ~ Nov. 11, 2021

Date of Issue: Nov. 26, 2021

NOTE: This test report of test results only related to testing samples, which can be duplicated completely for the legal use with the approval of the applicant; it shall not be reproduced except in full, without the written approval of Shenzhen BALUN Technology Co., Ltd. Any objections should be raised within thirty days from the date of issue. To validate the report, please contact us.

Revision History

<u>Version</u>	<u>Issue Date</u>	<u>Revisions Content</u>
<u>Rev. 01</u>	<u>Nov. 26, 2021</u>	<u>Initial Issue</u>

TABLE OF CONTENTS

1	ADMINISTRATIVE DATA (GENERAL INFORMATION)	5
1.1	Identification of the Testing Laboratory	5
1.2	Identification of the Responsible Testing Location	5
1.3	Laboratory Condition	5
1.4	Announce	5
2	PRODUCT INFORMATION.....	6
2.1	Applicant Information.....	6
2.2	Manufacturer Information	6
2.3	Factory Information	6
2.4	General Description for Equipment under Test (EUT)	6
2.5	Technical Information	7
2.6	Additional Instructions	9
3	SUMMARY OF TEST RESULTS.....	10
3.1	Test Standards	10
3.2	Verdict	10
4	GENERAL TEST CONFIGURATIONS.....	11
4.1	Test Environments	11
4.2	Test Equipment List.....	11
4.3	Measurement Uncertainty	11
4.4	Description of Test Setup	12
4.4.1	For Antenna Port Test.....	12
4.4.2	For AC Power Supply Port Test	12
4.4.3	For Radiated Test (Below 30 MHz)	13
4.4.4	For Radiated Test (30 MHz-1 GHz)	13
4.4.5	For Radiated Test (Above 1 GHz).....	14
4.5	Measurement Results Explanation Example.....	15

4.5.1	For conducted test items:	15
4.5.2	For radiated band edges and spurious emission test:.....	15
5	TEST ITEMS.....	16
5.1	Antenna Requirements.....	16
5.1.1	Relevant Standards.....	16
5.1.2	Antenna Anti-Replacement Construction	16
5.1.3	Antenna Gain	16
5.2	Output Power	17
5.2.1	Test Limit.....	17
5.2.2	Test Setup.....	17
5.2.3	Test Procedure.....	17
5.2.4	Test Result	18
5.3	6dB Bandwidth	19
5.3.1	Limit.....	19
5.3.2	Test Setup.....	19
5.3.3	Test Procedure.....	19
5.3.4	Test Result	19
5.4	Conducted Spurious Emission	20
5.4.1	Limit.....	20
5.4.2	Test Setup.....	20
5.4.3	Test Procedure.....	20
5.4.4	Test Result	21
5.5	Band Edge (Authorized-band band-edge).....	22
5.5.1	Limit.....	22
5.5.2	Test Setup.....	22
5.5.3	Test Procedure.....	22
5.5.4	Test Result	23
5.6	Conducted Emission	24
5.6.1	Limit.....	24
5.6.2	Test Setup.....	24
5.6.3	Test Procedure.....	24
5.6.4	Test Result	24

5.7	Radiated Spurious Emission	25
5.7.1	Limit.....	25
5.7.2	Test Setup	25
5.7.3	Test Procedure	25
5.7.4	Test Result	28
5.8	Band Edge (Restricted-band band-edge).....	29
5.8.1	Limit.....	29
5.8.2	Test Setup	29
5.8.3	Test Procedure	29
5.8.4	Test Result	29
5.9	Power Spectral density (PSD).....	30
5.9.1	Limit.....	30
5.9.2	Test Setup	30
5.9.3	Test Procedure	30
5.9.4	Test Result	30
ANNEX A	TEST RESULT	31
A.1	Output Power	31
A.2	Bandwidth.....	33
A.3	Conducted Spurious Emissions	38
A.4	Band Edge (Authorized-band band-edge).....	45
A.5	Conducted Emissions.....	48
A.6	Radiated Emission	50
A.7	Band Edge (Restricted-band band-edge).....	61
A.8	Power Spectral Density (PSD)	67
ANNEX B	TEST SETUP PHOTOS	70
ANNEX C	EUT EXTERNAL PHOTOS	70
ANNEX D	EUT INTERNAL PHOTOS	70

1 ADMINISTRATIVE DATA (GENERAL INFORMATION)

1.1 Identification of the Testing Laboratory

Company Name	Shenzhen BALUN Technology Co., Ltd.
Address	Block B, 1st FL, Baisha Science and Technology Park, Shahe Xi Road, Nanshan District, Shenzhen, Guangdong Province, P. R. China
Phone Number	+86 755 6685 0100

1.2 Identification of the Responsible Testing Location

Test Location	Shenzhen BALUN Technology Co., Ltd.
Address	Block B, 1st FL, Baisha Science and Technology Park, Shahe Xi Road, Nanshan District, Shenzhen, Guangdong Province, P. R. China
Accreditation Certificate	The laboratory is a testing organization accredited by FCC as a accredited testing laboratory. The designation number is CN1196.
Description	All measurement facilities used to collect the measurement data are located at Block B, FL 1, Baisha Science and Technology Park, Shahe Xi Road, Nanshan District, Shenzhen, Guangdong Province, P. R. China 518055

1.3 Laboratory Condition

Ambient Temperature	20°C to 25°C
Ambient Relative Humidity	45% to 55%
Ambient Pressure	100 kPa to 102 kPa

1.4 Announce

- (1) The test report reference to the report template version v6.6.
- (2) The test report is invalid if not marked with the signatures of the persons responsible for preparing and approving the test report.
- (3) The test report is invalid if there is any evidence and/or falsification.
- (4) The results documented in this report apply only to the tested sample, under the conditions and modes of operation as described herein.
- (5) This document may not be altered or revised in any way unless done so by BALUN and all revisions are duly noted in the revisions section.
- (6) Content of the test report, in part or in full, cannot be used for publicity and/or promotional purposes without prior written approval from the laboratory.
- (7) The laboratory is only responsible for the data released by the laboratory, except for the part provided by the applicant.

2 PRODUCT INFORMATION

2.1 Applicant Information

Applicant	GUANGDONG GENIUS TECHNOLOGY CO., LTD.
Address	No.168, Middle Road Of East Gate, Xiaobian Community, Chang'an Town, Dongguan City, Guangdong, China

2.2 Manufacturer Information

Manufacturer	GUANGDONG GENIUS TECHNOLOGY CO., LTD.
Address	No.168, Middle Road Of East Gate, Xiaobian Community, Chang'an Town, Dongguan City, Guangdong, China

2.3 Factory Information

Factory	GUANGDONG GENIUS TECHNOLOGY CO., LTD.
Address	No.168, Middle Road Of East Gate, Xiaobian Community, Chang'an Town, Dongguan City, Guangdong, China

2.4 General Description for Equipment under Test (EUT)

EUT Name	Translation Pen
Model Name Under Test	D21X3AO
Series Model Name	N/A
Description of Model Name Differentiation	N/A
Hardware Version	X3-M-1
Software Version	V1.0.0
Dimensions (Approx.)	N/A
Weight (Approx.)	N/A

2.5 Technical Information

Network and Wireless connectivity	Bluetooth (BR+EDR+BLE) WIFI 802.11b, 802.11g, 802.11n
-----------------------------------	--

The requirement for the following technical information of the EUT was tested in this report:

Frequency Range	802.11b/g/n(20 MHz): 2.412 GHz - 2.462 GHz $f_c = 2412 \text{ MHz} + (N-1) * 5 \text{ MHz}$, where - f_c = "Operating Frequency" in MHz, - N = "Channel Number" with the range from 1 to 11.
Modulation Type	DSSS, OFDM
Product Type	<input type="checkbox"/> Mobile <input checked="" type="checkbox"/> Portable <input type="checkbox"/> Fix Location
Antenna Type	FPC Antenna
Antenna Gain	-2.0 dBi (In test items related to antenna gain, the final results reflect this figure. This value is provided by the applicant.)
About the Product	Only the WIFI 802.11b, 802.11g and 802.11n (HT20) was tested in this report.

Modulation technology	Modulation Type	Transfer Rate (Mbps)
DSSS (802.11b)	DBPSK	1
	DQPSK	2
	CCK	5.5/11
OFDM (802.11g)	BPSK	6/9
	QPSK	12/18
	16QAM	24/36
	64QAM	48/54
OFDM (802.11n-20MHz)	BPSK	6.5/7.2
	QPSK	13/19.5/14.4/21.7
	16QAM	26/39/28.9/43.3
	64QAM	52/58.5/65/57.8/65/72.2

Note: Preliminary tests were performed in different data rate in above table to find the worst radiated emission. The data rate shown in the table below is the worst-case rate with respect to the specific test item. Investigation has been done on all the possible configurations for searching the worst cases. The following table is a list of the test modes shown in this test report.

Test Items	Mode	Data Rate	Channel
Output Power	11b/11g/11n20	1/6/6.5/13.5 Mbps	1/6/11
6dB Bandwidth	11b/11g/11n20	1/6/6.5/13.5 Mbps	1/6/11
Conducted Spurious Emission	11b/11g/11n20	1/6/6.5/13.5 Mbps	1/6/11
Conducted Emission	11b/11g/11n20	1/6/6.5/13.5 Mbps	1/6/11
Radiated Spurious Emission	11b/11g/11n20	1/6/6.5/13.5 Mbps	1/6/11
Band Edge	11b/11g/11n20	1/6/6.5/13.5 Mbps	1/6/11
Power spectral density (PSD)	11b/11g/11n20	1/6/6.5/13.5 Mbps	1/6/11

Note: The above EUT information in section 2.4 and 2.6 was declared by manufacturer and for more detailed features description, please refer to the manufacturer's specifications or user's manual.

2.6 Additional Instructions

EUT Software Settings:

Mode	<input checked="" type="checkbox"/> Special software is used. The software provided by client to enable the EUT under transmission condition continuously at specific channel frequencies individually.
------	--

During testing, Channel and Power Controlling Software provided by the customer was used to control the operating channel as well as the output power level. The RF output power selection is for the setting of RF output power expected by the customer and is going to be fixed on the firmware of the final end product.

Power level setup in software			
Test Software Version	CMD		
Support Units (Software installation media)	Description	Manufacturer	Model
		Notebook	HP
Mode	Channel	Soft Set	
802.11 b	1	16	
	6	16	
	11	16	
802.11 g	1	15	
	6	16	
	11	16	
802.11 n20	1	15	
	6	15	
	11	15	

Run software:

```

C:\Windows\System32\cmd.exe
wl up
wl scansuppress 1
wl phy_txpwrctrl 1
wl PM 0
wwl phy_forcecal 1
l txpwr1 -1
wl pkteng_start 00:11:22:33:44:55 tx 100 1024 0wl txpwr1 -o -d 15
wl up
wl PM 0
wl phy_forcecal 1
/# wl down
/# wl mpc 0
/# wl phy_watchdog 0
/# wl country ALL
/# wl band b
/# wl 2g_rate -h 0 -b 20
/# wl chanspec 11/20
Chanspec set to 0x100b
/# wl scansuppress 1
/# wl phy_txpwrctrl 1
wl: No clock
/# wl txpwr1 -1
/# wl txpwr1 -o -d 15
/# wl up
/# wl PM 0
/# wl phy_forcecal 1
/#
wl pkteng_start 00:11:22:33:44:55 tx 100 1024 0
/#
C:\Users\EDZ\Desktop\adb-1223>
    
```

3 SUMMARY OF TEST RESULTS

3.1 Test Standards

No.	Identity	Document Title
1	47 CFR Part 15, Subpart C	Miscellaneous Wireless Communications Services
2	KDB Publication 558074 D01v05r02	GUIDANCE FOR COMPLIANCE MEASUREMENTS ON DIGITAL TRANSMISSION SYSTEM, FREQUENCY HOPPING SPREAD SPECTRUM SYSTEM, AND HYBRID SYSTEM DEVICES OPERATING UNDER SECTION 15.247 OF THE FCC RULES
3	ANSI C63.10-2013	American National Standard of Procedures for Compliance Testing of Unlicensed Wireless Devices

3.2 Verdict

No.	Description	FCC PART No.	ISED Part No.	Test Result	Verdict
1	Antenna Requirement	15.203	RSS-247, 5.4 (f)	N/A	Pass ^{Note 1}
2	Output Power	15.247 (b)	RSS-247, 5.4 (d)	ANNEX A.1	Pass
3	6dB Bandwidth	15.247 (a)	RSS-GEN, 6.7; RSS-247, 5.2 (a)	ANNEX A.2	Pass
4	Conducted Spurious Emission	15.247 (d)	RSS-247, 5.5	ANNEX A.3	Pass
5	Band Edge(Authorized-band band-edge)	15.247 (d)	RSS-GEN, 8.9; RSS-247, 5.5	ANNEX A.4	Pass
6	Conducted Emission	15.207	RSS-GEN, 8.8	ANNEX A.5	Pass
7	Radiated Spurious Emission	15.209; 15.247 (d)	RSS-247, 5.5	ANNEX A.6	Pass
8	Band Edge(Restricted-band band-edge)	15.209; 15.247 (d)	RSS-247, 5.5	ANNEX A.7	Pass
9	Power spectral density (PSD)	15.247 (e)	RSS-247, 5.2 (b)	ANNEX A.8	Pass
10	Receiver Spurious Emissions	N/A	RSS-Gen, 7.3	N/A	N/A ^{Note 2}

Note 1: Please refer to section 5.1.

Note 2: Only radio communication receivers operating in stand-alone mode within the band 30-960 MHz, as well as scanner receivers, are subject to Industry Canada requirements, so this test is not applicable.

4 GENERAL TEST CONFIGURATIONS

4.1 Test Environments

During the measurement, the normal environmental conditions were within the listed ranges:

Relative Humidity	45% - 55%	
Atmospheric Pressure	100 kPa - 102 kPa	
Temperature	NT (Normal Temperature)	+22°C to +25°C
Working Voltage of the EUT	NV (Normal Voltage)	3.87 V

4.2 Test Equipment List

Description	Manufacturer	Model	Serial No.	Cal. Date	Cal. Due
Spectrum Analyzer	ROHDE&SCHWARZ	FSV-40	101544	2021.04.01	2022.03.31
Bluetooth Signaling Unit	ROHDE&SCHWARZ	CMW500	142028	2021.06.01	2022.05.31
EMI Receiver	KEYSIGHT	N9038A	MY53220118	2021.06.01	2022.05.31
EMI Receiver	ROHDE&SCHWARZ	ESRP	101036	2021.06.01	2022.05.31
LISN	SCHWARZBECK	NSLK 8127	8127-687	2021.06.01	2022.05.31
Test Antenna-Loop(9 kHz-30 MHz)	SCHWARZBECK	FMZB 1519	1519-037	2021.04.16	2024.04.15
Test Antenna-Bi-Log(30 MHz-3 GHz)	SCHWARZBECK	VULB 9163	9163-624	2021.08.20	2024.08.19
Test Antenna-Horn(1-18 GHz)	SCHWARZBECK	BBHA 9120D	9120D-1917	2019.07.02	2022.07.01
Test Antenna-Horn (18-40 GHz)	A-INFO	LB-180400KF	J211060273	2021.07.02	2023.07.01
Anechoic Chamber	RAINFORD	9m*6m*6m	N/A	2017.02.21	2022.02.20
Anechoic Chamber	EMC Electronic Co., Ltd	20.10*11.60*7.35m	N/A	2019.08.08	2022.08.07
Shielded Enclosure	ChangNing	CN-130701	130703	--	--

4.3 Measurement Uncertainty

The following measurement uncertainty levels have been estimated for tests performed on the EUT as specified in CISPR 16-4-2.

This uncertainty represents an expanded uncertainty expressed at approximately the 95% confidence level using a coverage factor of k=2.

Parameters	Uncertainty
Occupied Channel Bandwidth	2.8%
RF output power, conducted	1.28 dB
Power Spectral Density, conducted	1.30 dB
Unwanted Emissions, conducted	1.84 dB
All emissions, radiated	5.36 dB
Temperature	0.82°C
Humidity	4.1%

4.4 Description of Test Setup

4.4.1 For Antenna Port Test

Conducted value (dBm) = Measurement value (dBm) + cable loss (dB)

For example: the measurement value is 10 dBm and the cable 0.5dBm used, then the final result of EUT:

Conducted value (dBm) = 10 dBm + 0.5 dB = 10.5 dBm

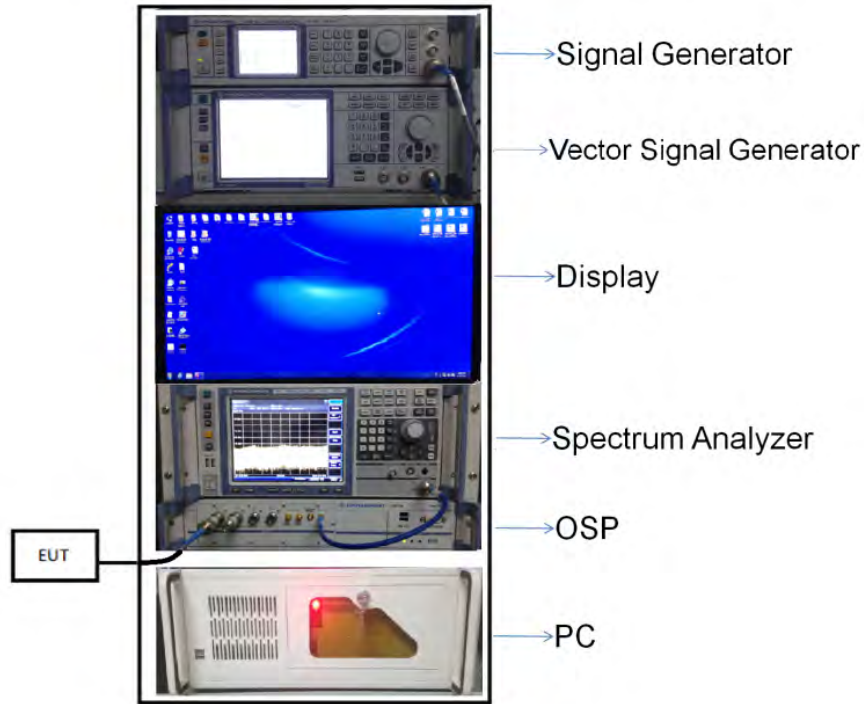

(Diagram 1)

4.4.2 For AC Power Supply Port Test

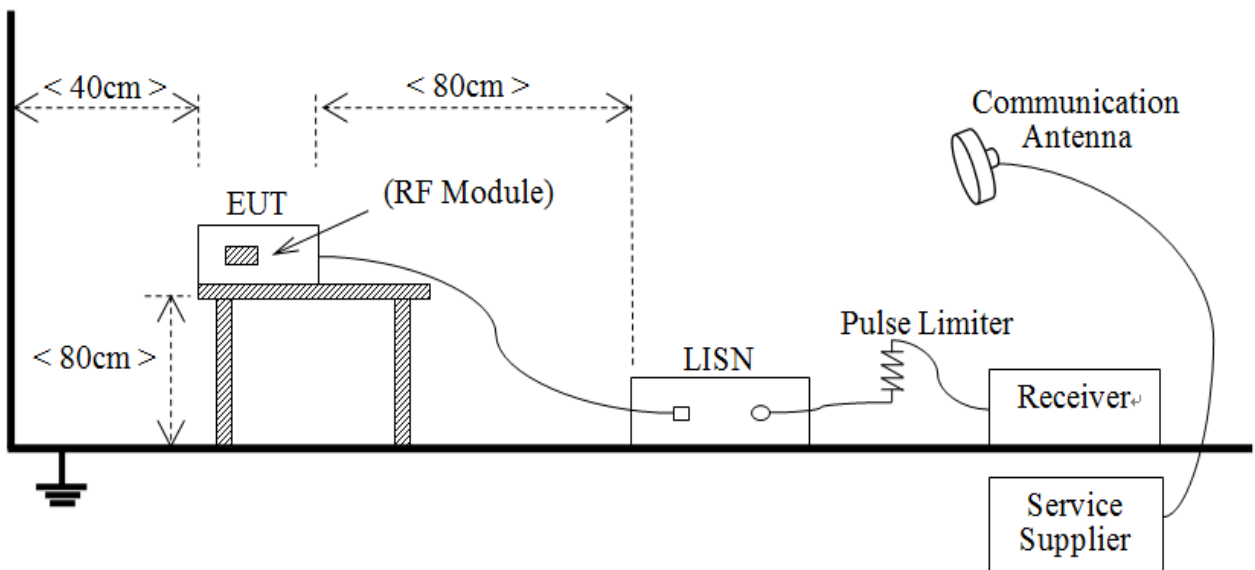

(Diagram 2)

4.4.3 For Radiated Test (Below 30 MHz)

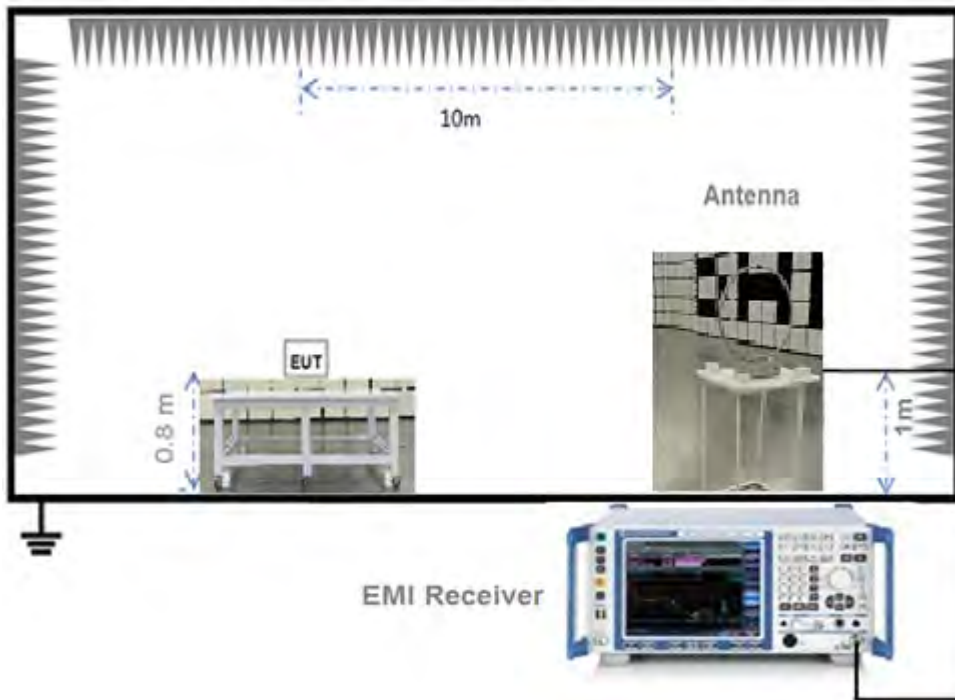

(Diagram 3)

4.4.4 For Radiated Test (30 MHz-1 GHz)

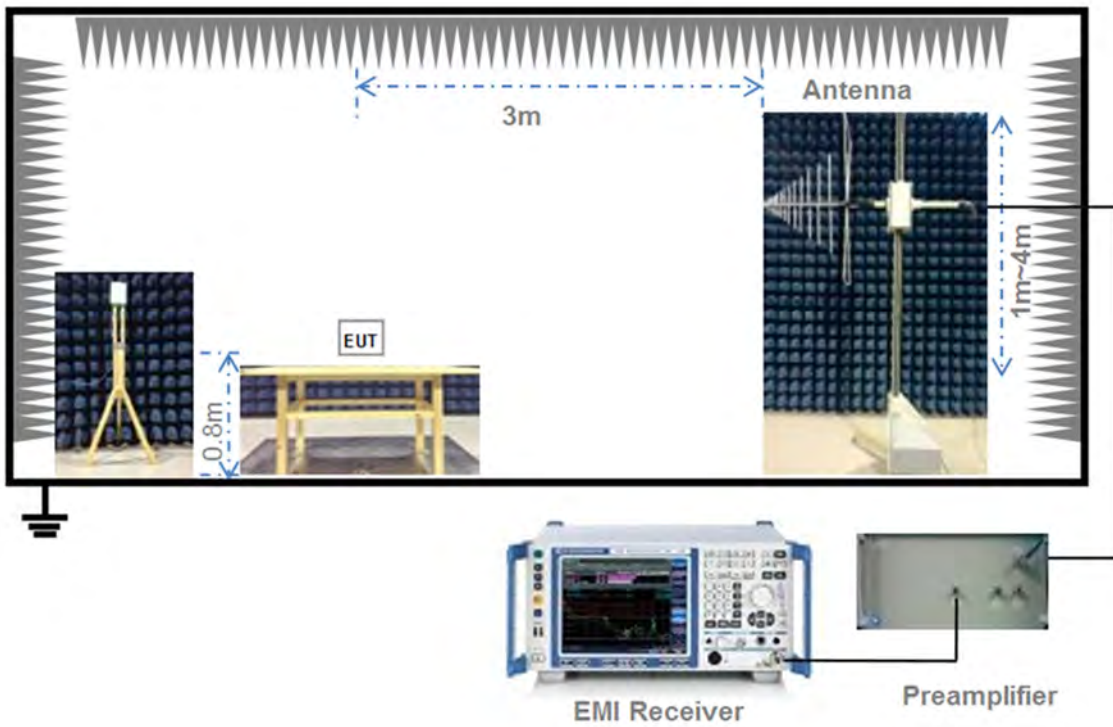

(Diagram 4)

4.4.5 For Radiated Test (Above 1 GHz)

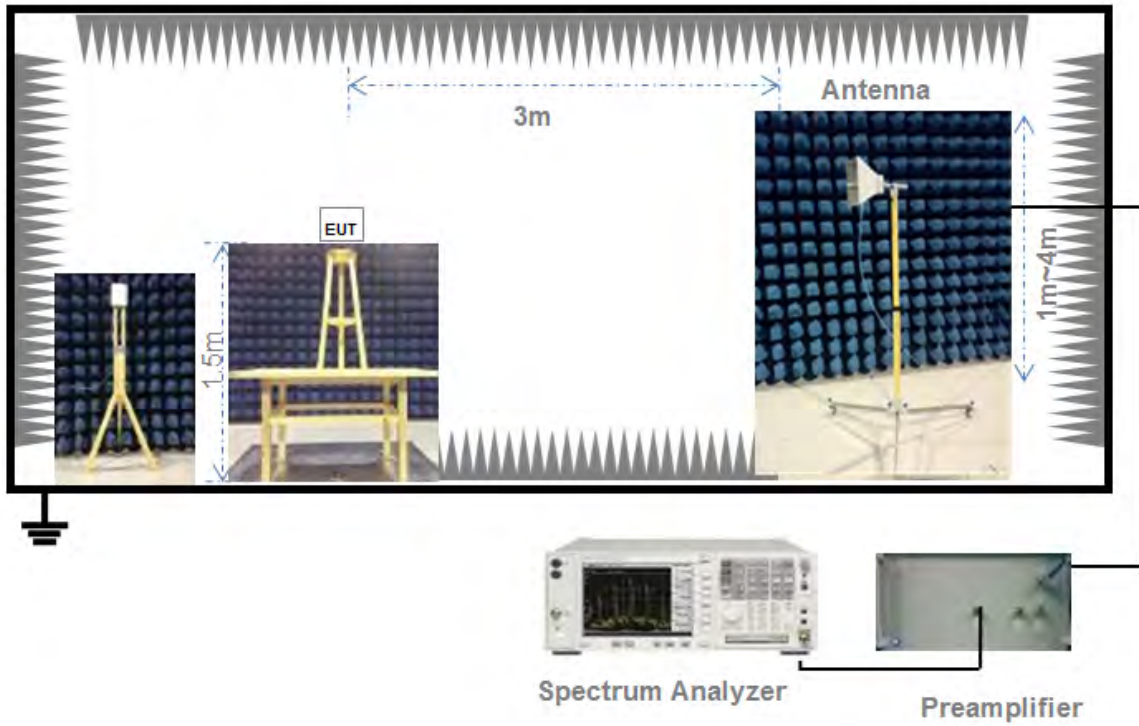

(Diagram 5)

4.5 Measurement Results Explanation Example

4.5.1 For conducted test items:

The offset level is set in the spectrum analyzer to compensate the RF cable loss and attenuator between EUT conducted output port and spectrum analyzer. With the offset compensation, the spectrum analyzer reading level is exactly the EUT RF output level.

The spectrum analyzer offset is derived from RF cable loss and attenuator factor.

Offset = RF cable loss + attenuator factor.

4.5.2 For radiated band edges and spurious emission test:

$$E = \text{EIRP} - 20\log D + 104.8$$

where:

E = electric field strength in dB μ V/m,

EIRP = equivalent isotropic radiated power in dBm

D = specified measurement distance in meters.

EIRP= Measure Conducted output power Value (dBm) + Maximum transmit antenna gain (dBi) + the appropriate maximum ground reflection factor (dB)

5 TEST ITEMS

5.1 Antenna Requirements

5.1.1 Relevant Standards

FCC §15.203; RSS-247, 5.4 (f)

An intentional radiator shall be designed to ensure that no antenna other than that furnished by the responsible party shall be used with the device. The use of a permanently attached antenna or of an antenna that uses a unique coupling to the intentional radiator shall be considered sufficient to comply with the provisions of this section. The manufacturer may design the unit so that a broken antenna can be replaced by the user, but the use of a standard antenna jack or electrical connector is prohibited. This requirement does not apply to carrier current devices or to devices operated under the provisions of § 15.211, § 15.213, § 15.217, § 15.219, or § 15.221. Further, this requirement does not apply to intentional radiators that must be professionally installed, such as perimeter protection systems and some field disturbance sensors, or to other intentional radiators which, in accordance with § 15.31(d), must be measured at the installation site. However, the installer shall be responsible for ensuring that the proper antenna is employed so that the limits in this part are not exceeded.

If directional gain of transmitting antennas is greater than 6 dBi, the power shall be reduced by the same level in dB comparing to gain minus 6 dBi. For the fixed point-to-point operation, the power shall be reduced by one dB for every 3 dB that the directional gain of the antenna exceeds 6 dBi. The use of a permanently attached antenna or of an antenna that uses a unique coupling to the intentional radiator shall be considered sufficient to comply with the FCC rule.

5.1.2 Antenna Anti-Replacement Construction

The Antenna Anti-Replacement as following method:

Protected Method	Description
The antenna is embedded in the product.	An embedded-in antenna design is used.

Reference Documents	Item
Photo	Please refer to the EUT Photo documents.

5.1.3 Antenna Gain

The antenna peak gain of EUT is less than 6 dBi. Therefore, it is not necessary to reduce maximum peak output power limit.

5.2 Output Power

5.2.1 Test Limit

FCC § 15.247(b)

For systems using digital modulation in the 902-928 MHz, 2400-2483.5 MHz, and 5725-5850 MHz bands: 1 Watt. As an alternative to a peak power measurement, compliance with the one Watt limit can be based on a measurement of the maximum conducted output power. Maximum Conducted Output Power is defined as the total transmit power delivered to all antennas and antenna elements averaged across all symbols in the signaling alphabet when the transmitter is operating at its maximum power control level. Power must be summed across all antennas and antenna elements.

5.2.2 Test Setup

See section 4.4.1 for test setup description for the antenna port. The photo of test setup please refer to ANNEX B.

5.2.3 Test Procedure

Maximum peak conducted output power

The maximum peak conducted output power may be measured using a broadband peak RF power meter. The power meter shall have a video bandwidth that is greater than or equal to the DTS bandwidth and shall utilize a fast-responding diode detector.

Maximum conducted (average) output power (Reporting Only)

a) As an alternative to spectrum analyzer or EMI receiver measurements, measurements may be performed using a wideband RF power meter with a thermocouple detector or equivalent if all of the conditions listed below are satisfied.

- 1) The EUT is configured to transmit continuously, or to transmit with a constant duty factor.
 - 2) At all times when the EUT is transmitting, it shall be transmitting at its maximum power control level.
 - 3) The integration period of the power meter exceeds the repetition period of the transmitted signal by at least a factor of five.
- b) If the transmitter does not transmit continuously, measure the duty cycle (x) of the transmitter output signal as described in Section 6.0.
- c) Measure the average power of the transmitter. This measurement is an average over both the on and off periods of the transmitter.
- d) Adjust the measurement in dBm by adding $10\log(1/x)$, where x is the duty cycle to the measurement result.

Measurements of duty cycle

The zero-span mode on a spectrum analyzer or EMI receiver if the response time and spacing between bins on the sweep are sufficient to permit accurate measurements of the on and off times of the transmitted signal.

Set the center frequency of the instrument to the center frequency of the transmission.

Set $RBW \geq OBW$ if possible; otherwise, set RBW to the largest available value.

Set $VBW \geq RBW$. Set detector = peak or average.

The zero-span measurement method shall not be used unless both RBW and VBW are $> 50/T$ and the number of sweep points across duration T exceeds 100. (For example, if VBW and/or RBW are limited to 3 MHz, then the zero-span method of measuring duty cycle shall not be used if $T \leq 16.7$ microseconds.)

5.2.4 Test Result

Please refer to ANNEX A.1.

5.3 6dB Bandwidth

5.3.1 Limit

FCC §15.247(a)

Make the measurement with the spectrum analyzer's resolution bandwidth (RBW) = 100 kHz. In order to make an accurate measurement, set the span greater than RBW. The 6 dB bandwidth must be greater than 500 kHz.

5.3.2 Test Setup

See section 4.4.1 for test setup description for the antenna port. The photo of test setup please refer to ANNEX B.

5.3.3 Test Procedure

Use the following spectrum analyzer settings:

Set RBW = 100 kHz.

Set the video bandwidth (VBW) ≥ 3 RBW.

Detector = Peak.

Trace mode = max hold.

Sweep = auto couple.

Allow the trace to stabilize.

Measure the maximum width of the emission that is constrained by the frequencies associated with the two outermost amplitude points (upper and lower frequencies) that are attenuated by 6 dB relative to the maximum level measured in the fundamental emission.

5.3.4 Test Result

Please refer to ANNEX A.2.

5.4 Conducted Spurious Emission

5.4.1 Limit

FCC §15.247(d)

In any 100 kHz bandwidth outside the frequency band in which the spread spectrum or digitally modulated intentional radiator is operating, the radio frequency power that is produced by the intentional radiator shall be at least 20 dB below that in the 100 kHz bandwidth within the band that contains the highest level of the desired power, based on either an RF conducted or a radiated measurement.

5.4.2 Test Setup

See section 4.4.1 for test setup description for the antenna port. The photo of test setup please refer to ANNEX B.

5.4.3 Test Procedure

The DTS rules specify that in any 100 kHz bandwidth outside of the authorized frequency band, the power shall be attenuated according to the following conditions:

- a) If the maximum peak conducted output power procedure was used to demonstrate compliance as described in 9.1, then the peak output power measured in any 100 kHz bandwidth outside of the authorized frequency band shall be attenuated by at least 20 dB relative to the maximum in-band peak PSD level in 100 kHz (i.e., 20 dBc).
- b) If maximum conducted (average) output power was used to demonstrate compliance as described in 9.2, then the peak power in any 100 kHz bandwidth outside of the authorized frequency band shall be attenuated by at least 30 dB relative to the maximum in-band peak PSD level in 100 kHz (i.e., 30 dBc).
- c) In either case, attenuation to levels below the 15.209 general radiated emissions limits is not required.

The following procedures shall be used to demonstrate compliance to these limits. Note that these procedures can be used in either an antenna-port conducted or radiated test set-up. Radiated tests must conform to the test site requirements and utilize maximization procedures defined herein.

Reference level measurement

Establish a reference level by using the following procedure:

Set instrument center frequency to DTS channel center frequency.

Set the span to ≥ 1.5 times the DTS bandwidth.

Set the RBW = 100 kHz.

Set the VBW $\geq 3 \times$ RBW.

Detector = peak.

Sweep time = auto couple.

Trace mode = max hold.

Allow trace to fully stabilize.

Use the peak marker function to determine the maximum PSD level.

Emission level measurement

Use the following spectrum analyzer settings:

Span = wide enough to capture the peak level of the in-band emission and all spurious emissions (e.g., harmonics) from the lowest frequency generated in the EUT up through the 10th harmonic. Typically, several plots are required to cover this entire span.

Set the RBW = 100 kHz.

Set the VBW $\geq 3 \times$ RBW.

Detector = peak.

Sweep time = auto couple.

Trace mode = max hold.

Allow trace to fully stabilize.

Use the peak marker function to determine the maximum amplitude level.

Ensure that the amplitude of all unwanted emissions outside of the authorized frequency band (excluding restricted frequency bands) are attenuated by at least the minimum requirements specified in 11.1 a) or 11.1 b). Report the three highest emissions relative to the limit.

5.4.4 Test Result

Please refer to ANNEX A.3.

5.5 Band Edge (Authorized-band band-edge)

5.5.1 Limit

FCC §15.247(d)

In any 100 kHz bandwidth outside the frequency band in which the spread spectrum or digitally modulated intentional radiator is operating, the radio frequency power that is produced by the intentional radiator shall be at least 20 dB below that in the 100 kHz bandwidth within the band that contains the highest level of the desired power, based on either an RF conducted or a radiated measurement.

5.5.2 Test Setup

See section 4.4.1 for test setup description for the antenna port. The photo of test setup please refer to ANNEX B.

5.5.3 Test Procedure

The following procedures may be used to determine the peak or average field strength or power of an unwanted emission that is within 2 MHz of the authorized band edge. If a peak detector is utilized, use the procedure described in 13.2.1. Use the procedure described in 13.2.2 when using an average detector and the EUT can be configured to transmit continuously (i.e., duty cycle $\geq 98\%$). Use the procedure described in 13.2.3 when using an average detector and the EUT cannot be configured to transmit continuously but the duty cycle is constant (i.e., duty cycle variations are less than ± 2 percent). Use the procedure described in 13.2.4 when using an average detector for those cases where the EUT cannot be configured to transmit continuously and the duty cycle is not constant (duty cycle variations equal or exceed 2 percent).

When using a peak detector to measure unwanted emissions at or near the band edge (within 2 MHz of the authorized band), the following integration procedure can be used.

Set instrument center frequency to the frequency of the emission to be measured (must be within 2 MHz of the authorized band edge).

Set span to 2 MHz

RBW = 100 kHz.

VBW $\geq 3 \times$ RBW.

Detector = peak.

Sweep time = auto.

Trace mode = max hold.

Allow sweep to continue until the trace stabilizes (required measurement time may increase for low duty cycle applications)

Compute the power by integrating the spectrum over 1 MHz using the analyzer's band power measurement function with band limits set equal to the emission frequency (femission) ± 0.5 MHz. If the instrument does not have a band power function, then sum the amplitude levels (in power units) at 100 kHz intervals extending across the 1 MHz spectrum defined by femission ± 0.5 MHz.

Standard method(The 99% OBW of the fundamental emission is without 2 MHz of the authorized band):

Span: Wide enough to capture the peak level of the emission operating on the channel closest to the band edge, as well as any modulation products that fall outside of the authorized band of operation.

Reference level: As required to keep the signal from exceeding the maximum instrument input mixer level for linear operation. In general, the peak of the spectral envelope shall be more than $[10 \log (OBW/RBW)]$ below the reference level. Specific guidance is given in 4.1.5.2.

Attenuation: Auto (at least 10 dB preferred).

Sweep time: Coupled.

Resolution bandwidth: 100 kHz.

Video bandwidth: 300 kHz.

Detector: Peak.

Trace: Max hold.

5.5.4 Test Result

Please refer to ANNEX A.4.

5.6 Conducted Emission

5.6.1 Limit

FCC §15.207

For an intentional radiator that is designed to be connected to the public utility (AC) power line, the radio frequency voltage that is conducted back onto the AC power line on any frequency within the band 150 kHz to 30 MHz shall not exceed the limits in the following table, as measured using a 50 μ H/50 Ω line impedance stabilization network (LISN).

Frequency range (MHz)	Conducted Limit (dB μ V)	
	Quai-peak	Average
0.15 - 0.50	66 to 56	56 to 46
0.50 - 5	56	46
0.50 - 30	60	50

5.6.2 Test Setup

See section 4.4.2 for test setup description for the AC power supply port. The photo of test setup please refer to ANNEX B.

5.6.3 Test Procedure

The maximum conducted interference is searched using Peak (PK), if the emission levels more than the AV and QP limits, and that have narrow margins from the AV and QP limits will be re-measured with AV and QP detectors. Tests for both L phase and N phase lines of the power mains connected to the EUT are performed. Refer to recorded points and plots below.

Devices subject to Part 15 must be tested for all available U.S. voltages and frequencies (such as a nominal 120 VAC, 50/60 Hz and 240 VAC, 50/60 Hz) for which the device is capable of operation. A device rated for 50/60 Hz operation need not be tested at both frequencies provided the radiated and line conducted emissions are the same at both frequencies.

5.6.4 Test Result

Please refer to ANNEX A.5.

5.7 Radiated Spurious Emission

5.7.1 Limit

FCC §15.209&15.247(d)

Radiated emission outside the frequency band attenuation below the general limits specified in FCC section 15.209(a) is not required. In addition, radiated emissions which fall in the restricted bands, as defined in FCC section 15.205(a), must also comply with the radiated emission limits specified in FCC section 15.209(a).

According to FCC section 15.209 (a), except as provided elsewhere in this subpart, the emissions from an intentional radiator shall not exceed the field strength levels specified in the following table:

Frequency (MHz)	Field Strength ($\mu\text{V}/\text{m}$)	Measurement Distance (m)
0.009 - 0.490	2400/F(kHz)	300
0.490 - 1.705	24000/F(kHz)	30
1.705 - 30.0	30	30
30 - 88	100	3
88 - 216	150	3
216 - 960	200	3
Above 960	500	3

Note:

1. For Above 1000 MHz, the emission limit in this paragraph is based on measurement instrumentation employing an average detector, measurement using instrumentation with a peak detector function, corresponding to 20dB above the maximum permitted average limit.
2. For above 1000 MHz, limit field strength of harmonics: 54dBuV/m@3m (AV) and 74dBuV/m@3m (PK).

5.7.2 Test Setup

See section 4.4.3 to 4.4.5 for test setup description for the antenna port. The photo of test setup please refer to ANNEX B.

5.7.3 Test Procedure

Since the emission limits are specified in terms of radiated field strength levels, measurements performed to demonstrate compliance have traditionally relied on a radiated test configuration. Radiated measurements remain the principal method for demonstrating compliance to the specified limits; however antenna-port conducted measurements are also now acceptable to demonstrate compliance (see below for details). When radiated measurements are utilized, test site requirements and procedures for maximizing and measuring radiated emissions that are described in ANSI C63.10 shall be followed.

Antenna-port conducted measurements may also be used as an alternative to radiated measurements for demonstrating compliance in the restricted frequency bands. If conducted measurements are performed, then proper impedance matching must be ensured and an additional radiated test for cabinet/case spurious emissions is required.

General Procedure for conducted measurements in restricted bands

- a) Measure the conducted output power (in dBm) using the detector specified (see guidance regarding measurement procedures for determining quasi-peak, peak, and average conducted output power, respectively).

- b) Add the maximum transmit antenna gain (in dBi) to the measured output power level to determine the EIRP level (see guidance on determining the applicable antenna gain)
- c) Add the appropriate maximum ground reflection factor to the EIRP level (6 dB for frequencies ≤ 30 MHz, 4.7 dB for frequencies between 30 MHz and 1000 MHz, inclusive and 0 dB for frequencies > 1000 MHz).
- d) For devices with multiple antenna-ports, measure the power of each individual chain and sum the EIRP of all chains in linear terms (e.g., Watts, mW).
- e) Convert the resultant EIRP level to an equivalent electric field strength using the following relationship:

$$E = \text{EIRP} - 20 \log D + 104.8$$

where:

E = electric field strength in dB μ V/m,

EIRP = equivalent isotropic radiated power in dBm

D = specified measurement distance in meters.

- f) Compare the resultant electric field strength level to the applicable limit.
- g) Perform radiated spurious emission test.

Quasi-Peak measurement procedure

The specifications for measurements using the CISPR quasi-peak detector can be found in Publication 16 of the International Special Committee on Radio Frequency Interference (CISPR) of the International Electrotechnical Commission.

As an alternative to CISPR quasi-peak measurement, compliance can be demonstrated to the applicable emission limits using a peak detector.

Peak power measurement procedure

Peak emission levels are measured by setting the instrument as follows:

- a) RBW = as specified in Table 1.
- b) VBW $\geq 3 \times$ RBW.
- c) Detector = Peak.
- d) Sweep time = auto.
- e) Trace mode = max hold.
- f) Allow sweeps to continue until the trace stabilizes. (Note that the required measurement time may be longer for low duty cycle applications).

Table 1—RBW as a function of frequency

Frequency	RBW
9-150 kHz	200-300 Hz
0.15-30 MHz	9-10 kHz
30-1000 MHz	100-120 kHz

> 1000 MHz	1 MHz
------------	-------

If the peak-detected amplitude can be shown to comply with the average limit, then it is not necessary to perform a separate average measurement.

Trace averaging across on and off times of the EUT transmissions followed by duty cycle correction

If continuous transmission of the EUT (i.e., duty cycle ≥ 98 percent) cannot be achieved and the duty cycle is constant (i.e., duty cycle variations are less than ± 2 percent), then the following procedure shall be used:

- a) The EUT shall be configured to operate at the maximum achievable duty cycle.
- b) Measure the duty cycle, x , of the transmitter output signal as described in section 6.0.
- c) RBW = 1 MHz (unless otherwise specified).
- d) VBW $\geq 3 \times$ RBW.
- e) Detector = RMS, if $\text{span}/(\# \text{ of points in sweep}) \leq (\text{RBW}/2)$. Satisfying this condition may require increasing the number of points in the sweep or reducing the span. If this condition cannot be satisfied, then the detector mode shall be set to peak.
- f) Averaging type = power (i.e., RMS).
 - 1) As an alternative, the detector and averaging type may be set for linear voltage averaging.
 - 2) Some instruments require linear display mode in order to use linear voltage averaging. Log or dB averaging shall not be used.
- g) Sweep time = auto.
- h) Perform a trace average of at least 100 traces.
- i) A correction factor shall be added to the measurement results prior to comparing to the emission limit in order to compute the emission level that would have been measured had the test been performed at 100 percent duty cycle. The correction factor is computed as follows:
 - 1) If power averaging (RMS) mode was used in step f), then the applicable correction factor is $10 \log(1/x)$, where x is the duty cycle.
 - 2) If linear voltage averaging mode was used in step f), then the applicable correction factor is $20 \log(1/x)$, where x is the duty cycle.
 - 3) If a specific emission is demonstrated to be continuous (≥ 98 percent duty cycle) rather than turning on and off with the transmit cycle, then no duty cycle correction is required for that emission.

NOTE: Reduction of the measured emission amplitude levels to account for operational duty factor is not permitted. Compliance is based on emission levels occurring during transmission - not on an average across on and off times of the transmitter.

Determining the applicable transmit antenna gain

A conducted power measurement will determine the maximum output power associated with a restricted band emission; however, in order to determine the associated EIRP level, the gain of the transmitting antenna (in dBi) must be added to the measured output power (in dBm).

Since the out-of-band characteristics of the EUT transmit antenna will often be unknown, the use of a conservative antenna gain value is necessary. Thus, when determining the EIRP based on the measured conducted power, the upper bound on antenna gain for a device with a single RF output shall be selected as the maximum in-band gain of the antenna across all operating bands, or 2 dBi, whichever is greater. However, for devices that operate in multiple frequency bands while using the same transmit antenna, the highest gain of the antenna within the operating band nearest in frequency to the restricted band emission being measured may be used in lieu of the overall highest gain when the emission is at a frequency that is within 20 percent of the nearest band edge frequency, but in no case shall a value less than 2 dBi be used.

See KDB 662911 for guidance on calculating the additional array gain term when determining the effective antenna gain for a EUT with multiple outputs occupying the same or overlapping frequency ranges in the same band.

Radiated spurious emission test

An additional consideration when performing conducted measurements of restricted band emissions is that unwanted emissions radiating from the EUT cabinet, control circuits, power leads, or intermediate circuit elements will likely go undetected in a conducted measurement configuration. To address this concern, a radiated test shall be performed to ensure that emissions emanating from the EUT cabinet (rather than the antenna port) also comply with the applicable limits.

For these cabinet radiated spurious emission measurements the EUT transmit antenna may be replaced with a termination matching the nominal impedance of the antenna. Procedures for performing radiated measurements are specified in ANSI C63.10. All detected emissions shall comply with the applicable limits.

The measurement frequency range is from 30 MHz to the 10th harmonic of the fundamental frequency. The Turn Table is actuated to turn from 0° to 360°, and both horizontal and vertical polarizations of the Test Antenna are used to find the maximum radiated power. Mid channels on all channel bandwidth verified. Only the worst RB size/offset presented.

The power of the EUT transmitting frequency should be ignored.

All Spurious Emission tests were performed in X, Y, Z axis direction. And only the worst axis test condition was recorded in this test report.

Use the following spectrum analyzer settings:

Span = wide enough to fully capture the emission being measured

RBW = 1 MHz for $f \geq 1$ GHz, 100 kHz for $f < 1$ GHz

VBW \geq RBW

Sweep = auto

Detector function = peak

Trace = max hold

5.7.4 Test Result

Please refer to ANNEX A.6.

5.8 Band Edge (Restricted-band band-edge)

5.8.1 Limit

FCC §15.209&15.247(d)

Radiated emission outside the frequency band attenuation below the general limits specified in FCC section 15.209(a) is not required. In addition, radiated emissions which fall in the restricted bands, as defined in FCC section 15.205(a), must also comply with the radiated emission limits specified in FCC section 15.209(a).

5.8.2 Test Setup

See section 4.4.1 for test setup description for the antenna port. The photo of test setup please refer to ANNEX B.

5.8.3 Test Procedure

The measurement frequency range is from 9 kHz to the 10th harmonic of the fundamental frequency. The Turn Table is actuated to turn from 0° to 360°, and both horizontal and vertical polarizations of the Test Antenna are used to find the maximum radiated power. Mid channels on all channel bandwidth verified. Only the worst RB size/offset presented.

The power of the EUT transmitting frequency should be ignored.

All Spurious Emission tests were performed in X, Y, Z axis direction. And only the worst axis test condition was recorded in this test report.

Use the following spectrum analyzer settings:

Span = wide enough to fully capture the emission being measured

RBW = 1 MHz for $f \geq 1$ GHz, 100 kHz for $f < 1$ GHz

VBW \geq RBW

Sweep = auto

Detector function = peak

Trace = max hold

For measurement below 1GHz, If the emission level of the EUT measured by the peak detector is 3 dB lower than the applicable limit, the peak emission level will be reported, Otherwise, the emission measurement will be repeated using the quasi-peak detector and reported.

For transmitters operating above 1 GHz repeat the measurement with an average detector.

5.8.4 Test Result

Please refer to ANNEX A.7.

5.9 Power Spectral density (PSD)

5.9.1 Limit

FCC §15.247(e)

The same method of determining the conducted output power shall be used to determine the power spectral density. If a peak output power is measured, then a peak power spectral density measurement is required. If an average output power is measured, then an average power spectral density measurement should be used.

5.9.2 Test Setup

See section 4.4.1 for test setup description for the antenna port. The photo of test setup please refer to ANNEX B.

5.9.3 Test Procedure

Set analyzer center frequency to DTS channel center frequency.

Set the span to 1.5 times the DTS bandwidth.

Set the RBW to: $3 \text{ kHz} \leq \text{RBW} \leq 100 \text{ kHz}$.

Set the VBW $\geq 3 \text{ RBW}$.

Detector = peak.

Sweep time = auto couple.

Trace mode = max hold.

Allow trace to fully stabilize.

Use the peak marker function to determine the maximum amplitude level within the RBW.

If measured value exceeds limit, reduce RBW (no less than 3 kHz) and repeat.

5.9.4 Test Result

Please refer to ANNEX A.8.

ANNEX A TEST RESULT

A.1 Output Power

Duty Cycle

Test Mode	On Time (ms)	On+Off time (ms)	Duty Cycle
802.11b	8.588	8.709	98.61
802.11g	1.419	1.528	92.87
802.11n-20 MHz	1.333	1.436	92.83

Peak Power Test Data

802.11b Mode:

Channel	Measured Output Peak Power		Limit		Verdict
	dBm	mW	dBm	mW	
Low	18.83	76.38	30	1000	Pass
Middle	18.89	77.45			Pass
High	18.95	78.52			Pass

802.11g Mode:

Channel	Measured Output Peak Power		Limit		Verdict
	dBm	mW	dBm	mW	
Low	23.92	246.60	30	1000	Pass
Middle	24.70	295.12			Pass
High	24.82	303.39			Pass

802.11n-20 MHz Mode:

Channel	Measured Output Peak Power		Limit		Verdict
	dBm	mW	dBm	mW	
Low	23.50	223.87	30	1000	Pass
Middle	23.60	229.09			Pass
High	23.70	234.42			Pass

Average Power Test Data

802.11b Mode:

Channel	Measured Output Average Power		Limit		Verdict
	dBm	mW	dBm	mW	
Low	15.16	32.81	30	1000	Pass
Middle	14.78	30.06			Pass
High	15.09	32.28			Pass

802.11g Mode:

Channel	Measured Output Average Power		Limit		Verdict
	dBm	mW	dBm	mW	
Low	15.10	32.36	30	1000	Pass
Middle	15.46	35.16			Pass
High	15.85	38.46			Pass

802.11n-20 MHz Mode:

Channel	Measured Output Average Power		Limit		Verdict
	dBm	mW	dBm	mW	
Low	14.46	27.93	30	1000	Pass
Middle	14.48	28.05			Pass
High	14.46	27.93			Pass

A.2 Bandwidth

Test Data

802.11b Mode:

Channel	6 dB Bandwidth (MHz)	99% Bandwidth (MHz)	6 dB Bandwidth Limits (kHz)
Low	9.100000	13.963000	≥ 500
Middle	8.650000	14.002000	≥ 500
High	9.100000	13.998000	≥ 500

802.11g Mode:

Channel	6 dB Bandwidth (MHz)	99% Bandwidth (MHz)	6 dB Bandwidth Limits (kHz)
Low	15.200000	16.921000	≥ 500
Middle	15.150000	16.903000	≥ 500
High	15.200000	16.929000	≥ 500

802.11n-20MHz Mode:

Channel	6 dB Bandwidth (MHz)	99% Bandwidth (MHz)	6 dB Bandwidth Limits (kHz)
Low	15.150000	17.898000	≥ 500
Middle	15.150000	17.876000	≥ 500
High	15.200000	17.879000	≥ 500

Test plots

6 dB Bandwidth

802.11b LOW CHANNEL



802.11b MIDDLE CHANNEL



802.11b HIGH CHANNEL



802.11g LOW CHANNEL



802.11g MIDDLE CHANNEL



802.11g HIGH CHANNEL

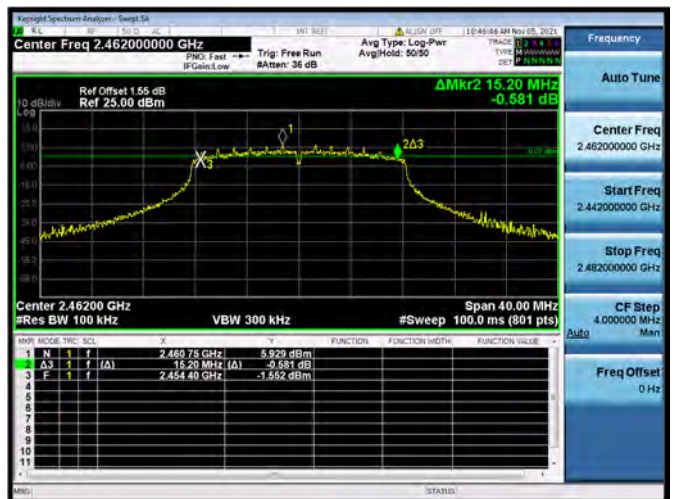

802.11n-20 MHz LOW CHANNEL

802.11 n-20 MHz MIDDLE CHANNEL



802.11n-20 MHz HIGH CHANNEL



99% Bandwidth

802.11b LOW CHANNEL

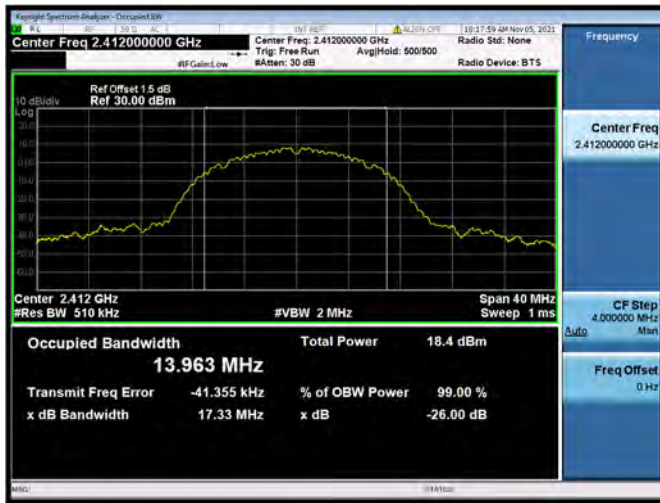

802.11b MIDDLE CHANNEL



802.11b HIGH CHANNEL



802.11g LOW CHANNEL



802.11g MIDDLE CHANNEL



802.11g HIGH CHANNEL



802.11n-20 MHz LOW CHANNEL

802.11 n-20 MHz MIDDLE CHANNEL



802.11n-20 MHz HIGH CHANNEL



A.3 Conducted Spurious Emissions

Test Data

802.11b Mode:

Channel	Measured Max. Out of Band Emission (dBm)	Limit (dBm)		Verdict
		Carrier Level	Calculated 20 dBc Limit	
Low	-41.14	7.98	-12.03	Pass
Middle	-41.87	8.09	-11.91	Pass
High	-44.29	8.12	-11.88	Pass

802.11g Mode:

Channel	Measured Max. Out of Band Emission (dBm)	Limit (dBm)		Verdict
		Carrier Level	Calculated 20 dBc Limit	
Low	-40.34	5.66	-14.34	Pass
Middle	-41.46	6.33	-13.67	Pass
High	-44.53	6.04	-13.96	Pass

802.11n-20MHz Mode:

Channel	Measured Max. Out of Band Emission (dBm)	Limit (dBm)		Verdict
		Carrier Level	Calculated 20 dBc Limit	
Low	-40.08	4.78	-15.22	Pass
Middle	-41.31	5.57	-14.43	Pass
High	-43.64	4.94	-15.07	Pass

Test Plots

802.11b LOW CHANNEL CARRIER LEVEL



802.11b LOW CHANNEL, SPURIOUS 30 MHz ~ 3 GHz

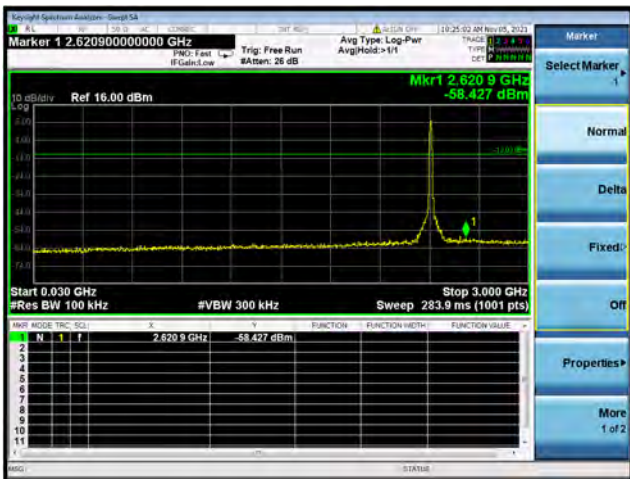

802.11b LOW CHANNEL, SPURIOUS 2 GHz ~ 25 GHz

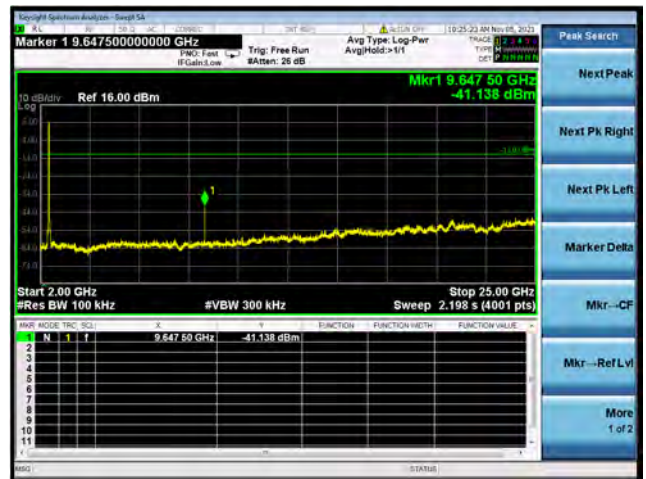

802.11b MIDDLE CHANNEL CARRIER LEVEL



802.11b MIDDLE CHANNEL, SPURIOUS
30 MHz ~ 3 GHz

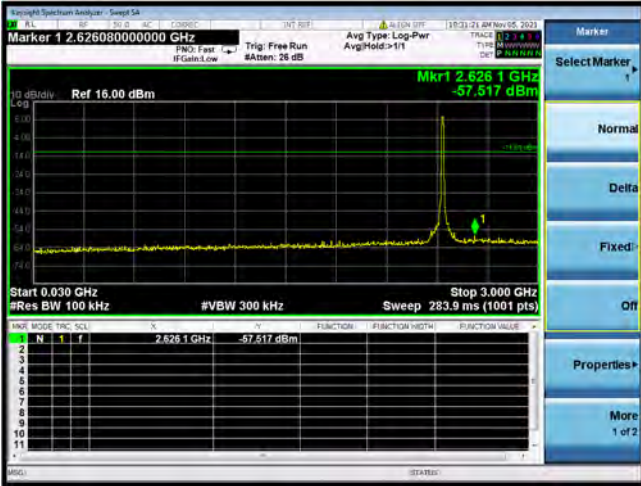

802.11b MIDDLE CHANNEL, SPURIOUS
2 GHz ~ 25 GHz

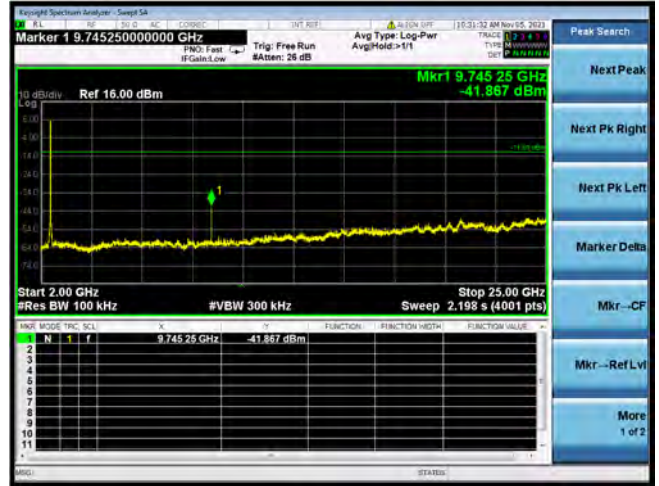

802.11b HIGH CHANNEL CARRIER LEVEL

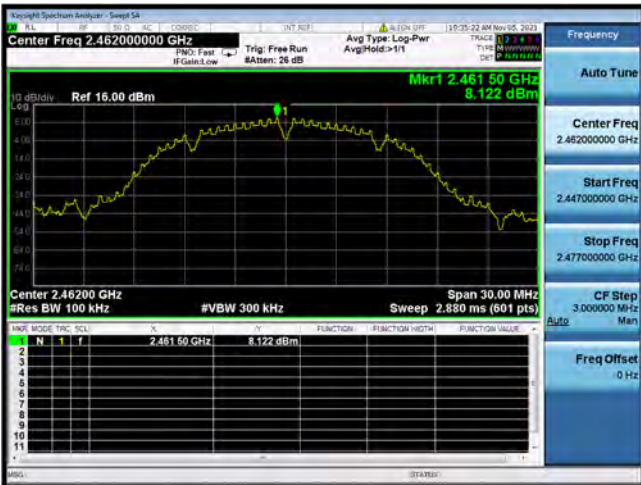

802.11b HIGH CHANNEL, SPURIOUS
30 MHz ~ 3 GHz

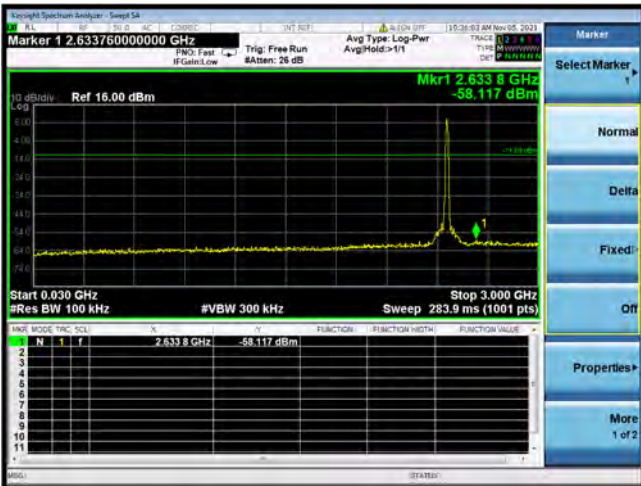

802.11b HIGH CHANNEL, SPURIOUS
2 GHz ~ 25 GHz

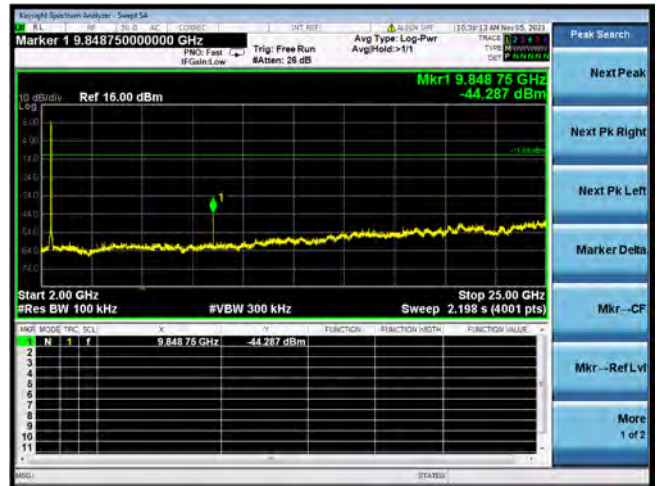

802.11g LOW CHANNEL CARRIER LEVEL

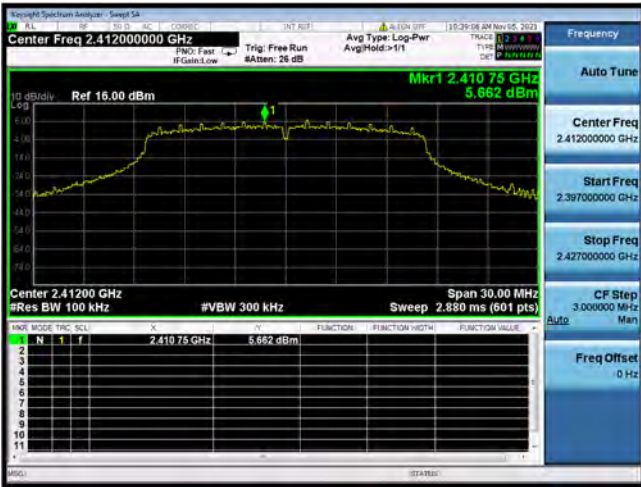

802.11g LOW CHANNEL, SPURIOUS 30 MHz ~ 3 GHz



802.11g LOW CHANNEL, SPURIOUS 2 GHz ~ 25 GHz

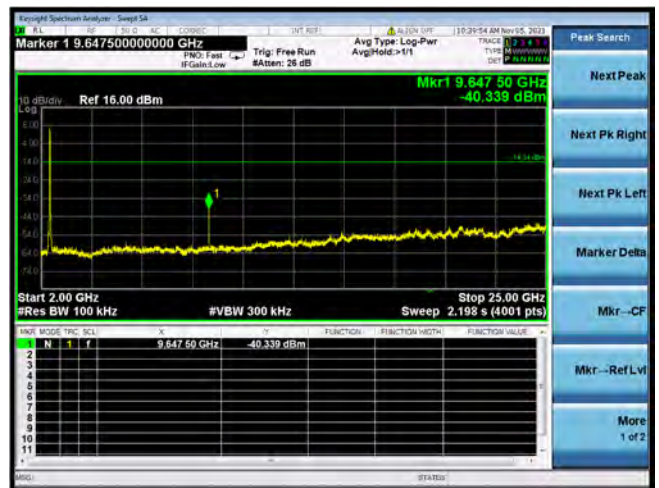

802.11g MIDDLE CHANNEL CARRIER LEVEL

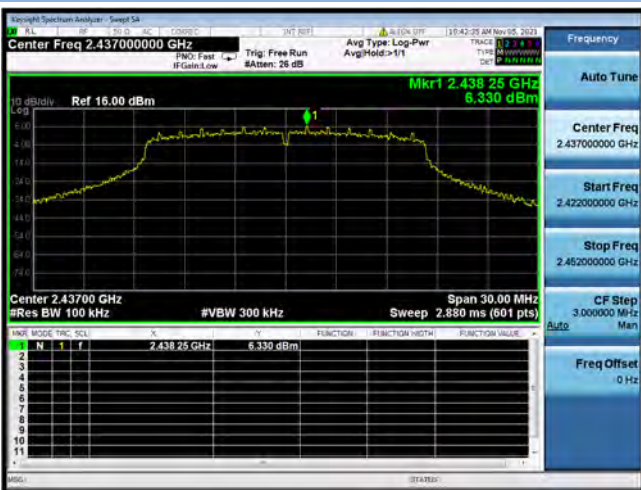

802.11g MIDDLE CHANNEL, SPURIOUS
30 MHz ~ 3 GHz

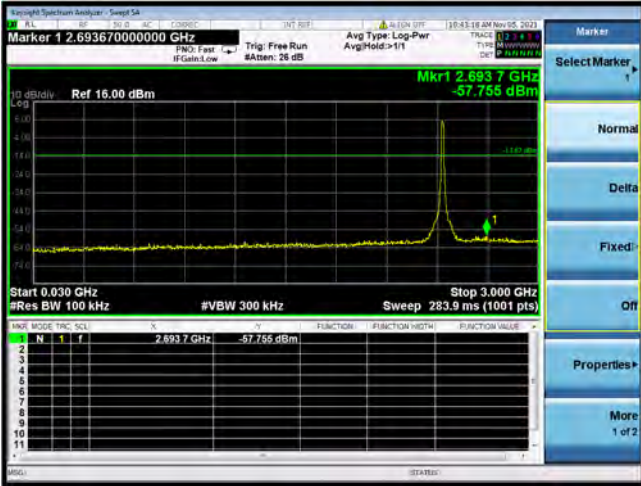

802.11g MIDDLE CHANNEL, SPURIOUS
2 GHz ~ 25 GHz

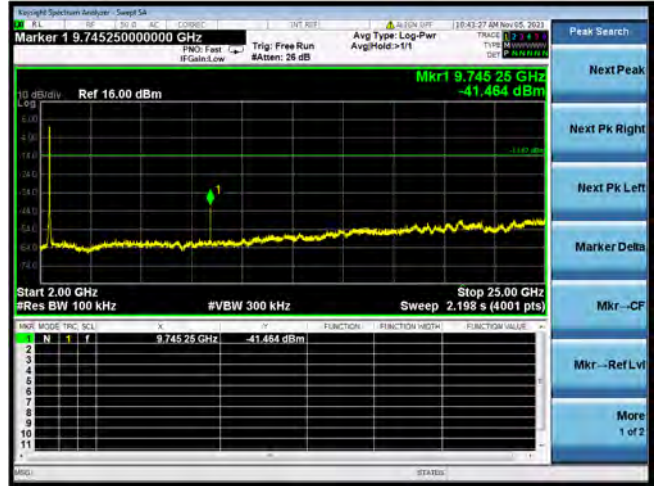

802.11g HIGH CHANNEL CARRIER LEVEL



802.11g HIGH CHANNEL, SPURIOUS
30 MHz ~ 3 GHz

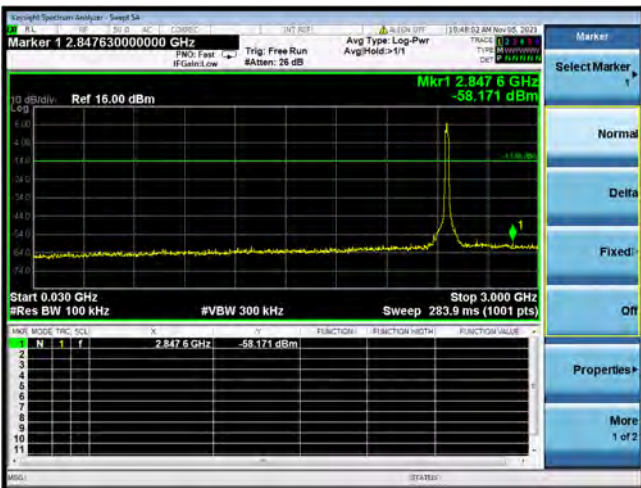

802.11g HIGH CHANNEL, SPURIOUS
2 GHz ~ 25 GHz

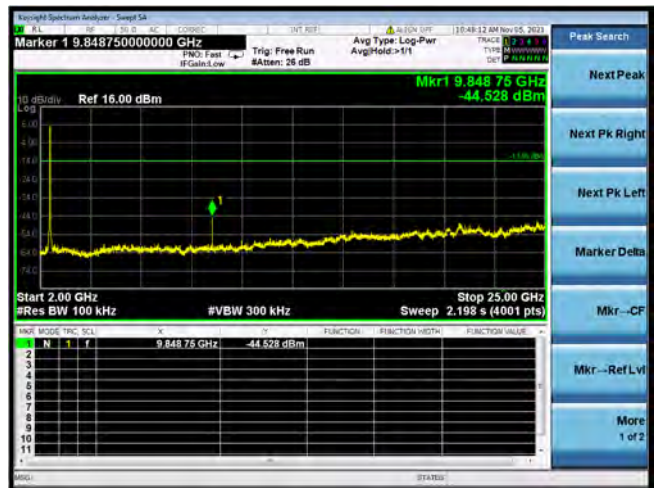

802.11n-20 LOW CHANNEL CARRIER LEVEL

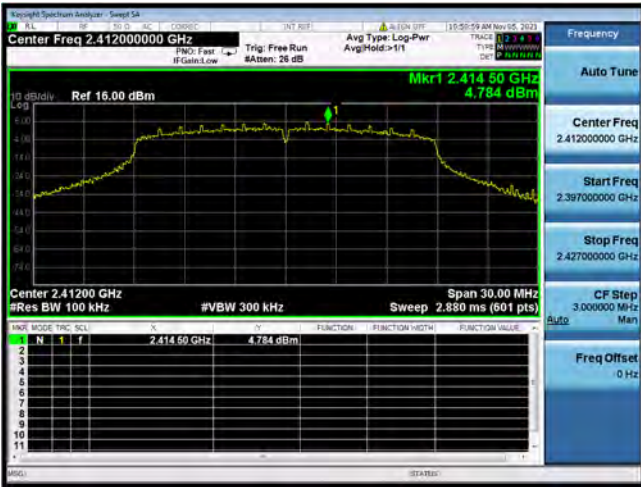

802.11n-20 LOW CHANNEL, SPURIOUS 30 MHz ~ 3 GHz

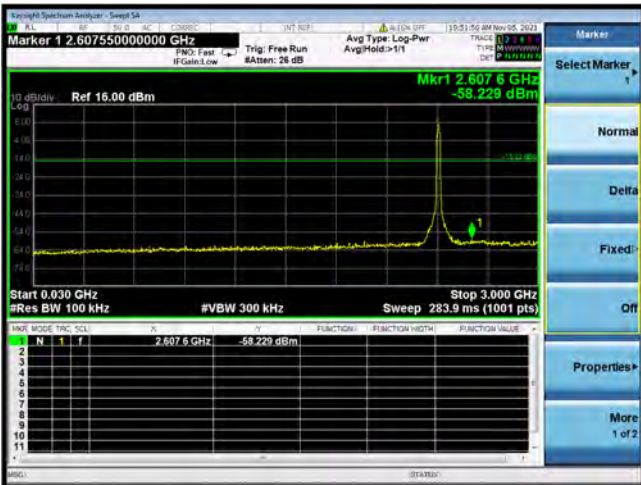

802.11n-20 LOW CHANNEL, SPURIOUS 2 GHz ~ 25 GHz

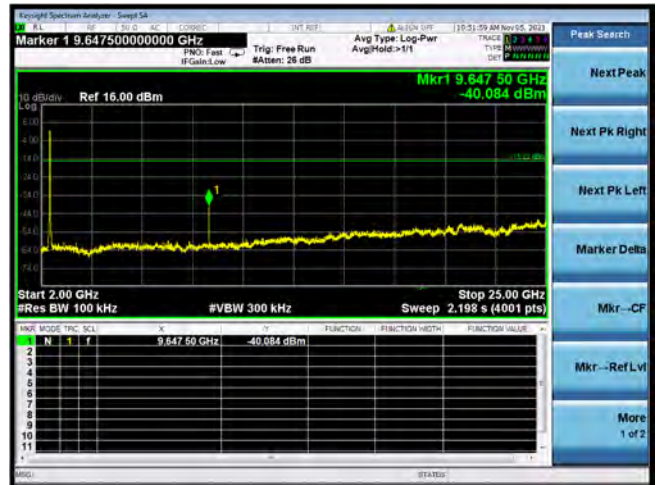

802.11n-20 MIDDLE CHANNEL CARRIER LEVEL

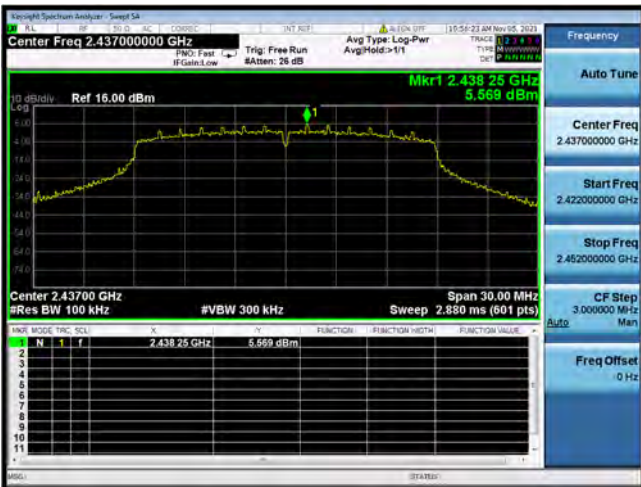

802.11n-20 MIDDLE CHANNEL, SPURIOUS
30 MHz ~ 3 GHz

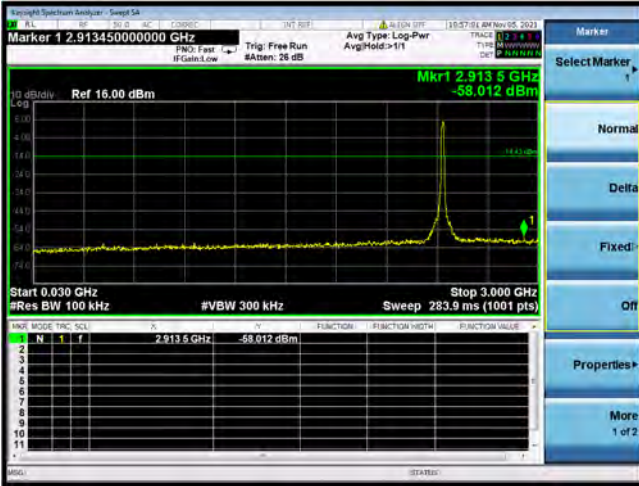

802.11n-20 MIDDLE CHANNEL, SPURIOUS
2 GHz ~ 25 GHz

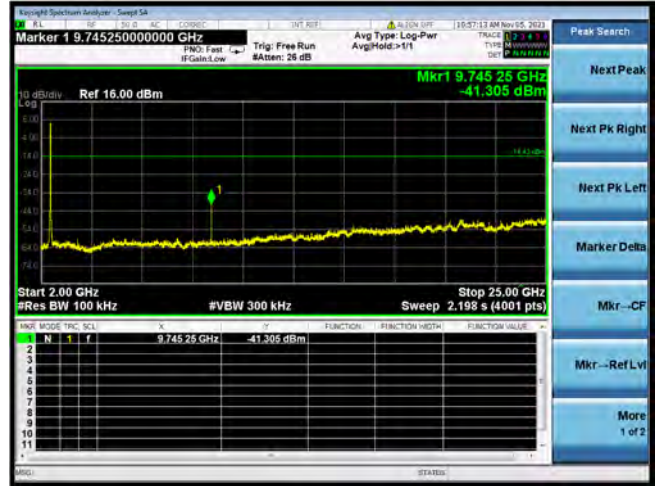

802.11n-20 HIGH CHANNEL CARRIER LEVEL

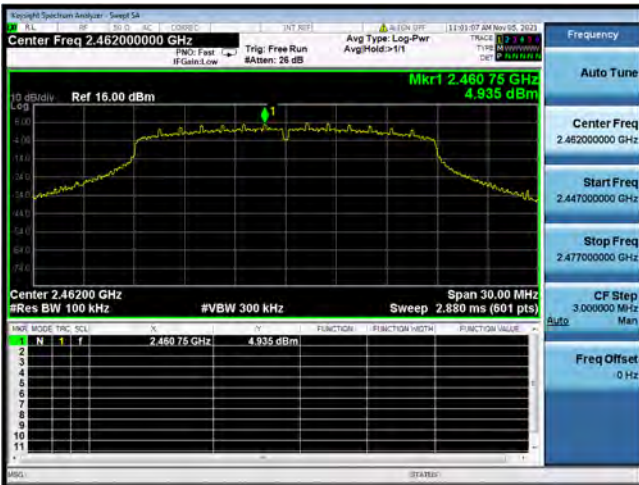

802.11n-20 HIGH CHANNEL, SPURIOUS
30 MHz ~ 3 GHz

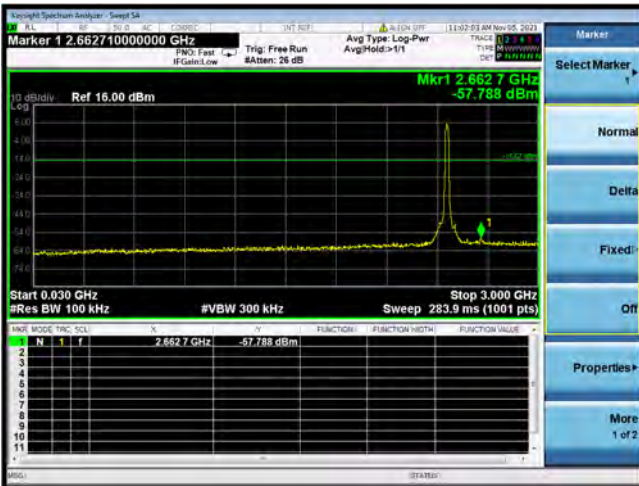

802.11n-20 HIGH CHANNEL, SPURIOUS
2 GHz ~ 25 GHz

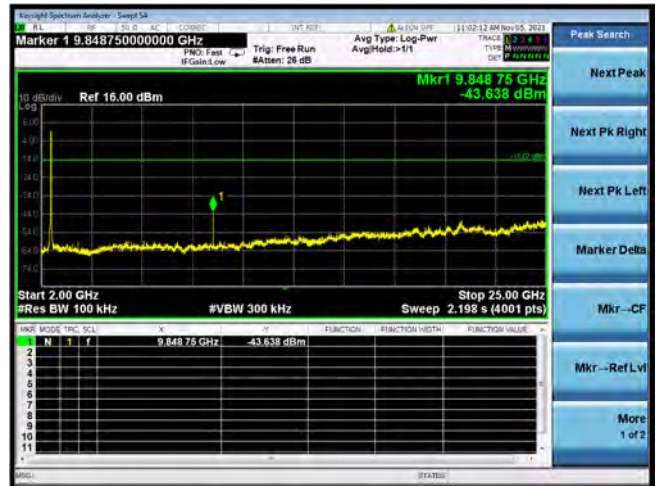

A.4 Band Edge (Authorized-band band-edge)

Test Data

Note: The 99% OBW of the fundamental emission is without 2 MHz of the authorized band.

802.11b Mode:

Channel	Measured Max. Band Edge Emission (dBm)	Limit (dBm)		Verdict
		Carrier Level	Calculated 20 dBc Limit	
Low Channel	-34.91	7.98	-12.03	Pass
High Channel	-53.31	8.12	-11.88	Pass

802.11g Mode:

Channel	Measured Max. Band Edge Emission (dBm)	Limit (dBm)		Verdict
		Carrier Level	Calculated 20 dBc Limit	
Low Channel	-30.24	5.66	-14.34	Pass
High Channel	-45.97	6.04	-13.96	Pass

802.11n-20 MHz Mode:

Channel	Measured Max. Band Edge Emission (dBm)	Limit (dBm)		Verdict
		Carrier Level	Calculated 20 dBc Limit	
Low Channel	-30.54	4.78	-15.22	Pass
High Channel	-48.16	4.94	-15.07	Pass

Test Plots

802.11b LOW CHANNEL, Carrier level



802.11b LOW CHANNEL, Reference level

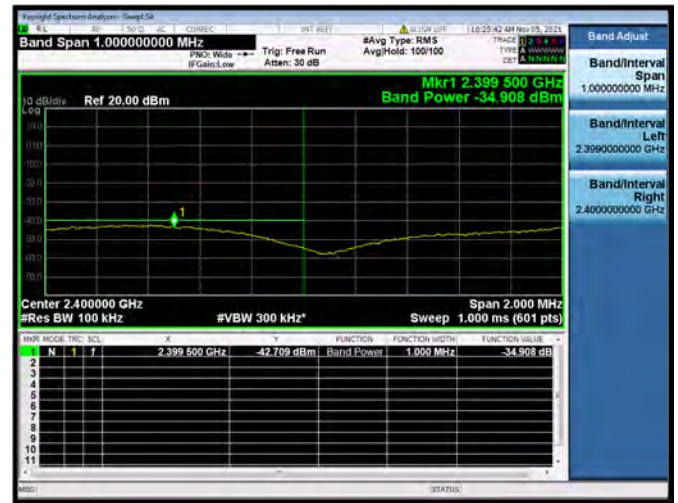

802.11b HIGH CHANNEL, Carrier level

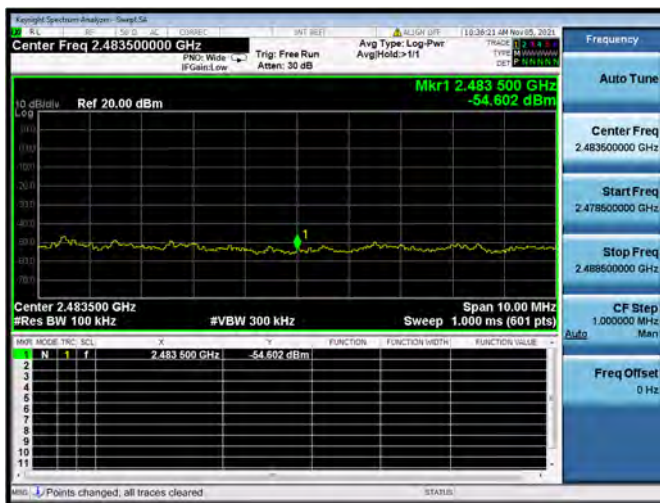

802.11b HIGH CHANNEL, Reference level

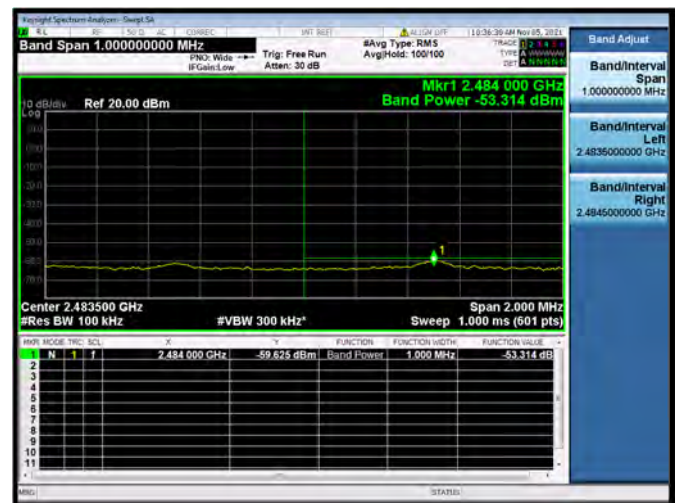

802.11g LOW CHANNEL, Carrier level



802.11g LOW CHANNEL, Reference level

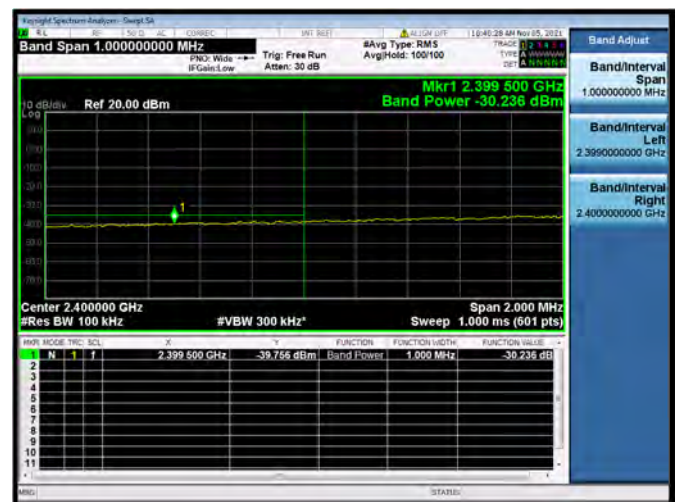

802.11g HIGH CHANNEL, Carrier level

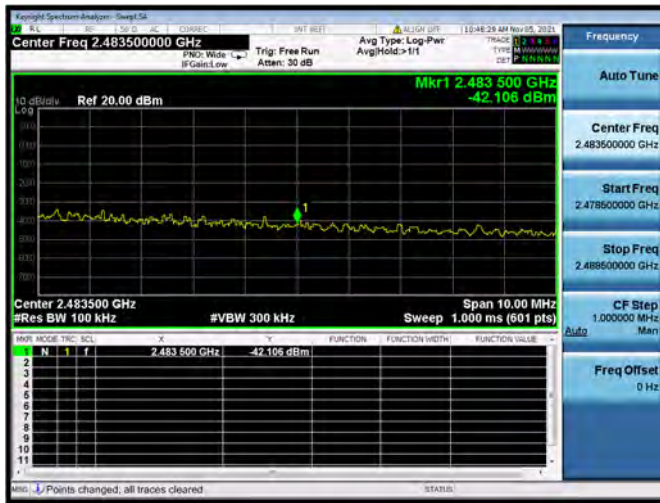

802.11g HIGH CHANNEL, Reference level

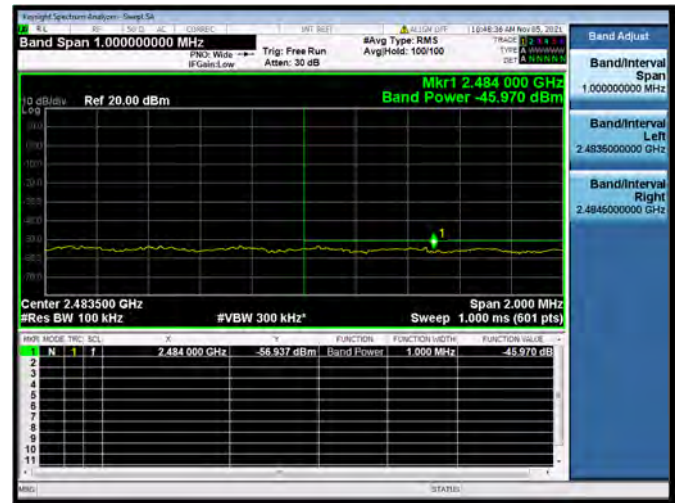

802.11n-20 MHz LOW CHANNEL, Carrier level



802.11n-20 MHz LOW CHANNEL, Reference level

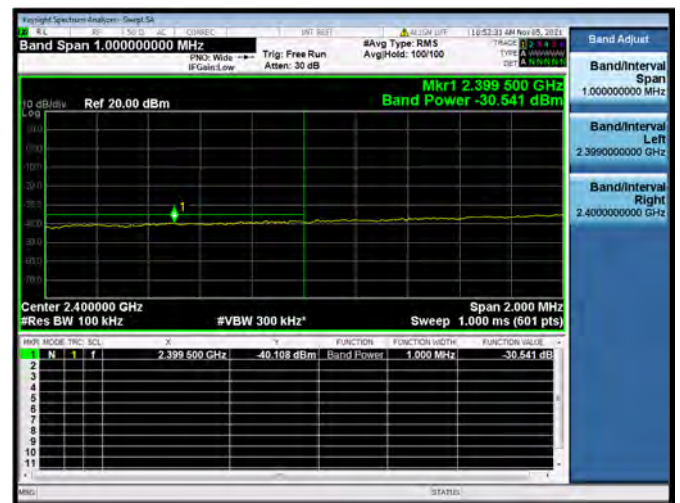

802.11n-20 MHz HIGH CHANNEL, Carrier level

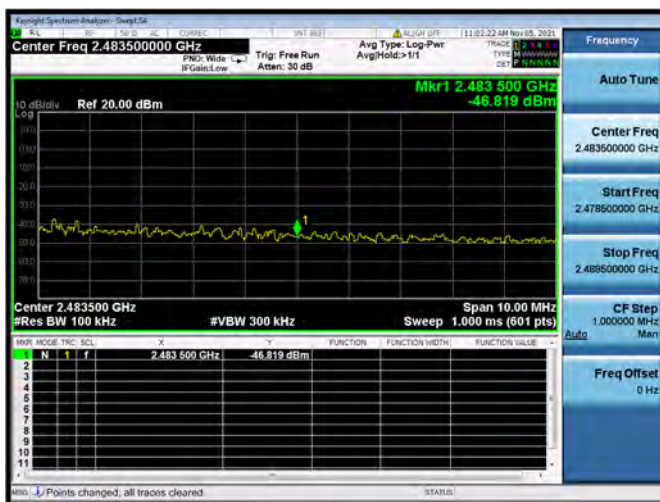

802.11n-20 MHz HIGH CHANNEL, Reference level

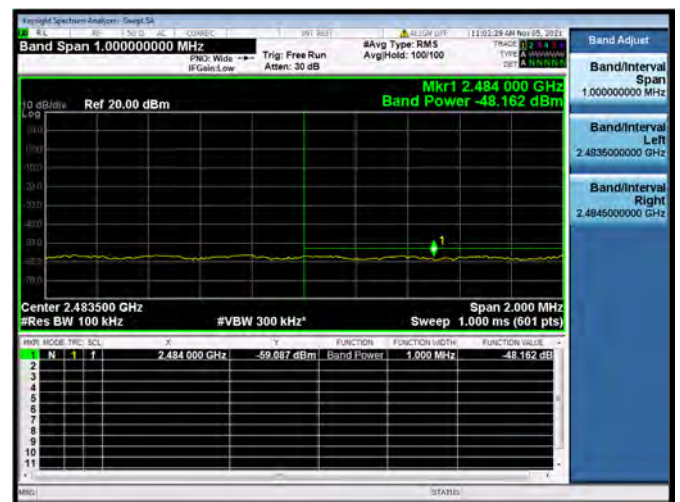

A.5 Conducted Emissions

Note 1: The EUT is working in the Normal link mode. All modes have been tested and normal link mode is worst.
 Note 2: Devices subject to Part 15 must be tested for all available U.S. voltages and frequencies (such as a nominal 120 VAC, 60 Hz and 240 VAC, 50 Hz) for which the device is capable of operation. So, The configuration 120 VAC, 60 Hz and 240 VAC, 50 Hz were tested respectively, but only the worst configuration (120 VAC, 60 Hz) shown here.

Test Data and Plots

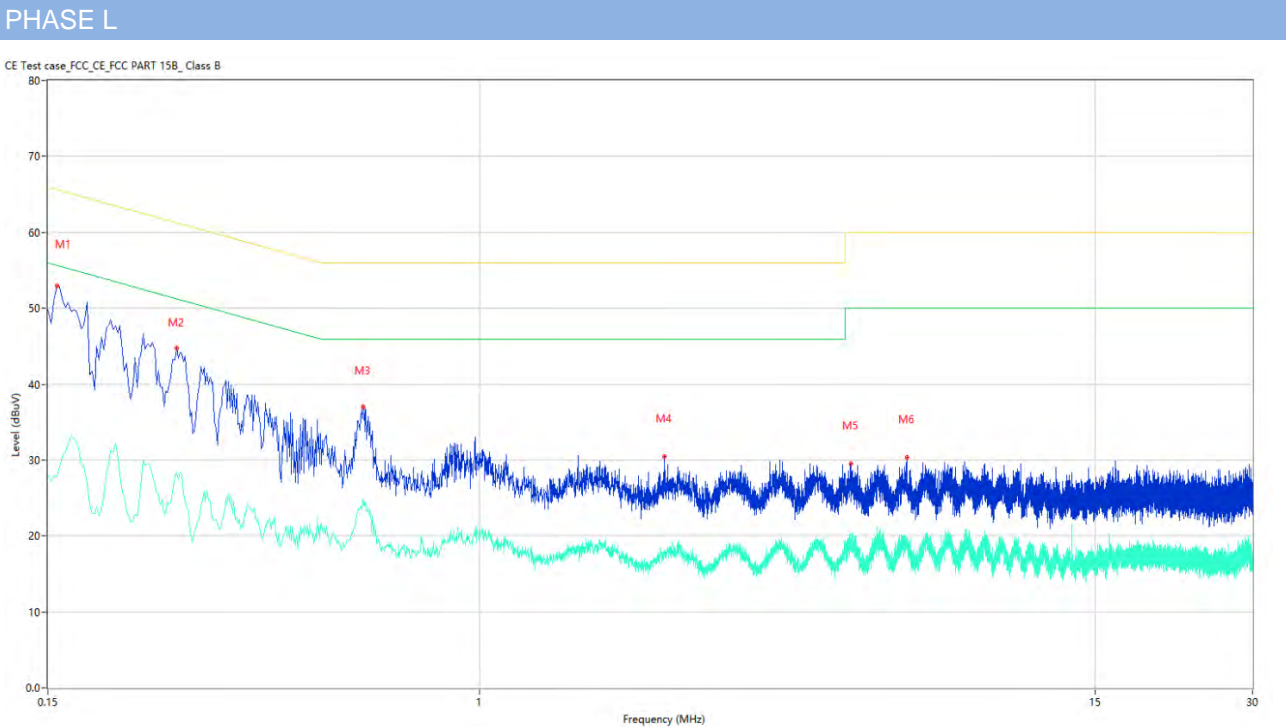

No.	Frequency (MHz)	Results (dBUV)	Factor (dB)	Limit (dBUV)	Over Limit (dB)	Detector	Line	Verdict
1	0.152	48.05	10.19	65.89	-17.84	Peak	L	Pass
1**	0.152	27.15	10.19	55.89	-28.74	AV	L	Pass
2	0.264	44.85	10.08	61.30	-16.45	Peak	L	Pass
2**	0.264	28.16	10.08	51.30	-23.14	AV	L	Pass
3	0.600	36.90	10.10	56.00	-19.10	Peak	L	Pass
3**	0.600	24.97	10.10	46.00	-21.03	AV	L	Pass
4	2.262	30.39	9.92	56.00	-25.61	Peak	L	Pass
4**	2.262	18.02	9.92	46.00	-27.98	AV	L	Pass
5	5.138	29.46	9.95	60.00	-30.54	Peak	L	Pass
5**	5.138	19.35	9.95	50.00	-30.65	AV	L	Pass
6	6.556	30.28	9.94	60.00	-29.72	Peak	L	Pass
6**	6.556	19.26	9.94	50.00	-30.74	AV	L	Pass

PHASE N

CE Test case_FCC_CE_FCC PART 15B_Class B

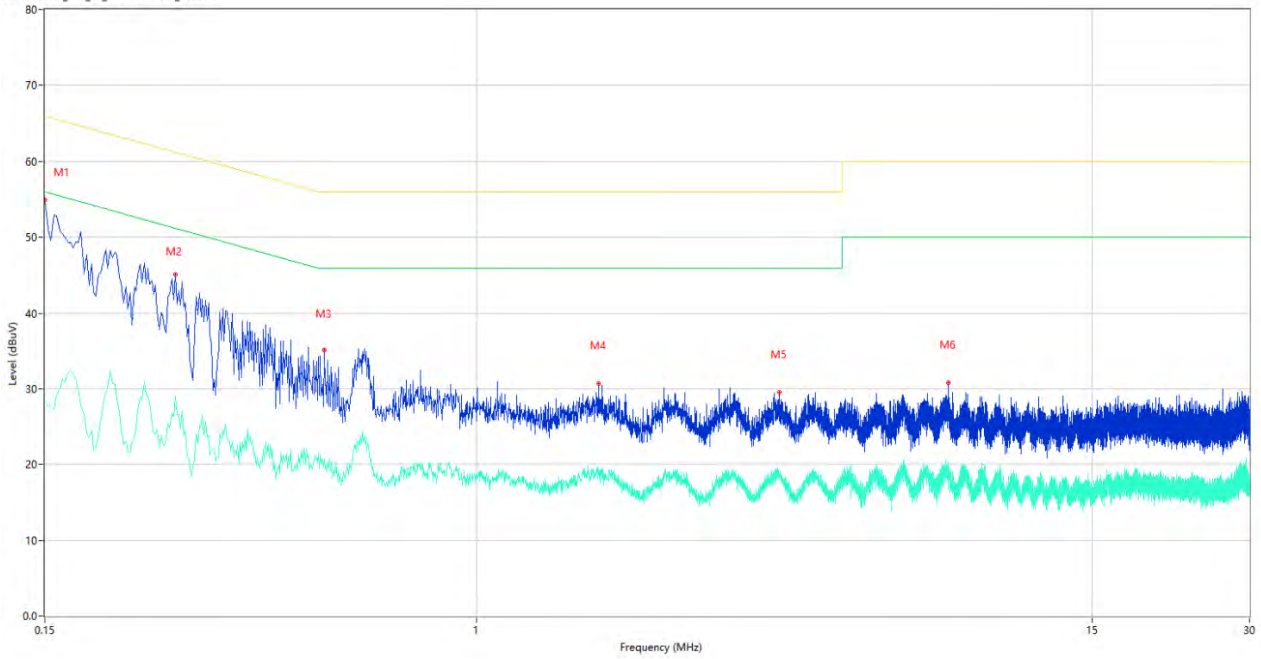

No.	Frequency (MHz)	Results (dBuV)	Factor (dB)	Limit (dBuV)	Over Limit (dB)	Detector	Line	Verdict
1	0.150	54.93	10.19	66.00	-11.07	Peak	N	Pass
1**	0.150	28.29	10.19	56.00	-27.71	AV	N	Pass
2	0.266	45.11	10.08	61.24	-16.13	Peak	N	Pass
2**	0.266	29.01	10.08	51.24	-22.23	AV	N	Pass
3	0.512	35.06	10.11	56.00	-20.94	Peak	N	Pass
3**	0.512	20.66	10.11	46.00	-25.34	AV	N	Pass
4	1.714	30.60	9.91	56.00	-25.40	Peak	N	Pass
4**	1.714	18.59	9.91	46.00	-27.41	AV	N	Pass
5	3.798	29.51	10.09	56.00	-26.49	Peak	N	Pass
5**	3.798	18.69	10.09	46.00	-27.31	AV	N	Pass
6	7.980	30.73	10.09	60.00	-29.27	Peak	N	Pass
6**	7.980	20.20	10.09	50.00	-29.80	AV	N	Pass

A.6 Radiated Emission

Note¹: The symbol of “--” in the table which means not application.

Note²: For the test data above 1 GHz, According the ANSI C63.10-2013, where limits are specified for both average and peak (or quasi-peak) detector functions, if the peak (or quasi-peak) measured value complies with the average limit, it is unnecessary to perform an average measurement.

Note³: The low frequency, which started from 9 kHz to 30 MHz, was pre-scanned and the result which was 20 dB lower than the limit line per 15.31(o) was not reported.

Note⁴: The EUT is working in the Normal link mode below 1 GHz. All modes have been tested and normal link mode is worst.

Test Data and Plots

30 MHz to 1 GHz, ANT H

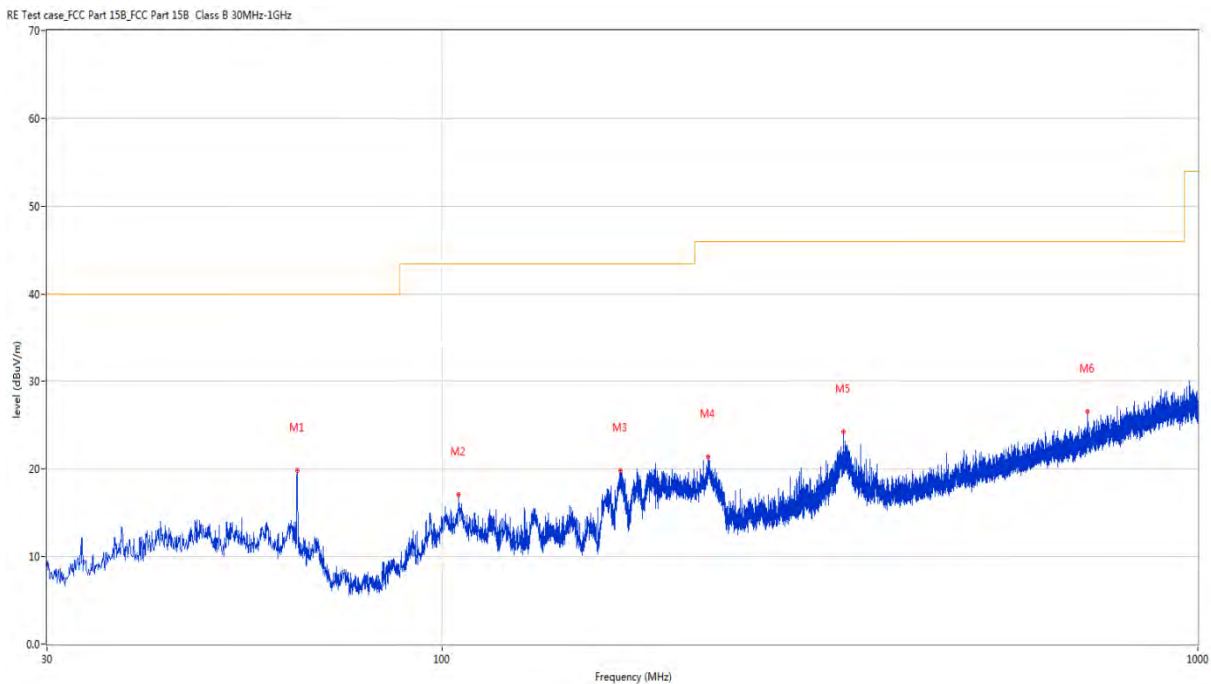

No.	Frequency (MHz)	Results (dBuV/m)	Factor (dB)	Limit (dBuV/m)	Over Limit (dB)	Detector	Table (Degree)	Height (cm)	Antenna	Verdict
1	64.289	19.77	-24.97	40.0	-20.23	Peak	177.40	200	Horizontal	Pass
2	105.224	17.07	-24.26	43.5	-26.43	Peak	360.00	200	Horizontal	Pass
3	172.348	19.79	-26.37	43.5	-23.71	Peak	86.10	100	Horizontal	Pass
4	224.970	21.36	-23.78	46.0	-24.64	Peak	255.40	100	Horizontal	Pass
5	339.478	24.17	-20.14	46.0	-21.83	Peak	242.80	100	Horizontal	Pass
6	714.238	26.50	-12.78	46.0	-19.50	Peak	107.30	100	Horizontal	Pass

30 MHz to 1 GHz, ANT V

RE Test case_FCC Part 15B_FCC Part 15B Class B 30MHz-1GHz

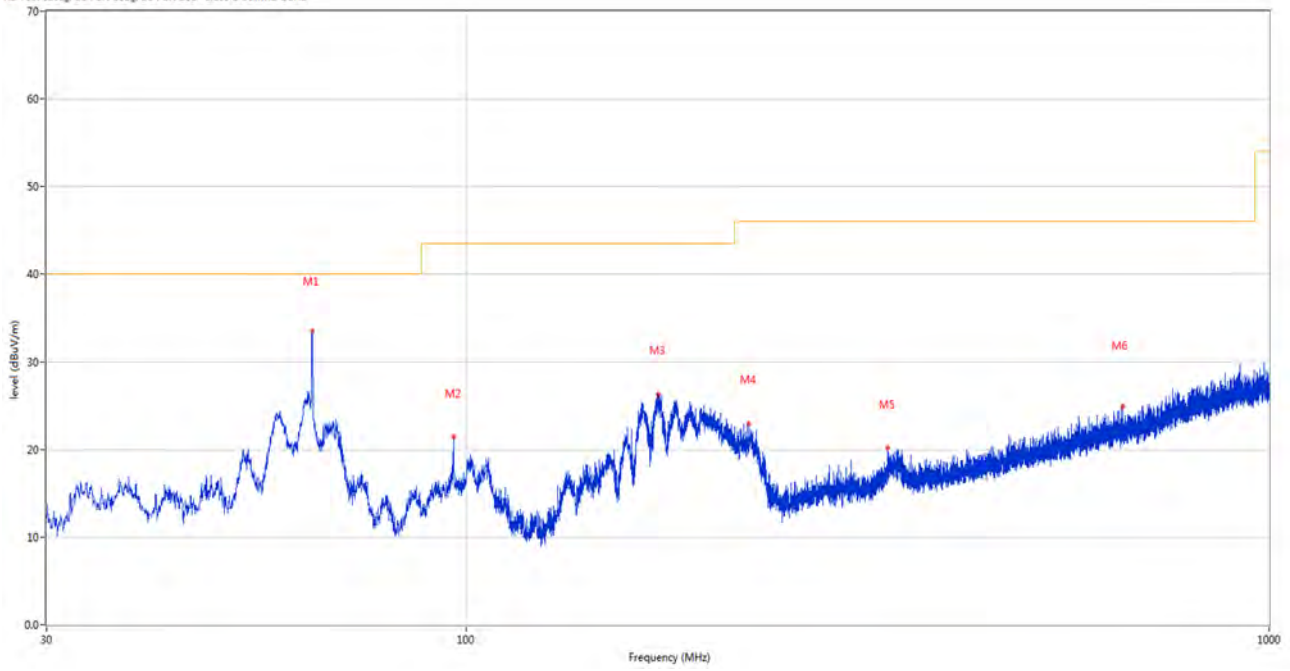

No.	Frequency (MHz)	Results (dBuV/m)	Factor (dB)	Limit (dBuV/m)	Over Limit (dB)	Detector	Table (Degree)	Height (cm)	Antenna	Verdict
1	64.289	33.49	-24.97	40.0	-6.51	Peak	196.20	100	Vertical	Pass
2	96.445	21.47	-24.78	43.5	-22.03	Peak	242.70	100	Vertical	Pass
3	173.366	26.27	-26.46	43.5	-17.23	Peak	136.50	100	Vertical	Pass
4	224.970	22.99	-23.78	46.0	-23.01	Peak	140.90	100	Vertical	Pass
5	334.629	20.22	-20.27	46.0	-25.78	Peak	0.70	200	Vertical	Pass
6	656.620	24.91	-13.60	46.0	-21.09	Peak	298.80	200	Vertical	Pass

Note 1: The marked spikes near 2400 MHz with circle should be ignored because they are Fundamental signal.

Note 2: The spurious above 18G is noise only, do not show on the report.

1 GHz to 18 GHz, ANT H 802.11b Low Channel

No.	Frequency (MHz)	Results (dBuV/m)	Factor (dB)	Limit (dBuV/m)	Over Limit (dB)	Detector	Table (Degree)	Height (cm)	Antenna	Verdict
1	1530.700	39.53	-17.59	74.0	-34.47	Peak	10.00	150	Horizontal	Pass
1**	1530.700	29.78	-17.59	54.0	-24.22	AV	10.00	150	Horizontal	Pass
2	2411.900	95.23	-12.26	74.0	21.23	Peak	7.00	150	Horizontal	N/A
2**	2411.900	91.93	-12.26	54.0	37.93	AV	7.00	150	Horizontal	N/A
3	6271.800	53.41	-0.26	74.0	-20.59	Peak	1.00	150	Horizontal	Pass
3**	6271.800	44.60	-0.26	54.0	-9.40	AV	1.00	150	Horizontal	Pass
4	7237.188	55.15	-4.18	74.0	-18.85	Peak	15.00	150	Horizontal	Pass
4**	7237.188	49.84	-4.18	54.0	-4.16	AV	15.00	150	Horizontal	Pass
5	10139.500	52.36	0.01	74.0	-21.64	Peak	3.00	150	Horizontal	Pass
5**	10139.500	43.01	0.01	54.0	-10.99	AV	3.00	150	Horizontal	Pass
6	12532.076	52.78	1.28	74.0	-21.22	Peak	5.00	150	Horizontal	Pass
6**	12532.076	43.00	1.28	54.0	-11.00	AV	5.00	150	Horizontal	Pass

1 GHz to 18 GHz, ANT V 802.11b Low Channel

No.	Frequency (MHz)	Results (dBuV/m)	Factor (dB)	Limit (dBuV/m)	Over Limit (dB)	Detector	Table (Degree)	Height (cm)	Antenna	Verdict
1	1195.200	39.98	-17.89	74.0	-34.02	Peak	12.00	150	Vertical	Pass
1**	1195.200	28.61	-17.89	54.0	-25.39	AV	12.00	150	Vertical	Pass
2	2412.000	97.78	-12.26	74.0	23.78	Peak	3.00	150	Vertical	N/A
2**	2412.000	94.75	-12.26	54.0	40.75	AV	3.00	150	Vertical	N/A
3	3204.400	46.30	-8.03	74.0	-27.70	Peak	2.00	150	Vertical	Pass
3**	3204.400	36.06	-8.03	54.0	-17.94	AV	2.00	150	Vertical	Pass
4	6685.000	54.16	-0.21	74.0	-19.84	Peak	8.00	150	Vertical	Pass
4**	6685.000	44.97	-0.21	54.0	-9.03	AV	8.00	150	Vertical	Pass
5	8591.025	50.32	-2.14	74.0	-23.68	Peak	1.00	150	Vertical	Pass
5**	8591.025	41.85	-2.14	54.0	-12.15	AV	1.00	150	Vertical	Pass
6	10936.738	51.61	-0.03	74.0	-22.39	Peak	5.00	150	Vertical	Pass
6**	10936.738	43.84	-0.03	54.0	-10.16	AV	5.00	150	Vertical	Pass

1 GHz to 18 GHz, ANT H 802.11b Middle Channel

No.	Frequency (MHz)	Results (dBuV/m)	Factor (dB)	Limit (dBuV/m)	Over Limit (dB)	Detector	Table (Degree)	Height (cm)	Antenna	Verdict
1	1312.400	39.26	-17.27	74.0	-34.74	Peak	3.00	150	Horizontal	Pass
1**	1312.400	29.18	-17.27	54.0	-24.82	AV	3.00	150	Horizontal	Pass
2	2437.000	96.43	-12.65	74.0	22.43	Peak	12.00	150	Horizontal	N/A
2**	2437.000	93.01	-12.65	54.0	39.01	AV	12.00	150	Horizontal	N/A
3	5545.600	52.55	-2.06	74.0	-21.45	Peak	6.00	150	Horizontal	Pass
3**	5545.600	42.47	-2.06	54.0	-11.53	AV	6.00	150	Horizontal	Pass
4	7310.213	51.61	-3.70	74.0	-22.39	Peak	1.00	150	Horizontal	Pass
4**	7310.213	47.29	-3.70	54.0	-6.71	AV	1.00	150	Horizontal	Pass
5	10491.975	51.60	-0.80	74.0	-22.40	Peak	4.00	150	Horizontal	Pass
5**	10491.975	43.09	-0.80	54.0	-10.91	AV	4.00	150	Horizontal	Pass
6	12106.575	53.50	0.59	74.0	-20.50	Peak	4.00	150	Horizontal	Pass
6**	12106.575	43.13	0.59	54.0	-10.87	AV	4.00	150	Horizontal	Pass

1 GHz to 18 GHz, ANT V 802.11b Middle Channel

No.	Frequency (MHz)	Results (dBuV/m)	Factor (dB)	Limit (dBuV/m)	Over Limit (dB)	Detector	Table (Degree)	Height (cm)	Antenna	Verdict
1	1201.300	38.35	-17.87	74.0	-35.65	Peak	2.00	150	Vertical	Pass
1**	1201.300	28.82	-17.87	54.0	-25.18	AV	2.00	150	Vertical	Pass
2	2437.000	98.87	-12.65	74.0	24.87	Peak	15.00	150	Vertical	N/A
2**	2437.000	95.83	-12.65	54.0	41.83	AV	15.00	150	Vertical	N/A
3	5527.000	52.17	-2.37	74.0	-21.83	Peak	9.00	150	Vertical	Pass
3**	5527.000	42.43	-2.37	54.0	-11.57	AV	9.00	150	Vertical	Pass
4	7311.650	50.85	-3.70	74.0	-23.15	Peak	10.00	150	Vertical	Pass
4**	7311.650	46.72	-3.70	54.0	-7.28	AV	10.00	150	Vertical	Pass
5	10494.850	51.77	-0.82	74.0	-22.23	Peak	15.00	150	Vertical	Pass
5**	10494.850	42.08	-0.82	54.0	-11.92	AV	15.00	150	Vertical	Pass
6	11653.763	53.28	-0.06	74.0	-20.72	Peak	2.00	150	Vertical	Pass
6**	11653.763	42.86	-0.06	54.0	-11.14	AV	2.00	150	Vertical	Pass

1 GHz to 18 GHz, ANT H 802.11b High Channel

No.	Frequency (MHz)	Results (dBuV/m)	Factor (dB)	Limit (dBuV/m)	Over Limit (dB)	Detector	Table (Degree)	Height (cm)	Antenna	Verdict
1	1563.100	39.36	-17.48	74.0	-34.64	Peak	3.00	150	Horizontal	Pass
1**	1563.100	32.82	-17.48	54.0	-21.18	AV	3.00	150	Horizontal	Pass
2	2460.800	87.29	-12.75	74.0	13.29	Peak	7.00	150	Horizontal	N/A
2**	2460.800	84.39	-12.75	54.0	30.39	AV	7.00	150	Horizontal	N/A
3	4853.600	50.89	-3.16	74.0	-23.11	Peak	10.00	150	Horizontal	Pass
3**	4853.600	40.67	-3.16	54.0	-13.33	AV	10.00	150	Horizontal	Pass
4	7384.675	50.31	-3.87	74.0	-23.69	Peak	4.00	150	Horizontal	Pass
4**	7384.675	43.41	-3.87	54.0	-10.59	AV	4.00	150	Horizontal	Pass
5	10151.576	52.09	-0.05	74.0	-21.91	Peak	4.00	150	Horizontal	Pass
5**	10151.576	43.05	-0.05	54.0	-10.95	AV	4.00	150	Horizontal	Pass
6	12236.526	53.81	1.13	74.0	-20.19	Peak	10.00	150	Horizontal	Pass
6**	12236.526	43.85	1.13	54.0	-10.15	AV	10.00	150	Horizontal	Pass

1 GHz to 18 GHz, ANT V 802.11b High Channel

No.	Frequency (MHz)	Results (dBuV/m)	Factor (dB)	Limit (dBuV/m)	Over Limit (dB)	Detector	Table (Degree)	Height (cm)	Antenna	Verdict
1	1196.500	41.03	-17.94	74.0	-32.97	Peak	5.00	150	Vertical	Pass
1**	1196.500	35.14	-17.94	54.0	-18.86	AV	5.00	150	Vertical	Pass
2	2463.100	99.01	-12.80	74.0	25.01	Peak	1.00	150	Vertical	N/A
2**	2463.100	96.38	-12.80	54.0	42.38	AV	1.00	150	Vertical	N/A
3	5656.200	52.46	-2.30	74.0	-21.54	Peak	12.00	150	Vertical	Pass
3**	5656.200	41.87	-2.30	54.0	-12.13	AV	12.00	150	Vertical	Pass
4	7386.687	51.19	-3.94	74.0	-22.81	Peak	9.00	150	Vertical	Pass
4**	7386.687	46.21	-3.94	54.0	-7.79	AV	9.00	150	Vertical	Pass
5	10268.588	51.57	0.37	74.0	-22.43	Peak	1.00	150	Vertical	Pass
5**	10268.588	41.66	0.37	54.0	-12.34	AV	1.00	150	Vertical	Pass
6	12879.938	53.57	1.57	74.0	-20.43	Peak	11.00	150	Vertical	Pass
6**	12879.938	45.21	1.57	54.0	-8.79	AV	11.00	150	Vertical	Pass

1 GHz to 18 GHz, ANT H 802.11g Low Channel

No.	Frequency (MHz)	Results (dBuV/m)	Factor (dB)	Limit (dBuV/m)	Over Limit (dB)	Detector	Table (Degree)	Height (cm)	Antenna	Verdict
1	1726.300	46.26	-17.16	74.0	-27.74	Peak	60.00	150	Horizontal	Pass
1**	1726.300	30.29	-17.16	54.0	-23.71	AV	60.00	150	Horizontal	Pass
2	2409.600	100.10	-12.25	74.0	26.10	Peak	181.00	150	Horizontal	N/A
2**	2409.600	92.32	-12.25	54.0	38.32	AV	181.00	150	Horizontal	N/A
3	5013.200	51.09	-3.15	74.0	-22.91	Peak	185.00	150	Horizontal	Pass
3**	5013.200	41.48	-3.15	54.0	-12.52	AV	185.00	150	Horizontal	Pass
4	7233.450	57.45	-4.19	74.0	-16.55	Peak	49.00	150	Horizontal	Pass
4**	7233.450	49.291	-4.19	54.0	-4.709	AV	49.00	150	Horizontal	Pass
5	8502.762	51.26	-1.33	74.0	-22.74	Peak	49.00	150	Horizontal	Pass
5**	8502.762	40.78	-1.33	54.0	-13.22	AV	49.00	150	Horizontal	Pass
6	11664.687	53.05	0.17	74.0	-20.95	Peak	138.00	150	Horizontal	Pass
6**	11664.687	44.08	0.17	54.0	-9.92	AV	138.00	150	Horizontal	Pass

1 GHz to 18 GHz, ANT V 802.11g Low Channel

No.	Frequency (MHz)	Results (dBuV/m)	Factor (dB)	Limit (dBuV/m)	Over Limit (dB)	Detector	Table (Degree)	Height (cm)	Antenna	Verdict
1	1793.300	47.32	-16.83	74.0	-26.68	Peak	222.00	150	Vertical	Pass
1**	1793.300	33.73	-16.83	54.0	-20.27	AV	222.00	150	Vertical	Pass
2	2409.400	102.54	-12.25	74.0	28.54	Peak	206.00	150	Vertical	N/A
2**	2409.400	95.16	-12.25	54.0	41.16	AV	206.00	150	Vertical	N/A
3	4247.000	52.73	-4.91	74.0	-21.27	Peak	339.00	150	Vertical	Pass
3**	4247.000	40.01	-4.91	54.0	-13.99	AV	339.00	150	Vertical	Pass
4	7235.463	59.33	-4.24	74.0	-14.67	Peak	125.00	150	Vertical	Pass
4**	7235.463	49.091	-4.24	54.0	-4.909	AV	125.00	150	Vertical	Pass
5	9647.875	52.28	-0.14	74.0	-21.72	Peak	0.00	150	Vertical	Pass
5**	9647.875	46.07	-0.14	54.0	-7.93	AV	0.00	150	Vertical	Pass
6	12055.975	56.70	1.01	74.0	-17.30	Peak	34.00	150	Vertical	Pass
6**	12055.975	48.31	1.01	54.0	-5.69	AV	34.00	150	Vertical	Pass

1 GHz to 18 GHz, ANT H 802.11g Middle Channel

No.	Frequency (MHz)	Results (dBuV/m)	Factor (dB)	Limit (dBuV/m)	Over Limit (dB)	Detector	Table (Degree)	Height (cm)	Antenna	Verdict
1	1197.400	43.23	-17.89	74.0	-30.77	Peak	179.00	150	Horizontal	Pass
1**	1197.400	33.03	-17.89	54.0	-20.97	AV	179.00	150	Horizontal	Pass
2	2440.100	104.39	-12.70	74.0	30.39	Peak	171.00	150	Horizontal	N/A
2**	2440.100	97.22	-12.70	54.0	43.22	AV	171.00	150	Horizontal	N/A
3	6302.200	53.85	-0.96	74.0	-20.15	Peak	272.00	150	Horizontal	Pass
3**	6302.200	43.74	-0.96	54.0	-10.26	AV	272.00	150	Horizontal	Pass
4	7309.350	56.89	-3.62	74.0	-17.11	Peak	271.00	150	Horizontal	Pass
4**	7309.350	47.784	-3.62	54.0	-6.216	AV	271.00	150	Horizontal	Pass
5	10351.674	51.64	0.03	74.0	-22.36	Peak	360.00	150	Horizontal	Pass
5**	10351.674	41.89	0.03	54.0	-12.11	AV	360.00	150	Horizontal	Pass
6	12271.600	53.04	1.50	74.0	-20.96	Peak	326.00	150	Horizontal	Pass
6**	12271.600	44.38	1.50	54.0	-9.62	AV	326.00	150	Horizontal	Pass

1 GHz to 18 GHz, ANT V 802.11g Middle Channel

No.	Frequency (MHz)	Results (dBuV/m)	Factor (dB)	Limit (dBuV/m)	Over Limit (dB)	Detector	Table (Degree)	Height (cm)	Antenna	Verdict
1	1186.200	41.81	-17.99	74.0	-32.19	Peak	99.00	150	Vertical	Pass
1**	1186.200	31.20	-17.99	54.0	-22.80	AV	99.00	150	Vertical	Pass
2	2438.300	103.39	-12.60	74.0	29.39	Peak	307.00	150	Vertical	N/A
2**	2438.300	95.94	-12.60	54.0	41.94	AV	307.00	150	Vertical	N/A
3	5118.400	51.89	-2.25	74.0	-22.11	Peak	226.00	150	Vertical	Pass
3**	5118.400	41.90	-2.25	54.0	-12.10	AV	226.00	150	Vertical	Pass
4	7306.187	55.78	-3.69	74.0	-18.22	Peak	233.00	150	Vertical	Pass
4**	7306.187	49.316	-3.69	54.0	-4.684	AV	233.00	150	Vertical	Pass
5	10344.776	51.90	0.04	74.0	-22.10	Peak	156.00	150	Vertical	Pass
5**	10344.776	42.41	0.04	54.0	-11.59	AV	156.00	150	Vertical	Pass
6	11935.799	53.27	1.69	74.0	-20.73	Peak	326.00	150	Vertical	Pass
6**	11935.799	44.96	1.69	54.0	-9.04	AV	326.00	150	Vertical	Pass

1 GHz to 18 GHz, ANT H 802.11g High Channel

No.	Frequency (MHz)	Results (dBuV/m)	Factor (dB)	Limit (dBuV/m)	Over Limit (dB)	Detector	Table (Degree)	Height (cm)	Antenna	Verdict
1	1574.300	41.71	-17.57	74.0	-32.29	Peak	1.00	150	Horizontal	Pass
1**	1574.300	32.20	-17.57	54.0	-21.80	AV	1.00	150	Horizontal	Pass
2	2462.100	94.21	-12.77	74.0	20.21	Peak	4.00	150	Horizontal	N/A
2**	2462.100	85.32	-12.77	54.0	31.32	AV	4.00	150	Horizontal	N/A
3	6144.800	52.64	-1.83	74.0	-21.36	Peak	15.00	150	Horizontal	Pass
3**	6144.800	43.60	-1.83	54.0	-10.40	AV	15.00	150	Horizontal	Pass
4	7398.762	48.41	-4.43	74.0	-25.59	Peak	1.00	150	Horizontal	Pass
4**	7398.762	40.41	-4.43	54.0	-13.59	AV	1.00	150	Horizontal	Pass
5	10328.100	51.64	-0.02	74.0	-22.36	Peak	13.00	150	Horizontal	Pass
5**	10328.100	43.13	-0.02	54.0	-10.87	AV	13.00	150	Horizontal	Pass
6	12448.700	53.16	1.87	74.0	-20.84	Peak	5.00	150	Horizontal	Pass
6**	12448.700	43.24	1.87	54.0	-10.76	AV	5.00	150	Horizontal	Pass

1 GHz to 18 GHz, ANT V 802.11g High Channel

No.	Frequency (MHz)	Results (dBuV/m)	Factor (dB)	Limit (dBuV/m)	Over Limit (dB)	Detector	Table (Degree)	Height (cm)	Antenna	Verdict
1	1324.300	41.70	-17.46	74.0	-32.30	Peak	11.00	150	Vertical	Pass
1**	1324.300	31.74	-17.46	54.0	-22.26	AV	11.00	150	Vertical	Pass
2	2464.600	101.49	-12.75	74.0	27.49	Peak	1.00	150	Vertical	N/A
2**	2464.600	94.07	-12.75	54.0	40.07	AV	1.00	150	Vertical	N/A
3	6050.200	52.87	-2.02	74.0	-21.13	Peak	10.00	150	Vertical	Pass
3**	6050.200	43.16	-2.02	54.0	-10.84	AV	10.00	150	Vertical	Pass
4	7378.062	56.87	-3.71	74.0	-17.13	Peak	15.00	150	Vertical	Pass
4**	7378.062	49.26	-3.71	54.0	-4.74	AV	15.00	150	Vertical	Pass
5	10263.987	51.98	0.49	74.0	-22.02	Peak	11.00	150	Vertical	Pass
5**	10263.987	41.79	0.49	54.0	-12.21	AV	11.00	150	Vertical	Pass
6	12226.750	52.61	1.31	74.0	-21.39	Peak	5.00	150	Vertical	Pass
6**	12226.750	43.64	1.31	54.0	-10.36	AV	5.00	150	Vertical	Pass

1 GHz to 18 GHz, ANT H 802.11n20 Low Channel

No.	Frequency (MHz)	Results (dBuV/m)	Factor (dB)	Limit (dBuV/m)	Over Limit (dB)	Detector	Table (Degree)	Height (cm)	Antenna	Verdict
1	1198.300	43.11	-17.83	74.0	-30.89	Peak	38.00	150	Horizontal	Pass
1**	1198.300	33.03	-17.83	54.0	-20.97	AV	38.00	150	Horizontal	Pass
2	2413.400	102.59	-12.26	74.0	28.59	Peak	172.00	150	Horizontal	N/A
2**	2413.400	95.29	-12.26	54.0	41.29	AV	172.00	150	Horizontal	N/A
3	6270.600	53.76	-0.33	74.0	-20.24	Peak	287.00	150	Horizontal	Pass
3**	6270.600	44.04	-0.33	54.0	-9.96	AV	287.00	150	Horizontal	Pass
4	7242.075	57.80	-4.05	74.0	-16.2	Peak	105.00	150	Horizontal	Pass
4**	7242.075	50.227	-4.05	54.0	-3.773	AV	105.00	150	Horizontal	Pass
5	10356.275	51.62	0.05	74.0	-22.38	Peak	360.00	150	Horizontal	Pass
5**	10356.275	41.64	0.05	54.0	-12.36	AV	360.00	150	Horizontal	Pass
6	12507.062	53.35	1.65	74.0	-20.65	Peak	14.00	150	Horizontal	Pass
6**	12507.062	43.60	1.65	54.0	-10.40	AV	14.00	150	Horizontal	Pass

1 GHz to 18 GHz, ANT V 802.11n20 Low Channel

No.	Frequency (MHz)	Results (dBuV/m)	Factor (dB)	Limit (dBuV/m)	Over Limit (dB)	Detector	Table (Degree)	Height (cm)	Antenna	Verdict
1	1196.600	42.42	-17.94	74.0	-31.58	Peak	91.00	150	Vertical	Pass
1**	1196.600	35.48	-17.94	54.0	-18.52	AV	91.00	150	Vertical	Pass
2	2409.900	102.17	-12.24	74.0	28.17	Peak	354.00	150	Vertical	N/A
2**	2409.900	94.75	-12.24	54.0	40.75	AV	354.00	150	Vertical	N/A
3	5940.600	52.64	-1.85	74.0	-21.36	Peak	248.00	150	Vertical	Pass
3**	5940.600	43.82	-1.85	54.0	-10.18	AV	248.00	150	Vertical	Pass
4	7232.875	57.35	-4.19	74.0	-16.65	Peak	86.00	150	Vertical	Pass
4**	7232.875	49.631	-4.19	54.0	-4.369	AV	86.00	150	Vertical	Pass
5	10544.012	51.96	-0.63	74.0	-22.04	Peak	229.00	150	Vertical	Pass
5**	10544.012	42.86	-0.63	54.0	-11.14	AV	229.00	150	Vertical	Pass
6	12437.775	53.99	1.74	74.0	-20.01	Peak	0.00	150	Vertical	Pass
6**	12437.775	44.08	1.74	54.0	-9.92	AV	0.00	150	Vertical	Pass

1 GHz to 18 GHz, ANT H 802.11n20 Middle Channel

No.	Frequency (MHz)	Results (dBuV/m)	Factor (dB)	Limit (dBuV/m)	Over Limit (dB)	Detector	Table (Degree)	Height (cm)	Antenna	Verdict
1	1202.600	43.39	-17.86	74.0	-30.61	Peak	246.00	150	Horizontal	Pass
1**	1202.600	31.92	-17.86	54.0	-22.08	AV	246.00	150	Horizontal	Pass
2	2438.700	103.43	-12.62	74.0	29.43	Peak	165.00	150	Horizontal	N/A
2**	2438.700	96.82	-12.62	54.0	42.82	AV	165.00	150	Horizontal	N/A
3	6211.600	53.48	-2.12	74.0	-20.52	Peak	156.00	150	Horizontal	Pass
3**	6211.600	43.66	-2.12	54.0	-10.34	AV	156.00	150	Horizontal	Pass
4	7300.438	54.65	-3.68	74.0	-19.35	Peak	72.00	150	Horizontal	Pass
4**	7300.438	46.585	-3.68	54.0	-7.415	AV	72.00	150	Horizontal	Pass
5	10363.750	52.24	0.10	74.0	-21.76	Peak	91.00	150	Horizontal	Pass
5**	10363.750	42.72	0.10	54.0	-11.28	AV	91.00	150	Horizontal	Pass
6	11950.175	52.61	1.39	74.0	-21.39	Peak	163.00	150	Horizontal	Pass
6**	11950.175	43.53	1.39	54.0	-10.47	AV	163.00	150	Horizontal	Pass

1 GHz to 18 GHz, ANT V 802.11n20 Middle Channel

No.	Frequency (MHz)	Results (dBuV/m)	Factor (dB)	Limit (dBuV/m)	Over Limit (dB)	Detector	Table (Degree)	Height (cm)	Antenna	Verdict
1	1193.300	44.53	-17.89	74.0	-29.47	Peak	61.00	150	Vertical	Pass
1**	1193.300	32.54	-17.89	54.0	-21.46	AV	61.00	150	Vertical	Pass
2	2435.100	102.96	-12.83	74.0	28.96	Peak	5.00	150	Vertical	N/A
2**	2435.100	95.89	-12.83	54.0	41.89	AV	5.00	150	Vertical	N/A
3	6270.600	53.78	-0.33	74.0	-20.22	Peak	261.00	150	Vertical	Pass
3**	6270.600	44.50	-0.33	54.0	-9.50	AV	261.00	150	Vertical	Pass
4	7300.725	56.27	-3.67	74.0	-17.73	Peak	272.00	150	Vertical	Pass
4**	7300.725	47.425	-3.67	54.0	-6.575	AV	272.00	150	Vertical	Pass
5	11017.525	51.86	-0.75	74.0	-22.14	Peak	290.00	150	Vertical	Pass
5**	11017.525	42.82	-0.75	54.0	-11.18	AV	290.00	150	Vertical	Pass
6	12338.588	54.29	1.30	74.0	-19.71	Peak	0.00	150	Vertical	Pass
6**	12338.588	44.33	1.30	54.0	-9.67	AV	0.00	150	Vertical	Pass

1 GHz to 18 GHz, ANT H 802.11n20 High Channel

No.	Frequency (MHz)	Results (dBuV/m)	Factor (dB)	Limit (dBuV/m)	Over Limit (dB)	Detector	Table (Degree)	Height (cm)	Antenna	Verdict
1	1202.400	42.80	-17.86	74.0	-31.20	Peak	250.00	150	Horizontal	Pass
1**	1202.400	32.01	-17.86	54.0	-21.99	AV	250.00	150	Horizontal	Pass
2	2464.400	104.24	-12.76	74.0	30.24	Peak	177.00	150	Horizontal	N/A
2**	2464.400	97.05	-12.76	54.0	43.05	AV	177.00	150	Horizontal	N/A
3	5837.800	53.19	-1.88	74.0	-20.81	Peak	135.00	150	Horizontal	Pass
3**	5837.800	43.21	-1.88	54.0	-10.79	AV	135.00	150	Horizontal	Pass
4	7377.775	52.17	-3.71	74.0	-21.83	Peak	195.00	150	Horizontal	Pass
4**	7377.775	50.49	-3.71	54.0	-3.51	AV	195.00	150	Horizontal	Pass
5	10478.463	52.06	-0.86	74.0	-21.94	Peak	68.00	150	Horizontal	Pass
5**	10478.463	42.23	-0.86	54.0	-11.77	AV	68.00	150	Horizontal	Pass
6	12833.212	53.95	1.21	74.0	-20.05	Peak	74.00	150	Horizontal	Pass
6**	12833.212	45.17	1.21	54.0	-8.83	AV	74.00	150	Horizontal	Pass

1 GHz to 18 GHz, ANT V 802.11n20 High Channel

No.	Frequency (MHz)	Results (dBuV/m)	Factor (dB)	Limit (dBuV/m)	Over Limit (dB)	Detector	Table (Degree)	Height (cm)	Antenna	Verdict
1	1197.900	43.78	-17.86	74.0	-30.22	Peak	125.00	150	Vertical	Pass
1**	1197.900	36.87	-17.86	54.0	-17.13	AV	125.00	150	Vertical	Pass
2	2465.400	103.07	-12.72	74.0	29.07	Peak	336.00	150	Vertical	N/A
2**	2465.400	96.33	-12.72	54.0	42.33	AV	336.00	150	Vertical	N/A
3	5525.000	51.81	-2.44	74.0	-22.19	Peak	52.00	150	Vertical	Pass
3**	5525.000	42.54	-2.44	54.0	-11.46	AV	52.00	150	Vertical	Pass
4	7378.925	61.65	-3.66	74.0	-12.35	Peak	303.00	150	Vertical	Pass
4**	7378.925	47.598	-3.66	54.0	-6.402	AV	303.00	150	Vertical	Pass
5	10328.674	51.76	-0.01	74.0	-22.24	Peak	246.00	150	Vertical	Pass
5**	10328.674	42.47	-0.01	54.0	-11.53	AV	246.00	150	Vertical	Pass
6	12302.937	53.38	1.42	74.0	-20.62	Peak	34.00	150	Vertical	Pass
6**	12302.937	44.88	1.42	54.0	-9.12	AV	34.00	150	Vertical	Pass

A.7 Band Edge (Restricted-band band-edge)

Test Data

Note 1: The lowest and highest channels are tested to verify the band edge emissions. Please refer to the following the plots for emissions values.

Note 2: The test data all are tested in the vertical and horizontal antenna which the trace is max hold. So these plots have shown the worst case.

Note 3: According the ANSI C63.10-2013, where limits are specified for both average and peak (or quasi-peak) detector functions, if the peak (or quasi-peak) measured value complies with the average limit, it is unnecessary to perform an average measurement.

802.11b LOW CHANNEL

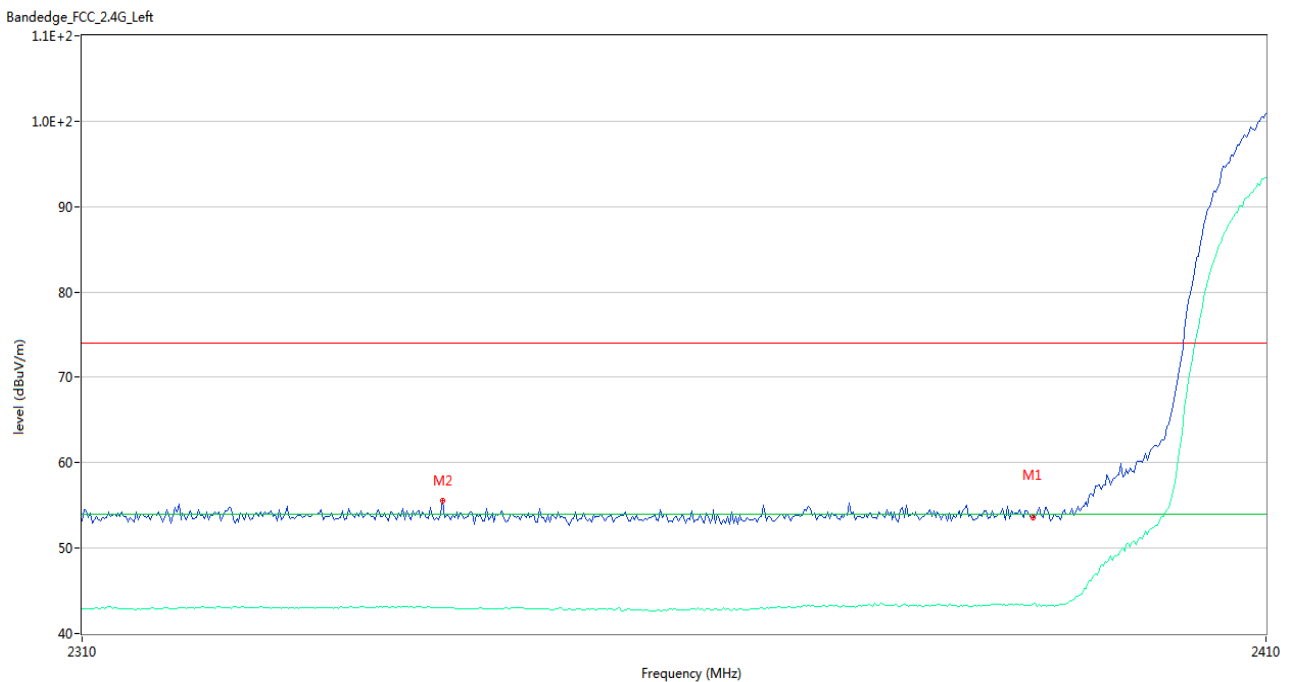

No.	Frequency (MHz)	Results (dBuV/m)	Factor (dB)	Limit (dBuV/m)	Over Limit (dB)	Detector	Table (Degree)	Height (cm)	Antenna	Verdict
1	2390.000	53.59	-0.50	74.0	-20.41	Peak	168.00	150	Horizontal	Pass
1**	2390.000	43.39	-0.50	54.0	-10.61	AV	168.00	150	Horizontal	Pass
2	2340.000	55.50	-0.65	74.0	-18.50	Peak	168.00	150	Horizontal	Pass
2**	2340.000	42.98	-0.65	54.0	-11.02	AV	168.00	150	Horizontal	Pass

802.11b HIGH CHANNEL

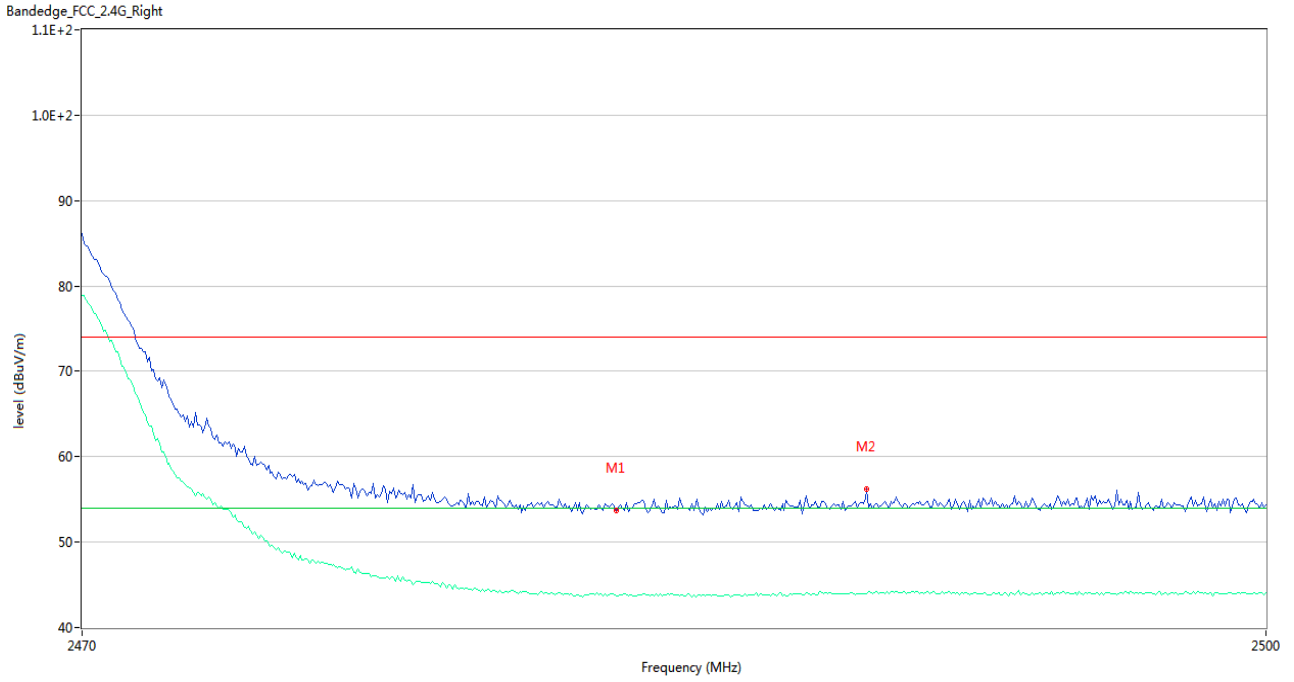

No.	Frequency (MHz)	Results (dBuV/m)	Factor (dB)	Limit (dBuV/m)	Over Limit (dB)	Detector	Table (Degree)	Height (cm)	Antenna	Verdict
1	2483.500	53.68	-0.36	74.0	-20.32	Peak	348.00	150	Horizontal	Pass
1**	2483.500	43.67	-0.36	54.0	-10.33	AV	348.00	150	Horizontal	Pass
2	2489.850	56.24	-0.11	74.0	-17.76	Peak	101.00	150	Horizontal	Pass
2**	2489.850	43.93	-0.11	54.0	-10.07	AV	101.00	150	Horizontal	Pass

802.11g LOW CHANNEL

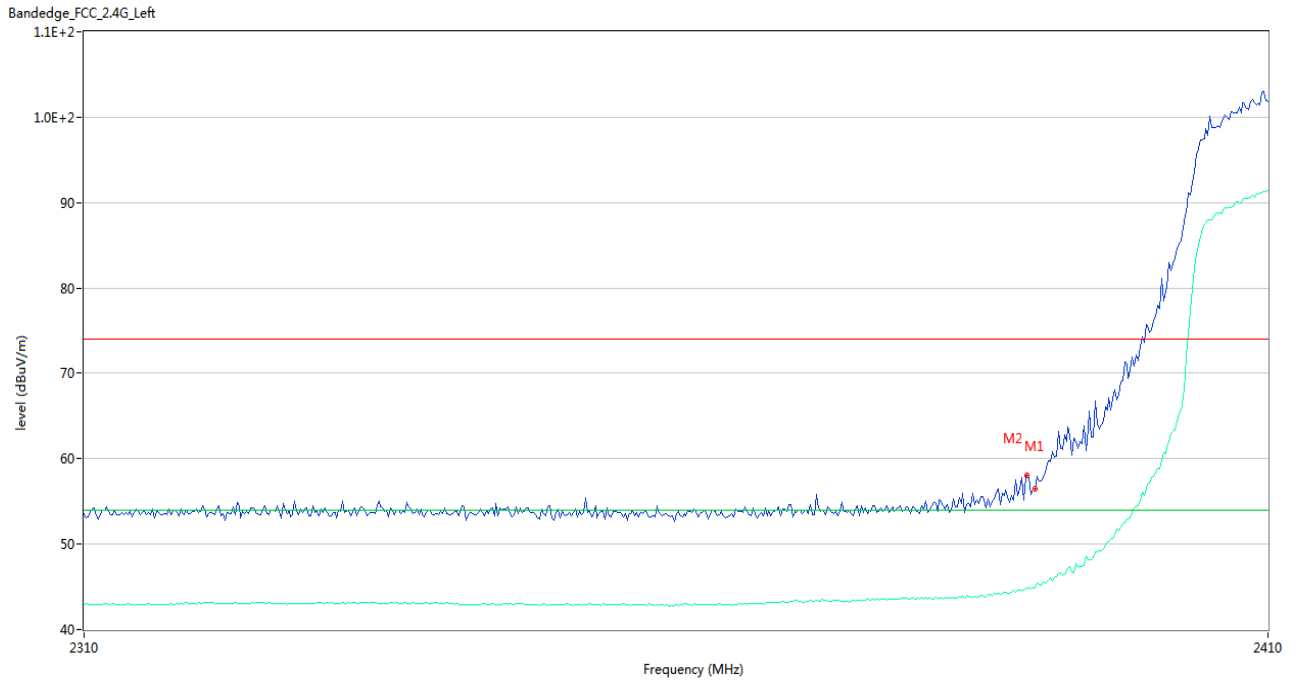

No.	Frequency (MHz)	Results (dBuV/m)	Factor (dB)	Limit (dBuV/m)	Over Limit (dB)	Detector	Table (Degree)	Height (cm)	Antenna	Verdict
1	2390.000	56.43	-0.50	74.0	-17.57	Peak	239.00	150	Horizontal	Pass
1**	2390.000	44.91	-0.50	54.0	-9.09	AV	239.00	150	Horizontal	Pass
2	2389.333	58.05	-0.49	74.0	-15.95	Peak	308.00	150	Horizontal	Pass
2**	2389.333	44.73	-0.49	54.0	-9.27	AV	308.00	150	Horizontal	Pass

802.11g HIGH CHANNEL

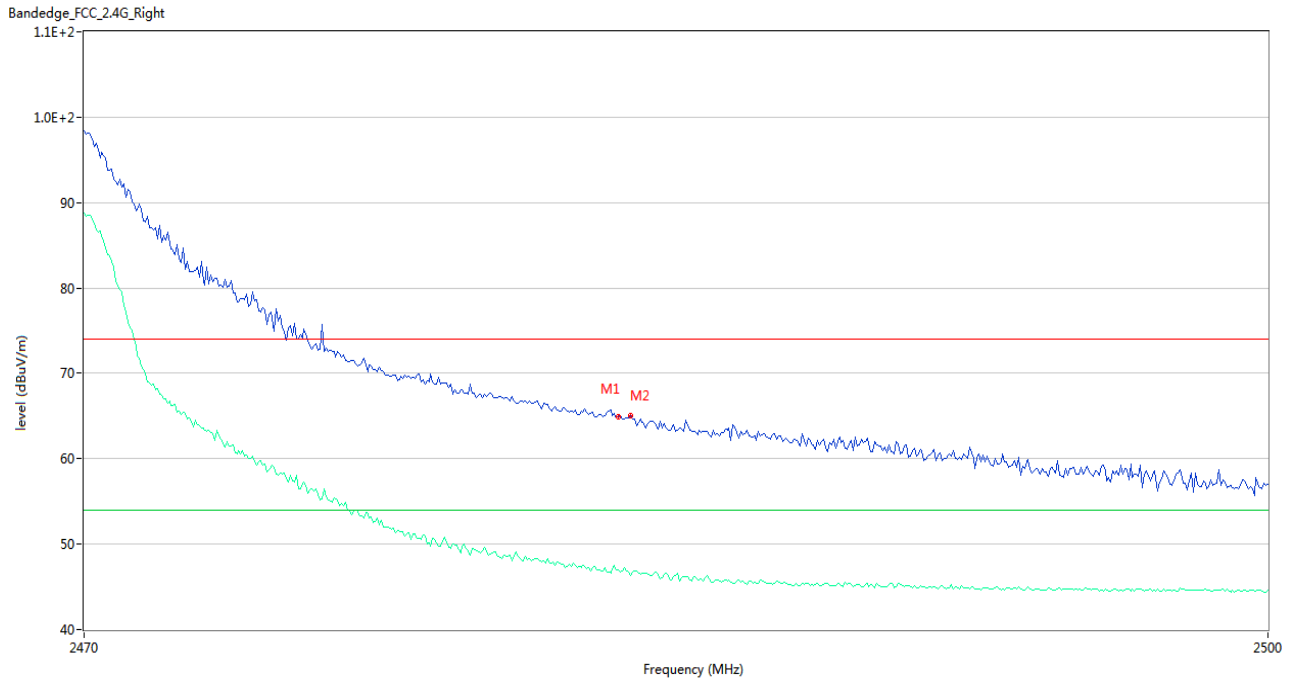

No.	Frequency (MHz)	Results (dBuV/m)	Factor (dB)	Limit (dBuV/m)	Over Limit (dB)	Detector	Table (Degree)	Height (cm)	Antenna	Verdict
1	2483.500	64.87	-0.36	74.0	-9.13	Peak	297.00	150	Horizontal	Pass
1**	2483.500	46.94	-0.36	54.0	-7.06	AV	297.00	150	Horizontal	Pass
2	2483.800	65.05	-0.35	74.0	-8.95	Peak	297.00	150	Horizontal	Pass
2**	2483.800	46.36	-0.35	54.0	-7.64	AV	297.00	150	Horizontal	Pass

802.11n-20 LOW CHANNEL

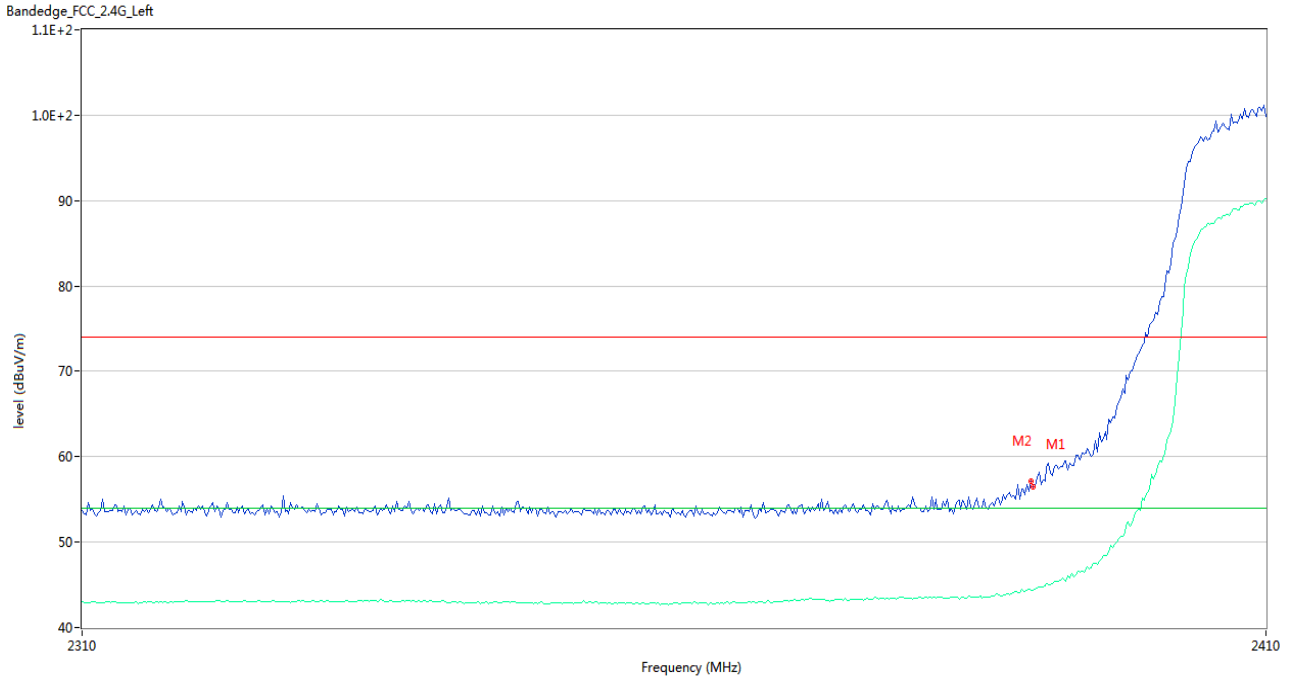

No.	Frequency (MHz)	Results (dBuV/m)	Factor (dB)	Limit (dBuV/m)	Over Limit (dB)	Detector	Table (Degree)	Height (cm)	Antenna	Verdict
1	2390.000	56.47	-0.50	74.0	-17.53	Peak	307.00	150	Horizontal	Pass
1**	2390.000	44.31	-0.50	54.0	-9.69	AV	307.00	150	Horizontal	Pass
2	2389.833	57.08	-0.50	74.0	-16.92	Peak	233.00	150	Horizontal	Pass
2**	2389.833	44.36	-0.50	54.0	-9.64	AV	233.00	150	Horizontal	Pass

802.11n-20 HIGH CHANNEL,

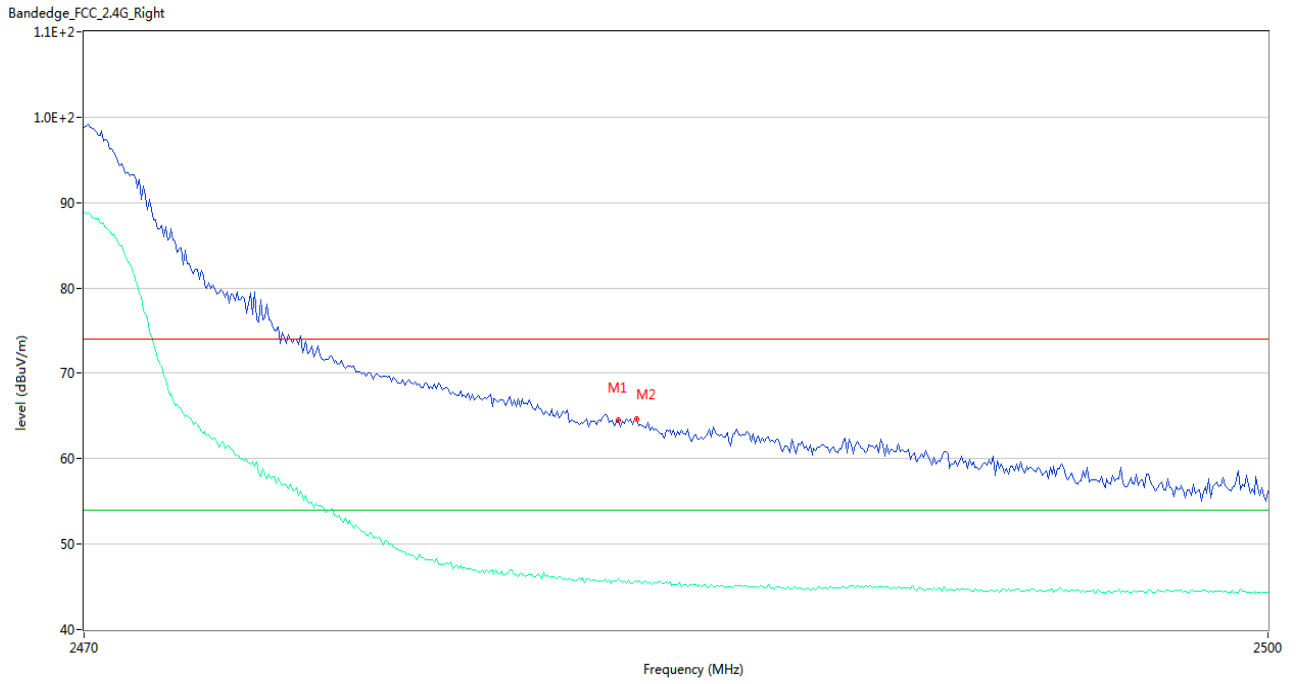

No.	Frequency (MHz)	Results (dBuV/m)	Factor (dB)	Limit (dBuV/m)	Over Limit (dB)	Detector	Table (Degree)	Height (cm)	Antenna	Verdict
1	2483.500	64.58	-0.36	74.0	-9.42	Peak	300.00	150	Horizontal	Pass
1**	2483.500	45.93	-0.36	54.0	-8.07	AV	300.00	150	Horizontal	Pass
2	2483.950	64.67	-0.35	74.0	-9.33	Peak	296.00	150	Horizontal	Pass
2**	2483.950	45.54	-0.35	54.0	-8.46	AV	296.00	150	Horizontal	Pass

A.8 Power Spectral Density (PSD)

Test Data

802.11b Mode:

Channel	Spectral power density (dBm/3kHz)	Limit (dBm/3kHz)
Low	-15.717	8
Middle	-15.851	8
High	-16.098	8

802.11g Mode:

Channel	Spectral power density (dBm/3kHz)	Limit (dBm/3kHz)
Low	-18.484	8
Middle	-18.018	8
High	-17.623	8

802.11n-20 MHz Mode:

Channel	Spectral power density (dBm/3kHz)	Limit (dBm/3kHz)
Low	-18.586	8
Middle	-19.043	8
High	-18.780	8

Test plots

802.11b LOW CHANNEL



802.11b MIDDLE CHANNEL



802.11b HIGH CHANNEL



802.11g LOW CHANNEL

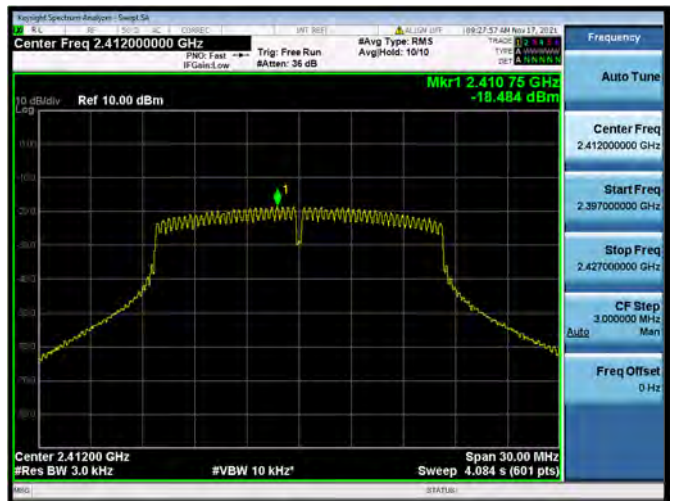

802.11g MIDDLE CHANNEL

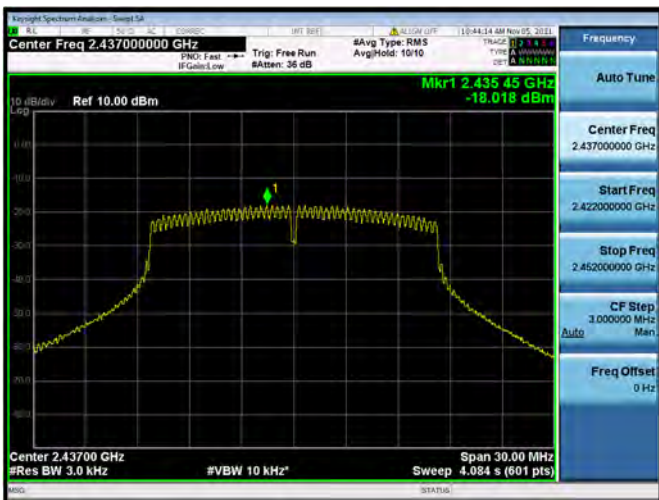

802.11g HIGH CHANNEL



802.11n-20 MHz LOW CHANNEL

802.11 n-20 MHz MIDDLE CHANNEL



802.11n-20 MHz HIGH CHANNEL



ANNEX B TEST SETUP PHOTOS

Please refer the document "BL-SZ21A0826-AR.pdf".

ANNEX C EUT EXTERNAL PHOTOS

Please refer the document "BL-SZ21A0826-AW.pdf".

ANNEX D EUT INTERNAL PHOTOS

Please refer the document "BL-SZ21A0826-AI.pdf".

--END OF REPORT--