



RADIO TEST REPORT

Report No.: STS2109158W04

Issued for

Shenzhen Freesun Technology Co., Ltd

3rd Floor, Yingdefeng Building, Hourui, Aimin Road,
Hangcheng Street, Bao an, Shenzhen, China

Product Name:	Ditto Projector
Brand Name:	Joann
Model Name:	DT01
Series Model:	N/A
FCC ID:	2AYJ8-DITTO
Test Standard:	FCC Part 15.407

Any reproduction of this document must be done in full. No single part of this document may be reproduced without permission from STS, all test data presented in this report is only applicable to presented test sample.

Shenzhen STS Test Services Co., Ltd.
A 1/F, Building B, Zhuoke Science Park, No.190 Chongqing Road, HepingShequ,
Fuyong Sub-District, Bao'an District, Shenzhen, Guang Dong, China
TEL: +86-755 3688 6288 FAX: +86-755 3688 6277 E-mail: sts@stsapp.com





TEST RESULT CERTIFICATION

Applicant's Name..... : Shenzhen Freesun Technology Co.,Ltd
Address : 3rd Floor, Yingdefeng Building, Hourui, Aimin Road, Hangcheng Street, Bao an, Shenzhen, China
Manufacturer's Name : Shenzhen Freesun Technology Co.,Ltd
Address : 3rd Floor, Yingdefeng Building, Hourui, Aimin Road, Hangcheng Street, Bao an, Shenzhen, China

Product Description

Product Name..... : Ditto Projector
Brand Name : Joann
Model Name : DT01
Series Model..... : N/A

Test Standards..... : FCC Part15.407

Test Procedure..... ANSI C63.10-2013

This device described above has been tested by STS, the test results show that the equipment under test (EUT) is in compliance with the FCC requirements. And it is applicable only to the tested sample identified in the report.

This report shall not be reproduced except in full, without the written approval of STS, this document only be altered or revised by STS, personal only, and shall be noted in the revision of the document.

Date of Test..... :
Date of receipt of test item : 22 Sept. 2021
Date (s) of performance of tests..... : 22 Sept. 2021 ~ 13 Oct. 2021
Date of Issue..... : 13 Oct. 2021
Test Result..... : **Pass**

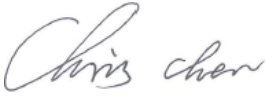
Testing Engineer : 

 (Chris Chen)

Technical Manager : 

 (Sean she)

Authorized Signatory : 

 (Vita Li)





Table of Contents	Page
1 . SUMMARY OF TEST RESULTS	6
1.1 TEST FACTORY	7
1.2 MEASUREMENT UNCERTAINTY	7
2 . GENERAL INFORMATION	8
2.1 GENERAL DESCRIPTION OF THE EUT	8
2.2 DESCRIPTION OF TEST MODES	10
2.3 TEST SOFTWARE AND POWER LEVEL	10
2.4 BLOCK DIAGRAM SHOWING THE CONFIGURATION OF SYSTEM TESTED	11
2.5 DESCRIPTION OF NECESSARY ACCESSORIES AND SUPPORT UNITS	12
2.6 EQUIPMENTS LIST FOR ALL TEST ITEMS	13
3 . EMC EMISSION TEST	14
3.1 CONDUCTED EMISSION MEASUREMENT	14
3.2 RADIATED EMISSION AND (BANDEDGE) MEASUREMENT	18
4. POWER SPECTRAL DENSITY TEST	34
4.1 LIMIT	34
4.2 TEST PROCEDURE	34
4.3 DEVIATION FROM STANDARD	35
4.4 TEST SETUP	35
4.5 EUT OPERATION CONDITIONS	35
4.6 TEST RESULTS	35
5. BANDWIDTH MEASUREMENT	36
5.1 EMISSION BANDWIDTH (EBW) 26 BANDWID PROCEDURES / LIMIT	36
5.2 OCCUPIED BANDWIDTH (99%) TEST APPLIED PROCEDURES / LIMIT	38
5.3 MINIMUM EMISSION BANDWIDTH(6 DB) PROCEDURES / LIMIT	40
6. MAXIMUM CONDUCTED OUTPUT POWER	41
6.1 LIMIT	41
6.2 TEST PROCEDURE	41
6.3 DEVIATION FROM STANDARD	41
6.4 TEST SETUP	41
6.5 EUT OPERATION CONDITIONS	41
6.6 TEST RESULTS	42
7. AUTOMATICALLY DISCONTINUE TRANSMISSION	45
7.1 LIMIT OF AUTOMATICALLY DISCONTINUE TRANSMISSION	45
7.2 TEST RESULT OF AUTOMATICALLY DISCONTINUE TRANSMISSION	45



Table of Contents	Page
8. ANTENNA REQUIREMENT	46
8.1 STANDARD REQUIREMENT	46
8.2 EUT ANTENNA	46
APPENDIX - PHOTOS OF TEST SETUP	47





Revision History

Rev.	Issue Date	Report NO.	Effect Page	Contents
00	13 Oct. 2021	STS2109158W04	ALL	Initial Issue





1. SUMMARY OF TEST RESULTS

Test procedures according to the technical standards:

§ 15.407, KDB 789033 D02 General U-NII Test Procedures New Rules v02r01.

FCC Part 15.407		
FCC standard	Test Item	Results
15.207	AC Conducted Emission	PASS
15.407 (a) /15.407 (e)	26dB/6dB &99% Bandwidth	PASS
15.407(a)	Maximum Conducted Output Power	PASS
15.407(b)/15.205/15.209	Radiated Emission And (bandedge Emissions) Measurement	PASS
15.407(a)	Power Spectral Density	PASS
15.407(c)	Automatically Discontinue Transmission	PASS
15.203	Antenna Requirement	PASS

NOTE:

(1) 'N/A' denotes test is not applicable in this Test Report.

(2) All tests are according to ANSI C63.10-2013.



1.1 TEST FACTORY

SHENZHEN STS TEST SERVICES CO., LTD

Add. : A 1/F, Building B, Zhuoke Science Park, No.190 Chongqing Road, HepingShequ, Fuyong Sub-District, Bao'an District, Shenzhen, Guang Dong, China

FCC test Firm Registration Number: 625569

IC test Firm Registration Number: 12108A

A2LA Certificate No.: 4338.01

1.2 MEASUREMENT UNCERTAINTY

The reported uncertainty of measurement $y \pm U$, where expanded uncertainty U is based on a standard uncertainty multiplied by a coverage factor of $k=2$, providing a level of confidence of approximately **95 %**.

No.	Item	Uncertainty
1	RF output power, conducted	$\pm 0.68\text{dB}$
2	Unwanted Emissions, conducted	$\pm 2.988\text{dB}$
3	All emissions, radiated 9K-30MHz	$\pm 2.84\text{dB}$
4	All emissions, radiated 30M-1GHz	$\pm 4.39\text{dB}$
5	All emissions, radiated 1G-6GHz	$\pm 5.10\text{dB}$
6	All emissions, radiated >6G	$\pm 5.48\text{dB}$
7	Conducted Emission (9KHz-150KHz)	$\pm 2.79\text{dB}$
8	Conducted Emission (150KHz-30MHz)	$\pm 2.80\text{dB}$



2. GENERAL INFORMATION

2.1 GENERAL DESCRIPTION OF THE EUT

Product Name	Ditto Projector								
Trade Name	Joann								
Model Name	DT01								
Series Model	N/A								
Model Difference	N/A								
Product Description	The EUT is a Ditto Projector								
	<table border="1"> <tr> <td>Operation Frequency:</td> <td>IEEE 802.11a/ n(HT20)/ac(VHT20): 5.180GHz-5.240GHz IEEE 802.11n(HT40)/ac(VHT40): 5.190GHz-5.230GHz IEEE 802.11ac(VHT80): 5.210GHz</td> </tr> <tr> <td>Modulation Type:</td> <td>802.11a(OFDM): BPSK,QPSK,16-QAM,64-QAM 802.11n(OFDM): BPSK,QPSK,16-QAM,64-QAM 802.11ac(OFDM): BPSK,QPSK,16-QAM,64-QAM,256-QAM</td> </tr> <tr> <td>Antenna Designation:</td> <td>Please refer to the Note 3.</td> </tr> <tr> <td>Max.Output Power(Conducted):</td> <td>17.63 dBm</td> </tr> </table>	Operation Frequency:	IEEE 802.11a/ n(HT20)/ac(VHT20): 5.180GHz-5.240GHz IEEE 802.11n(HT40)/ac(VHT40): 5.190GHz-5.230GHz IEEE 802.11ac(VHT80): 5.210GHz	Modulation Type:	802.11a(OFDM): BPSK,QPSK,16-QAM,64-QAM 802.11n(OFDM): BPSK,QPSK,16-QAM,64-QAM 802.11ac(OFDM): BPSK,QPSK,16-QAM,64-QAM,256-QAM	Antenna Designation:	Please refer to the Note 3.	Max.Output Power(Conducted):	17.63 dBm
	Operation Frequency:	IEEE 802.11a/ n(HT20)/ac(VHT20): 5.180GHz-5.240GHz IEEE 802.11n(HT40)/ac(VHT40): 5.190GHz-5.230GHz IEEE 802.11ac(VHT80): 5.210GHz							
	Modulation Type:	802.11a(OFDM): BPSK,QPSK,16-QAM,64-QAM 802.11n(OFDM): BPSK,QPSK,16-QAM,64-QAM 802.11ac(OFDM): BPSK,QPSK,16-QAM,64-QAM,256-QAM							
	Antenna Designation:	Please refer to the Note 3.							
Max.Output Power(Conducted):	17.63 dBm								
More details of EUT technical specification, please refer to the User's Manual.									
Test Channel	Please refer to the Note 2.								
Adapter	Input: 100-240V~50/60Hz 0.7A Output: DC 5.0V 3.0A 15.0W								
Hardware version number	5071B								
Software version number	20210916								
Connecting I/O Port(s)	Please refer to the Note 1.								

Note:

- For a more detailed features description, please refer to the manufacturer's specifications or the User Manual.



2.

Operation Frequency of channel	
5.180GHz-5.240GHz	
Channel	Frequency
36	5180
38	5190
40	5200
42	5210
44	5220
46	5230
48	5240

Note:

In section 15.31(m), regards to the operating frequency range over 10 MHz, the Lowest frequency, the middle frequency, and the highest frequency of channel were selected to perform the test, and the selected channel see below:

Carrier Frequency Channel

5GHz:

For 802.11a/n(HT20) /ac (VHT20)	
Channel	Freq.(MHz)
36	5180
40	5200
48	5240

For 802.11n(HT40) /ac (VHT40)	
Channel	Freq.(MHz)
38	5190
46	5230

For 802.11ac (VHT80)	
Channel	Freq.(MHz)
42	5210

3.

Ant	Brand	Model Name	Ant Type	Connector	Gain (dBi)	NOTE
A	Joann	DT01	PIFA	N/A	3dBi	WLAN Ant.

Note: The antenna information refer the manufacturer provide report, applicable only to the tested sample identified in the report.



2.2 DESCRIPTION OF TEST MODES

To investigate the maximum EMI emission characteristics generates from EUT, the test system was pre-scanning tested base on the consideration of following EUT operation mode or test configuration mode which possible have effect on EMI emission level. Each of these EUT operation mode(s) or test configuration mode(s) mentioned above was evaluated respectively.

Worst Mode	Description	Data Rate
Mode 1	TX IEEE 802.11a HT20 CH36&CH40&CH48	6 Mbps
Mode 2	TX IEEE 802.11n HT20 CH36&CH40&CH48	MCS 0
Mode 3	TX IEEE 802.11ac VHT20 CH36&CH40&CH48	NSS1 MCS0
Mode 4	TX IEEE 802.11n HT40 CH38&CH46	MCS 0
Mode 5	TX IEEE 802.11ac VHT40 CH38&CH46	NSS1 MCS0
Mode 6	TX IEEE 802.11ac VHT80 CH42	NSS1 MCS0

- Note: (1) The measurements are performed at the highest, middle, lowest available channels.
 (2) The measurements are performed at all Bit Rate of Transmitter, the worst data was reported.
 (3) We have be tested for all avaiable U.S. voltage and frequencies(For 120V,50/60Hz and 240V, 50/60Hz) for which the device is capable of operation.
 (4) The battery is fully-charged during the radited and RF conducted test.

AC Conducted Emission

Test Case	
AC Conducted Emission	Mode 7: Keeping TX + WLAN Link

2.3 TEST SOFTWARE AND POWER LEVEL

During testing channel & power controlling software provided by the customer was used to control the operating channel as well as the output power level.

RF Function	Type	Mode Or Modulation type	ANT Gain(dBi)	Power Class	Software For Testing
WIFI(5G)	5G WIFI Band1 (5150MHz-5250MHz)	802.11a	3	Default	RF_Test Tool
		802.11n(HT20)		Default	
		802.11n(HT40)		Default	
		802.11ac(VHT20)		Default	
		802.11ac(VHT40)		Default	
		802.11ac(VHT80)		Default	

2.4 BLOCK DIAGRAM SHOWING THE CONFIGURATION OF SYSTEM TESTED

Radiated Spurious Emission Test

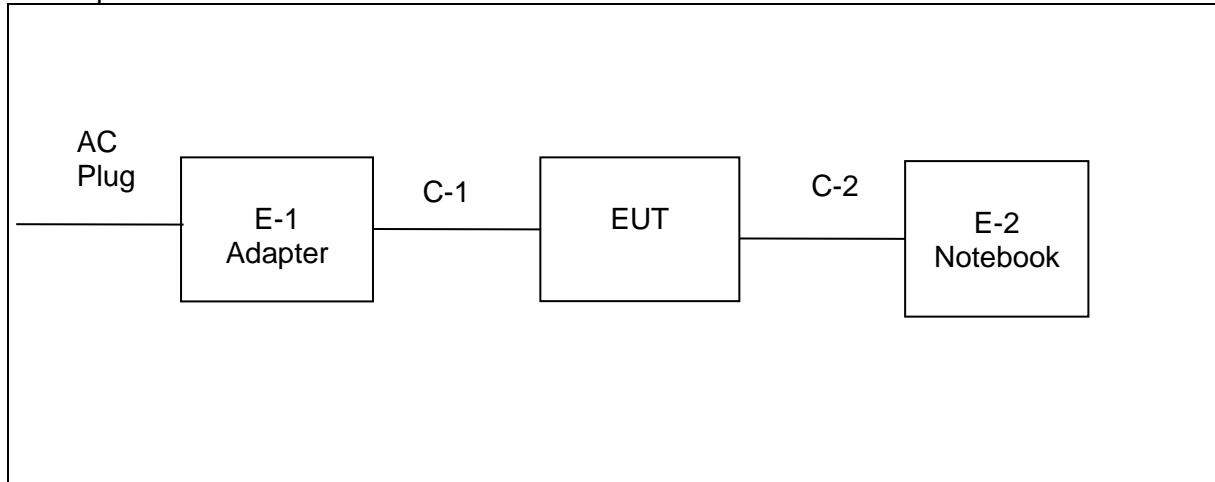

Conducted Emission Test

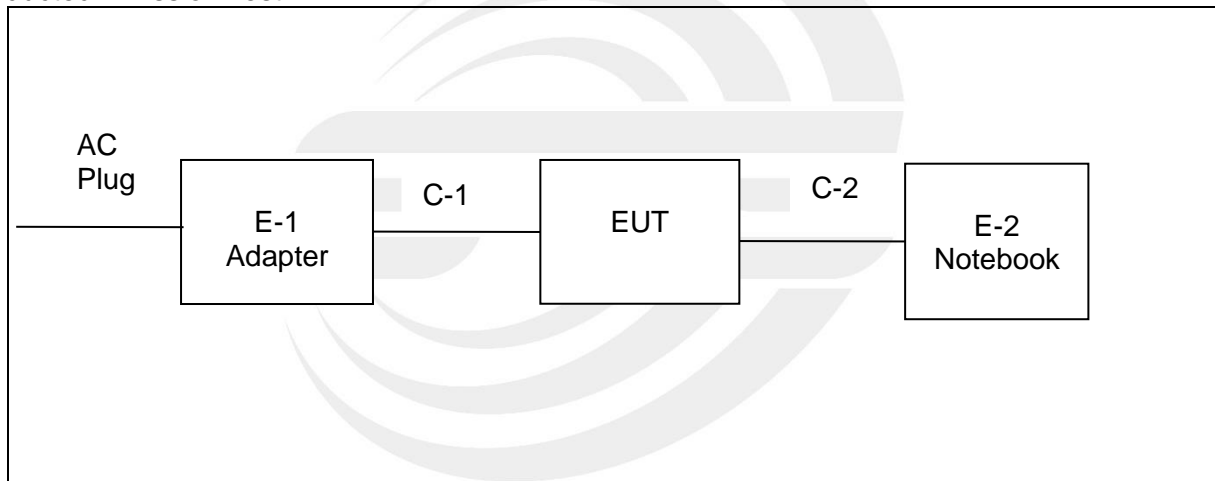



2.5 DESCRIPTION OF NECESSARY ACCESSORIES AND SUPPORT UNITS

The EUT has been tested as an independent unit together with other necessary accessories or support units. The following support units or accessories were used to form a representative test configuration during the tests.

Necessary accessories

Item	Equipment	Mfr/Brand	Model/Type No.	Length	Note
E-1	Adapter	N/A	MD30A-0500300-T	N/A	N/A
C-1	DC Cable	N/A	N/A	285cm	NO

Support units

Item	Equipment	Mfr/Brand	Model/Type No.	Length	Note
E-2	Notebook	LENOVO	ThinkPad E470	N/A	N/A
C-2	USB Cable	N/A	N/A	150cm	NO

Note:

- (1) For detachable type I/O cable should be specified the length in cm in 『Length』 column.
- (2) “YES” is means “with core”; “NO” is means “without core”.



2.6 EQUIPMENTS LIST FOR ALL TEST ITEMS

Radiation Test equipment

Kind of Equipment	Manufacturer	Type No.	Serial No.	Last calibration	Calibrated until
Test Receiver	R&S	ESCI	101427	2021.09.30	2022.09.29
Signal Analyzer	R&S	FSV 40-N	101823	2021.09.30	2022.09.29
Active loop Antenna	ZHINAN	ZN30900C	16035	2021.04.11	2023.04.10
Bilog Antenna	TESEQ	CBL6111D	34678	2020.10.12	2022.10.11
Horn Antenna	SCHWARZBECK	BBHA 9120D	02014	2021.10.11	2023.10.10
SHF-EHF Horn Antenna (18G-40GHz)	A-INFO	LB-180400-KF	J211020657	2020.10.12	2022.10.11
Pre-Amplifier(0.1M-3G Hz)	EM	EM330	060665	2021.10.08	2022.10.07
Pre-Amplifier (1G-18GHz)	SKET	LNPA-01018G-45	SK2018080901	2021.09.30	2022.09.29
Pre-Amplifier (18G-40GHz)	SKET	LNPA-1840-50	SK2018101801	2021.09.28	2022.09.27
Temperature & Humidity	HH660	Mieo	N/A	2021.10.09	2022.10.08
Turn table	EM	SC100_1	60531	N/A	N/A
Antenna mast	EM	SC100	N/A	N/A	N/A
Test SW	FARAD	EZ-EMC(Ver.STSLAB-03A1 RE)			

Conduction Test equipment

Kind of Equipment	Manufacturer	Type No.	Serial No.	Last calibration	Calibrated until
Test Receiver	R&S	ESCI	101427	2021.09.30	2022.09.29
LISN	R&S	ENV216	101242	2021.09.30	2022.09.29
LISN	EMCO	3810/2NM	23625	2021.09.30	2022.09.29
Temperature & Humidity	HH660	Mieo	N/A	2021.10.09	2022.10.08
Test SW	FARAD	EZ-EMC(Ver.STSLAB-03A1 CE)			

RF Connected Test

Kind of Equipment	Manufacturer	Type No.	Serial No.	Last calibration	Calibrated until
Power Sensor	Keysight	U2021XA	MY55520005	2021.09.30	2022.09.29
			MY55520006	2021.09.30	2022.09.29
			MY56120038	2021.09.30	2022.09.29
			MY56280002	2021.09.30	2022.09.29
Signal Analyzer	Agilent	N9020A	MY51110105	2021.03.04	2022.03.03
Temperature & Humidity	HH660	Mieo	N/A	2021.10.09	2022.10.08



3. EMC EMISSION TEST

3.1 CONDUCTED EMISSION MEASUREMENT

3.1.1 POWER LINE CONDUCTED EMISSION Limits (Frequency Range 150KHz-30MHz)

FREQUENCY (MHz)	Class B (dBuV)		Standard
	Quasi-peak	Average	
0.15 -0.5	66 - 56 *	56 - 46 *	CISPR
0.50 -5.0	56.00	46.00	CISPR
5.0 -30.0	60.00	50.00	CISPR

0.15 -0.5	66 - 56 *	56 - 46 *	FCC
0.50 -5.0	56.00	46.00	FCC
5.0 -30.0	60.00	50.00	FCC

Note:

- (1) The tighter limit applies at the band edges.
- (2) The limit of “ * ” marked band means the limitation decreases linearly with the logarithm of the frequency in the range.

The following table is the setting of the receiver

Receiver Parameters	Setting
Attenuation	10 dB
Start Frequency	0.15 MHz
Stop Frequency	30 MHz
IF Bandwidth	9 kHz

3.1.2 TEST PROCEDURE

- a. The EUT is 0.8 m from the horizontal ground plane and 0.4 m from the vertical ground plane with EUT being connected to the power mains through a line impedance stabilization network (LISN). All other support equipments are powered from additional LISN(s). The LISN provides 50 Ohm/ 50uH of coupling impedance for the measuring instrument.
- b. Interconnecting cables that hang closer than 40 cm to the ground plane shall be folded back and forth in the center forming a bundle 30 to 40 cm long.
- c. I/O cables that are not connected to a peripheral shall be bundled in the center. The end of the cable may be terminated, if required, using the correct terminating impedance. The overall length shall not exceed 1 m.
- d. LISN is at least 80 cm from the nearest part of EUT chassis.
- e. For the actual test configuration, please refer to the related Item –EUT Test Photos.

3.1.3 DEVIATION FROM TEST STANDARD

No deviation

3.1.4 TEST SETUP

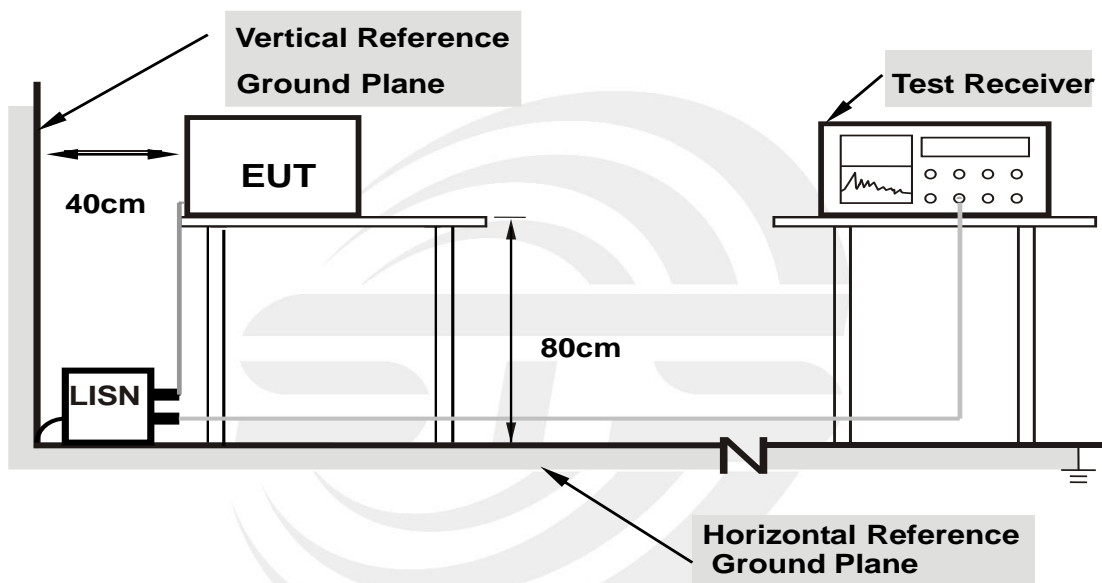

- Note:**
- 1. Support units were connected to second LISN.
 - 2. Both of LISNs (AMN) are 80 cm from EUT and at least 80 cm from other units and other metal planes support units.

3.1.5 EUT OPERATING CONDITIONS

The EUT was configured for testing in a typical fashion (as a customer would normally use it). The EUT has been programmed to continuously transmit during test. This operating condition was tested and used to collect the included data.



3.1.6 TEST RESULTS

Temperature:	21.8(C)	Relative Humidity:	54%RH
Test Voltage:	AC 120V/60Hz	Phase:	L
Test Mode :	Mode 7		

No.	Frequency (MHz)	Reading (dBuV)	Correct Factor(dB)	Result (dBuV)	Limit (dBuV)	Margin (dB)	Remark
1	0.1590	35.94	20.33	56.27	65.52	-9.25	QP
2	0.1590	15.55	20.33	35.88	55.52	-19.64	AVG
3	0.3140	31.09	20.72	51.81	59.86	-8.05	QP
4	0.3140	12.44	20.72	33.16	49.86	-16.70	AVG
5	0.4380	30.72	20.54	51.26	57.10	-5.84	QP
6	0.4380	8.45	20.54	28.99	47.10	-18.11	AVG
7	1.6700	21.36	20.30	41.66	56.00	-14.34	QP
8	1.6700	7.16	20.30	27.46	46.00	-18.54	AVG
9	5.0820	25.63	20.46	46.09	60.00	-13.91	QP
10	5.0820	12.86	20.46	33.32	50.00	-16.68	AVG
11	21.5300	25.70	22.81	48.51	60.00	-11.49	QP
12	21.5300	5.36	22.81	28.17	50.00	-21.83	AVG

Remark:

1. All readings are Quasi-Peak and Average values
2. Margin = Result (Result =Reading + Factor)–Limit
3. Factor=LISN factor+Cable loss+Limiter (10dB)

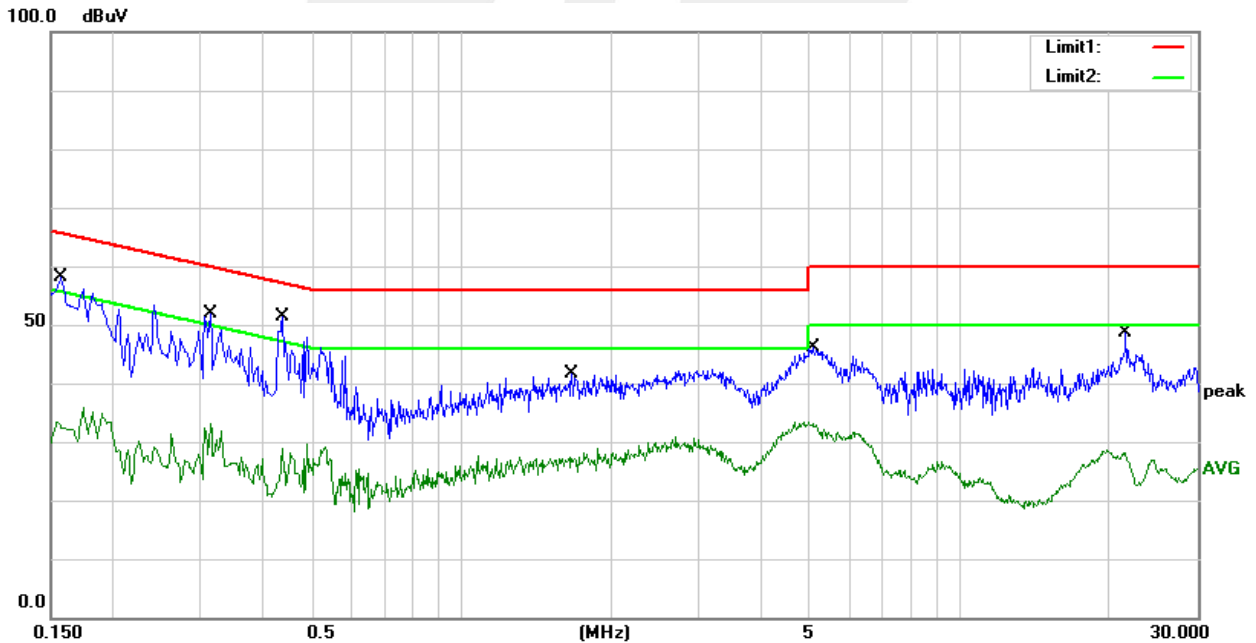



Temperature:	21.8(C)	Relative Humidity:	54%RH
Test Voltage	AC 120V/60Hz	Phase:	N
Test Mode	Mode 7		

No.	Frequency (MHz)	Reading (dBuV)	Correct Factor(dB)	Result (dBuV)	Limit (dBuV)	Margin (dB)	Remark
1	0.1580	36.37	20.33	56.70	65.57	-8.87	QP
2	0.1580	15.41	20.33	35.74	55.57	-19.83	AVG
3	0.2420	29.56	20.50	50.06	62.03	-11.97	QP
4	0.2420	8.32	20.50	28.82	52.03	-23.21	AVG
5	0.4860	32.13	20.54	52.67	56.24	-3.57	QP
6	0.4860	12.55	20.54	33.09	46.24	-13.15	AVG
7	1.4380	22.41	20.30	42.71	56.00	-13.29	QP
8	1.4380	8.77	20.30	29.07	46.00	-16.93	AVG
9	5.3180	24.45	20.48	44.93	60.00	-15.07	QP
10	5.3180	12.37	20.48	32.85	50.00	-17.15	AVG
11	14.1500	20.81	21.64	42.45	60.00	-17.55	QP
12	14.1500	0.89	21.64	22.53	50.00	-27.47	AVG

Remark:

1. All readings are Quasi-Peak and Average values
2. Margin = Result (Result =Reading + Factor) –Limit
3. Factor=LISN factor+Cable loss+Limiter (10dB)

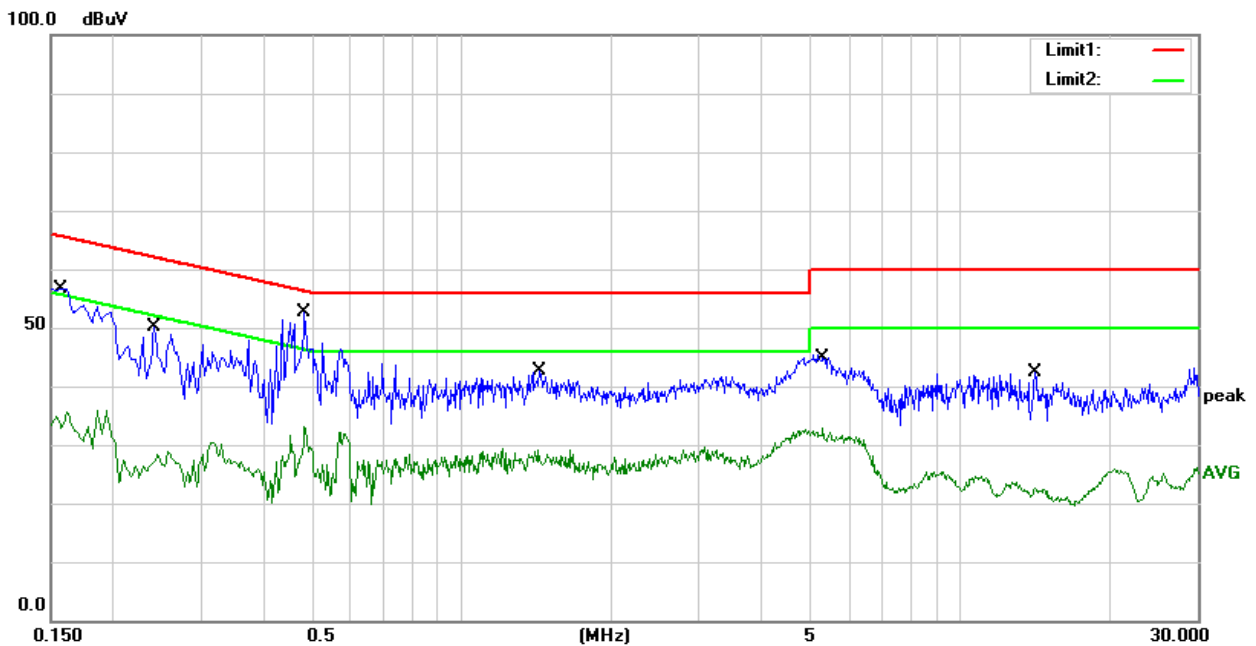

3.2 RADIATED EMISSION AND (BANDEDGE) MEASUREMENT

3.2.1 RADIATED EMISSION LIMITS (Frequency Range 9kHz-1000MHz)

In case the emission fall within the restricted band specified on 15.407(b)7& 15.205/209(a), then the limit in the table below has to be followed.

Frequencies (MHz)	Field Strength (microrvolts/meter)	Measurement Distance (meters)
0.009~0.490	2400/F(KHz)	300
0.490~1.705	24000/F(KHz)	30
1.705~30.0	30	30
30~88	100	3
88~216	150	3
216~960	200	3
Above 960	500	3

LIMITS OF RADIATED EMISSION MEASUREMENT (Above 1000MHz)

FREQUENCY (MHz)	Class B (dBuV/m) (at 3M)	
	PEAK	AVERAGE
Above 1000	68.2	54

Notes:

- (1) The limit for radiated test was performed according to FCC PART 15E.
- (2) The tighter limit applies at the band edges.
- (3) Emission level (dBuV/m)=20log Emission level (uV/m).

LIMITS OF RESTRICTED FREQUENCY BANDS

FREQUENCY (MHz)	FREQUENCY (MHz)	FREQUENCY (MHz)	FREQUENCY (GHz)
0.090-0.110	16.42-16.423	399.9-410	4.5-5.15
0.495-0.505	16.69475-16.69525	608-614	5.35-5.46
2.1735-2.1905	16.80425-16.80475	960-1240	7.25-7.75
4.125-4.128	25.5-25.67	1300-1427	8.025-8.5
4.17725-4.17775	37.5-38.25	1435-1626.5	9.0-9.2
4.20725-4.20775	73-74.6	1645.5-1646.5	9.3-9.5
6.215-6.218	74.8-75.2	1660-1710	10.6-12.7
6.26775-6.26825	108-121.94	1718.8-1722.2	13.25-13.4
6.31175-6.31225	123-138	2200-2300	14.47-14.5
8.291-8.294	149.9-150.05	2310-2390	15.35-16.2
8.362-8.366	156.52475-156.52525	2483.5-2500	17.7-21.4
8.37625-8.38675	156.7-156.9	2690-2900	22.01-23.12
8.41425-8.41475	162.0125-167.17	3260-3267	23.6-24.0
12.29-12.293	167.72-173.2	3332-3339	31.2-31.8
12.51975-12.52025	240-285	3345.8-3358	36.43-36.5
12.57675-12.57725	322-335.4	3600-4400	Above 38.6
13.36-13.41			

Note: In case the emission radiated emission above 1000MHz fall within the restricted band the restricted frequency bands, the peak limit is 74 dBuV/m.

**LIMITS OF EMISSIONS OUTSIDE OF THE FREQUENCY BANDS**

Undesirable emission limits. Except as shown in paragraph (b)(7) of this section, the maximum emissions outside of the frequency bands of operation shall be attenuated in accordance with the following limits:

((1) For transmitters operating in the 5.15-5.25 GHz band: All emissions outside of the 5.15-5.35 GHz band shall not exceed an e.i.r.p. of -27 dBm/MHz.

(2) For transmitters operating in the 5.25-5.35 GHz band: All emissions outside of the 5.15-5.35 GHz band shall not exceed an e.i.r.p. of -27 dBm/MHz.

(3) For transmitters operating in the 5.47-5.725 GHz band: All emissions outside of the 5.47-5.725 GHz band shall not exceed an e.i.r.p. of -27 dBm/MHz.

(4) For transmitters operating in the 5.725-5.85 GHz band:

(i) All emissions shall be limited to a level of -27 dBm/MHz at 75 MHz or more above or below the band edge increasing linearly to 10 dBm/MHz at 25 MHz above or below the band edge, and from 25 MHz above or below the band edge increasing linearly to a level of 15.6 dBm/MHz at 5 MHz above or below the band edge, and from 5 MHz above or below the band edge increasing linearly to a level of 27 dBm/MHz at the band edge.

Note: dBuV/m(at 3M) = EIRP(dBm) + 95.3.

Peak Limit = -27dBm/MHz + 95.3 = 68.3 dBuV/m.

Spectrum Parameter	Setting
Attenuation	Auto
Detector	Peak
Start Frequency	1000 MHz(Peak/AV)
Stop Frequency	10th carrier harmonic (Peak/AV)
RB / VB (emission in restricted band)	1 MHz / 1 MHz, AV=1 MHz /3 MHz

For Band edge

Spectrum Parameter	Setting
Detector	Peak
RB / VB (emission in restricted band)	1 MHz / 1 MHz, AV=1 MHz /3 MHz

Receiver Parameter	Setting
Attenuation	Auto
Start ~ Stop Frequency	9kHz~90kHz / RB 200Hz for PK & AV
Start ~ Stop Frequency	90kHz~110kHz / RB 200Hz for QP
Start ~ Stop Frequency	110kHz~490kHz / RB 200Hz for PK & AV
Start ~ Stop Frequency	490kHz~30MHz / RB 9kHz for QP
Start ~ Stop Frequency	30MHz~1000MHz / RB 120kHz for QP



3.2.2 TEST PROCEDURE

- a. The measuring distance at 3 m shall be used for measurements at frequency 0.009MHz up to 1GHz, and above 1GHz.
- b. The EUT was placed on the top of a rotating table 0.8 m (above 1GHz is 1.5 m) above the ground at a 3 m anechoic chamber test site. The table was rotated 360 degree to determine the position of the highest radiation.
- c. The height of the equipment shall be 0.8 m (above 1GHz is 1.5 m); the height of the test antenna shall vary between 1 m to 4 m. Horizontal and vertical polarization of the antenna are set to make the measurement.
- d. The initial step in collecting conducted emission data is a spectrum analyzer peak detector mode pre-scanning the measurement frequency range. Significant peaks are then marked and QuasiPeak detector mode will be re-measured.
- e. If the Peak Mode measured value is compliance with and lower than Quasi Peak Mode Limit, the EUT shall be deemed to meet QP Limits and no additional QP Mode measurement was performed.
- f. For the actual test configuration, please refer to the related Item –EUT Test Photos.

Note:

Both horizontal and vertical antenna polarities were tested and performed pretest to three orthogonal axis. The worst case emissions were reported.

3.2.2 DEVIATION FROM TEST STANDARD

No deviation



3.2.3 TEST SETUP

(A) Radiated Emission Test-Up Frequency Below 30MHz

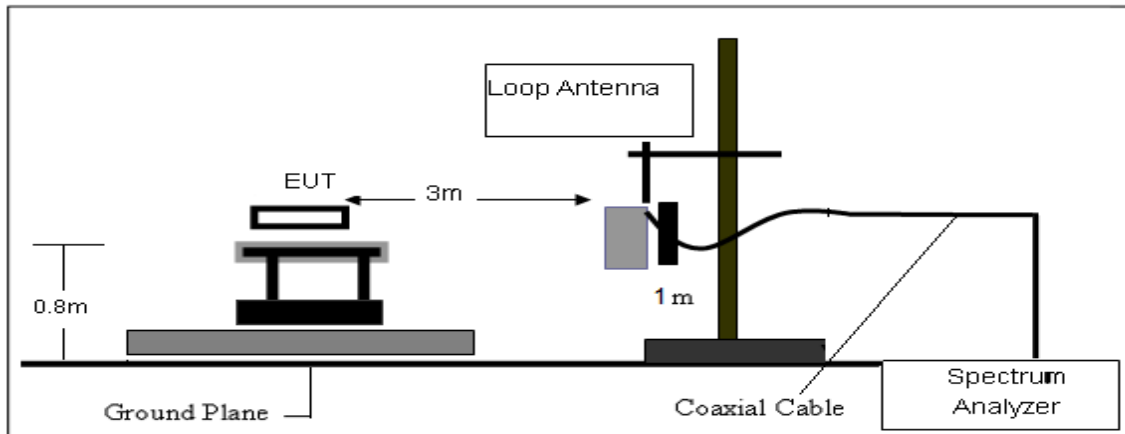

(B) Radiated Emission Test-Up Frequency 30MHz~1GHz

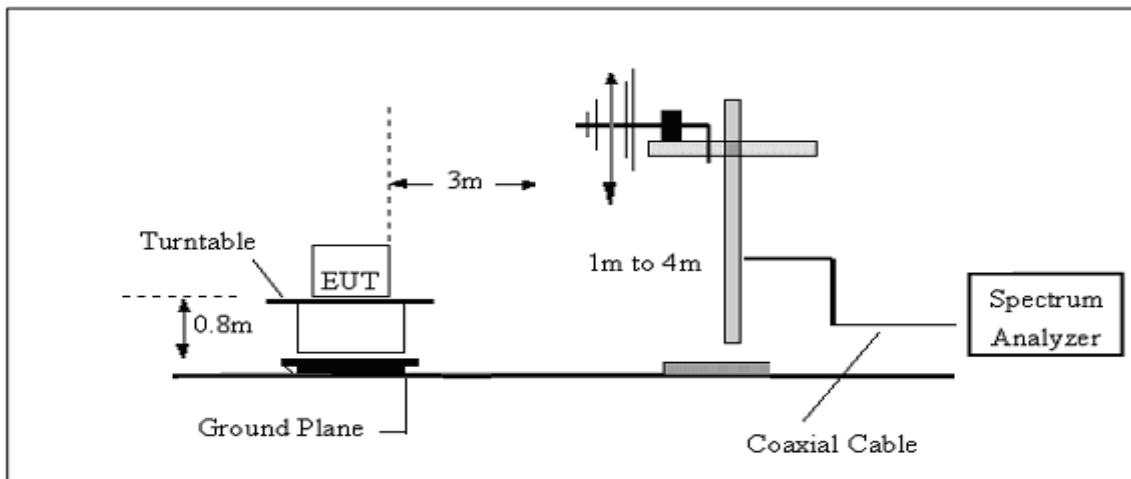

(C) Radiated Emission Test-Up Frequency Above 1GHz

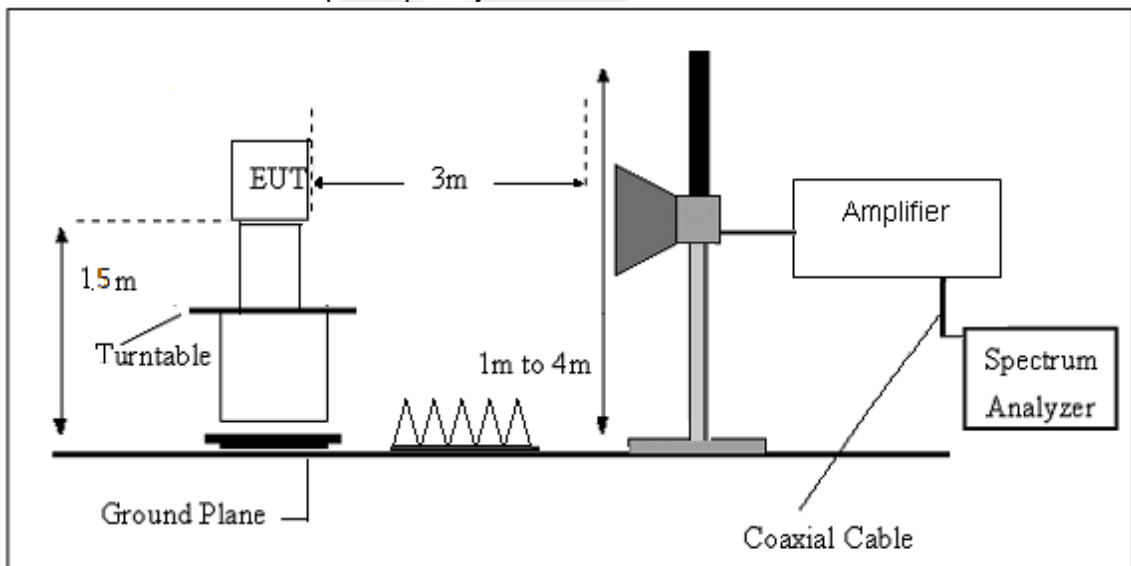



3.2.4 EUT OPERATING CONDITIONS

The EUT tested system was configured as the statements of 2.4 Unless otherwise a special operating condition is specified in the follows during the testing.

3.2.5 FIELD STRENGTH CALCULATION

The field strength is calculated by adding the Antenna Factor and Cable Factor and subtracting the Amplifier Gain and Duty Cycle Correction Factor (if any) from the measured reading. The basic equation with a sample calculation is as follows:

$$FS = RA + AF + CL - AG$$

Where

FS = Field Strength

CL = Cable Attenuation Factor (Cable Loss)

RA = Reading Amplitude

AG = Amplifier Gain

AF = Antenna Factor

For example

Frequency (MHz)	FS (dB μ V/m)	RA (dB μ V/m)	AF (dB)	CL (dB)	AG (dB)	Factor (dB)
300	40	58.1	12.2	1.6	31.9	-18.1

$$\text{Factor} = \text{AF} + \text{CL} - \text{AG}$$

**3.2.6 TEST RESULTS (Between 9KHz – 30 MHz)**

Temperature:	23.1(C)	Relative Humidity:	60%RH
Test Voltage:	AC 120V/60Hz	Polarization :	--
Test Mode:	TX Mode		

Freq. (MHz)	Reading (dBuV/m)	Limit (dBuV/m)	Margin (dB)	State P/F
--	--	--	--	PASS
--	--	--	--	PASS

Note:

The amplitude of spurious emissions which are attenuated by more than 20dB below the permissible value has no need to be reported.

Distance extrapolation factor = $40 \log(\text{specific distance}/\text{test distance})$ (dB);

Limit line = specific limits(dBuv) + distance extrapolation factor.

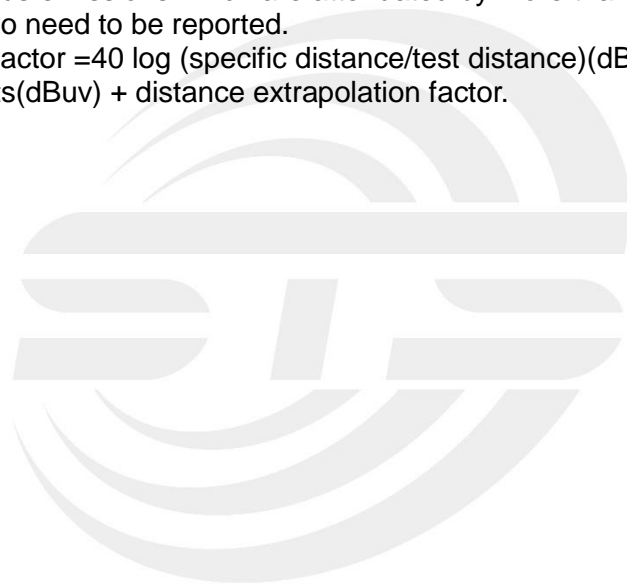



3.2.7 TEST RESULTS (Between 30MHz – 1GHz)

Temperature	23.1(C)	Relative Humidity:	60%RH
Test Voltage	AC 120V/60Hz	Polarization:	Horizontal
Test Mode	Mode 1~6(Mode 1 worst mode)		

No.	Frequency (MHz)	Reading (dBuV)	Correct Factor(dB/m)	Result (dBuV/m)	Limit (dBuV/m)	Margin (dB)	Remark
1	113.4200	34.58	-18.73	15.85	43.50	-27.65	QP
2	501.4200	28.64	-8.00	20.64	46.00	-25.36	QP
3	568.3500	27.79	-5.58	22.21	46.00	-23.79	QP
4	733.2500	30.01	-2.35	27.66	46.00	-18.34	QP
5	873.9000	28.98	-0.58	28.40	46.00	-17.60	QP
6	955.3800	28.51	1.68	30.19	46.00	-15.81	QP

Remark:

1. Margin = Result (Result =Reading + Factor)-Limit
2. Factor= Antenna factor+Cable attenuation factor(cable loss)-Amplifier gain

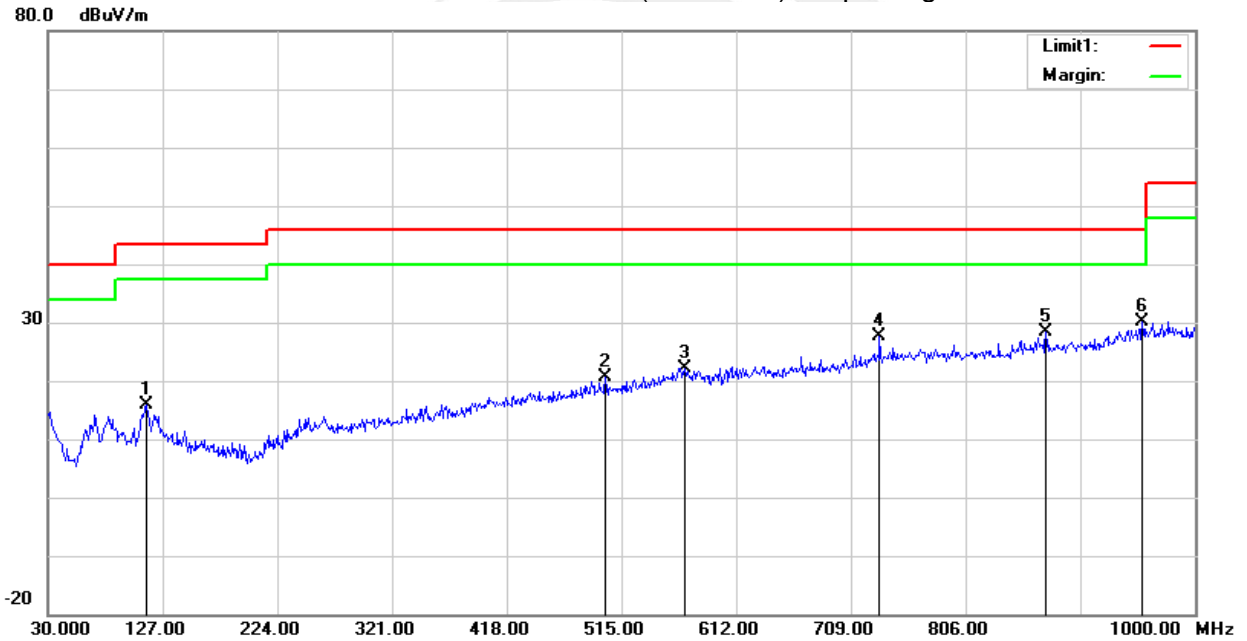



Temperature	23.1(C)	Relative Humidity:	60%RH
Test Voltage	AC 120V/60Hz	Polarization:	Vertical
Test Mode	Mode 1~6(Mode 1 worst mode)		

No.	Frequency (MHz)	Reading (dBuV)	Correct Factor(dB/m)	Result (dBuV/m)	Limit (dBuV/m)	Margin (dB)	Remark
1	65.8900	45.16	-25.60	19.56	40.00	-20.44	QP
2	243.4000	32.40	-17.32	15.08	46.00	-30.92	QP
3	570.2900	28.85	-5.61	23.24	46.00	-22.76	QP
4	767.2000	28.68	-2.29	26.39	46.00	-19.61	QP
5	867.1100	27.73	-0.50	27.23	46.00	-18.77	QP
6	970.9000	28.19	2.06	30.25	54.00	-23.75	QP

Remark:

- Margin = Result (Result =Reading + Factor) –Limit
- Factor= Antenna factor+Cable attenuation factor(cable loss)-Amplifier gain

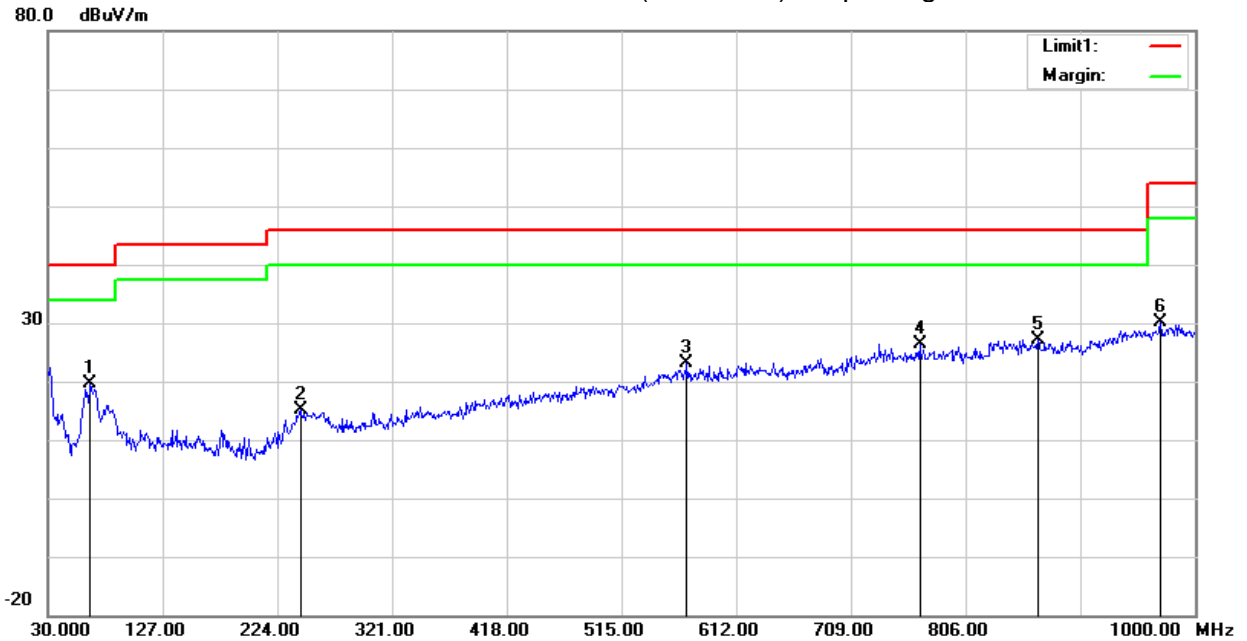



3.2.8 TEST RESULTS (Above 1000 MHz)

Band I 5150-5250MHz

Frequency (MHz)	Reading (dBuV)	Amplifier (dB)	Loss (dB)	Antenna Factor (dB/m)	Orrected Factor (dB)	Emission Level (dBuV/m)	Limit (dBuV/m)	Margin (dB)	Detector	Comment
Low Channel (802.11a/ 5180 MHz)										
3262.87	44.23	44.70	6.70	28.20	-9.80	34.43	74.00	-39.57	Pk	Vertical
3262.87	41.50	44.70	6.70	28.20	-9.80	31.70	54.00	-22.30	AV	Vertical
3265.23	45.24	44.70	6.70	28.20	-9.80	35.44	74.00	-38.56	Pk	Horizontal
3265.23	41.85	44.70	6.70	28.20	-9.80	32.05	54.00	-21.95	AV	Horizontal
3987.20	39.64	44.20	7.90	29.70	-6.60	33.04	74.00	-40.96	Pk	Vertical
3987.20	36.36	44.20	7.90	29.70	-6.60	29.76	54.00	-24.24	AV	Vertical
3992.86	39.49	44.20	7.90	29.70	-6.60	32.89	74.00	-41.11	Pk	Horizontal
3992.86	36.92	44.20	7.90	29.70	-6.60	30.32	54.00	-23.68	AV	Horizontal
7234.51	37.33	43.50	11.40	35.50	3.40	40.73	68.20	-27.47	Pk	Vertical
7234.51	33.80	43.50	11.40	35.50	3.40	37.20	54.00	-16.80	AV	Vertical
7232.67	37.82	43.50	11.40	35.50	3.40	41.22	68.20	-26.98	Pk	Horizontal
7232.67	33.89	43.50	11.40	35.50	3.40	37.29	54.00	-16.71	AV	Horizontal
10359.97	39.92	44.50	13.80	38.80	8.10	48.02	68.20	-20.18	Pk	Vertical
10359.97	36.82	44.50	13.80	38.80	8.10	44.92	54.00	-9.08	AV	Vertical
10360.33	39.23	44.50	13.80	38.80	8.10	47.33	68.20	-20.87	Pk	Horizontal
10360.33	35.79	44.50	13.80	38.80	8.10	43.89	54.00	-10.11	AV	Horizontal
11025.85	33.40	43.60	14.30	39.50	10.20	43.60	74.00	-30.40	Pk	Vertical
11025.85	30.15	43.60	14.30	39.50	10.20	40.35	54.00	-13.65	AV	Vertical
11025.71	33.48	43.60	14.30	39.50	10.20	43.68	74.00	-30.32	Pk	Horizontal
11025.71	29.83	43.60	14.30	39.50	10.20	40.03	54.00	-13.97	AV	Horizontal
13286.70	31.90	42.60	15.90	38.90	12.20	44.10	74.00	-29.90	Pk	Vertical
13286.70	28.77	42.60	15.90	38.90	12.20	40.97	54.00	-13.03	AV	Vertical
13294.08	32.47	42.60	15.90	38.90	12.20	44.67	74.00	-29.33	Pk	Horizontal
13294.08	29.81	42.60	15.90	38.90	12.20	42.01	54.00	-11.99	AV	Horizontal
Mid Channel (802.11a/ 5200 MHz)										
3250.92	45.10	44.70	6.70	28.20	-9.80	35.30	68.20	-32.90	Pk	Vertical
3250.92	41.10	44.70	6.70	28.20	-9.80	31.30	54.00	-22.70	AV	Vertical
3251.28	45.08	44.70	6.70	28.20	-9.80	35.28	68.20	-32.92	Pk	Horizontal
3251.28	41.98	44.70	6.70	28.20	-9.80	32.18	54.00	-21.82	AV	Horizontal
3995.97	39.49	44.20	7.90	29.70	-6.60	32.89	74.00	-41.11	Pk	Vertical
3995.97	35.96	44.20	7.90	29.70	-6.60	29.36	54.00	-24.64	AV	Vertical
3988.07	39.05	44.20	7.90	29.70	-6.60	32.45	74.00	-41.55	Pk	Horizontal
3988.07	36.68	44.20	7.90	29.70	-6.60	30.08	54.00	-23.92	AV	Horizontal
7221.31	37.41	43.50	11.40	35.50	3.40	40.81	68.20	-27.39	Pk	Vertical
7221.31	33.86	43.50	11.40	35.50	3.40	37.26	54.00	-16.74	AV	Vertical
7220.64	37.47	43.50	11.40	35.50	3.40	40.87	68.20	-27.33	Pk	Horizontal
7220.64	34.59	43.50	11.40	35.50	3.40	37.99	54.00	-16.01	AV	Horizontal
10400.39	40.05	44.50	13.80	38.80	8.10	48.15	68.20	-20.05	Pk	Vertical
10400.39	36.66	44.50	13.80	38.80	8.10	44.76	54.00	-9.24	AV	Vertical
10400.07	39.55	44.50	13.80	38.80	8.10	47.65	68.20	-20.55	Pk	Horizontal
10400.07	36.24	44.50	13.80	38.80	8.10	44.34	54.00	-9.66	AV	Horizontal
11018.09	34.14	43.60	14.30	39.50	10.20	44.34	74.00	-29.66	Pk	Vertical
11018.09	30.34	43.60	14.30	39.50	10.20	40.54	54.00	-13.46	AV	Vertical
11018.91	33.00	43.60	14.30	39.50	10.20	43.20	74.00	-30.80	Pk	Horizontal
11018.91	29.90	43.60	14.30	39.50	10.20	40.10	54.00	-13.90	AV	Horizontal
13283.90	32.55	42.60	15.90	38.90	12.20	44.75	74.00	-29.25	Pk	Vertical
13283.90	28.94	42.60	15.90	38.90	12.20	41.14	54.00	-12.86	AV	Vertical
13297.44	31.68	42.60	15.90	38.90	12.20	43.88	74.00	-30.12	Pk	Horizontal
13297.44	30.01	42.60	15.90	38.90	12.20	42.21	54.00	-11.79	AV	Horizontal



High Channel (802.11a/ 5240 MHz)										
3246.60	44.48	44.70	6.70	28.20	-9.80	34.68	68.20	-33.52	Pk	Vertical
3246.60	42.14	44.70	6.70	28.20	-9.80	32.34	54.00	-21.66	AV	Vertical
3256.98	43.86	44.70	6.70	28.20	-9.80	34.06	68.20	-34.14	Pk	Horizontal
3256.98	41.85	44.70	6.70	28.20	-9.80	32.05	54.00	-21.95	AV	Horizontal
3990.84	39.37	44.20	7.90	29.70	-6.60	32.77	74.00	-41.23	Pk	Vertical
3990.84	35.72	44.20	7.90	29.70	-6.60	29.12	54.00	-24.88	AV	Vertical
3983.40	39.38	44.20	7.90	29.70	-6.60	32.78	74.00	-41.22	Pk	Horizontal
3983.40	35.74	44.20	7.90	29.70	-6.60	29.14	54.00	-24.86	AV	Horizontal
7221.85	36.88	43.50	11.40	35.50	3.40	40.28	68.20	-27.92	Pk	Vertical
7221.85	34.66	43.50	11.40	35.50	3.40	38.06	54.00	-15.94	AV	Vertical
7229.11	36.93	43.50	11.40	35.50	3.40	40.33	68.20	-27.87	Pk	Horizontal
7229.11	33.80	43.50	11.40	35.50	3.40	37.20	54.00	-16.80	AV	Horizontal
10479.96	39.75	44.50	13.80	38.80	8.10	47.85	68.20	-20.35	Pk	Vertical
10479.96	35.98	44.50	13.80	38.80	8.10	44.08	54.00	-9.92	AV	Vertical
10480.10	39.31	44.50	13.80	38.80	8.10	47.41	68.20	-20.79	Pk	Horizontal
10480.10	35.85	44.50	13.80	38.80	8.10	43.95	54.00	-10.05	AV	Horizontal
11020.69	33.95	43.60	14.30	39.50	10.20	44.15	74.00	-29.85	Pk	Vertical
11020.69	30.36	43.60	14.30	39.50	10.20	40.56	54.00	-13.44	AV	Vertical
11017.99	33.60	43.60	14.30	39.50	10.20	43.80	74.00	-30.20	Pk	Horizontal
11017.99	30.11	43.60	14.30	39.50	10.20	40.31	54.00	-13.69	AV	Horizontal
13280.06	32.15	42.60	15.90	38.90	12.20	44.35	74.00	-29.65	Pk	Vertical
13280.06	29.90	42.60	15.90	38.90	12.20	42.10	54.00	-11.90	AV	Vertical
13293.01	32.22	42.60	15.90	38.90	12.20	44.42	74.00	-29.58	Pk	Horizontal
13293.01	29.66	42.60	15.90	38.90	12.20	41.86	54.00	-12.14	AV	Horizontal

Remark:

- Factor = Antenna Factor + Cable Loss – Pre-amplifier.
- Scan with 802.11a,802.11n (HT-20),802.11n (HT-40), 802.11ac (VHT-20),802.11ac (VHT-40), 802.11ac (VHT-80) the worst case is 802.11a.
- The frequency emission of peak points that did not show above the forms are at least 20dB below the limit, the frequency emission is mainly from the environment noise.

3.2.9 RESTRICTED FREQUENCY BANDS AND BAND EDGE

Band I 5150-5250MHz

802.11a20-L-H

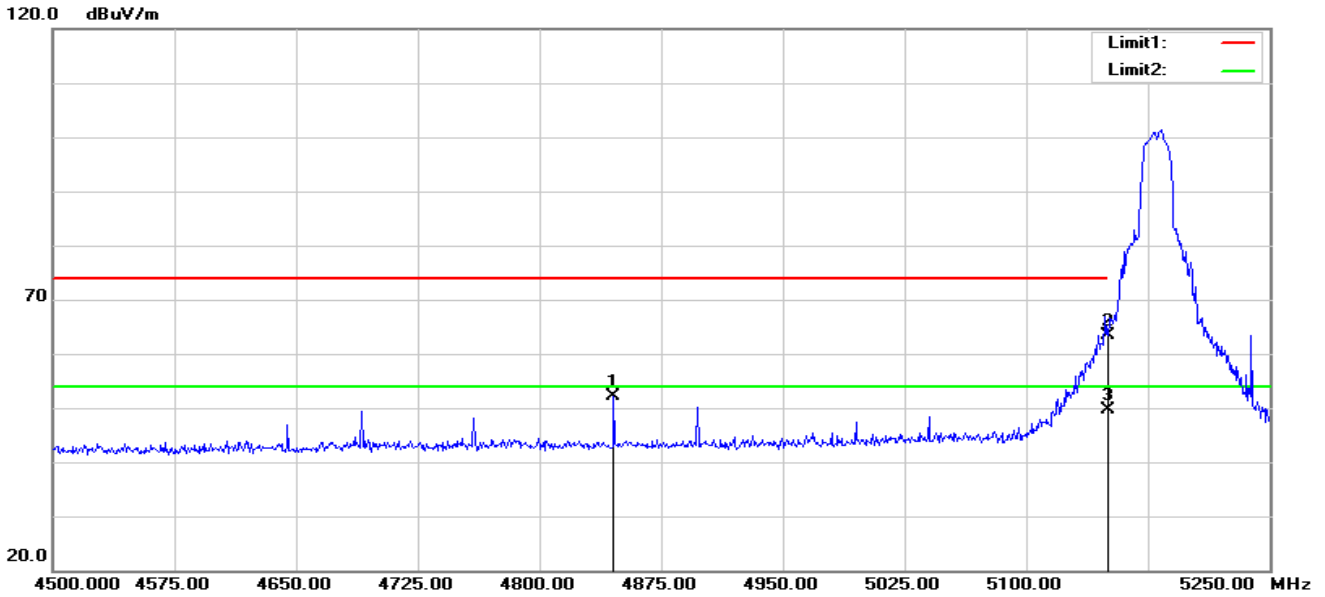

No.	Frequency (MHz)	Reading (dBuV)	Correct Factor(dB/m)	Result (dBuV/m)	Limit (dBuV/m)	Margin (dB)	Remark
1	4845.750	59.06	-7.05	52.01	74.00	-21.99	peak
2	5150.000	69.07	-5.73	63.34	74.00	-10.66	peak
3	5150.000	55.35	-5.73	49.62	54.00	-4.38	AVG

802.11a20-L-V

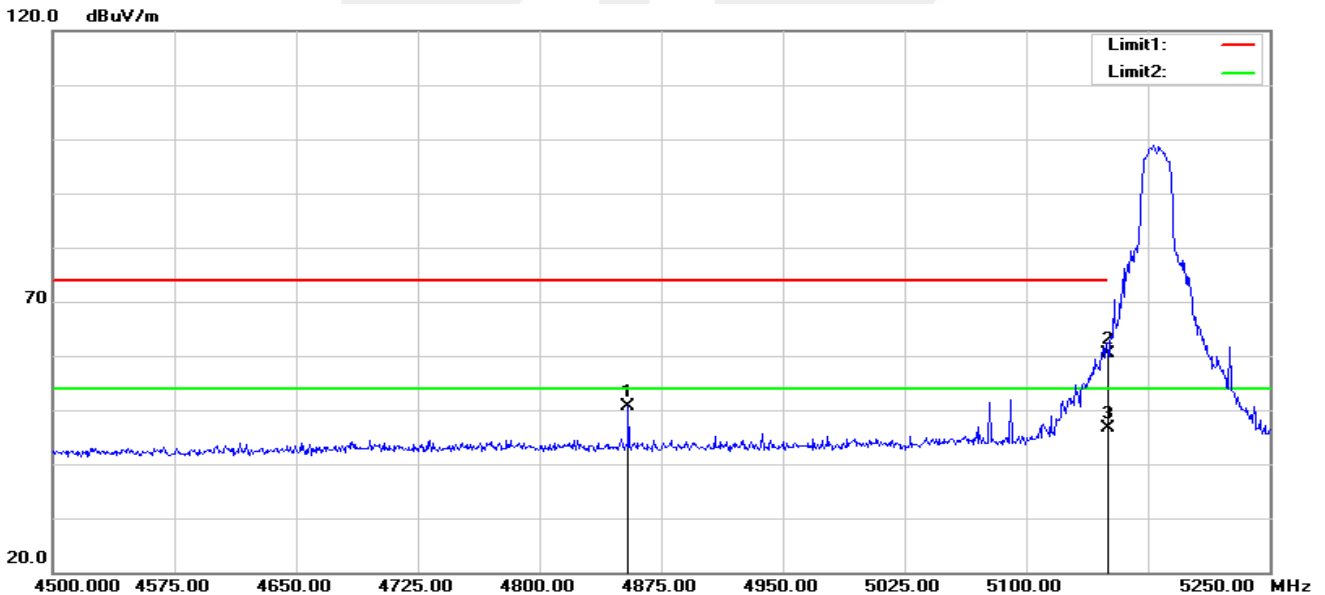

No.	Frequency (MHz)	Reading (dBuV)	Correct Factor(dB/m)	Result (dBuV/m)	Limit (dBuV/m)	Margin (dB)	Remark
1	4854.750	57.63	-7.01	50.62	74.00	-23.38	peak
2	5150.000	66.19	-5.73	60.46	74.00	-13.54	peak
3	5150.000	52.25	-5.73	46.52	54.00	-7.48	AVG



802.11a20-H-H

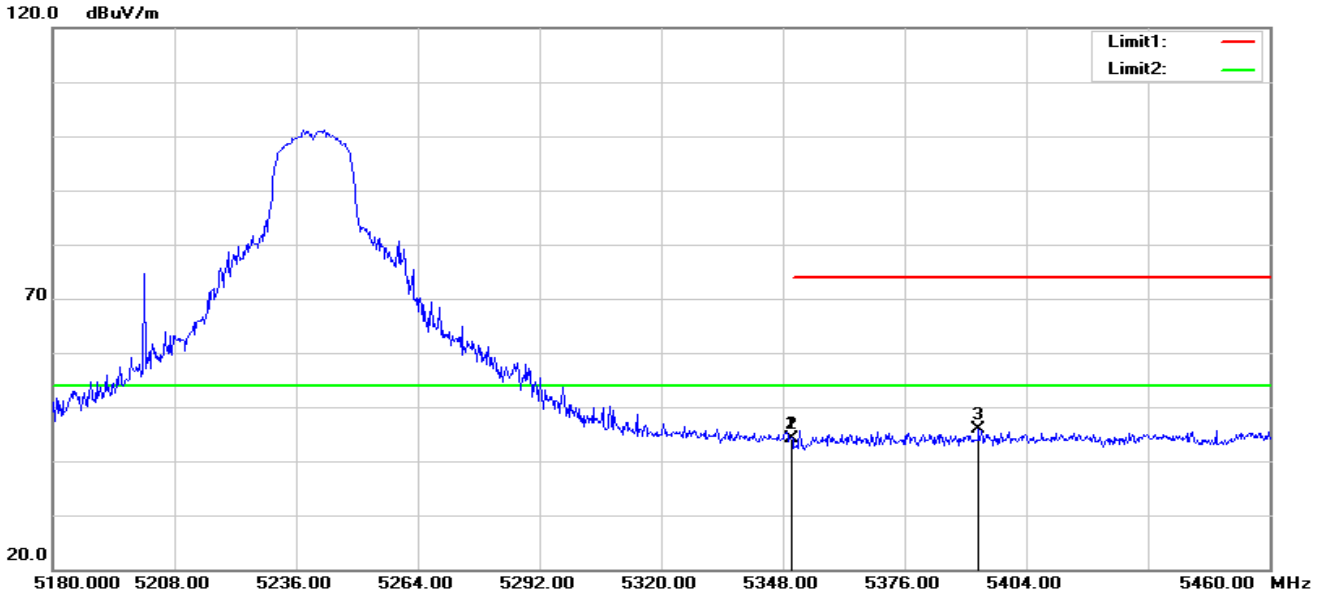

No.	Frequency (MHz)	Reading (dBuV)	Correct Factor(dB/m)	Result (dBuV/m)	Limit (dBuV/m)	Margin (dB)	Remark
1	5350.000	49.43	-5.23	44.20	74.00	-29.80	peak
2	5350.000	49.43	-5.23	44.20	74.00	-29.80	peak
3	5393.080	51.21	-5.25	45.96	74.00	-28.04	peak

802.11a20-H-V

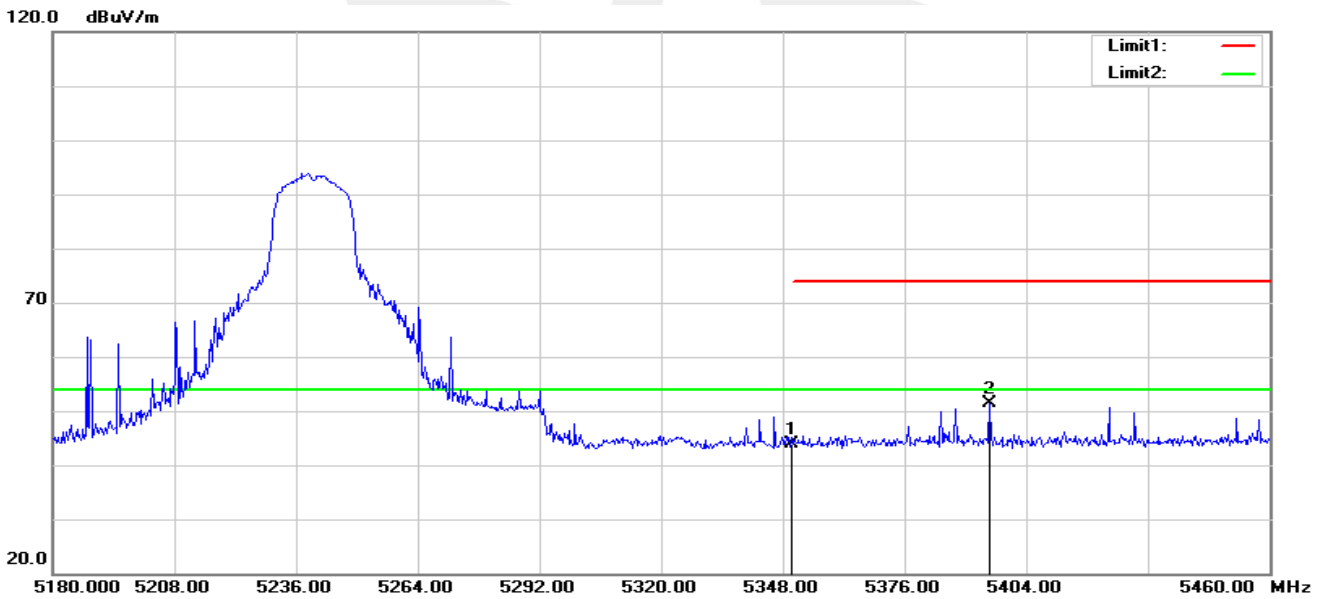

No.	Frequency (MHz)	Reading (dBuV)	Correct Factor(dB/m)	Result (dBuV/m)	Limit (dBuV/m)	Margin (dB)	Remark
1	5350.000	49.03	-5.23	43.80	74.00	-30.20	peak
2	5395.600	56.66	-5.24	51.42	74.00	-22.58	peak



802.11ac40-L-H

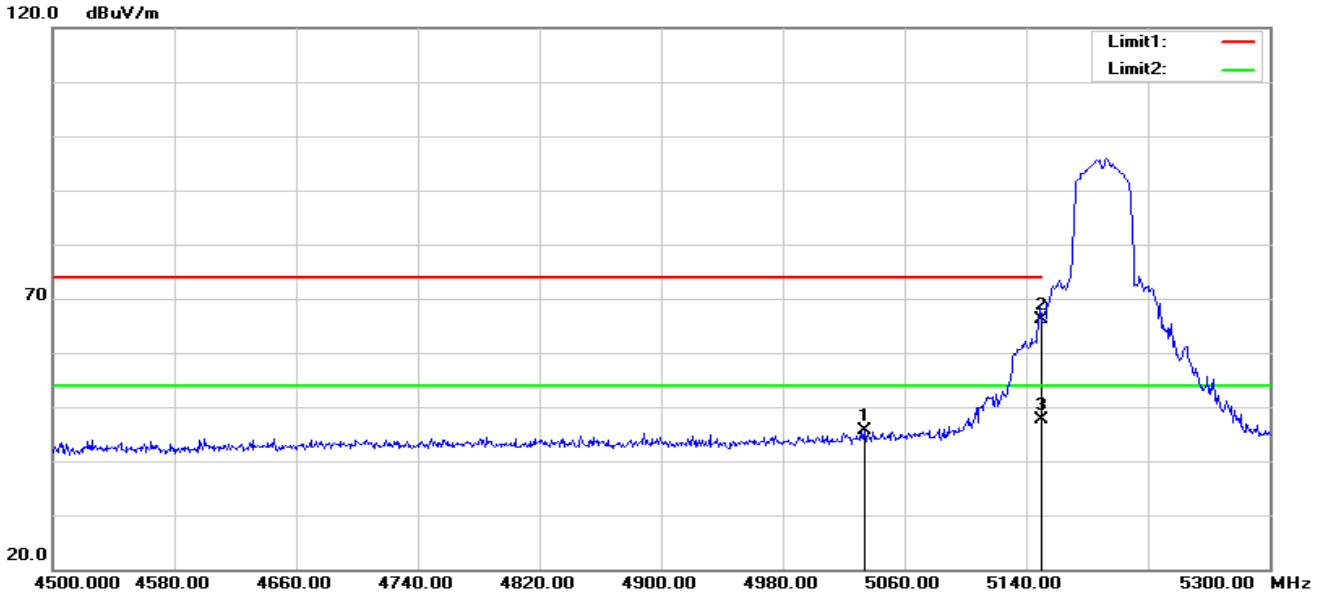

No.	Frequency (MHz)	Reading (dBuV)	Correct Factor(dB/m)	Result (dBuV/m)	Limit (dBuV/m)	Margin (dB)	Remark
1	5033.600	51.79	-6.04	45.75	74.00	-28.25	peak
2	5150.000	71.90	-5.73	66.17	74.00	-7.83	peak
3	5150.000	53.29	-5.73	47.56	54.00	-6.44	AVG

802.11ac40-L-V

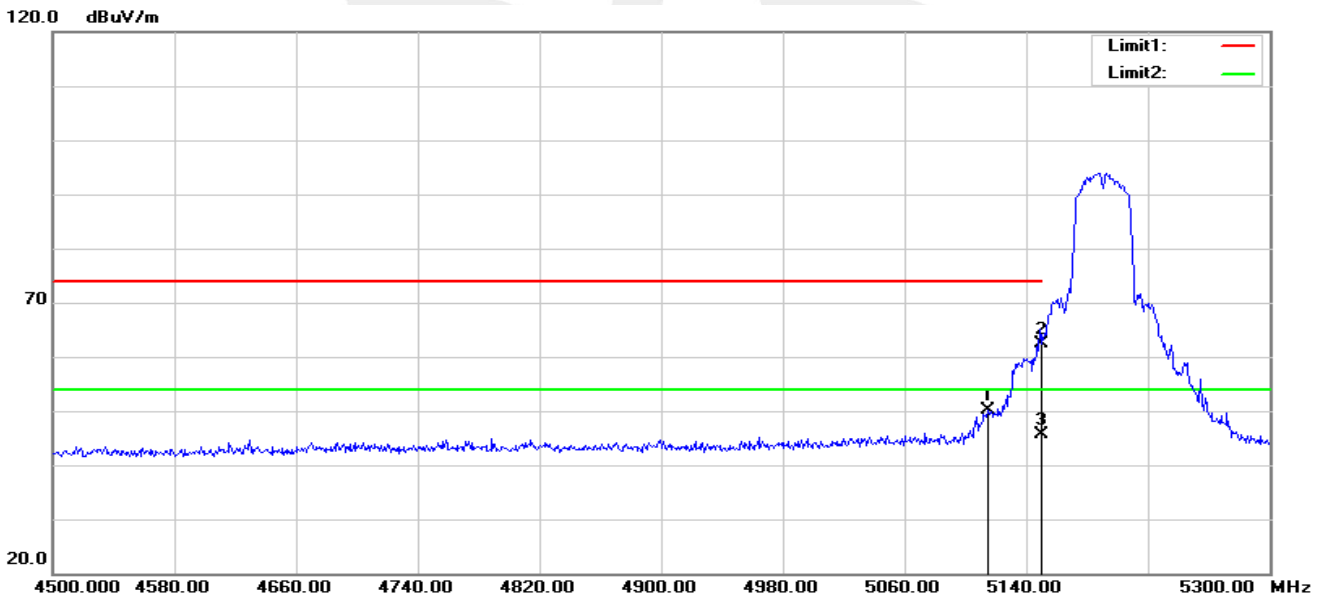

No.	Frequency (MHz)	Reading (dBuV)	Correct Factor(dB/m)	Result (dBuV/m)	Limit (dBuV/m)	Margin (dB)	Remark
1	5115.200	55.96	-5.74	50.22	74.00	-23.78	peak
2	5150.000	68.04	-5.73	62.31	74.00	-11.69	peak
3	5150.000	51.31	-5.73	45.58	54.00	-8.42	AVG



802.11ac40-H-V

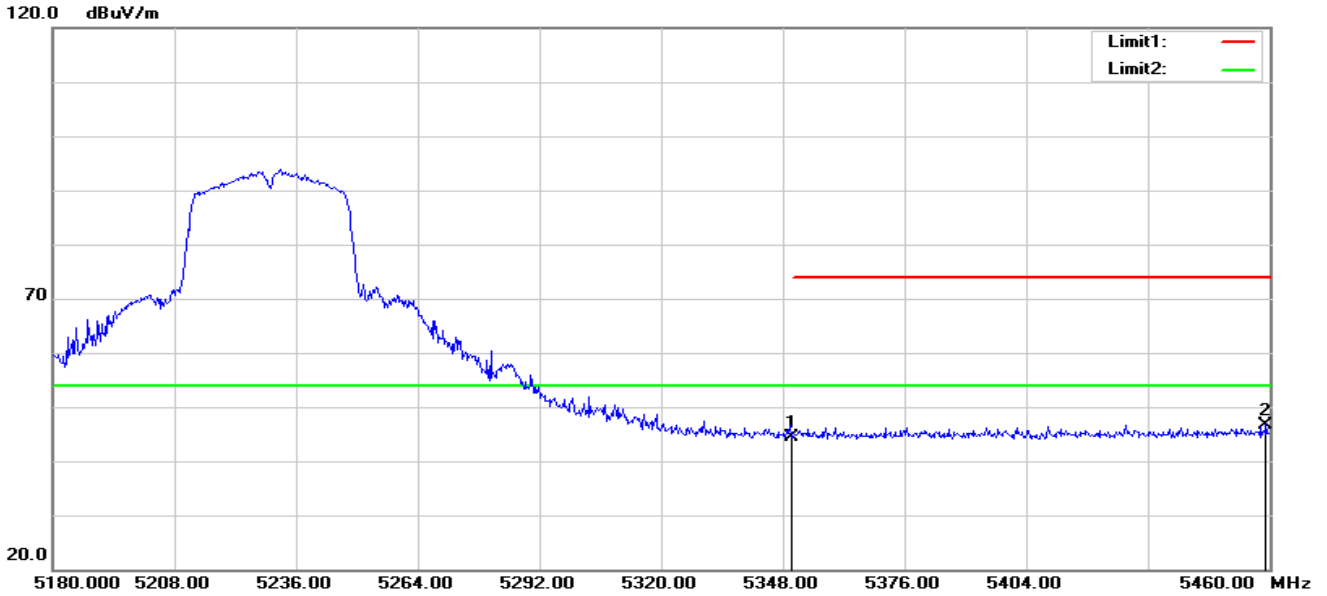

No.	Frequency (MHz)	Reading (dBuV)	Correct Factor(dB/m)	Result (dBuV/m)	Limit (dBuV/m)	Margin (dB)	Remark
1	5350.000	49.67	-5.23	44.44	74.00	-29.56	peak
2	5459.160	51.86	-5.11	46.75	74.00	-27.25	peak

802.11ac40-H-H

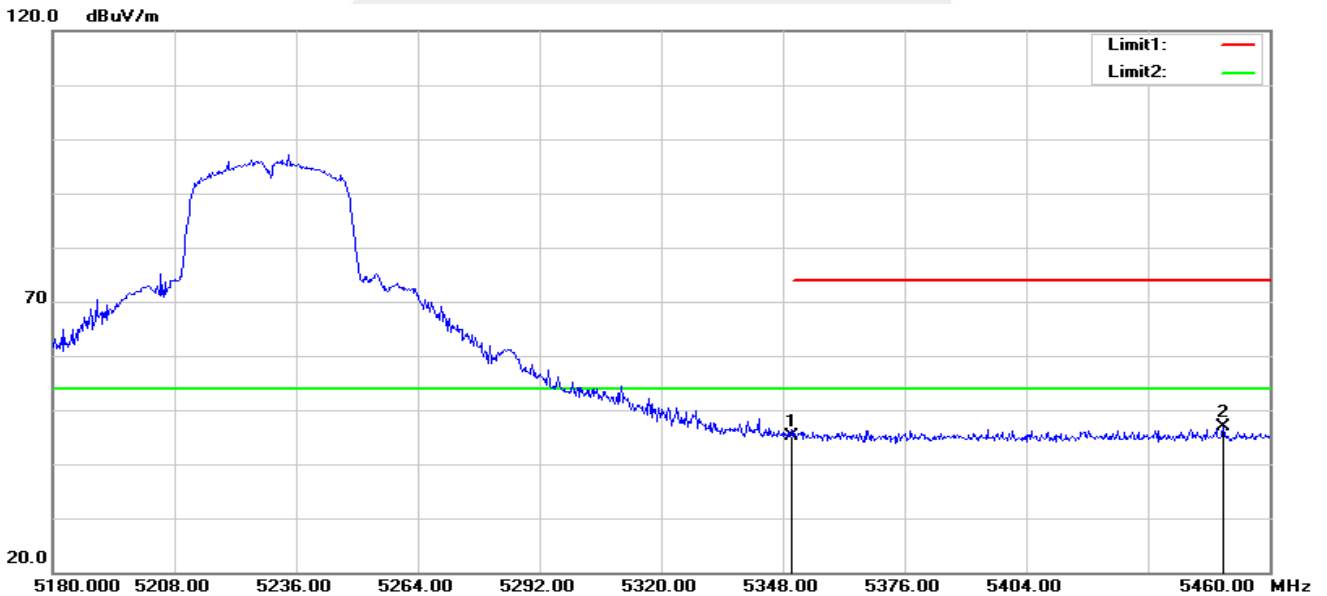

No.	Frequency (MHz)	Reading (dBuV)	Correct Factor(dB/m)	Result (dBuV/m)	Limit (dBuV/m)	Margin (dB)	Remark
1	5350.000	50.24	-5.23	45.01	74.00	-28.99	peak
2	5449.360	51.91	-5.14	46.77	74.00	-27.23	peak



802.11ac80-L-H

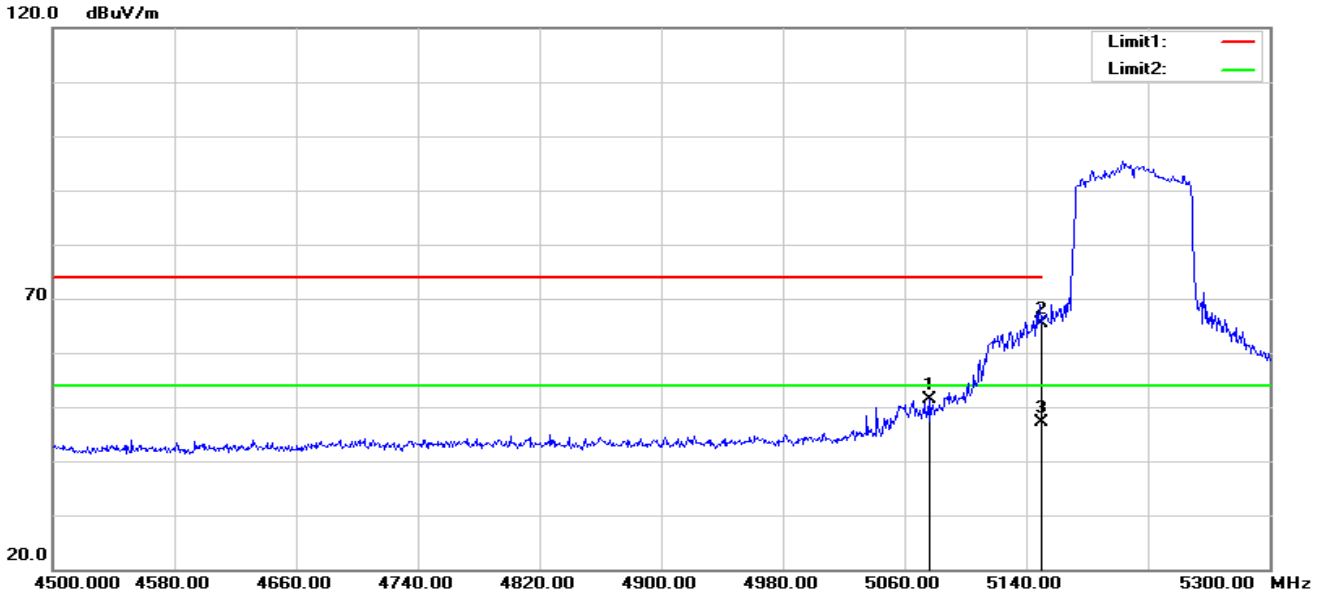

No.	Frequency (MHz)	Reading (dBuV)	Correct Factor(dB/m)	Result (dBuV/m)	Limit (dBuV/m)	Margin (dB)	Remark
1	5076.000	57.25	-5.85	51.40	74.00	-22.60	peak
2	5150.000	71.17	-5.73	65.44	74.00	-8.56	peak
3	5150.000	52.79	-5.73	47.06	54.00	-6.94	AVG

802.11ac80-L-V

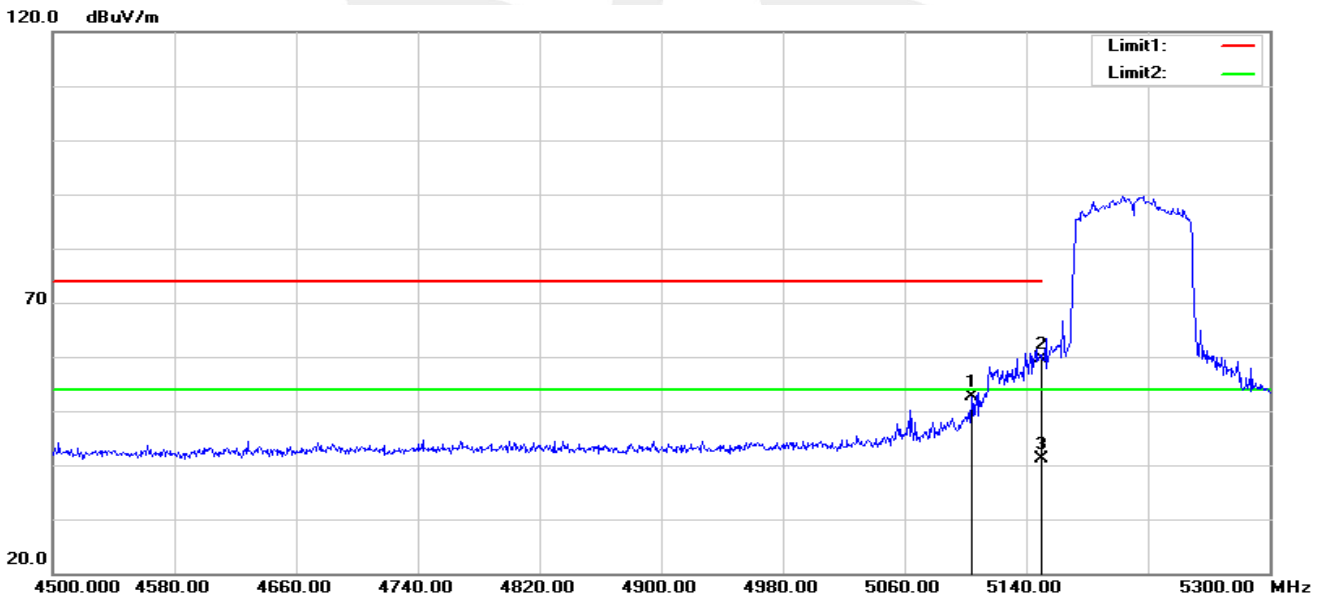

No.	Frequency (MHz)	Reading (dBuV)	Correct Factor(dB/m)	Result (dBuV/m)	Limit (dBuV/m)	Margin (dB)	Remark
1	5104.000	58.46	-5.74	52.72	74.00	-21.28	peak
2	5150.000	65.35	-5.73	59.62	74.00	-14.38	peak
3	5150.000	46.96	-5.73	41.23	54.00	-12.77	AVG



802.11ac80-H-H

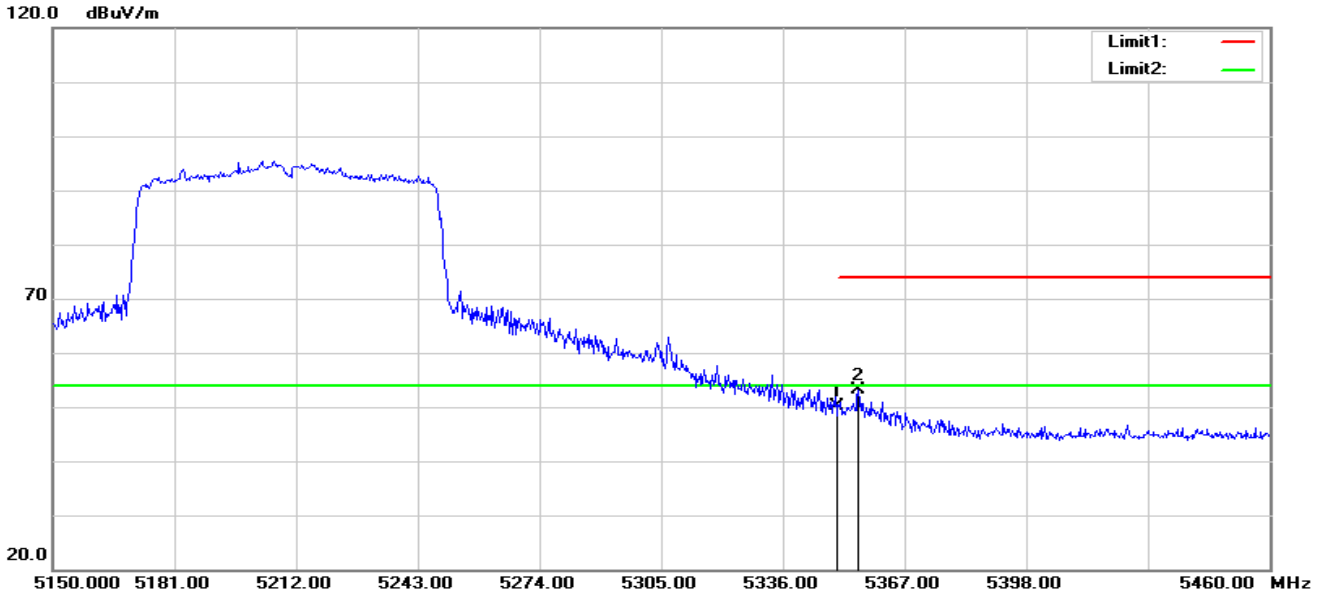

No.	Frequency (MHz)	Reading (dBuV)	Correct Factor(dB/m)	Result (dBuV/m)	Limit (dBuV/m)	Margin (dB)	Remark
1	5350.000	55.25	-5.23	50.02	74.00	-23.98	peak
2	5355.220	58.42	-5.24	53.18	74.00	-20.82	peak

802.11ac80-H-V

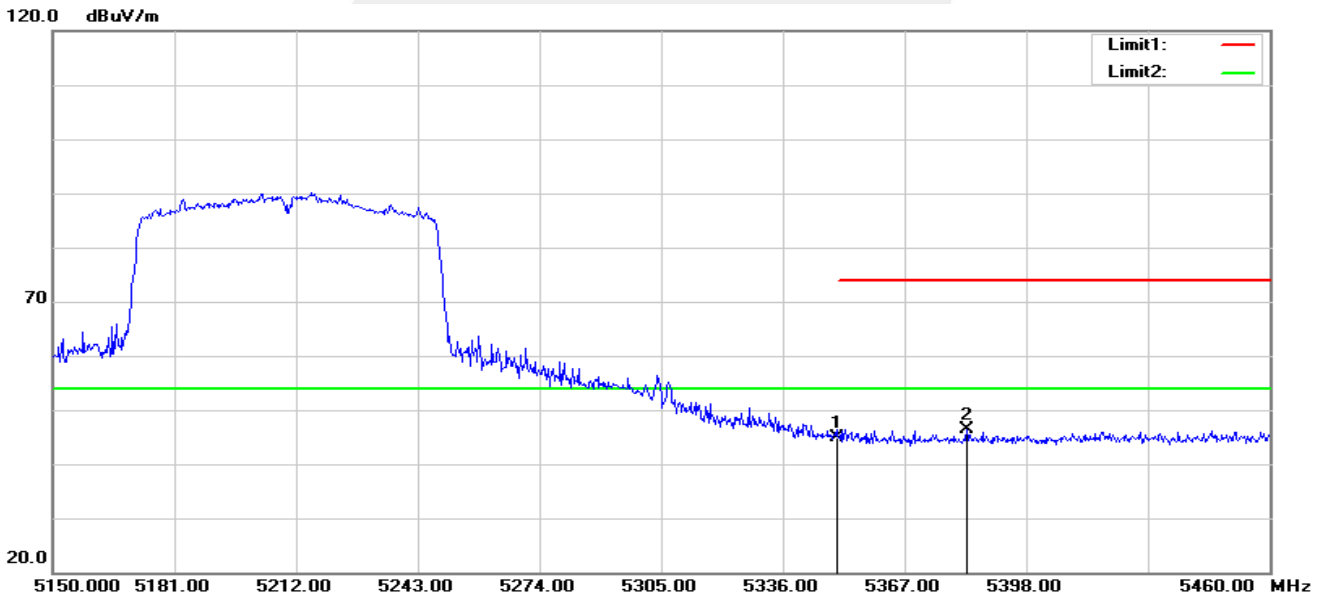

No.	Frequency (MHz)	Reading (dBuV)	Correct Factor(dB/m)	Result (dBuV/m)	Limit (dBuV/m)	Margin (dB)	Remark
1	5350.000	50.03	-5.23	44.80	74.00	-29.20	peak
2	5382.810	51.71	-5.24	46.47	74.00	-27.53	peak

Note: All modes have been tested. Only the worst mode shown in the report.



4. POWER SPECTRAL DENSITY TEST

4.1 LIMIT

1. For mobile and portable client devices in the 5.15-5.25 GHz band, , the maximum power spectral density shall not exceed 11 dBm in any 1 megahertz band. If transmitting antennas of directional gain greater than 6 dBi are used, both the maximum conducted output power and the maximum power spectral density shall be reduced by the amount in dB that the directional gain of the antenna exceeds 6 dBi.
2. For the 5.25-5.35 GHz and 5.47-5.725 GHz bands, the maximum power spectral density shall not exceed 11 dBm in any 1 megahertz band. If transmitting antennas of directional gain greater than 6 dBi are used, both the maximum conducted output power and the maximum power spectral density shall be reduced by the amount in dB that the directional gain of the antenna exceeds 6 dBi.
3. For the band 5.725-5.850 GHz, the peak power spectral density shall not exceed 30 dBm in any 500KHz band. If transmitting antenna directional gain is greater than 6 dBi, both the maximum conducted output power and the peak power spectral density shall be reduced by the amount in dB that the directional gain of the antenna exceeds 6 dBi.

4.2 TEST PROCEDURE

1. The setting follows Method SA-1 of FCC KDB D02 General UNII Test Procedures New Rules v01r03.

For devices operating in the band, the rules specify a measurement bandwidth of 500 kHz.

Many spectrum analyzers do not have 500 kHz RBW, thus a narrower RBW may need to be used.

The rules permit the use of a RBWs less than 1 MHz, or 500 kHz, "provided that the measured power is integrated over the full reference bandwidth" to show the total power over the specified measurement bandwidth (*i.e.*, 1 MHz, or 500 kHz). If measurements are performed using a reduced resolution bandwidth (< 1 MHz, or < 500 kHz) and integrated over 1 MHz, or 500 KHz bandwidth, the following adjustments to the procedures apply:

- a) Set $RBW \geq 1/T$, where T is defined in section II.B.I.a).
- b) Set $VBW \geq 3 RBW$.
- c) If measurement bandwidth of Maximum PSD is specified in 500 kHz, add $10 \log (500\text{kHz}/RBW)$ to the measured result, whereas $RBW (< 500 \text{ kHz})$ is the reduced resolution bandwidth of the spectrum analyzer set during measurement.
- d) If measurement bandwidth of Maximum PSD is specified in 1 MHz, add $10 \log (1\text{MHz}/RBW)$ to the measured result, whereas $RBW (< 1 \text{ MHz})$ is the reduced resolution bandwidth of spectrum analyzer set during measurement.
- e) Care must be taken to ensure that the measurements are performed during a period of continuous transmission or are corrected upward for duty cycle.

Note: As a practical matter, it is recommended to use reduced RBW of 100 kHz for the sections 5.c) and 5.d) above, since $RBW=100 \text{ KHZ}$ is available on nearly all spectrum analyzers.

4.3 DEVIATION FROM STANDARD

No deviation.

4.4 TEST SETUP



4.5 EUT OPERATION CONDITIONS

The EUT tested system was configured as the statements of 2.1 Unless otherwise a special operating condition is specified in the follows during the testing.

4.6 TEST RESULTS

5150-5250MHz					
Frequency	Direct measurement Power Density (dBm)	Duty cycle factor (dB)	Final Power Density (dBm)	Limit (dBm)	Result
802.11a					
5180	7.400	0.098	7.498	11	PASS
5200	7.479	0.098	7.577	11	PASS
5240	7.155	0.098	7.253	11	PASS
802.11n20					
5180	6.783	0.104	6.887	11	PASS
5200	6.490	0.104	6.594	11	PASS
5240	6.613	0.104	6.717	11	PASS
802.11n40					
5190	3.864	0.219	4.083	11	PASS
5230	3.628	0.219	3.847	11	PASS
802.11ac20					
5180	6.835	0.090	6.925	11	PASS
5200	6.861	0.090	6.951	11	PASS
5240	6.497	0.090	6.587	11	PASS
802.11ac40					
5190	3.724	0.217	3.941	11	PASS
5230	3.549	0.217	3.766	11	PASS
802.11ac80					
5210	0.092	0.376	0.468	11	PASS

Note: 1. RB conversion formula: $10 \cdot \text{LOG}(500\text{KHz}/\text{RBW})$
 2. Test plots see Attachment A

5. BANDWIDTH MEASUREMENT

5.1 EMISSION BANDWIDTH (EBW) 26 BANDWID PROCEDURES / LIMIT

The following procedure shall be used for measuring 26 bandwidth.

5.1.1 TEST PROCEDURE

1. The testing follows FCC KDB 789033 D02 General UNII Test Procedures New Rules v02r01
2. Set RBW = approximately 1% of the emission bandwidth.
3. Set the VBW \geq RBW.
4. Detector = Peak.
5. Trace mode = max hold.
6. Measure the maximum width of the emission that is 26 dB down from the peak of the emission. Compare this with the RBW setting of the analyzer. Readjust RBW and repeat measurement as needed until the RBW/EBW ratio is approximately 1%.

5.1.2 DEVIATION FROM STANDARD

No deviation.

6.1.3 TEST SETUP



5.1.4 EUT OPERATION CONDITIONS

The EUT tested system was configured as the statements of 2.4 Unless otherwise a special operating condition is specified in the follows during the testing.

**5.1.5 TEST RESULTS**

Frequency (MHz)	26dB Bandwidth (MHz)	Pass/Fail
802.11a		
5180	22.95	Pass
5200	23.94	Pass
5240	24.19	Pass
802.11n(HT20)		
5180	23.70	Pass
5200	23.63	Pass
5240	23.59	Pass
802.11n(HT40)		
5190	47.84	Pass
5230	47.85	Pass
802.11ac(VHT20)		
5180	23.61	Pass
5200	24.12	Pass
5240	23.65	Pass
802.11ac(VHT40)		
5190	47.47	Pass
5230	47.91	Pass
802.11ac(VHT80)		
5210	97.49	Pass

Test plot see Attachment B

5.2 OCCUPIED BANDWIDTH (99%) TEST APPLIED PROCEDURES / LIMIT

The following procedure shall be used for measuring (99 %) power bandwidth.

5.2.1 TEST PROCEDURE

1. The testing follows FCC KDB 789033 D02 General UNII Test Procedures v02r01. The following procedure shall be used for measuring (99 %) power bandwidth:
 1. Set center frequency to the nominal EUT channel center frequency.
 2. Set span = 1.5 times to 5.0 times the OBW.
 3. Set RBW = 1 % to 5 % of the OBW
 4. Set VBW $\geq 3 \cdot$ RBW
 5. Video averaging is not permitted. Where practical, a sample detection and single sweep mode shall be used. Otherwise, peak detection and max hold mode (until the trace stabilizes) shall be used.
 6. Use the 99 % power bandwidth function of the instrument (if available).
 7. If the instrument does not have a 99 % power bandwidth function, the trace data points are recovered and directly summed in power units. The recovered amplitude data points, beginning at the lowest frequency, are placed in a running sum until 0.5 % of the total is reached; that frequency is recorded as the lower frequency. The process is repeated until 99.5 % of the total is reached; that frequency is recorded as the upper frequency. The 99% occupied bandwidth is the difference between these two frequencies.

5.2.2 DEVIATION FROM STANDARD

No deviation.

5.2.3 TEST SETUP



5.2.4 EUT OPERATION CONDITIONS

The EUT tested system was configured as the statements of 2.4 Unless otherwise a special operating condition is specified in the follows during the testing.

**5.2.5 TEST RESULTS**

Frequency (MHz)	99% Bandwidth (MHz)	Pass/Fail
802.11a		
5180	16.60	Pass
5200	16.67	Pass
5240	16.77	Pass
802.11n(HT20)		
5180	17.72	Pass
5200	17.74	Pass
5240	17.73	Pass
802.11n(HT40)		
5190	36.22	Pass
5230	36.24	Pass
802.11ac(VHT20)		
5180	17.74	Pass
5200	17.76	Pass
5240	17.79	Pass
802.11ac(VHT40)		
5190	36.23	Pass
5230	36.38	Pass
802.11ac(VHT80)		
5210	75.66	Pass

Test plot See Attachment B

5.3 MINIMUM EMISSION BANDWIDTH(6 DB) PROCEDURES / LIMIT

Section 15.407(e) specifies the minimum 6 dB emission bandwidth of at least 500 KHz for the band 5.725-5.85 GHz. The following procedure shall be used for measuring this bandwidth.

5.3.1 TEST PROCEDURE

1. The testing follows FCC KDB 789033 D02 General UNII Test Procedures v02r01.
 - a) Set RBW = 100 kHz.
 - b) Set the video bandwidth (VBW) $\geq 3 \times$ RBW.
 - c) Detector = Peak.
 - d) Trace mode = max hold.
 - e) Sweep = auto couple.
 - f) Allow the trace to stabilize.
 - g) Measure the maximum width of the emission that is constrained by the frequencies associated with the two outermost amplitude points (upper and lower frequencies) that are attenuated by 6 dB relative to the maximum level measured in the fundamental emission.

5.3.2 DEVIATION FROM STANDARD

No deviation.

5.3.3 TEST SETUP



5.3.4 EUT OPERATION CONDITIONS

The EUT tested system was configured as the statements of 2.4 Unless otherwise a special operating condition is specified in the follows during the testing.

5.3.5 TEST RESULTS

Note: The EUT not support Band 5.725-5.85 GHz, not applicable.

6. MAXIMUM CONDUCTED OUTPUT POWER

6.1 LIMIT

For mobile and portable client devices in the 5.15-5.25 GHz band, the maximum conducted output power over the frequency band of operation shall not exceed 250 mW provided the maximum antenna gain does not exceed 6 dBi. If transmitting antennas of directional gain greater than 6 dBi are used, both the maximum conducted output power and the maximum power spectral density shall be reduced by the amount in dB that the directional gain of the antenna exceeds 6 dBi.

For the 5.25-5.35 GHz and 5.47-5.725 GHz bands, the maximum conducted output power over the frequency bands of operation shall not exceed the lesser of 250 mW or 11 dBm + 10 log B, where B is the 26 dB emission bandwidth in megahertz, If transmitting antennas of directional gain greater than 6 dBi are used.

For the band 5.725-5.85 GHz, the maximum conducted output power over the frequency band of operation shall not exceed 1 W. If transmitting antennas of directional gain greater than 6 dBi are used.

FCC Part15 (15.407) , Subpart E				
Section	Test Item	Limit	Frequency Range (MHz)	Result
15.407(a) (1) (iv)	Peak Output Power	0.25 watt	5150-5250	PASS
		The lesser of 250 mW or 11 dBm + 10 log (26 dB emission bandwidth)	5250-5350 5470-5725	
15.407(a) (3)		1 watt	5725-5825	

6.2 TEST PROCEDURE

The EUT was directly connected to the Power Sensor&PC

6.3 DEVIATION FROM STANDARD

No deviation.

6.4 TEST SETUP

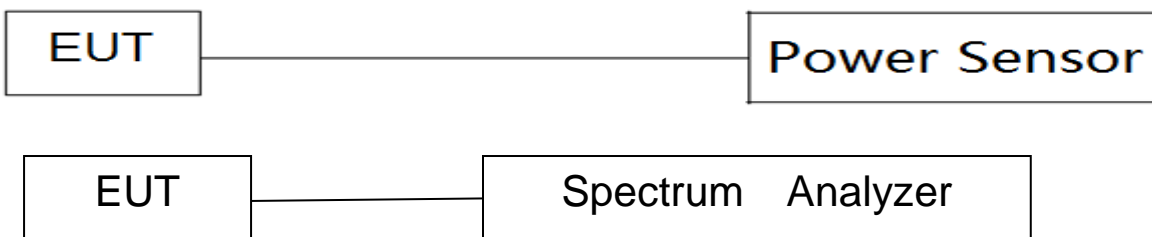

6.5 EUT OPERATION CONDITIONS

The EUT tested system was configured as the statements of 5 Unless otherwise a special operating condition is specified in the follows during the testing.



6.6 TEST RESULTS

Band I (5.15-5.25GHz)					
Test Channel	Frequency (MHz)	Direct measurement AV Power (dBm)	Duty cycle factor (dB)	Final AV Power (dBm)	LIMIT (dBm)
802.11a					
36	5180	17.53	0.098	17.63	23.98
40	5200	16.96	0.098	17.06	23.98
48	5240	16.86	0.098	16.96	23.98
802.11n(HT20)					
36	5180	16.72	0.104	16.82	23.98
40	5200	16.50	0.104	16.60	23.98
48	5240	16.57	0.104	16.67	23.98
802.11n(HT40)					
38	5190	16.10	0.219	16.32	23.98
46	5230	16.13	0.219	16.35	23.98
802.11ac(VHT20)					
36	5180	16.78	0.090	16.87	23.98
40	5200	16.55	0.090	16.64	23.98
48	5240	16.61	0.090	16.70	23.98
802.11ac(VHT40)					
38	5190	16.10	0.217	16.32	23.98
46	5230	16.16	0.217	16.38	23.98
802.11ac(VHT80)					
42	5210	16.02	0.376	16.40	23.98

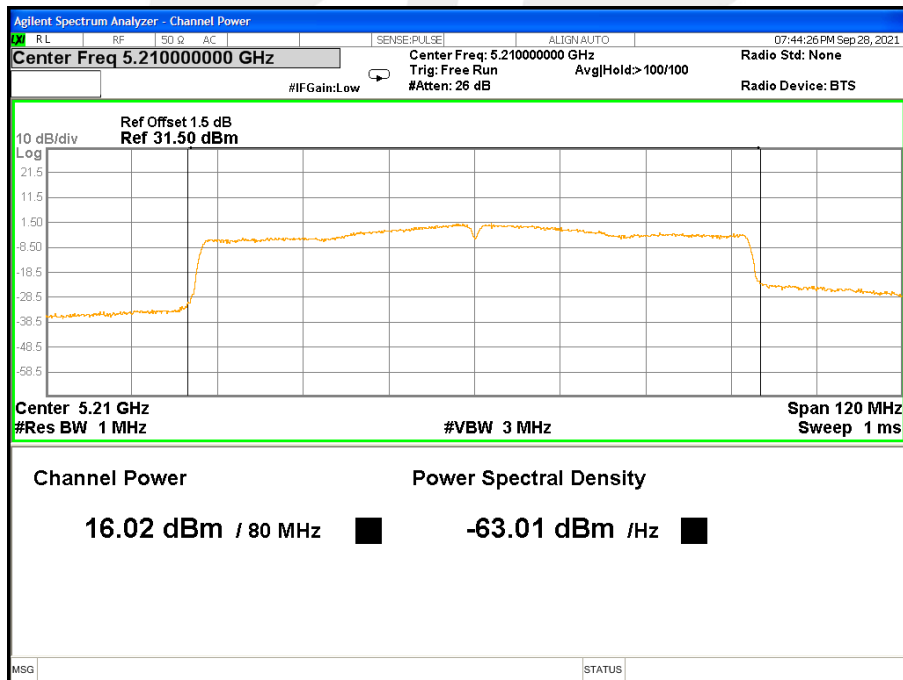

5210MHz_AV_Ant A



Duty cycle

Band1				
Mode	Ton(ms)	Tp(ms)	Duty cycle(%)	Duty factor(dB)
a	1.408	1.440	97.78%	0.098
n20	1.320	1.352	97.63%	0.104
n40	0.656	0.690	95.07%	0.219
ac20	1.332	1.360	97.94%	0.090
ac40	0.664	0.698	95.13%	0.217
ac80	0.336	0.366	91.70%	0.376



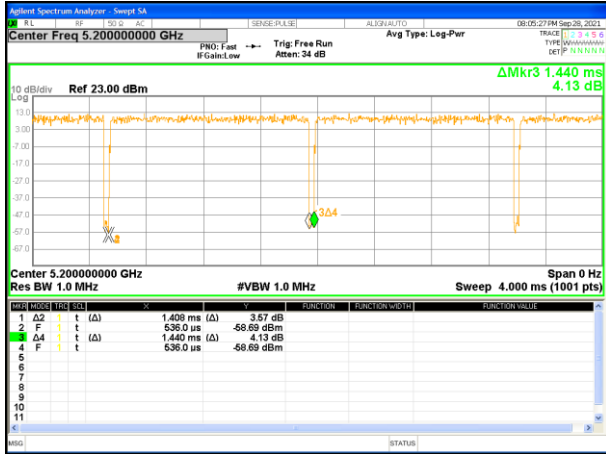

Band 1-a20

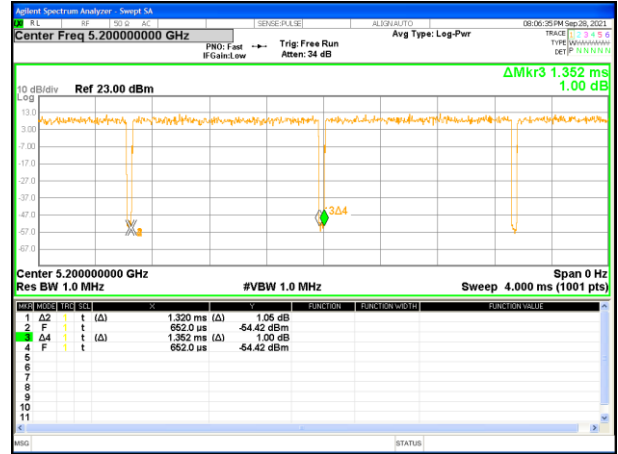

Band 1-n20



Band 1-n40

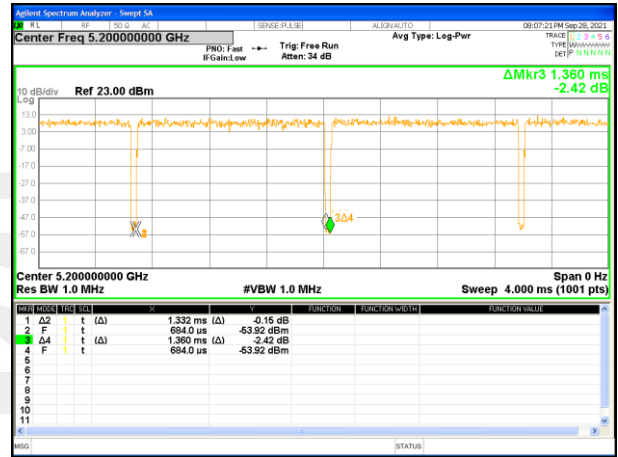

Band 1-ac20



Band 1-ac40

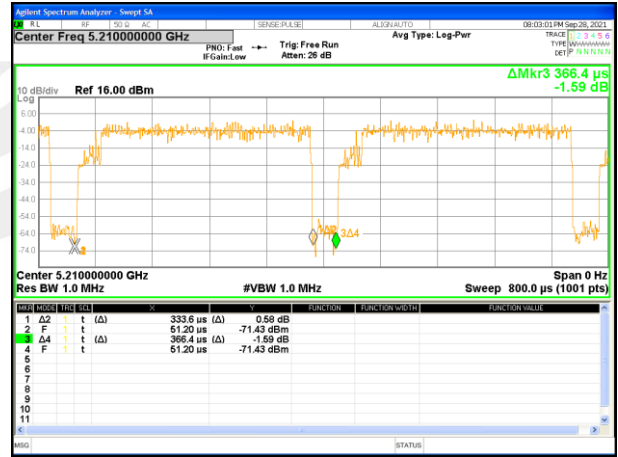

Band 1-ac80



7. AUTOMATICALLY DISCONTINUE TRANSMISSION

7.1 LIMIT OF AUTOMATICALLY DISCONTINUE TRANSMISSION

The device shall automatically discontinue transmission in case of either absence of information to transmit or operational failure. These provisions are not intended to preclude the transmission of control or signaling information or the use of repetitive codes used by certain digital technologies to complete frame or burst intervals. Applicants shall include in their application for equipment authorization to describe how this requirement is met.

7.2 TEST RESULT OF AUTOMATICALLY DISCONTINUE TRANSMISSION

During no any information transmission, the EUT can automatically discontinue transmission and become standby mode for power saving. The EUT can detect the controlling signal of ACK message transmitting from remote device and verify whether it shall resend or discontinue transmission.





8. ANTENNA REQUIREMENT

8.1 STANDARD REQUIREMENT

15.203 requirement: For intentional device, according to 15.203: an intentional radiator shall be designed to ensure that no antenna other than that furnished by the responsible party shall be used with the device.

8.2 EUT ANTENNA

The EUT antenna is PIFA Antenna. It comply with the standard requirement.





APPENDIX - PHOTOS OF TEST SETUP

Note: See test photos in setup photo document for the actual connections between Product and support equipment.

*****END OF THE REPORT*****

