

QUICK START GUIDE

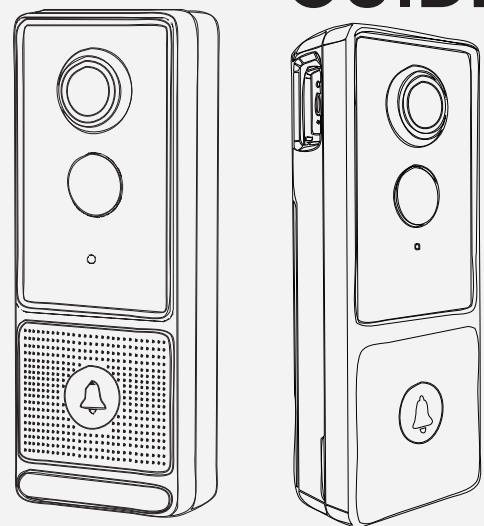

1. Meet the doorbell

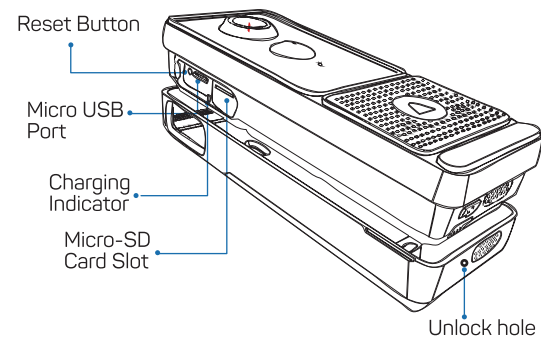
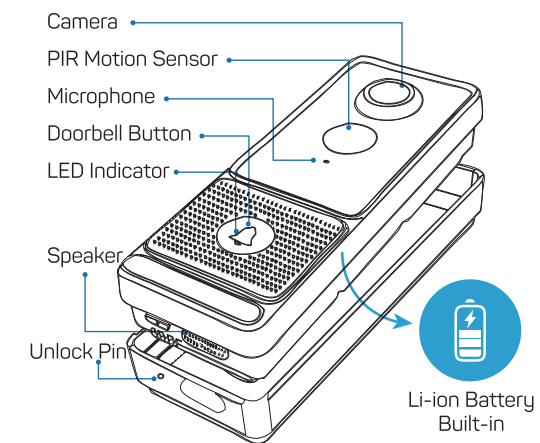

2. Meet the chime

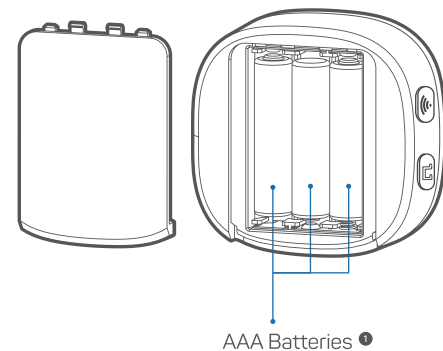
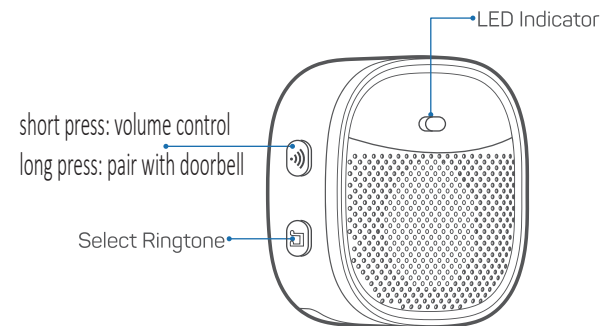

1 Please mind the battery polarities when installing.

3. Charge your doorbell

Prior to the doorbell installation, please charge up your doorbell for about 8-10 hours till the charging LED turns BLUE from RED.

LED STATUS	INDICATION
Solid red	Battery charging
Solid blue	Fully charged

Compatible charger

USB compatible mobile phone charger (DC 5V = 1A~2A).

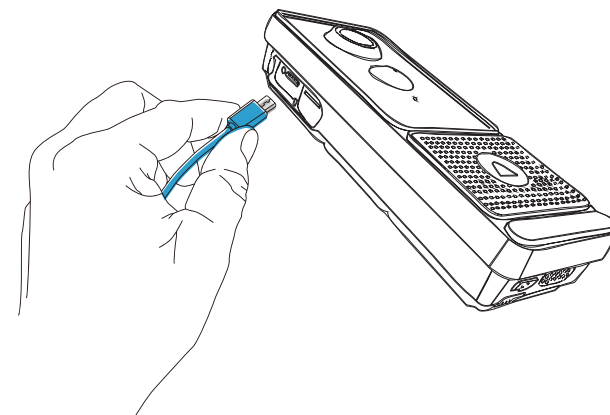

4. App download

Search 'CloudEdge' in the App stores or scan below QR codes to download the App.



iOS



Android

5. Set up doorbell

1 Press your doorbell to activate, and you will see the LED indicator flashes red (once per second). If not, press and hold reset button for 5 seconds to restore factory defaults.

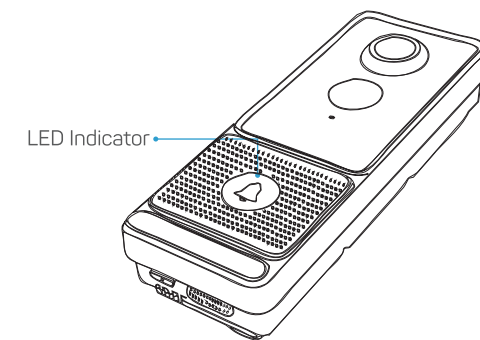

2 Start setting up your doorbell following the in-app instructions.

3 Tips

- Please operate the setup near your Wi-Fi router.
- Make sure your phone is connecting to a 2.4GHz Wi-Fi.
- Make sure the doorbell is turned on, and its indicator LED is flashing red. If not, press and hold RESET for 5 seconds.
- Ensure the Wi-Fi signal is good, and the Wi-Fi password is correct.

LED STATUS	INDICATION
Solid red	Device is abnormal.
Flash red (once/sec)	Ready for Wi-Fi configuration.
Flash red (twice/sec)	Connecting to Wi-Fi
Solid blue	Device is online
Flash blue (once/sec)	Live-viewing doorbell cam
Flash blue (twice/sec)	Firmware upgrading

Note: Manual contents are subject to change without notice in accordance with our policy of continuous product improvement.

6. Pair with your indoor chime

- 1 Long press the above button of Chime and the chime is on the pair status for 20 seconds and then red LED light flash

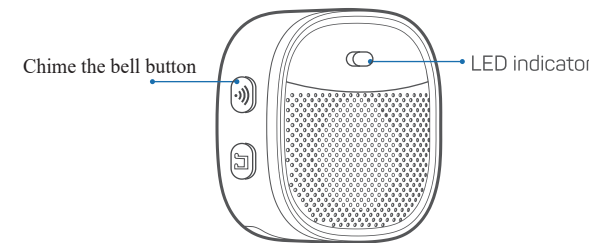

- 2 Press the doorbell button to send a pairing signal, and your chime will sound to react, together with its blue LED flashing. Chime pairing succeeds.

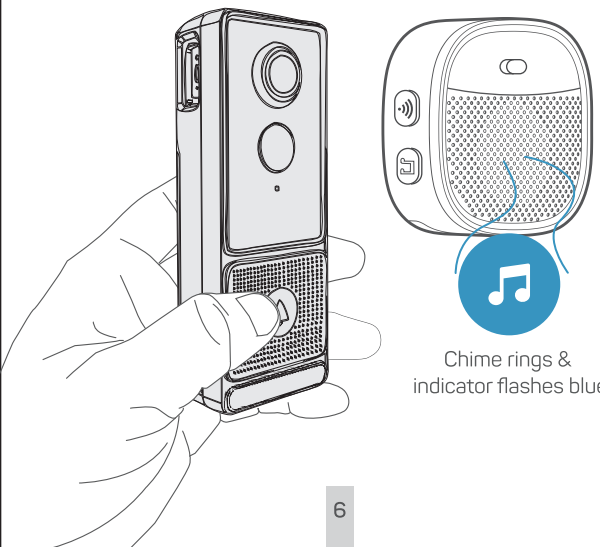

3 Chime settings.

- Long press: pair with doorbell
Press & hold for 5 seconds to restore factory defaults.

Short press: volume control
Click to control volume: 5-speed volume

- Ringtone selection.
Click to change ringtone (16 ringtones available).

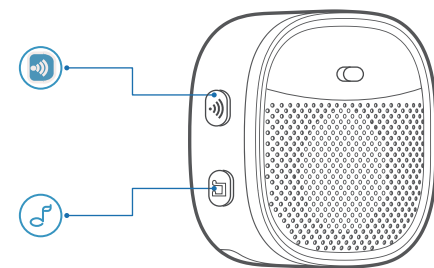

7. Install Your doorbell

- 1 Select location for your doorbell.

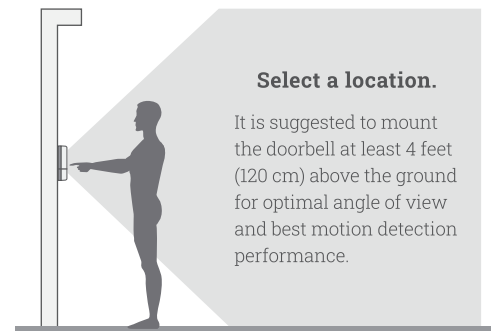

- 2 Mount your doorbell.

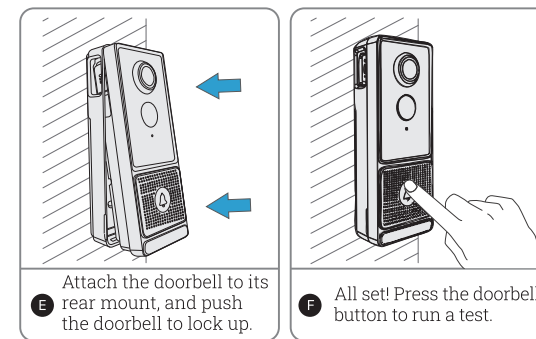
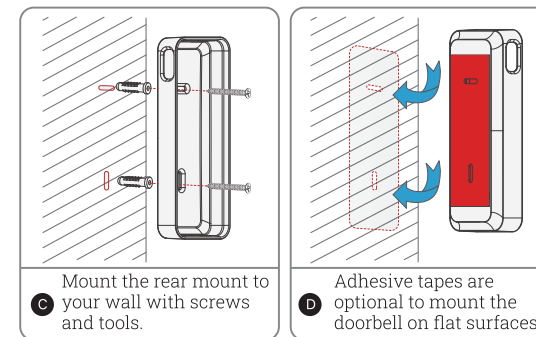
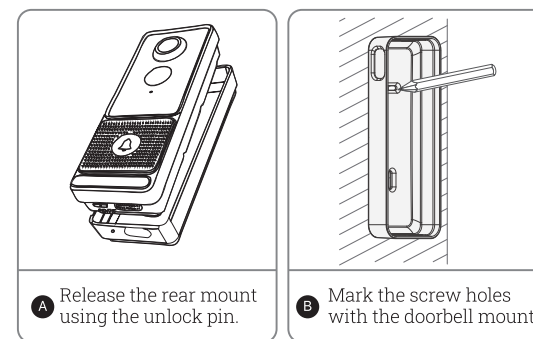

8. Trouble Shooting

Q1: Is the video doorbell powered by battery?

A1: Yes, there is a Li-ion battery built-in. Thanks to the low power consumption technology, a full charge lasts for more than 2 to 3 months in our lab test environment (Lab test condition: 10 events per day, 15 seconds video recording per event).

Q2: Does it work with existing mechanical chime?

A2: No. The doorbell comes with a battery powered wireless chime to notify people when your visitor presses the doorbell button. And our wireless chime is 100% wireless, you can place it almost everywhere you like. The transmission distance in open space is more than 100 meters (328 feet).

Q3: How many wireless chimes can be added to the doorbell?

A3: You can add several wireless chimes to work with your video doorbell. And one chime can be paired with upto 8 video doorbells.

Q4: Does it support customized Motion Detection Zones.

A4: Yes it does. You can customize the detection zone in the doorbell settings.

Q5: Does the doorbell support cloud storage?

A5: Your doorbell support local video storage by TF card . And you can also activate the cloud storage service in the App so as to back up video clips into the cloud server. There is a 7-day-free cloud recording trial service.

This device complies with part 15 of the FCC Rules. Operation is subject to the following two conditions: (1) This device may not cause harmful interference, and (2) this device must accept any interference received, including interference that may cause undesired operation.

Any Changes or modifications not expressly approved by the party responsible for compliance could void the user's authority to operate the equipment.

Note: This equipment has been tested and found to comply with the limits for a Class B digital device, pursuant to part 15 of the FCC Rules. These limits are designed to provide reasonable protection against harmful interference in a residential installation. This equipment generates uses and can radiate radio frequency energy and, if not installed and used in accordance with the instructions, may cause harmful interference to radio communications. However, there is no guarantee that interference will not occur in a particular installation. If this equipment does cause harmful interference to radio or television reception, which can be determined by turning the equipment off and on, the user is encouraged to try to correct the interference by one or more of the following measures:

- Reorient or relocate the receiving antenna.
- Increase the separation between the equipment and receiver.
- Connect the equipment into an outlet on a circuit different from that to which the receiver is connected.
- Consult the dealer or an experienced radio/TV technician for help.

This equipment complies with FCC radiation exposure limits set forth for an uncontrolled environment. This equipment should be installed and operated with minimum distance 20cm between the radiator & your body.