

129g铜版纸 过哑油

成品尺寸：130\*160mm

设计尺寸：136\*166mm（含出血3mm）

彩印

骑马订

MORECam

J2



# USER MANUAL

1080P Battery-Powered Doorbell Camera



# CATALOG

---

● WARM SUPPORT .....	01
● PRODUCT DESCRIPTION .....	02
● HOW TO ADD A CAMERA TO APP .....	04
Download "Cloud Edge" APP .....	04
Register Account .....	06
Power on Camera .....	07
Connect WI-FI Steps .....	08
● CONNETCT THE CHIME .....	12
● MOUNTING THE CAMERA TO THE WALL .....	13
● FUNCTION INTRODUCTION .....	19
Main Page .....	19
Preview page .....	19
Video replay page .....	20
Setup page .....	21
Device Sharing .....	22
SD card recording .....	22
PIR motion detection settings .....	23
Battery Management .....	25
● TROUBLESHOOTING/FAQ .....	29

# WARM SUPPORT

---

Dear Friends,

Congratulations on purchasing one of the best security cameras on the market! We appreciate your business and want to earn your trust. Please refer to the notes below and follow the instructions in this manual to ensure that you use the action camera correctly and have a good experience with this product.

If your camera does not seem to be functioning properly, please check the Troubleshooting / FAQ section. You also can contact our support team:

[support@morecam.cn](mailto:support@morecam.cn). We will provide a fast solution in 24 hours.

Problems are often due to something simple that was overlooked, or require only changing one setting to solve.

Thank you again for ordering from Morecam. We truly appreciate your business. We LOVE our customers and we will always be here with our professional camera engineers.

Wishing you the best,

Morecam Customer Support Team



**SCAN ME**

# PRODUCT DESCRIPTION

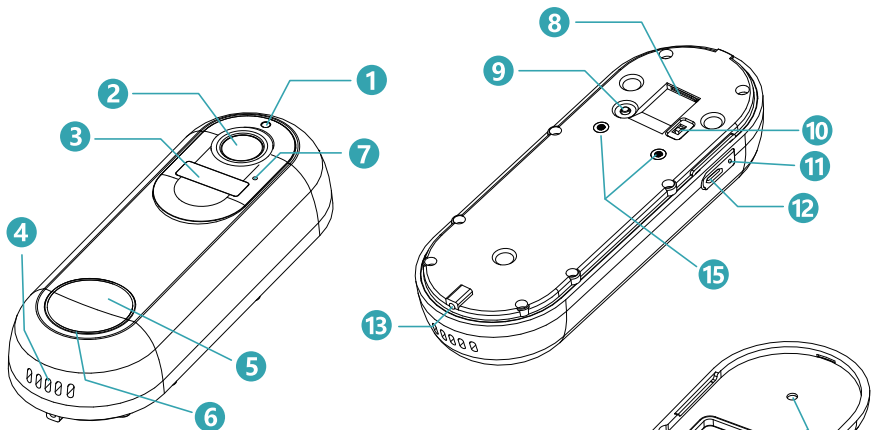

- 1 Photoresistor
- 2 Camera
- 3 PIR Motion Sensor
- 4 Speaker
- 5 Doorbell Button
- 6 LED Indicator
- 7 Microphone
- 8 Memory Card Slot
- 9 Reset Button
- 10 On / Off Switch

- 11 Charging Indicator
- 12 Micro USB Port
- 13 Security Screw Hole
- 14 Security Screw
- 15 Hardwire Terminals
- 16 Wall Mount Screw Holes

<b>Power Key</b>	Move the button to turn on/off the camera
<b>Reset Key</b>	Press and hold RESET for 5 seconds to reset the device to factory setting.(You will hear 'Bugu' if reset successfully)
<b>SD Card Slot</b>	Support local SD card storage (up to 128G)
<b>Lens</b>	Support FHD 1080P resolution
<b>Power Light</b>	Red means charging, Blue means fully charged
<b>Microphone</b>	Capture sound for your videos
<b>PIR Sensor</b>	Can detect moving objects up to 50FT away
<b>Working Status Light</b>	Solid on red: Device is abnormal Flashing red slowly: Ready for Wi-Fi connection Flashing red quickly: Wi-Fi connecting Solid on blue: Wi-Fi connected Successfully
<b>Speaker</b>	Two-way audio output
<b>USB Charge Port</b>	Use 5V/2A USB standard charger and micro USB cable to charge the camera
<b>Hardwire Terminals</b>	Installation requires existing doorbell wires at AC 12-24 V
<b>Safety Screw</b>	Prevent your doorbell camera from being stolen

# HOW TO ADD A CAMERA TO APP

---

## 1. DOWNLOAD "CLOUDEDGE" APP

Search "CloudEdge" in App Store or Google Play, or scan the QR code below to download and install it on your smartphone.



### TIPS

Please turn on the following 2 permissions when using the application for the first time,

- ① Allow "CloudEdge" to access mobile cellular data and WLAN, otherwise you will not be able to add devices.
- ② Allow "CloudEdge" to receive messages, otherwise the phone will not receive alert push notifications when motion detection or audible alerts are triggered.



## TIPS

The following is a screenshot of iOS cell phone operation, Android cell phone permissions open method is basically the same as this method.

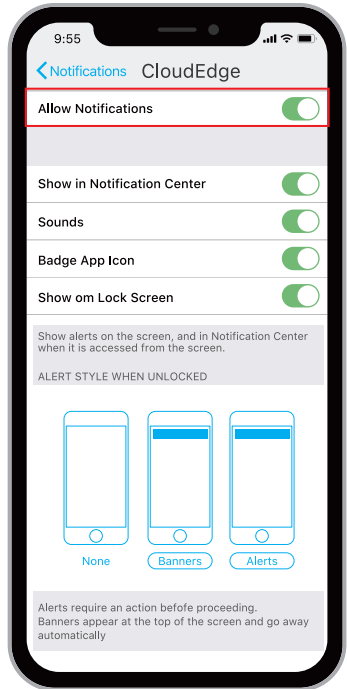
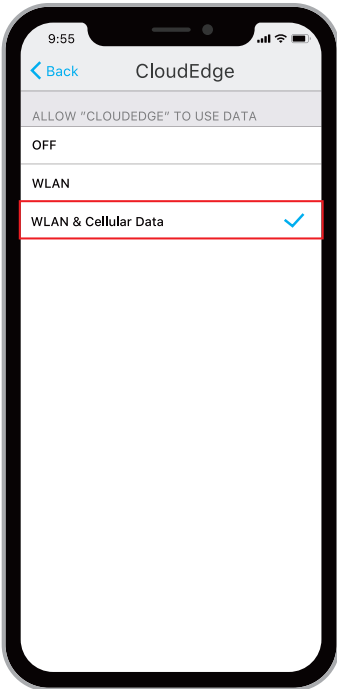

## 2. REGISTER ACCOUNT

New users must register by email

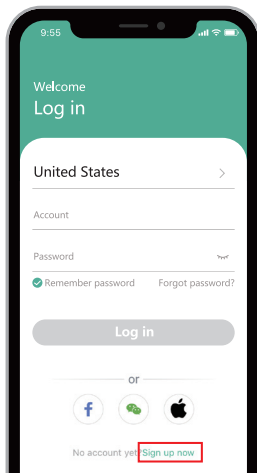

1. Click on 'Register'

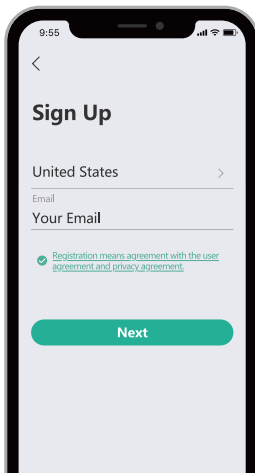

2. Follow the steps to complete your account registration;

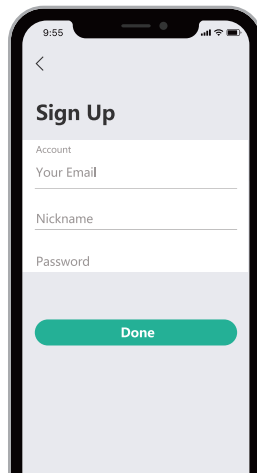

3. Set 'Nickname' and 'Password'

### TIP

- ① Please use the correct e-mail.
- ② Please select the correct country code.
- ③ When registering for a new account, please select the region where you are actually located. (Cameras cannot be shared between different registration regions.)

### 3. POWER ON CAMERA

Find the camera's power button and move it to 'ON' (If it can't be powered on, please plug in 5V/2A USB standard adapter to charge the camera for 15 mins first) then the working indicator light up, red light flashing slowly means the camera is waiting for connect to WiFi(If the working status light is not flashing red, please Reset the device)

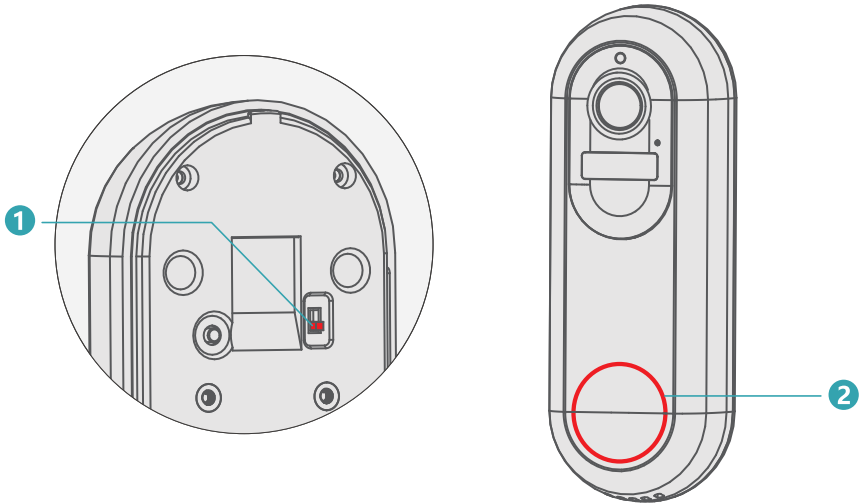

1 Power key

2 Working Status indicator

#### Why the camera cannot be turned on?

1. Try to charge the device and then turn it on again.
2. Please try several times to move the power key continuously.
3. Contact Customer Support Team [support@xtucam.com](mailto:support@xtucam.com)

## 4. CONNECT THE CAMERA TO WIFI

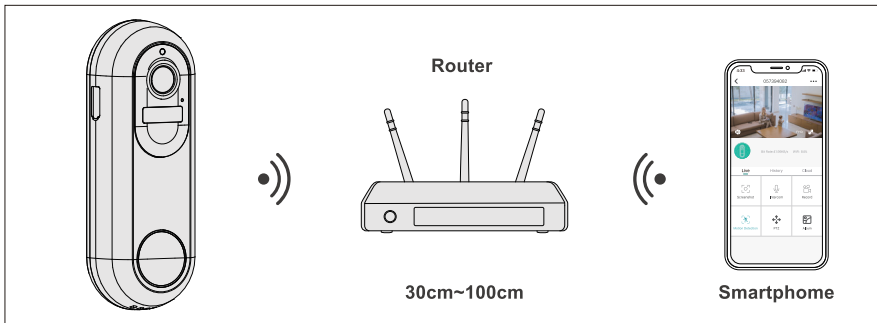

### **i** IMPORTANT:

- ① To connect the camera successfully, please allow Clouddedge to use your WLAN & Cellular Data at the first run of this App.
- ② The camera only supports 2.4GHz Wi-Fi.
- ③ Make sure the camera and your mobile device are close to the router.
- ④ Press the Power Button once to wake up the camera from sleep mode and make sure the LED indicator flashes RED slowly.
- ⑤ Insert the Reset Pin into the Reset Hole and press for 5 seconds to reset the camera. There is beeping sound from the camera after a successful reset.

## Connecting by Scanning the QR Code

Start the Wi-Fi configuration following the in-App instructions or referring to below tutorial steps.

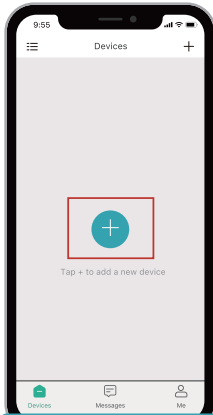

1. Tap "+" to add device

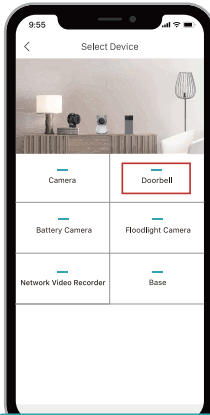

2. Select Doorbell

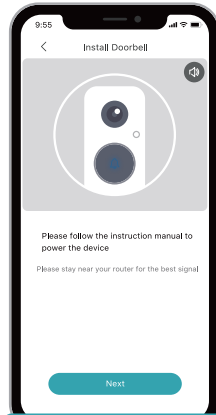

3. Check power status

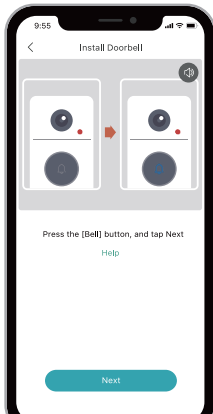

4. Activate the doorbell

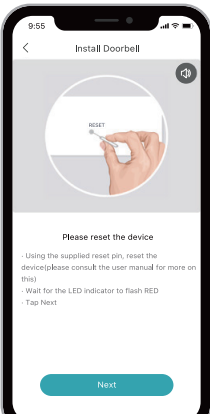

5. Reset device



6. Input Wi-Fi password



7. Prepare Code Scanning



8. Generate QR Code

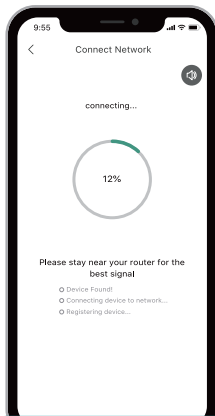

9. Wait for connection

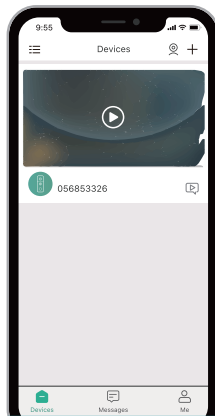

10. Device Added

## Processing Steps Of Camera and WI-FI connection failure :

- Please make sure you are using 2.4GHz Wi-Fi. In our experience, most users fail to connect the WI-FI because of selecting 5GHz WIFI and adding the camera incorrectly.
- Make sure you use the correct Wi-Fi password and a fast WI-FI network. (Note: It requires that the Wi-Fi password doesn't have special characters such as (!@#\$))
- Make sure the QR code on the phone screen is normal and the distance between the phone and the camera lens is 10-15cm (3.9-5.9inch) during the scanning process.
- If none of the above steps take effect, please try to re-download the APP, restore the product to factory settings, restart the router, and then add it again.
- After multiple attempts have failed, please contact customer service:  
[support@morecam.cn](mailto:support@morecam.cn)

# CONNECT THE CHIME

## 1 Supply power to the chime

The chime can be powered by USB compatible power source(DC5V 1A), or by the USB port on your computer.

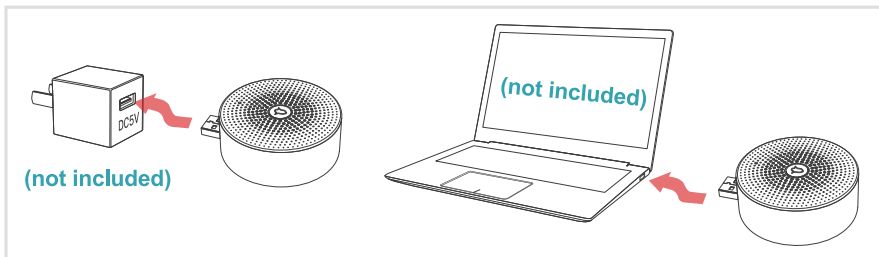

## 2 Click reset button

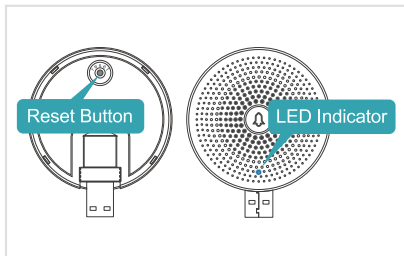

Click on **RESET** only once, and you will see the chime indicator flashing blue, indicating that the chime is in pairing mode.

## 3 Press the doorbell button

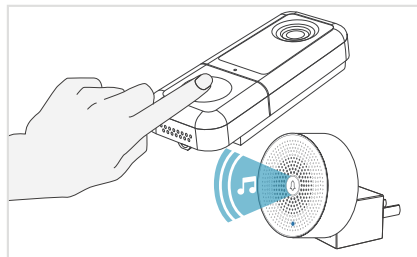

Press the doorbell button, and the chime will sound. If pairing is successful, the indicator on the chime will be in solid blue.



# MOUNTING THE CAMERA TO THE WALL

---

## NOTE

In order to obtain the best product performance and avoid unnecessary environmental disturbances, please pay attention to the following during the installation process:

- Do not install the product nearby to the heat sources, such as outdoor units of air conditioners, kitchen exhausts, etc.
- Make sure there are no reflections within 5 feet (1.5 meters) of the PIR sensor, otherwise it will interfere with the normal function of the sensor.
- Try to avoid installing the product on the side of a lively road. Frequent pedestrians and vehicles will keep waking up the camera, resulting in frequent alarm messages and extremely fast power consumption.
- Do not install the product very far from the router, the product needs a good WI-FI signal to work properly.

## Extra Tools You need needed:



**Power drill**

## Step 1:

Select the location where you need to install the camera, take the camera and the phone to the location, and use the "Installation Guide" in the application to diagnose the network and determine whether the WI-FI signal at the location is good.

It is recommended to install the camera in a location with good WI-FI signal for smooth camera operation.

## Step 2:

Use Power Drill . Secure the camera bracket to the wall, 4 feet off the ground (1.2m) is recommended, snap the camera into the bracket and secure the camera with safety screws.

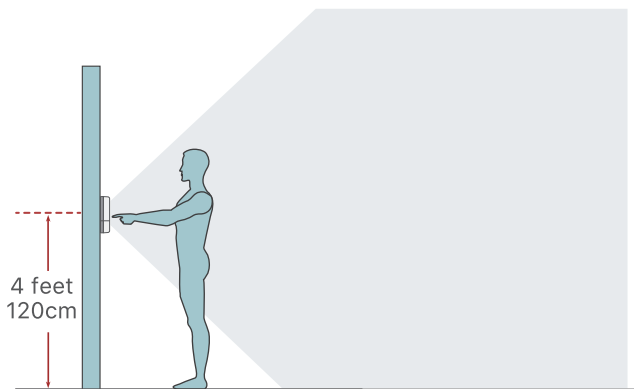

## 1. HARDWIRED INSTALLATION (OPTINONAL)

To replace your existing doorbell and mechanical chime, please follow below installation steps:

- 1 Shut off the master circuit breaker in your house.
- 2 Bypass your indoor chime with provided jumper.

In most cases, the existing doorbell circuit looks similar to the image below. Remove the cover of the indoor chime and loosen the “**FRONT**” and “**TRANS**” terminal screws. Use the provided jumper to connect the two terminals, and replace the chime cover.

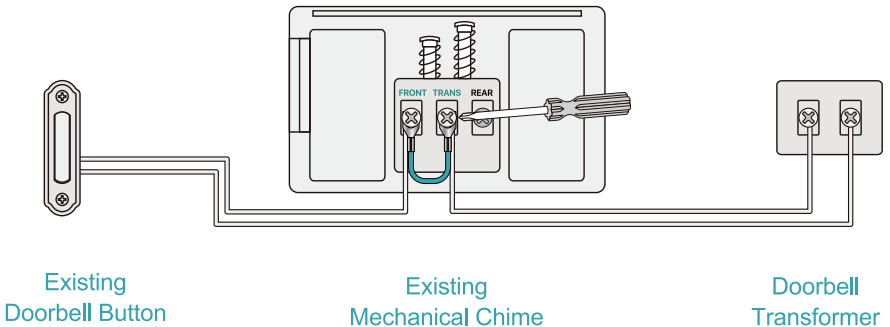

### 3 Replace your existing doorbell.

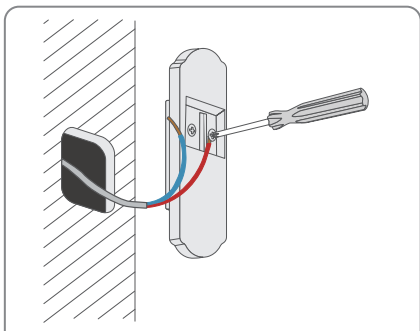

**A** Remove the existing doorbell from the wall and disconnect the wires.

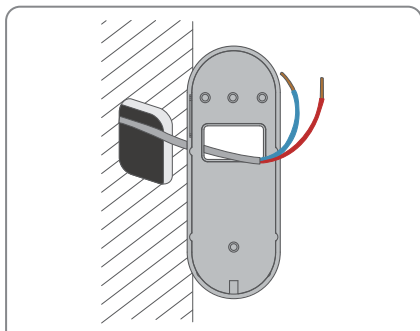

**B** Lead the wire through the holes on the bracket before mounting.

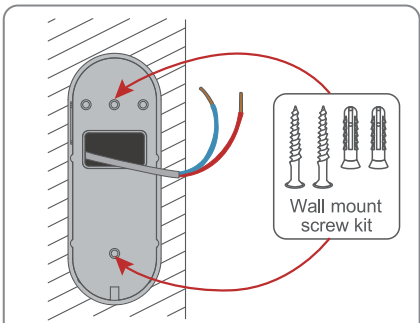

**C** Mount the bracket on the wall with provided screw set or adhesive tape.

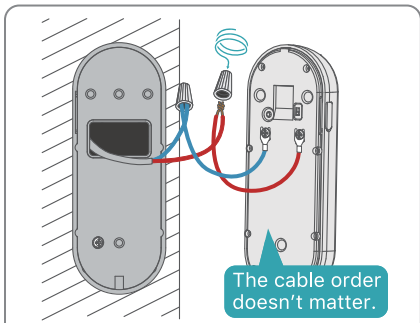

**D** Attach the wires to the terminals. Wire extension kits are optional.

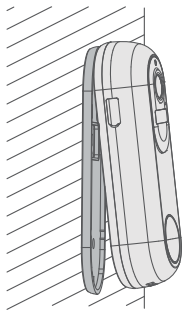

- E** Feed the wires back to the wall and mount the doorbell to the brackets.

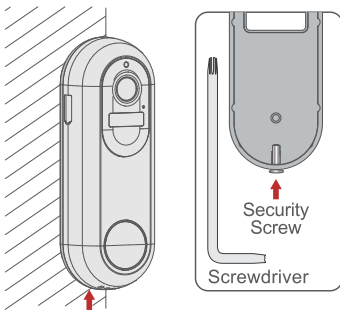

- F** Tighten the security screw at the bottom of the bracket.

**4** Restore power at the breaker, and your doorbell is ready for use.

## 2. WIRELESS INSTALLATION

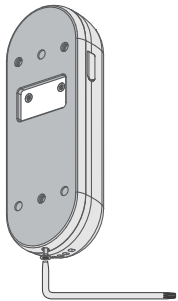

- A** Release the bracket from the doorbell with the provided tool.

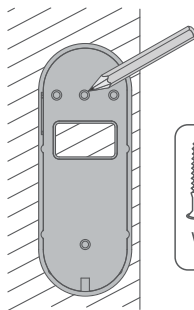

- B** Mark the screw holes and mount the bracket on your wall with screws.

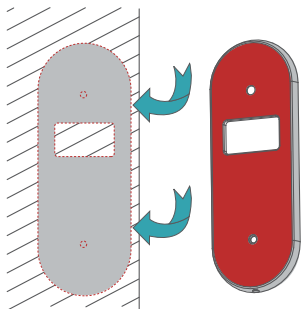

- C** Adhesive tape is provided to mount the bracket on flat surfaces. (Optional)

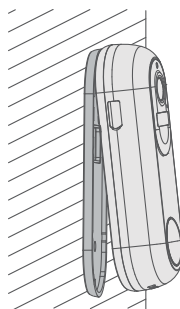

- D** Attach the doorbell to the fixed mounting bracket.

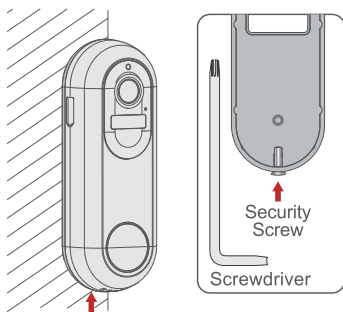

- E** Tighten the security screw at the bottom of the bracket.

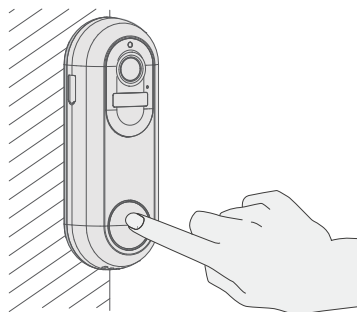

- F** All set! Press the doorbell button to run a test.

# FUNCTION INTRODUCTION

## 1. MAIN PAGE

- 1 Go to the video browsing page
- 2 Multi-screen viewing
- 3 Adding Devices
- 4 Device Sharing
- 5 View alarm pictures and video
- 6 Cloud Storage

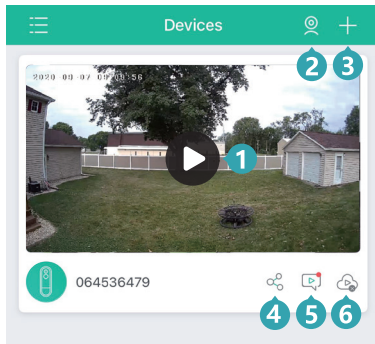

## 2. PREVIEW PAGE

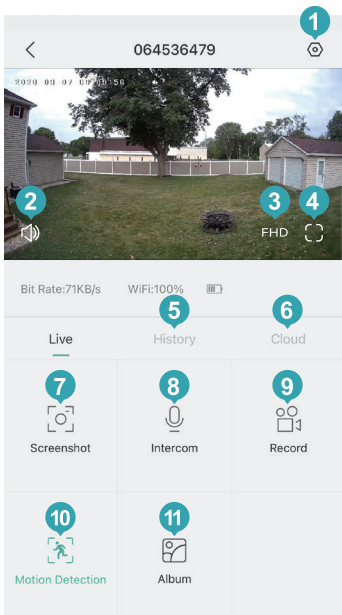

- 1 Enter settings menu(alarm settings, video, lighting, device information, firmware upgrade, etc.)
- 2 Turn on/off the speaker
- 3 Video definition settings (SD, HD options)
- 4 Full screen option
- 5 SD card video playback
- 6 Cloud storage video playback
- 7 Manual Screen-shot
- 8 Voice intercom (long press to talk)
- 9 Manually capture video clips
- 10 Turn on/off motion detection
- 11 Albums (store screen-shots and manual video files)

## TIP

Stretch the video screen with two fingers to zoom in on the image and view image details.

### 3. VIDEO REPLAY PAGE

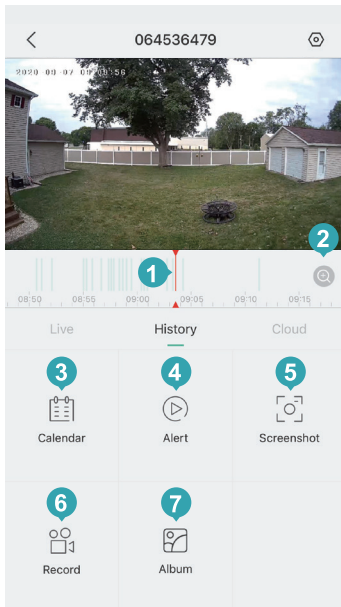

- 1 Video timeline with drag-and-drop time selection
- 2 Timeline zoom button
- 3 Select video playback date
- 4 Select alarm video clips
- 5 Video Screen-shot
- 6 Record video, first click to start recording, click again to end recording
- 7 Save video screen-shots and recorded videos



## 4. SETUP PAGE

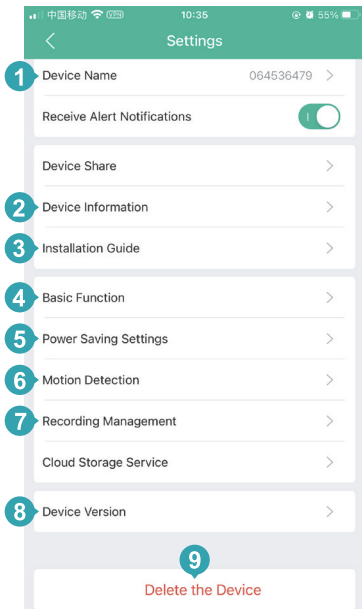

- 1 Modify device name (The default is S/N of device)
- 2 Get device information (network information, Mac address, time zone)
- 3 Installation Guide, Network Diagnostics
- 4 Turn off the light, night vision settings, check the battery level
- 5 Set the length of recording, alarm interval, optimize the battery life
- 6 Motion detection settings, adjust the detection sensitivity, etc.
- 7 Video settings, view SD card capacity, format
- 8 Device firmware version information, version upgrade
- 9 Delete the device and operate it before rewiring

## 5. DEVICE SHARING

### Others share camera steps:

This function can be achieved through "Device Share". 1) Invite your friends to download and install "CloudEdge" APP and login. 2) Click the "Device Share"



icon to watch the operation video, and then follow the steps to complete device sharing.

### TIP

When sharing, please make sure the APP account is registered in the same region. Otherwise, you will not be able to share successfully.

## 6. SD CARD RECORDING

This product does not include an SD card. If you need an SD card to store your files, please purchase it by yourself.

### SD card requirements:

- Recommend the use of brand name cards such as San Disk, Samsung, etc.
- Support 8-128GB capacity;
- Recommend the use of standard Class 10 SD cards.
- Only FAT32 format is supported.

### NOTE

Insert the memory card into the SD card slot of the device and the device will automatically start saving the video.

## How to watch videos on SD card:

- Click the "History" or "Alert" button on the alarm information icon in the app to enter the video playback interface. Drag the timeline or select the alarm point to find the corresponding time period you want to record.
- Insert the SD card into your computer. The video file is in MP4 format. You can play the video directly using the video player.

## 7. PIR MOTION DETECTION SETTINGS

Enter the application - "**Settings**" - "**Motion Detection**" interface, you can adjust the motion detection settings.

The device is used for 5 grades of PIR motion detection sensitivity.

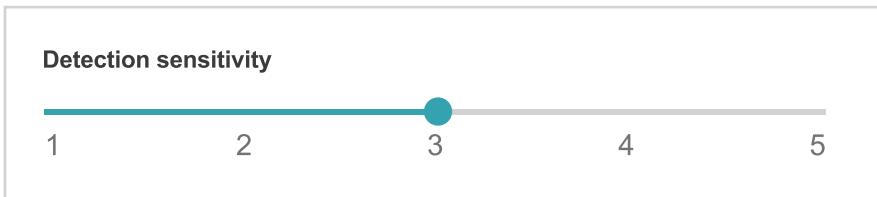

- ※ **1-2** belongs to the Low gear sensitivity, motion detection distance of 4-5 meters.
- ※ **3-4** belongs to the Med gear sensitivity, motion detection distance of 5-8 meters.
- ※ **5** belongs to the High gear sensitivity, motion detection distance of 8-13 meters.

## WARM TIPS

**You can adjust the sensitivity of the motion detection to solve the following problems when using this product in the process .**

- If the phone receives alarm messages too often, the camera will greatly consume battery power. It is recommended to adjust the motion detection sensitivity downward and set the alarm interval to turn on the alarm plan.
- If it is found that the phone frequently receives alarm pictures without moving objects, there may be sensitive heat sources within the range of motion detection, resulting in PIR false triggering, it is recommended to adjust the sensitivity of motion detection downward.
- If you detect someone passing in front of the camera but cannot receive an alarm message, it is recommended to adjust the motion detection sensitivity upwards to increase the PIR detection range.
- If you find that the alarm picture or video has a delay, or you can only see the back of the person, it is recommended to adjust the motion detection sensitivity upward.
- PIR sensor will be interfered by the ambient temperature, it is recommended to adjust the sensitivity of motion detection upwards in hot temperature environment and downwards in cold temperature environment. At the same time in very low temperatures, heavy clothing will hinder the PIR sensor detection.
- Sunlight UV rays will interfere with the PIR sensor, the camera's PIR in the case of direct exposure to strong sunlight, there is a probability that the alarm is not sensitive and other undesirable phenomena.
- If you notice poor motion detection performance in nighttime environments, try turning off "Night Detection".

## 8. BATTERY MANAGEMENT

### A. Charging the camera

It is recommended to use a 5V/2A power adapter for charging, connect the USB charging cable that comes with the product, and plug the charging cable into the USB charging port of the device.

#### NOTE

If there is no 5V/2A power adapter, other specifications of 5V power adapter can also be charged.

#### How to check if charging is successful?

The device's charging indicator lights up in red to indicate charging is in progress. The charging indicator lights up in blue, which means charging is complete. It takes about 10 hours or more to fully charged.

#### What if the charge fails?

- Determine whether the power adapter is good and try a different one.
- Determine whether the USB charging cable is good and try a different one.
- The charging indicator may be defective, check in the phone app to see if it is charging.
- Determine if the device's charging port is poorly disconnected from the USB charging cable.
- The device has a low temperature charging protection module, please do not charge the device at low temperature.
- Contact Customer Service : [support@xtucam.com](mailto:support@xtucam.com)

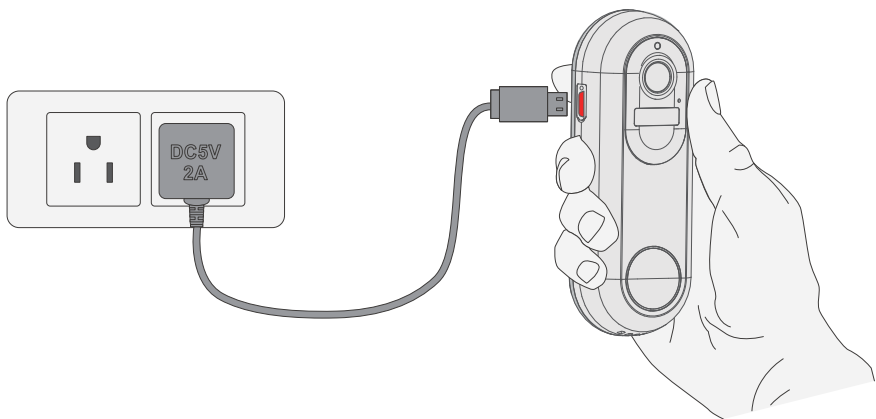

**1 Power Light**

① **Red Light:** Charging

② **Blue Light:**  
Charging Completed

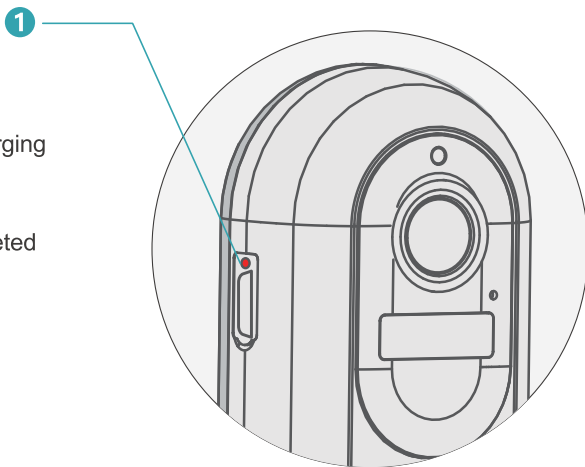

## B. Battery life

If the device does not detect a moving object, the device will go into sleep mode to reduce the power consumption of the device.

If the device detects a moving object, it quickly wakes up and starts within 1 second and takes a screen-shot and records a video.

### **WARM TIP:**

The device uses a ternary lithium battery, when the battery is in a low-temperature environment, the internal chemicals of the battery will slowly solidify, the battery charging and discharging performance slows down, resulting in a decrease in the capacity of the battery, the life of the device will be seriously reduced. And the lower the temperature, the lower the battery capacity will be, when the temperature is below -20 degrees, the battery has the probability to enter the self-protection mode and shut down. But if the temperature rises, the battery will automatically return to its normal state.

In cold winter, if the device needs to be charged, it is recommended to take the device back inside the house and set it aside for an hour, the warm air in the house will pull up the temperature of the battery before the charging action. Then recharge it.

## Why does the device have a poor battery life?

- The working time of the device determines the battery life. The more frequently the PIR wakes up and the number of alarms, the longer the working time of the device. Please check whether the number of alarms is too frequent. It is recommended to adjust the motion detection sensitivity of the device appropriately and set the alarm interval and alarm time plan.
- Check whether there are objects within the field of view of the device that interfere with and trigger the PIR sensor, such as outdoor units of air conditioners, moving cars, passing pedestrians, etc. The angle of the device can be adjusted appropriately to avoid these objects prone to cause interference.
- The battery capacity will be reduced in cold weather, which will affect the range of the device.
- Contact Customer Service : [support@morecam.cn](mailto:support@morecam.cn)



# TROUBLESHOOTING/FAQ

---

For more detailed FAQs, please log in the APP, "[Me](#)"-"[FAQ](#)"-"[Battery Camera](#)".

## Device prompted offline?

- Check whether the equipment is in the energized state and observe whether the working light of the equipment lights up normally.
- Check whether the WIFI network is good and restart the router.
- If the location of the device according to the router is far away, resulting in the inability to obtain a good WIFI signal, it is recommended to move the router to a closer location, or add a WIFI amplifier to enhance the home WIFI performance.
- Remove the floodlight camera from your CloudEdge account, Reset the device, and then re-add it.
- Check that the device firmware and applications are up to date.

## Update router or WIFI password?

- Remove the floodlight camera from your [CloudEdge](#) account, Reset the device and re-add it with a new WIFI or password.

## Can't play history videos?

- Check the status of SD card in "Settings" and make sure the SD card is successfully recognized.
- Reinsert the SD card.
- In the application, format the SD card.
- Try another new SD card.

## Frequent alarm?

- Open the application, turn down the motion detection alarm sensitivity.
- Check whether there are objects within the field of view of the device that interfere with and trigger the PIR sensor, such as outdoor units of air conditioners, moving cars, passing pedestrians, etc. The angle of the device can be adjusted appropriately to avoid these easy to interfere with objects
- Enable **"The Alert will be triggered only when human motion is detected"** to filter useless alarms using humanoid algorithm.

## Can't receive alarm on your phone?

- In the system settings of the phone, turn on the push permission of "CloudEdge" application.
- Ensure that the device's motion detection feature is successfully enabled.
- Restart your phone and try clearing the cache on your Android phone.
- Check if the network is good.

## What's the Wi-Fi range of the video doorbell?

The video doorbell works with any 2.4GHz wireless Wi-Fi router, mesh system or modems. In outfield test, it works well in most 3000sqft houses. The Wi-Fi range may vary because of different WiFi transmit power, transmission distance and wall blocks in between.

## How many wireless chimes can be paired with one video doorbell?

You can add as many wireless chimes as your wish on one video doorbell.

## **I installed my video doorbell, but the video or audio quality is poor, why?**

In live view interface, Wi-Fi status will be listed. It is suggested to ensure the Wi-Fi status be more than 70%, so as to get your doorbell work as expected. If you think your problem is caused by low Wi-Fi signal strength, try moving your Wi-Fi router closer, or add one Wi-Fi Booster to extend your Wi-Fi range.

## **Does the video doorbell work with existing indoor mechanical chime?**

No. The doorbell comes with an battery powered wireless chime to notify people when your vistor presses the doorbell button. If you have an existing indoor chime, please use the provided jumper to bypass the existing chime, so as to provide sufficient power to the new video doorbell. And our wireless chime is 100% wireless, you can place it almost everywhere you like. The transmission distance in open space is more than 100 meters (328 feet).

## **I installed a 16GB memory card, how many days of event recordings does it keep?**

The video bit rate is around 100KB/s. If you have 10 event recordings per day, and each of the video clips lasts for 20 seconds, a 16GB memory card is capable of keeping 24-Month's video recordings.

## **Does the doorbell support cloud storage?**

Your doorbell supports local video storage by Micro SD card as well as cloud storage. You can activate the cloud storage service in the App. There is a 7-day free cloud recording trial service.

## FCC ID:2AYIT-BELL1

This device complies with Part 15 of the FCC Rules. Operation is subject to the following two conditions: (1) this device may not cause harmful interference, and (2) this device must accept any interference received, including interference that may cause undesired operation.

changes or modifications not expressly approved by the party responsible for compliance could void the user's authority to operate the equipment.

NOTE: This equipment has been tested and found to comply with the limits for a Class B digital device, pursuant to Part 15 of the FCC Rules. These limits are designed to provide reasonable protection against harmful interference in a residential installation. This equipment generates, uses and can radiate radio frequency energy and, if not installed and used in accordance with the instructions, may cause harmful interference to radio communications. However, there is no guarantee that interference will not occur in a particular installation. If this equipment does cause harmful interference to radio or television reception, which can be determined by turning the equipment off and on, the user is encouraged to try to correct the interference by one or more of the following measures:

- Reorient or relocate the receiving antenna.
  - Increase the separation between the equipment and receiver.
  - Connect the equipment into an outlet on a circuit different from that to which the receiver is connected.
  - Consult the dealer or an experienced radio/TV technician for help.
- The distance between user and products should be no less than 20cm

