



Test Report No.:
FCC2022-0038-RF6

RF Test Report

EUT : **IoT Display**
MODEL : **DS7610-915M**
BRAND NAME : **Milesight**
APPLICANT : **Xiamen Milesight IoT Co., Ltd.**
CLASSIFICATION OF TEST : **N/A**



CVC Testing Technology Co., Ltd.



CVC Testing Technology Co., Ltd.

Test Report No.: FCC2022-0038-RF6

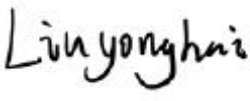
Page 2 of 19

Applicant		Name: Xiamen Milesight IoT Co., Ltd. Address: Building C09, Software Park Phase III, Xiamen 361024, Fujian, China	
Manufacturer		Name: Xiamen Milesight IoT Co., Ltd. Address: Building C09, Software Park Phase III, Xiamen 361024, Fujian, China	
Equipment Under Test		Name: IoT Display Model/Type: DS7610-915M Additional Models/Types: See Section 2.2 Brand: Milesight Serial NO.: N/A Sampe NO.: 4-1	
Date of Receipt.	2022.07.11	Date of Testing	2022.07.11~2022.12.06
Test Specification		Test Result	
FCC Part 15, Subpart E, Section 15.407		PASS	
Evaluation of Test Result		The equipment under test was found to comply with the requirements of the standards applied. Seal of CVC Issue Date: 2022.12.10	
Tested by:  Xu ZhenFei Name Signature		Reviewed by:  Liu YongHai Name Signature	
		Approved by:  Chen HuaWen Name Signature	
Other Aspects: NONE.			
Abbreviations:OK, Pass= passed Fail = failed N/A= not applicable EUT= equipment, sample(s) under tested			

This test report relates only to the EUT, and shall not be reproduced except in full, without written approval of CVC.



TABLE OF CONTENTS

1 SUMMARY OF TEST RESULTS 5

1.1 LIST OF TEST AND MEASUREMENT INSTRUMENTS 6

1.2 TEST LOCATION 6

2 GENERAL INFORMATION 7

2.1 GENERAL PRODUCT INFORMATION 7

2.2 ADDITIONAL MODELS/TYPES 7

2.3 TEST MODE APPLICABILITY AND TESTED CHANNEL DETAIL 8

2.4 DESCRIPTION OF SUPPORT UNITS 8

3 REQUIREMENTS AND PARAMETERS FOR DFS TEST 9

3.1 APPLICABILITY OF DFS REQUIREMENTS 9

3.2 DETECTION THRESHOLD VALUES 10

3.3 DFS RESPONSE REQUIREMENT VALUES 10

3.4 PARAMETERS OF DFS TEST SIGNALS 11

4 TEST RESULTS 12

4.1 TEST SETUP OF DFS 12

4.2 DFS DETECTION THRESHOLD 13

4.3 CHANNEL LOADING 14

4.4 CHANNEL CLOSING TRANSMISSION AND CHANNEL MOVE TIME 15

4.5 NON- OCCUPANCY PERIOD 16

5 PHOTOGRAPHS OF THE EUT 18



RELEASE CONTROL RECORD

ISSUE NO.	REASON FOR CHANGE	DATE ISSUED
FCC2022-0038-RF6	Original release	2022.12.10



1 SUMMARY OF TEST RESULTS

The EUT has been tested according to the following specifications:

FCC STANDARD SECTION	TEST TYPE AND LIMIT	RESULT	REMARK
15.407	Channel Move Time	PASS	774.5 msec
15.407	Channel Closing Transmission Time	PASS	200+aggregate of 13ms over remaining 10s period.
15.407	Non-Occupancy Period and Client Beacon Test	PASS	≥ 30 min

Note: Since the product is client without radar detection function, only Channel Move Time, Channel Closing Transmission Time and Non-Occupancy Period and Client Beacon Test are required to be performed



1.1 LIST OF TEST AND MEASUREMENT INSTRUMENTS

Test Equipment	Type/Mode	SERIAL NO.	Equipment No.	Manufacturer	Cal. Due
WIFI & Bluetooth Test System 1					/
Communication Shielded Room 2	4m*3m*3m	CRTDSWKSR 44301	VGDS-0700	CRT	2024/04/24
Bluetooth system integration	/	/	-	Tonscend	/
Spectrum Analyzer	FSV40	101580	DZ-000238-3	R&S	2023/06/05
Comprehensive Test Instrument	CMW270	100304	DZ-000240-1	R&S	2023/12/06
Analog Signal Generator	SMB100A	181858	DZ-000238-2	R&S	2023/06/05
Vector Signal Generator	SGT100A	111661	DZ-000238-1	R&S	2023/06/05
RF Radio Frequency Switch	JS0806-2	19H9080187	'	Tonscend	2023/06/06
Programmable DC Power Supply	E3644A	MY58036222	DZ-000178	KEYSIGHT	2023/04/21

1.2 TEST LOCATION

The tests and measurements refer to this report were performed by EMC testing Lab. of CVC Testing Technology Co., Ltd.

Address: No.3,TiantaiyiRoad,KaitaiAvenue,ScienceCity,Guangzhou,China
Post Code: 510663 Tel: 020-32293888
FAX: 020-32293889 E-mail: office@cvc.org.cn



2 GENERAL INFORMATION

2.1 GENERAL PRODUCT INFORMATION

PRODUCT	IoT Display
BRAND	Milesight
MODEL NO.	DS7610-915M
ADDITIONAL MODEL	See Section 2.2
FCC ID	2AYHY-DS7610
POWER SUPPLY	1. DC 5V from USB host unit 2. DC 56V from POE 3. DC 12V from Adapter
OPERATING FREQUENCY	5260MHz ~ 5320MHz, 5500MHz ~ 5700MHz
ANTENNA TYPE	Ceramic Antenna, -2.89dBi Gain for 5260MHz ~ 5320MHz Ceramic Antenna, -0.80dBi Gain for 5500MHz ~ 5700MHz
HARDWARE VERSION:	UD00-00-V1.2
SOFTWARE VERSION:	72.0.0.5-r1
I/O PORTS	Refer to user's manual
CABLE SUPPLIED	N/A
Remark: 1. For more detailed features description, please refer to the manufacturer's specifications or the User's Manual. 2. For the test results, the EUT had been tested with all conditions. But only the worst case was shown in test report. 3. EUT photo refer to report (Report NO.: FCC2022-0038-E).	

2.2 ADDITIONAL MODELS/TYPES

Models	
1	DS7610-9M
2	NH7610-915M
3	NH7610-9M
Note: The only differences are silk-screen 、 trade name and model no. for trading purpose.	



2.3 TEST MODE APPLICABILITY AND TESTED CHANNEL DETAIL

This test was investigated for different bandwidth (20MHz, 40MHz and 80MHz). The following plots was done on 80MHz as a representative

BANDWIDTH	CHANNEL	TEST TYPE AND LIMIT
80MHz	CH58	Channel Move Time
		Channel Closing Transmission Time
		Non-Occupancy Period and Client Beacon Test

2.4 DESCRIPTION OF SUPPORT UNITS

The EUT has been tested as an independent unit together with other necessary accessories or support units. The following support units or accessories were used to form a representative test configuration during the tests.

Support Equipment							
NO	Description	Brand	Model No.	FCC ID	Supplied by		
1	Wireless router	LINKSYS	WRT3200ACM	Q87-WRT3200ACM	Lab		
Support Cable							
NO	Description	Quantity (Number)	Length (m)	Detachable (Yes/ No)	Shielded (Yes/ No)	Cores (Number)	Supplied by
1	N/A	N/A	N/A	N/A	N/A	N/A	N/A



3 REQUIREMENTS AND PARAMETERS FOR DFS TEST

3.1 APPLICABILITY OF DFS REQUIREMENTS

APPLICABILITY OF DFS REQUIREMENTS PRIOR TO USE A CHANNEL

REQUIREMENT	OPERATIONAL MODE		
	MASTER	CLIENT WITHOUT RADAR DETECTION	CLIENT WITH RADAR DETECTION
Non-Occupancy Period	✓	✓	✓
DFS Detection Threshold	✓	Not required	✓
Channel Availability Check Time	✓	Not required	Not required
Uniform Spreading	✓	Not required	Not required
U-NII Detection Bandwidth	✓	Not required	✓

APPLICABILITY OF DFS REQUIREMENTS DURING NORMAL OPERATION

REQUIREMENT	OPERATIONAL MODE		
	MASTER	CLIENT WITHOUT RADAR DETECTION	CLIENT WITH RADAR DETECTION
DFS Detection Threshold	✓	Not required	✓
Channel Closing Transmission Time	✓	✓	✓
Channel Move Time	✓	✓	✓
U-NII Detection Bandwidth	✓	Not required	✓



3.2 DETECTION THRESHOLD VALUES

DFS DETECTION THRESHOLDS FOR MASTER DEVICES AND CLIENT DEVICES WITH RADAR DETECTION

MAXIMUM TRANSMIT POWER	VALUE (SEE Note 1 and 2)
≥ 200 milliwatt	-64 dBm
< 200 milliwatt	-62 dBm

Note 1: This is the level at the input of the receiver assuming a 0 dBi receive antenna.

Note 2: Throughout these test procedures an additional 1 dB has been added to the amplitude of the test transmission waveforms to account for variations in measurement equipment. This will ensure that the test signal is at or above the detection threshold level to trigger a DFS response.

3.3 DFS Response Requirement Values

PARAMETER	VALUE
Non-occupancy period	Minimum 30 minutes
Channel Availability Check Time	60 seconds
Channel Move Time	10 seconds See Note 1.
Channel Closing Transmission Time	200 milliseconds + an aggregate of 60 milliseconds over remaining 10 second period. See Notes 1 and 2.
U-NII Detection Bandwidth	100% of the UNII transmission power bandwidth. See Note 3.

Note 1: The instant that the Channel Move Time and the Channel Closing Transmission Time begins is as follows:

- For the Short Pulse Radar Test Signals this instant is the end of the Burst.
- For the Frequency Hopping radar Test Signal, this instant is the end of the last radar Burst generated.
- For the Long Pulse Radar Test Signal this instant is the end of the 12 second period defining the Radar Waveform.

Note 2: The Channel Closing Transmission Time is comprised of 200 milliseconds starting at the beginning of the Channel Move Time plus any additional intermittent control signals required to facilitate a Channel move (an aggregate of 60 milliseconds) during the remainder of the 10 second period. The aggregate duration of control signals will not count quiet periods in between transmissions.

Note 3: During the U-NII Detection Bandwidth detection test, radar type 1 is used and for each frequency step the minimum percentage of detection is 90 percent. Measurements are performed with no data traffic.



3.4 PARAMETERS OF DFS TEST SIGNALS

Step intervals of 0.1 microsecond for Pulse Width, 1 microsecond for PRI, 1 MHz for chirp width and 1 for the number of pulses will be utilized for the random determination of specific test waveforms.

Short Pulse Radar Test Waveforms

Radar Type	Pulse Width (µsec)	PRI (µsec)	Number of Pulses	Minimum Percentage of Successful Detection	Minimum Number of Trials
0	1	1428	18	See Note 1	See Note 1
1	1	Test A Test B	$\text{Roundup} \left\{ \begin{array}{l} \left(\frac{1}{360} \right) \cdot \\ \left(\frac{19 \cdot 10^8}{\text{PRI} \cdot \text{sec}} \right) \end{array} \right\}$	60%	30
2	1-5	150-230	23-29	60%	30
3	6-10	200-500	16-18	60%	30
4	11-20	200-500	12-16	60%	30
Aggregate (Radar Types 1-4)				80%	120
Note 1: Short Pulse Radar Type 0 should be used for the detection bandwidth test, channel move time, and channel closing time tests.					

LONG PULSE RADAR TEST WAVEFORM

RADAR TYPE	PULSE WIDTH (µsec)	CHIRP WIDTH (MHz)	PRI (µsec)	NUMBER OF PULSES PER BURST	NUMBER OF BURSTS	MINIMUM PERCENTAGE OF SUCCESSFUL DETECTION	MINIMUM NUMBER OF TRIALS
5	50-100	5-20	1000-2000	1-3	8-20	80%	30

FREQUENCY HOPPING RADAR TEST WAVEFORM

RADAR TYPE	PULSE WIDTH (µsec)	PRI (µsec)	PULSES PER HOP	HOPPING RATE (kHz)	HOPPING SEQUENCE LENGTH (msec)	MINIMUM PERCENTAGE OF SUCCESSFUL DETECTION	MINIMUM NUMBER OF TRIALS
6	1	333	9	0.333	300	70%	30

4 TEST RESULTS

4.1 Test Setup of DFS

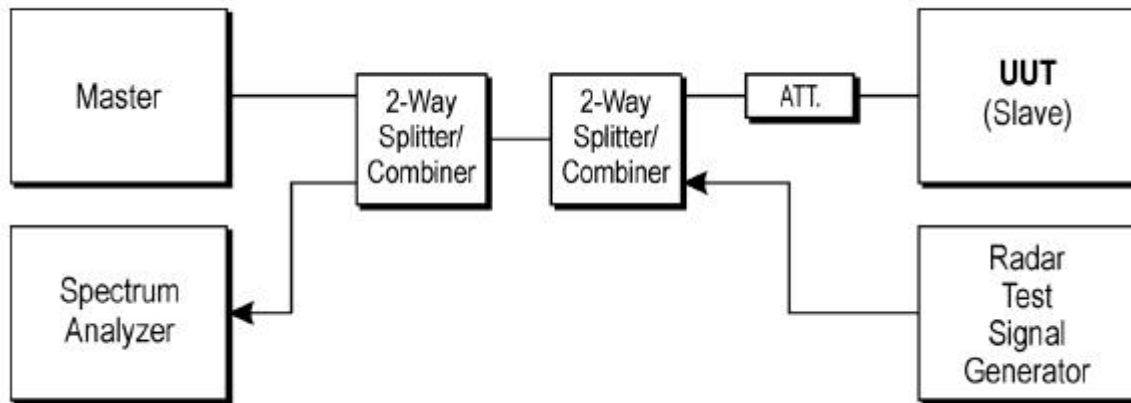



4.2 DFS Detection Threshold

The Required detection threshold is $-59.05.00\text{dBm} = -64 + 4.95\text{dBi}$. The conducted radar burst level is set to -59.39dBm .

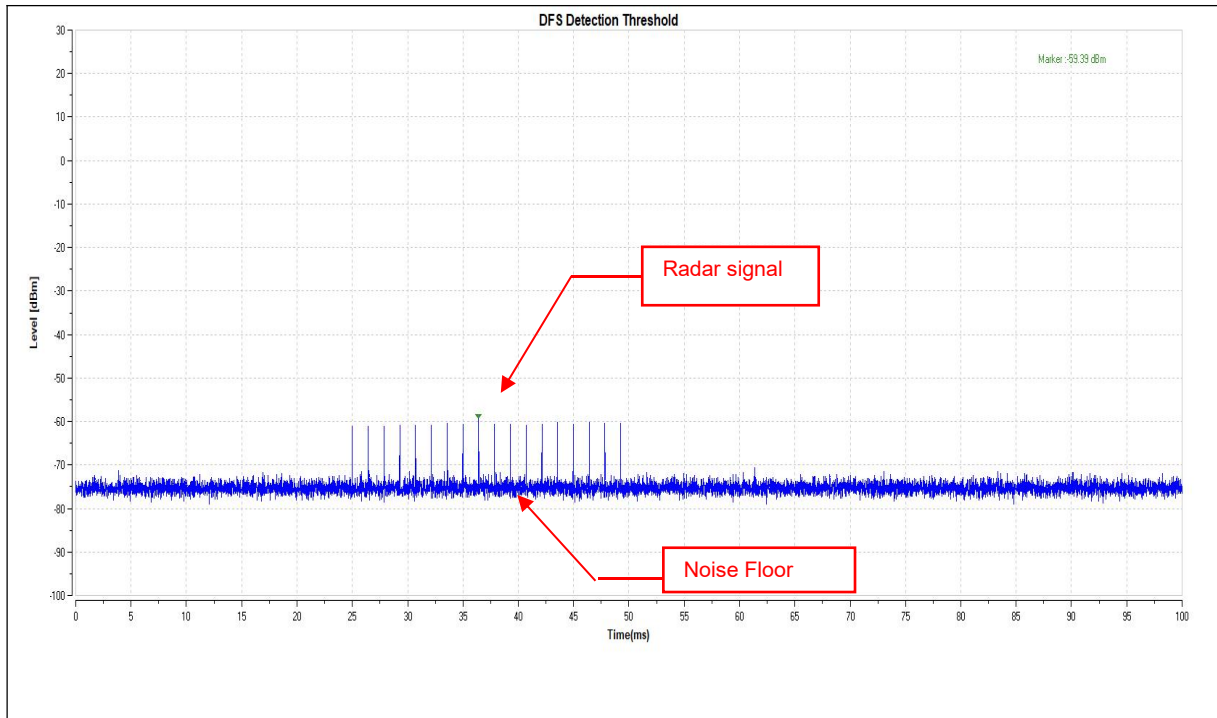

4.3 Channel loading

The radar signal was the same as transmitted channels, and injected into the antenna port of AP (master) with radar signal, measured the channel shutdown. The slave transmitted the test data to master, the transmitted duty cycle is 20.413%.

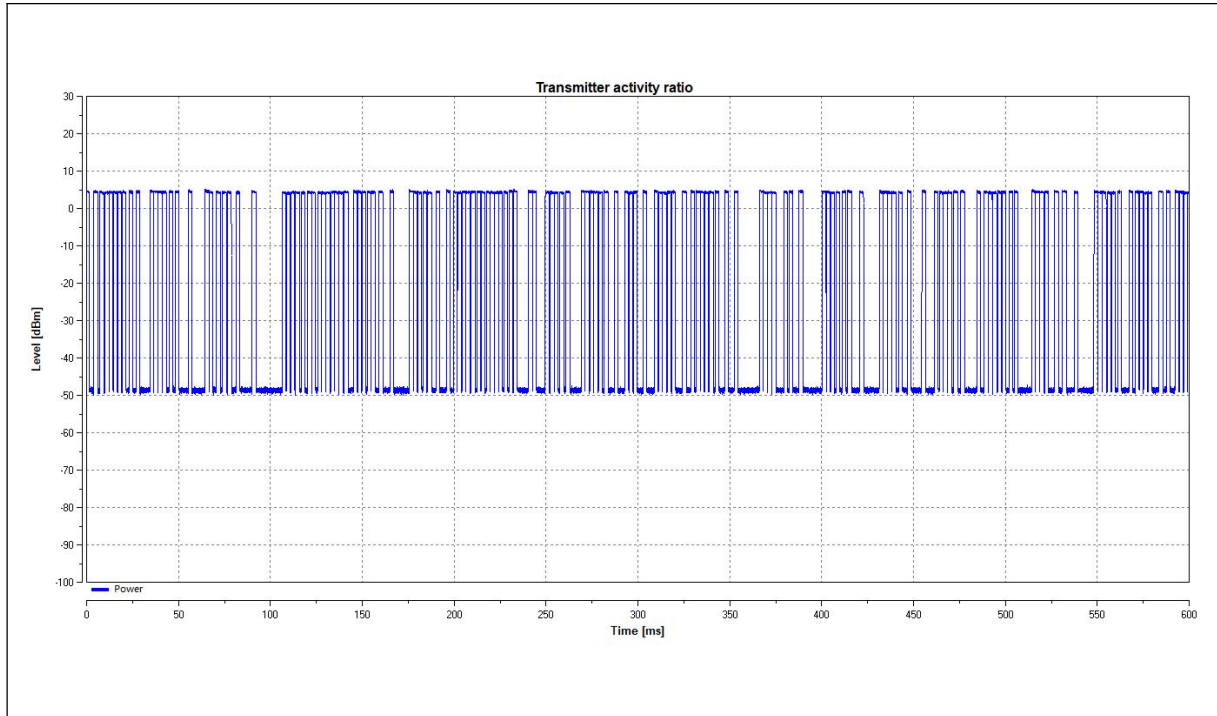

Note: Traffic signal: from slave transmit to master.



4.4 Channel Closing Transmission and Channel Move Time

Radar Signal 0

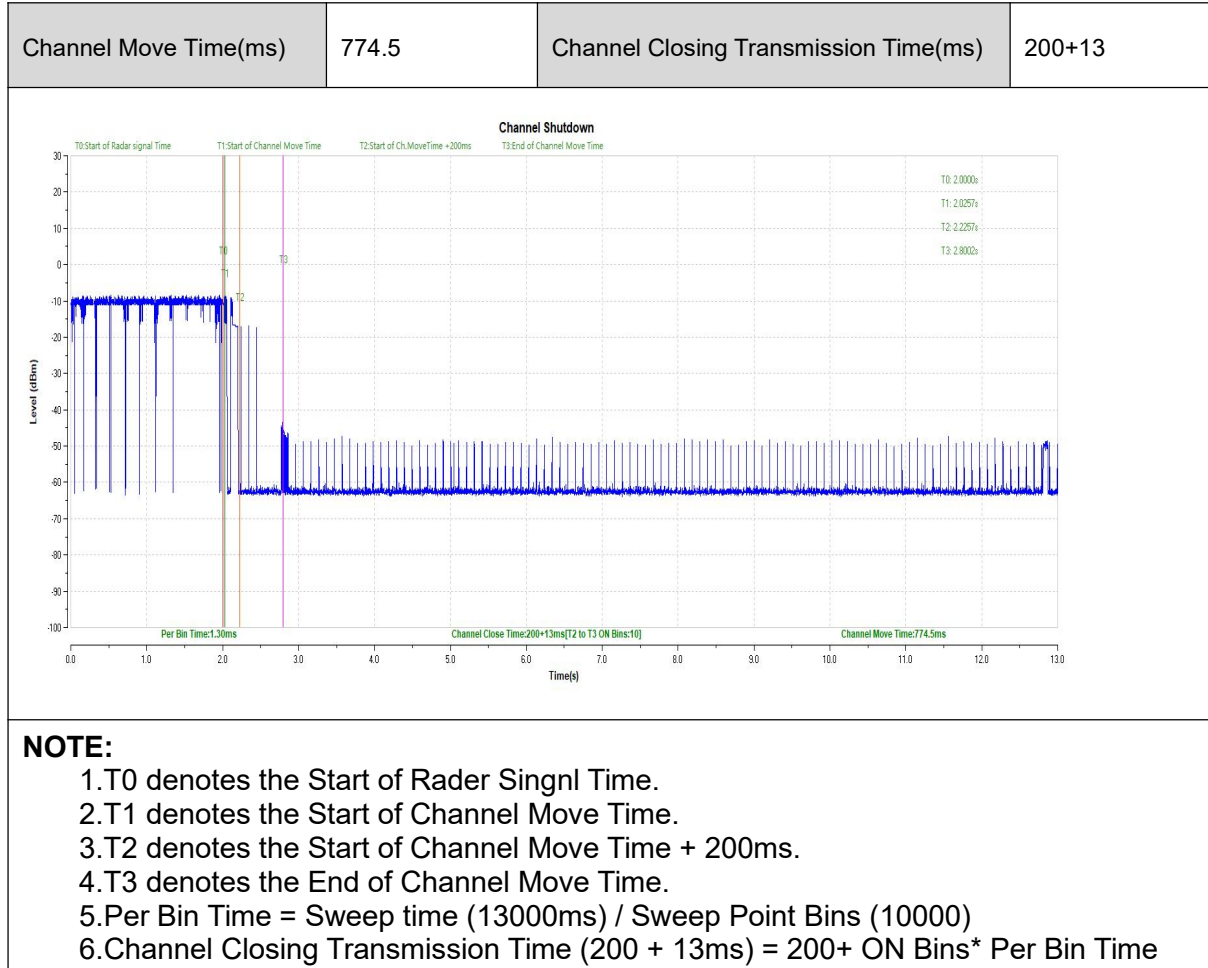



4.5 Non-Occupancy Period

- 1) Test results demonstrating an associated client link is established with the master on a test frequency
- 2) The client and DFS-certified master device are associated, and system testing will be performed with channel-loading for a non-occupancy period test.
- 3). The device transmits one type of radar as specified in the DFS Order.
- 4) The test frequency has been monitored to ensure no transmission of any type has occurred for 30 minutes;
Note: If the client moves with the master, the device is considered compliant if nothing appears in the client non-occupancy period test. For devices that shut down (rather than moving channels), no beacons should appear;
- 5)An analyzer plot that contains a single 30-minute sweep on the original test frequency.

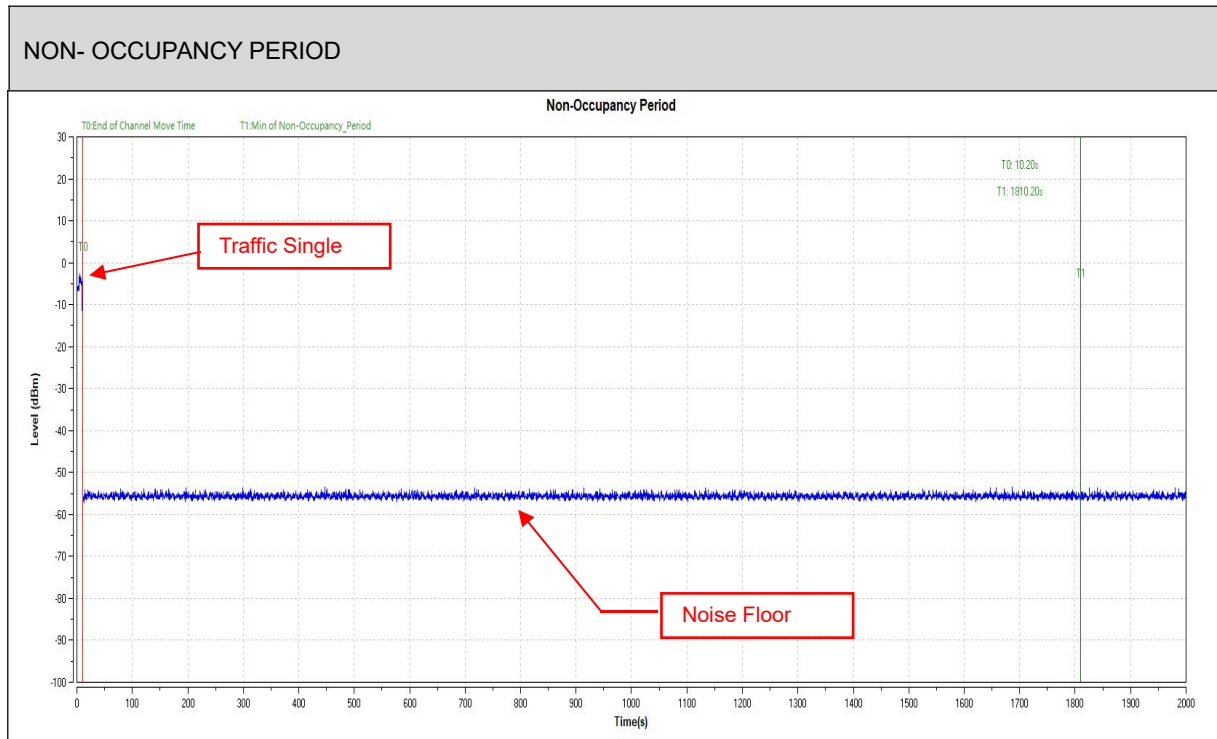



Master was off.

During the 30 minutes observation time, The UUT did not make any transmissions in the DFS band after UUT power up

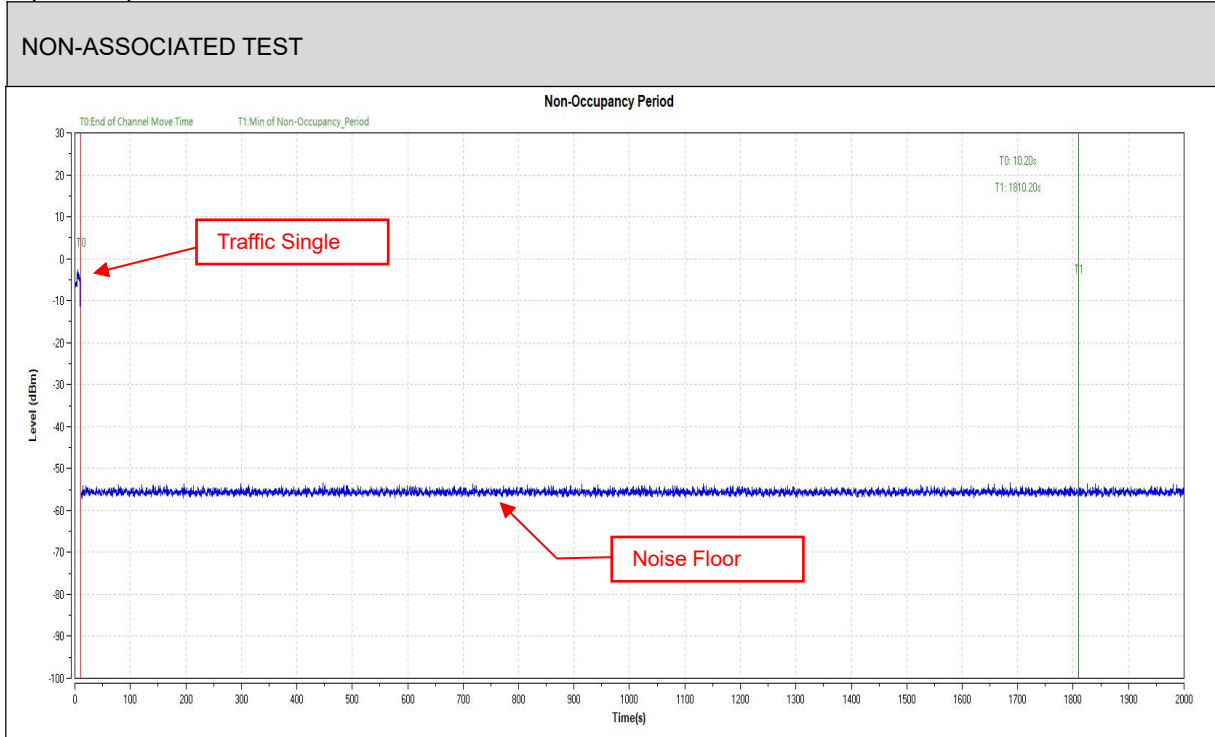



5 PHOTOGRAPHS OF THE EUT

Please refer to the attached file (External Photos report and Internal Photos).



Important

- (1) The test report is valid without the official stamp of CVC;
- (2) Any part photocopies of the test report are forbidden without the written permission from CVC;
- (3) The test report is invalid without the signatures of Approval and Reviewer;
- (4) The test report is invalid if altered;
- (5) Objections to the test report must be submitted to CVC within 15 days.
- (6) Generally, commission test is responsible for the tested samples only.
- (7) As for the test result “-” or “N” means “not applicable”, “/” means “not test”, “P” means “pass” and “F” means “fail”

The test data and test results given in this test report should only be used for purposes of scientific research, teaching and internal quality control when the CMA symbol is not presented.

Laboratory: CVC Testing Technology Co., Ltd.

Address: No.3, TiantaiyiRoad, KaitaiAvenue, ScienceCity, Guangzhou, China

Post Code: 510663 Tel: 020-32293888

FAX: 020-32293889 E-mail: office@cvc.org.cn