

Milesight

Milesight

QUICK START GUIDE

Lite/Pro/Ultra Series
Industrial Cellular Router



Quick Start Guide



All software & files can be downloaded from
<https://www.milesight-iot.com/documents-download/>

Better Inside, More in Sight

Milesight IoT Co., Ltd. | www.milesight-iot.com

Add: Building C09, Software Park Phase III, Xiamen 361024, Fujian, China

FEATURING 5G/4G CONNECTIVITY

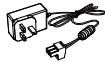

Table of Contents

1. Packing List.....	2
2. Hardware Introduction.....	4
3. Fitting Installation.....	6
4. Router Installation.....	8
5. Web GUI Access.....	12
6. Safety Precautions.....	14
7. FCC Statement.....	15

1. Packing List

Please check the package contents to verify that you have received the items below.



Power Adapter



Serial & IO Terminal



SIM Card Eject Tool



DIN Rail Kit

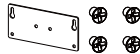

Wall Mounting Bracket with Screws

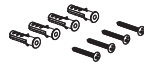

Wall Mounting Kits



Warranty Card



Quick Start Guide



Magnetic Cellular Antennas



Stubby Cellular Antenna

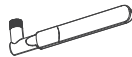

Stubby Wi-Fi Antenna

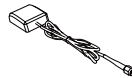

GPS Antenna

Contents \ Model	UR32L	UR32	UR35	UR41	UR75
Router	●	●	●	●	●
Power Adapter	●	●	●	●	●
Serial & IO Terminal		●	●	●	●
SIM Card Eject Tool				●	
DIN Rail Kit	●	●	●		●
Wall Mounting Bracket with Screws				●	
Wall Mounting Kits	●	●		●	
Warranty Card	●	●	●	●	●
Quick Start Guide	●	●	●	●	●
Magnetic Cellular Antenna	●	●(2)	●(2)	●	
Stubby Cellular Antenna	○	○	○	○	●(4)
Stubby Wi-Fi Antenna		◎	◎		◎(4)
GPS Antenna		◎	◎	○	○

Note: ●=standard, ◎=standard by specific model, ○=optional.

⚠ If any of the above items is missing or damaged, please contact your sales representative.

2. Hardware Introduction

UR32L

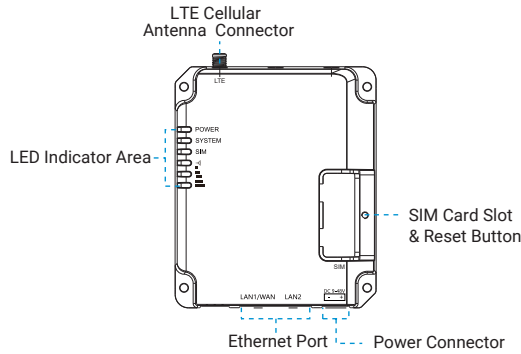

UR32

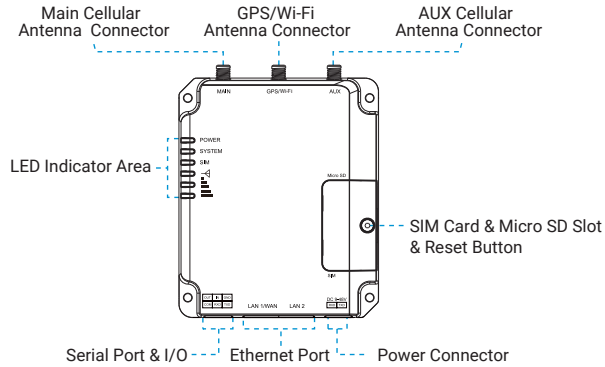

UR35

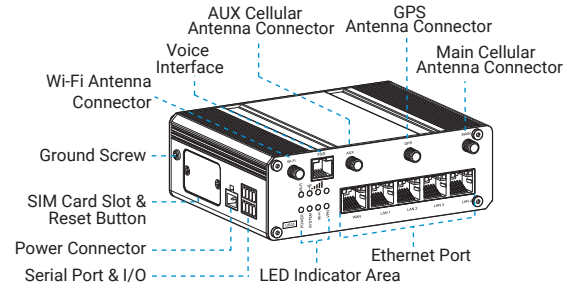

UR41

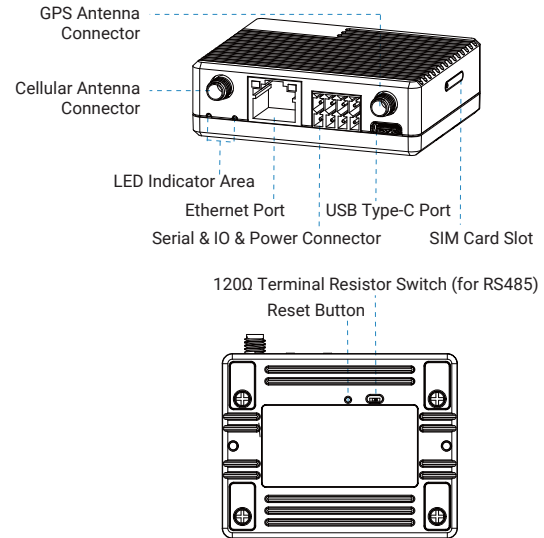

UR75

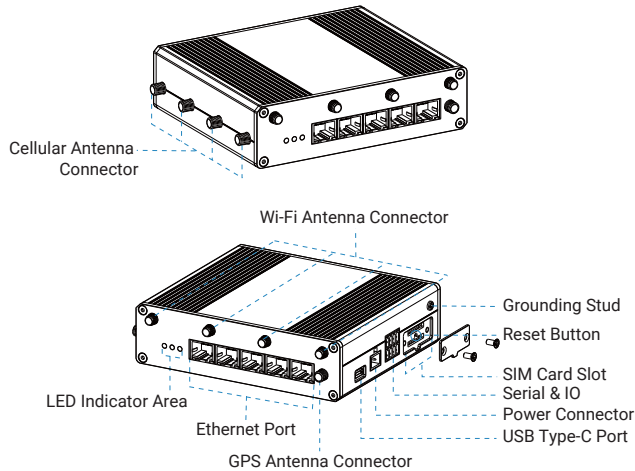

⚠ How to reset the device to factory default?

Press and hold the reset button for more than 5 seconds until SYSYEM LED is rapidly blinking.

3. Fitting Installation

SIM Card

UR3x & UR75: Insert the SIM card into the device according to the arrow icon on the device.

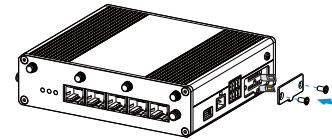
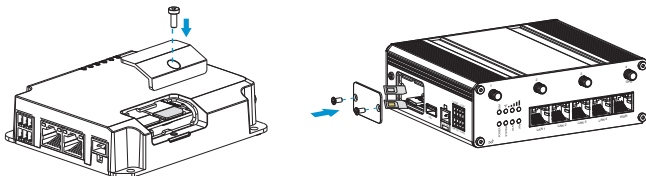

Note: UR3x does not support hot plugging (also called hot swapping). Please turn off the power before you insert or take off SIM cards.

UR41: Press the hole beside SIM slot with the ejector tool to pop up the slot, insert the nano SIM card, then put the slot with SIM card back to device.

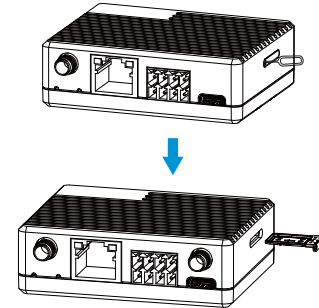

Antenna

Rotate antennas into the antenna connectors. Antennas should be installed vertically and the device should be placed always on a site with a good signal.

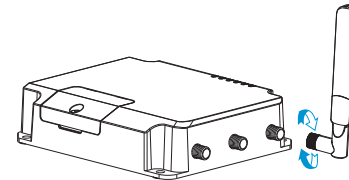

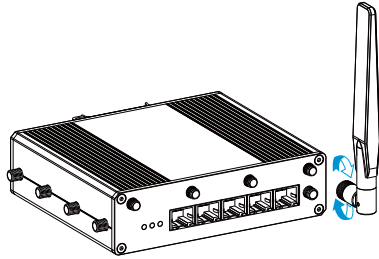

4. Router Installation

UR series routers can be placed on desktop or mounted to a wall or DIN rail. Before you start, make sure that your SIM card has been inserted, your antennas have been attached and all cables have been installed.

Note: Do not power on the device or connect it to other electrical device when installing.

DIN Rail Mounting

Use 2 pcs of M3 × 6 flat head Phillips screws to fix the mount clip to the router, and then hang the device to the DIN rail. The width of DIN rail is 3.5cm.

UR32L/UR32

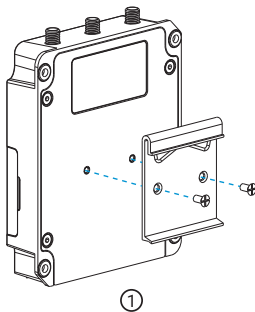

①

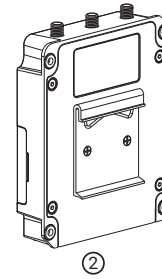

②

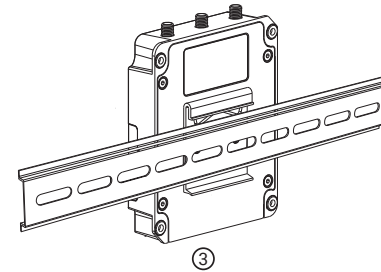

③

UR35/UR75

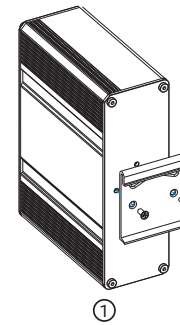

①

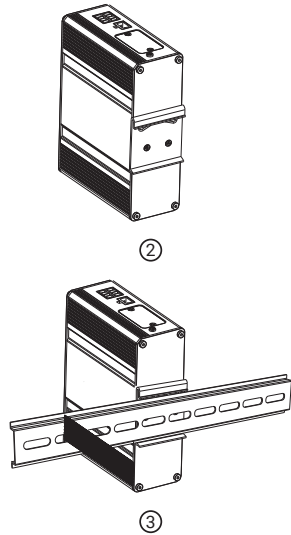

Wall Mounting

UR32L/UR32

Drill four holes on the wall by using your drill and insert four wall plugs into the holes respectively, and then use 4 pcs of M3 × 6 flat head Phillips screws to fix the router to the wall.

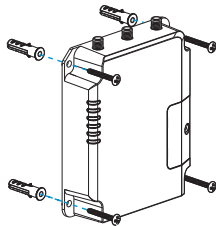

UR41

1. Fix the wall mounting bracket to the device with 2 screws.

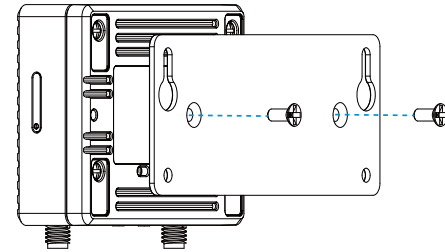

2. Drill 4 holes on the wall according to wall mounting bracket, then fix the wall plugs into the wall.

3. Fix the device to the wall plugs with screws. When installation, it's suggested to fix the upper two screws first.

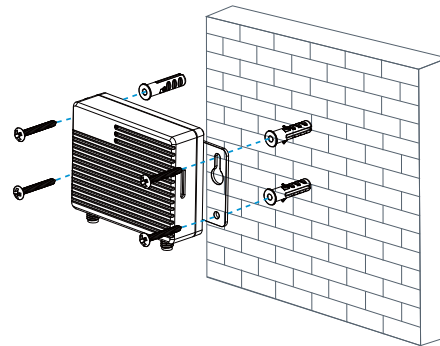

Lite/Pro/Ultra Series Industrial Cellular Router

Thank you
for choosing
Milesight Product

Milesight IoT Co., Ltd.

5. Web GUI Access

UR series provides web-based configuration interface for management. If it is the first time you configure the router, please use the default settings below:

IP Address: **192.168.1.1**

Username: **admin**

Password: **password**

Browser: Chrome (recommended)

Wired Access

Step 1: Connect any **LAN** port of router to PC.

Step 2: Configure the IP address of computer manually or automatically. Here are steps of configuring computer IP address manually based on Windows 10.

- Go to "Control Panel" → "Network and Internet" → "Network and Sharing Center", then click "Ethernet" (It may have different names).

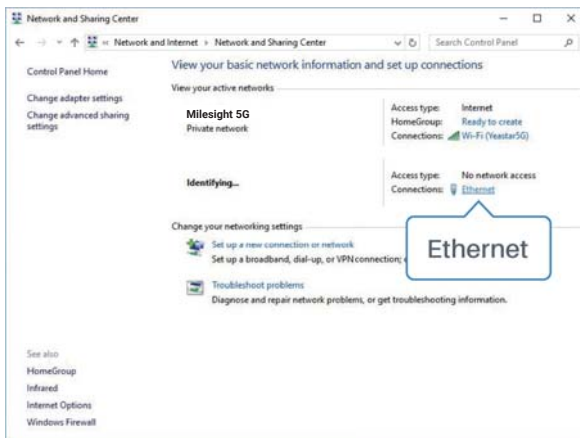

- Go to "Properties" → "Internet Protocol Version 4 (TCP/IPv4) Properties", select "Obtain IP address automatically" or "Use the following IP address" to assign a static IP manually within the same subnet of router.

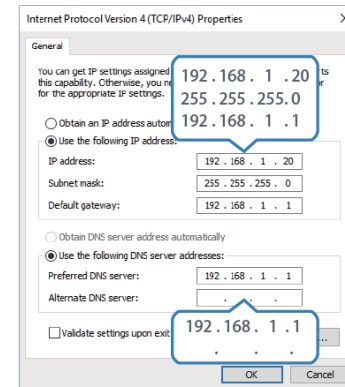
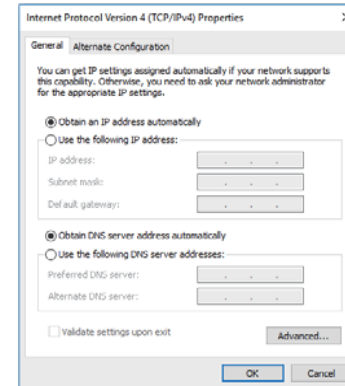

Step 3: Open a browser and type default IP address to log in the web GUI of the router.



Wireless Access (Wi-Fi Model Only)

Enable Wireless Network Connection on your computer and search for access point "Router_*****" (last 6 bits of MAC address) to connect it. After it is connected, type 192.168.1.1 to your Internet browser to log in the web GUI of routers.

6. Safety Precautions

- Milesight will not shoulder responsibility for any loss or damage resulting from not following the instructions of this operating guide.
- The device must not be dismantled or modified in any way.
- Do not place the device close to objects with naked flames.
- Do not place the device where the temperature is below/above the operating range.
- Do not power on the device or connect it to other electrical device when installing.
- Do not connect or power the device using cables that have been damaged.

7. FCC Statement

Any Changes or modifications not expressly approved by the party responsible for compliance could void the user's authority to operate the equipment. This device complies with part 15 of the FCC Rules. Operation is subject to the following two conditions:

- (1) This device may not cause harmful interference, and
- (2) This device must accept any interference received, including interference that may cause undesired operation.

Note: This equipment has been tested and found to comply with the limits for a Class B digital device, pursuant to part 15 of the FCC Rules. These limits are designed to provide reasonable protection against harmful interference in a residential installation. This equipment generates, uses and can radiate radio frequency energy and, if not installed and used in accordance with the instructions, may cause harmful interference to radio communications. However, there is no guarantee that interference will not occur in a particular installation. If this equipment does cause harmful interference to radio or television reception, which can be determined by turning the equipment off and on, the user is encouraged to try to correct the interference by one or more of the following measures:

- Reorient or relocate the receiving antenna.
- Increase the separation between the equipment and receiver.
- Connect the equipment into an outlet on a circuit different from that to which the receiver is connected.
- Consult the dealer or an experienced radio/TV technician for help.

FCC Radiation Exposure Statement:

This equipment complies with FCC radiation exposure limits set forth for an uncontrolled environment .

This transmitter must not be co - located or operating in conjunction with any other antenna or transmitter.

This equipment should be installed and operated with minimum distance 20cm between the radiator &you body.