



WHA YU INDUSTRIAL CO., LTD.(HEAD OFFICE)



DONGGUAN AEON TECH CO.,LTD.(CHINA)

SPECIFICATION FOR APPROVAL

CUSTOMER: 星縱智能

PART NAME: RF Antenna Assembly

PART NO.:

REVISION:

W. Y. P/NO.: C4254-510037-A(SSR-220281)

REV.: XI

	MANUFACTURER SIGNATURE	CUSTOMER SIGNATURE
APPROVED BY :		
DATE :	12/11/12	

WHA YU GROUP

WHA YU INDUSTRIAL CO., LTD.(HEAD OFFICE)

譚裕實業股份有限公司

Address: No. 326,Sec. 2,Kung Tao 5 Road, Hsin Chu City, Taiwan, R.O.C.

Tel:+886-3-5714225(REP.) Fax:+ 886-3-5713853 · + 886-3-5723600

DONGGUAN AEON TECH CO.,LTD.(CHINA)

東莞台霖電子通訊有限公司

Address:Hupan Industrial District,Tai Ling Shan Town,Dong Guan City,Guangdong,China

Tel:+86-769-85655858 Fax:+86-769-85655258

Contents

<i>Item</i>	<i>Description</i>	<i>Page</i>
1.	規格表 1
2.	成品圖 2
3.	測試報告 3~7

RF Antenna Assembly

Specification

1. Electrical Properties :

- 1.1 Frequency Range..... 902~928MHz
- 1.2 Impedance 50Ω Nominal
- 1.3 VSWR 2.2:1 Max.
- 1.4 Return Loss..... 8.5 dB Min.
- 1.5 Radiation Omni-directional
- 1.6 Gain(peak)..... 1dBi
- 1.7 Polarization..... Linear
- 1.8 Admitted Power.....1W
- 1.9 Cable..... RG-178 Cable
- 1.10 Connector..... SMA Plug Standard

2. Physical Properties :

- 2.1 Operating Temp. -10°C ~ +60°C
- 2.2 Storage Temp. -10°C ~ +70°C

REV	DATE	DESCRIPTION
X1	01/08-2021	New Issue

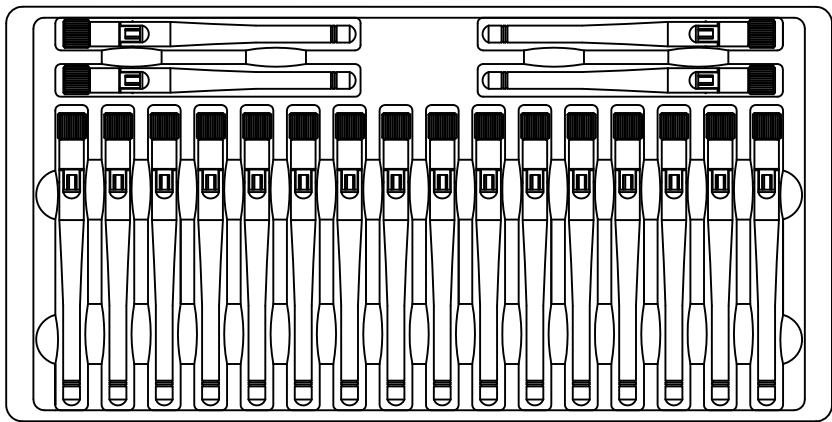
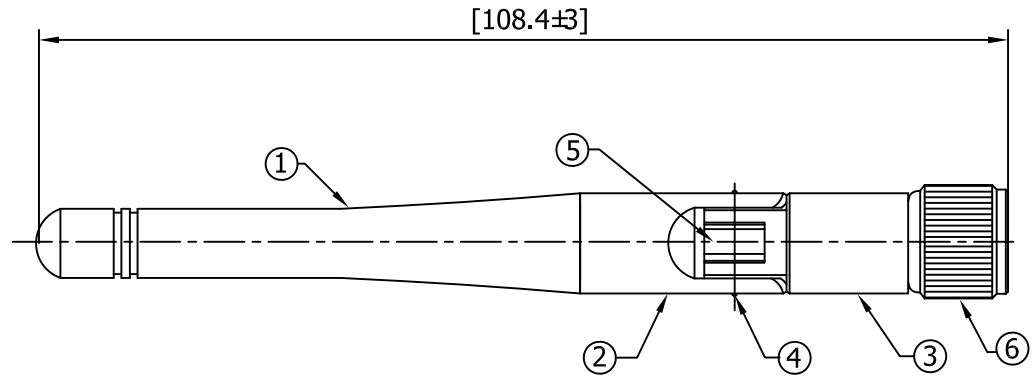
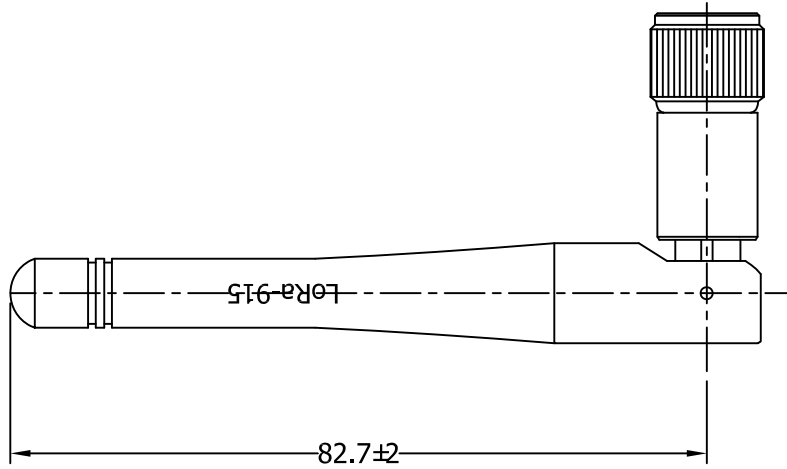

Packing:每Tray盤裝20PCS成品

NO	DESCRIPTION	QTY	REMARK
6	Connector SMA Straight Plug Standard	1	
5	Cable RG-178Cable,Transparency Brown,50Ω	1	
4	Rivet POM,Color:Black[黑色]	2	
3	Antenna Base (CD-348)PC+PBT,Color:Black[黑色]	1	
2	Antenna Base (CD-373)PC,Color:Black[黑色]	1	
1	Antenna Body (CD-379)TPE,Color:Black[黑色]	1	

CUSTOMER'S SINGATURE	XX.	±5.0	APPROVED Spring	CUSTOMER: 星縱智能		
	X.	±3.0		PART NO : 23.003.000015		
	.X	±1.0	CHECKED	PART NAME: RF Antenna Assembly		
	.XX	±0.5		W.Y P/NO : C4254-510037-A		
	.XXX	±0.1	DRAWING 葉雁麗	REV	UNIT	FILE
				X1	mm	SHEET

M.gear Wha Yu Group
 THIS DRAWING, AND IT'S INHERANT DESIGN CONCEPTS, ARE THE PROPERTY OF WHA YU AND AS SUCH MAY NOT BE COPIED, REPRODUCED, OR GIVEN TO THIRD PARTIES WITHOUT THE WRITTEN CONSENT OF WHA YU.

RF Antenna Assembly

Spec:902~928MHz

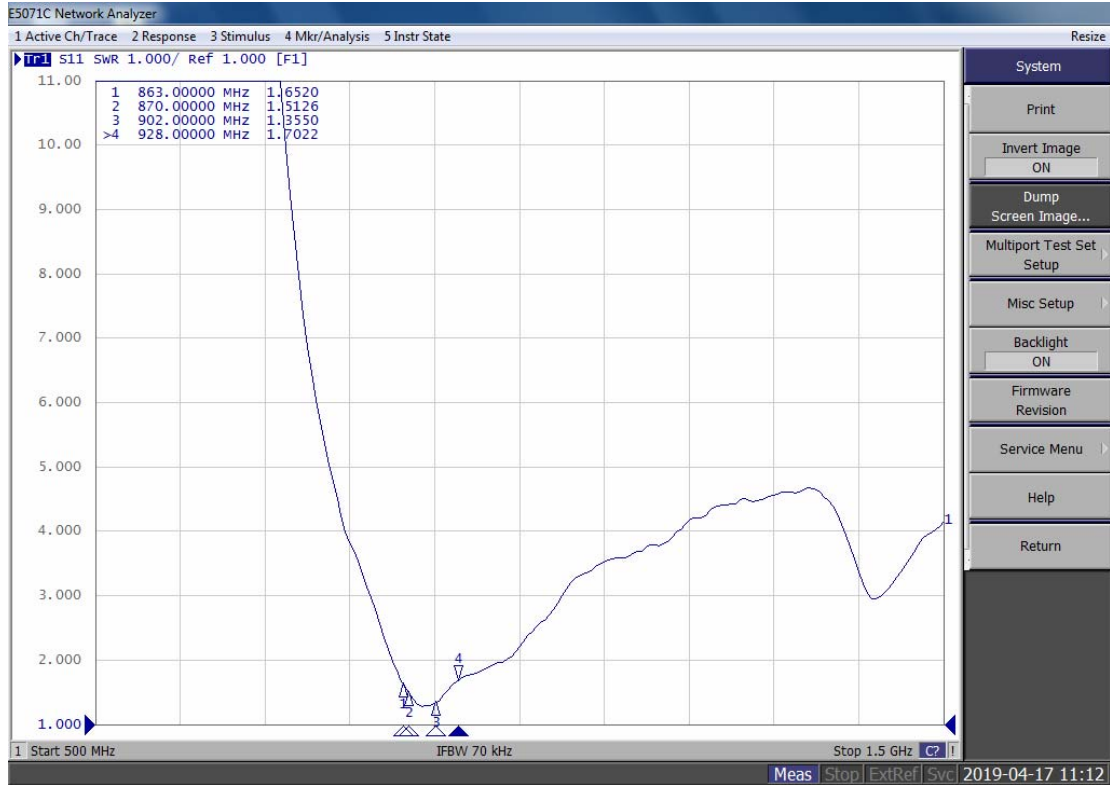

RF Antenna Assembly

Spec:902~928MHz

902.0MHz H+V, Eff: 50.5%

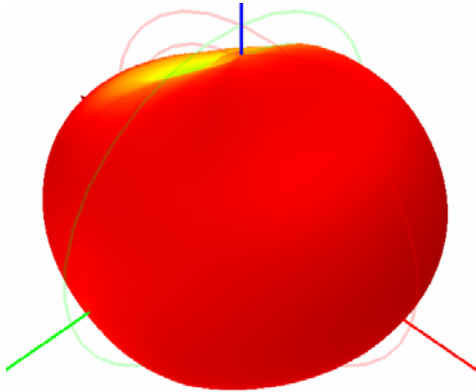

Back View

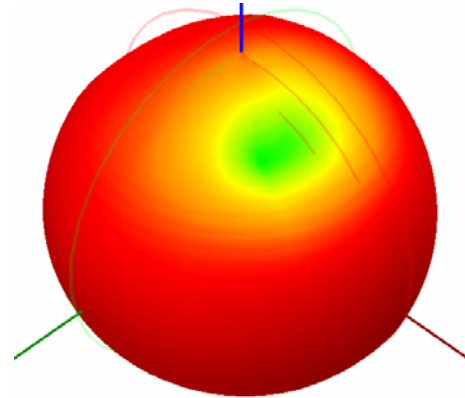

915.0MHz H+V, Eff: 48.9%

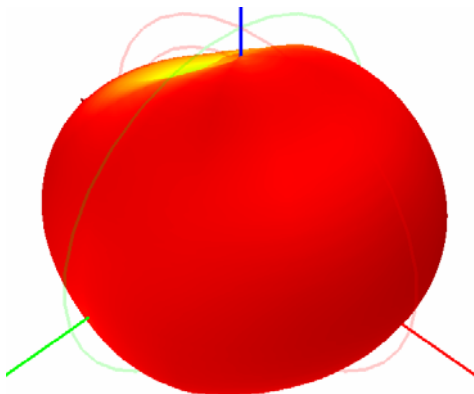

Back View

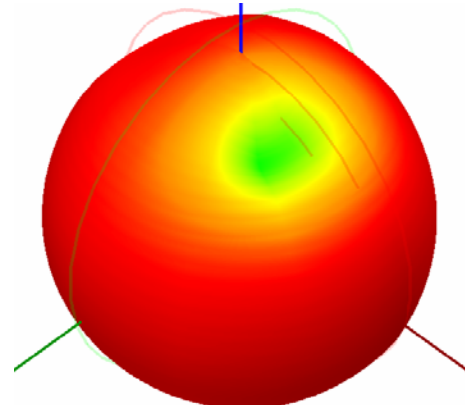

928.0MHz H+V, Eff: 48.1%

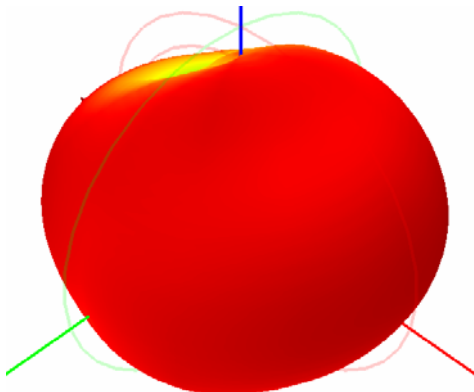

Back View

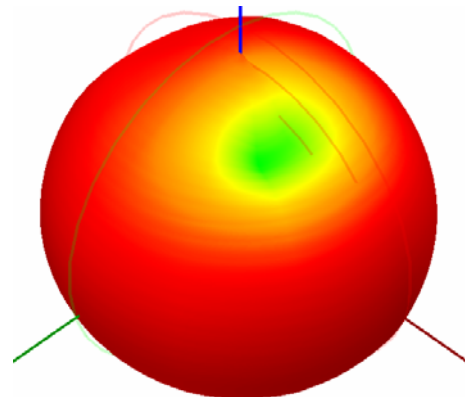

RF Antenna Assembly

Spec: 902~928MHz

902.0MHz Total(E1)

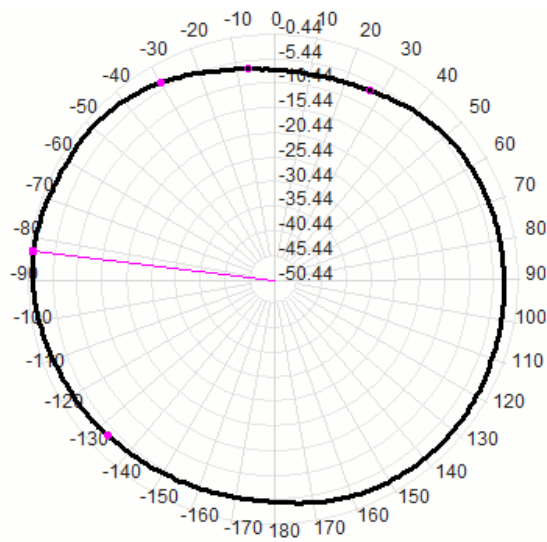

902.0MHz Total(E2)

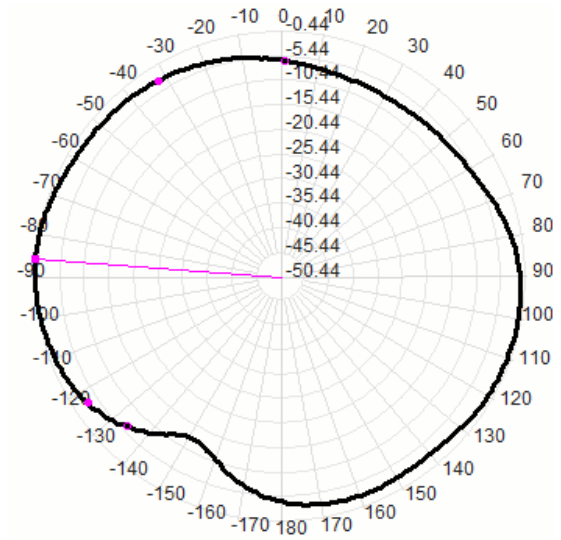

902.0MHz Total(H)

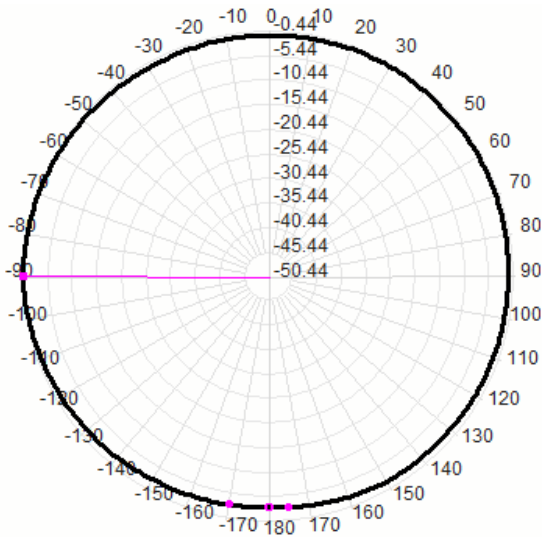

RF Antenna Assembly

Spec: 902~928MHz

915.0MHz Total(E1),

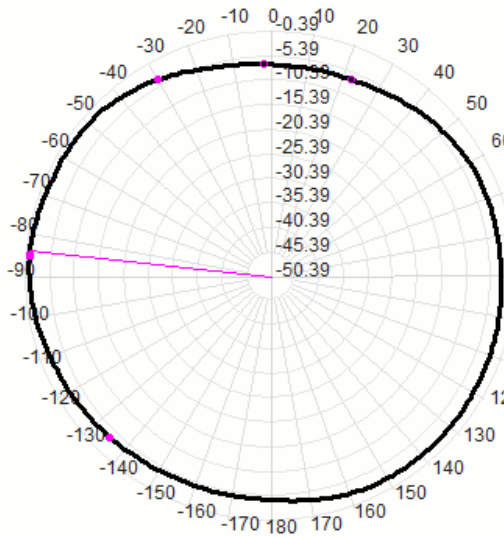

915.0MHz Total(E2),

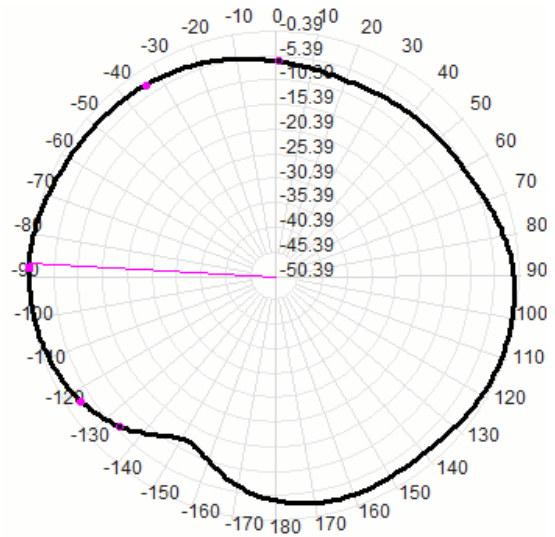

915.0MHz Total(H)

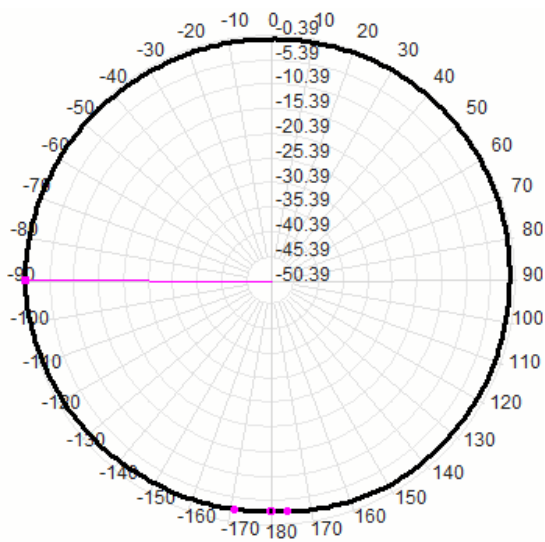

RF Antenna Assembly

Spec: 902~928MHz

928.0MHz Total(E1)

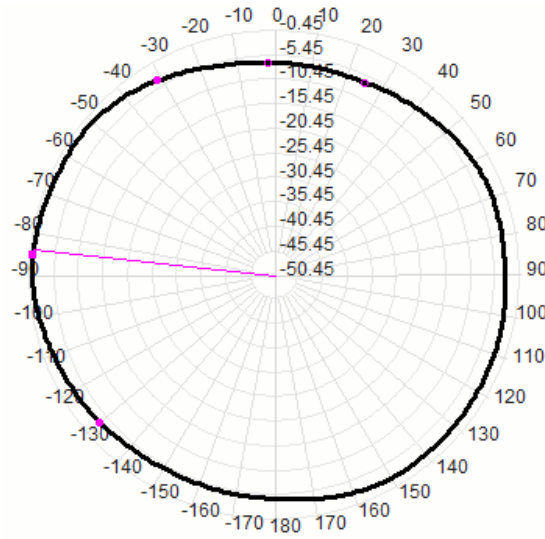

928.0MHz Total(E2)

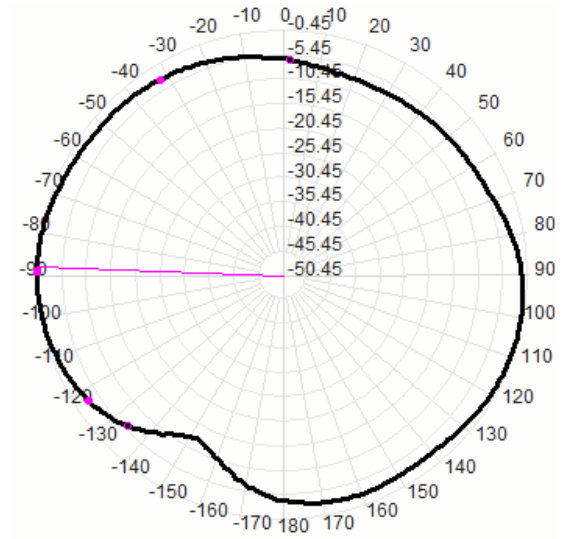

928.0MHz Total(H)

