



中认信通
CHINA CERTIFICATION ICT CO., LTD (DONGGUAN)



TEST REPORT

Applicant: Xiamen Milesight IoT Co., Ltd.

Address: Building C09, Software Park Phase III, Xiamen 361024, Fujian, China

FCC ID: 2AYHY-SC211

Product Name: 4G Solar-powered ANPR Camera

Model Number: SC211-NA, NS211-NA

**Standard(s): 47 CFR Part 15, Subpart C(15.247)
ANSI C63.10-2013
KDB 558074 D01 15.247 Meas Guidance v05r02**

The above equipment has been tested and found compliant with the requirement of the relative standards by China Certification ICT Co., Ltd (Dongguan)

Report Number: CR221046105-00A

Date Of Issue: 2022/11/09

Reviewed By: Sun Zhong

Sun Zhong

Title: Manager

Test Laboratory: China Certification ICT Co., Ltd (Dongguan)

No. 113, Pingkang Road, Dalang Town, Dongguan,

Guangdong, China

Tel: +86-769-82016888

Test Facility

The Test site used by China Certification ICT Co., Ltd (Dongguan) to collect test data is located on the No. 113, Pingkang Road, Dalang Town, Dongguan, Guangdong, China.

The lab has been recognized as the FCC accredited lab under the KDB 974614 D01 and is listed in the FCC Public Access Link (PAL) database, FCC Registration No. : 442868, the FCC Designation No. : CN1314.

The lab has been recognized by Innovation, Science and Economic Development Canada to test to Canadian radio equipment requirements, the CAB identifier: CN0123.

Declarations

China Certification ICT Co., Ltd (Dongguan) is not responsible for the authenticity of any test data provided by the applicant. Data included from the applicant that may affect test results are marked with a triangle symbol “▲”. Customer model name, addresses, names, trademarks etc. are not considered data.

Unless otherwise stated the results shown in this test report refer only to the sample(s) tested.

This report cannot be reproduced except in full, without prior written approval of the Company.

This report is valid only with a valid digital signature. The digital signature may be available only under the Adobe software above version 7.0.

This report may contain data that are not covered by the accreditation scope and shall be marked with an asterisk “★”.

CONTENTS

TEST FACILITY	2
DECLARATIONS.....	2
1. GENERAL INFORMATION	5
1.1 PRODUCT DESCRIPTION FOR EQUIPMENT UNDER TEST (EUT)	5
1.2 DESCRIPTION OF TEST CONFIGURATION.....	6
1.2.1 EUT Operation Condition:.....	6
1.2.2 Support Equipment List and Details	6
1.2.3 Support Cable List and Details	6
1.2.4 Block Diagram of Test Setup.....	7
1.3 MEASUREMENT UNCERTAINTY	8
2. SUMMARY OF TEST RESULTS	9
3. REQUIREMENTS AND TEST PROCEDURES	10
3.1 AC LINE CONDUCTED EMISSIONS.....	10
3.1.1 Applicable Standard.....	10
3.1.2 EUT Setup.....	11
3.1.3 EMI Test Receiver Setup	11
3.1.4 Test Procedure	12
3.1.5 Corrected Amplitude & Margin Calculation.....	12
3.2 RADIATION SPURIOUS EMISSIONS	13
3.2.1 Applicable Standard.....	13
3.2.2 EUT Setup.....	13
3.2.3 EMI Test Receiver & Spectrum Analyzer Setup	14
3.2.4 Test Procedure	14
3.2.5 Corrected Amplitude & Margin Calculation.....	14
3.3 6 DB EMISSION BANDWIDTH:.....	15
3.3.1 Applicable Standard.....	15
3.3.2 EUT Setup.....	15
3.3.3 Test Procedure	15
3.4 MAXIMUM PEAK CONDUCTED OUTPUT POWER:.....	16
3.4.1 Applicable Standard.....	16
3.4.2 EUT Setup.....	16
3.4.3 Test Procedure	16
3.5 MAXIMUM POWER SPECTRAL DENSITY:	17
3.5.1 Applicable Standard.....	17
3.5.2 EUT Setup.....	17
3.5.3 Test Procedure	17
3.6 100 KHZ BANDWIDTH OF FREQUENCY BAND EDGE:	18
3.6.1 Applicable Standard.....	18
3.6.2 EUT Setup.....	18
3.6.3 Test Procedure	18
3.7 DUTY CYCLE:.....	19

3.7.1 EUT Setup.....19

3.7.2 Test Procedure19

3.8 ANTENNA REQUIREMENT.....19

3.8.1 Applicable Standard.....19

3.8.2 Judgment.....19

4. Test DATA AND RESULTS..... 20

4.1 AC LINE CONDUCTED EMISSIONS.....20

4.2 RADIATION SPURIOUS EMISSIONS23

4.3 6 DB EMISSION BANDWIDTH:31

4.4 MAXIMUM PEAK CONDUCTED OUTPUT POWER:35

4.5 MAXIMUM POWER SPECTRAL DENSITY:36

4.6 100 KHZ BANDWIDTH OF FREQUENCY BAND EDGE:40

4.7 DUTY CYCLE:.....44

5. RF EXPOSURE EVALUATION 46

5.1 APPLICABLE STANDARD.....46

5.2 MEASUREMENT RESULT47

1. GENERAL INFORMATION

1.1 Product Description for Equipment under Test (EUT)

EUT Name:	4G Solar-powered ANPR Camera
EUT Model:	SC211-NA
Multiple Model:	NS211-NA
Operation Frequency:	2412-2462 MHz(802.11b/g/n ht20)
Maximum Peak Output Power (Conducted):	18.16dBm
Modulation Type:	802.11b:DSSS-DBPSK, DQPSK, CCK 802.11g/n:OFDM-BPSK, QPSK, 16QAM, 64QAM
Rated Input Voltage:	DC 5V from USB port, DC 18V from DC port or DC 3.3V from battery
Serial Number:	CR221046105-RF-S1
EUT Received Date:	2022.10.13
EUT Received Status:	Good
Note: The Multiple models are electrically identical with the test model. Please refer to the declaration letter for more detail, which was provided by manufacturer.	

Operation Frequency Detail: For 802.11b/g/n ht20:

Channel	Frequency (MHz)	Channel	Frequency (MHz)
1	2412	7	2442
2	2417	8	2447
3	2422	9	2452
4	2427	10	2457
5	2432	11	2462
6	2437	/	/

Per section 15.31(m), the below frequencies were performed the test as below:

Test Channel	Frequency (MHz)
Lowest	2412
Middle	2437
Highest	2462

Antenna Information Detail▲:

Manufacturer	Antenna Type	input impedance (Ohm)	Frequency Range	Antenna Gain
Shenzhen Yingjia Chuang Electronic Technology Co., LTD	PCB	50	2400-2500MHz	1.93dBi

The Method of §15.203 Compliance:

- Antenna must be permanently attached to the unit.
 Antenna must use a unique type of connector to attach to the EUT.
 Unit must be professionally installed, and installer shall be responsible for verifying that the correct antenna is employed with the unit.

Accessory Information:

No

1.2 Description of Test Configuration

1.2.1 EUT Operation Condition:

EUT Operation Mode:	The system was configured for testing in Engineering Mode, which was provided by the manufacturer.			
Equipment Modifications:	No			
EUT Exercise Software:	PuTTY			
The software “PuTTY” was provided by manufacturer. The maximum power was configured as below, that was provided by the manufacturer ▲ :				
Mode	Channel	Frequency (MHz)	Data Rate	Power Level Setting
802.11b	Lowest	2412	1Mbps	48
	Middle	2437	1Mbps	45
	Highest	2462	1Mbps	43
802.11g	Lowest	2412	6Mbps	36
	Middle	2437	6Mbps	35
	Highest	2462	6Mbps	33
802.11n ht20	Lowest	2412	MCS0	34
	Middle	2437	MCS0	33
	Highest	2462	MCS0	31
Note: The above are the worst-case data rates, which are determined for each mode based upon investigations by measuring the average power and PSD across all data rates, bandwidths, and modulations.				

1.2.2 Support Equipment List and Details

Manufacturer	Description	Model	Serial Number
Vietnam Honor High Tech Company Limited	Adapter	ADS-10LA-06 050 10EPCU	000051
Xiamen Milesight IoT Co., Ltd.	Solar Panel	Unknown	CR221046105-RF-S2

1.2.3 Support Cable List and Details

Cable Description	Shielding Type	Ferrite Core	Length (m)	From Port	To
USB Cable	No	No	0.8	Adapter	EUT
MC4 Cable	Yes	No	1.2	EUT	Solar Panel

1.2.4 Block Diagram of Test Setup

AC line conducted emissions:

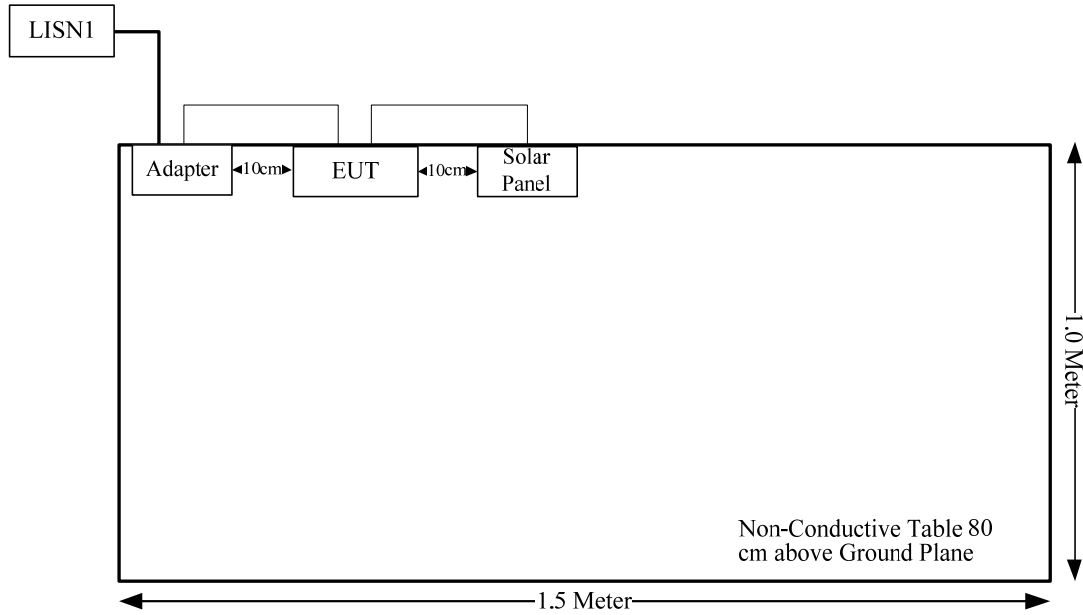

Spurious Emissions:

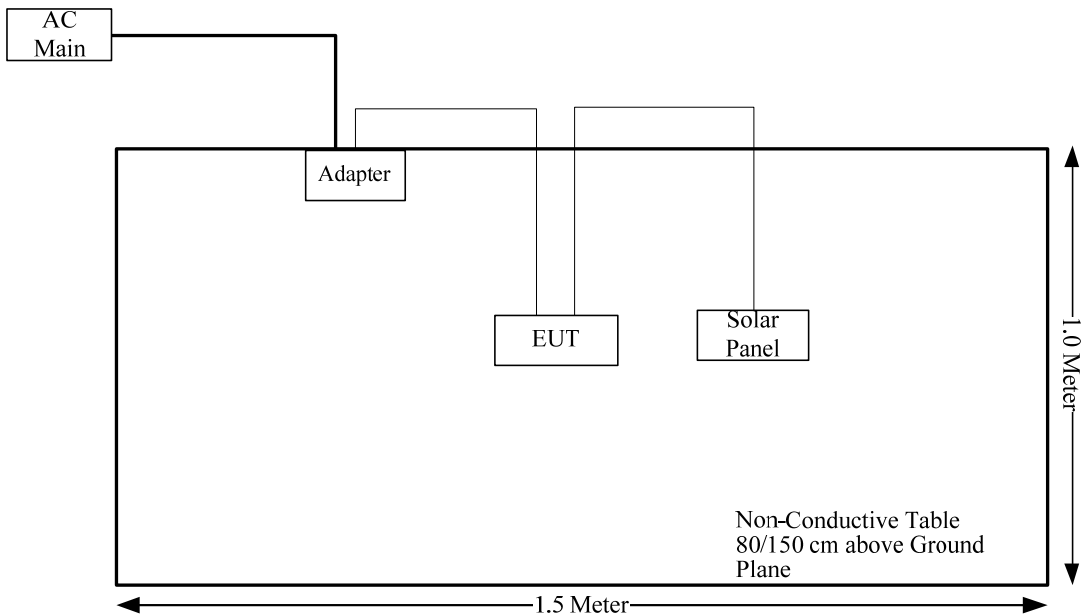

1.3 Measurement Uncertainty

Otherwise required by the applicant or Product Regulations, Decision Rule in this report did not consider the uncertainty. The extended uncertainty given in this report is obtained by combining the standard uncertainty times the coverage factor K with the 95% confidence interval.

Parameter	Measurement Uncertainty
Occupied Channel Bandwidth	±5 %
RF output power, conducted	±0.61dB
Power Spectral Density, conducted	±0.61 dB
Unwanted Emissions, radiated	30M~200MHz: 4.15 dB,200M~1GHz: 5.61 dB,1G~6GHz: 5.14 dB, 6G~18GHz: 5.93 dB,18G~26.5G:5.47 dB,26.5G~40G:5.63 dB
Unwanted Emissions, conducted	±1.26 dB
Temperature	±1°C
Humidity	±5%
DC and low frequency voltages	±0.4%
Duty Cycle	1%
AC Power Lines Conducted Emission	2.8 dB (150 kHz to 30 MHz)

2. SUMMARY OF TEST RESULTS

Standard(s) Section	Test Items	Result
§15.207(a)	AC line conducted emissions	Compliant
§15.205, §15.209, §15.247(d)	Spurious Emissions	Compliant
§15.247 (a)(2)	6 dB Bandwidth	Compliant
§15.247(b)(3)	Maximum Conducted Output Power	Compliant
§15.247(d)	100 kHz Bandwidth of Frequency Band Edge	Compliant
§15.247(e)	Power Spectral Density	Compliant
§15.203	Antenna Requirement	Compliant
§15.247 (i) & §1.1307 & §2.1091	RF Exposure Evaluation	Compliant

3. REQUIREMENTS AND TEST PROCEDURES

3.1 AC Line Conducted Emissions

3.1.1 Applicable Standard

FCC§15.207(a).

(a) Except as shown in paragraphs (b) and (c) of this section, for an intentional radiator that is designed to be connected to the public utility (AC) power line, the radio frequency voltage that is conducted back onto the AC power line on any frequency or frequencies, within the band 150 kHz to 30 MHz, shall not exceed the limits in the following table, as measured using a 50 μ H/50 ohms line impedance stabilization network (LISN). Compliance with the provisions of this paragraph shall be based on the measurement of the radio frequency voltage between each power line and ground at the power terminal. The lower limit applies at the boundary between the frequency ranges.

Frequency of emission (MHz)	Conducted limit (dB μ V)	
	Quasi-peak	Average
0.15-0.5	66 to 56*	56 to 46*
0.5-5	56	46
5-30	60	50

*Decreases with the logarithm of the frequency.

(b) The limit shown in paragraph (a) of this section shall not apply to carrier current systems operating as intentional radiators on frequencies below 30 MHz. In lieu thereof, these carrier current systems shall be subject to the following standards:

(1) For carrier current system containing their fundamental emission within the frequency band 535-1705 kHz and intended to be received using a standard AM broadcast receiver: no limit on conducted emissions.

(2) For all other carrier current systems: 1000 μ V within the frequency band 535-1705 kHz, as measured using a 50 μ H/50 ohms LISN.

(3) Carrier current systems operating below 30 MHz are also subject to the radiated emission limits in §15.205, §15.209, §15.221, §15.223, or §15.227, as appropriate.

(c) Measurements to demonstrate compliance with the conducted limits are not required for devices which only employ battery power for operation and which do not operate from the AC power lines or contain provisions for operation while connected to the AC power lines. Devices that include, or make provisions for, the use of battery chargers which permit operating while charging, AC adapters or battery eliminators or that connect to the AC power lines indirectly, obtaining their power through another device which is connected to the AC power lines, shall be tested to demonstrate compliance with the conducted limits.

3.1.2 EUT Setup

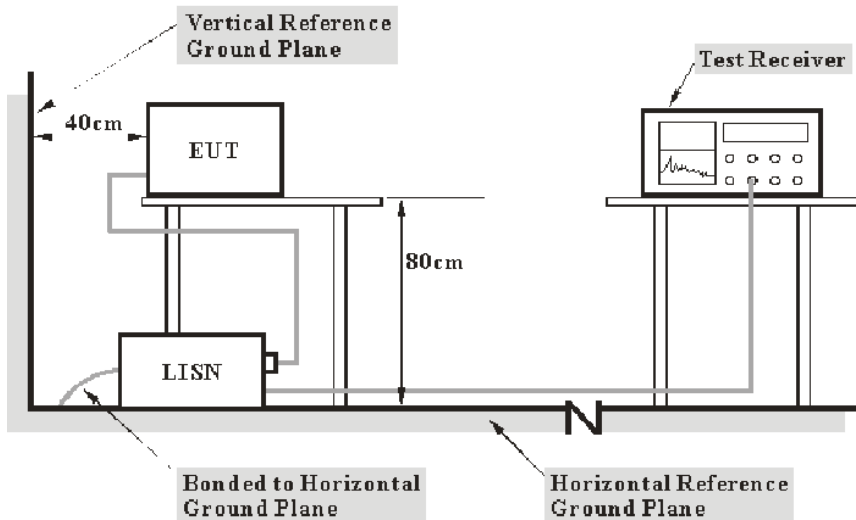

- Note: 1. Support units were connected to second LISN.
 2. Both of LISNs (AMN) 80 cm from EUT and at the least 80 cm from other units and other metal planes support units.

The setup of EUT is according with per ANSI C63.10-2013 measurement procedure. The specification used was with the FCC Part 15.207 limits.

The spacing between the peripherals was 10 cm.

The adapter or EUT was connected to the main LISN with a 120 V/60 Hz AC power source.

3.1.3 EMI Test Receiver Setup

The EMI test receiver was set to investigate the spectrum from 150 kHz to 30 MHz.

During the conducted emission test, the EMI test receiver was set with the following configurations:

Frequency Range	IF B/W
150 kHz – 30 MHz	9 kHz

3.1.4 Test Procedure

The frequency and amplitude of the six highest ac power-line conducted emissions relative to the limit, measured over all the current-carrying conductors of the EUT power cords, and the operating frequency or frequency to which the EUT is tuned (if appropriate), should be reported, unless such emissions are more than 20 dB below the limit. AC power-line conducted emissions measurements are to be separately carried out only on each of the phase (“hot”) line(s) and (if used) on the neutral line(s), but not on the ground [protective earth] line(s). If less than six emission frequencies are within 20 dB of the limit, then the noise level of the measuring instrument at representative frequencies should be reported. The specific conductor of the power-line cord for each of the reported emissions should be identified. Measure the six highest emissions with respect to the limit on each current-carrying conductor of each power cord associated with the EUT (but not the power cords of associated or peripheral equipment that are part of the test configuration). Then, report the six highest emissions with respect to the limit from among all the measurements identifying the frequency and specific current-carrying conductor identified with the emission. The six highest emissions should be reported for each of the current-carrying conductors, or the six highest emissions may be reported over all the current-carrying conductors.

3.1.5 Corrected Amplitude & Margin Calculation

The basic equation is as follows:

Result = Reading + Factor

Factor = attenuation caused by cable loss + voltage division factor of AMN

The “**Margin**” column of the following data tables indicates the degree of compliance within the applicable limit. The equation for margin calculation is as follows:

Margin = Limit – Result

3.2 Radiation Spurious Emissions

3.2.1 Applicable Standard

FCC §15.247 (d);

In any 100 kHz bandwidth outside the frequency band in which the spread spectrum or digitally modulated intentional radiator is operating, the radio frequency power that is produced by the intentional radiator shall be at least 20 dB below that in the 100 kHz bandwidth within the band that contains the highest level of the desired power, based on either an RF conducted or a radiated measurement, provided the transmitter demonstrates compliance with the peak conducted power limits. If the transmitter complies with the conducted power limits based on the use of RMS averaging over a time interval, as permitted under paragraph (b)(3) of this section, the attenuation required under this paragraph shall be 30 dB instead of 20 dB. Attenuation below the general limits specified in §15.209(a) is not required. In addition, radiated emissions which fall in the restricted bands, as defined in §15.205(a), must also comply with the radiated emission limits specified in §15.209(a) (see §15.205(c)).

3.2.2 EUT Setup

Below 1GHz:

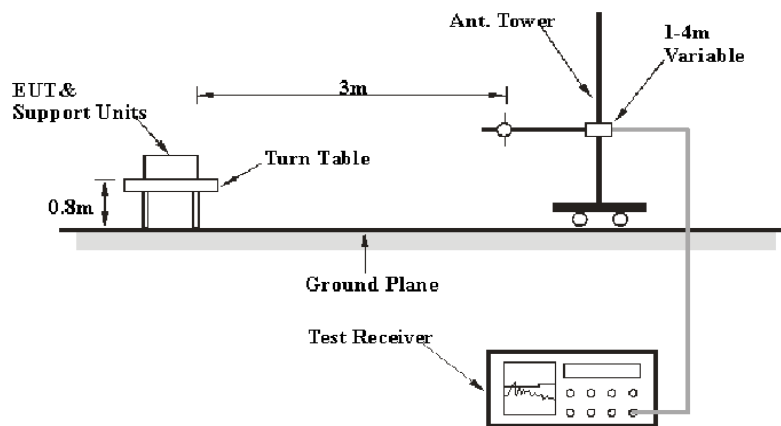

Above 1GHz:

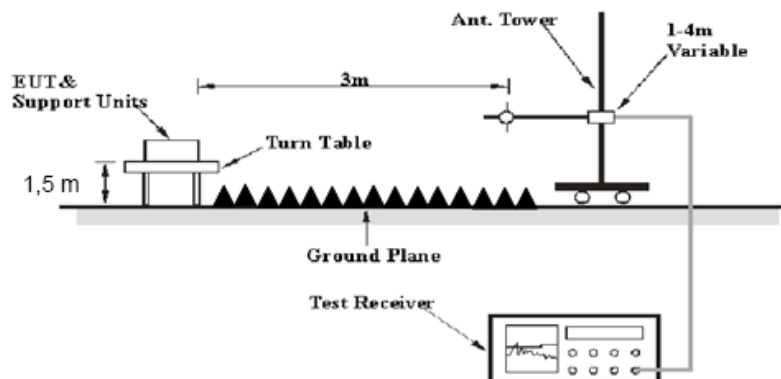

The radiated emissions were performed in the 3 meters distance, using the setup accordance with the ANSI C63.10-2013. The specification used was the FCC 15.209, and FCC 15.247 limits.

The external I/O cables were draped along the test table and formed a bundle 30 to 40 cm long in the middle.

The spacing between the peripherals was 10 cm.

3.2.3 EMI Test Receiver & Spectrum Analyzer Setup

The system was investigated from 30 MHz to 25 GHz.

During the radiated emission test, the EMI test receiver & Spectrum Analyzer Setup were set with the following configurations:

30MHz-1000MHz:

Measurement	RBW	Video B/W	IF B/W
QP	120 kHz	300 kHz	120kHz

1GHz- 25GHz:

Measurement	Duty cycle	RBW	Video B/W
PK	Any	1MHz	3 MHz
AV	>98%	1MHz	10 Hz
	<98%	1MHz	1/T

Note: T is minimum transmission duration

If the maximized peak measured value complies with under the QP/Average limit more than 6dB, then it is unnecessary to perform an QP/Average measurement.

3.2.4 Test Procedure

Maximizing procedure was performed on the highest emissions to ensure that the EUT complied with all installation combinations.

Data was recorded in Quasi-peak detection mode for frequency range of 30 MHz-1 GHz, peak and Average detection modes for frequencies above 1 GHz.

3.2.5 Corrected Amplitude & Margin Calculation

The basic equation is as follows:

Result = Reading + Factor

Factor = Antenna Factor + Cable Loss- Amplifier Gain

The “**Margin**” column of the following data tables indicates the degree of compliance within the applicable limit. The equation for margin calculation is as follows:

Margin = Limit – Result

3.3 6 dB Emission Bandwidth:

3.3.1 Applicable Standard

FCC §15.247 (a)(2)

Systems using digital modulation techniques may operate in the 902-928 MHz, 2400-2483.5 MHz, and 5725-5850 MHz bands. The minimum 6 dB bandwidth shall be at least 500 kHz.

3.3.2 EUT Setup

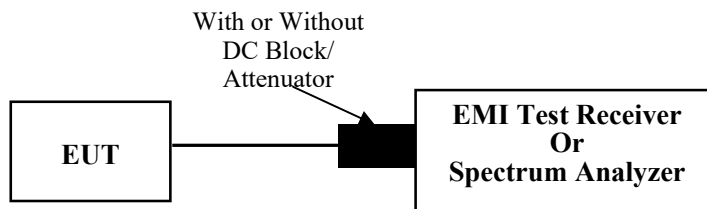

3.3.3 Test Procedure

According to ANSI C63.10-2013 Section 11.8

- a) Set RBW = 100 kHz.
- b) Set the video bandwidth (VBW) $\geq 3 \times$ RBW.
- c) Detector = Peak.
- d) Trace mode = max hold.
- e) Sweep = auto couple.
- f) Allow the trace to stabilize.
- g) Measure the maximum width of the emission that is constrained by the frequencies associated with the two outermost amplitude points (upper and lower frequencies) that are attenuated by 6 dB relative to the maximum level measured in the fundamental emission.

3.4 Maximum peak conducted output power:

3.4.1 Applicable Standard

FCC §15.247 (b)(3)

For systems using digital modulation in the 902-928 MHz, 2400-2483.5 MHz, and 5725-5850 MHz bands: 1 Watt. As an alternative to a peak power measurement, compliance with the one Watt limit can be based on a measurement of the maximum conducted output power. Maximum Conducted Output Power is defined as the total transmit power delivered to all antennas and antenna elements averaged across all symbols in the signaling alphabet when the transmitter is operating at its maximum power control level. Power must be summed across all antennas and antenna elements. The average must not include any time intervals during which the transmitter is off or is transmitting at a reduced power level. If multiple modes of operation are possible (e.g., alternative modulation methods), the maximum conducted output power is the highest total transmit power occurring in any mode.

3.4.2 EUT Setup

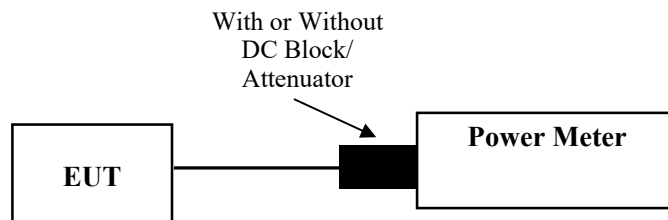

3.4.3 Test Procedure

According to ANSI C63.10-2013 Section 11.9.1.3

The maximum peak conducted output power may be measured using a broadband peak RF power meter. The power meter shall have a video bandwidth that is greater than or equal to the DTS bandwidth and shall use a fast-responding diode detector.

- a) Set the EUT in transmitting mode.
- b) Remove the antenna from the EUT and then connect a low loss RF cable from the antenna port to test equipment.
- c) Add a correction factor to the display.
- d) Set the power meter to test peak output power, record the result.

3.5 Maximum power spectral density:

3.5.1 Applicable Standard

FCC §15.247 (e)

For digitally modulated systems, the power spectral density conducted from the intentional radiator to the antenna shall not be greater than 8 dBm in any 3 kHz band during any time interval of continuous transmission. This power spectral density shall be determined in accordance with the provisions of paragraph (b) of this section. The same method of determining the conducted output power shall be used to determine the power spectral density.

3.5.2 EUT Setup

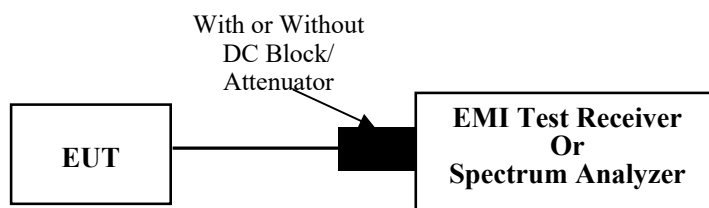

3.5.3 Test Procedure

According to ANSI C63.10-2013 Section 11.10.2

- a) Set analyzer center frequency to DTS channel center frequency.
- b) Set the span to 1.5 times the DTS bandwidth.
- c) Set the RBW to $3 \text{ kHz} \leq \text{RBW} \leq 100 \text{ kHz}$.
- d) Set the VBW $\geq [3 \text{ RBW}]$.
- e) Detector = peak.
- f) Sweep time = auto couple.
- g) Trace mode = max hold.
- h) Allow trace to fully stabilize.
- i) Use the peak marker function to determine the maximum amplitude level within the RBW.
- j) If measured value exceeds requirement, then reduce RBW (but no less than 3 kHz) and repeat.

3.6 100 kHz Bandwidth of Frequency Band Edge:

3.6.1 Applicable Standard

FCC §15.247 (d);

In any 100 kHz bandwidth outside the frequency band in which the spread spectrum or digitally modulated intentional radiator is operating, the radio frequency power that is produced by the intentional radiator shall be at least 20 dB below that in the 100 kHz bandwidth within the band that contains the highest level of the desired power, based on either an RF conducted or a radiated measurement, provided the transmitter demonstrates compliance with the peak conducted power limits. If the transmitter complies with the conducted power limits based on the use of RMS averaging over a time interval, as permitted under paragraph (b)(3) of this section, the attenuation required under this paragraph shall be 30 dB instead of 20 dB. Attenuation below the general limits specified in §15.209(a) is not required. In addition, radiated emissions which fall in the restricted bands, as defined in §15.205(a), must also comply with the radiated emission limits specified in §15.209(a) (see §15.205(c)).

3.6.2 EUT Setup

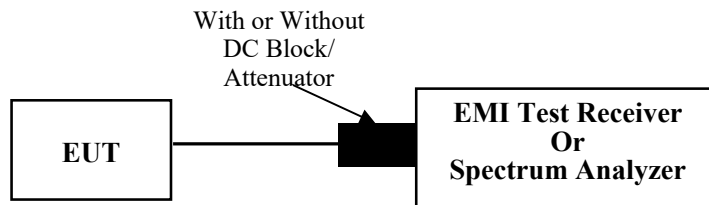

3.6.3 Test Procedure

According to ANSI C63.10-2013 Section 11.11

- a) Set the center frequency and span to encompass frequency range to be measured.
- b) Set the RBW = 100 kHz.
- c) Set the VBW $\geq [3 \times \text{RBW}]$.
- d) Detector = peak.
- e) Sweep time = auto couple.
- f) Trace mode = max hold.
- g) Allow trace to fully stabilize.
- h) Use the peak marker function to determine the maximum amplitude level.

Ensure that the amplitude of all unwanted emissions outside of the authorized frequency band (excluding restricted frequency bands) is attenuated by at least the minimum requirements specified in 11.11. Report the three highest emissions relative to the limit.

3.7 Duty Cycle:

3.7.1 EUT Setup

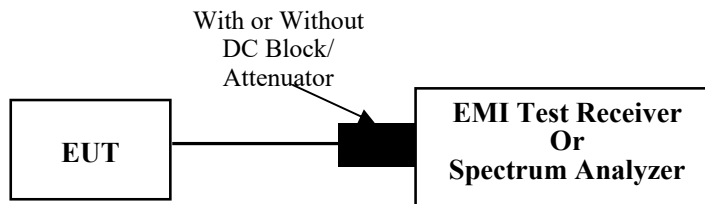

3.7.2 Test Procedure

According to ANSI C63.10-2013 Section 11.6

The zero-span mode on a spectrum analyzer or EMI receiver if the response time and spacing between bins on the sweep are sufficient to permit accurate measurements of the ON and OFF times of the transmitted signal:

- 1) Set the center frequency of the instrument to the center frequency of the transmission.
- 2) Set $RBW \geq OBW$ if possible; otherwise, set RBW to the largest available value.
- 3) Set $VBW \geq RBW$. Set detector = peak or average.
- 4) The zero-span measurement method shall not be used unless both RBW and VBW are $> 50/T$ and the number of sweep points across duration T exceeds 100. (For example, if VBW and/or RBW are limited to 3 MHz, then the zero-span method of measuring the duty cycle shall not be used if $T \leq 16.7 \mu s$.)

3.8 Antenna Requirement

3.8.1 Applicable Standard

FCC §15.203

An intentional radiator shall be designed to ensure that no antenna other than that furnished by the responsible party shall be used with the device. The use of a permanently attached antenna or of an antenna that uses a unique coupling to the intentional radiator shall be considered sufficient to comply with the provisions of this section. The manufacturer may design the unit so that a broken antenna can be replaced by the user, but the use of a standard antenna jack or electrical connector is prohibited. This requirement does not apply to carrier current devices or to devices operated under the provisions of §§15.211, 15.213, 15.217, 15.219, 15.221, or §15.236. Further, this requirement does not apply to intentional radiators that must be professionally installed, such as perimeter protection systems and some field disturbance sensors, or to other intentional radiators which, in accordance with §15.31(d), must be measured at the installation site. However, the installer shall be responsible for ensuring that the proper antenna is employed so that the limits in this part are not exceeded.

3.8.2 Judgment

Result: Compliant. Please refer to the Antenna Information detail in Section 1.

4. Test DATA AND RESULTS

4.1 AC Line Conducted Emissions

Serial Number:	CR221046105-RF-S1	Test Date:	2022/10/18
Test Site:	CE	Test Mode:	Transmitting (802.11b Middle channel was the worst)
Tester:	Vic Du	Test Result:	Pass

Environmental Conditions:

Temperature: (°C)	25.2	Relative Humidity: (%)	50	ATM Pressure: (kPa)	100.5
----------------------	------	------------------------------	----	------------------------	-------

Test Equipment List and Details:

Manufacturer	Description	Model	Serial Number	Calibration Date	Calibration Due Date
R&S	LISN	ENV216	101134	2022/04/01	2023/03/31
R&S	EMI Test Receiver	ESR3	102726	2022/07/15	2023/07/14
MICRO-COAX	Coaxial Cable	UTIFLEX	C-0200-01	2022/08/07	2023/08/06
Audix	Test Software	E3	190306 (V9)	N/A	N/A

* Statement of Traceability: China Certification ICT Co., Ltd (Dongguan) attests that all calibrations have been performed, traceable to National Primary Standards and International System of Units (SI).

Line:

Test Mode: Transmitting
 Port: Line
 Note:

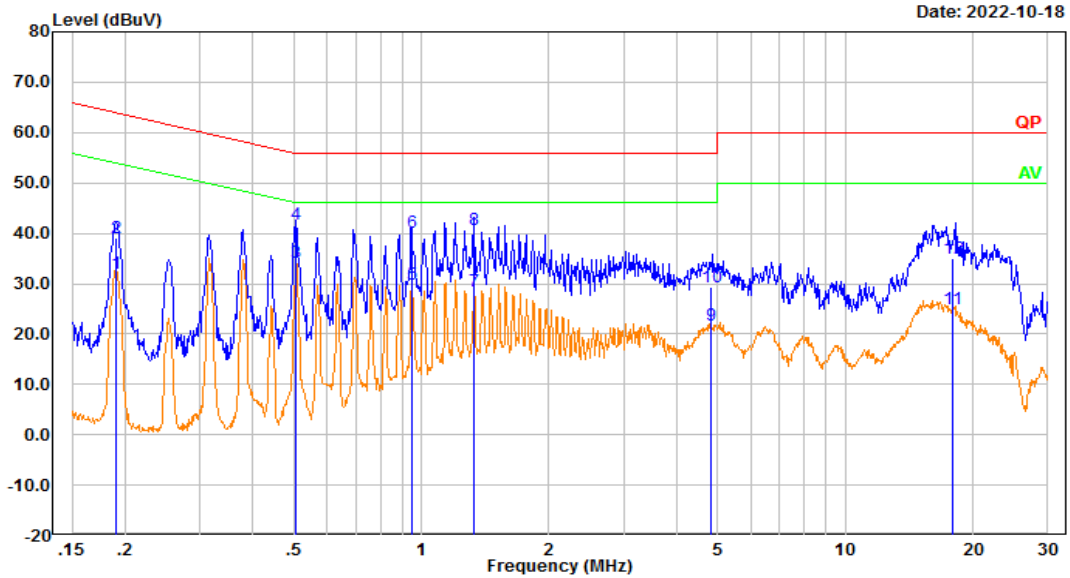

Date: 2022-10-18

No.	Frequency (MHz)	Reading (dBμV)	Factor (dB)	Result (dBμV)	Limit (dBμV)	Margin (dB)	Detector
1	0.191	22.54	9.61	32.15	53.99	21.84	Average
2	0.191	29.37	9.61	38.98	63.99	25.01	QP
3	0.505	24.49	9.61	34.10	46.00	11.90	Average
4	0.505	32.15	9.61	41.76	56.00	14.24	QP
5	0.947	20.15	9.62	29.77	46.00	16.23	Average
6	0.947	30.57	9.62	40.19	56.00	15.81	QP
7	1.326	18.86	9.62	28.48	46.00	17.52	Average
8	1.326	30.97	9.62	40.59	56.00	15.41	QP
9	4.810	11.95	9.66	21.61	46.00	24.39	Average
10	4.810	19.66	9.66	29.32	56.00	26.68	QP
11	17.862	15.28	9.75	25.03	50.00	24.97	Average
12	17.862	25.25	9.75	35.00	60.00	25.00	QP

Neutral:

Test Mode: Transmitting
 Port: neutral
 Note:

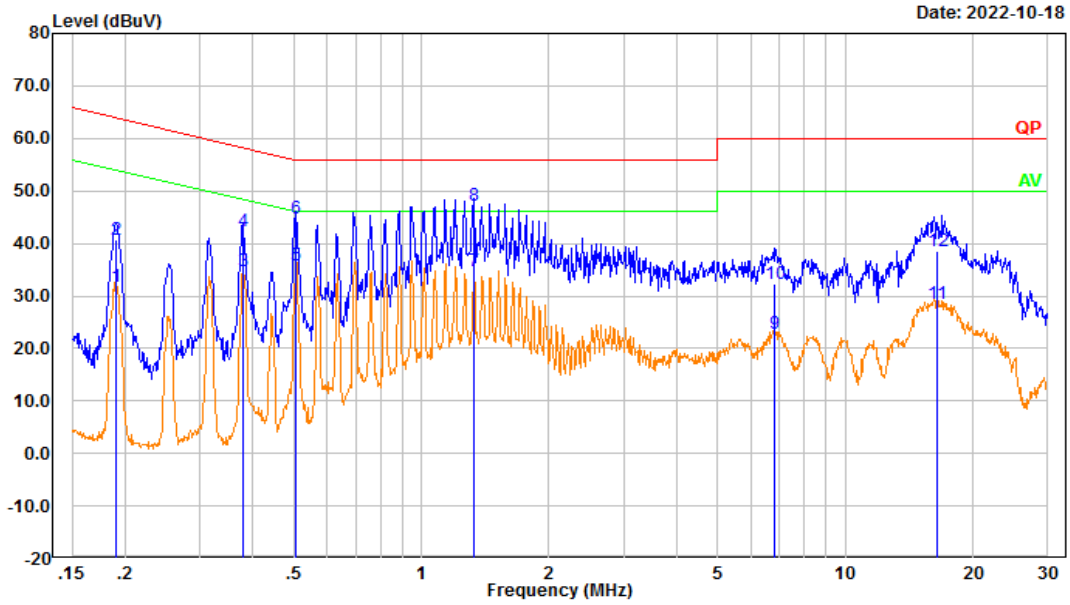

Date: 2022-10-18

No.	Frequency (MHz)	Reading (dBμV)	Factor (dB)	Result (dBμV)	Limit (dBμV)	Margin (dB)	Detector
1	0.191	22.18	9.61	31.79	54.00	22.21	Average
2	0.191	31.06	9.61	40.67	64.00	23.33	QP
3	0.379	25.24	9.61	34.85	48.29	13.44	Average
4	0.379	32.79	9.61	42.40	58.29	15.89	QP
5	0.505	26.15	9.61	35.76	46.00	10.24	Average
6	0.505	35.16	9.61	44.77	56.00	11.23	QP
7	1.326	25.25	9.62	34.87	46.00	11.13	Average
8	1.326	37.59	9.62	47.21	56.00	8.79	QP
9	6.810	13.11	9.66	22.77	50.00	27.23	Average
10	6.810	22.66	9.66	32.32	60.00	27.68	QP
11	16.420	18.73	9.69	28.42	50.00	21.58	Average
12	16.420	28.92	9.69	38.61	60.00	21.39	QP

4.2 Radiation Spurious Emissions

Serial Number:	CR221046105-RF-S1	Test Date:	2022/10/21~2022/11/02
Test Site:	966-1,966-2	Test Mode:	Transmitting
Tester:	coco Tian, Carl Xue	Test Result:	Pass

Environmental Conditions:

Temperature: (°C)	25.1~26.5	Relative Humidity: (%)	51~52	ATM Pressure: (kPa)	100.1~101.2
----------------------	-----------	------------------------------	-------	------------------------	-------------

Test Equipment List and Details:

Manufacturer	Description	Model	Serial Number	Calibration Date	Calibration Due Date
Sunol Sciences	Antenna	JB6	A082520-5	2020/10/19	2023/10/18
R&S	EMI Test Receiver	ESR3	102724	2022/07/15	2023/07/14
TIMES MICROWAVE	Coaxial Cable	LMR-600-UltraFlex	C-0470-02	2022/07/17	2023/07/16
TIMES MICROWAVE	Coaxial Cable	LMR-600-UltraFlex	C-0780-01	2022/07/17	2023/07/16
Sonoma	Amplifier	310N	186165	2022/07/17	2023/07/16
Audix	Test Software	E3	201021 (V9)	N/A	N/A
ETS-Lindgren	Horn Antenna	3115	9912-5985	2020/10/13	2023/10/12
R&S	Spectrum Analyzer	FSV40	101591	2022/07/15	2023/07/14
MICRO-COAX	Coaxial Cable	UFA210A-1-1200-70U300	217423-008	2022/08/07	2023/08/06
MICRO-COAX	Coaxial Cable	UFA210A-1-2362-300300	235780-001	2022/08/07	2023/08/06
PASTERNAK	Horn Antenna	PE9852/2F-20	112002	2021/02/05	2024/02/04
AH	Preamplifier	PAM-1840VH	190	2021/11/19	2022/11/18
MICRO-COAX	Coaxial Cable	UFB142A-1-2362-200200	235772-001	2022/08/07	2023/08/06
E-Microwave	Band Rejection Filter	2400-2483.5MHz	OE01902424	2022/08/07	2023/08/06
Mini Circuits	High Pass Filter	VHF-6010+	31119	2022/08/07	2023/08/06

* Statement of Traceability: China Certification ICT Co., Ltd (Dongguan) attests that all calibrations have been performed, traceable to National Primary Standards and International System of Units (SI).

Test Data:

Please refer to the below table and plots.

Note: The device can be mounted in multiple orientations, test was performed with X,Y, Z Axis according to C63.10 figure 8, the worst orientation was photographed and it's data was recorded.

1) 30MHz-1GHz(802.11b Low channel was the worst)

Horizontal:

Test Mode: Transmitting
 Polarization: horizontal
 Note:

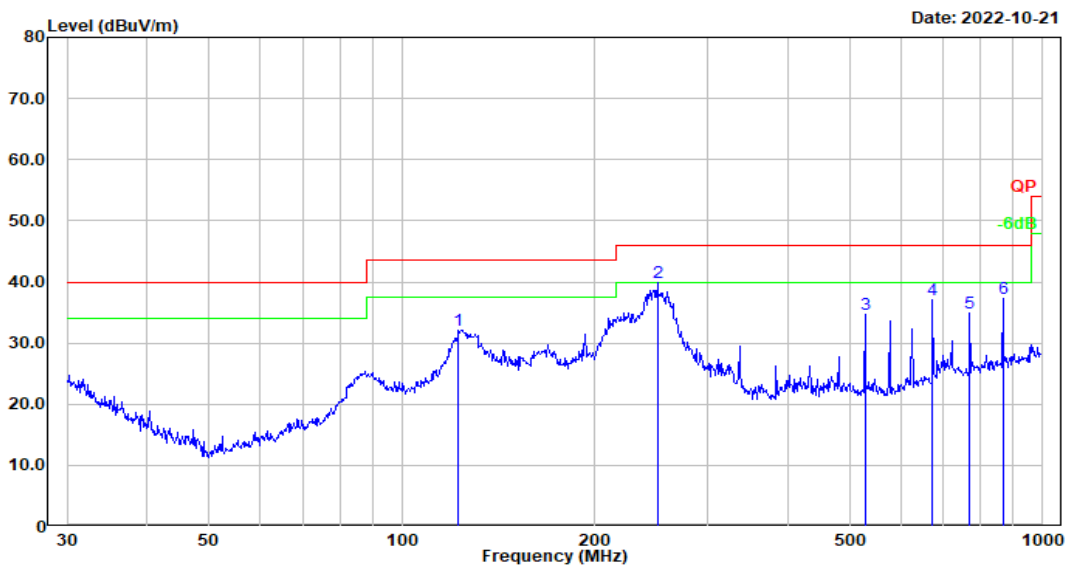

No.	Frequency (MHz)	Reading (dBμV)	Factor (dB/m)	Result (dBμV/m)	Limit (dBμV/m)	Margin (dB)	Detector
1	122.404	43.57	-11.41	32.16	43.50	11.34	Peak
2	250.301	53.06	-13.08	39.98	46.00	6.02	Peak
3	528.246	40.63	-5.93	34.70	46.00	11.30	Peak
4	672.845	41.01	-4.00	37.01	46.00	8.99	Peak
5	768.748	37.45	-2.61	34.84	46.00	11.16	Peak
6	866.088	38.47	-1.19	37.28	46.00	8.72	Peak

Vertical:

Test Mode: Transmitting
 Polarization: vertical
 Note:

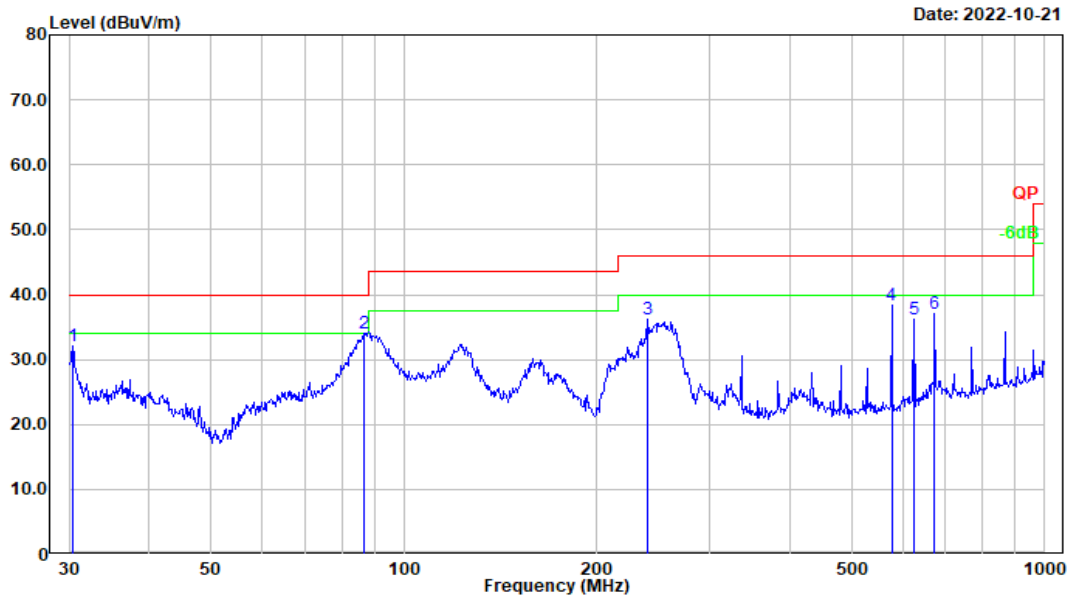

No.	Frequency (MHz)	Reading (dBμV)	Factor (dB/m)	Result (dBμV/m)	Limit (dBμV/m)	Margin (dB)	Detector
1	30.424	35.95	-3.93	32.02	40.00	7.98	Peak
2	86.503	51.08	-17.11	33.97	40.00	6.03	Peak
3	239.987	49.23	-13.02	36.21	46.00	9.79	Peak
4	576.644	43.99	-5.58	38.41	46.00	7.59	Peak
5	625.078	40.79	-4.60	36.19	46.00	9.81	Peak
6	672.845	41.10	-4.00	37.10	46.00	8.90	Peak

2) 1-25GHz:
802.11b Mode:

Frequency (MHz)	Receiver		Polar (H/V)	Factor (dB/m)	Result (dB μ V/m)	Limit (dB μ V/m)	Margin (dB)
	Reading (dB μ V)	Detector					
Low Channel: 2412 MHz							
2412.000	73.65	PK	H	31.53	105.18	N/A	N/A
2412.000	70.15	AV	H	31.53	101.68	N/A	N/A
2412.000	74.13	PK	V	31.53	105.66	N/A	N/A
2412.000	71.05	AV	V	31.53	102.58	N/A	N/A
2390.000	26.59	PK	V	31.46	58.05	74.00	15.95
2390.000	14.05	AV	V	31.46	45.51	54.00	8.49
4824.000	35.68	PK	V	10.94	46.62	74.00	27.38
4824.000	22.86	AV	V	10.94	33.80	54.00	20.20
7236.000	37.35	PK	V	14.44	51.79	74.00	22.21
7236.000	24.76	AV	V	14.44	39.20	54.00	14.80
Middle Channel: 2437 MHz							
2437.000	72.80	PK	H	31.60	104.40	N/A	N/A
2437.000	69.68	AV	H	31.60	101.28	N/A	N/A
2437.000	74.25	PK	V	31.60	105.85	N/A	N/A
2437.000	71.14	AV	V	31.60	102.74	N/A	N/A
4874.000	35.16	PK	V	11.05	46.21	74.00	27.79
4874.000	22.11	AV	V	11.05	33.16	54.00	20.84
7311.000	35.86	PK	V	14.80	50.66	74.00	23.34
7311.000	22.79	AV	V	14.80	37.59	54.00	16.41
High Channel: 2462MHz							
2462.000	73.04	PK	H	31.63	104.67	N/A	N/A
2462.000	69.91	AV	H	31.63	101.54	N/A	N/A
2462.000	73.64	PK	V	31.63	105.27	N/A	N/A
2462.000	70.47	AV	V	31.63	102.10	N/A	N/A
2483.500	29.22	PK	V	31.64	60.86	74.00	13.14
2483.500	15.18	AV	V	31.64	46.82	54.00	7.18
4924.000	35.16	PK	V	11.18	46.34	74.00	27.66
4924.000	22.23	AV	V	11.18	33.41	54.00	20.59
7386.000	35.42	PK	V	14.89	50.31	74.00	23.69
7386.000	22.61	AV	V	14.89	37.50	54.00	16.50

802.11g Mode:

Frequency (MHz)	Receiver		Polar (H/V)	Factor (dB/m)	Result (dB μ V/m)	Limit (dB μ V/m)	Margin (dB)
	Reading (dB μ V)	Detector					
Low Channel: 2412 MHz							
2412.000	62.53	PK	H	31.53	94.06	N/A	N/A
2412.000	52.24	AV	H	31.53	83.77	N/A	N/A
2412.000	63.75	PK	V	31.53	95.28	N/A	N/A
2412.000	53.44	AV	V	31.53	84.97	N/A	N/A
2390.000	27.21	PK	V	31.46	58.67	74.00	15.33
2390.000	13.97	AV	V	31.46	45.43	54.00	8.57
4824.000	33.56	PK	V	10.94	44.50	74.00	29.50
4824.000	20.86	AV	V	10.94	31.80	54.00	22.20
7236.000	33.27	PK	V	14.44	47.71	74.00	26.29
7236.000	20.49	AV	V	14.44	34.93	54.00	19.07
Middle Channel: 2437 MHz							
2437.000	63.87	PK	H	31.60	95.47	N/A	N/A
2437.000	53.69	AV	H	31.60	85.29	N/A	N/A
2437.000	64.56	PK	V	31.60	96.16	N/A	N/A
2437.000	54.43	AV	V	31.60	86.03	N/A	N/A
4874.000	34.26	PK	V	11.05	45.31	74.00	28.69
4874.000	21.45	AV	V	11.05	32.50	54.00	21.50
7311.000	33.57	PK	V	14.80	48.37	74.00	25.63
7311.000	20.78	AV	V	14.80	35.58	54.00	18.42
High Channel: 2462MHz							
2462.000	64.11	PK	H	31.63	95.74	N/A	N/A
2462.000	54.08	AV	H	31.63	85.71	N/A	N/A
2462.000	64.98	PK	V	31.63	96.61	N/A	N/A
2462.000	54.89	AV	V	31.63	86.52	N/A	N/A
2483.500	27.43	PK	V	31.64	59.07	74.00	14.93
2483.500	14.45	AV	V	31.64	46.09	54.00	7.91
4924.000	33.21	PK	V	11.18	44.39	74.00	29.61
4924.000	20.74	AV	V	11.18	31.92	54.00	22.08
7386.000	32.24	PK	V	14.89	47.13	74.00	26.87
7386.000	19.87	AV	V	14.89	34.76	54.00	19.24

802.11n ht20 Mode:

Frequency (MHz)	Receiver		Polar (H/V)	Factor (dB/m)	Result (dB μ V/m)	Limit (dB μ V/m)	Margin (dB)
	Reading (dB μ V)	Detector					
Low Channel: 2412 MHz							
2412.000	61.74	PK	H	31.53	93.27	N/A	N/A
2412.000	51.43	AV	H	31.53	82.96	N/A	N/A
2412.000	62.34	PK	V	31.53	93.87	N/A	N/A
2412.000	52.21	AV	V	31.53	83.74	N/A	N/A
2390.000	27.26	PK	V	31.46	58.72	74.00	15.28
2390.000	13.92	AV	V	31.46	45.38	54.00	8.62
4824.000	36.24	PK	V	10.94	47.18	74.00	26.82
4824.000	23.78	AV	V	10.94	34.72	54.00	19.28
7236.000	35.24	PK	V	14.44	49.68	74.00	24.32
7236.000	22.75	AV	V	14.44	37.19	54.00	16.81
Middle Channel: 2437 MHz							
2437.000	62.50	PK	H	31.60	94.10	N/A	N/A
2437.000	52.27	AV	H	31.60	83.87	N/A	N/A
2437.000	62.97	PK	V	31.60	94.57	N/A	N/A
2437.000	52.65	AV	V	31.60	84.25	N/A	N/A
4874.000	34.25	PK	V	11.05	45.30	74.00	28.70
4874.000	21.64	AV	V	11.05	32.69	54.00	21.31
7311.000	33.78	PK	V	14.80	48.58	74.00	25.42
7311.000	20.94	AV	V	14.80	35.74	54.00	18.26
High Channel: 2462MHz							
2462.000	62.87	PK	H	31.63	94.50	N/A	N/A
2462.000	52.64	AV	H	31.63	84.27	N/A	N/A
2462.000	63.34	PK	V	31.63	94.97	N/A	N/A
2462.000	53.02	AV	V	31.63	84.65	N/A	N/A
2483.500	27.37	PK	V	31.64	59.01	74.00	14.99
2483.500	14.46	AV	V	31.64	46.10	54.00	7.90
4924.000	32.73	PK	V	11.18	43.91	74.00	30.09
4924.000	20.01	AV	V	11.18	31.19	54.00	22.81
7386.000	33.46	PK	V	14.89	48.35	74.00	25.65
7386.000	20.77	AV	V	14.89	35.66	54.00	18.34

Worst Test plots(802.11b low channel was the worst)

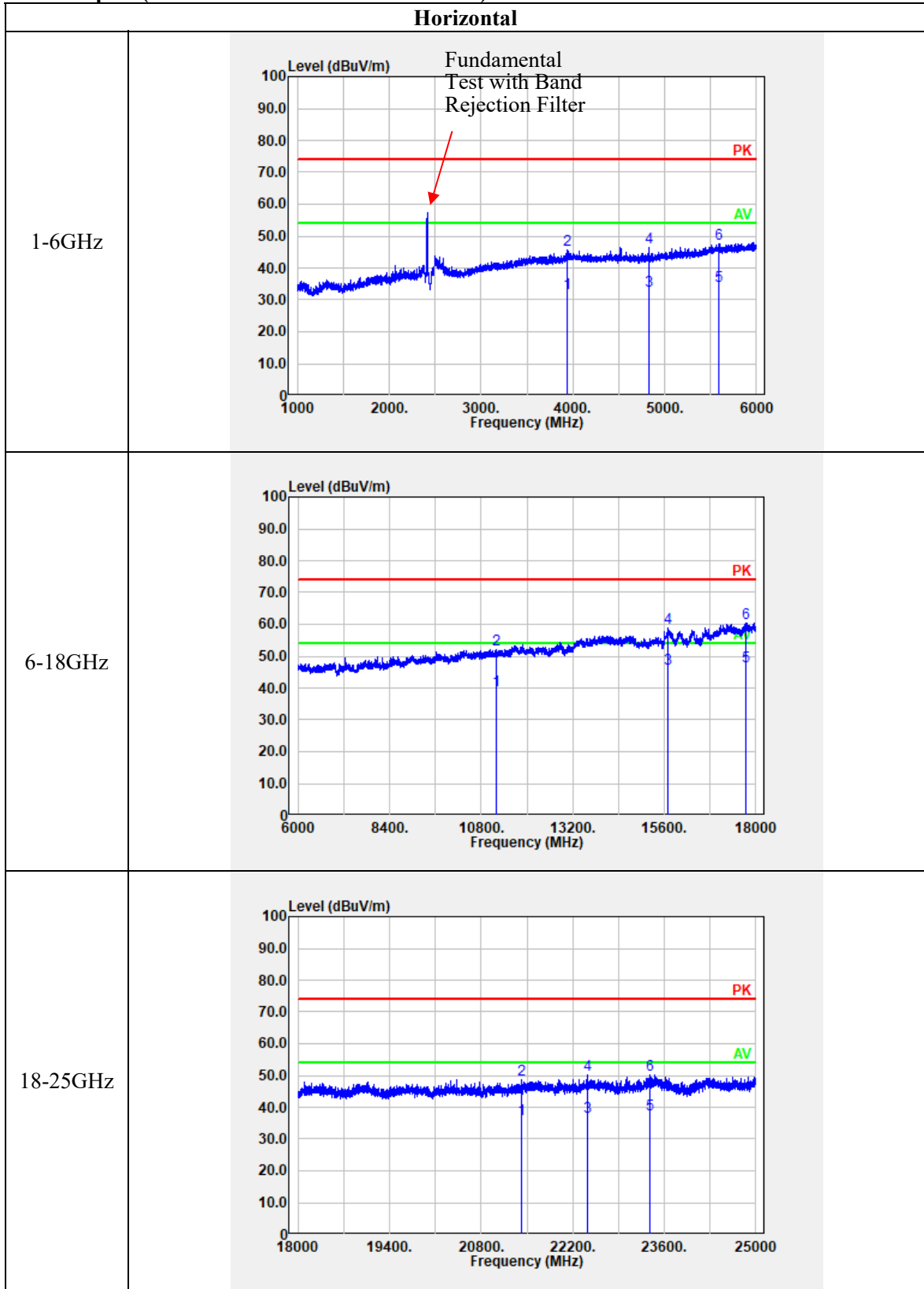

Vertical

<p>1-6GHz</p>	
<p>6-18GHz</p>	
<p>18-25GHz</p>	

4.3 6 dB Emission Bandwidth:

Serial Number:	CR221046105-RF-S1	Test Date:	2022/10/22
Test Site:	RF	Test Mode:	Transmitting
Tester:	Julie Tan	Test Result:	Pass

Environmental Conditions:

Temperature: (°C)	25.2	Relative Humidity: (%)	47	ATM Pressure: (kPa)	101.7
----------------------	------	---------------------------	----	------------------------	-------

Test Equipment List and Details:

Manufacturer	Description	Model	Serial Number	Calibration Date	Calibration Due Date
R&S	Spectrum Analyzer	FSU26	200256	2022/07/15	2023/07/14
zhuoxiang	Coaxial Cable	SMA-178	211003	Each time	N/A

* Statement of Traceability: China Certification ICT Co., Ltd (Dongguan) attests that all calibrations have been performed, traceable to National Primary Standards and International System of Units (SI).

Test Data:

Test Modes	Test Frequency (MHz)	6 dB Bandwidth (MHz)	Limit (MHz)
802.11b	2412	9.04	0.5
	2437	8.56	0.5
	2462	8.56	0.5
802.11g	2412	16.32	0.5
	2437	16.32	0.5
	2462	16.48	0.5
802.11n ht20	2412	17.52	0.5
	2437	17.44	0.5
	2462	17.6	0.5

6dB Emission Bandwidth	
<p>802.11b Lowest Channel</p>	<p>Ref 20 dBm *Att 25 dB *RBW 100 kHz Delta 1 [T1] 0.23 dB *VSW 300 kHz SWT 15 ms 9.040000000 MHz</p> <p>Offset 0.4 dB Marker 1 [T1] 4.26 dBm 2.407440000 GHz</p> <p>D1 6.15 dBm D2 0.15 dBm</p> <p>Center 2.412 GHz 4 MHz/ Span 40 MHz</p> <p>Date: 22.OCT.2022 14:49:04</p>
<p>802.11b Middle Channel</p>	<p>Ref 20 dBm *Att 25 dB *RBW 100 kHz Delta 1 [T1] -0.23 dB *VSW 300 kHz SWT 15 ms 8.560000000 MHz</p> <p>Offset 0.4 dB Marker 1 [T1] 4.11 dBm 2.432920000 GHz</p> <p>D1 6.19 dBm D2 0.19 dBm</p> <p>Center 2.437 GHz 4 MHz/ Span 40 MHz</p> <p>Date: 22.OCT.2022 14:56:26</p>
<p>802.11b Highest Channel</p>	<p>Ref 20 dBm *Att 25 dB *RBW 100 kHz Delta 1 [T1] 0.34 dB *VSW 300 kHz SWT 15 ms 8.560000000 MHz</p> <p>Offset 0.4 dB Marker 1 [T1] 4.18 dBm 2.457440000 GHz</p> <p>D1 6.07 dBm D2 0.07 dBm</p> <p>Center 2.462 GHz 4 MHz/ Span 40 MHz</p> <p>Date: 22.OCT.2022 14:52:15</p>

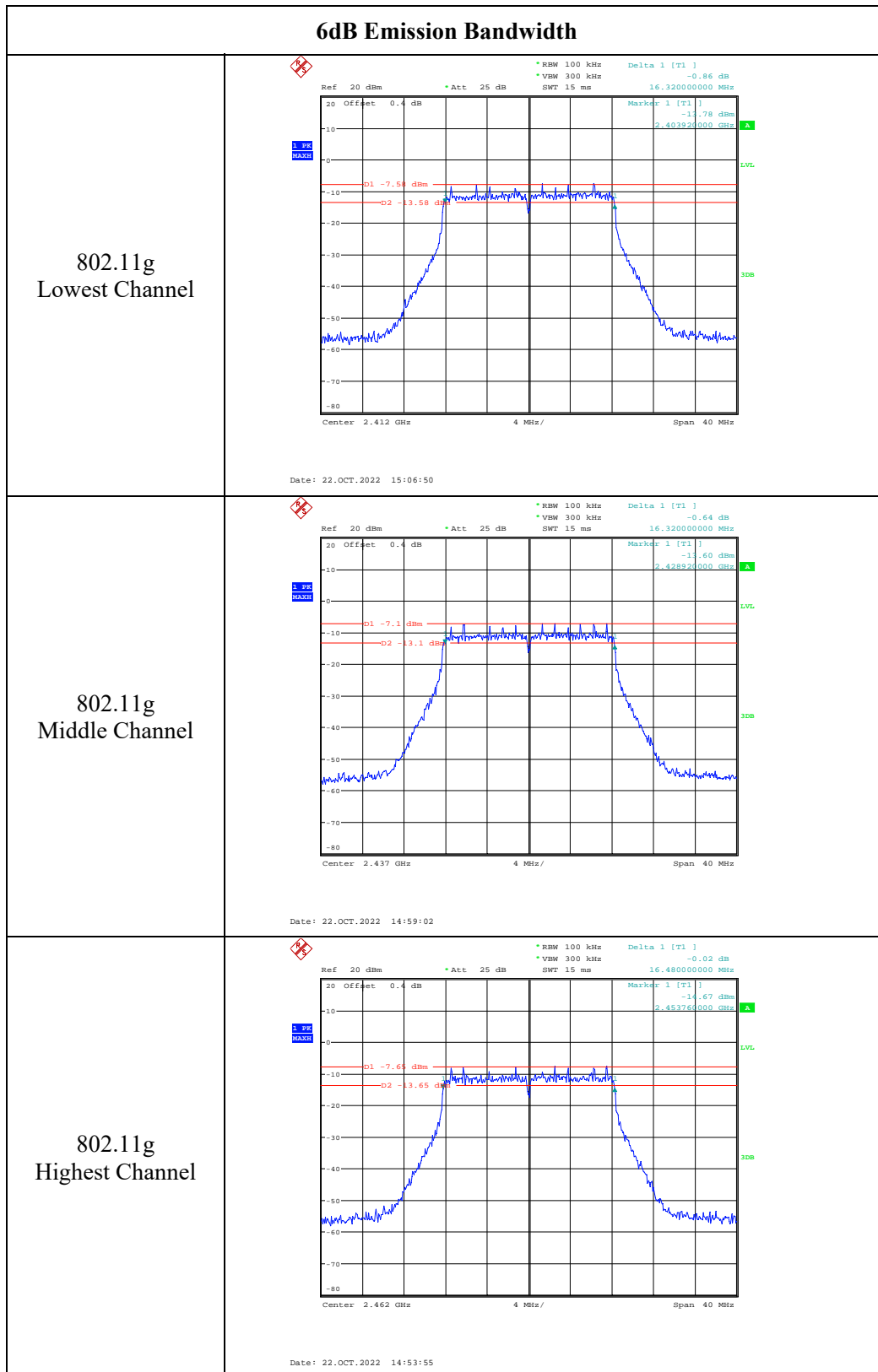

6dB Emission Bandwidth

<p>802.11n ht20 Lowest Channel</p>	<p>Date: 22.OCT.2022 15:16:19</p>
<p>802.11n ht20 Middle Channel</p>	<p>Date: 22.OCT.2022 15:11:11</p>
<p>802.11n ht20 Highest Channel</p>	<p>Date: 22.OCT.2022 15:09:04</p>

4.4 Maximum peak conducted output power:

Serial Number:	CR221046105-RF-S1	Test Date:	2022/10/22
Test Site:	RF	Test Mode:	Transmitting
Tester:	Julie Tan	Test Result:	Pass

Environmental Conditions:

Temperature: (°C)	25.2	Relative Humidity: (%)	47	ATM Pressure: (kPa)	101.7
----------------------	------	---------------------------	----	------------------------	-------

Test Equipment List and Details:

Manufacturer	Description	Model	Serial Number	Calibration Date	Calibration Due Date
Agilent	USB Wideband Power Sensor	U2021XA	MY54080015	2022/07/15	2023/07/14
eastsheep	Coaxial Attenuator	2W-SMA-JK-18G	21060301	Each time	N/A
zhuoxiang	Coaxial Cable	SMA-178	211003	Each time	N/A

* Statement of Traceability: China Certification ICT Co., Ltd (Dongguan) attests that all calibrations have been performed, traceable to National Primary Standards and International System of Units (SI).

Test Data:

Test Modes	Test Frequency (MHz)	Maximum Conducted Peak Output Power (dBm)	Limit (dBm)
802.11b	2412	18.16	30
	2437	17.93	30
	2462	17.98	30
802.11g	2412	15.14	30
	2437	15.21	30
	2462	15.1	30
802.11n ht20	2412	14.04	30
	2437	13.81	30
	2462	14.25	30

4.5 Maximum power spectral density:

Serial Number:	CR221046105-RF-S1	Test Date:	2022/10/22
Test Site:	RF	Test Mode:	Transmitting
Tester:	Julie Tan	Test Result:	Pass

Environmental Conditions:

Temperature: (°C)	25.2	Relative Humidity: (%)	47	ATM Pressure: (kPa)	101.7
----------------------	------	------------------------------	----	------------------------	-------

Test Equipment List and Details:

Manufacturer	Description	Model	Serial Number	Calibration Date	Calibration Due Date
R&S	Spectrum Analyzer	FSU26	200256	2022/07/15	2023/07/14
zhuoxiang	Coaxial Cable	SMA-178	211003	Each time	N/A

* Statement of Traceability: China Certification ICT Co., Ltd (Dongguan) attests that all calibrations have been performed, traceable to National Primary Standards and International System of Units (SI).

Test Data:

Test Modes	Test Frequency (MHz)	Power Spectral Density (dBm/3kHz)	Limit (dBm/3kHz)
802.11b	2412	-7.49	8.00
	2437	-7.12	8.00
	2462	-8.09	8.00
802.11g	2412	-19.32	8.00
	2437	-21.31	8.00
	2462	-20.34	8.00
802.11n ht20	2412	-22.2	8.00
	2437	-21.2	8.00
	2462	-20.81	8.00

Maximum power spectral density

<p>802.11b Lowest Channel</p>	<p>Ref: 20 dBm *Att: 25 dB *RBW: 3 kHz Marker 1 [T1] -7.49 dBm *VBW: 10 kHz 2.410182960 GHz SWT: 1.55 s</p> <p>Center: 2.412 GHz 1.356 MHz/ Span: 13.56 MHz</p> <p>Date: 22.OCT.2022 14:49:45</p>
<p>802.11b Middle Channel</p>	<p>Ref: 20 dBm *Att: 25 dB *RBW: 3 kHz Marker 1 [T1] -7.12 dBm *VBW: 10 kHz 2.437898800 GHz SWT: 1.45 s</p> <p>Center: 2.437 GHz 1.284 MHz/ Span: 12.84 MHz</p> <p>Date: 22.OCT.2022 14:57:53</p>
<p>802.11b Highest Channel</p>	<p>Ref: 20 dBm *Att: 25 dB *RBW: 3 kHz Marker 1 [T1] -8.09 dBm *VBW: 10 kHz 2.462667680 GHz SWT: 1.45 s</p> <p>Center: 2.462 GHz 1.284 MHz/ Span: 12.84 MHz</p> <p>Date: 22.OCT.2022 14:52:49</p>

Maximum power spectral density

<p>802.11g Lowest Channel</p>	<p>Ref 20 dBm * Att 25 dB * RBW 3 kHz * VBW 10 kHz * SWT 2.8 s Marker 1 [T1] -19.52 dBm 2.416993920 GHz</p> <p>20 Offset 0.4 dB</p> <p>Center 2.412 GHz 2.448 MHz/ Span 24.48 MHz</p> <p>Date: 22.OCT.2022 15:07:41</p>
<p>802.11g Middle Channel</p>	<p>Ref 20 dBm * Att 25 dB * RBW 3 kHz * VBW 10 kHz * SWT 2.8 s Marker 1 [T1] -21.31 dBm 2.436363520 GHz</p> <p>20 Offset 0.4 dB</p> <p>Center 2.437 GHz 2.448 MHz/ Span 24.48 MHz</p> <p>Date: 22.OCT.2022 14:59:50</p>
<p>802.11g Highest Channel</p>	<p>Ref 20 dBm * Att 25 dB * RBW 3 kHz * VBW 10 kHz * SWT 2.8 s Marker 1 [T1] -20.34 dBm 2.462593280 GHz</p> <p>20 Offset 0.4 dB</p> <p>Center 2.462 GHz 2.472 MHz/ Span 24.72 MHz</p> <p>Date: 22.OCT.2022 14:54:45</p>

Maximum power spectral density

<p>802.11n ht20 Lowest Channel</p>	<p>Ref: 20 dBm *Att: 25 dB *RBW: 3 kHz Marker 1 [T1] -22.20 dBm *VBW: 10 kHz 2.412988640 GHz SWF: 3 s</p> <p>Center: 2.412 GHz 2.628 MHz/ Span: 26.28 MHz</p> <p>Date: 22.OCT.2022 15:17:08</p>
<p>802.11n ht20 Middle Channel</p>	<p>Ref: 20 dBm *Att: 25 dB *RBW: 3 kHz Marker 1 [T1] -21.20 dBm *VBW: 10 kHz 2.440453120 GHz SWF: 3 s</p> <p>Center: 2.437 GHz 2.616 MHz/ Span: 26.16 MHz</p> <p>Date: 22.OCT.2022 15:12:00</p>
<p>802.11n ht20 Highest Channel</p>	<p>Ref: 20 dBm *Att: 25 dB *RBW: 3 kHz Marker 1 [T1] -20.81 dBm *VBW: 10 kHz 2.462000000 GHz SWF: 3 s</p> <p>Center: 2.462 GHz 2.64 MHz/ Span: 26.4 MHz</p> <p>Date: 22.OCT.2022 15:09:53</p>

4.6 100 kHz Bandwidth of Frequency Band Edge:

Serial Number:	CR221046105-RF-S1	Test Date:	2022/10/22
Test Site:	RF	Test Mode:	Transmitting
Tester:	Julie Tan	Test Result:	Pass

Environmental Conditions:

Temperature: (°C)	25.2	Relative Humidity: (%)	47	ATM Pressure: (kPa)	101.7
----------------------	------	------------------------------	----	------------------------	-------

Test Equipment List and Details:

Manufacturer	Description	Model	Serial Number	Calibration Date	Calibration Due Date
R&S	Spectrum Analyzer	FSU26	200256	2022/07/15	2023/07/14
zhuoxiang	Coaxial Cable	SMA-178	211003	Each time	N/A

* Statement of Traceability: China Certification ICT Co., Ltd (Dongguan) attests that all calibrations have been performed, traceable to National Primary Standards and International System of Units (SI).

100 kHz Bandwidth of Frequency Band Edge

802.11b
Lowest Band edge

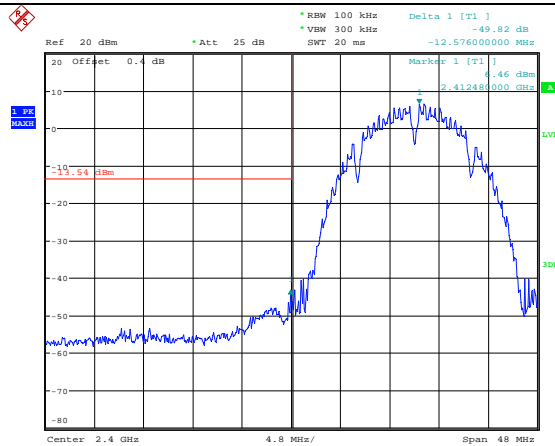

Date: 22.OCT.2022 14:50:01

802.11b
Highest Band edge

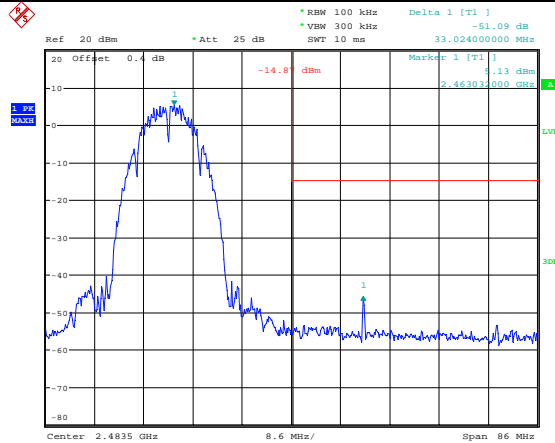

Date: 22.OCT.2022 14:53:02

100 kHz Bandwidth of Frequency Band Edge

802.11g
Lowest Band edge

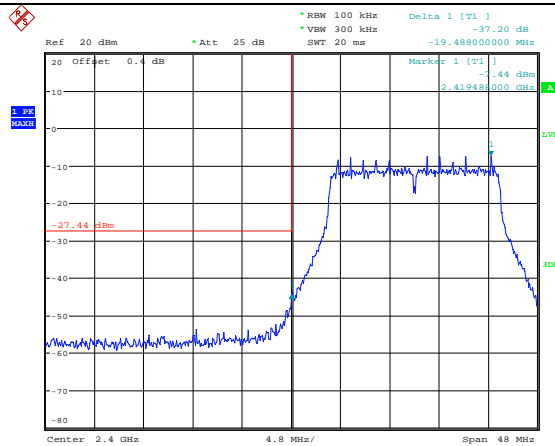

Date: 22.OCT.2022 15:07:54

802.11g
Highest Band edge

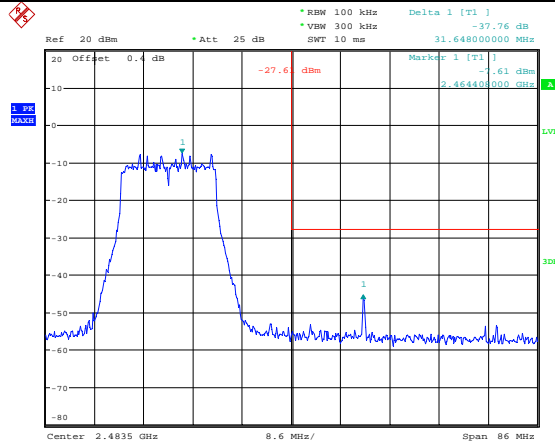

Date: 22.OCT.2022 14:54:58

100 kHz Bandwidth of Frequency Band Edge

802.11n ht20
Lowest Band edge

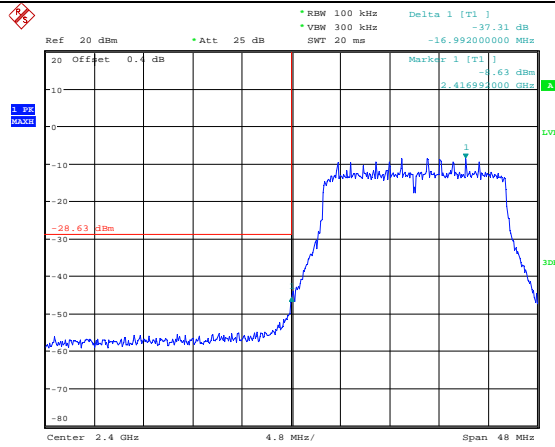

Date: 22.OCT.2022 15:17:21

802.11n ht20
Highest Band edge

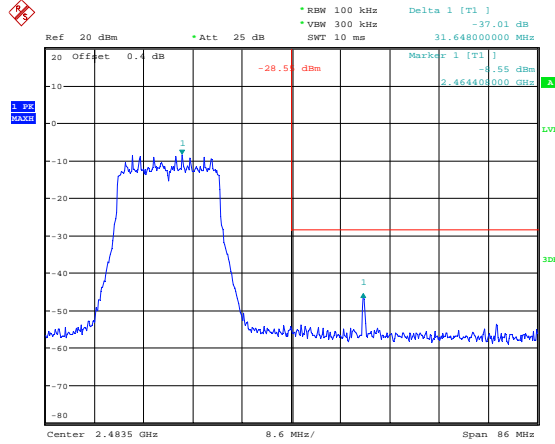

Date: 22.OCT.2022 15:10:07

4.7 Duty Cycle:

Serial Number:	CR221046105-RF-S1	Test Date:	2022/10/22
Test Site:	RF	Test Mode:	Transmitting
Tester:	Julie Tan	Test Result:	N/A

Environmental Conditions:

Temperature: (°C)	25.2	Relative Humidity: (%)	47	ATM Pressure: (kPa)	101.7
----------------------	------	------------------------------	----	------------------------	-------

Test Equipment List and Details:

Manufacturer	Description	Model	Serial Number	Calibration Date	Calibration Due Date
R&S	Spectrum Analyzer	FSU26	200256	2022/07/15	2023/07/14
zhuoxiang	Coaxial Cable	SMA-178	211003	Each time	N/A

* Statement of Traceability: China Certification ICT Co., Ltd (Dongguan) attests that all calibrations have been performed, traceable to National Primary Standards and International System of Units (SI).

Test Data:

Test Modes	Ton (ms)	Ton+off (ms)	Duty cycle (%)
802.11b	100	100	100.00
802.11g	2.113	2.233	94.63
802.11n ht20	1.946	1.99	97.79

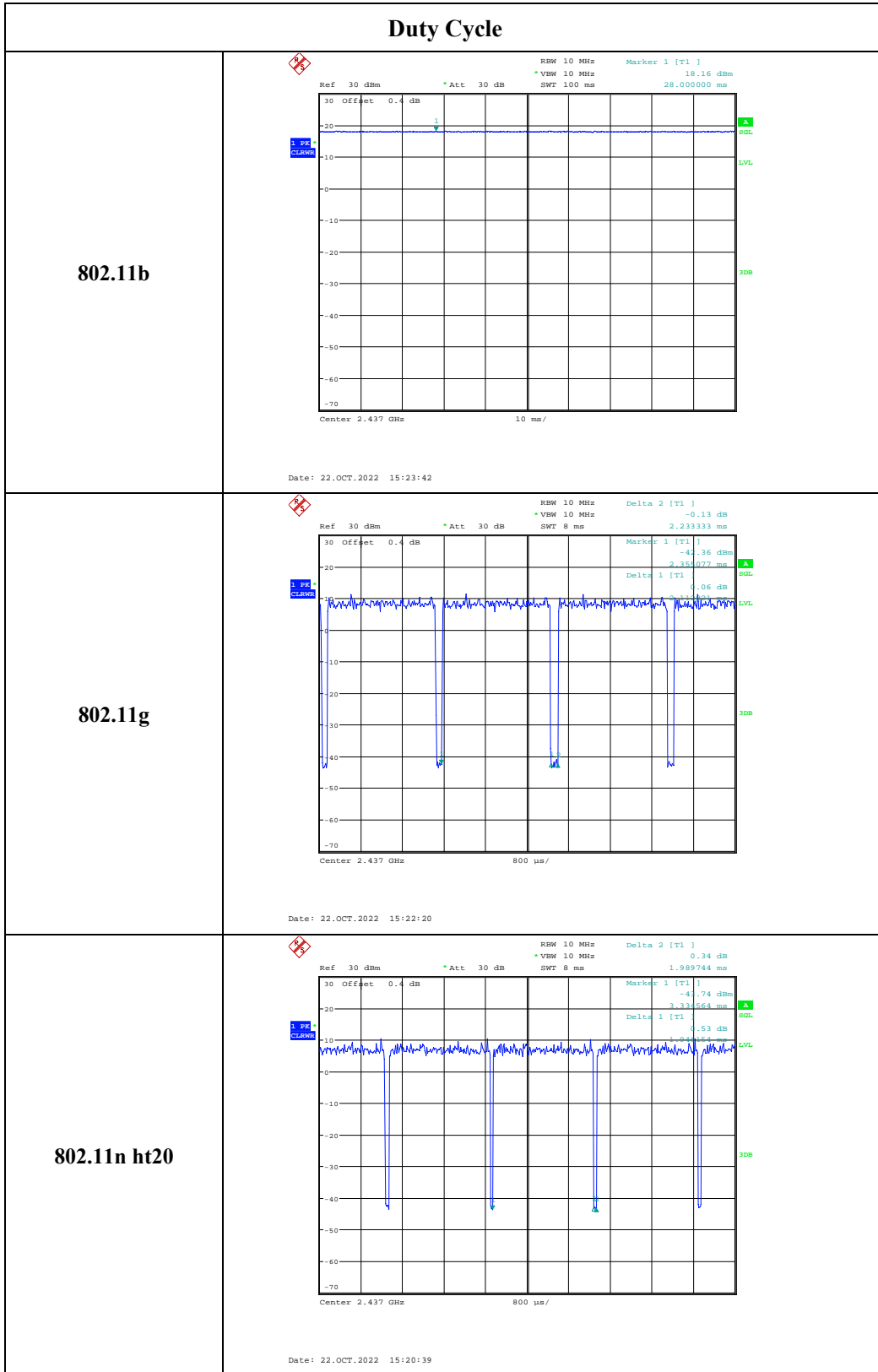

5. RF EXPOSURE EVALUATION

5.1 Applicable Standard

According to §1.1307(b)(3)(i)

(C) Or using Table 1 and the minimum separation distance (R in meters) from the body of a nearby person for the frequency (f in MHz) at which the source operates, the ERP (watts) is no more than the calculated value prescribed for that frequency. For the exemption in Table 1 to apply, R must be at least $\lambda/2\pi$, where λ is the free-space operating wavelength in meters. If the ERP of a single RF source is not easily obtained, then the available maximum time-averaged power may be used in lieu of ERP if the physical dimensions of the radiating structure(s) do not exceed the electrical length of $\lambda/4$ or if the antenna gain is less than that of a half-wave dipole (1.64 linear value).

Table 1 to § 1.1307(b)(3)(i)(C) - Single RF Sources Subject to Routine Environmental Evaluation

RF Source frequency (MHz)	Threshold ERP (watts)
0.3-1.34	$1,920 R^2$.
1.34-30	$3,450 R^2/f^2$.
30-300	$3.83 R^2$.
300-1,500	$0.0128 R^2 f$.
1,500-100,000	$19.2R^2$.

5.2 Measurement Result

Operation Modes	Frequency (MHz)	$\lambda/2\pi$ (mm)	Distance (mm)	Exemption ERP		Maximum Conducted Power including Tune-up Tolerance (dBm)	Antenna Gain (dBi)	ERP (dBm)	ERP (mW)	MPE-Based Exemption
				(mW)	(dBm)					
WLAN 2.4G	2412-2462	19.80	200	768	28.85	19	1.93	18.78	75.51	Compliant
Sensor	24125	9.22	200	768	28.85	/	/	9.45	8.81	Compliant
WCDMA Band II	1850-1910	25.82	200	768	28.85	25	2.61	25.46	351.56	Compliant
WCDMA Band IV	1710-1755	27.93	200	768	28.85	25	3.63	26.48	444.63	Compliant
WCDMA Band V	824-849	57.97	200	422	26.25	25	2.39	25.24	334.20	Compliant
LTE Band 2	1850-1910	25.82	200	768	28.85	25	2.61	25.46	351.56	Compliant
LTE Band 4	1710-1755	27.93	200	768	28.85	25	3.63	26.48	444.63	Compliant
LTE Band 5	824-849	57.97	200	422	26.25	25	2.39	25.24	334.20	Compliant
LTE Band 12	699-716	68.34	200	358	25.54	25	-0.21	22.64	183.65	Compliant
LTE Band 13	777-787	61.48	200	398	26.00	25	1.42	24.27	267.30	Compliant
LTE Band 25	1850-1915	25.82	200	768	28.85	25	2.61	25.46	351.56	Compliant
LTE Band 26	814-849	58.69	200	417	26.2	25	2.39	25.24	334.20	Compliant

The device contains two certified module, WWAN module FCC ID: XMR201909EG95NAX, Sensor module FCC ID: 2ASYV-K-LD2.

The maximum Field strength for Sensor module FCC ID: 2ASYV-K-LD2 is 106.8 dB μ V/m @3m (ERP=9.45dBm),

WLAN 2.4G and Sensor, WWAN can transmit simultaneously:

$$\sum_{i=1}^a \left(\frac{P_i}{P_{th_i}} \right) + \sum_{j=1}^b \left(\frac{ERP_j}{ERP_{th_j}} \right) + \sum_{k=1}^c \left(\frac{Evaluated_k}{Exposure Limit_k} \right)$$

$$= \frac{EPR_{WLAN}}{P_{limit-WLAN}} + \frac{EPR_{WWAN}}{P_{limit-WWAN}} + \frac{EPR_{Sensor}}{P_{limit-Sensor}}$$

$$= \frac{75.51}{768} + \frac{334.2}{417} + \frac{8.81}{768}$$

$$= 0.91$$

Result: The device compliant the Exemption at 20cm distances.

===== END OF REPORT =====