

Prüfbericht-Nr.: <i>Test report no.:</i>	SE24RYPW-001	Auftrags-Nr.: <i>Order no.:</i>	290100301	Seite 1 von 54 <i>Page 1 of 54</i>
Kunden-Referenz-Nr.: <i>Client reference no.:</i>	2311184	Auftragsdatum: <i>Order date:</i>	2023-02-13	
Auftraggeber: <i>Client:</i>	Wittra Networks AB			
Prüfgegenstand: <i>Test item:</i>	Wireless Asset Tag			
Bezeichnung / Typ-Nr.: <i>Identification / Type no.:</i>	CXAMELEON-1.0-US / FCC ID:2AYHX00464			
Auftrags-Inhalt: <i>Order content:</i>	Accredited testing according to FCC Part 15C			
Prüfgrundlage: <i>Test specification:</i>	FCC 47 CFR Part 15.247 with parts 15.207 & 15.209 ANSI C63.10: 2013			
Wareneingangsdatum: <i>Date of sample receipt:</i>	2020.12.09			
Prüfmuster-Nr.: <i>Test sample no.:</i>	See section 2.3			
Prüfzeitraum: <i>Testing period:</i>	2020.12.11 – 2021.02.04			
Ort der Prüfung: <i>Place of testing:</i>	Lund, Sweden			
Prüflaboratorium: <i>Testing laboratory:</i>	TÜV Rheinland Sweden			
Prüfergebnis*: <i>Test result*:</i>	Pass			
überprüft von: <i>reviewed by:</i>	<input checked="" type="checkbox"/> 	genehmigt von: <i>authorized by:</i>	<input checked="" type="checkbox"/> 	
Datum: 2024.03.21 <i>Date:</i>	Signed by: Fariborz Abasi	Datum: 2024.03.21 <i>Date:</i>	Signed by: Hakan Ahlberg	
Stellung / Position:	Senior Technical Expert	Stellung / Position:	Lab Manager	
Sonstiges / Other:	Note: This reports contains information for Bluetooth Low Energy measurements only			
Zustand des Prüfgegenstandes bei Anlieferung: <i>Condition of the test item at delivery:</i>	Prüfmuster vollständig und unbeschädigt <i>Test item complete and undamaged</i>			
* Legende:	1 = sehr gut P(ass) = entspricht o.g. Prüfgrundlage(n)	2 = gut F(ail) = entspricht nicht o.g. Prüfgrundlage(n)	3 = befriedigend N/A = nicht anwendbar	4 = ausreichend N/T = nicht getestet
* Legend:	1 = very good P(ass) = passed a.m. test specification(s)	2 = good F(ail) = failed a.m. test specification(s)	3 = satisfactory N/A = not applicable	4 = sufficient N/T = not tested
Dieser Prüfbericht bezieht sich nur auf das o.g. Prüfmuster und darf ohne Genehmigung der Prüfstelle nicht auszugsweise vervielfältigt werden. Dieser Bericht berechtigt nicht zur Verwendung eines Prüfzeichens. <i>This test report only relates to the a. m. test sample. Without permission of the test center this test report is not permitted to be duplicated in extracts.</i>				

Revision History SE24RYPW-001 SE24RYPW-001

REVISION	DATE	REMARKS	AUTHOR
001	2024.03.21	First release, based on report 60437588-004, updated with the new name/ID for filing	Fariborz Abasi

Note: Latest revision report will replace all previous reports

This report based on FCC Part 15.247 Template version 1.2

Summary of Test Results

FCC 47 CFR Rule Part	Test Description	Applicability	Report Section	RESULT	REMARKS
15.207	AC Power Line Conducted Emissions (Intentional Radiators)	YES	4.1	PASS	
15.209	Radiated Emissions (Intentional Radiators)	YES	4.2	PASS	
15.247 (d)	Antenna Conducted Emissions	NO	4.3	N/A	Radiated testing performed
15.247 (d)	Band Edge Compliance (Authorized Band)	YES	4.4	PASS	
15.247 (d)	Band Edge Compliance (Restricted Band)	YES	4.5	PASS	
15.247 (a)(1)	20dB Bandwidth	NO	4.6	N/A	BLE is non-hopping
15.247 (a)(1)	Carrier (Hopping Channel) Separation	NO	4.7	N/A	BLE is non-hopping
15.247 (a)(1)	Number of Hopping Channels	NO	4.8	N/A	BLE is non-hopping
15.247 (a)(1)	Time of Occupancy (Dwell Time)	NO	4.9	N/A	BLE is non-hopping
15.247 (a)(2)	6dB Bandwidth	YES	4.10	PASS	
15.247 (b)	Peak Conducted Output Power	YES	4.11	PASS	
15.247 (e)	Power Spectral Density	YES	4.12	PASS	

Possible test case verdicts:

- | | |
|--|-----------------------|
| - Test case does not apply to the test object: | N/A |
| - Test object complies with the requirement: | PASS or COMPLIANT |
| - Test object does not meet the requirement: | FAIL or NOT COMPLIANT |
| - Test case not performed on the test object: | N.P. |

Table of Contents

1. GENERAL INFORMATION	4
1.1 Test Site	4
1.2 Client Information	4
2. PRODUCT INFORMATION.....	5
2.1 General Description.....	5
2.2 Device Characteristics.....	5
2.3 Test Samples	5
2.4 Wireless Technologies and Bands Supported by the EUT.....	5
2.5 Antenna Information.....	6
2.6 Simultaneous Transmissions.....	6
2.7 Wireless Technology Details	6
2.8 Ancillary Equipment.....	6
2.9 EUT Diagrams.....	6
3. TEST METHODS	7
3.1 Test Standards.....	7
3.2 Additional references.....	7
3.3 Limits	8
3.4 Description of Test Methods and Equipment Setup	9
3.5 EUT Configuration During Test.....	14
3.6 EUT Operation Modes.....	14
3.7 Deviations from the Test Standard	14
3.8 Environmental Conditions.....	15
4. TEST RESULTS	16
4.1 Test Results – AC Power Line Conducted Emissions (Intentional Transmitter).....	16
4.2 Test Results – Radiated Emissions (Intentional Transmitter).....	19
4.3 Test Results – Antenna Conducted Emissions	38
4.4 Test Results – Band Edge Compliance (Authorized Band).....	38
4.5 Test Results – Band Edge Compliance (Restricted Band).....	40
4.6 Test Results – 20dB Bandwidth.....	43
4.7 Test Results – Carrier (Hopping Channel) Separation	43
4.8 Test Results – Number of Hopping Channels	43
4.9 Test Results – Time of Occupancy (Dwell Time)	43
4.10 Test Results – 6dB Bandwidth.....	44
4.11 Test Results – Peak Conducted Output Power.....	46
4.12 Test Results – Power Spectral Density.....	50
5. TEST EQUIPMENT STATUS.....	52
5.1 List of Hardware with Calibration Dates.....	52
5.2 Software / Firmware Versions.....	53
6. MEASUREMENT UNCERTAINTY	54
6.1 Measurement Uncertainty for CTE	54
6.2 Measurement Uncertainty for Conducted Emissions	54
6.3 Measurement Uncertainty for SAC 5 (Radiated Emissions & Band Edge)	54
7. PHOTOGRAPHS.....	54

1. GENERAL INFORMATION

1.1 Test Site

Test Facility:	TÜV Rheinland Sweden AB
Address:	Mobilvägen 10
	223 62 Lund
	Sweden
Swedac Registration Number:	10325
FCC Test Firm Registration Number:	517458
ISED Test Site Registration Number:	24753

1.2 Client Information

Company Name:	Wittra Networks AB
Address:	Västra Järnvägsgatan 3
	111 64 Stockholm
	Sweden
Contact Person:	Warwick Taws
Contact e-Mail / Telephone	wat@wittra.se

2. PRODUCT INFORMATION

2.1 General Description

Model name:	CXAMELEON-1.0-US
Manufacturer:	TT Electronics PLC
Model number / Marketing name:	CXAMELEON-1.0-US
FCC ID:	2AYHX00464
Description:	Wireless Asset Tag
Ancillary Equipment:	See section 2.8

2.2 Device Characteristics

Type of Power Supply	Battery
Nominal Supply Voltage	3.7 VDC
Supply Voltage Range	2.4 VDC – 5.5 VDC
Operating Temperature Range	-30°C – 85°C
Operating Air Humidity Range	0% – 100% RH
Highest Internal Frequency Source	2483.5 MHz

2.3 Test Samples

EUT #	EUT ID	Description	Used For:
1	A002965790-001	Standard Sample	Conducted Emissions Radiated Emissions
2	A002965790-010	Modified with RF connector and DC cables	Conducted RF

2.4 Wireless Technologies and Bands Supported by the EUT

Technology	Band	Frequency Range (Tx)	Evaluation Performed*
IEEE 802.15.4g	902-928 MHz	902.0 MHz - 928.0 MHz	NO
Bluetooth LE	2.4 GHz	2400.0 MHz - 2483.5 MHz	YES

*This statement refers only to this report. Other wireless technologies may be covered by other reports.

2.5 Antenna Information

Technology	Band	Number of Antennas	Antenna Type(s)	Gain
IEEE 802.15.4g	902-928 MHz	1	Printed foil 50Ω	-4.71
Bluetooth LE	2.4 GHz	1	Printed foil 50Ω	1.40

2.6 Simultaneous Transmissions

The device supports NO simultaneous transmission configurations. The Bluetooth Low Energy and IEEE 802.15.4 “Sub-GHz” transmitters cannot be transmit at the same time

2.7 Wireless Technology Details

Technology	Band	Modulation Type(s)	No. of Channels	Channel Spacing	Adaptivity
IEEE 802.15.4g	902-928 MHz	2-GFSK	129	0.2 MHz	N/A
Bluetooth LE	2.4 GHz	GFSK	40	2 MHz	N/A

2.8 Ancillary Equipment

ID	Description	Manufacturer / Model	Hardware & Software Versions
A002965790-009	Launchpad	Texas Instruments CC1310 + Wittra Debugger Board	Rev 1.4 / V2.0
A002972080-007	USB Charger	Power Pax P2620	-

2.9 EUT Diagrams

-

3. TEST METHODS

3.1 Test Standards

Testing was performed according to the following standards / references

Standard	Version	Description
FCC 47 CFR 15.247	-	Operation within the bands 902-928 MHz, 2400-2483.5 MHz, and 5725-5850 MHz.
FCC 47 CFR 15.207	-	Conducted limits
FCC 47 CFR 15.209	-	Radiated emission limits; general requirements

3.2 Additional references

The following standards / references were also considered for the testing

Standard	Version	Description
ANSI C63.10	2013	American National Standard of Procedures for Compliance Testing of Unlicensed Wireless Devices

3.3 Limits

FCC 47 CFR Rule Part	Test Description	Limit Reference (FCC 47 CFR Reference)
15.207	AC Power Line Conducted Emissions (Intentional Radiators)	15.207 (a)
15.209	Radiated Emissions (Intentional Radiators)	15.209 (a) *See Note 1
15.247 (d)	Antenna Conducted Emissions	15.247 (d)
15.247 (d)	Band Edge Compliance (Authorized Band)	15.247 (d)
15.247 (d)	Band Edge Compliance (Restricted Band)	15.247 (d)
15.247 (a)(1)	20dB Bandwidth	15.247 (a)(1)
15.247 (a)(1)	Carrier (Hopping Channel) Separation	15.247 (a)(1)
15.247 (a)(1)	Number of Hopping Channels	15.247 (a)(1)
15.247 (a)(1)	Time of Occupancy (Dwell Time)	15.247 (a)(1)
15.247 (a)(2)	6dB Bandwidth	15.247 (a)(2)
15.247 (b)	Peak Conducted Output Power	15.247 (b)(1) [Hopping] 15.247 (b)(3) [Non-Hopping]
15.247 (e)	Power Spectral Density	15.247 (e)

Interpretation of the measurement results has been performed in accordance with ANSI C63.10 section 1.3

Compliance with the requirements has been based on the results of the measurements compared to the specified limits, not taking into account measurement instrumentation uncertainty.

Measurement Uncertainty figures are stated in section 6

Note 1

Radiated Emissions limits in the tables from 47 CFR sections 15.109 & 15.209 are presented in $\mu\text{V}/\text{m}$. Measurements on the test system are made in $\text{dB}\mu\text{V}/\text{m}$. To convert between these, the following adjustment is used:

$$\text{New Limit} = 20 \log \left(\frac{\text{Original Limit}}{10^6} \right) + 120$$

Example: from 15.209(a) the limit for 30MHz – 88MHz is $100\mu\text{V}/\text{m}$ at 3m. This gives:

$$\text{New Limit} = 20 \log \left(\frac{100}{10^6} \right) + 120 = 40\text{dB}\mu\text{V}/\text{m} \text{ at } 3\text{m}$$

Additionally, in some cases testing has been performed at distances other than those specified in the tables. When this has occurred, the limits have been adjusted in accordance with the requirements in 47 CFR 15.31, using an extrapolation factor of 40dB/decade at frequencies below 30MHz and 20dB/decade at or above 30MHz

Example: from 15.209(a) the limit for 1.705MHz – 30MHz is $30\mu\text{V}/\text{m}$ (=29.54 $\text{dB}\mu\text{V}/\text{m}$) at 30m

$$\text{Limit@3m} = \text{Limit@30m} + 40 \log \left(\frac{30}{3} \right) = 29.54 + 40.00 = 69.54 \text{ dB}\mu\text{V}/\text{m} \text{ at } 3\text{m}$$

Example: from 15.209(a) the limit for 1GHz – 18GHz is $500\mu\text{V}/\text{m}$ (=53.98 $\text{dB}\mu\text{V}/\text{m}$) at 3m

$$\text{Limit@1m} = \text{Limit@3m} + 20 \log \left(\frac{3}{1} \right) = 53.98 + 9.54 = 63.52 \text{ dB}\mu\text{V}/\text{m} \text{ at } 1\text{m}$$

3.4 Description of Test Methods and Equipment Setup

3.4.1 General Description

Testing was performed in accordance with the various requirements of ANSI C63.4 and ANSI C63.10. Any deviations from the test methods are described in section 3.7

Where different arrangements of equipment were used for different types of measurements, these are tabulated in section 3.4.2 and details of each arrangement are included in subsequent sections

3.4.2 Test Equipment Setup Used by Test Type

FCC 47 CFR Rule Part	Test Description	Test Equipment Used
15.207	AC Power Line Conducted Emissions (Intentional Radiators)	Conducted Emissions
15.209	Radiated Emissions (Intentional Radiators)	SAC5
15.247 (d)	Antenna Conducted Emissions	CTE
15.247 (d)	Band Edge Compliance (Authorized band)	CTE
15.247 (d)	Band Edge Compliance (Restricted band)	SAC 5
15.247 (a)(1)	20dB Bandwidth	CTE
15.247 (a)(1)	Carrier (Hopping Channel) Separation	CTE
15.247 (a)(1)	Number of Hopping Channels	CTE
15.247 (a)(1)	Time of Occupancy (Dwell Time)	CTE
15.247 (a)(2)	6dB Bandwidth	CTE
15.247 (b)	Peak Conducted Output Power	CTE
15.247 (e)	Power Spectral Density	CTE

3.4.3 Test Equipment Setup – CTE System

The Comprehensive Test Environment (CTE) system consists of a number of instruments (see section 5.1.1) mounted in a rack together with automated relays and interconnecting hardware. The instruments and other equipment are controlled from a standard PC running software provided by the manufacturer. The RF output of the EUT is connected to the test system via a coaxial cable.

Tests are in the form of pre-defined scripts that can be loaded on the PC. The scripts, as well as the hardware setup, have been verified for conformance with the relevant test specifications.

Losses in the cables and interconnects have been measured using the system's own automated routines and are compensated for automatically. Any additional loss in RF adapter cables supplied together with the EUT can be compensated for using the known characteristics of that adapter.

CTE Block Diagram

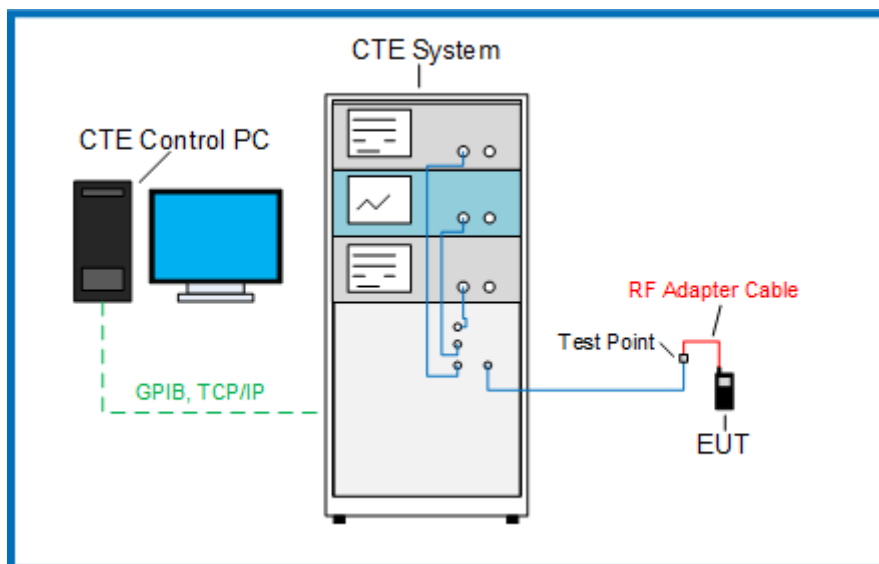

3.4.4 Test Equipment Setup – Conducted Emissions

- The EUT was placed 0.4 meters from the conducting wall of the shielded room with EUT being connected to the power mains through a line impedance stabilization network (LISN). Other support units were connected to the power mains through another LISN. The LISNs provide $50\Omega/50\mu\text{H}$ of coupling impedance for the measuring instrument.
- The lines of the power mains connected to the EUT were checked for maximum conducted interference.
- The frequency range from 150 kHz to 30 MHz was searched. Emission levels over 10 dB under the prescribed limits could not be reported.

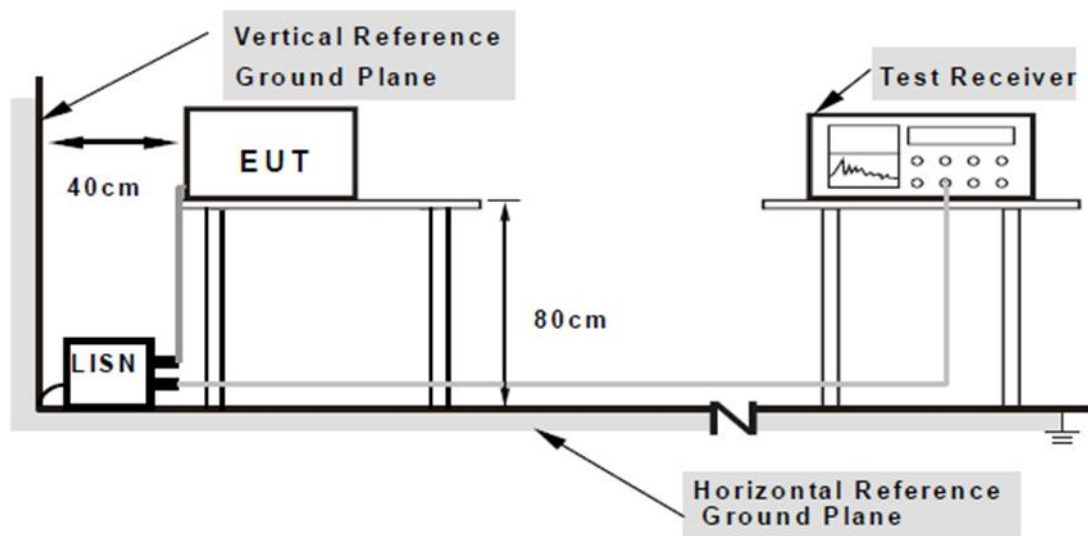

3.4.5 Test Equipment Setup – SAC 5 (Radiated Emissions and Restricted Band Edge)

- For frequency range 30MHz-1GHz Log-Periodic Antenna was used. Antenna elevated from 100 cm from floor to 400 cm from floor, and was placed at 3 m from center of turntable in tilted position. The equipment under test (EUT) was placed at the middle of the turntable at 150 cm height from floor. The antenna rotated to repeat the measurements for both the horizontal and vertical antenna polarizations. Repeat the measurement steps until the maximum emissions were obtained.
- For frequency range 1GHz-18GHz horn Antenna was used. Antenna elevated from 100 cm from floor to 200 cm from floor, and was placed at 3 m from center of turntable. The equipment under test (EUT) was placed at the middle of the turntable at 150 cm height from floor. The antenna rotated to repeat the measurements for both the horizontal and vertical antenna polarizations. Repeat the measurement steps until the maximum emissions were obtained.
- For frequency range 18GHz-40GHz double horn Antenna was used. Antenna's height was adjusted to 150 cm from floor, and 1 m distance to center of turntable. The equipment under test (EUT) was placed at the middle of the turntable on at 150 cm height from floor.
- For all frequency ranges the turntable was rotated 360° for obtaining the maximum emission.

SAC 5 Test Setup Configuration 30MHz – 1GHz

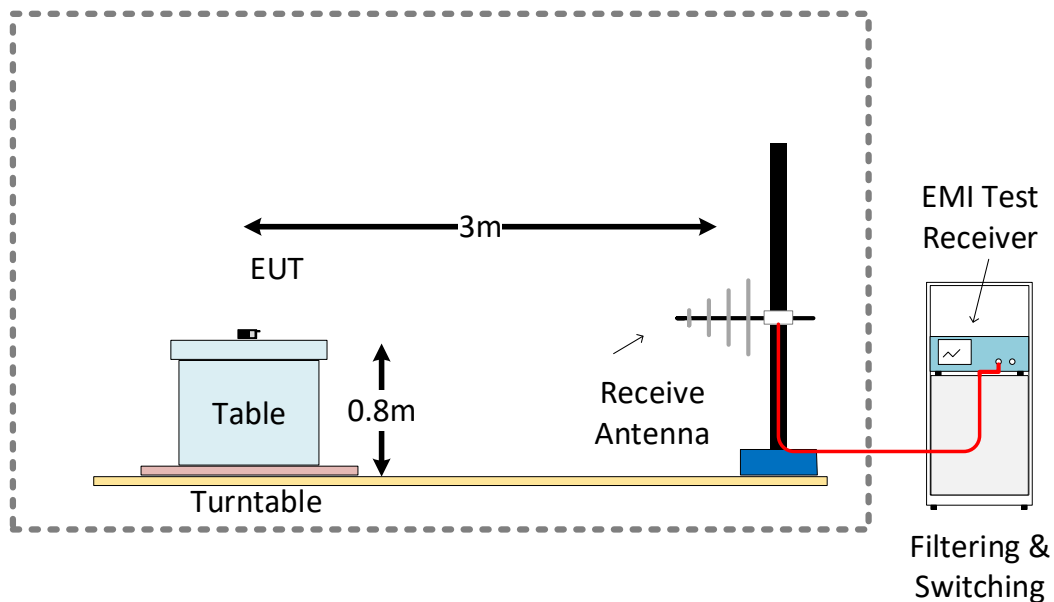

SAC 5 Test Setup Configuration 1GHz – 18GHz

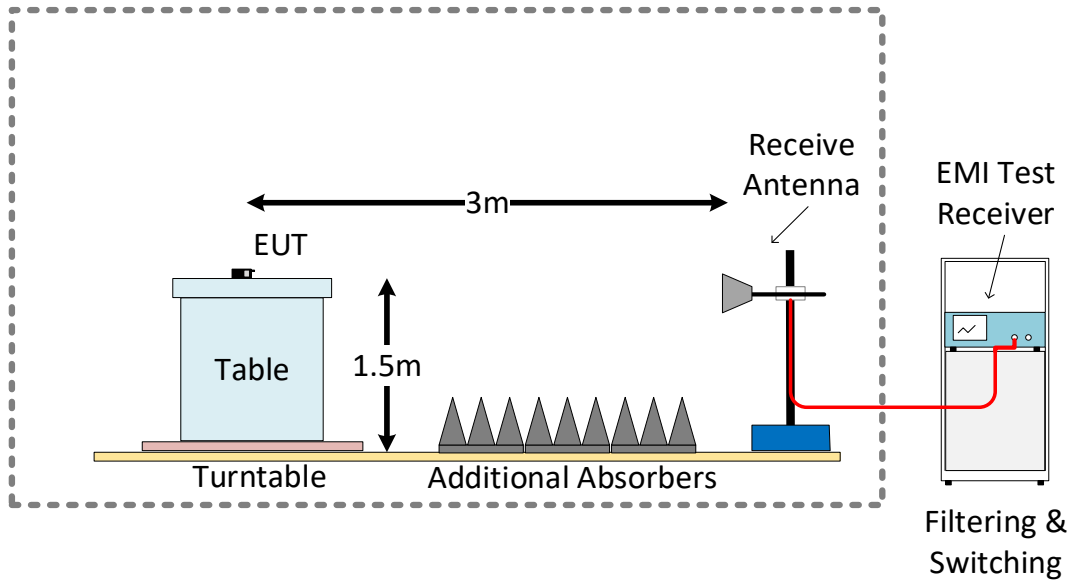

SAC 5 Test Setup Configuration 18GHz – 40GHz

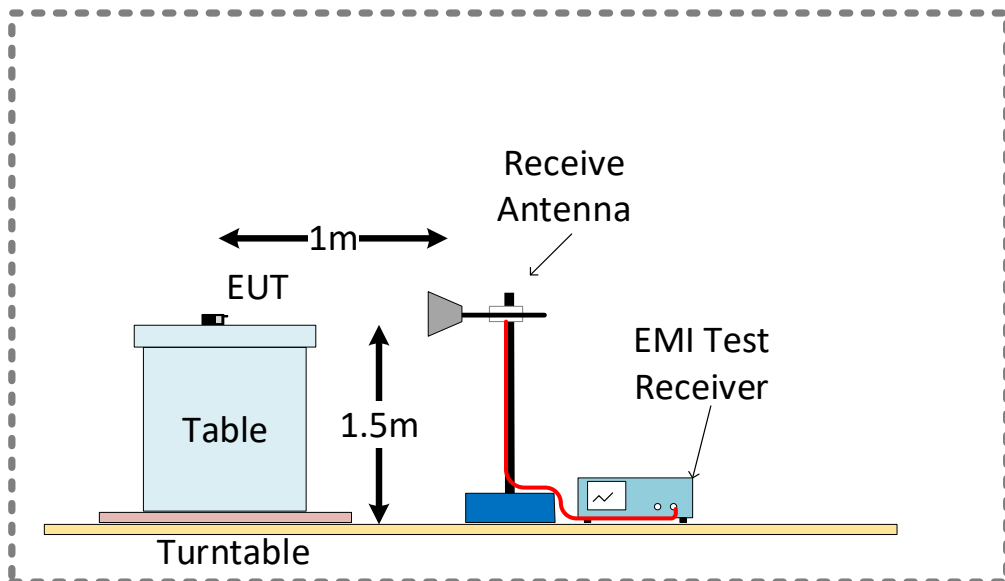

3.5 EUT Configuration During Test

AC Power Line Conducted Emissions

For AC power line conducted emissions testing, the device was connected to the USB Charger and set to continuous transmit mode on the mid channel. Conducted emissions tests were run on the Mains AC connection to the charger. See test setup photographs for more detail.

Radiated Emissions

For radiated emissions testing, the device was operated from the battery and set to continuous transmit mode on an appropriate channel. See test setup photographs for more detail.

Conducted RF

For all conducted RF testing, the device was mounted in the Launchpad interface board to allow access to the DTM mode. A USB connection from the test equipment to the Launchpad allowed the test equipment to send DTM commands and control the device. DC Power was supplied from a DC power supply to simulate the various battery levels. The device was modified with an RF connector in place of the Bluetooth antenna to allow for conducted RF measurements

3.6 EUT Operation Modes

Operation mode	Description
Continuous Tx	The device was set to transmit a continuous modulated signal with the appropriate frequency
DTM	The device was set to Bluetooth LE Direct Test Mode and was controlled by the test equipment

3.7 Deviations from the Test Standard

None

3.8 Environmental Conditions

3.8.1 Environmental Conditions – CTE System

Environmental Conditions Log - CTE

Date	Time	Temperature (°C)	Relative Humidity (%)
2021.02.03	10:00	20.8	22
2021.02.04	07:55	22.1	15

3.8.2 Environmental Conditions – Conducted Emissions System

Environmental Conditions Log – Conducted Emissions

Date	Time	Temperature (°C)	Relative Humidity (%)
2021.01.11	08:40	22.1	27

3.8.3 Environmental Conditions – SAC5 (Radiated Emissions)

Environmental Conditions Log – SAC5

Date	Time	Temperature (°C)	Relative Humidity (%)
2020.12.11	08:25	18.8	37
2020.12.22	08:51	18.1	43
2020.12.23	08:45	18.3	43
2021.01.19	07:48	18.4	31
2021.01.21	07:22	18.4	35
2021.01.23	09:00	18.3	35
2021.01.24	12:00	20.1	32

4. TEST RESULTS

4.1 Test Results – AC Power Line Conducted Emissions (Intentional Transmitter)

4.1.1 AC Power Line Conducted Emissions (Intentional) – Test Summary

Test Specification	FCC 47 CFR 15.207 (Part 15 Subpart C)		
Test Engineer & Date	Fariborz Abasi	2021.01.11	
EUT and Ancillary Equipment IDs	A002965790-001	A002972080-007	
EUT Operation Mode(s)	Continuous Tx		
EUT Wireless Configuration(s)	Bluetooth Low Energy (see below for details)		
EUT Hardware Configuration(s)	-		
Overall Result	PASS		
Test Parameter	Wireless Configuration	Frequency Range	Result*
AC Conducted Power Line Emissions – “N” Line	Bluetooth Low Energy 1M Mid Channel (GFSK 2440 MHz)	150 kHz – 30 MHz	PASS
AC Conducted Power Line Emissions – “L1” Line	Bluetooth Low Energy 1M Mid Channel (GFSK 2440 MHz)	150 kHz – 30 MHz	PASS

* For detailed measurements, see tables and graphs in sections below

4.1.2 AC Power Line Conducted Emissions (Intentional) – Test Details

Test	Conducted Emissions	
Test mode condition	Bluetooth 1M Mid Channel (2440 MHz)	
Standard	47 CFR Part 15.24	
EUT	A002965790-001	
Ancillary Equipment	A002972080-007 AC Adaptor	
Test Engineer	Fariborz Abasi	Date: 2021.01.11

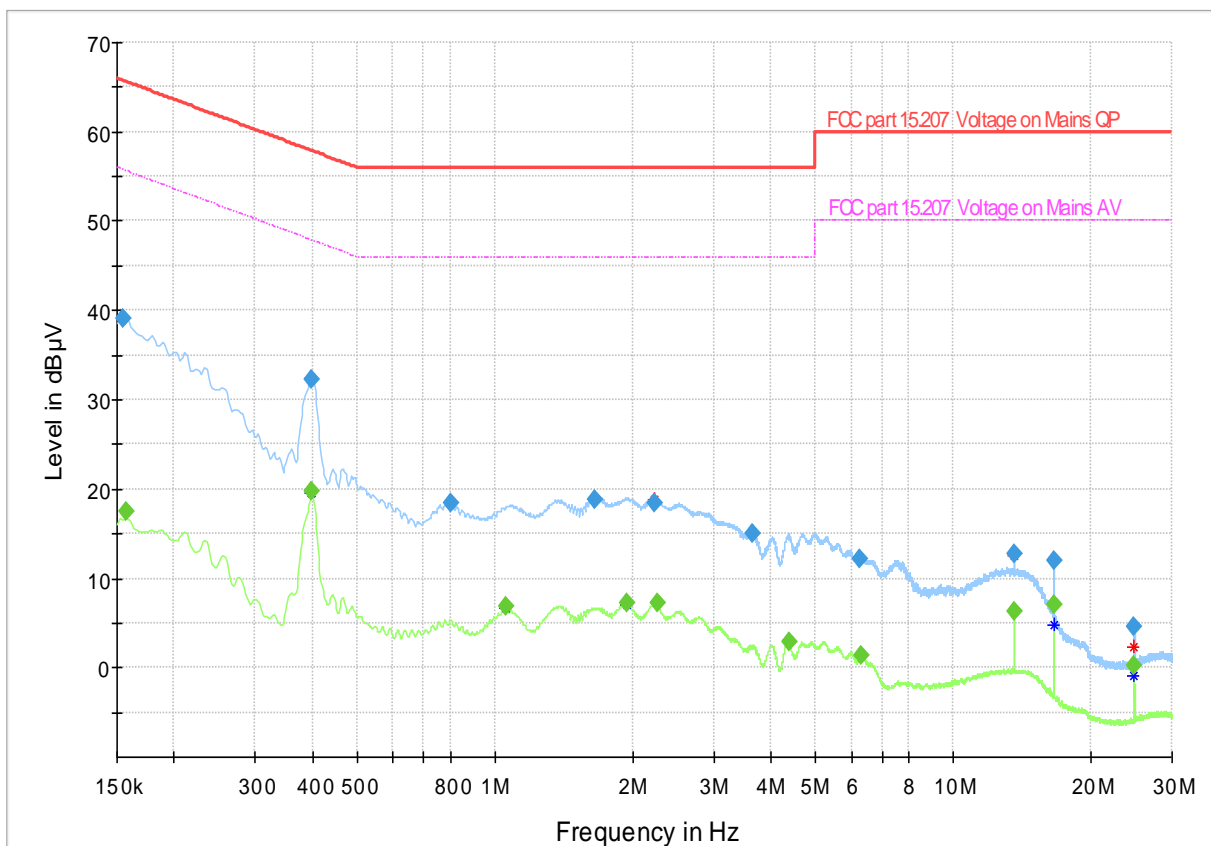

- Preview Result 2-CAV
- Preview Result 1-QPK
- * Critical_Freqs CAV
- * Critical_Freqs QPK
- FCC part 15.207 Voltage on Mains QP
- FCC part 15.207 Voltage on Mains AV
- ◆ Final_Result QPK
- ◆ Final_Result CAV

Frequency (MHz)	QuasiPeak (dBµV)	CAverage (dBµV)	Limit (dBµV)	Margin (dB)	Meas. Time (ms)	Bandwidth (kHz)	Line	Filter	Corr. (dB)
0.154500	39.17	---	65.75	26.58	1000.0	9.000	L1	ON	9.7
0.156750	---	17.55	55.63	38.08	1000.0	9.000	N	ON	9.7
0.399750	32.36	---	57.86	25.50	1000.0	9.000	N	ON	9.6
0.399750	---	19.85	47.86	28.01	1000.0	9.000	N	ON	9.6
0.802500	18.40	---	56.00	37.60	1000.0	9.000	N	ON	9.6
1.061250	---	6.79	46.00	39.21	1000.0	9.000	N	ON	9.7
1.653000	18.81	---	56.00	37.19	1000.0	9.000	N	ON	9.7
1.938750	---	7.34	46.00	38.66	1000.0	9.000	N	ON	9.7
2.238000	18.46	---	56.00	37.54	1000.0	9.000	N	ON	9.7
2.262750	---	7.18	46.00	38.82	1000.0	9.000	N	ON	9.7
3.660000	15.01	---	56.00	40.99	1000.0	9.000	L1	ON	9.8
4.382250	---	2.92	46.00	43.08	1000.0	9.000	N	ON	9.8
6.261000	12.19	---	60.00	47.81	1000.0	9.000	N	ON	9.8
6.321750	---	1.43	50.00	48.57	1000.0	9.000	N	ON	9.8
13.560000	---	6.40	50.00	43.60	1000.0	9.000	N	ON	9.9
13.560000	12.70	---	60.00	47.30	1000.0	9.000	N	ON	9.9
16.559250	---	7.04	50.00	42.96	1000.0	9.000	N	ON	10.0
16.572750	11.97	---	60.00	48.03	1000.0	9.000	L1	ON	9.9
24.837000	---	0.17	50.00	49.83	1000.0	9.000	N	ON	10.1
24.846000	4.58	---	60.00	55.42	1000.0	9.000	N	ON	10.1

4.2 Test Results – Radiated Emissions (Intentional Transmitter)

4.2.1 Radiated Emissions (Intentional) – Test Summary

Test Specification	FCC 47 CFR 15.209 (Part 15 Subpart C)		
Test Engineer & Date	Niall Forrester Joel Efraimsson Simon Palmhager	2020.12.11 – 2021.01.24	
EUT and Ancillary Equipment IDs	A002965790-001	-	
EUT Operation Mode(s)	Continuous Tx		
EUT Wireless Configuration(s)	Bluetooth Low Energy (see below for details)		
EUT Hardware Configuration(s)	-		
Overall Result	PASS		
Test Parameter	Wireless Configuration	Frequency Range	Result
Radiated Emissions	Bluetooth Low Energy 1M Low Channel (GFSK 2402 MHz)	9 kHz – 30 MHz	PASS
Radiated Emissions	Bluetooth Low Energy 1M Low Channel (GFSK 2402 MHz)	30 MHz – 1 GHz	PASS
Radiated Emissions	Bluetooth Low Energy 1M Low Channel (GFSK 2402 MHz)	1 GHz – 18 GHz	PASS
Radiated Emissions	Bluetooth Low Energy 1M Low Channel (GFSK 2402 MHz)	18 GHz – 40 GHz	PASS
Radiated Emissions	Bluetooth Low Energy 1M Mid Channel (GFSK 2440 MHz)	9 kHz – 30 MHz	PASS
Radiated Emissions	Bluetooth Low Energy 1M Mid Channel (GFSK 2440 MHz)	30 MHz – 1 GHz	PASS
Radiated Emissions	Bluetooth Low Energy 1M Mid Channel (GFSK 2440 MHz)	1 GHz – 18 GHz	PASS
Radiated Emissions	Bluetooth Low Energy 1M Mid Channel (GFSK 2440 MHz)	18 GHz – 40 GHz	PASS
Radiated Emissions	Bluetooth Low Energy 1M High Channel (GFSK 2480 MHz)	9 kHz – 30 MHz	PASS
Radiated Emissions	Bluetooth Low Energy 1M High Channel (GFSK 2480 MHz)	30 MHz – 1 GHz	PASS
Radiated Emissions	Bluetooth Low Energy 1M High Channel (GFSK 2480 MHz)	1 GHz – 18 GHz	PASS
Radiated Emissions	Bluetooth Low Energy 1M High Channel (GFSK 2480 MHz)	18 GHz – 40 GHz	PASS

4.2.2 Radiated Emissions (Intentional) – Test Details
Low Channel

Test mode condition	Bluetooth Low Energy 1M, Low channel (2402 MHz)	
Antenna orientation	Loop Antenna Parallel to Axis	
Sweep frequency	9 kHz-30 MHz	
Standard	47 CFR FCC Part 15 subpart C	
EUT	A002965790-001	
Ancillary Equipment	-	
Test Engineer	Niall Forrester	Date: 2021-01-21
Chamber details	Chamber: SAC 5	

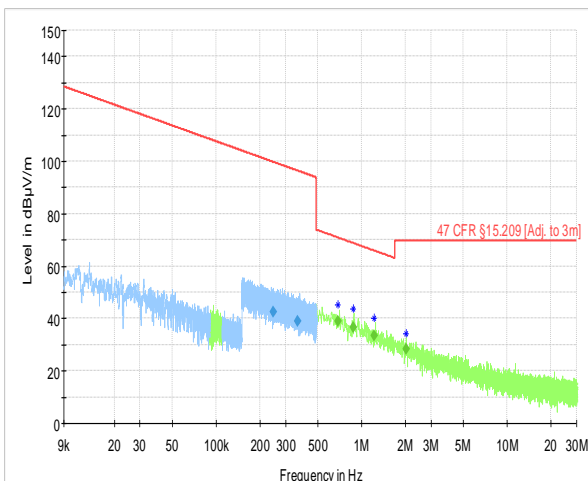

— Preview Result 2-PK+
♦ Critical_Freqs PK+
— 47 CFR §15.209 [Adj. to 3m]
♦ Final_Result QPK
— Preview Result 1-AVG
♦ Critical_Freqs AVG
♦ Final_Result AVG

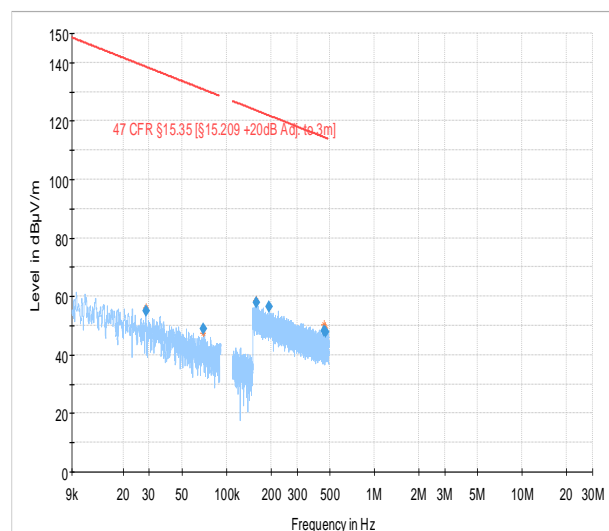

— Preview Result 1-PK+
— 47 CFR §15.35 [15.209 +20dB Adj. to 3m]
♦ Critical_Freqs PK+
♦ Final_Result PK+

Frequency (MHz)	Average (dBµV/m)	QuasiPeak (dBµV/m)	MaxPeak (dBµV/m)	Limit (dBµV/m)	Margin (dB)	Meas. Time (ms)	Bandwidth (kHz)	Height (cm)	Pol	Azimuth (deg)
0.247257	42.40	---	---	99.74	57.34	1000.0	9.000	100.0	H	269.0
0.364066	38.85	---	---	96.38	57.53	1000.0	9.000	100.0	H	25.0
0.684948	---	38.90	---	70.89	31.99	1000.0	9.000	100.0	H	45.0
0.877668	---	36.69	---	68.74	32.04	1000.0	9.000	100.0	H	244.0
1.213344	---	33.37	---	65.93	32.56	1000.0	9.000	100.0	H	45.0
2.015982	---	28.16	---	69.54	41.38	1000.0	9.000	100.0	H	77.0
0.028686	---	---	54.91	138.45	83.54	1000.0	0.200	100.0	H	45.0
0.069692	---	---	48.85	130.74	81.89	1000.0	0.200	100.0	H	-15.0
0.159682	---	---	57.74	123.54	65.80	1000.0	9.000	100.0	H	-2.0
0.194377	---	---	56.43	121.83	65.40	1000.0	9.000	100.0	H	225.0
0.457091	---	---	48.25	114.40	66.15	1000.0	9.000	100.0	H	229.0
0.469887	---	---	47.93	114.16	66.24	1000.0	9.000	100.0	H	-27.0

Test mode condition	Bluetooth Low Energy 1M, Low channel (2402 MHz)	
Antenna orientation	Loop Antenna Perpendicular to Axis	
Sweep frequency	9 kHz-30 MHz	
Standard	47 CFR FCC Part 15 subpart C	
EUT	A002965790-001	
Ancillary Equipment	-	
Test Engineer	Joel Efraimsson	Date: 2021-01-21
Chamber details	Chamber: SAC 5	

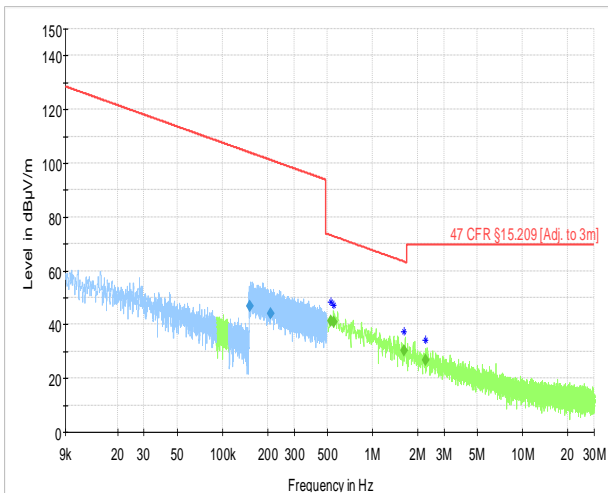

— Preview Result 2-PK+
+ Critical_Freqs PK+
— 47 CFR §15.209 [Adj. to 3m]
◆ Final_Result QPK
— Preview Result 1-AVG
+ Critical_Freqs AVG
◆ Final_Result AVG

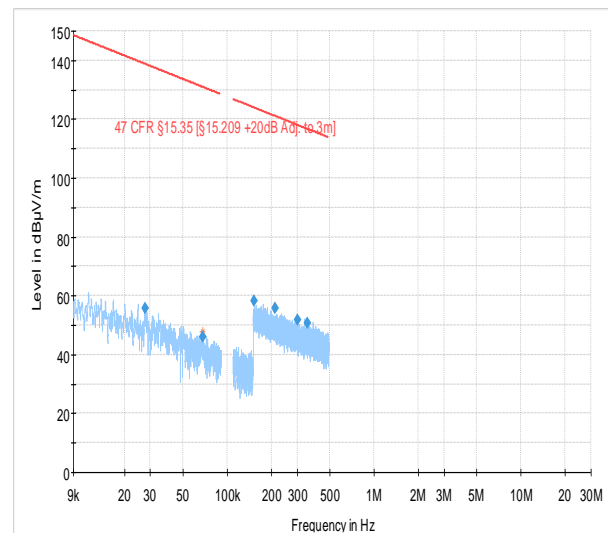

— Preview Result 1-PK+
— 47 CFR §15.35 [§15.209 +20dB Adj. to 3m]
+ Critical_Freqs PK+
◆ Final_Result PK+

Frequency (MHz)	Average (dBµV/m)	QuasiPeak (dBµV/m)	MaxPeak (dBµV/m)	Limit (dBµV/m)	Margin (dB)	Meas. Time (ms)	Bandwidth (kHz)	Height (cm)	Pol	Azimuth (deg)
0.152948	46.75	---	---	103.91	57.17	1000.0	9.000	100.0	H	256.0
0.209548	44.03	---	---	101.18	57.15	1000.0	9.000	100.0	H	-45.0
0.527439	---	41.49	---	73.16	31.67	1000.0	9.000	100.0	H	-2.0
0.550304	---	41.09	---	72.79	31.70	1000.0	9.000	100.0	H	-1.0
1.620348	---	30.25	---	63.41	33.16	1000.0	9.000	100.0	H	139.0
2.263755	---	26.89	---	69.54	42.65	1000.0	9.000	100.0	H	89.0
0.027520	---	---	55.59	138.81	83.22	1000.0	0.200	100.0	H	292.0
0.068167	---	---	45.97	130.93	84.96	1000.0	0.200	100.0	H	165.0
0.151797	---	---	58.33	123.98	65.65	1000.0	9.000	100.0	H	45.0
0.211132	---	---	55.76	121.11	65.35	1000.0	9.000	100.0	H	125.0
0.299720	---	---	51.66	118.07	66.41	1000.0	9.000	100.0	H	88.0
0.351583	---	---	50.90	116.68	65.79	1000.0	9.000	100.0	H	229.0

Test mode condition	Bluetooth Low Energy 1M, Low channel (2402 MHz)	
Antenna orientation	Loop Antenna Parallel to floor	
Sweep frequency	9 kHz-30 MHz	
Standard	47 CFR FCC Part 15 subpart C	
EUT	A002965790-001	
Ancillary Equipment	-	
Test Engineer	Joel Efraimsson	Date: 2021-01-24
Chamber details	Chamber: SAC 5	

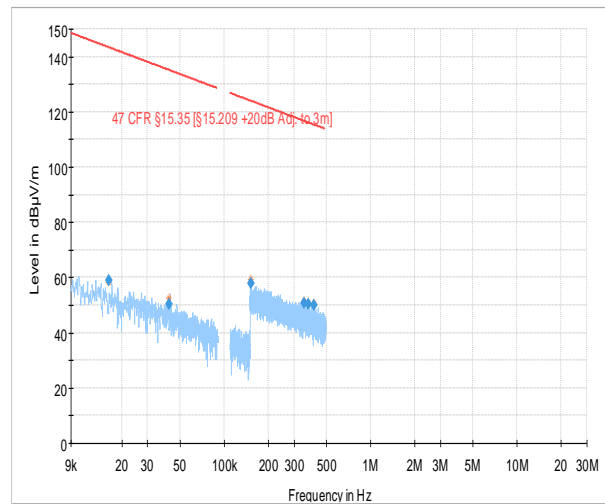
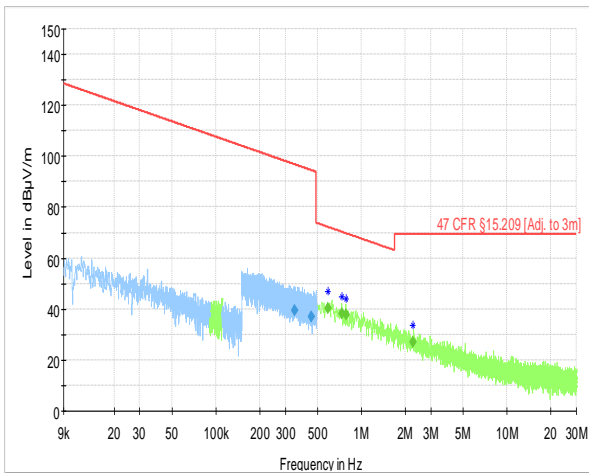

Frequency (MHz)	Average (dBµV/m)	QuasiPeak (dBµV/m)	MaxPeak (dBµV/m)	Limit (dBµV/m)	Margin (dB)	Meas. Time (ms)	Bandwidth (kHz)	Height (cm)	Pol	Azimuth (deg)
0.347260	39.29	---	---	96.79	57.50	1000.0	9.000	100.0	H	45.0
0.452591	37.04	---	---	94.49	57.45	1000.0	9.000	100.0	H	127.0
0.589304	---	40.33	---	72.20	31.87	1000.0	9.000	100.0	H	-2.0
0.736258	---	38.35	---	70.26	31.92	1000.0	9.000	100.0	H	12.0
0.782843	---	37.77	---	69.73	31.97	1000.0	9.000	100.0	H	135.0
2.253187	---	27.01	---	69.54	42.54	1000.0	9.000	100.0	H	295.0
0.016383	---	---	58.89	143.32	84.43	1000.0	0.200	100.0	H	75.0
0.042120	---	---	50.28	135.11	84.83	1000.0	0.200	100.0	H	63.0
0.152094	---	---	58.07	123.96	65.89	1000.0	9.000	100.0	H	223.0
0.353389	---	---	50.78	116.64	65.85	1000.0	9.000	100.0	H	112.0
0.377158	---	---	50.26	116.07	65.82	1000.0	9.000	100.0	H	225.0
0.410248	---	---	50.14	115.34	65.20	1000.0	9.000	100.0	H	-3.0

Test mode condition	Bluetooth Low Energy 1M, Low channel (2402 MHz)	
Antenna orientation	Horizontal and Vertical	
Sweep frequency	30 MHz – 1 GHz	
Standard	47 CFR FCC Part 15 subpart C	
EUT	A002965790-001	
Ancillary Equipment	-	
Test Engineer	Niall Forrester	Date: 2020-12-23
Chamber details	Chamber: SAC 5	

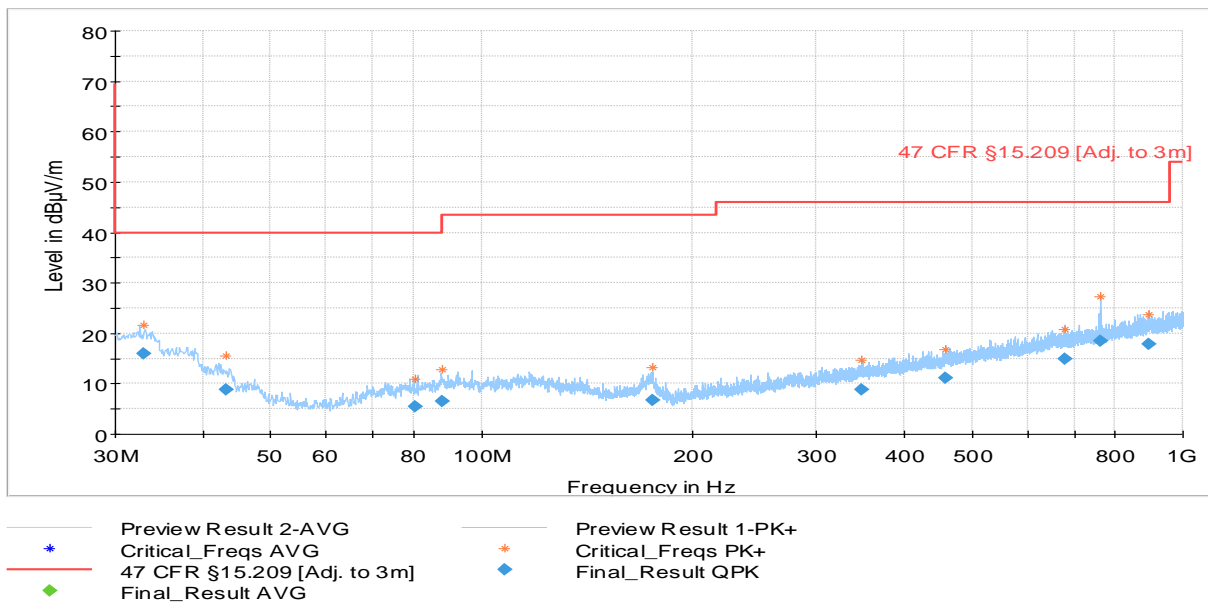

Frequency (MHz)	QuasiPeak (dBµV/m)	Limit (dBµV/m)	Margin (dB)	Meas. Time (ms)	Bandwidth (kHz)	Height (cm)	Pol	Azimuth (deg)
32.929760	16.03	40.00	23.97	1000.0	120.000	233.0	V	112.0
43.279680	8.77	40.00	31.23	1000.0	120.000	170.0	V	27.0
80.367960	5.49	40.00	34.51	1000.0	120.000	154.0	H	142.0
87.696920	6.58	40.00	33.42	1000.0	120.000	354.0	H	158.0
174.937320	6.79	43.52	36.74	1000.0	120.000	220.0	H	322.0
348.756560	8.72	46.02	37.30	1000.0	120.000	183.0	H	142.0
458.689040	11.23	46.02	34.79	1000.0	120.000	410.0	V	40.0
677.663800	14.83	46.02	31.19	1000.0	120.000	233.0	V	72.0
761.999040	18.54	46.02	27.48	1000.0	120.000	254.0	H	68.0
893.408280	17.75	46.02	28.28	1000.0	120.000	275.0	H	289.0

Test mode condition	Bluetooth Low Energy 1M, Low channel (2402 MHz)	
Antenna orientation	Horizontal and Vertical	
Sweep frequency	1 GHz – 18 GHz	
Standard	47 CFR FCC Part 15 subpart C	
EUT	A002965790-001	
Ancillary Equipment	-	
Test Engineer	Joel Efraimsson	Date: 2020-12-21
Chamber details	Chamber: SAC 5	

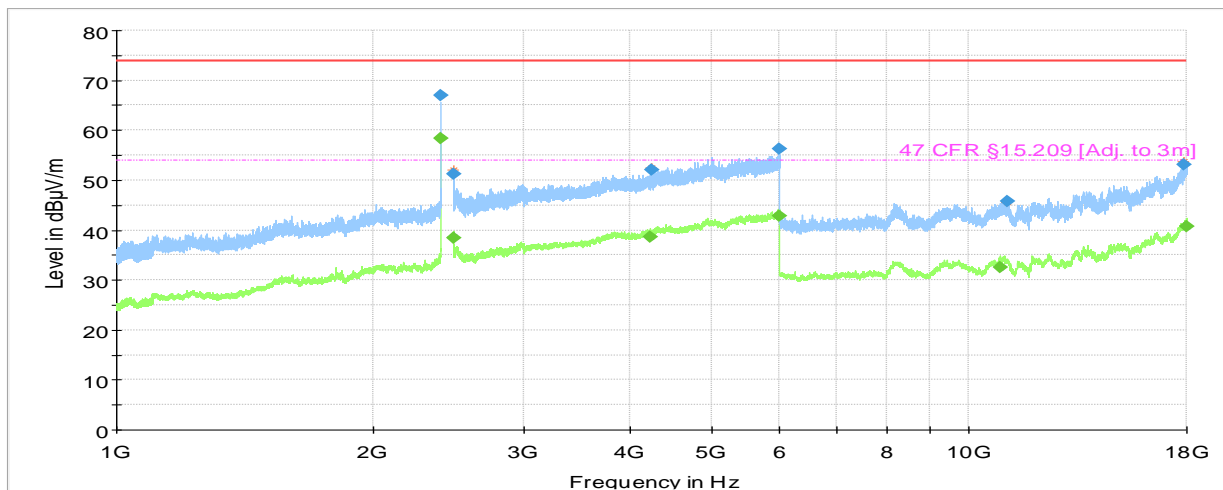

- Preview Result 2-AVG
- * Critical_Freqs AVG
- 47 CFR §15.35 [§15.209 +20dB Adj. to 3m]
- ◆ Final_Result PK+
- Preview Result 1-PK+
- * Critical_Freqs PK+
- 47 CFR §15.209 [Adj. to 3m]
- ◆ Final_Result AVG

Frequency (MHz)	MaxPeak (dBµV/m)	Average (dBµV/m)	Limit (dBµV/m)	Margin (dB)	Meas. Time (ms)	Bandwidth (kHz)	Height (cm)	Pol	Azimuth (deg)
2399.974000	67.05	---	73.98	6.93	1000.0	1000.000	158.0	H	-3.0
2399.996500	---	58.37	53.98	-4.39	1000.0	1000.000	175.0	H	-2.0
2483.508000	---	38.53	53.98	15.45	1000.0	1000.000	207.0	V	292.0
2483.556000	51.32	---	73.98	22.66	1000.0	1000.000	100.0	H	10.0
4234.215000	---	38.74	53.98	15.24	1000.0	1000.000	100.0	H	267.0
4239.154000	52.07	---	73.98	21.91	1000.0	1000.000	206.0	H	87.0
5982.867000	---	42.91	53.98	11.07	1000.0	1000.000	175.0	H	-22.0
5982.895000	56.34	---	73.98	17.64	1000.0	1000.000	175.0	V	10.0
10875.974000	---	32.64	53.98	21.34	1000.0	1000.000	100.0	V	153.0
11070.535000	45.83	---	73.98	28.15	1000.0	1000.000	125.0	V	22.0
17887.005000	53.12	---	73.98	20.86	1000.0	1000.000	189.0	H	154.0
17998.203000	---	40.72	53.98	13.25	1000.0	1000.000	100.0	H	252.0

***NOTE** The peak around 2400MHz is an artefact of the path loss compensation and is not caused by the DUT. Please see Band Edge test results for accurate measurements at this frequency

Test mode condition	Bluetooth Low Energy 1M, Low channel (2402 MHz)	
Antenna orientation	Horizontal and Vertical	
Sweep frequency	18 GHz – 40 GHz	
Standard	47 CFR FCC Part 15 subpart C	
EUT	A002965790-001	
Ancillary Equipment	-	
Test Engineer	Niall Forrester	Date: 2021-01-19
Chamber details	Chamber: SAC 5	

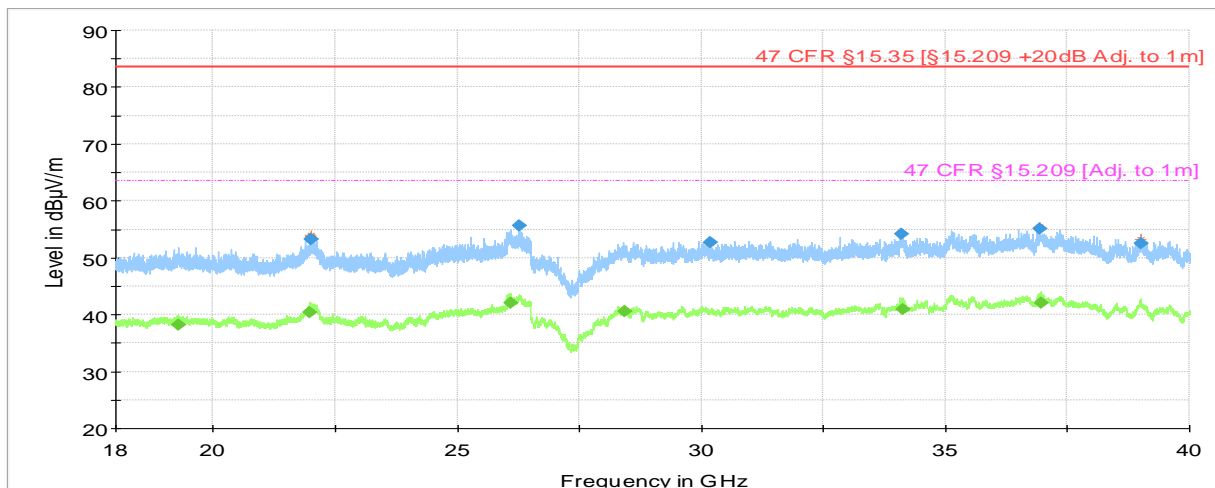

— Preview Result 2-AVG
* Critical_Freqs AVG
— 47 CFR §15.35 [§15.209 +20dB Adj. to 1m]
◆ Final_Result PK+

— Preview Result 1-PK+
* Critical_Freqs PK+
— 47 CFR §15.209 [Adj. to 1m]
◆ Final_Result AVG

Frequency (MHz)	MaxPeak (dBµV/m)	Average (dBµV/m)	Limit (dBµV/m)	Margin (dB)	Meas. Time (ms)	Bandwidth (kHz)	Height (cm)	Pol	Azimuth (deg)
19293.098000	---	38.25	63.52	25.27	1000.0	1000.000	155.0	H	142.0
21977.674000	---	40.31	63.52	23.21	1000.0	1000.000	155.0	V	262.0
21991.915000	53.17	---	83.52	30.35	1000.0	1000.000	155.0	V	72.0
21993.976000	53.22	---	83.52	30.30	1000.0	1000.000	155.0	V	82.0
26085.553000	---	42.14	63.52	21.39	1000.0	1000.000	155.0	V	172.0
26280.425000	55.73	---	83.52	27.79	1000.0	1000.000	155.0	V	352.0
28416.446000	---	40.52	63.52	23.00	1000.0	1000.000	155.0	V	8.0
30196.788000	52.68	---	83.52	30.84	1000.0	1000.000	155.0	V	112.0
34098.733000	54.09	---	83.52	29.43	1000.0	1000.000	155.0	H	202.0
34134.657000	---	40.93	63.52	22.59	1000.0	1000.000	155.0	V	248.0
36922.530000	55.17	---	83.52	28.35	1000.0	1000.000	155.0	V	202.0
36947.324000	---	42.10	63.52	21.42	1000.0	1000.000	155.0	V	-8.0
38995.188000	52.51	---	83.52	31.02	1000.0	1000.000	155.0	H	322.0

Mid Channel

Test mode condition	Bluetooth Low Energy 1M, Mid channel (2440 MHz)	
Antenna orientation	Loop Antenna Parallel to Axis	
Sweep frequency	9 kHz-30 MHz	
Standard	47 CFR FCC Part 15 subpart C	
EUT	A002965790-001	
Ancillary Equipment	-	
Test Engineer	Niall Forrester	Date: 2021-01-21
Chamber details	Chamber: SAC 5	

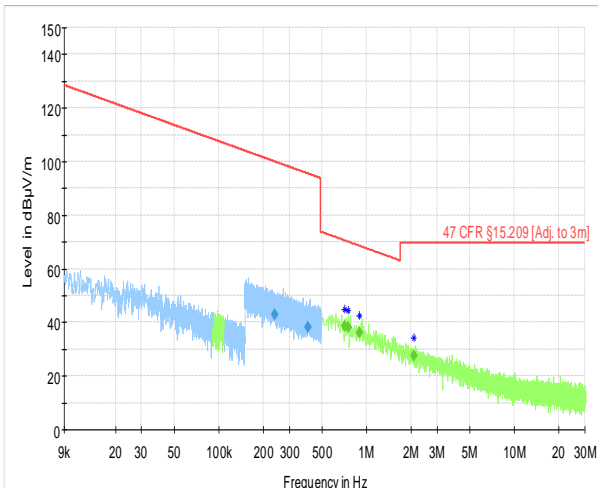

— Preview Result 2-PK+ — Preview Result 1-AVG
+ Critical_Freqs PK+ + Critical_Freqs AVG
— 47 CFR §15.209 [Adj. to 3m] ♦ Final_Result AVG
♦ Final_Result QPK

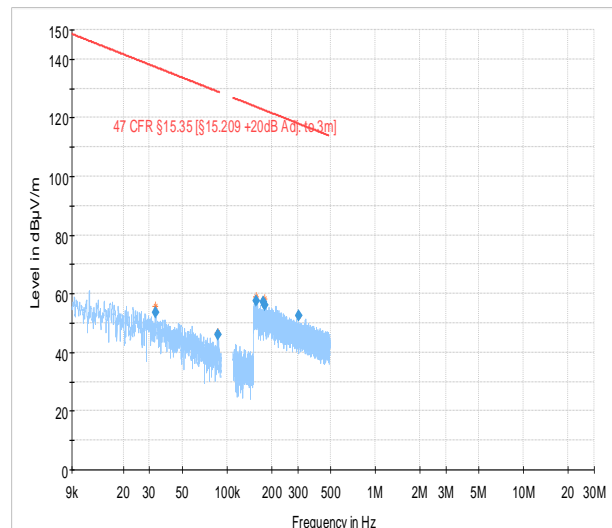

— Preview Result 1-PK+ + Critical_Freqs PK+
— 47 CFR §15.35 [§15.209 +20dB Adj. to 3m] ♦ Final_Result PK+

Frequency (MHz)	Average (dBµV/m)	QuasiPeak (dBµV/m)	MaxPeak (dBµV/m)	Limit (dBµV/m)	Margin (dB)	Meas. Time (ms)	Bandwidth (kHz)	Height (cm)	Pol	Azimuth (deg)
0.239108	42.75	---	---	100.03	57.29	1000.0	9.000	100.0	H	269.0
0.400838	38.09	---	---	95.55	57.46	1000.0	9.000	100.0	H	-26.0
0.707657	---	38.70	---	70.61	31.90	1000.0	9.000	100.0	H	315.0
0.750247	---	38.17	---	70.10	31.93	1000.0	9.000	100.0	H	218.0
0.898864	---	36.33	---	68.53	32.20	1000.0	9.000	100.0	H	-45.0
2.093478	---	27.68	---	69.54	41.86	1000.0	9.000	100.0	H	315.0
0.033100	---	---	53.59	137.21	83.61	1000.0	0.200	100.0	H	-45.0
0.086582	---	---	46.15	128.86	82.71	1000.0	0.200	100.0	H	45.0
0.157188	---	---	57.61	123.68	66.07	1000.0	9.000	100.0	H	43.0
0.174850	---	---	57.09	122.75	65.66	1000.0	9.000	100.0	H	268.0
0.179639	---	---	55.99	122.52	66.52	1000.0	9.000	100.0	H	225.0
0.304282	---	---	52.60	117.94	65.33	1000.0	9.000	100.0	H	-27.0

Test mode condition	Bluetooth Low Energy 1M, Mid channel (2440 MHz)	
Antenna orientation	Loop Antenna Perpendicular to Axis	
Sweep frequency	9 kHz-30 MHz	
Standard	47 CFR FCC Part 15 subpart C	
EUT	A002965790-001	
Ancillary Equipment	-	
Test Engineer	Joel Efraimsson	Date: 2021-01-21
Chamber details	Chamber: SAC 5	

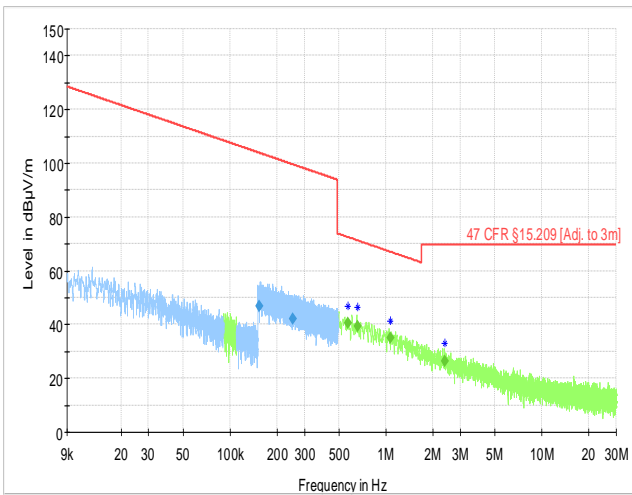

- Preview Result 2-PK+
- Preview Result 1-AVG
- * Critical_Freqs PK+
- * Critical_Freqs AVG
- 47 CFR §15.209 [Adj. to 3m]
- ♦ Final_Result AVG
- ♦ Final_Result QPK

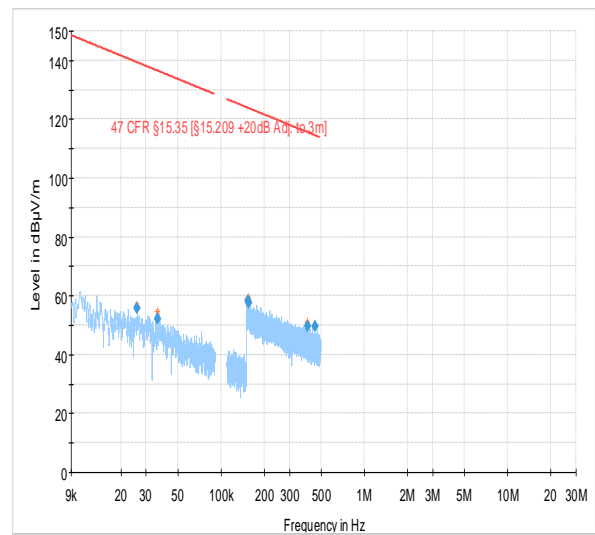

- Preview Result 1-PK+
- 47 CFR §15.35 [§15.209 +20dB Adj. to 3m]
- * Critical_Freqs PK+
- ♦ Final_Result PK+

Frequency (MHz)	Average (dBµV/m)	QuasiPeak (dBµV/m)	MaxPeak (dBµV/m)	Limit (dBµV/m)	Margin (dB)	Meas. Time (ms)	Bandwidth (kHz)	Height (cm)	Pol	Azimuth (deg)
0.153738	46.71	---	---	103.87	57.16	1000.0	9.000	100.0	H	309.0
0.253894	42.13	---	---	99.51	57.38	1000.0	9.000	100.0	H	205.0
0.570313	---	40.72	---	72.48	31.77	1000.0	9.000	100.0	H	-26.0
0.660694	---	39.36	---	71.20	31.84	1000.0	9.000	100.0	H	37.0
1.068304	---	34.85	---	67.03	32.18	1000.0	9.000	100.0	H	49.0
2.395924	---	26.37	---	69.54	43.17	1000.0	9.000	100.0	H	-2.0
0.025852	---	---	55.72	139.35	83.64	1000.0	0.200	100.0	H	-27.0
0.036104	---	---	51.99	136.45	84.46	1000.0	0.200	100.0	H	135.0
0.154409	---	---	58.22	123.83	65.61	1000.0	9.000	100.0	H	23.0
0.155671	---	---	57.67	123.76	66.09	1000.0	9.000	100.0	H	307.0
0.400469	---	---	49.62	115.55	65.93	1000.0	9.000	100.0	H	45.0
0.455041	---	---	49.61	114.44	64.83	1000.0	9.000	100.0	H	45.0

Test mode condition	Bluetooth Low Energy 1M, Mid channel (2440 MHz)	
Antenna orientation	Loop Antenna Parallel to floor	
Sweep frequency	9 kHz-30 MHz	
Standard	47 CFR FCC Part 15 subpart C	
EUT	A002965790-001	
Ancillary Equipment	-	
Test Engineer	Joel Efraimsson	Date: 2021-01-24
Chamber details	Chamber: SAC 5	

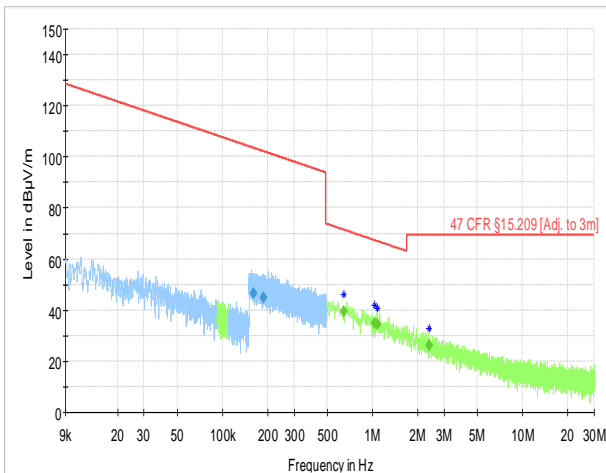

- Preview Result 2-PK+
- Critical_Freqs PK+
- 47 CFR §15.209 [Adj. to 3m]
- Final_Result QPK
- QuasiPeak-QPK (Single)
- Preview Result 1-AVG
- Critical_Freqs AVG
- Final_Result AVG
- MaxPeak-PK+ (Single)
- Average-AVG (Single)

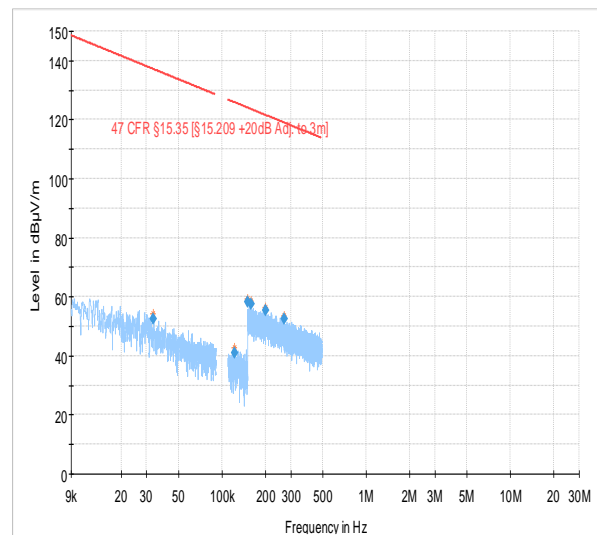

- Preview Result 1-PK+
- 47 CFR §15.35 [§15.209 +20dB Adj. to 3m]
- Critical_Freqs PK+
- Final_Result PK+

Frequency (MHz)	Average (dBµV/m)	QuasiPeak (dBµV/m)	MaxPeak (dBµV/m)	Limit (dBµV/m)	Margin (dB)	Meas. Time (ms)	Bandwidth (kHz)	Height (cm)	Pol	Azimuth (deg)
0.160633	46.37	---	---	103.49	57.12	1000.0	9.000	100.0	H	-26.0
0.187495	45.00	---	---	102.14	57.14	1000.0	9.000	100.0	H	225.0
0.645621	---	39.48	---	71.41	31.93	1000.0	9.000	100.0	H	36.0
1.034924	---	35.10	---	67.31	32.21	1000.0	9.000	100.0	H	225.0
1.082311	---	34.56	---	66.92	32.36	1000.0	9.000	100.0	H	135.0
2.395910	---	26.36	---	69.54	43.18	1000.0	9.000	100.0	H	307.0
0.033430	---	---	52.49	137.12	84.63	1000.0	0.200	100.0	H	135.0
0.122237	---	---	41.02	125.86	84.84	1000.0	0.200	100.0	H	135.0
0.151190	---	---	58.17	124.01	65.84	1000.0	9.000	100.0	H	135.0
0.159525	---	---	57.73	123.55	65.82	1000.0	9.000	100.0	H	135.0
0.200715	---	---	55.33	121.55	66.23	1000.0	9.000	100.0	H	9.0
0.269864	---	---	52.61	118.98	66.37	1000.0	9.000	100.0	H	191.0

Test mode condition	Bluetooth Low Energy 1M, Mid channel (2440 MHz)	
Antenna orientation	Horizontal and Vertical	
Sweep frequency	30 MHz – 1 GHz	
Standard	47 CFR FCC Part 15 subpart C	
EUT	A002965790-001	
Ancillary Equipment	-	
Test Engineer	Simon Palmhager	Date: 2020-12-28
Chamber details	Chamber: SAC 5	

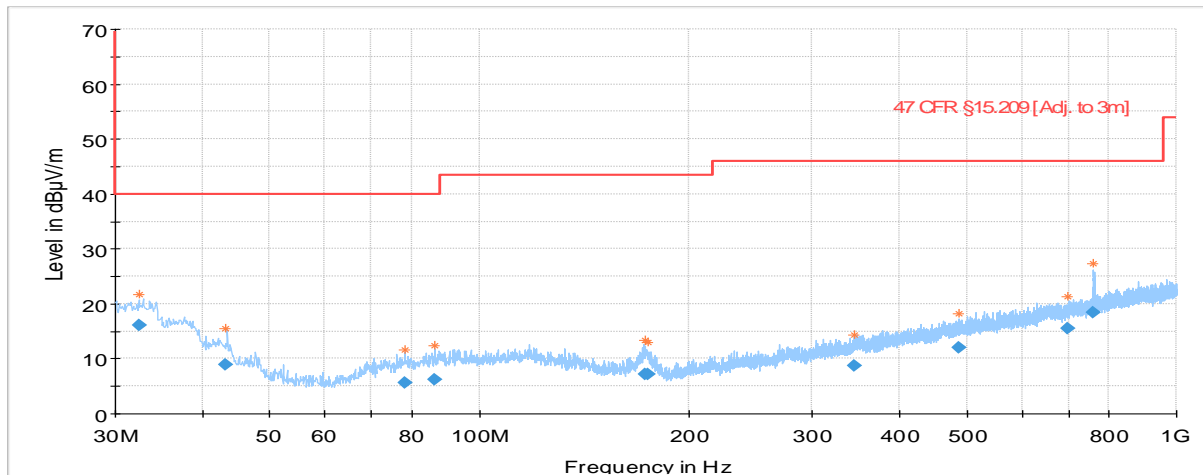

- Preview Result 2-AVG
- * Critical_Freqs AVG
- 47 CFR §15.209 [Adj. to 3m]
- ◆ Final_Result AVG
- + QuasiPeak-QPK (Single)
- Preview Result 1-PK+
- * Critical_Freqs PK+
- ◆ Final_Result QPK
- × MaxPeak-PK+ (Single)
- × Average-AVG (Single)

Frequency (MHz)	QuasiPeak (dBµV/m)	Average (dBµV/m)	Limit (dBµV/m)	Margin (dB)	Meas. Time (ms)	Bandwidth (kHz)	Height (cm)	Pol	Azimuth (deg)
32.421720	16.02	---	40.00	23.98	1000.0	120.000	375.0	V	232.0
43.219840	8.83	---	40.00	31.17	1000.0	120.000	325.0	V	-22.0
78.104680	5.69	---	40.00	34.31	1000.0	120.000	254.0	H	-4.0
86.347600	6.19	---	40.00	33.81	1000.0	120.000	125.0	V	68.0
172.557600	7.15	---	43.52	36.37	1000.0	120.000	108.0	H	220.0
174.070880	7.20	---	43.52	36.32	1000.0	120.000	275.0	H	98.0
344.790000	8.75	---	46.02	37.27	1000.0	120.000	100.0	V	233.0
487.854080	11.94	---	46.02	34.08	1000.0	120.000	175.0	H	-18.0
699.419560	15.51	---	46.02	30.52	1000.0	120.000	325.0	V	199.0
760.969360	18.34	---	46.02	27.68	1000.0	120.000	375.0	H	248.0

Test mode condition	Bluetooth Low Energy 1M, Mid channel (2440 MHz)	
Antenna orientation	Horizontal and Vertical	
Sweep frequency	1 GHz – 18 GHz	
Standard	47 CFR FCC Part 15 subpart C	
EUT	A002965790-001	
Ancillary Equipment	-	
Test Engineer	Joel Efraimsson	Date: 2020-12-11
Chamber details	Chamber: SAC 5	

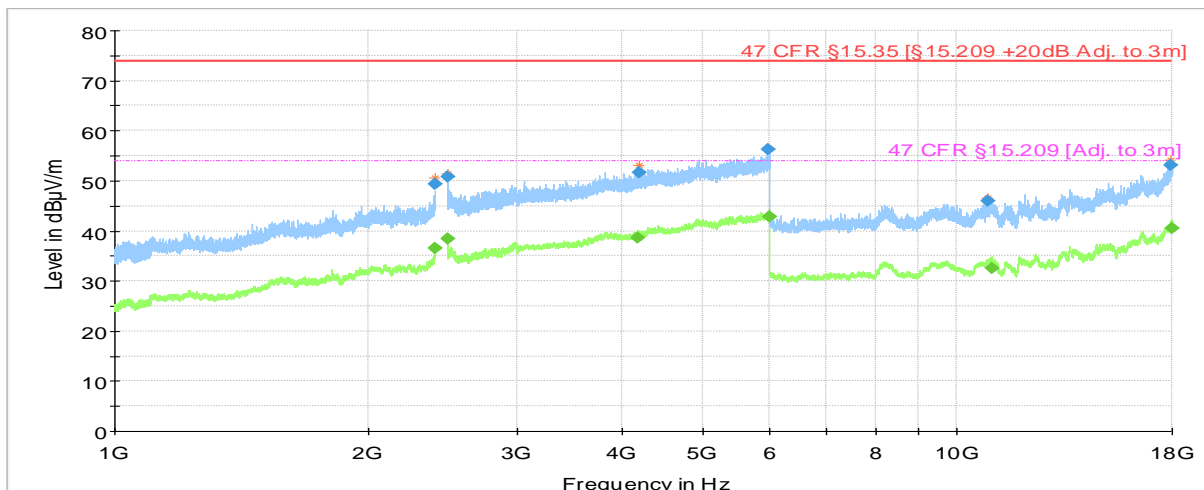

— Preview Result 2-AVG
— Preview Result 1-PK+
* Critical_Freqs AVG
* Critical_Freqs PK+
— 47 CFR §15.35 [§15.209 +20dB Adj. to 3m]
— 47 CFR §15.209 [Adj. to 3m]
◆ Final_Result PK+
◆ Final_Result AVG

Frequency (MHz)	MaxPeak (dBµV/m)	Average (dBµV/m)	Limit (dBµV/m)	Margin (dB)	Meas. Time (ms)	Bandwidth (kHz)	Height (cm)	Pol	Azimuth (deg)
2399.970500	49.36	---	73.98	24.62	1000.0	1000.000	121.0	H	292.0
2399.984000	---	36.50	53.98	17.48	1000.0	1000.000	177.0	H	335.0
2483.566000	---	38.42	53.98	15.56	1000.0	1000.000	102.0	V	248.0
2483.733519	50.73	---	73.98	23.25	1000.0	1000.000	177.0	H	338.0
4178.993000	---	38.72	53.98	15.26	1000.0	1000.000	210.0	H	41.0
4186.866000	51.69	---	73.98	22.29	1000.0	1000.000	100.0	H	66.0
5974.761000	56.19	---	73.98	17.79	1000.0	1000.000	198.0	V	248.0
5987.199000	---	42.86	53.98	11.12	1000.0	1000.000	100.0	V	10.0
10861.122000	45.97	---	73.98	28.01	1000.0	1000.000	100.0	V	142.0
10991.885000	---	32.48	53.98	21.50	1000.0	1000.000	175.0	H	39.0
17915.851000	53.15	---	73.98	20.83	1000.0	1000.000	100.0	H	278.0
17971.604000	---	40.58	53.98	13.40	1000.0	1000.000	206.0	V	248.0

Test mode condition	Bluetooth Low Energy 1M, Mid channel (2440 MHz)	
Antenna orientation	Horizontal and Vertical	
Sweep frequency	18 GHz – 40 GHz	
Standard	47 CFR FCC Part 15 subpart C	
EUT	A002965790-001	
Ancillary Equipment	-	
Test Engineer	Joel Efraimsson	Date: 2021-01-19
Chamber details	Chamber: SAC 5	

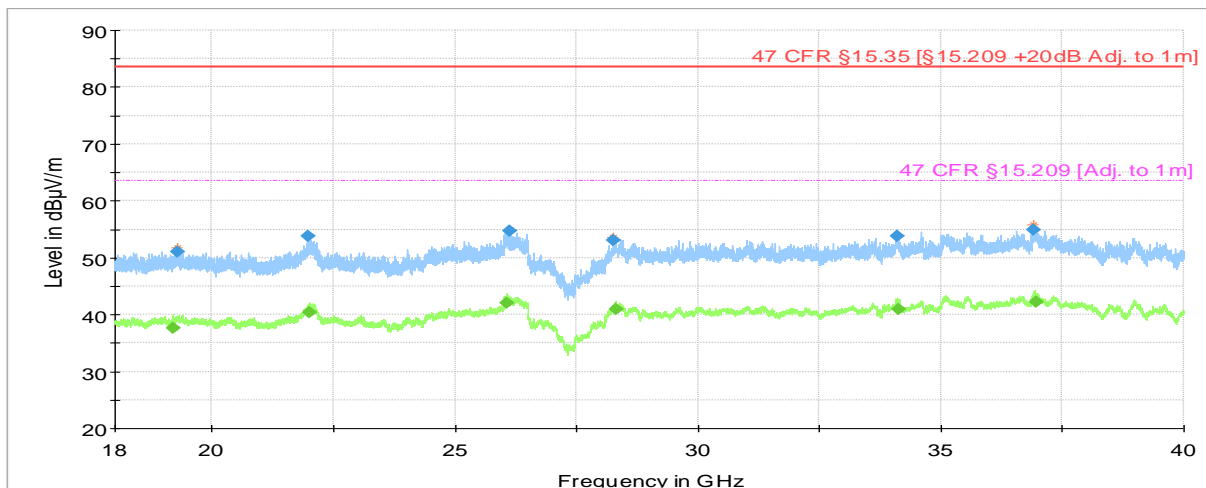

— Preview Result 2-AVG
* Critical_Freqs AVG
— 47 CFR §15.35 [§15.209 +20dB Adj. to 1m]
◆ Final_Result PK+

— Preview Result 1-PK+
* Critical_Freqs PK+
— 47 CFR §15.209 [Adj. to 1m]
◆ Final_Result AVG

Frequency (MHz)	MaxPeak (dBµV/m)	Average (dBµV/m)	Limit (dBµV/m)	Margin (dB)	Meas. Time (ms)	Bandwidth (kHz)	Height (cm)	Pol	Azimuth (deg)
19193.176000	---	37.58	63.52	25.94	1000.0	1000.000	155.0	H	308.0
19273.046000	51.09	---	83.52	32.43	1000.0	1000.000	155.0	V	156.0
21987.572000	53.89	---	83.52	29.64	1000.0	1000.000	155.0	V	232.0
22005.524000	---	40.33	63.52	23.19	1000.0	1000.000	155.0	H	146.0
26064.179000	---	42.04	63.52	21.48	1000.0	1000.000	155.0	H	172.0
26111.598000	54.77	---	83.52	28.75	1000.0	1000.000	155.0	V	262.0
28255.780000	53.13	---	83.52	30.39	1000.0	1000.000	155.0	V	186.0
28299.392000	---	40.93	63.52	22.59	1000.0	1000.000	155.0	V	292.0
34101.750000	53.89	---	83.52	29.63	1000.0	1000.000	155.0	H	158.0
34119.502000	---	40.92	63.52	22.60	1000.0	1000.000	155.0	V	246.0
36898.026000	54.92	---	83.52	28.61	1000.0	1000.000	155.0	V	222.0
36947.210000	---	42.26	63.52	21.26	1000.0	1000.000	155.0	H	278.0

High Channel

Test mode condition	Bluetooth Low Energy 1M, High channel (2480 MHz)	
Antenna orientation	Loop Antenna Parallel to axis	
Sweep frequency	9 kHz-30 MHz	
Standard	47 CFR FCC Part 15 subpart C	
EUT	A002965790-001	
Ancillary Equipment	-	
Test Engineer	Niall Forrester	Date: 2021-01-21
Chamber details	Chamber: SAC 5	

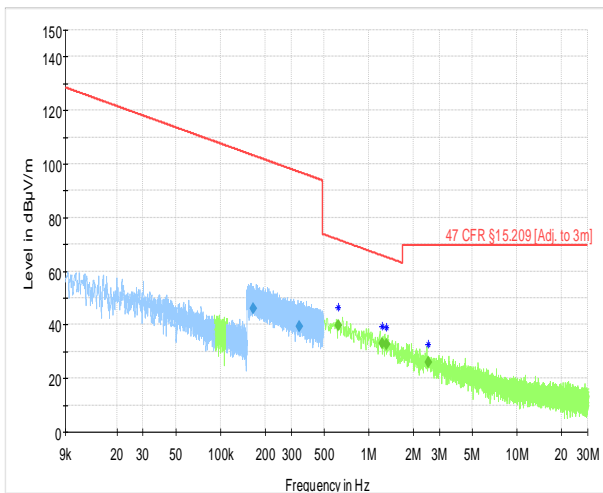

— Preview Result 2-PK+
+ Critical_Freqs PK+
— 47 CFR §15.209 (Adj. to 3m)
◆ Final_Result QPK
— Preview Result 1-AVG
+ Critical_Freqs AVG
◆ Final_Result AVG

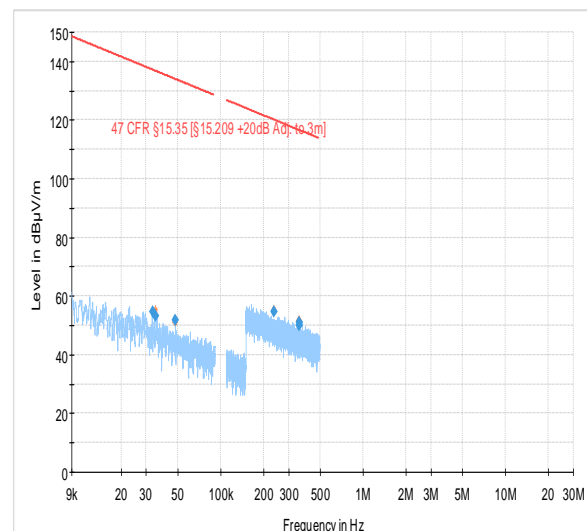

— Preview Result 1-PK+
— 47 CFR §15.35 (Adj. to 3m)
+ Critical_Freqs PK+
◆ Final_Result PK+

Frequency (MHz)	Average (dBµV/m)	QuasiPeak (dBµV/m)	MaxPeak (dBµV/m)	Limit (dBµV/m)	Margin (dB)	Meas. Time (ms)	Bandwidth (kHz)	Height (cm)	Pol	Azimuth (deg)
0.165596	46.04	---	---	103.22	57.19	1000.0	9.000	100.0	H	115.0
0.340145	39.44	---	---	96.97	57.53	1000.0	9.000	100.0	H	-13.0
0.624734	---	39.83	---	71.69	31.86	1000.0	9.000	100.0	H	244.0
1.229807	---	33.25	---	65.81	32.55	1000.0	9.000	100.0	H	-13.0
1.310115	---	32.52	---	65.26	32.74	1000.0	9.000	100.0	H	257.0
2.508586	---	25.99	---	69.54	43.55	1000.0	9.000	100.0	H	135.0
0.033264	---	---	54.72	137.17	82.44	1000.0	0.200	100.0	H	75.0
0.034957	---	---	53.38	136.73	83.36	1000.0	0.200	100.0	H	112.0
0.047733	---	---	51.76	134.03	82.27	1000.0	0.200	100.0	H	315.0
0.236586	---	---	54.57	120.12	65.56	1000.0	9.000	100.0	H	45.0
0.355641	---	---	50.98	116.58	65.61	1000.0	9.000	100.0	H	45.0
0.357077	---	---	50.07	116.55	66.48	1000.0	9.000	100.0	H	279.0

Test mode condition	Bluetooth Low Energy 1M, High channel (2480 MHz)	
Antenna orientation	Loop Antenna Perpendicular to axis	
Sweep frequency	9 kHz-30 MHz	
Standard	47 CFR FCC Part 15 subpart C	
EUT	A002965790-001	
Ancillary Equipment	-	
Test Engineer	Simon Palmhager	Date: 2021-01-23
Chamber details	Chamber: SAC 5	

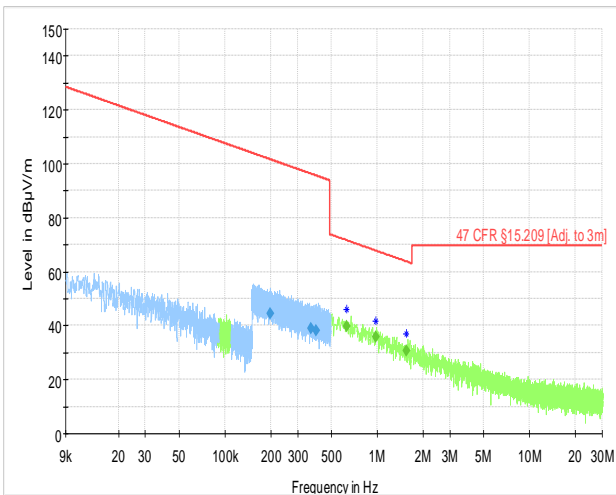

— Preview Result 2-PK+
+ Critical_Freqs PK+
— 47 CFR §15.209 [Adj. to 3m]
◆ Final_Result QPK
— Preview Result 1-AVG
+ Critical_Freqs AVG
◆ Final_Result AVG

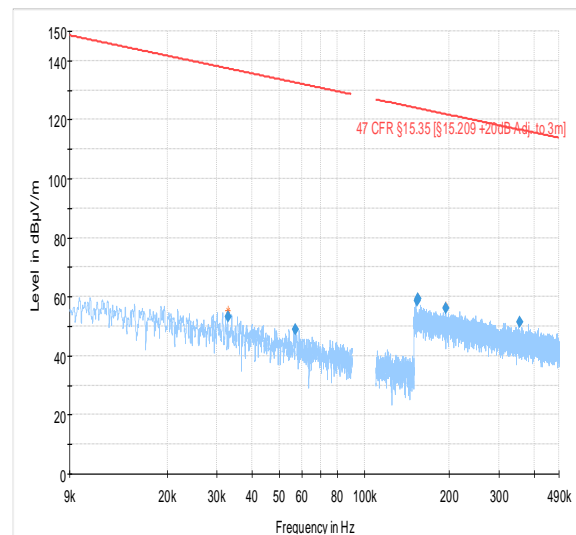

— Preview Result 1-PK+
— 47 CFR §15.35 [§15.209 +20dB Adj. to 3m]
+ Critical_Freqs PK+
◆ Final_Result PK+

Frequency (MHz)	Average (dBµV/m)	QuasiPeak (dBµV/m)	MaxPeak (dBµV/m)	Limit (dBµV/m)	Margin (dB)	Meas. Time (ms)	Bandwidth (kHz)	Height (cm)	Pol	Azimuth (deg)
0.197540	44.64	---	---	101.69	57.05	1000.0	9.000	100.0	H	45.0
0.367751	38.83	---	---	96.29	57.47	1000.0	9.000	100.0	H	307.0
0.397205	38.12	---	---	95.62	57.51	1000.0	9.000	100.0	H	191.0
0.628835	---	39.76	---	71.63	31.87	1000.0	9.000	100.0	H	135.0
0.974778	---	35.71	---	67.83	32.12	1000.0	9.000	100.0	H	269.0
1.560841	---	30.74	---	63.74	33.00	1000.0	9.000	100.0	H	-41.0
0.032877	---	---	53.25	137.27	84.02	1000.0	0.200	100.0	H	124.0
0.056738	---	---	49.01	132.53	83.52	1000.0	0.200	100.0	H	135.0
0.153700	---	---	58.62	123.87	65.25	1000.0	9.000	100.0	H	315.0
0.154362	---	---	59.21	123.83	64.62	1000.0	9.000	100.0	H	243.0
0.194320	---	---	55.97	121.83	65.86	1000.0	9.000	100.0	H	225.0
0.355494	---	---	51.52	116.59	65.07	1000.0	9.000	100.0	H	100.0

Test mode condition	Bluetooth Low Energy 1M, High channel (2480 MHz)	
Antenna orientation	Loop Antenna Parallel to floor	
Sweep frequency	9 kHz-30 MHz	
Standard	47 CFR FCC Part 15 subpart C	
EUT	A002965790-001	
Ancillary Equipment	-	
Test Engineer	Joel Efraimsson	Date: 2021-01-24
Chamber details	Chamber: SAC 5	

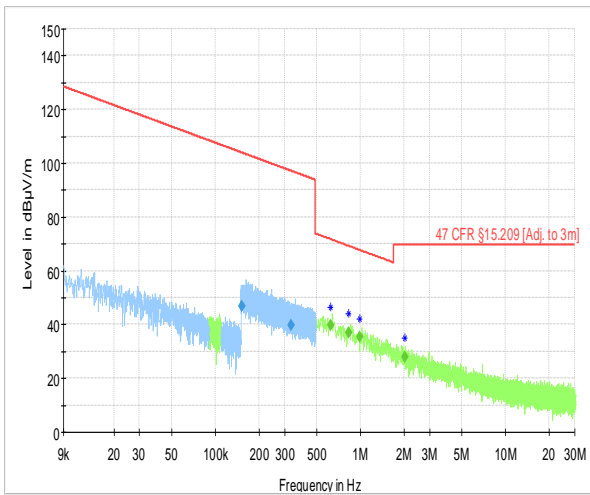

— Preview Result 2-PK+ — Preview Result 1-AVG
+ Critical_Freqs PK+ + Critical_Freqs AVG
— 47 CFR §15.209 (Adj. to 3m) ♦ Final_Result AVG
♦ Final_Result QPK

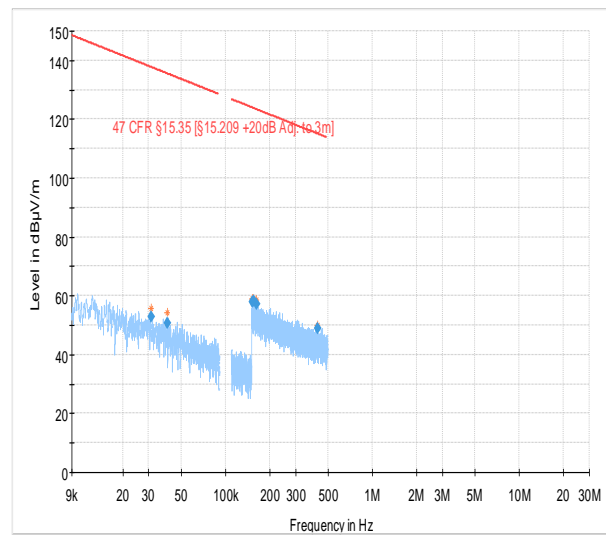

— Preview Result 1-PK+ + Critical_Freqs PK+
— 47 CFR §15.35 (Adj. to 3m) ♦ Final_Result PK+

Frequency (MHz)	Average (dBµV/m)	QuasiPeak (dBµV/m)	MaxPeak (dBµV/m)	Limit (dBµV/m)	Margin (dB)	Meas. Time (ms)	Bandwidth (kHz)	Height (cm)	Pol	Azimuth (deg)
0.151758	46.77	---	---	103.98	57.21	1000.0	9.000	100.0	H	139.0
0.331699	39.65	---	---	97.19	57.54	1000.0	9.000	100.0	H	126.0
0.624896	---	39.88	---	71.69	31.81	1000.0	9.000	100.0	H	24.0
0.825484	---	37.17	---	69.27	32.10	1000.0	9.000	100.0	H	101.0
0.988914	---	35.59	---	67.70	32.11	1000.0	9.000	100.0	H	49.0
2.018220	---	28.11	---	69.54	41.44	1000.0	9.000	100.0	H	218.0
0.031142	---	---	52.95	137.74	84.79	1000.0	0.200	100.0	H	315.0
0.040089	---	---	50.69	135.54	84.85	1000.0	0.200	100.0	H	63.0
0.152063	---	---	58.08	123.96	65.88	1000.0	9.000	100.0	H	202.0
0.156365	---	---	58.13	123.72	65.59	1000.0	9.000	100.0	H	-15.0
0.162347	---	---	57.19	123.40	66.21	1000.0	9.000	100.0	H	34.0
0.423104	---	---	48.83	115.08	66.24	1000.0	9.000	100.0	H	255.0

Test mode condition	Bluetooth Low Energy 1M, High channel (2480 MHz)	
Antenna orientation	Horizontal and Vertical	
Sweep frequency	30 MHz – 1 GHz	
Standard	47 CFR FCC Part 15 subpart C	
EUT	A002965790-001	
Ancillary Equipment	-	
Test Engineer	Simon Palmhager	Date: 2020-12-28
Chamber details	Chamber: SAC 5	

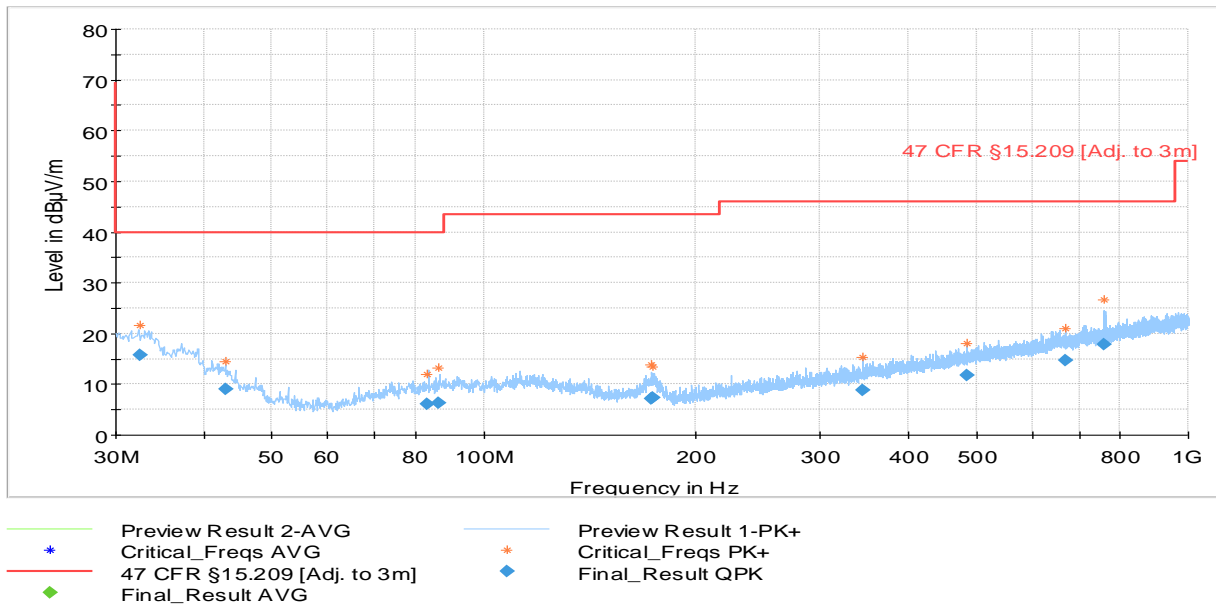

Frequency (MHz)	QuasiPeak (dBµV/m)	Average (dBµV/m)	Limit (dBµV/m)	Margin (dB)	Meas. Time (ms)	Bandwidth (kHz)	Height (cm)	Pol	Azimuth (deg)
32.444760	15.81	---	40.00	24.19	1000.0	120.000	225.0	H	64.0
43.075720	8.95	---	40.00	31.05	1000.0	120.000	304.0	V	-4.0
83.130080	6.08	---	40.00	33.92	1000.0	120.000	275.0	H	142.0
86.182160	6.25	---	40.00	33.75	1000.0	120.000	108.0	V	202.0
172.872680	7.20	---	43.52	36.32	1000.0	120.000	320.0	V	338.0
173.350520	7.35	---	43.52	36.17	1000.0	120.000	404.0	H	202.0
345.138480	8.74	---	46.02	37.29	1000.0	120.000	275.0	V	188.0
485.675120	11.81	---	46.02	34.21	1000.0	120.000	375.0	V	19.0
670.250560	14.79	---	46.02	31.23	1000.0	120.000	304.0	H	68.0
760.564480	17.92	---	46.02	28.10	1000.0	120.000	375.0	H	52.0

Test mode condition	Bluetooth Low Energy 1M, High channel (2480 MHz)	
Antenna orientation	Horizontal and Vertical	
Sweep frequency	1 GHz – 18 GHz	
Standard	47 CFR FCC Part 15 subpart C	
EUT	A002965790-001	
Ancillary Equipment	-	
Test Engineer	Joel Efraimsson	Date: 2020-12-21
Chamber details	Chamber: SAC 5	

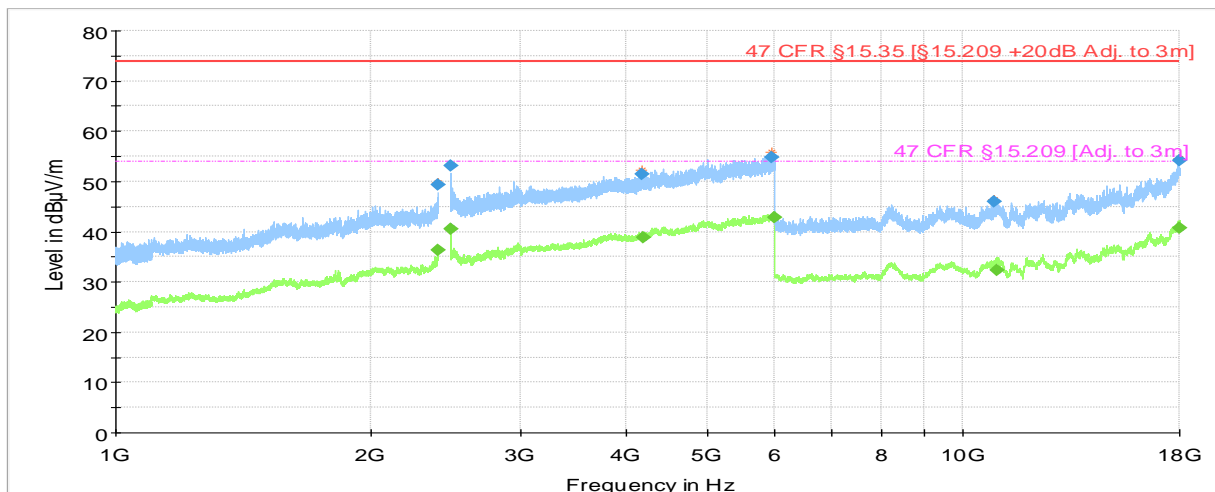

- Preview Result 2-AVG
- Preview Result 1-PK+
- * Critical_Freqs AVG
- * Critical_Freqs PK+
- ◆ 47 CFR §15.35 [§15.209 +20dB Adj. to 3m]
- ◆ 47 CFR §15.209 [Adj. to 3m]
- ◆ Final_Result PK+
- ◆ Final_Result AVG

Frequency (MHz)	MaxPeak (dBµV/m)	Average (dBµV/m)	Limit (dBµV/m)	Margin (dB)	Meas. Time (ms)	Bandwidth (kHz)	Height (cm)	Pol	Azimuth (deg)
2399.970000	---	36.24	53.98	17.74	1000.0	1000.000	120.0	V	192.0
2399.993500	49.27	---	73.98	24.71	1000.0	1000.000	100.0	V	206.0
2483.520924	---	40.52	53.98	13.46	1000.0	1000.000	171.0	H	-3.0
2483.617669	53.04	---	73.98	20.94	1000.0	1000.000	148.0	H	10.0
4175.823000	51.47	---	73.98	22.51	1000.0	1000.000	196.0	V	20.0
4190.373000	---	38.75	53.98	15.23	1000.0	1000.000	198.0	V	234.0
5946.877000	54.81	---	73.98	19.17	1000.0	1000.000	175.0	H	116.0
5980.897000	---	42.91	53.98	11.07	1000.0	1000.000	100.0	V	202.0
10858.485000	45.93	---	73.98	28.05	1000.0	1000.000	175.0	V	68.0
10977.883000	---	32.40	53.98	21.58	1000.0	1000.000	100.0	V	116.0
17968.482000	54.20	---	73.98	19.78	1000.0	1000.000	175.0	H	109.0
17985.223000	---	40.82	53.98	13.16	1000.0	1000.000	175.0	V	296.0

Test mode condition	Bluetooth Low Energy 1M, High channel (2480 MHz)	
Antenna orientation	Horizontal and Vertical	
Sweep frequency	18 GHz – 40 GHz	
Standard	47 CFR FCC Part 15 subpart C	
EUT	A002965790-001	
Ancillary Equipment	-	
Test Engineer	Joel Efraimsson	Date: 2021-01-19
Chamber details	Chamber: SAC 5	

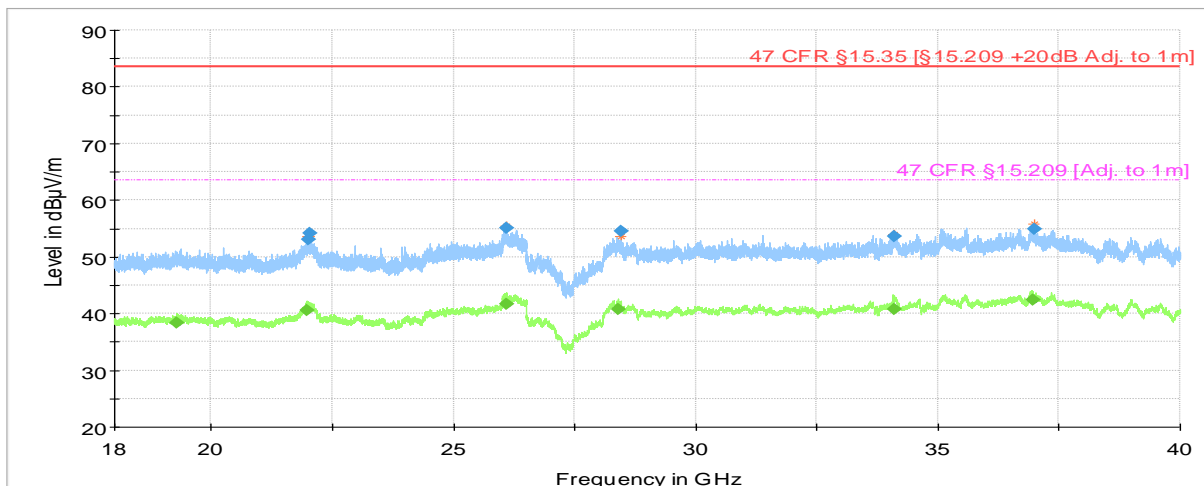

- Preview Result 2-AVG
- Preview Result 1-PK+
- * Critical_Freqs AVG
- * Critical_Freqs PK+
- 47 CFR §15.35 [§15.209 +20dB Adj. to 1m]
- 47 CFR §15.209 [Adj. to 1m]
- ◆ Final_Result PK+
- ◆ Final_Result AVG

Frequency (MHz)	MaxPeak (dBµV/m)	Average (dBµV/m)	Limit (dBµV/m)	Margin (dB)	Meas. Time (ms)	Bandwidth (kHz)	Height (cm)	Pol	Azimuth (deg)
19296.370000	---	38.30	63.52	25.23	1000.0	1000.000	155.0	H	248.0
21986.845000	---	40.50	63.52	23.02	1000.0	1000.000	155.0	V	158.0
22016.501000	53.05	---	83.52	30.47	1000.0	1000.000	155.0	H	38.0
22017.336000	54.15	---	83.52	29.37	1000.0	1000.000	155.0	H	22.0
26091.002000	55.01	---	83.52	28.51	1000.0	1000.000	155.0	H	22.0
26104.118000	---	41.66	63.52	21.86	1000.0	1000.000	155.0	V	172.0
28414.989000	---	40.72	63.52	22.80	1000.0	1000.000	155.0	V	142.0
28464.862000	54.57	---	83.52	28.95	1000.0	1000.000	155.0	V	262.0
34084.916000	53.66	---	83.52	29.86	1000.0	1000.000	155.0	V	132.0
34085.933000	---	40.79	63.52	22.73	1000.0	1000.000	155.0	V	338.0
36947.484000	---	42.35	63.52	21.17	1000.0	1000.000	155.0	H	26.0
36998.476000	54.87	---	83.52	28.66	1000.0	1000.000	155.0	H	322.0

4.3 Test Results – Antenna Conducted Emissions

4.3.1 Antenna Conducted Emissions – Test Summary

Emissions measurements performed as radiated test (see section 4.2)

4.4 Test Results – Band Edge Compliance (Authorized Band)

4.4.1 Band Edge Compliance (Authorized Band) – Test Summary

Test Specification	47 CFR 15.247 (d)			
Test Engineer & Date	Niall Forrester	2021.02.03		
EUT and Ancillary Equipment IDs	A002965790-010	A002965790-009		
EUT Operation Mode(s)	DTM			
EUT Wireless Configuration(s)	Bluetooth Low Energy (see below for details)			
EUT Hardware Configuration(s)	Mounted in Launchpad. Power from Lab Power Supply.			
Overall Result	PASS			
Test Parameter	Wireless Configuration	Measured Level (dBm)	Limit (dBm)	Result
Emissions at Band Edge (Auth. Band – Low Edge)	Bluetooth Low Energy 1M Low Channel (GFSK 2402 MHz)	-46.09	-19.26	PASS
Emissions at Band Edge (Auth. Band – Low Edge)	Bluetooth Low Energy 2M Low Channel (GFSK 2402 MHz)	-31.15	-19.32	PASS
Emissions at Band Edge (Auth. Band – High Edge)	Bluetooth Low Energy 1M High Channel (GFSK 2480 MHz)	-53.10	-19.08	PASS
Emissions at Band Edge (Auth. Band – High Edge)	Bluetooth Low Energy 2M High Channel (GFSK 2480 MHz)	-51.66	-19.09	PASS

4.4.2 Band Edge Compliance (Authorized Band) – Test Details (Worst Case Plot)

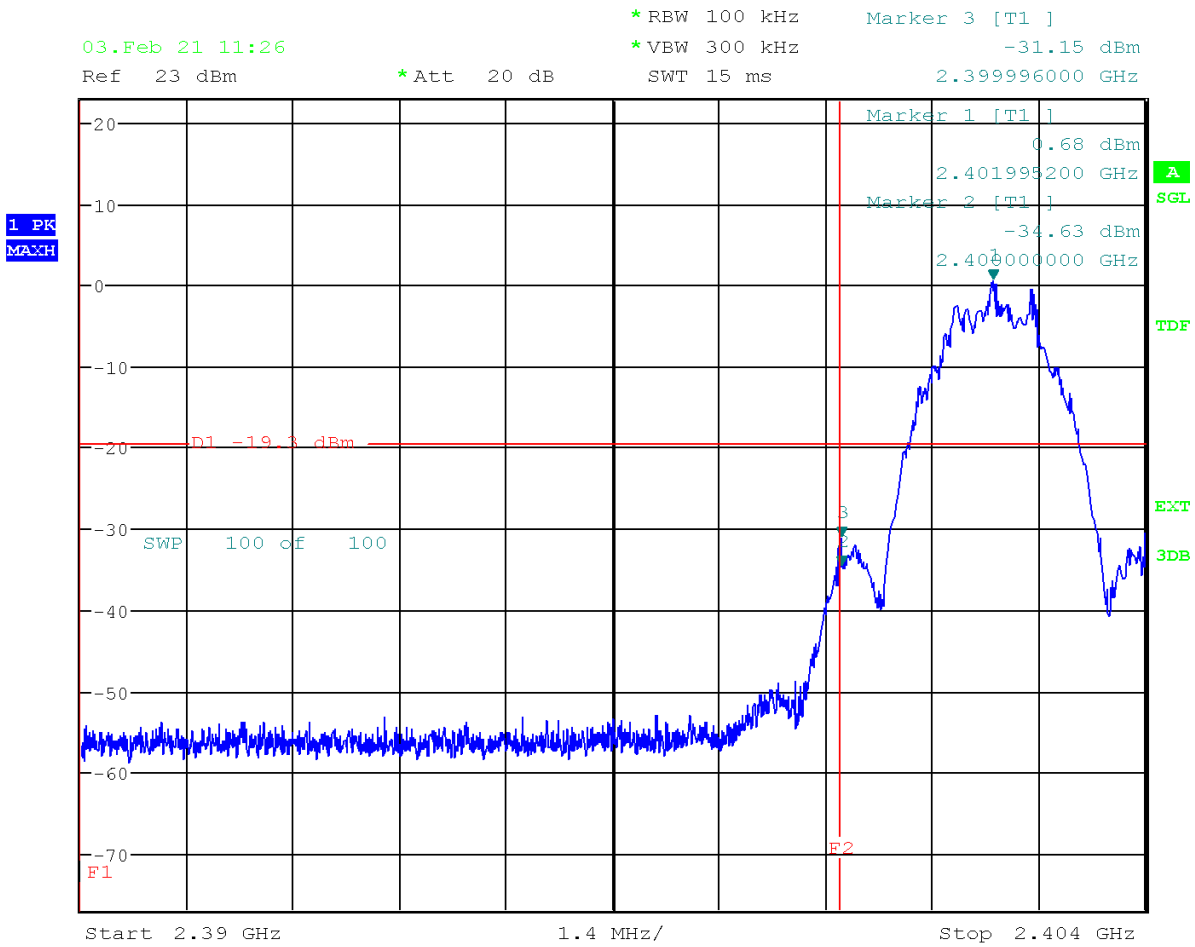

Date: 3.FEB.2021 11:26:16

4.5 Test Results – Band Edge Compliance (Restricted Band)

4.5.1 Band Edge Compliance (Restricted Band) – Test Summary

Test Specification	47 CFR 15.209 & 15.247 (d)	
Test Engineer & Date	Niall Forrester Joel Efraimsson	2020.12.11
EUT and Ancillary Equipment IDs	A002965790-001	-
EUT Operation Mode(s)	Continuous Tx	
EUT Wireless Configuration(s)	Bluetooth Low Energy (see below for details)	
EUT Hardware Configuration(s)	-	
Overall Result	PASS	
Test Parameter	Wireless Configuration	Result*
Emissions at Band Edge (Rest. Band – Low Edge)	Bluetooth Low Energy 1M Low Channel (GFSK 2402 MHz)	PASS
Emissions at Band Edge (Rest. Band – High Edge)	Bluetooth Low Energy 1M High Channel (GFSK 2480 MHz)	PASS

* For detailed measurements, see tables and graphs in sections below

4.5.2 Band Edge Compliance (Restricted Band) – Test Details
Restricted Band – Low Edge

Test mode condition	Bluetooth Low Energy 1M, Low channel (2402 MHz)	
Antenna orientation	Horizontal and Vertical	
Sweep frequency	1 GHz – 18 GHz Lower Band Edge	
Standard	47 CFR FCC Part 15 subpart C	
EUT	A002965790-001	
Ancillary Equipment	-	
Test Engineer	Sam Ebedah	Date: 2020-12-11
Chamber details	Chamber: SAC 5	

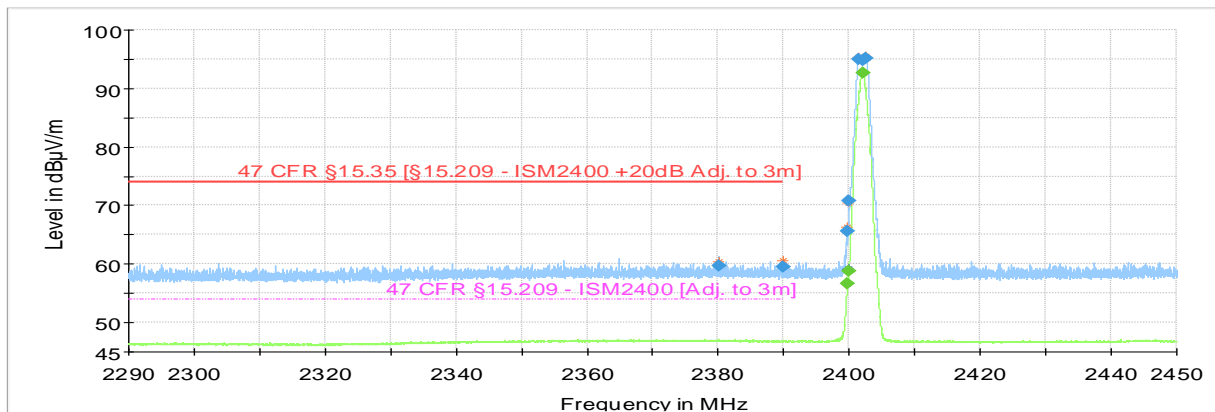

- Preview Result 2-AVG
- Preview Result 1-PK+
- * Critical_Freqs AVG
- * Critical_Freqs PK+
- 47 CFR §15.35 [§15.209 - ISM2400 +20dB Adj. to 3m]
- 47 CFR §15.209 - ISM2400 [Adj. to 3m]
- ◆ Final_Result PK+
- ◆ Final_Result AVG

Frequency (MHz)	MaxPeak (dBµV/m)	Average (dBµV/m)	Limit (dBµV/m)	Margin (dB)	Meas. Time (ms)	Bandwidth (kHz)	Height (cm)	Pol	Azimuth (deg)
2380.160000	---	44.51	53.98	9.47	1000.0	1000.000	210.0	V	318.0
2380.176000	59.66	---	73.98	14.32	1000.0	1000.000	145.0	V	180.0
2390.000000	---	44.37	53.98	9.61	1000.0	1000.000	168.0	V	31.0
2390.000000	59.56	---	73.98	14.42	1000.0	1000.000	203.0	V	190.0
2399.680000	65.58	---	---	---	1000.0	1000.000	169.0	H	338.0
2399.792000	---	56.56	---	---	1000.0	1000.000	205.0	H	339.0
2400.000000	70.89	---	---	---	1000.0	1000.000	169.0	H	351.0
2400.000000	---	58.87	---	---	1000.0	1000.000	203.0	H	338.0
2401.536000	95.04	---	---	---	1000.0	1000.000	204.0	H	341.0
2402.016000	94.77	---	---	---	1000.0	1000.000	203.0	H	345.0
2402.048000	---	92.63	---	---	1000.0	1000.000	210.0	H	0.0
2402.528000	95.10	---	---	---	1000.0	1000.000	156.0	H	347.0

Restricted Band – High Edge

Test mode condition	Bluetooth Low Energy 1M, High channel (2480 MHz)	
Antenna orientation	Horizontal and Vertical	
Sweep frequency	1 GHz – 18 GHz Upper Band Edge	
Standard	47 CFR FCC Part 15 subpart C	
EUT	A002965790-001	
Ancillary Equipment	-	
Test Engineer	Joel Efraimsson	Date: 2020-12-11
Chamber details	Chamber: SAC 5	

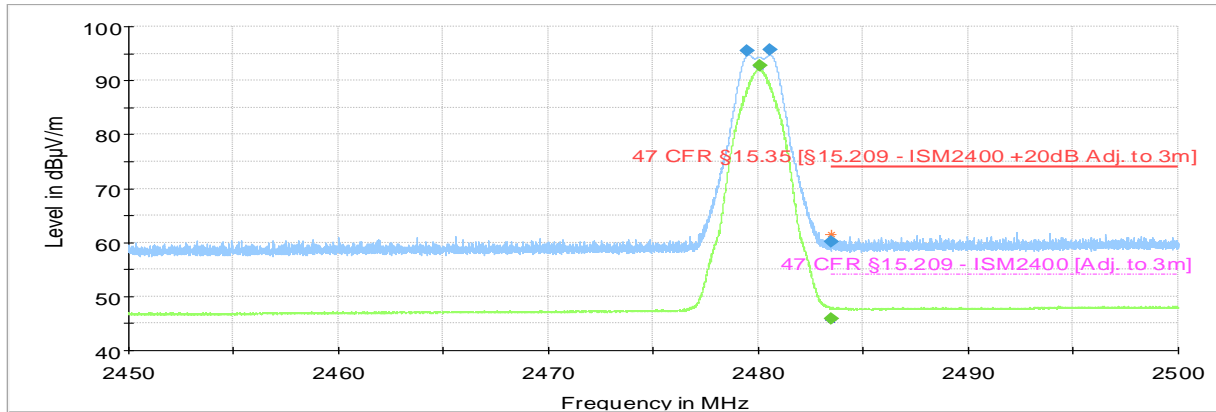

- Preview Result 2-AVG
- Preview Result 1-PK+
- Critical_Freqs AVG
- Critical_Freqs PK+
- 47 CFR §15.35 [§15.209 - ISM2400 +20dB Adj. to 3m]
- 47 CFR §15.209 - ISM2400 [Adj. to 3m]
- Final_Result PK+
- Final_Result AVG

Frequency (MHz)	MaxPeak (dBµV/m)	Average (dBµV/m)	Limit (dBµV/m)	Margin (dB)	Meas. Time (ms)	Bandwidth (kHz)	Height (cm)	Pol	Azimuth (deg)
2479.485000	95.53	---	---	---	1000.0	1000.000	156.0	H	0.0
2480.035000	---	92.71	---	---	1000.0	1000.000	156.0	H	0.0
2480.565000	95.63	---	---	---	1000.0	1000.000	157.0	H	0.0
2483.500000	---	45.81	53.98	8.17	1000.0	1000.000	157.0	H	0.0
2483.500000	60.16	---	73.98	13.82	1000.0	1000.000	101.0	H	268.0

4.6 Test Results – 20dB Bandwidth

4.6.1 20dB Bandwidth – Test Summary

Requirement is not applicable as the device is non-hopping

4.7 Test Results – Carrier (Hopping Channel) Separation

4.7.1 Carrier (Hopping Channel) Separation – Test Summary

Requirement is not applicable as the device is non-hopping

4.8 Test Results – Number of Hopping Channels

4.8.1 Number of Hopping Channels – Test Summary

Requirement is not applicable as the device is non-hopping

4.9 Test Results – Time of Occupancy (Dwell Time)

4.9.1 Time of Occupancy (Dwell Time) – Test Summary

Requirement is not applicable as the device is non-hopping

4.10 Test Results – 6dB Bandwidth

4.10.1 6dB Bandwidth – Test Summary

Test Specification	47 CFR 15.247 (a)(2)			
Test Engineer & Date	Niall Forrester	2021.02.03		
EUT and Ancillary Equipment IDs	A002965790-010	A002965790-009		
EUT Operation Mode(s)	DTM			
EUT Wireless Configuration(s)	Bluetooth Low Energy (see below for details)			
EUT Hardware Configuration(s)	Mounted in Launchpad. Power from Lab Power Supply.			
Overall Result	PASS			
Test Parameter	Wireless Configuration	Measured Level (kHz)	Limit Min (kHz)	Result
6dB Bandwidth	Bluetooth Low Energy 1M Low Channel (GFSK 2402 MHz)	672.00	500	PASS
6dB Bandwidth	Bluetooth Low Energy 2M Low Channel (GFSK 2402 MHz)	532.80	500	PASS
6dB Bandwidth	Bluetooth Low Energy 1M Mid Channel (GFSK 2440 MHz)	681.60	500	PASS
6dB Bandwidth	Bluetooth Low Energy 2M Mid Channel (GFSK 2440 MHz)	628.80	500	PASS
6dB Bandwidth	Bluetooth Low Energy 1M High Channel (GFSK 2480 MHz)	672.00	500	PASS
6dB Bandwidth	Bluetooth Low Energy 2M High Channel (GFSK 2480 MHz)	950.40	500	PASS

4.10.2 6dB Bandwidth – Test Details (Worst Case Plot)

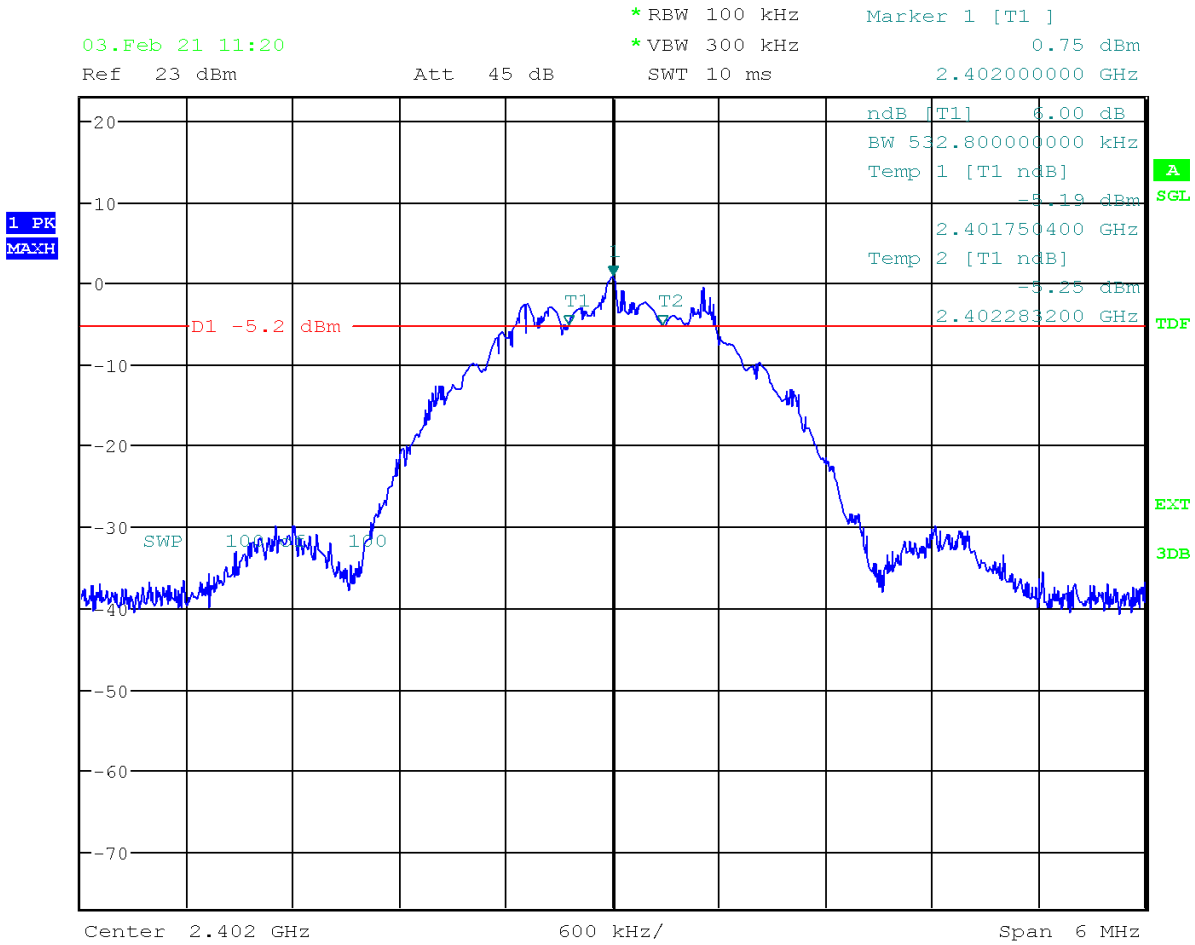

Date: 3.FEB.2021 11:20:06

4.11 Test Results – Peak Conducted Output Power

4.11.1 Peak Conducted Output Power – Test Summary

Test Specification	47 CFR 15.247(b)	
Test Engineer & Date	Niall Forrester	2021.02.03 - 2021.02.04
EUT and Ancillary Equipment IDs	A002965790-010	A002965790-009
EUT Operation Mode(s)	DTM	
EUT Wireless Configuration(s)	Bluetooth Low Energy (see below for details)	
EUT Hardware Configuration(s)	Mounted in Launchpad. Power from Lab Power Supply.	
Overall Result	PASS	

Test Parameter	Wireless Configuration	Measured Level (dBm)			Limit (dBm)	Result
		Low 2.4V	Nom 3.7V	High 5.5V		
Peak Conducted Output Power	Bluetooth Low Energy 1M Low Channel (GFSK 2402 MHz)	1.25	1.22	1.23	30	PASS
Peak Conducted Output Power	Bluetooth Low Energy 2M Low Channel (GFSK 2402 MHz)	1.32	1.25	1.30	30	PASS
Peak Conducted Output Power	Bluetooth Low Energy 1M Mid Channel (GFSK 2440 MHz)	0.72	0.76	0.76	30	PASS
Peak Conducted Output Power	Bluetooth Low Energy 2M Mid Channel (GFSK 2440 MHz)	0.78	0.80	0.80	30	PASS
Peak Conducted Output Power	Bluetooth Low Energy 1M High Channel (GFSK 2480 MHz)	1.37	1.40	1.39	30	PASS
Peak Conducted Output Power	Bluetooth Low Energy 2M High Channel (GFSK 2480 MHz)	1.51	1.44	1.51	30	PASS

4.11.2 Peak Conducted Output Power – Test Details (Worst Case Plots)
BLE 2M – Low Channel – Low Voltage

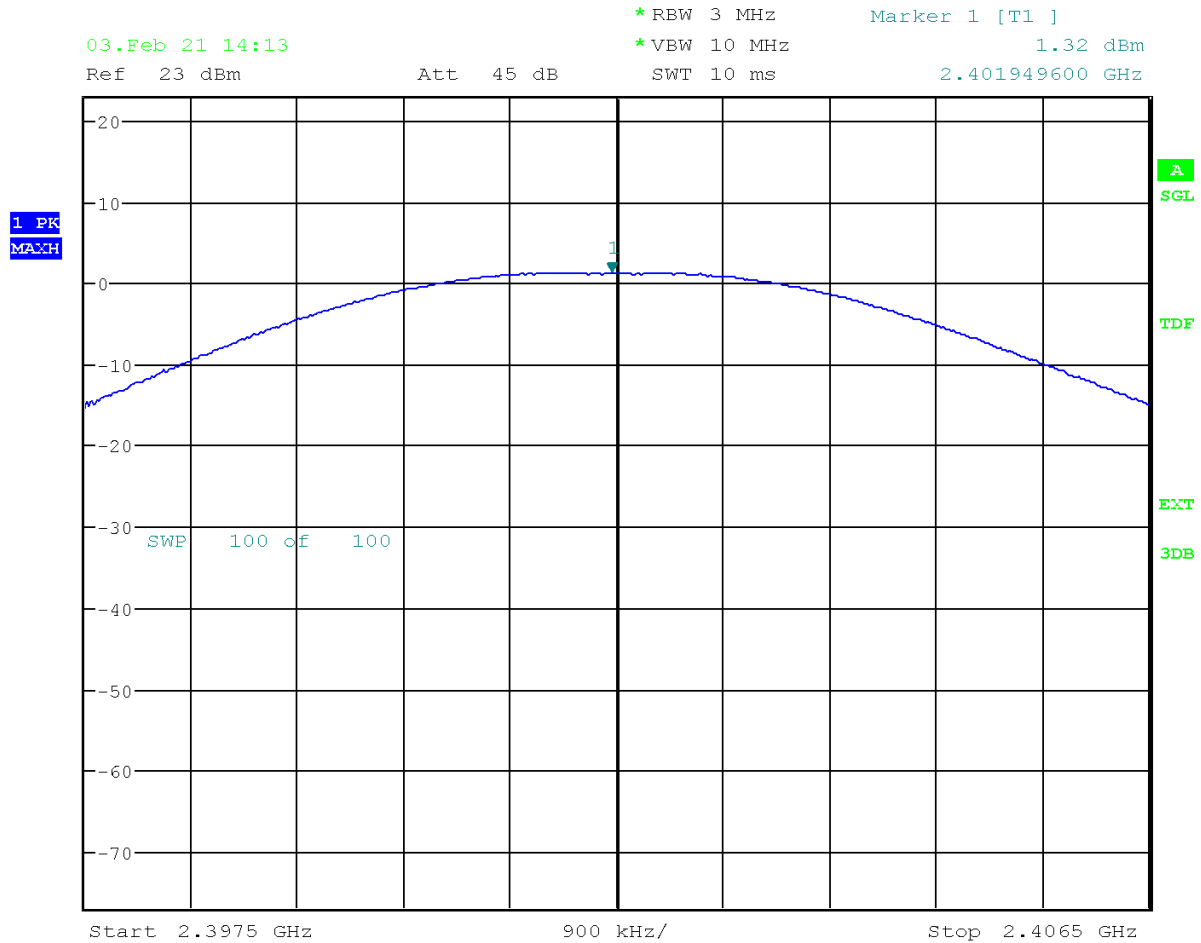

Date: 3.FEB.2021 14:13:13

BLE 2M – Mid Channel – Nominal Voltage

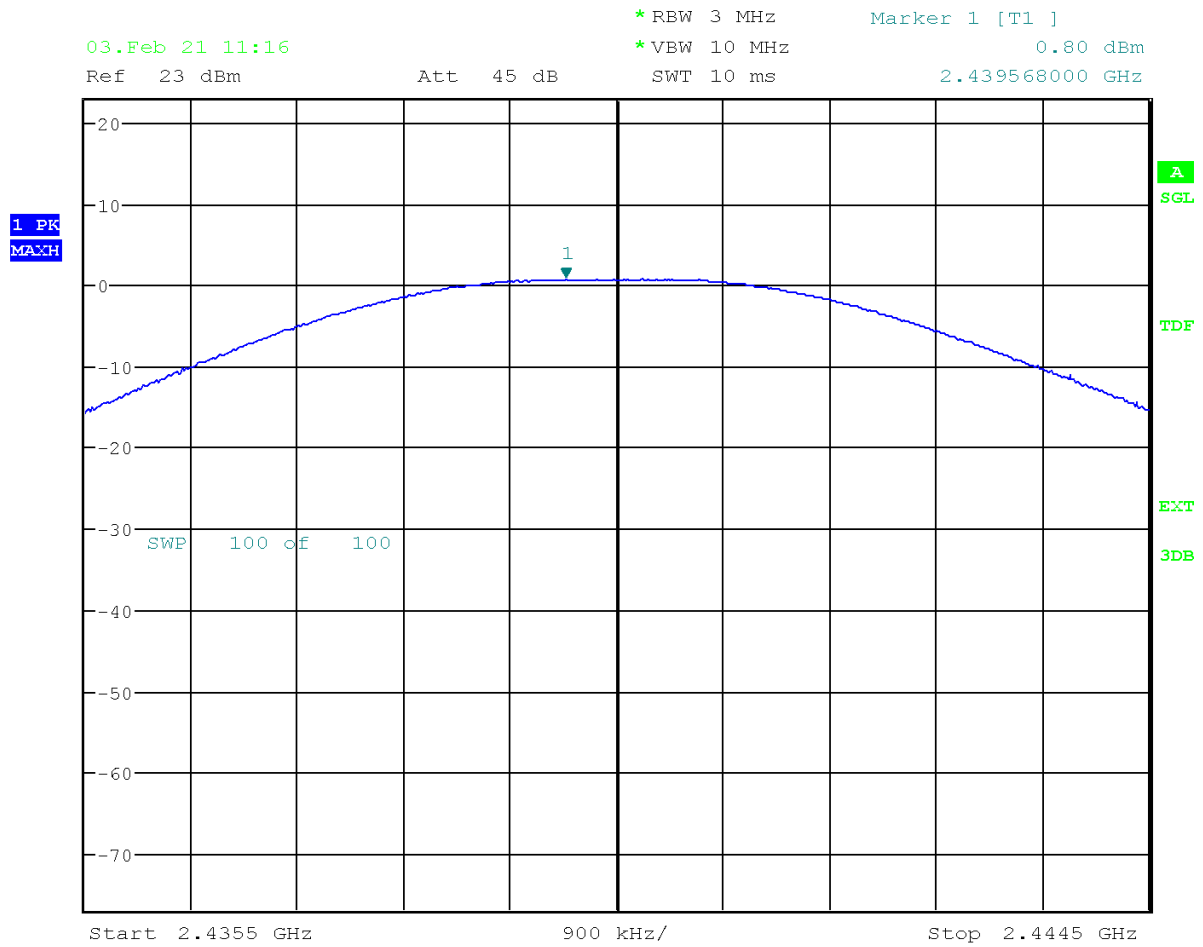

Date: 3.FEB.2021 11:16:58

BLE 2M – High Channel – Low Voltage

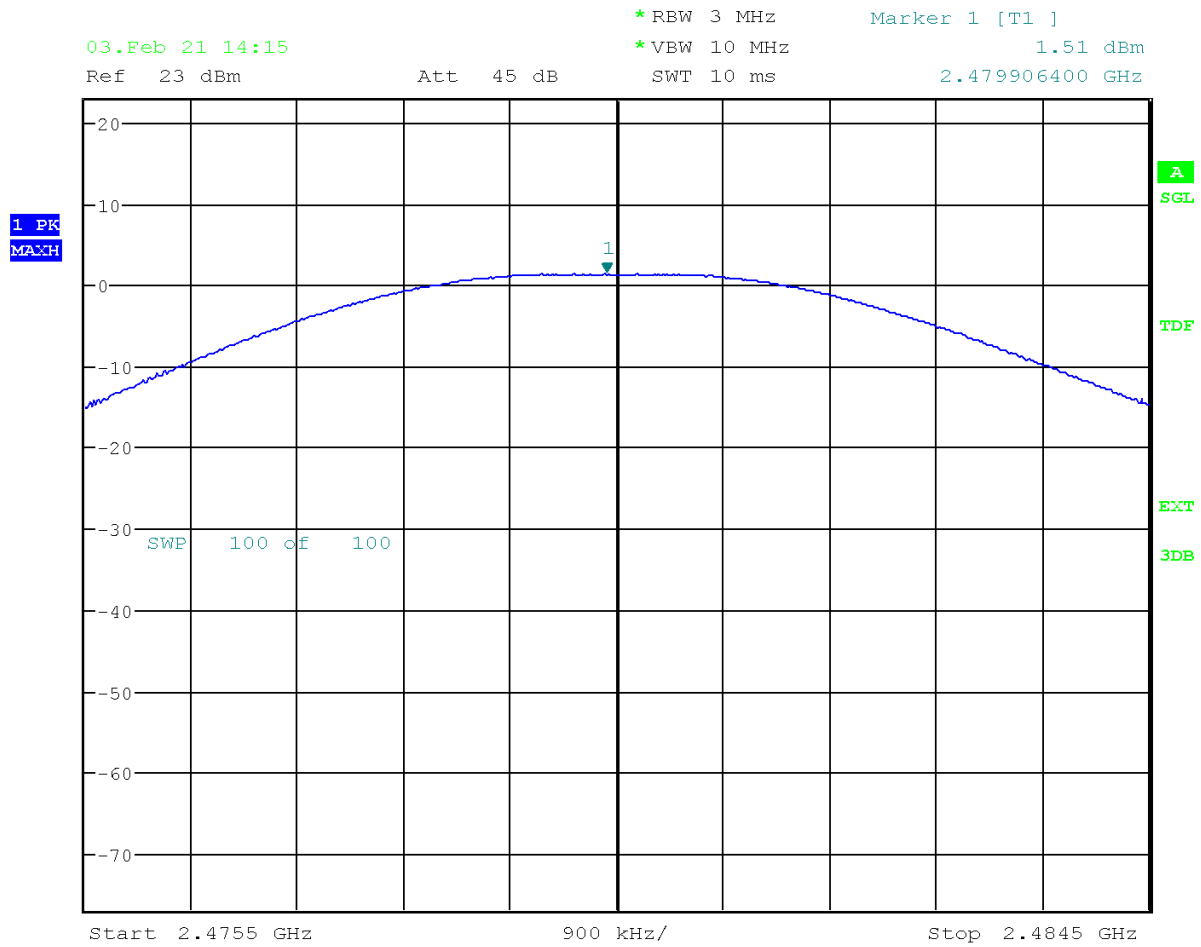

Date: 3.FEB.2021 14:15:54

4.12 Test Results – Power Spectral Density

4.12.1 Power Spectral Density – Test Summary

Test Specification	47 CFR 15.247(e)				
Test Engineer & Date	Niall Forrester		2021.02.03		
EUT and Ancillary Equipment IDs	A002965790-010		A002965790-009		
EUT Operation Mode(s)	DTM				
EUT Wireless Configuration(s)	Bluetooth Low Energy (see below for details)				
EUT Hardware Configuration(s)	Mounted in Launchpad. Power from Lab Power Supply.				
Overall Result	PASS				
Test Parameter	Wireless Configuration	Measured (dBm/3kHz)	Low Limit (dBm/3kHz)	High Limit (dBm/3kHz)	Result
Power Density	Bluetooth Low Energy 1M Low Channel (GFSK 2402 MHz)	-14.74	-30	8	PASS
Power Density	Bluetooth Low Energy 2M Low Channel (GFSK 2402 MHz)	-16.56	-30	8	PASS
Power Density	Bluetooth Low Energy 1M Mid Channel (GFSK 2440 MHz)	-15.38	-30	8	PASS
Power Density	Bluetooth Low Energy 2M Mid Channel (GFSK 2440 MHz)	-17.15	-30	8	PASS
Power Density	Bluetooth Low Energy 1M High Channel (GFSK 2480 MHz)	-14.91	-30	8	PASS
Power Density	Bluetooth Low Energy 2M High Channel (GFSK 2480 MHz)	-15.79	-30	8	PASS

4.12.2 Power Spectral Density – Test Details

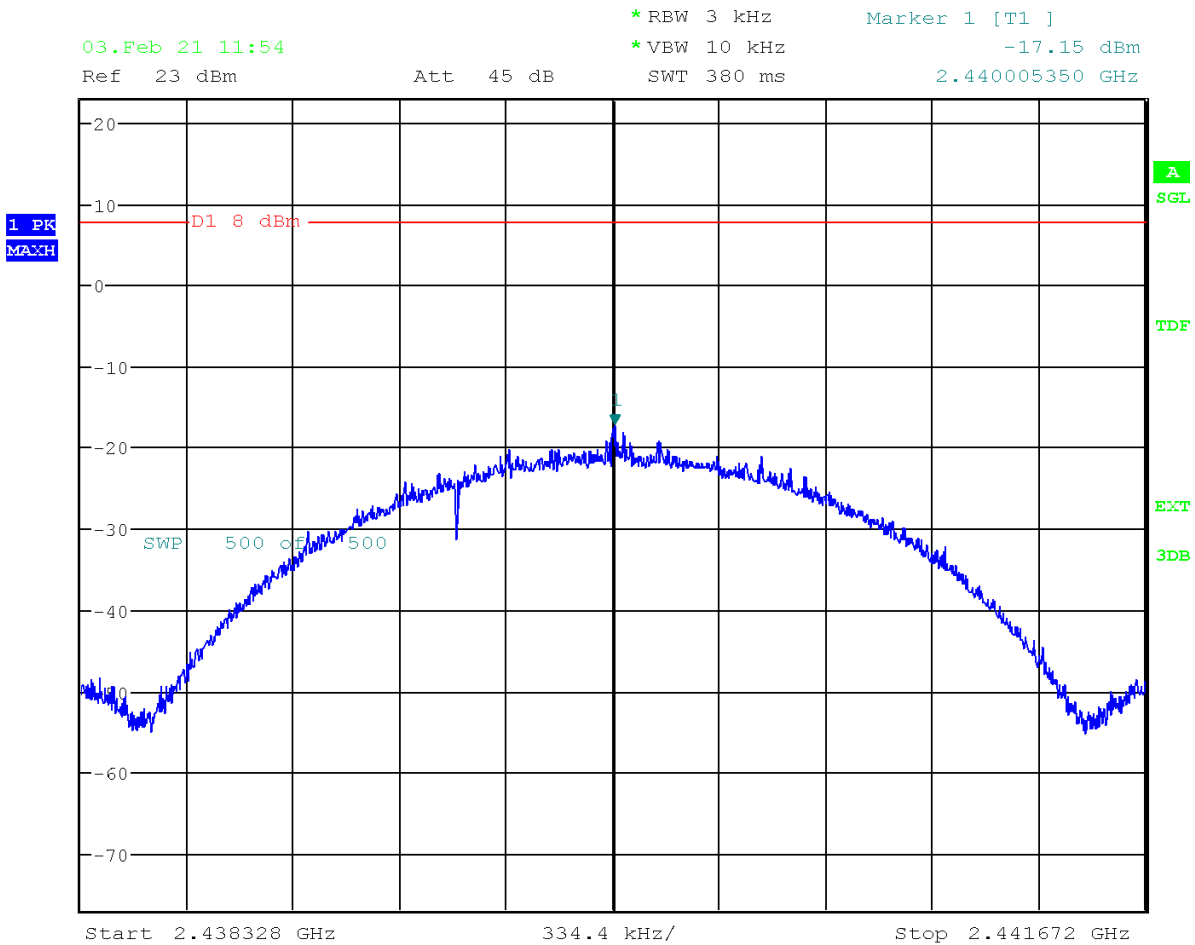

Date: 3.FEB.2021 11:54:58

5. TEST EQUIPMENT STATUS

5.1 List of Hardware with Calibration Dates

5.1.1 Hardware List – CTE System

Type	Manufacturer	Model	Serial Number / ID	Calibration Date	Calibration Due
Comprehensive Testing Environment	TÜV Rheinland LGA Products	HWE 6000	00139	N/A	N/A
Bluetooth Signaling Unit	Rohde & Schwarz	CMW500	163750 2711468	16.07.2020	16.07.2021
Spectrum Analyzer	Rohde & Schwarz	FSU26	100308 2704108	14.07.2020	14.07.2021
Vector Signal Generator	Rohde & Schwarz	SMU200A	101584 2704111	04.08.2020	04.08.2021
Power Supply	Keithley	2303	1198722 2717714	24.07.2020	24.07.2021
Multimeter	Keithley	2700	1035251 2704115	09.07.2020	09.07.2021
Average Power Sensor	Rohde & Schwarz	NRP-Z31	102145 2704104	17.07.2020	17.07.2021
Temperature Chamber	Vötsch	VT4002	58566081940010 2717693	N/A	N/A
Temp. & Humidity Logger	Lufft	Opus 20	113.0118.0802.033 2771025	31.07.2020	31.07.2022

5.1.2 Hardware List – Conducted Emissions System

Type	Manufacturer	Model	Serial Number / ID	Calibration Date	Calibration Due
Two-Line V-network	Rohde & Schwarz	ENV216	101090 2704076	2020.07.16	2021.07.16
Test Receiver 9KHz to 3.5 GHz	Rohde & Schwarz	ESR3	101674 2704016	2020.07.17	2021.07.17

5.1.3 Hardware List – SAC5 System

Type	Manufacturer	Model	Serial Number / ID	Calibration Date	Calibration Due
EMI Test Receiver	Rohde & Schwarz	ESW44	101760 2881044	2020.07.17	2021.07.17
Ultra Broadband Antenna	Rohde & Schwarz	HL562E	100988 2823181	2019.07.23	2021.07.23
Double Ridged Waveguide Horn Antenna	Rohde & Schwarz	HF907	102678 2823164	2019.07.15	2021.07.15
Control Device	Maturo	NCD	NCD/393/2372.01	N/A	N/A
Open Switch & Control Unit	Rohde & Schwarz	OSP150	100081 2884198	2020.08.04	2021.08.04
Open Switch & Control Unit	Rohde & Schwarz	OSP120	100084 2761253	2020.08.04	2021.08.04
Shielded Filter Unit	Rohde & Schwarz	OSP-F Extension 1	101333 2761265	2020.08.04	2021.08.04
Shielded Filter Unit	Rohde & Schwarz	OSP-F Extension 2	101335 2761266	2020.08.04	2021.08.04
Shielded Filter Unit	Rohde & Schwarz	OSP-F Base Unit	101330 2761262	2020.08.04	2021.08.04
Humidity Temperature Probe	Lufft	OPUS 20	1236.0118.0802.033 2771042	2020.07.31	2022.07.31

5.2 Software / Firmware Versions

Equipment	Software / Firmware Name	Version
Comprehensive Testing Environment (CTE)	CTE – TMF CTE – WLAN	V47.5 V41.5
Conducted Emissions System	EMC 32	V10.60.10
SAC 5	EMC 32	V10.60.10

6. MEASUREMENT UNCERTAINTY

6.1 Measurement Uncertainty for CTE

Parameter	Uncertainty (Coverage Factor k=2)
Maximum Output Power (15.247b)	±0.51 dB
6dB / 20dB Channel Bandwidth & 99% Occupied bandwidth (15.247a)	<5%
Carrier Frequency Separation (15.247a)	N/A
Number of Hopping Channels (15.247a)	N/A
Time of Occupancy – Dwell Time (15.247a)	N/A
Band Edge Compliance of Conducted Emissions (15.247a)	±1.04 dB
Conducted Spurious Emissions (15.247d)	±2.98 dB
Power Spectral Density (15.247e)	±0.51 dB

6.2 Measurement Uncertainty for Conducted Emissions

Parameter	Uncertainty (Coverage Factor k=2)
Conducted emissions with LISN 150KHz to 30 MHz	2.98 dB

6.3 Measurement Uncertainty for SAC 5 (Radiated Emissions & Band Edge)

Parameter	Uncertainty (Coverage Factor k=2)
Field Strength 10 Hz -9 kHz	3.38 dB
Field Strength 9 kHz -30 MHz	3.38 dB
Field Strength 30 MHz -1000 MHz	3.38 dB
Field Strength 1 GHz -18 GHz	4.88 dB
Field Strength 18 GHz - 40 GHz	5.14 dB

7. PHOTOGRAPHS

For photographs, see Appendix 1