

<b>Prüfbericht-Nr.:</b> <i>Test report no.:</i>	<b>60440956-003</b>	<b>Auftrags-Nr.:</b> <i>Order no.:</i>	23870481 030	Seite 1 von 54 <i>Page 1 of 54</i>
<b>Kunden-Referenz-Nr.:</b> <i>Client reference no.:</i>	2311184	<b>Auftragsdatum:</b> <i>Order date:</i>	2020.12.09	
<b>Auftraggeber:</b> <i>Client:</i>	Wittra Sweden AB			
<b>Prüfgegenstand:</b> <i>Test item:</i>	Wireless Asset Tag			
<b>Bezeichnung / Typ-Nr.:</b> <i>Identification / Type no.:</i>	Mesh Router 1.0 US / FCC ID:2AYHX00349			
<b>Auftrags-Inhalt:</b> <i>Order content:</i>	Accredited testing according to FCC Part 15C			
<b>Prüfgrundlage:</b> <i>Test specification:</i>	FCC 47 CFR Part 15.247 with parts 15.207 & 15.209 ANSI C63.10: 2013			
<b>Wareneingangsdatum:</b> <i>Date of sample receipt:</i>	2020.12.09			
<b>Prüfmuster-Nr.:</b> <i>Test sample no.:</i>	See section 2.3			
<b>Prüfzeitraum:</b> <i>Testing period:</i>	2020.12.18 – 2021.06.24			
<b>Ort der Prüfung:</b> <i>Place of testing:</i>	Lund, Sweden			
<b>Prüflaboratorium:</b> <i>Testing laboratory:</i>	TÜV Rheinland Sweden			
<b>Prüfergebnis*:</b> <i>Test result*:</i>	Pass			
<b>überprüft von:</b> <i>reviewed by:</i>		<b>genehmigt von:</b> <i>authorized by:</i>		
<b>Datum:</b> 2021.06.24 <i>Date:</i>	Signed by: Niall Forrester	<b>Datum:</b> 2021.06.24 <i>Date:</i>	Signed by: Per Isacson	
<b>Stellung / Position:</b>	<b>Senior</b> Technical Expert	<b>Stellung / Position:</b>	Lab Manager	
<b>Sonstiges / Other:</b>	Note: This reports contains information for "Sub-GHz" IEEE 802.15.4g proprietary radio measurements only. Testing was performed on "Sensor tag 1.0" devices (FCC ID 2AYHX00348) which are functionally and electronically identical to the Mesh Router (FCC ID 2AYHX00349) for the purposes of the testing in this report			
<b>Zustand des Prüfgegenstandes bei Anlieferung:</b> <i>Condition of the test item at delivery:</i>	Prüfmuster vollständig und unbeschädigt <i>Test item complete and undamaged</i>			
* Legende:	1 = sehr gut P(ass) = entspricht o.g. Prüfgrundlage(n)	2 = gut F(ail) = entspricht nicht o.g. Prüfgrundlage(n)	3 = befriedigend N/A = nicht anwendbar	4 = ausreichend N/T = nicht getestet
* Legend:	1 = very good P(ass) = passed a.m. test specification(s)	2 = good F(ail) = failed a.m. test specification(s)	3 = satisfactory N/A = not applicable	4 = sufficient N/T = not tested
<b>Dieser Prüfbericht bezieht sich nur auf das o.g. Prüfmuster und darf ohne Genehmigung der Prüfstelle nicht auszugsweise vervielfältigt werden. Dieser Bericht berechtigt nicht zur Verwendung eines Prüfzeichens.</b> <i>This test report only relates to the a. m. test sample. Without permission of the test center this test report is not permitted to be duplicated in extracts.</i>				

## Revision History 60440956-00360440956-003

REVISION	DATE	REMARKS	AUTHOR
001	2021.04.16	First Release	Niall Forrester
002	2021.05.12	Corrected tables 4.1.2, 4.7.1 images in 4.2.2, 4.7.2 & added plots to section 4.11.2	Niall Forrester
003	2021.06.24	Corrected gain figures, 20dB BW and typos	Niall Forrester

Note: Latest revision report will replace all previous reports

This report based on FCC Part 15.247 Template version 1.2

## Summary of Test Results

FCC 47 CFR Rule Part	Test Description	Applicability	Report Section	RESULT	REMARKS
15.207	AC Power Line Conducted Emissions (Intentional Radiators)	YES	4.1	PASS	
15.209	Radiated Emissions (Intentional Radiators)	YES	4.2	PASS	
15.247 (d)	Antenna Conducted Emissions	NO	4.3	N/A	Radiated testing performed
15.247 (d)	Band Edge Compliance (Authorized Band)	YES	4.4	PASS	
15.247 (d)	Band Edge Compliance (Restricted Band)	YES	4.5	PASS	
15.247 (a)(1)	20dB Bandwidth	YES	4.6	PASS	
15.247 (a)(1)	Carrier (Hopping Channel) Separation	YES	4.7	PASS	
15.247 (a)(1)	Number of Hopping Channels	YES	4.8	PASS	
15.247 (a)(1)	Time of Occupancy (Dwell Time)	YES	4.9	PASS	
15.247 (a)(2)	6dB Bandwidth	NO	4.12	N/A	Frequency Hopping Device
15.247 (b)	Peak Conducted Output Power	YES	4.11	PASS	
15.247 (e)	Power Spectral Density	NO	4.14	N/A	Frequency Hopping Device

Possible test case verdicts:

- Test case does not apply to the test object: N/A
- Test object complies with the requirement: PASS or COMPLIANT
- Test object does not meet the requirement: FAIL or NOT COMPLIANT
- Test case not performed on the test object: N.P.

## Table of Contents

1.	GENERAL INFORMATION	4
1.1	Test Site	4
1.2	Client Information	4
2.	PRODUCT INFORMATION	5
2.1	General Description	5
2.2	Device Characteristics	5
2.3	Test Samples	5
2.4	Wireless Technologies and Bands Supported by the EUT	5
2.5	Antenna Information	6
2.6	Simultaneous Transmissions	6
2.7	Wireless Technology Details	6
2.8	Ancillary Equipment	6
2.9	EUT Diagrams	6
3.	TEST METHODS	7
3.1	Test Standards	7
3.2	Additional references	7
3.3	Limits	8
3.4	Description of Test Methods and Equipment Setup	9
3.5	EUT Configuration During Test	13
3.6	EUT Operation Modes	13
3.7	Deviations from the Test Standard	13
3.8	Environmental Conditions	14
4.	TEST RESULTS	15
4.1	Test Results – AC Power Line Conducted Emissions (Intentional Transmitter)	15
4.2	Test Results – Radiated Emissions (Intentional Transmitter)	18
4.3	Test Results – Antenna Conducted Emissions	34
4.4	Test Results – Band Edge Compliance (Authorized Band)	34
4.5	Test Results – Band Edge Compliance (Restricted Band)	38
4.6	Test Results – 20dB Bandwidth	41
4.7	Test Results – Carrier (Hopping Channel) Separation	43
4.8	Test Results – Number of Hopping Channels	45
4.9	Test Results – Time of Occupancy (Dwell Time)	46
4.10	Test Results – 6dB Bandwidth	47
4.11	Test Results – Peak Conducted Output Power	48
4.12	Test Results – Power Spectral Density	51
5.	TEST EQUIPMENT STATUS	52
5.1	List of Hardware with Calibration Dates	52
5.2	Software / Firmware Versions	53
6.	MEASUREMENT UNCERTAINTY	53
6.1	Measurement Uncertainty for Conducted RF	53
6.2	Measurement Uncertainty for Conducted Emissions	53
6.3	Measurement Uncertainty for SAC 5 (Radiated Emissions & Band Edge)	54
7.	PHOTOGRAPHS	54

## 1. GENERAL INFORMATION

### 1.1 Test Site

Test Facility:	TÜV Rheinland Sweden AB
Address:	Mobilvägen 10
	223 62 Lund
	Sweden
Swedac Registration Number:	10325
FCC Test Firm Registration Number:	517458
ISED Test Site Registration Number:	24753

### 1.2 Client Information

Company Name:	Wittra Sweden AB
Address:	Rosenlundsgatan 40 OTR
	118 53 Stockholm
	Sweden
Contact Person:	Warwick Taws
Contact e-Mail / Telephone	wat@wittra.se

## 2. PRODUCT INFORMATION

### 2.1 General Description

<b>Model name:</b>	Mesh Router 1.0 US
<b>Manufacturer:</b>	TT Electronics PLC
<b>Model number / Marketing name:</b>	Mesh Router 1.0 US
<b>FCC ID:</b>	2AYHX00349
<b>Description:</b>	Wireless Asset Tag
<b>Ancillary Equipment:</b>	See section 2.8

### 2.2 Device Characteristics

<b>Type of Power Supply</b>	Battery
<b>Nominal Supply Voltage</b>	3.7 VDC
<b>Supply Voltage Range</b>	2.4 VDC – 5.5 VDC
<b>Operating Temperature Range</b>	-30°C – 85°C
<b>Operating Air Humidity Range</b>	0% – 100% RH
<b>Highest Internal Frequency Source</b>	2483.5 MHz

### 2.3 Test Samples

EUT #	EUT ID	Description	Used For:
1	A002972080-001	Sensor Tag 1.0 Standard Sample	Conducted Emissions Radiated Emissions
2	A002965790-011	Sensor Tag 1.0 Modified with RF connector and	Conducted RF
3	A003002493-001	Sensor Tag 1.0 Modified with RF connector	Conducted RF

Note that testing was performed on “Sensor tag 1.0” devices (FCC ID 2AYHX00348) which are functionally and electronically identical to the Mesh Router (FCC ID 2AYHX00349) for the purposes of the testing in this report

### 2.4 Wireless Technologies and Bands Supported by the EUT

Technology	Band	Frequency Range (Tx)	Evaluation Performed*
IEEE 802.15.4g	902-928 MHz	902.0 MHz - 928.0 MHz	YES
Bluetooth LE	2.4 GHz	2400.0 MHz - 2483.5 MHz	NO

\*This statement refers only to this report. Other wireless technologies may be covered by other reports.

## 2.5 Antenna Information

Technology	Band	Number of Antennas	Antenna Type(s)	Gain
IEEE 802.15.4g	902-928 MHz	1	Printed foil 50Ω	-4.71
Bluetooth LE	2.4 GHz	1	Printed foil 50Ω	1.40

## 2.6 Simultaneous Transmissions

The device supports NO simultaneous transmission configurations. The Bluetooth Low Energy and IEEE 802.15.4 “Sub-GHz” transmitters cannot be transmit at the same time

## 2.7 Wireless Technology Details

Technology	Band	Modulation Type(s)	No. of Channels	Channel Spacing	Adaptivity
IEEE 802.15.4g	902-928 MHz	2-GFSK	129	0.2 MHz	N/A
Bluetooth LE	2.4 GHz	GFSK	40	2 MHz	N/A

## 2.8 Ancillary Equipment

ID	Description	Manufacturer / Model	Hardware & Software Versions
A002972080-007	USB Charger	Power Pax P2620	-

## 2.9 EUT Diagrams

-

### 3. TEST METHODS

#### 3.1 Test Standards

Testing was performed according to the following standards / references

Standard	Version	Description
FCC 47 CFR 15.247	-	Operation within the bands 902-928 MHz, 2400-2483.5 MHz, and 5725-5850 MHz.
FCC 47 CFR 15.207	-	Conducted limits
FCC 47 CFR 15.209	-	Radiated emission limits; general requirements

#### 3.2 Additional references

The following standards / references were also considered for the testing

Standard	Version	Description
ANSI C63.10	2013	American National Standard of Procedures for Compliance Testing of Unlicensed Wireless Devices

### 3.3 Limits

FCC 47 CFR Rule Part	Test Description	Limit Reference (FCC 47 CFR Reference)
15.207	AC Power Line Conducted Emissions (Intentional Radiators)	15.207 (a)
15.209	Radiated Emissions (Intentional Radiators)	15.209 (a) *See Note 1
15.247 (d)	Antenna Conducted Emissions	15.247 (d)
15.247 (d)	Band Edge Compliance (Authorized Band)	15.247 (d)
15.247 (d)	Band Edge Compliance (Restricted Band)	15.247 (d)
15.247 (a)(1)	20dB Bandwidth	15.247 (a)(1)
15.247 (a)(1)	Carrier (Hopping Channel) Separation	15.247 (a)(1)
15.247 (a)(1)	Number of Hopping Channels	15.247 (a)(1)
15.247 (a)(1)	Time of Occupancy (Dwell Time)	15.247 (a)(1)
15.247 (a)(2)	6dB Bandwidth	15.247 (a)(2)
15.247 (b)	Peak Conducted Output Power	15.247 (b)(1) [Hopping] 15.247 (b)(3) [Non-Hopping]
15.247 (e)	Power Spectral Density	15.247 (e)

Interpretation of the measurement results has been performed in accordance with ANSI C63.10 section 1.3

Compliance with the requirements has been based on the results of the measurements compared to the specified limits, not taking into account measurement instrumentation uncertainty.

Measurement Uncertainty figures are stated in section 6

#### Note 1

Radiated Emissions limits in the tables from 47 CFR sections 15.109 & 15.209 are presented in  $\mu\text{V}/\text{m}$ . Measurements on the test system are made in  $\text{dB}\mu\text{V}/\text{m}$ . To convert between these, the following adjustment is used:

$$\text{New Limit} = 20 \log \left( \frac{\text{Original Limit}}{10^6} \right) + 120$$

Example: from 15.209(a) the limit for 30MHz – 88MHz is  $100\mu\text{V}/\text{m}$  at 3m. This gives:

$$\text{New Limit} = 20 \log \left( \frac{100}{10^6} \right) + 120 = 40\text{dB}\mu\text{V}/\text{m} \text{ at } 3\text{m}$$

Additionally, in some cases testing has been performed at distances other than those specified in the tables. When this has occurred, the limits have been adjusted in accordance with the requirements in 47 CFR 15.31, using an extrapolation factor of 40dB/decade at frequencies below 30MHz and 20dB/decade at or above 30MHz

Example: from 15.209(a) the limit for 1.705MHz – 30MHz is  $30\mu\text{V}/\text{m}$  (=29.54  $\text{dB}\mu\text{V}/\text{m}$ ) at 30m

$$\text{Limit@3m} = \text{Limit@30m} + 40 \log \left( \frac{30}{3} \right) = 29.54 + 40.00 = 69.54 \text{ dB}\mu\text{V}/\text{m} \text{ at } 3\text{m}$$

Example: from 15.209(a) the limit for 1GHz – 18GHz is  $500\mu\text{V}/\text{m}$  (=53.98  $\text{dB}\mu\text{V}/\text{m}$ ) at 3m

$$\text{Limit@1m} = \text{Limit@3m} + 20 \log \left( \frac{3}{1} \right) = 53.98 + 9.54 = 63.52 \text{ dB}\mu\text{V}/\text{m} \text{ at } 1\text{m}$$



### 3.4 Description of Test Methods and Equipment Setup

#### 3.4.1 General Description

Testing was performed in accordance with the various requirements of ANSI C63.4 and ANSI C63.10. Any deviations from the test methods are described in section 3.7

Where different arrangements of equipment were used for different types of measurements, these are tabulated in section 3.4.2 and details of each arrangement are included in subsequent sections

#### 3.4.2 Test Equipment Setup Used by Test Type

FCC 47 CFR Rule Part	Test Description	Test Equipment Used
15.207	AC Power Line Conducted Emissions (Intentional Radiators)	Conducted Emissions
15.209	Radiated Emissions (Intentional Radiators)	SAC5
15.247 (d)	Antenna Conducted Emissions	Conducted RF
15.247 (d)	Band Edge Compliance (Authorized band)	Conducted RF
15.247 (d)	Band Edge Compliance (Restricted band)	SAC 5
15.247 (a)(1)	20dB Bandwidth	Conducted RF
15.247 (a)(1)	Carrier (Hopping Channel) Separation	Conducted RF
15.247 (a)(1)	Number of Hopping Channels	Conducted RF
15.247 (a)(1)	Time of Occupancy (Dwell Time)	Conducted RF
15.247 (a)(2)	6dB Bandwidth	Conducted RF
15.247 (b)	Peak Conducted Output Power	Conducted RF
15.247 (e)	Power Spectral Density	Conducted RF

### 3.4.3 Test Equipment Setup – Conducted RF

For the purposes of the testing in the report, the conducted RF system consists of a Spectrum Analyzer with suitable cabling and a controller PC. The DUT is connected to the Spectrum analyser RF input and the loss in the connecting cable is compensate for in the reported results. The tests are either script based (using dedicated software on the controller PC), or in some cases manual measurements are made directly using the spectrum analyser interface.

### 3.4.4 Test Equipment Setup – Conducted Emissions

- The EUT was placed 0.4 meters from the conducting wall of the shielded room with EUT being connected to the power mains through a line impedance stabilization network (LISN). Other support units were connected to the power mains through another LISN. The LISNs provide  $50\Omega/50\mu\text{H}$  of coupling impedance for the measuring instrument.
- The lines of the power mains connected to the EUT were checked for maximum conducted interference.
- The frequency range from 150 kHz to 30 MHz was searched. Emission levels over 10 dB under the prescribed limits could not be reported.

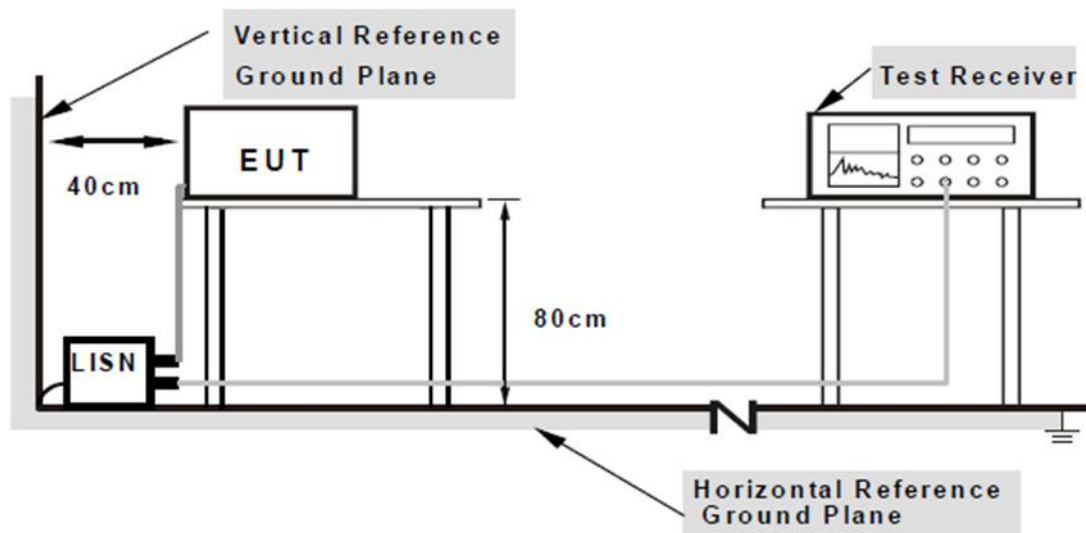

### 3.4.5 Test Equipment Setup – SAC 5 (Radiated Emissions and Restricted Band Edge)

- For frequency range 30MHz-1GHz Log-Periodic Antenna was used. Antenna elevated from 100 cm from floor to 400 cm from floor, and was placed at 3 m from center of turntable in tilted position. The equipment under test (EUT) was placed at the middle of the turntable at 150 cm height from floor. The antenna rotated to repeat the measurements for both the horizontal and vertical antenna polarizations. Repeat the measurement steps until the maximum emissions were obtained.
- For frequency range 1GHz-18GHz horn Antenna was used. Antenna elevated from 100 cm from floor to 200 cm from floor, and was placed at 3 m from center of turntable. The equipment under test (EUT) was placed at the middle of the turntable at 150 cm height from floor. The antenna rotated to repeat the measurements for both the horizontal and vertical antenna polarizations. Repeat the measurement steps until the maximum emissions were obtained.
- For frequency range 18GHz-40GHz double horn Antenna was used. Antenna's height was adjusted to 150 cm from floor, and 1 m distance to center of turntable. The equipment under test (EUT) was placed at the middle of the turntable on at 150 cm height from floor.
- For all frequency ranges the turntable was rotated 360° for obtaining the maximum emission.

SAC 5 Test Setup Configuration 30MHz – 1GHz

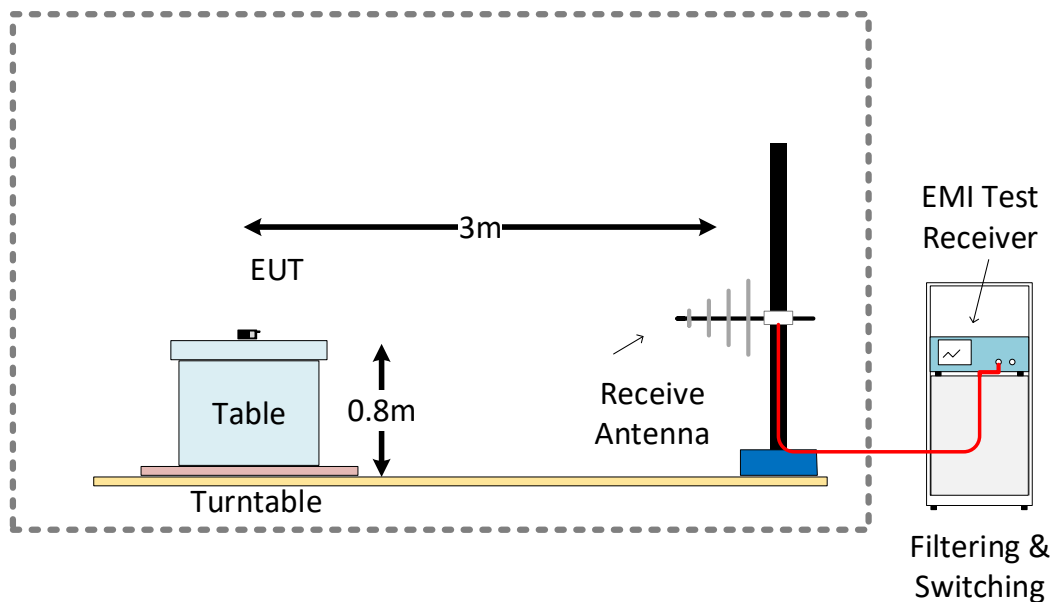

### SAC 5 Test Setup Configuration 1GHz – 18GHz

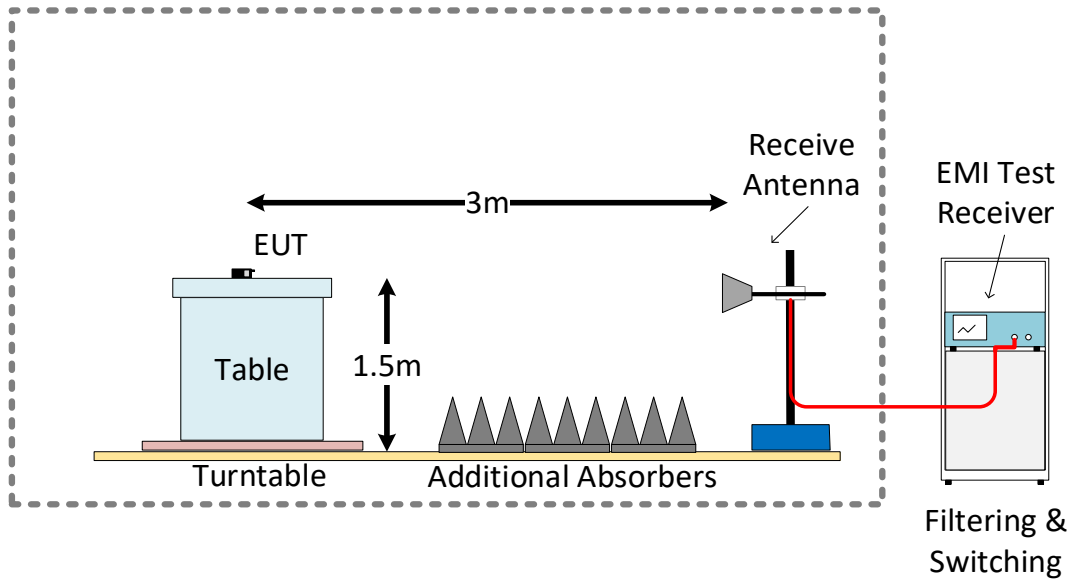

### SAC 5 Test Setup Configuration 18GHz – 40GHz

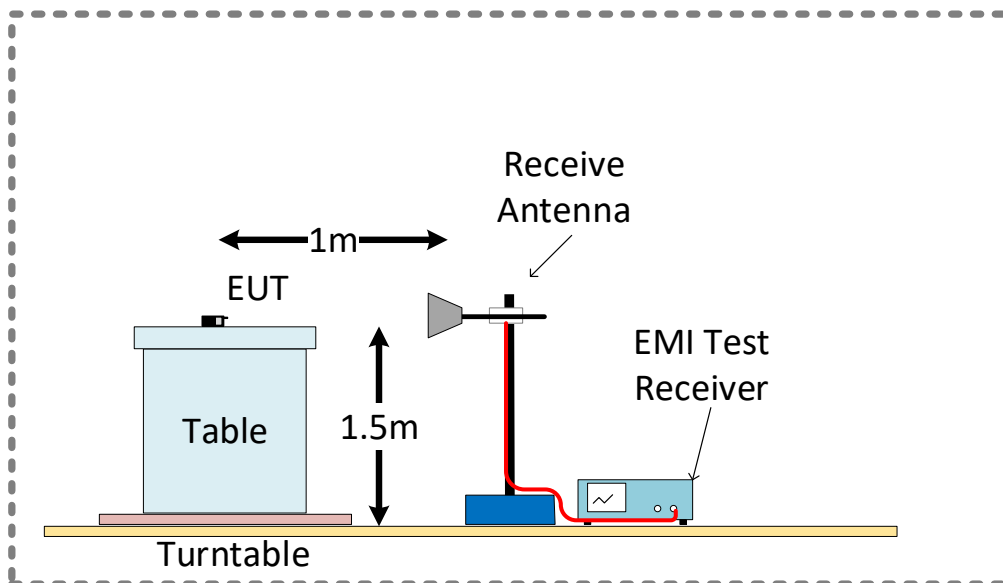

### 3.5 EUT Configuration During Test

#### AC Power Line Conducted Emissions

For AC power line conducted emissions testing, the device was connected to the USB Charger and set to continuous transmit mode on the mid channel. Conducted emissions tests were run on the Mains AC connection to the charger. See test setup photographs for more detail.

#### Radiated Emissions

For radiated emissions testing, the device was operated from the battery and set to continuous transmit mode on an appropriate channel. See test setup photographs for more detail.

#### Conducted RF

For conducted RF testing for a fixed channel, power to the device was supplied from a DC power supply to simulate the various battery levels. The device was modified with an RF connector in place of the antenna to allow for conducted RF measurements.

For conducted testing in hopping mode, power to the device was supplied from a USB charger. The device was modified with an RF connector in place of the antenna to allow for conducted RF measurements.

### 3.6 EUT Operation Modes

Operation mode	Description
Continuous Tx	The device was set to transmit a continuous modulated signal with the appropriate frequency
Continuous Hopping	The device was set to transmit a modulated signal with the standard frequency-hopping parameters

### 3.7 Deviations from the Test Standard

None

### 3.8 Environmental Conditions

#### 3.8.1 Environmental Conditions – Conducted RF System

##### Environmental Conditions Log – Conducted RF

Date	Time	Temperature (°C)	Relative Humidity (%)
2021.02.22	09:03	19.3	34
2021.03.09	14:16	22.8	16
2021.04.12	16:50	18.7	25
2021.06.24	13:16	23.1	53

#### 3.8.2 Environmental Conditions – Conducted Emissions System

##### Environmental Conditions Log – Conducted Emissions

Date	Time	Temperature (°C)	Relative Humidity (%)
2021.01.11	08:40	22.1	27

#### 3.8.3 Environmental Conditions – SAC5 (Radiated Emissions)

##### Environmental Conditions Log – SAC5

Date	Time	Temperature (°C)	Relative Humidity (%)
2020.12.18	07:26	18.6	43
2020.12.21	08:32	18.3	44
2020.12.22	08:51	18.1	43
2020.12.23	08:45	18.3	43
2021.01.21	07:22	18.4	35
2021.01.23	09:00	18.3	35

## 4. TEST RESULTS

### 4.1 Test Results – AC Power Line Conducted Emissions (Intentional Transmitter)

#### 4.1.1 AC Power Line Conducted Emissions (Intentional) – Test Summary

<b>Test Specification</b>	FCC 47 CFR 15.207 (Part 15 Subpart C)		
<b>Test Engineer &amp; Date</b>	Fariborz Abasi	2021.01.11	
<b>EUT and Ancillary Equipment IDs</b>	A002972080-001	A002972080-007	
<b>EUT Operation Mode(s)</b>	Continuous Tx		
<b>EUT Wireless Configuration(s)</b>	IEEE 802.15.4g Sub-GHz US (see below for details)		
<b>EUT Hardware Configuration(s)</b>	-		
<b>Overall Result</b>	PASS		
<b>Test Parameter</b>	<b>Wireless Configuration</b>	<b>Frequency Range</b>	<b>Result*</b>
AC Conducted Power Line Emissions – “N” Line	IEEE 802.15.4g Sub-GHz US Mid Channel (2-GFSK 915.0 MHz)	150 kHz – 30 MHz	PASS
AC Conducted Power Line Emissions – “L1” Line	IEEE 802.15.4g Sub-GHz US Mid Channel (2-GFSK 915.0 MHz)	150 kHz – 30 MHz	PASS

\* For detailed measurements, see tables and graphs in sections below

4.1.2 AC Power Line Conducted Emissions (Intentional) – Test Details

<b>Test</b>	Conducted Emission	
<b>Test mode condition</b>	Sub-GHz US Mid Channel (915 MHz)	
<b>Standard</b>	47 CFR Part 15.247	
<b>EUT</b>	A002972080-001	
<b>Ancillary Equipment</b>	A002972080-007 AC Adaptor	
<b>Test Engineer</b>	Fariborz Abasi	Date: 2021.01.11

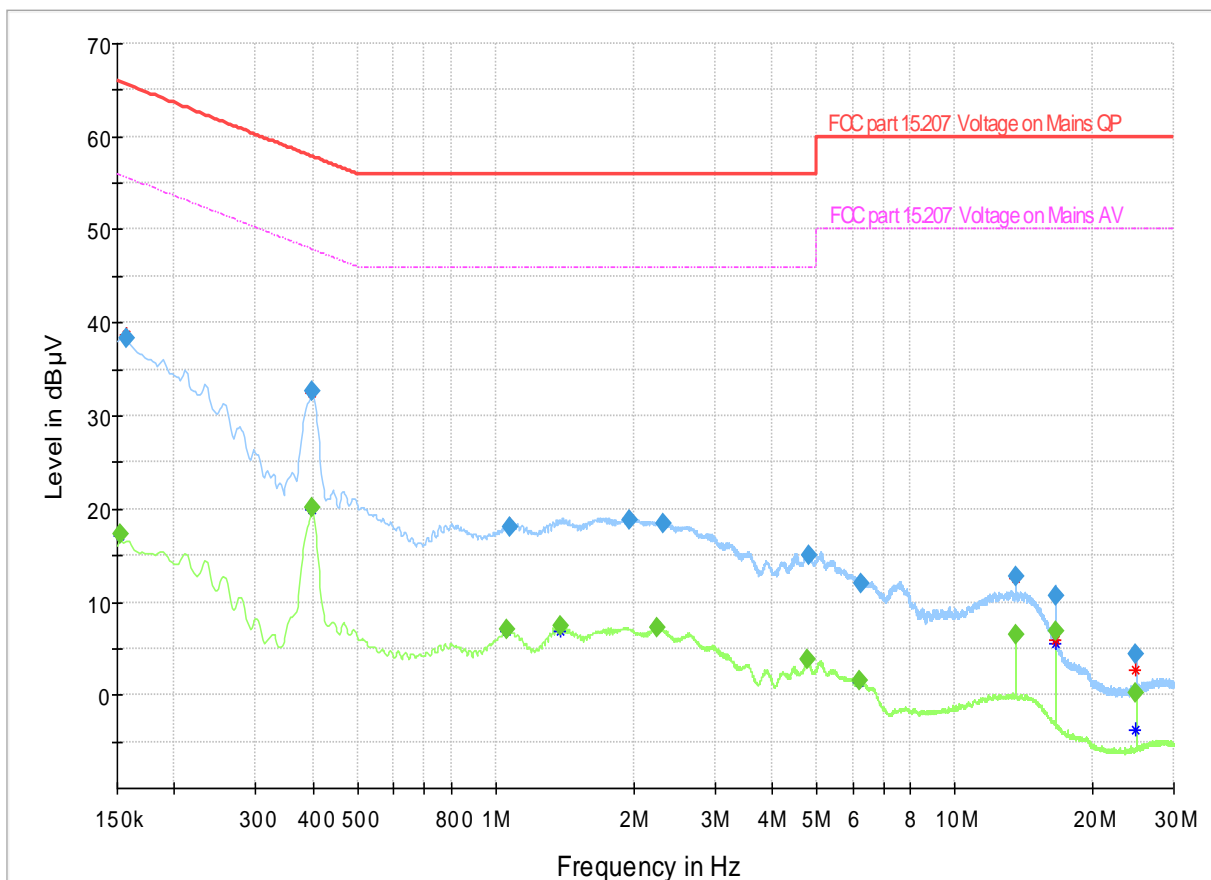

- Preview Result 2-CAV
- \* Critical\_Freqs CAV
- FCC part 15.207 Voltage on Mains QP
- ◆ Final\_Result QPK
- Preview Result 1-QPK
- \* Critical\_Freqs QPK
- FCC part 15.207 Voltage on Mains AV
- ◆ Final\_Result CAV



Frequency (MHz)	QuasiPeak (dBµV)	CAverage (dBµV)	Limit (dBµV)	Margin (dB)	Meas. Time (ms)	Bandwidth (kHz)	Line	Filter	Corr. (dB)
0.152250	---	17.31	55.88	38.57	1000.0	9.000	N	ON	9.7
0.156750	38.34	---	65.63	27.30	1000.0	9.000	N	ON	9.7
0.399750	---	20.06	47.86	27.79	1000.0	9.000	N	ON	9.6
0.399750	32.64	---	57.86	25.22	1000.0	9.000	N	ON	9.6
1.059000	---	6.99	46.00	39.01	1000.0	9.000	N	ON	9.7
1.077000	18.03	---	56.00	37.97	1000.0	9.000	N	ON	9.7
1.380750	---	7.44	46.00	38.56	1000.0	9.000	N	ON	9.7
1.961250	18.90	---	56.00	37.10	1000.0	9.000	N	ON	9.7
2.247000	---	7.22	46.00	38.78	1000.0	9.000	N	ON	9.7
2.312250	18.35	---	56.00	37.65	1000.0	9.000	N	ON	9.7
4.776000	---	3.86	46.00	42.14	1000.0	9.000	N	ON	9.8
4.825500	14.96	---	56.00	41.04	1000.0	9.000	N	ON	9.8
6.209250	---	1.54	50.00	48.46	1000.0	9.000	N	ON	9.8
6.234000	12.08	---	60.00	47.92	1000.0	9.000	N	ON	9.8
13.560000	12.76	---	60.00	47.24	1000.0	9.000	N	ON	9.9
13.560000	---	6.49	50.00	43.51	1000.0	9.000	N	ON	9.9
16.543500	---	6.95	50.00	43.05	1000.0	9.000	N	ON	10.0
16.545750	10.76	---	60.00	49.24	1000.0	9.000	N	ON	10.0
24.816750	---	0.20	50.00	49.80	1000.0	9.000	N	ON	10.1
24.832500	4.44	---	60.00	55.56	1000.0	9.000	L1	ON	10.0

## 4.2 Test Results – Radiated Emissions (Intentional Transmitter)

### 4.2.1 Radiated Emissions (Intentional) – Test Summary

<b>Test Specification</b>	FCC 47 CFR 15.209 (Part 15 Subpart C)		
<b>Test Engineer &amp; Date</b>	Niall Forrester Joel Efraimsson Simon Palmhager	2020.12.18 – 2021.01.23	
<b>EUT and Ancillary Equipment IDs</b>	A002972080-001	-	
<b>EUT Operation Mode(s)</b>	Continuous Tx		
<b>EUT Wireless Configuration(s)</b>	IEEE 802.15.4g Sub-GHz US (see below for details)		
<b>EUT Hardware Configuration(s)</b>	-		
<b>Overall Result</b>	PASS		
<b>Test Parameter</b>	<b>Wireless Configuration</b>	<b>Frequency Range</b>	<b>Result</b>
Radiated Emissions	IEEE 802.15.4g Sub-GHz US Low Channel (2-GFSK 902.2 MHz)	9 kHz – 30 MHz	PASS
Radiated Emissions	IEEE 802.15.4g Sub-GHz US Low Channel (2-GFSK 902.2 MHz)	30 MHz – 1 GHz	PASS
Radiated Emissions	IEEE 802.15.4g Sub-GHz US Low Channel (2-GFSK 902.2 MHz)	1 GHz – 18 GHz	PASS
Radiated Emissions	IEEE 802.15.4g Sub-GHz US Mid Channel (2-GFSK 915.0 MHz)	9 kHz – 30 MHz	PASS
Radiated Emissions	IEEE 802.15.4g Sub-GHz US Mid Channel (2-GFSK 915.0 MHz)	30 MHz – 1 GHz	PASS
Radiated Emissions	IEEE 802.15.4g Sub-GHz US Mid Channel (2-GFSK 915.0 MHz)	1 GHz – 18 GHz	PASS
Radiated Emissions	IEEE 802.15.4g Sub-GHz US High Channel (2-GFSK 927.8 MHz)	9 kHz – 30 MHz	PASS
Radiated Emissions	IEEE 802.15.4g Sub-GHz US High Channel (2-GFSK 927.8 MHz)	30 MHz – 1 GHz	PASS
Radiated Emissions	IEEE 802.15.4g Sub-GHz US High Channel (2-GFSK 927.8 MHz)	1 GHz – 18 GHz	PASS

4.2.2 Radiated Emissions (Intentional) – Test Details  
Low Channel

Test mode condition	Sub-GHz US Low Channel (902.2 MHz)	
Antenna orientation	Loop Antenna Parallel to Axis	
Sweep frequency	9 kHz-30 MHz	
Standard	47 CFR FCC Part 15 subpart C	
EUT	A002972080-001	
Ancillary Equipment	-	
Test Engineer	Joel Efraimsson	Date: 2021-01-21
Chamber details	Chamber: SAC 5	

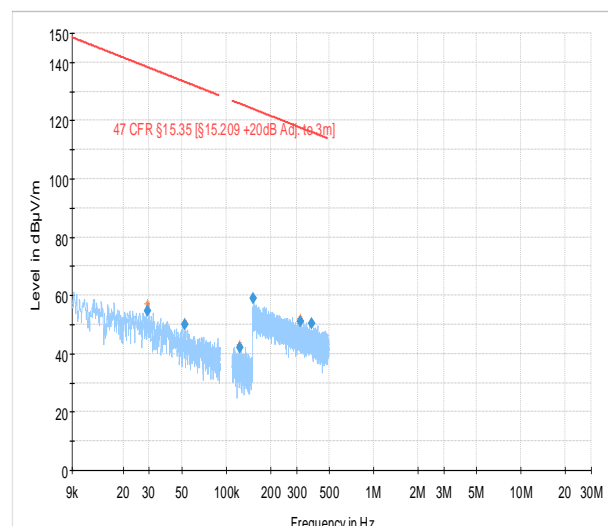
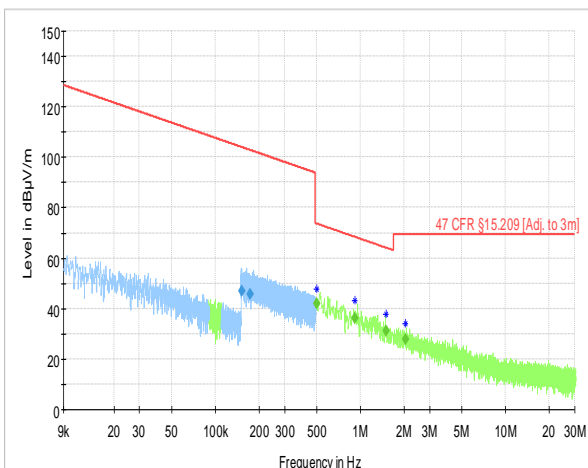

Frequency (MHz)	Average (dBµV/m)	QuasiPeak (dBµV/m)	MaxPeak (dBµV/m)	Limit (dBµV/m)	Margin (dB)	Meas. Time (ms)	Bandwidth (kHz)	Height (cm)	Pol	Azimuth (deg)
0.151645	46.85	---	---	103.99	57.14	1000.0	9.000	100.0	H	269.0
0.173700	45.61	---	---	102.81	57.20	1000.0	9.000	100.0	H	297.0
0.502030	---	42.02	---	73.59	31.57	1000.0	9.000	100.0	H	135.0
0.913310	---	36.32	---	68.39	32.07	1000.0	9.000	100.0	H	154.0
1.505314	---	31.07	---	64.05	32.98	1000.0	9.000	100.0	H	77.0
2.052523	---	27.78	---	69.54	41.76	1000.0	9.000	100.0	H	282.0
0.029112	---	---	54.80	138.32	83.52	1000.0	0.200	100.0	H	101.0
0.052166	---	---	50.10	133.26	83.16	1000.0	0.200	100.0	H	139.0
0.123010	---	---	42.18	125.81	83.63	1000.0	0.200	100.0	H	49.0
0.152921	---	---	59.06	123.92	64.85	1000.0	9.000	100.0	H	112.0
0.319919	---	---	51.05	117.50	66.45	1000.0	9.000	100.0	H	225.0
0.381011	---	---	50.35	115.99	65.63	1000.0	9.000	100.0	H	45.0

<b>Test mode condition</b>	Sub-GHz US Low Channel (902.2 MHz)	
<b>Antenna orientation</b>	Loop Antenna Perpendicular to Axis	
<b>Sweep frequency</b>	9 kHz-30 MHz	
<b>Standard</b>	47 CFR FCC Part 15 subpart C	
<b>EUT</b>	A002972080-001	
<b>Ancillary Equipment</b>	-	
<b>Test Engineer</b>	Simon Palmhager	Date: 2021-01-23
<b>Chamber details</b>	Chamber: SAC 5	

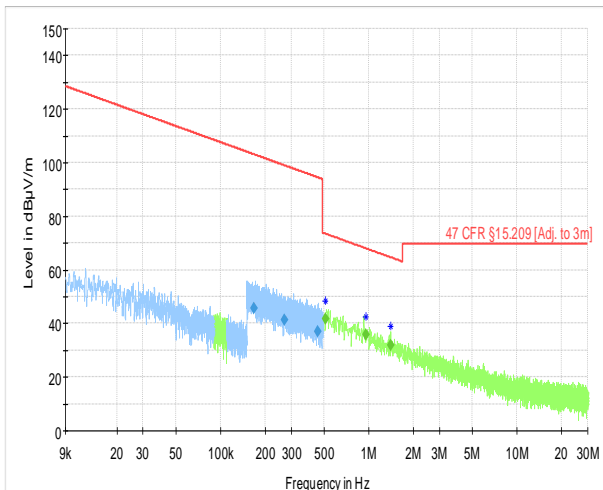

— Preview Result 2-PK+      — Preview Result 1-AVG  
♦ Critical\_Freqs PK+      ♦ Critical\_Freqs AVG  
— 47 CFR §15.209 (Adj. to 3m)      ♦ Final\_Result AVG  
♦ Final\_Result QPK

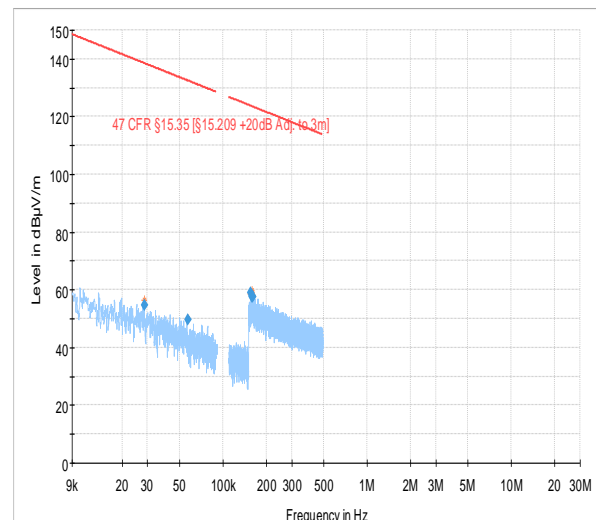

— Preview Result 1-PK+      ♦ Critical\_Freqs PK+  
— 47 CFR §15.35 (§15.209 +20dB Adj. to 3m)      ♦ Final\_Result PK+

Frequency (MHz)	Average (dBµV/m)	QuasiPeak (dBµV/m)	MaxPeak (dBµV/m)	Limit (dBµV/m)	Margin (dB)	Meas. Time (ms)	Bandwidth (kHz)	Height (cm)	Pol	Azimuth (deg)
0.168988	45.85	---	---	103.05	57.20	1000.0	9.000	100.0	H	281.0
0.268970	41.53	---	---	99.01	57.48	1000.0	9.000	100.0	H	166.0
0.454180	37.06	---	---	94.46	57.40	1000.0	9.000	100.0	H	309.0
0.511622	---	41.91	---	73.43	31.52	1000.0	9.000	100.0	H	281.0
0.958464	---	35.83	---	67.97	32.14	1000.0	9.000	100.0	H	135.0
1.411658	---	31.71	---	64.61	32.90	1000.0	9.000	100.0	H	229.0
0.028542	---	---	54.86	138.50	83.64	1000.0	0.200	100.0	H	225.0
0.057048	---	---	49.46	132.48	83.02	1000.0	0.200	100.0	H	225.0
0.156480	---	---	58.88	123.72	64.83	1000.0	9.000	100.0	H	-27.0
0.158773	---	---	57.98	123.59	65.61	1000.0	9.000	100.0	H	139.0
0.159643	---	---	57.49	123.54	66.05	1000.0	9.000	100.0	H	223.0
0.161552	---	---	57.53	123.44	65.90	1000.0	9.000	100.0	H	153.0

<b>Test mode condition</b>	Sub-GHz US Low Channel (902.2 MHz)	
<b>Antenna orientation</b>	Loop Antenna Parallel to floor	
<b>Sweep frequency</b>	9 kHz-30 MHz	
<b>Standard</b>	47 CFR FCC Part 15 subpart C	
<b>EUT</b>	A002972080-001	
<b>Ancillary Equipment</b>	-	
<b>Test Engineer</b>	Simon Palmhager	Date: 2021-01-23
<b>Chamber details</b>	Chamber: SAC 5	

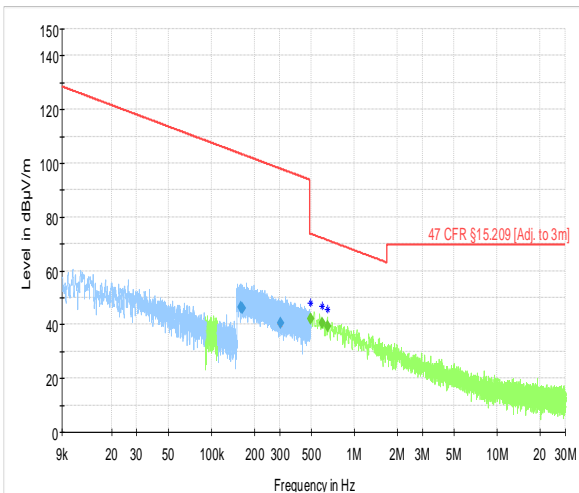

— Preview Result 2-PK+  
+ Critical\_Freqs PK+  
— 47 CFR §15.209 (Adj. to 3m)  
◆ Final\_Result QPK  
— Preview Result 1-AVG  
+ Critical\_Freqs AVG  
◆ Final\_Result AVG

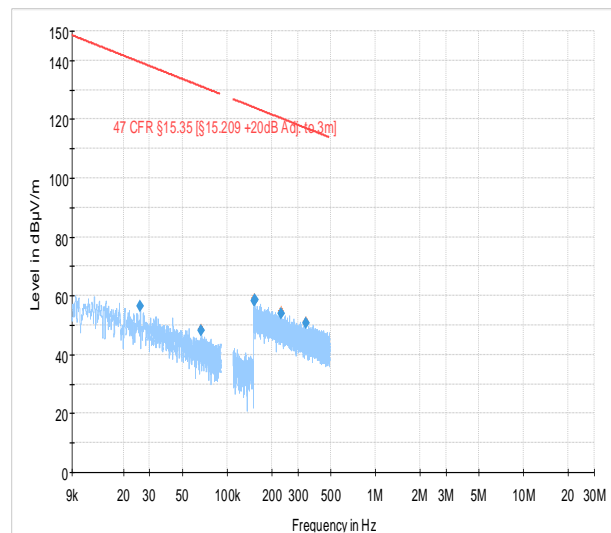

— Preview Result 1-PK+  
— 47 CFR §15.35 (§15.209 +20dB Adj. to 3m)  
+ Critical\_Freqs PK+  
◆ Final\_Result PK+

Frequency (MHz)	Average (dBµV/m)	QuasiPeak (dBµV/m)	MaxPeak (dBµV/m)	Limit (dBµV/m)	Margin (dB)	Meas. Time (ms)	Bandwidth (kHz)	Height (cm)	Pol	Azimuth (deg)
0.160356	46.36	---	---	103.50	57.14	1000.0	9.000	100.0	H	38.0
0.164280	46.19	---	---	103.29	57.10	1000.0	9.000	100.0	H	-26.0
0.306126	40.36	---	---	97.89	57.53	1000.0	9.000	100.0	H	256.0
0.494694	---	42.10	---	73.72	31.62	1000.0	9.000	100.0	H	154.0
0.597387	---	40.40	---	72.08	31.68	1000.0	9.000	100.0	H	49.0
0.649327	---	39.48	---	71.36	31.88	1000.0	9.000	100.0	H	257.0
0.025873	---	---	56.56	139.35	82.79	1000.0	0.200	100.0	H	113.0
0.067039	---	---	48.29	131.08	82.78	1000.0	0.200	100.0	H	267.0
0.152367	---	---	58.24	123.95	65.70	1000.0	9.000	100.0	H	125.0
0.153987	---	---	58.54	123.86	65.31	1000.0	9.000	100.0	H	153.0
0.232258	---	---	53.84	120.29	66.45	1000.0	9.000	100.0	H	305.0
0.339912	---	---	50.74	116.98	66.24	1000.0	9.000	100.0	H	45.0

<b>Test mode condition</b>	Sub-GHz US Low Channel (902.2 MHz)	
<b>Antenna orientation</b>	Horizontal and Vertical	
<b>Sweep frequency</b>	30 MHz – 1 GHz	
<b>Standard</b>	47 CFR FCC Part 15 subpart C	
<b>EUT</b>	A002972080-001	
<b>Ancillary Equipment</b>	-	
<b>Test Engineer</b>	Simon Palmhager	Date: 2020-12-28
<b>Chamber details</b>	Chamber: SAC 5	

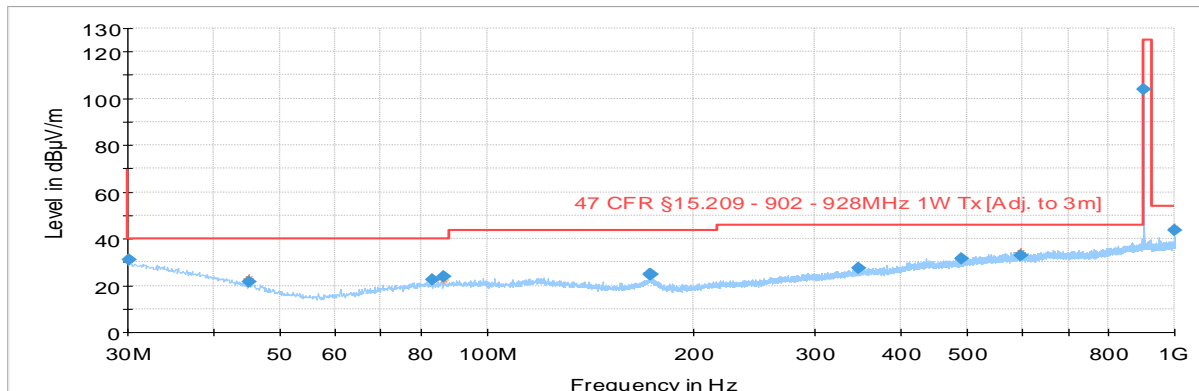

- Preview Result 2-AVG
- Preview Result 1-PK+
- Critical\_Freqs AVG
- Critical\_Freqs PK+
- 47 CFR §15.209 - 902 - 928MHz 1W Tx [Adj. to 3m]
- Final\_Result PK+
- Final\_Result AVG
- MaxPeak-PK+ (Single)
- Average-AVG (Single)

Frequency (MHz)	MaxPeak (dBµV/m)	Limit (dBµV/m)	Margin (dB)	Meas. Time (ms)	Bandwidth (kHz)	Height (cm)	Pol	Azimuth (deg)
30.110287	31.16	40.00	8.84	1000.0	120.000	283.0	H	72.0
44.991840	21.81	40.00	18.19	1000.0	120.000	270.0	V	112.0
83.242120	22.47	40.00	17.53	1000.0	120.000	204.0	H	188.0
86.399200	23.70	40.00	16.30	1000.0	120.000	125.0	H	63.0
172.483160	24.60	43.52	18.92	1000.0	120.000	325.0	V	202.0
173.384520	24.95	43.52	18.57	1000.0	120.000	220.0	V	112.0
346.418680	27.52	46.02	18.50	1000.0	120.000	108.0	H	289.0
490.177480	31.60	46.02	14.42	1000.0	120.000	220.0	H	252.0
597.898320	32.92	46.02	13.10	1000.0	120.000	108.0	V	252.0
902.204080	103.95	125.23	21.28	1000.0	120.000	100.0	H	278.0
998.200360	43.78	53.98	10.20	1000.0	120.000	183.0	H	278.0

<b>Test mode condition</b>	Sub-GHz US Low Channel (902.2 MHz)	
<b>Antenna orientation</b>	Horizontal and Vertical	
<b>Sweep frequency</b>	1 GHz – 18 GHz	
<b>Standard</b>	47 CFR FCC Part 15 subpart C	
<b>EUT</b>	A002972080-001	
<b>Ancillary Equipment</b>	-	
<b>Test Engineer</b>	Joel Efraimsson	Date: 2020-12-21
<b>Chamber details</b>	Chamber: SAC 5	

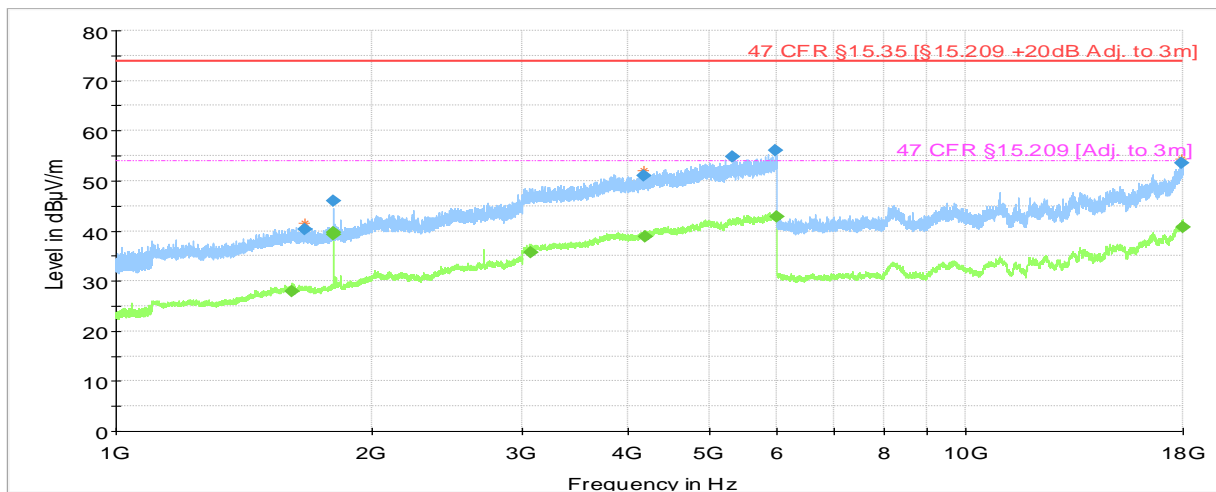

— Preview Result 2-AVG  
— Preview Result 1-PK+  
\* Critical\_Freqs AVG  
\* Critical\_Freqs PK+  
— 47 CFR §15.35 [§15.209 +20dB Adj. to 3m]  
— 47 CFR §15.209 [Adj. to 3m]  
◆ Final\_Result PK+  
◆ Final\_Result AVG

Frequency (MHz)	MaxPeak (dBµV/m)	Average (dBµV/m)	Limit (dBµV/m)	Margin (dB)	Meas. Time (ms)	Bandwidth (kHz)	Height (cm)	Pol	Azimuth (deg)
1612.261000	---	27.93	53.98	26.04	1000.0	1000.000	187.0	V	144.0
1667.858000	40.40	---	73.98	33.58	1000.0	1000.000	198.0	H	-3.0
1804.400000	---	39.60	53.98	14.38	1000.0	1000.000	175.0	H	177.0
1804.436000	45.90	---	73.98	28.08	1000.0	1000.000	177.0	H	178.0
1804.461000	---	39.21	53.98	14.77	1000.0	1000.000	197.0	H	162.0
3071.152000	---	35.79	53.98	18.19	1000.0	1000.000	175.0	H	99.0
4177.653000	51.04	---	73.98	22.94	1000.0	1000.000	125.0	V	324.0
4187.238000	---	38.76	53.98	15.22	1000.0	1000.000	177.0	H	158.0
5320.193000	54.71	---	73.98	19.27	1000.0	1000.000	135.0	V	68.0
5974.908000	56.04	---	73.98	17.94	1000.0	1000.000	169.0	H	158.0
5984.334000	---	42.84	53.98	11.14	1000.0	1000.000	175.0	H	323.0
17916.929000	53.64	---	73.98	20.34	1000.0	1000.000	169.0	V	219.0
17999.465560	---	40.73	53.98	13.25	1000.0	1000.000	100.0	V	19.0

Mid Channel

<b>Test mode condition</b>	Sub-GHz US Mid Channel (915.0 MHz)	
<b>Antenna orientation</b>	Loop Antenna Parallel to Axis	
<b>Sweep frequency</b>	9 kHz-30 MHz	
<b>Standard</b>	47 CFR FCC Part 15 subpart C	
<b>EUT</b>	A002972080-001	
<b>Ancillary Equipment</b>	-	
<b>Test Engineer</b>	Joel Efraimsson	Date: 2021-01-21
<b>Chamber details</b>	Chamber: SAC 5	

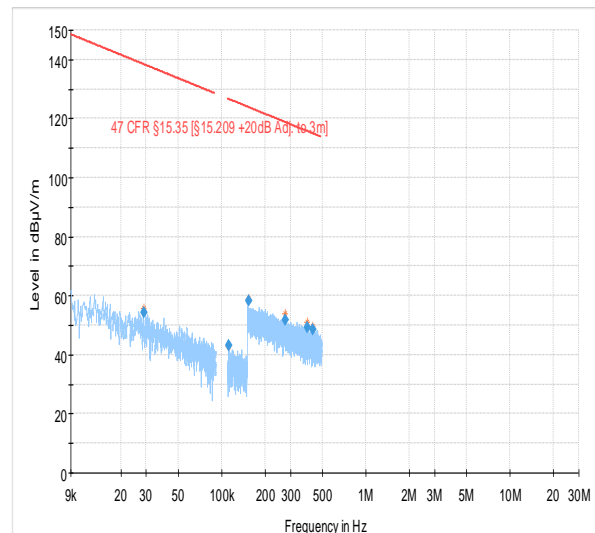
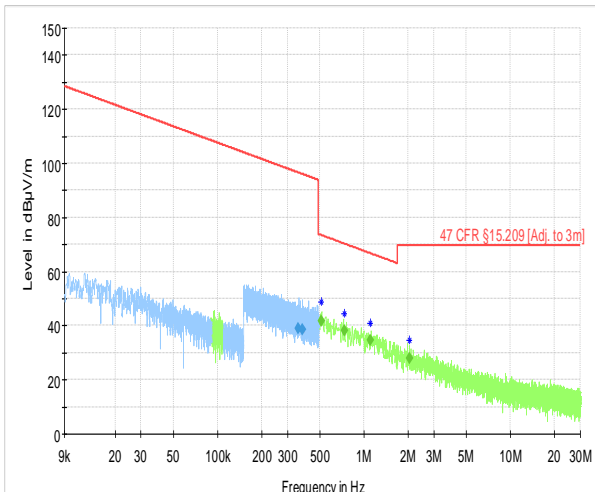

- Preview Result 2-PK+
- ◆ Critical\_Freqs PK+
- 47 CFR §15.209 [Adj. to 3m]
- ◆ Final\_Result QPK
- Preview Result 1-AVG
- ◆ Critical\_Freqs AVG
- ◆ Final\_Result AVG

- Preview Result 1-PK+
- 47 CFR §15.35 [§15.209 +20dB Adj. to 3m]
- ◆ Critical\_Freqs PK+
- ◆ Final\_Result PK+

Frequency (MHz)	Average (dBµV/m)	QuasiPeak (dBµV/m)	MaxPeak (dBµV/m)	Limit (dBµV/m)	Margin (dB)	Meas. Time (ms)	Bandwidth (kHz)	Height (cm)	Pol	Azimuth (deg)
0.357322	39.06	---	---	96.54	57.48	1000.0	9.000	100.0	H	-1.0
0.378562	38.64	---	---	96.04	57.40	1000.0	9.000	100.0	H	-41.0
0.508749	---	41.91	---	73.47	31.56	1000.0	9.000	100.0	H	37.0
0.737016	---	38.27	---	70.26	31.99	1000.0	9.000	100.0	H	-45.0
1.098367	---	34.48	---	66.79	32.31	1000.0	9.000	100.0	H	12.0
2.050831	---	27.78	---	69.54	41.76	1000.0	9.000	100.0	H	281.0
0.028995	---	---	54.31	138.36	84.05	1000.0	0.200	100.0	H	63.0
0.112131	---	---	43.28	126.61	83.33	1000.0	0.200	100.0	H	11.0
0.153747	---	---	58.19	123.87	65.68	1000.0	9.000	100.0	H	113.0
0.276127	---	---	51.95	118.78	66.83	1000.0	9.000	100.0	H	-15.0
0.392718	---	---	49.14	115.72	66.59	1000.0	9.000	100.0	H	292.0
0.427558	---	---	48.62	114.98	66.37	1000.0	9.000	100.0	H	315.0



<b>Test mode condition</b>	Sub-GHz US Mid Channel (915.0 MHz)	
<b>Antenna orientation</b>	Loop Antenna Perpendicular to Axis	
<b>Sweep frequency</b>	9 kHz-30 MHz	
<b>Standard</b>	47 CFR FCC Part 15 subpart C	
<b>EUT</b>	A002972080-001	
<b>Ancillary Equipment</b>	-	
<b>Test Engineer</b>	Simon Palmhager	Date: 2021-01-23
<b>Chamber details</b>	Chamber: SAC 5	

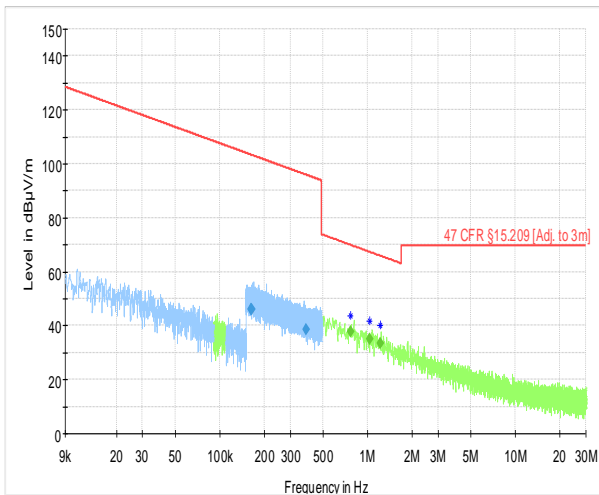

— Preview Result 2-PK+  
◆ Critical\_Freqs PK+  
— 47 CFR §15.209 [Adj. to 3m]  
◆ Final\_Result QPK  
— Preview Result 1-AVG  
◆ Critical\_Freqs AVG  
◆ Final\_Result AVG

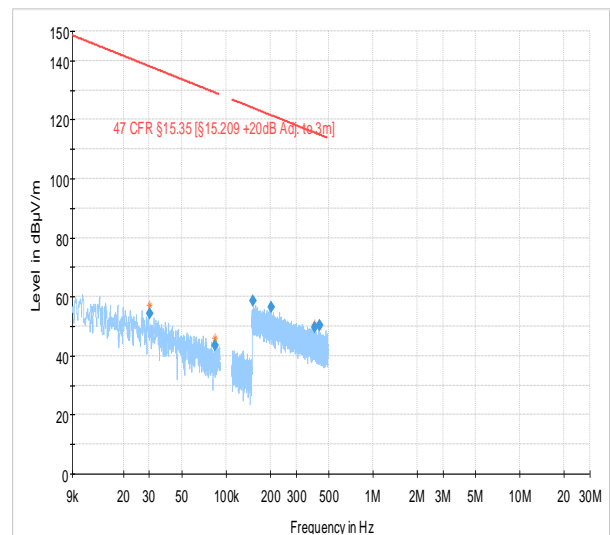

— Preview Result 1-PK+  
— 47 CFR §15.35 [§15.209 +20dB Adj. to 3m]  
◆ Critical\_Freqs PK+  
◆ Final\_Result PK+

Frequency (MHz)	Average (dBµV/m)	QuasiPeak (dBµV/m)	MaxPeak (dBµV/m)	Limit (dBµV/m)	Margin (dB)	Meas. Time (ms)	Bandwidth (kHz)	Height (cm)	Pol	Azimuth (deg)
0.162114	46.25	---	---	103.41	57.15	1000.0	9.000	100.0	H	315.0
0.164257	46.20	---	---	103.29	57.10	1000.0	9.000	100.0	H	77.0
0.384490	38.42	---	---	95.91	57.49	1000.0	9.000	100.0	H	225.0
0.765229	---	37.75	---	69.93	32.18	1000.0	9.000	100.0	H	281.0
1.039216	---	35.01	---	67.27	32.26	1000.0	9.000	100.0	H	-41.0
1.222258	---	33.31	---	65.86	32.55	1000.0	9.000	100.0	H	315.0
0.030177	---	---	54.22	138.01	83.79	1000.0	0.200	100.0	H	35.0
0.083944	---	---	43.64	129.12	85.48	1000.0	0.200	100.0	H	-41.0
0.152793	---	---	58.49	123.92	65.44	1000.0	9.000	100.0	H	135.0
0.201887	---	---	56.31	121.50	65.19	1000.0	9.000	100.0	H	45.0
0.401216	---	---	49.80	115.54	65.74	1000.0	9.000	100.0	H	282.0
0.434581	---	---	50.37	114.84	64.47	1000.0	9.000	100.0	H	190.0

<b>Test mode condition</b>	Sub-GHz US Mid Channel (915.0 MHz)	
<b>Antenna orientation</b>	Loop Antenna Parallel to floor	
<b>Sweep frequency</b>	9 kHz-30 MHz	
<b>Standard</b>	47 CFR FCC Part 15 subpart C	
<b>EUT</b>	A002972080-001	
<b>Ancillary Equipment</b>	-	
<b>Test Engineer</b>	Simon Palmhager	Date: 2021-01-23
<b>Chamber details</b>	Chamber: SAC 5	

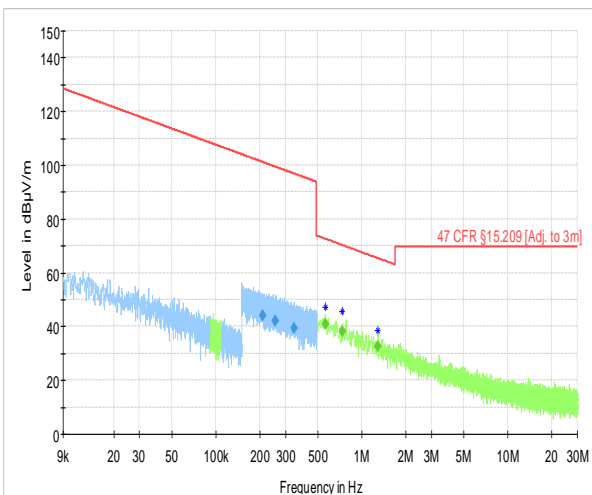

— Preview Result 2-PK+  
+ Critical\_Freqs PK+  
— 47 CFR §15.209 [Adj. to 3m]  
♦ Final\_Result QPK  
— Preview Result 1-AVG  
+ Critical\_Freqs AVG  
♦ Final\_Result AVG

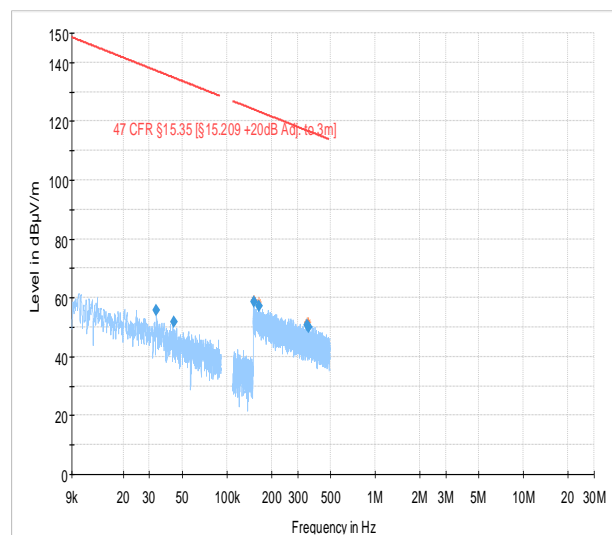

— Preview Result 1-PK+  
— 47 CFR §15.35 [§15.209 +20dB Adj. to 3m]  
+ Critical\_Freqs PK+  
♦ Final\_Result PK+

Frequency (MHz)	Average (dBµV/m)	QuasiPeak (dBµV/m)	MaxPeak (dBµV/m)	Limit (dBµV/m)	Margin (dB)	Meas. Time (ms)	Bandwidth (kHz)	Height (cm)	Pol	Azimuth (deg)
0.209471	---	101.18	---	101.18	57.15	1000.0	9.000	100.0	H	315.0
0.255291	---	99.46	---	99.46	57.34	1000.0	9.000	100.0	H	154.0
0.343039	---	96.90	---	96.90	57.59	1000.0	9.000	100.0	H	244.0
0.566637	40.80	72.54	---	72.54	31.74	1000.0	9.000	100.0	H	229.0
0.737563	38.33	70.25	---	70.25	31.91	1000.0	9.000	100.0	H	139.0
1.281455	32.67	65.45	---	65.45	32.78	1000.0	9.000	100.0	H	128.0
0.033327	---	---	55.60	137.15	81.55	1000.0	0.200	100.0	H	-2.0
0.044070	---	---	51.94	134.72	82.78	1000.0	0.200	100.0	H	293.0
0.152028	---	---	58.73	123.97	65.24	1000.0	9.000	100.0	H	-2.0
0.163745	---	---	57.23	123.32	66.09	1000.0	9.000	100.0	H	225.0
0.348745	---	---	50.84	116.75	65.92	1000.0	9.000	100.0	H	45.0
0.355662	---	---	50.14	116.58	66.45	1000.0	9.000	100.0	H	45.0

<b>Test mode condition</b>	Sub-GHz US Mid Channel (915.0 MHz)	
<b>Antenna orientation</b>	Horizontal and Vertical	
<b>Sweep frequency</b>	30 MHz – 1 GHz	
<b>Standard</b>	47 CFR FCC Part 15 subpart C	
<b>EUT</b>	A002972080-001	
<b>Ancillary Equipment</b>	-	
<b>Test Engineer</b>	Simon Palmhager	Date: 2020-12-28
<b>Chamber details</b>	Chamber: SAC 5	

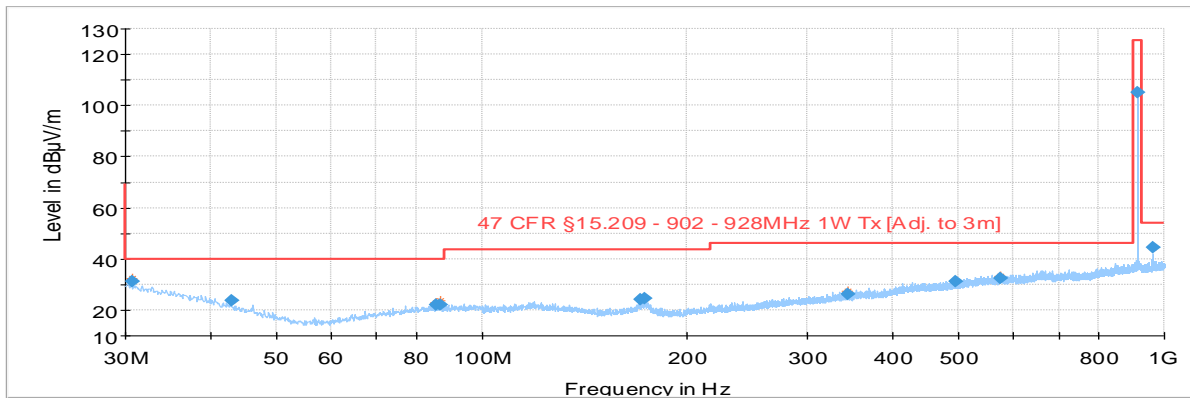

- Preview Result 2-AVG
- Preview Result 1-PK+
- Critical\_Freqs AVG
- Critical\_Freqs PK+
- 47 CFR §15.209 - 902 - 928MHz 1W Tx [Adj. to 3m]
- Final\_Result PK+
- Final\_Result AVG
- MaxPeak-PK+ (Single)
- Average-AVG (Single)

Frequency (MHz)	MaxPeak (dBµV/m)	Limit (dBµV/m)	Margin (dB)	Meas. Time (ms)	Bandwidth (kHz)	Height (cm)	Pol	Azimuth (deg)
30.768042	31.08	40.00	8.92	1000.0	120.000	175.0	V	109.0
42.961200	23.56	40.00	16.44	1000.0	120.000	154.0	V	188.0
85.783480	21.87	40.00	18.13	1000.0	120.000	275.0	V	112.0
86.959960	22.07	40.00	17.93	1000.0	120.000	404.0	V	292.0
170.719320	24.13	43.52	19.39	1000.0	120.000	325.0	H	154.0
173.500560	24.49	43.52	19.03	1000.0	120.000	175.0	H	248.0
343.776200	26.28	46.02	19.74	1000.0	120.000	108.0	H	-4.0
494.663240	31.02	46.02	15.00	1000.0	120.000	275.0	H	188.0
574.170400	32.41	46.02	13.61	1000.0	120.000	304.0	H	154.0
915.002920	104.90	125.23	20.33	1000.0	120.000	100.0	H	289.0
963.027280	44.34	53.98	9.64	1000.0	120.000	100.0	H	112.0

<b>Test mode condition</b>	Sub-GHz US Mid Channel (915.0 MHz)	
<b>Antenna orientation</b>	Horizontal and Vertical	
<b>Sweep frequency</b>	1 GHz – 18 GHz	
<b>Standard</b>	47 CFR FCC Part 15 subpart C	
<b>EUT</b>	A002972080-001	
<b>Ancillary Equipment</b>	-	
<b>Test Engineer</b>	Joel Efraimsson	Date: 2020-12-18
<b>Chamber details</b>	Chamber: SAC 5	

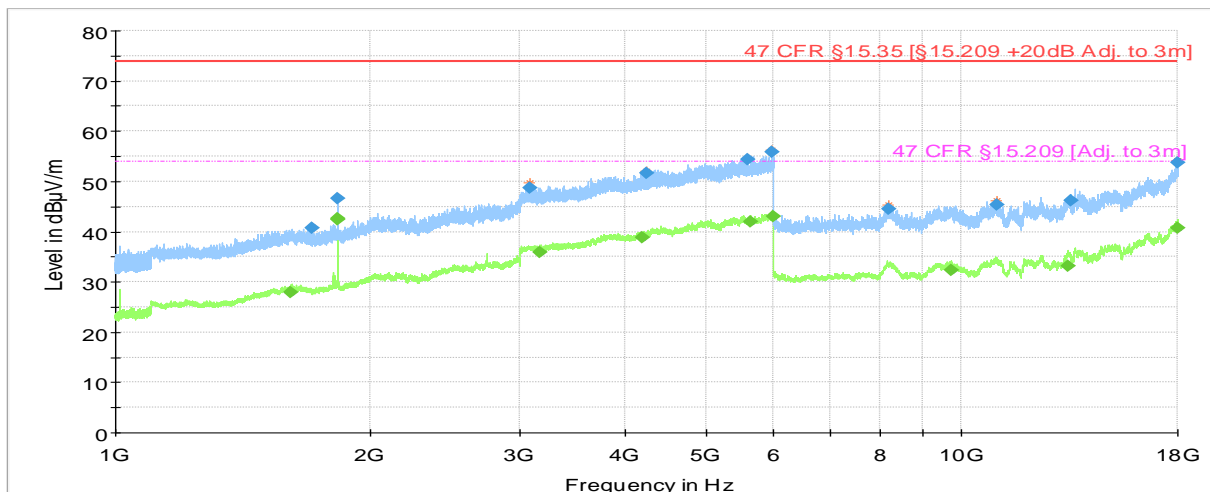

- Preview Result 2-AVG
- \* Critical\_Freqs AVG
- 47 CFR §15.35 [§15.209 +20dB Adj. to 3m]
- ◆ Final\_Result PK+
- Preview Result 1-PK+
- \* Critical\_Freqs PK+
- 47 CFR §15.209 [Adj. to 3m]
- ◆ Final\_Result AVG

Frequency (MHz)	MaxPeak (dBµV/m)	Average (dBµV/m)	Limit (dBµV/m)	Margin (dB)	Meas. Time (ms)	Bandwidth (kHz)	Height (cm)	Pol	Azimuth (deg)
1612.178000	---	28.02	53.98	25.96	1000.0	1000.000	102.0	V	292.0
1704.649000	40.84	---	73.98	33.14	1000.0	1000.000	100.0	V	248.0
1829.934000	46.71	---	73.98	27.26	1000.0	1000.000	186.0	H	-18.0
1829.943000	---	42.41	53.98	11.57	1000.0	1000.000	175.0	H	177.0
1829.990000	---	42.57	53.98	11.41	1000.0	1000.000	175.0	H	177.0
3091.508000	48.79	---	73.98	25.19	1000.0	1000.000	187.0	H	22.0
3172.058000	---	35.82	53.98	18.16	1000.0	1000.000	175.0	H	54.0
4200.703000	---	38.78	53.98	15.20	1000.0	1000.000	169.0	V	290.0
4237.862000	51.70	---	73.98	22.28	1000.0	1000.000	100.0	H	158.0
5581.471000	54.37	---	73.98	19.61	1000.0	1000.000	175.0	H	334.0
5637.989000	---	41.91	53.98	12.07	1000.0	1000.000	102.0	V	-18.0
5977.308000	55.79	---	73.98	18.19	1000.0	1000.000	127.0	V	-3.0
5978.614000	---	43.02	53.98	10.96	1000.0	1000.000	125.0	V	280.0
8209.950000	44.54	---	73.98	29.44	1000.0	1000.000	175.0	V	112.0
9721.117000	---	32.39	53.98	21.59	1000.0	1000.000	102.0	V	-22.0
11003.385000	45.45	---	73.98	28.53	1000.0	1000.000	175.0	H	112.0
13349.586000	---	33.12	53.98	20.86	1000.0	1000.000	125.0	H	158.0
13444.713000	46.26	---	73.98	27.72	1000.0	1000.000	176.0	H	309.0
17969.072000	53.79	---	73.98	20.19	1000.0	1000.000	176.0	H	338.0
17994.929640	---	40.70	53.98	13.28	1000.0	1000.000	175.0	H	252.0

High Channel

<b>Test mode condition</b>	Sub-GHz US High Channel (927.8 MHz)	
<b>Antenna orientation</b>	Loop Antenna Parallel to axis	
<b>Sweep frequency</b>	9 kHz-30 MHz	
<b>Standard</b>	47 CFR FCC Part 15 subpart C	
<b>EUT</b>	A002972080-001	
<b>Ancillary Equipment</b>	-	
<b>Test Engineer</b>	Joel Efraimsson	Date: 2021-01-21
<b>Chamber details</b>	Chamber: SAC 5	

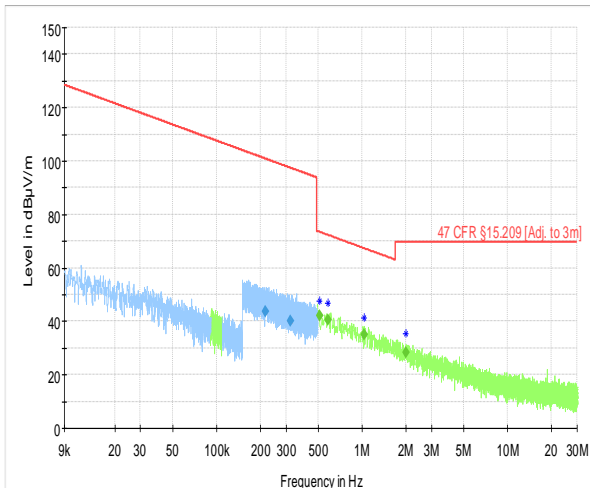

— Preview Result 2-PK+      — Preview Result 1-AVG  
♦ Critical\_Freqs PK+      ♦ Critical\_Freqs AVG  
— 47 CFR §15.209 [Adj. to 3m]      ♦ Final\_Result AVG  
♦ Final\_Result QPK

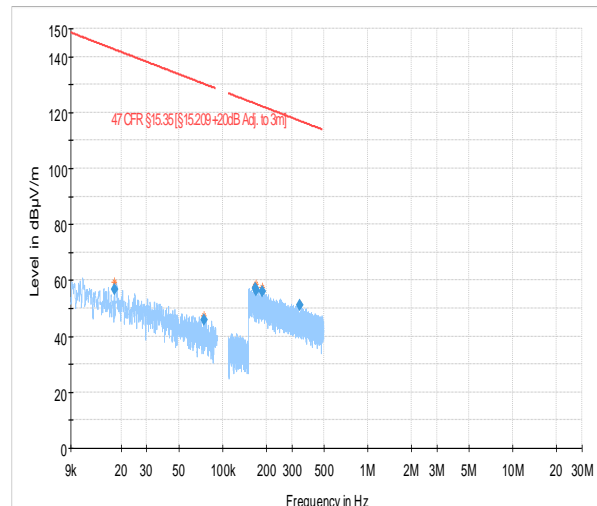

— Preview Result 1-PK+      ♦ Critical\_Freqs PK+  
— 47 CFR §15.35 [§15.209 +20dB Adj. to 3m]      ♦ Final\_Result PK+  
x MaxPeak-PK+ (Single)

Frequency (MHz)	Average (dBµV/m)	QuasiPeak (dBµV/m)	MaxPeak (dBµV/m)	Limit (dBµV/m)	Margin (dB)	Meas. Time (ms)	Bandwidth (kHz)	Height (cm)	Pol	Azimuth (deg)
0.217568	43.70	---	---	100.85	57.15	1000.0	9.000	100.0	H	315.0
0.320265	39.99	---	---	97.49	57.50	1000.0	9.000	100.0	H	229.0
0.508524	---	41.98	---	73.48	31.50	1000.0	9.000	100.0	H	217.0
0.584153	---	40.46	---	72.27	31.81	1000.0	9.000	100.0	H	135.0
1.037465	---	35.11	---	67.29	32.17	1000.0	9.000	100.0	H	315.0
2.004419	---	28.17	---	69.54	41.37	1000.0	9.000	100.0	H	135.0
0.018068	---	---	56.63	142.47	85.84	1000.0	0.200	100.0	H	99.0
0.074750	---	---	45.97	130.13	84.16	1000.0	0.200	100.0	H	-3.0
0.168727	---	---	57.18	123.06	65.88	1000.0	9.000	100.0	H	225.0
0.169330	---	---	56.27	123.03	66.76	1000.0	9.000	100.0	H	88.0
0.188217	---	---	56.01	122.11	66.11	1000.0	9.000	100.0	H	225.0
0.341231	---	---	51.14	116.94	65.80	1000.0	9.000	100.0	H	223.0

<b>Test mode condition</b>	Sub-GHz US High Channel (927.8 MHz)	
<b>Antenna orientation</b>	Loop Antenna Perpendicular to axis	
<b>Sweep frequency</b>	9 kHz-30 MHz	
<b>Standard</b>	47 CFR FCC Part 15 subpart C	
<b>EUT</b>	A002972080-001	
<b>Ancillary Equipment</b>	-	
<b>Test Engineer</b>	Simon Palmhager	Date: 2021-01-23
<b>Chamber details</b>	Chamber: SAC 5	

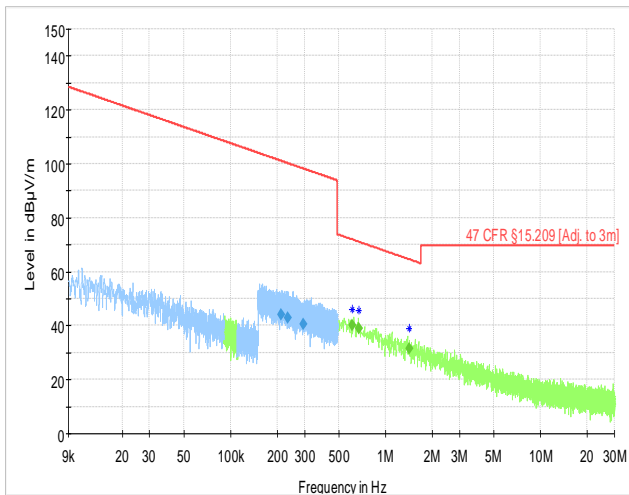

— Preview Result 2-PK+      — Preview Result 1-AVG  
\* Critical\_Freqs PK+      \* Critical\_Freqs AVG  
— 47 CFR §15.209 [Adj. to 3m]      ♦ Final\_Result AVG  
♦ Final\_Result QPK

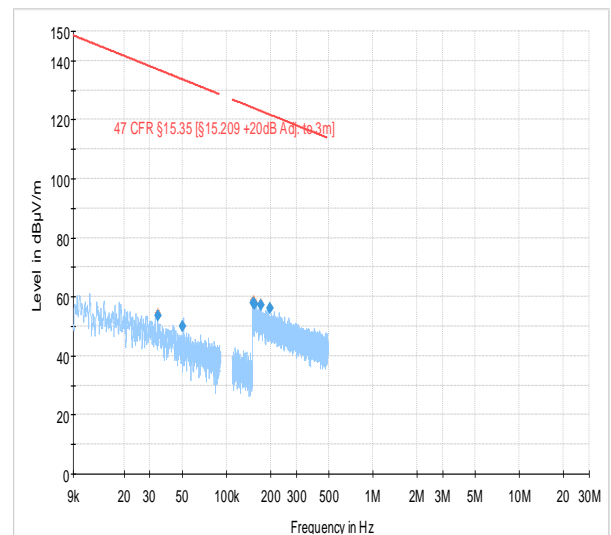

— Preview Result 1-PK+      \* Critical\_Freqs PK+  
— 47 CFR §15.35 (§15.209 +20dB Adj. to 3m)      ♦ Final\_Result PK+

Frequency (MHz)	Average (dBµV/m)	QuasiPeak (dBµV/m)	MaxPeak (dBµV/m)	Limit (dBµV/m)	Margin (dB)	Meas. Time (ms)	Bandwidth (kHz)	Height (cm)	Pol	Azimuth (deg)
0.211096	43.96	---	---	101.12	57.15	1000.0	9.000	100.0	H	25.0
0.234091	42.98	---	---	100.22	57.24	1000.0	9.000	100.0	H	45.0
0.294509	40.67	---	---	98.22	57.56	1000.0	9.000	100.0	H	192.0
0.607702	---	40.10	---	71.93	31.83	1000.0	9.000	100.0	H	135.0
0.673576	---	39.07	---	71.04	31.97	1000.0	9.000	100.0	H	225.0
1.425562	---	31.61	---	64.52	32.91	1000.0	9.000	100.0	H	315.0
0.034093	---	---	53.78	136.95	83.17	1000.0	0.200	100.0	H	-27.0
0.050306	---	---	50.04	133.57	83.53	1000.0	0.200	100.0	H	112.0
0.152208	---	---	57.96	123.96	65.99	1000.0	9.000	100.0	H	229.0
0.155809	---	---	57.52	123.75	66.23	1000.0	9.000	100.0	H	63.0
0.171078	---	---	57.37	122.94	65.57	1000.0	9.000	100.0	H	45.0
0.197648	---	---	56.18	121.69	65.51	1000.0	9.000	100.0	H	-3.0

<b>Test mode condition</b>	Sub-GHz US High Channel (927.8 MHz)	
<b>Antenna orientation</b>	Loop Antenna Parallel to floor	
<b>Sweep frequency</b>	9 kHz-30 MHz	
<b>Standard</b>	47 CFR FCC Part 15 subpart C	
<b>EUT</b>	A002972080-001	
<b>Ancillary Equipment</b>	-	
<b>Test Engineer</b>	Simon Palmhager	Date: 2021-01-23
<b>Chamber details</b>	Chamber: SAC 5	

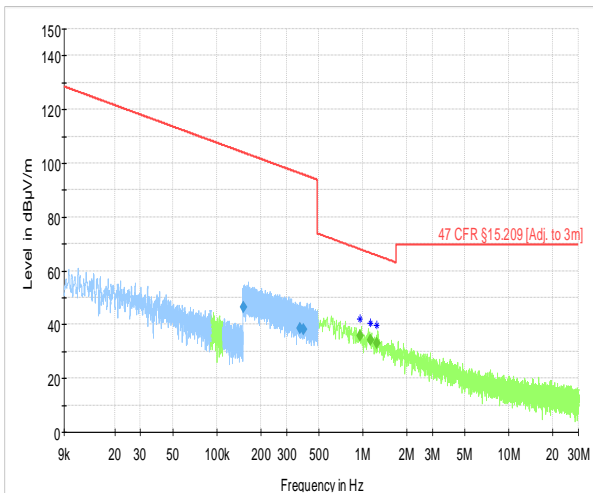

— Preview Result 2-PK+  
+ Critical\_Freqs PK+  
— 47 CFR §15.209 [Adj. to 3m]  
◆ Final\_Result QPK  
— Preview Result 1-AVG  
+ Critical\_Freqs AVG  
◆ Final\_Result AVG

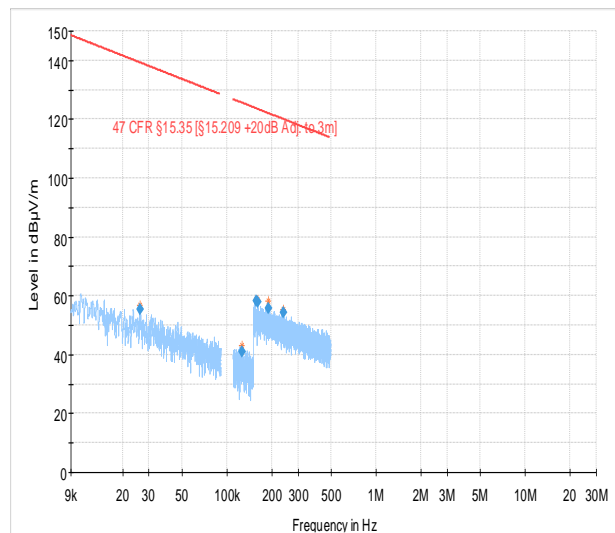

— Preview Result 1-PK+  
— 47 CFR §15.35 [§15.209 +20dB Adj. to 3m]  
+ Critical\_Freqs PK+  
◆ Final\_Result PK+

Frequency (MHz)	Average (dBµV/m)	QuasiPeak (dBµV/m)	MaxPeak (dBµV/m)	Limit (dBµV/m)	Margin (dB)	Meas. Time (ms)	Bandwidth (kHz)	Height (cm)	Pol	Azimuth (deg)
0.152652	46.58	---	---	103.93	57.35	1000.0	9.000	100.0	H	77.0
0.369899	38.73	---	---	96.24	57.51	1000.0	9.000	100.0	H	128.0
0.394042	38.18	---	---	95.69	57.51	1000.0	9.000	100.0	H	-26.0
0.953398	---	35.88	---	68.02	32.14	1000.0	9.000	100.0	H	25.0
1.125727	---	34.11	---	66.58	32.47	1000.0	9.000	100.0	H	45.0
1.244027	---	32.99	---	65.71	32.72	1000.0	9.000	100.0	H	281.0
0.026153	---	---	55.44	139.25	83.81	1000.0	0.200	100.0	H	113.0
0.126729	---	---	41.12	125.55	84.42	1000.0	0.200	100.0	H	135.0
0.157724	---	---	58.33	123.65	65.32	1000.0	9.000	100.0	H	100.0
0.160532	---	---	57.81	123.49	65.68	1000.0	9.000	100.0	H	139.0
0.189356	---	---	55.74	122.06	66.32	1000.0	9.000	100.0	H	153.0
0.238327	---	---	54.15	120.06	65.92	1000.0	9.000	100.0	H	49.0

<b>Test mode condition</b>	Sub-GHz US High Channel (927.8 MHz)	
<b>Antenna orientation</b>	Horizontal and Vertical	
<b>Sweep frequency</b>	30 MHz – 1 GHz	
<b>Standard</b>	47 CFR FCC Part 15 subpart C	
<b>EUT</b>	A002972080-001	
<b>Ancillary Equipment</b>	-	
<b>Test Engineer</b>	Niall Forrester	Date: 2020-12-23
<b>Chamber details</b>	Chamber: SAC 5	

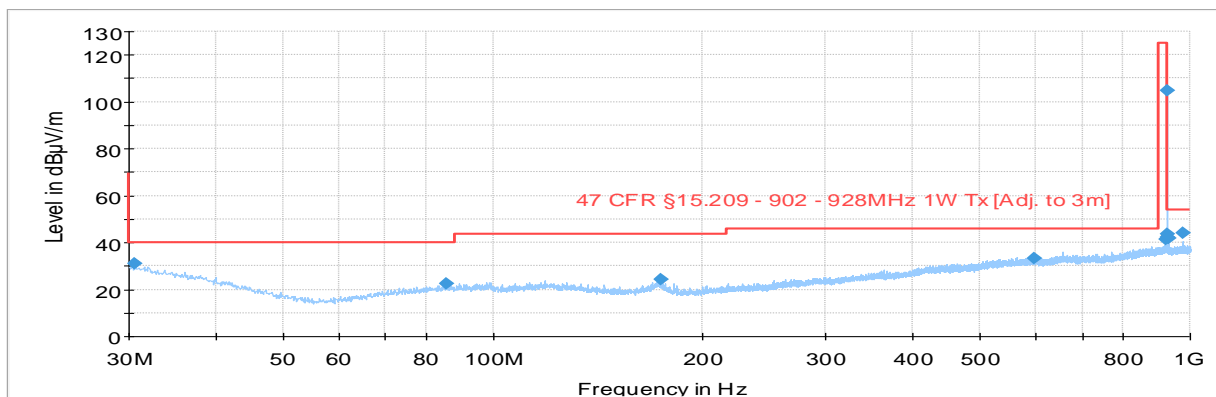

Frequency (MHz)	MaxPeak (dBµV/m)	Limit (dBµV/m)	Margin (dB)	Meas. Time (ms)	Bandwidth (kHz)	Height (cm)	Pol	Azimuth (deg)
30.610720	31.15	40.00	8.85	1000.0	120.000	204.0	V	202.0
85.609960	22.28	40.00	17.72	1000.0	120.000	125.0	V	206.0
174.196080	24.13	43.52	19.39	1000.0	120.000	404.0	V	142.0
596.309560	33.24	46.02	12.78	1000.0	120.000	125.0	V	324.0
923.852320	41.22	125.23	84.01	1000.0	120.000	206.0	H	292.0
925.766560	42.14	125.23	83.09	1000.0	120.000	100.0	H	112.0
927.804040	104.68	125.23	20.55	1000.0	120.000	100.0	H	278.0
929.262000	43.43	53.98	10.55	1000.0	120.000	100.0	H	116.0
931.840920	41.77	53.98	12.21	1000.0	120.000	100.0	H	109.0
975.797440	44.06	53.98	9.92	1000.0	120.000	100.0	H	112.0



<b>Test mode condition</b>	Sub-GHz US High Channel (927.8 MHz)	
<b>Antenna orientation</b>	Horizontal and Vertical	
<b>Sweep frequency</b>	1 GHz – 18 GHz	
<b>Standard</b>	47 CFR FCC Part 15 subpart C	
<b>EUT</b>	A002972080-001	
<b>Ancillary Equipment</b>	-	
<b>Test Engineer</b>	Simon Palmhager	Date: 2020-12-28
<b>Chamber details</b>	Chamber: SAC 5	

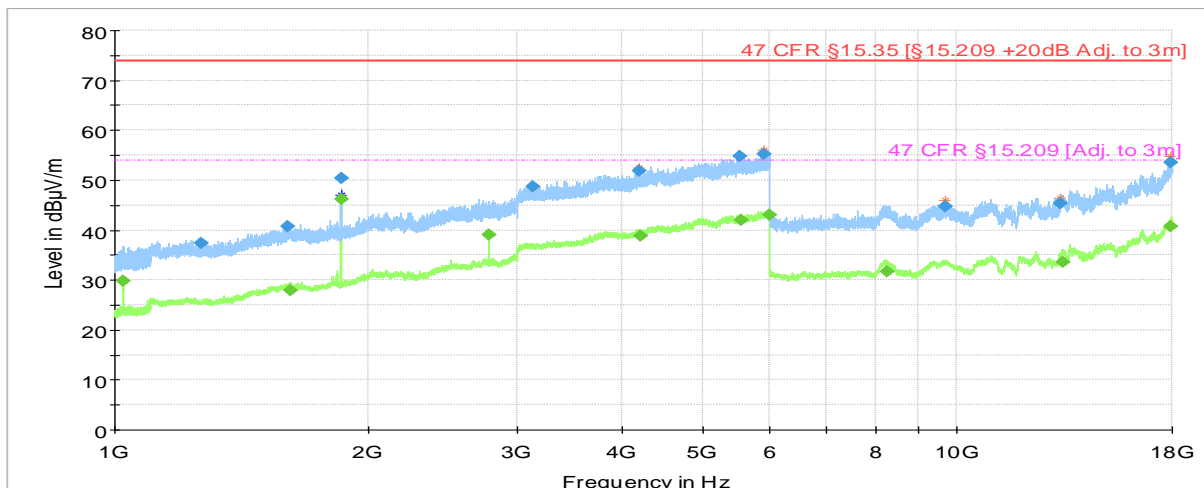

- Preview Result 2-AVG
- Preview Result 1-PK+
- \* Critical\_Freqs AVG
- \* Critical\_Freqs PK+
- 47 CFR §15.35 [§15.209 +20dB Adj. to 3m]
- 47 CFR §15.209 [Adj. to 3m]
- ◆ Final\_Result PK+
- ◆ Final\_Result AVG

Frequency (MHz)	MaxPeak (dBµV/m)	Average (dBµV/m)	Limit (dBµV/m)	Margin (dB)	Meas. Time (ms)	Bandwidth (kHz)	Height (cm)	Pol	Azimuth (deg)
1023.774000	---	29.73	53.98	24.25	1000.0	1000.000	197.0	H	26.0
1265.809000	37.31	---	73.98	36.67	1000.0	1000.000	206.0	V	248.0
1604.520000	40.78	---	73.98	33.20	1000.0	1000.000	169.0	V	26.0
1615.021000	---	27.99	53.98	25.99	1000.0	1000.000	187.0	V	190.0
1855.583000	---	46.28	53.98	7.70	1000.0	1000.000	175.0	H	162.0
1855.609000	50.45	---	73.98	23.53	1000.0	1000.000	175.0	H	177.0
2783.506000	---	38.96	53.98	15.02	1000.0	1000.000	175.0	H	177.0
3134.284000	48.70	---	73.98	25.28	1000.0	1000.000	175.0	H	68.0
4192.526000	51.97	---	73.98	22.01	1000.0	1000.000	100.0	H	280.0
4207.798000	---	38.76	53.98	15.22	1000.0	1000.000	125.0	V	-22.0
5531.751000	54.74	---	73.98	19.23	1000.0	1000.000	125.0	V	116.0
5534.311000	---	41.91	53.98	12.07	1000.0	1000.000	175.0	V	206.0
5893.480000	55.18	---	73.98	18.80	1000.0	1000.000	175.0	H	54.0
5982.066000	---	43.02	53.98	10.96	1000.0	1000.000	125.0	V	41.0
8250.215000	---	31.63	53.98	22.35	1000.0	1000.000	175.0	H	68.0
9665.281000	44.79	---	73.98	29.19	1000.0	1000.000	111.0	H	14.0
13278.957000	45.43	---	73.98	28.55	1000.0	1000.000	210.0	V	112.0
13374.812000	---	33.59	53.98	20.39	1000.0	1000.000	175.0	V	248.0
17947.799000	53.49	---	73.98	20.49	1000.0	1000.000	100.0	H	68.0
17961.737000	---	40.84	53.98	13.14	1000.0	1000.000	125.0	H	158.0

## 4.3 Test Results – Antenna Conducted Emissions

### 4.3.1 Antenna Conducted Emissions – Test Summary

Emissions measurements performed as radiated test (see section 4.2)

## 4.4 Test Results – Band Edge Compliance (Authorized Band)

### 4.4.1 Band Edge Compliance (Authorized Band) – Test Summary

<b>Test Specification</b>	47 CFR 15.247 (d)			
<b>Test Engineer &amp; Date</b>	Sam Ebadeh	2021.02.22 – 2021.04.12		
<b>EUT and Ancillary Equipment IDs</b>	A002965790-011 A003002493-001	A002972080-007		
<b>EUT Operation Mode(s)</b>	Continuous Tx / Continuous Hopping			
<b>EUT Wireless Configuration(s)</b>	IEEE 802.15.4g Sub-GHz US (see below for details)			
<b>EUT Hardware Configuration(s)</b>	Power from Lab Power Supply.			
<b>Overall Result</b>	PASS			
Test Parameter	Wireless Configuration	Measured Level (dBm)	Limit (dBm)	Result
Emissions at Band Edge (Auth. Band – Low Edge)	IEEE 802.15.4g Sub-GHz US Low Channel (2-GFSK 902.2 MHz)	-55.604	-11.054	PASS
Emissions at Band Edge (Auth. Band – Low Edge)	IEEE 802.15.4g Sub-GHz US Low Channel (2-GFSK 902.2 MHz)	-55.403	-11.054	PASS
Emissions at Band Edge (Auth. Band – Low Edge)	IEEE 802.15.4g Sub-GHz US Hopping (2-GFSK)	-40.965	-10.884	PASS
Emissions at Band Edge (Auth. Band – High Edge)	IEEE 802.15.4g Sub-GHz US High Channel (2-GFSK 927.8 MHz)	-55.970	-10.859	PASS
Emissions at Band Edge (Auth. Band – High Edge)	IEEE 802.15.4g Sub-GHz US High Channel (2-GFSK 927.8 MHz)	-55.008	-10.859	PASS
Emissions at Band Edge (Auth. Band – High Edge)	IEEE 802.15.4g Sub-GHz US Hopping (2-GFSK)	-55.230	-10.884	PASS

#### 4.4.2 Band Edge Compliance (Authorized Band) – Test Details Low Channel

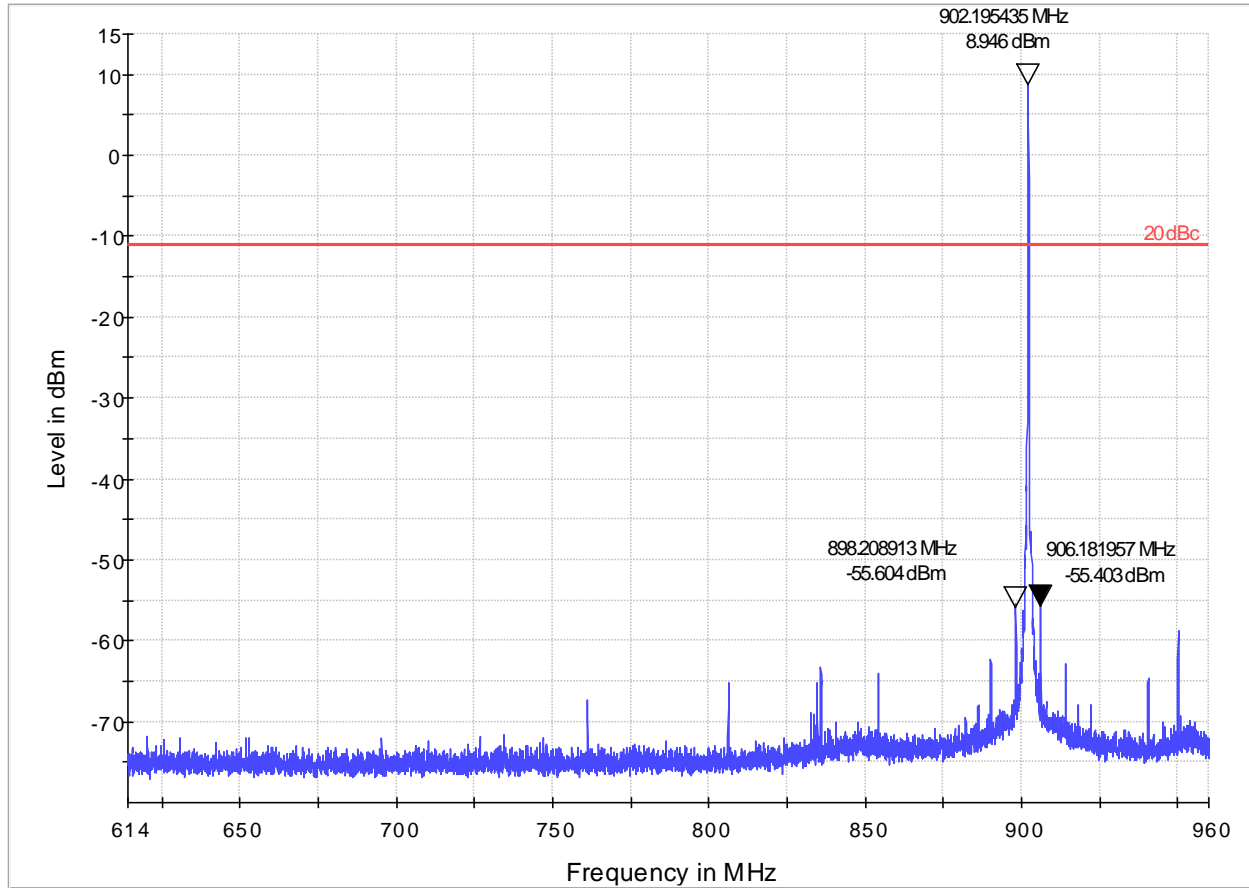

### High Channel

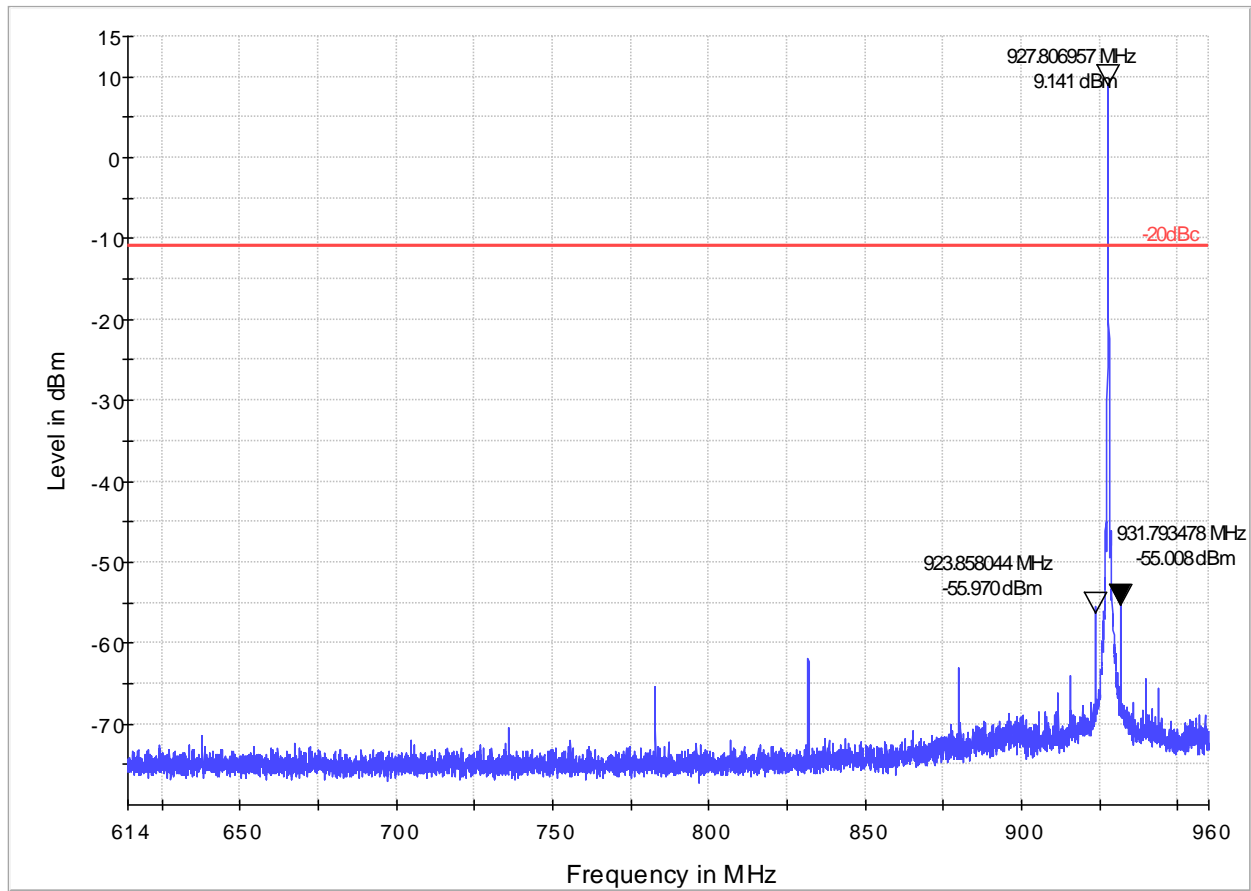

### Hopping

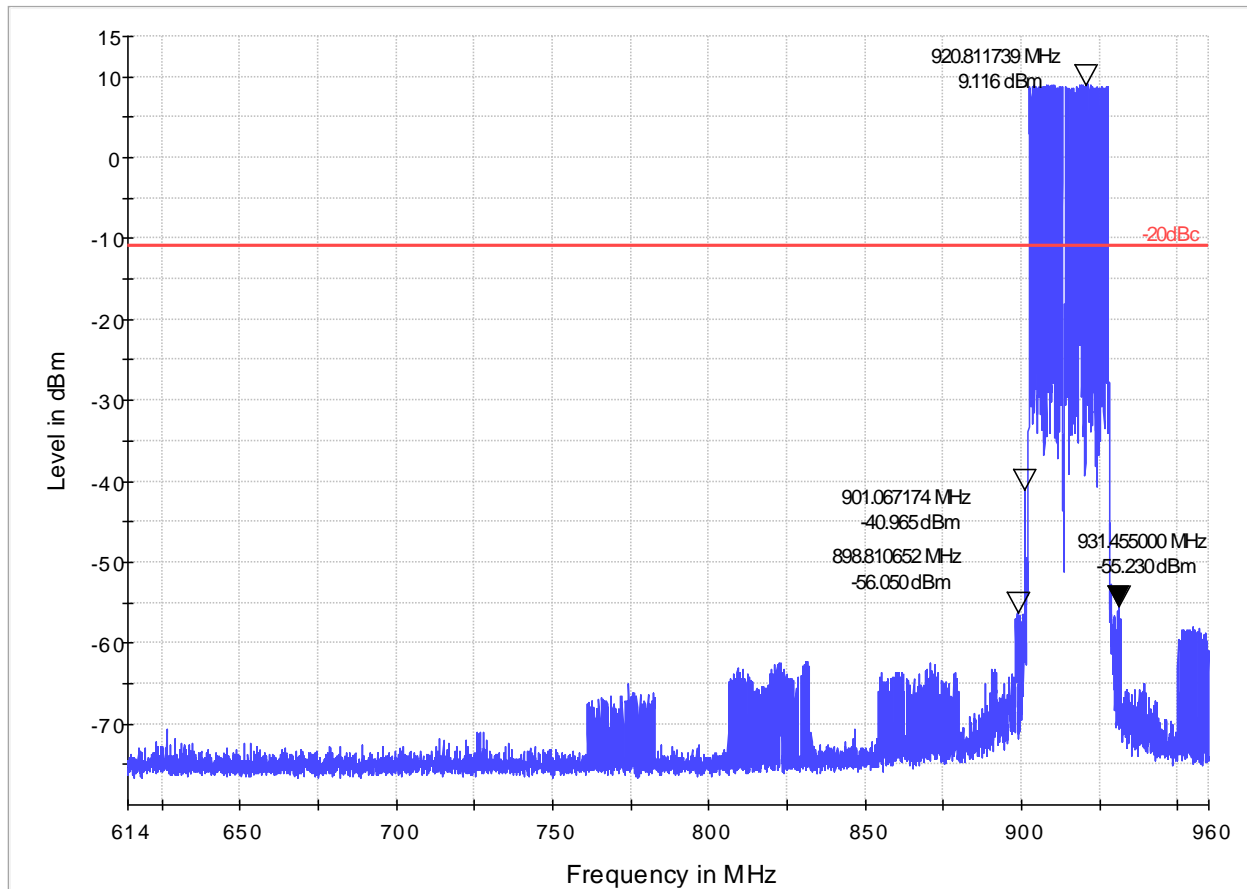

## 4.5 Test Results – Band Edge Compliance (Restricted Band)

### 4.5.1 Band Edge Compliance (Restricted Band) – Test Summary

<b>Test Specification</b>	47 CFR 15.209 & 15.247 (d)	
<b>Test Engineer &amp; Date</b>	Niall Forrester	2020.12.22 – 2020.12.23
<b>EUT and Ancillary Equipment IDs</b>	A002972080-001	-
<b>EUT Operation Mode(s)</b>	Continuous Tx	
<b>EUT Wireless Configuration(s)</b>	IEEE 802.15.4g Sub-GHz US (see below for details)	
<b>EUT Hardware Configuration(s)</b>	-	
<b>Overall Result</b>	PASS	
<b>Test Parameter</b>	<b>Wireless Configuration</b>	<b>Result*</b>
Emissions at Band Edge (Rest. Band – Low Edge)	IEEE 802.15.4g Sub-GHz US Low Channel (2-GFSK 902.2 MHz)	PASS
Emissions at Band Edge (Rest. Band – High Edge)	IEEE 802.15.4g Sub-GHz US High Channel (2-GFSK 927.8 MHz)	PASS

\* For detailed measurements, see tables and graphs in sections below

**4.5.2 Band Edge Compliance (Restricted Band) – Test Details**  
**Restricted Band – Low Edge**

<b>Test mode condition</b>	Bluetooth Low Energy 1M, Low channel (2402 MHz)	
<b>Antenna orientation</b>	Horizontal and Vertical	
<b>Sweep frequency</b>	1 GHz – 18 GHz Lower Band Edge	
<b>Standard</b>	47 CFR FCC Part 15 subpart C	
<b>EUT</b>	A002972080-001	
<b>Ancillary Equipment</b>	-	
<b>Test Engineer</b>	Niall Forrester	Date: 2020-12-22
<b>Chamber details</b>	Chamber: SAC 5	

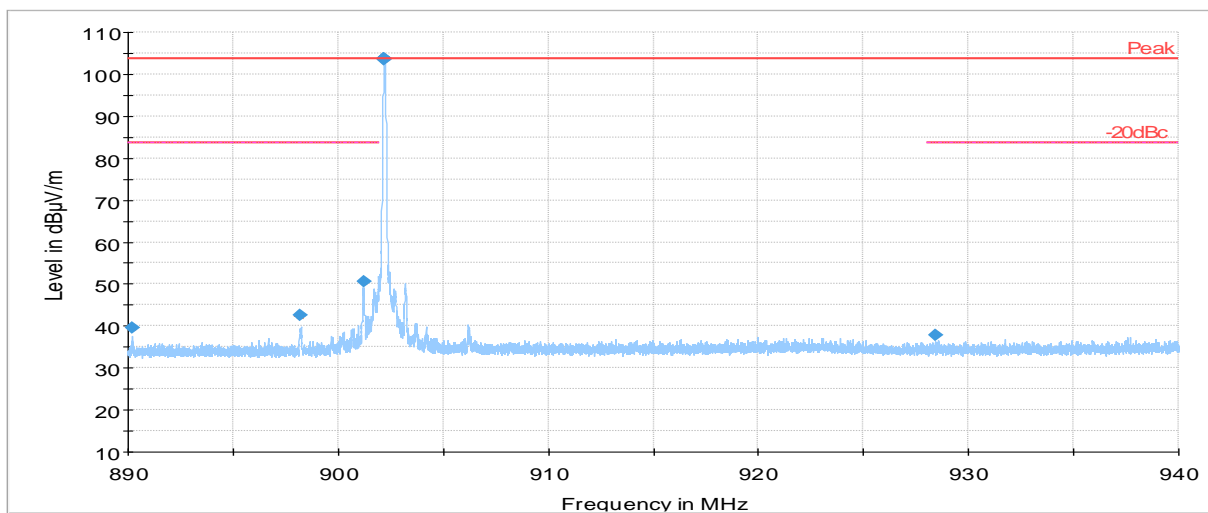

— Preview Result 2-AVG      — Preview Result 1-PK+      \* Critical\_Freqs AVG  
◆ Critical\_Freqs PK+      — -20dBc      ◆ Final\_Result PK+  
◆ Final\_Result AVG      — -20dBc      — Peak

Frequency (MHz)	MaxPeak (dBµV/m)	Limit (dBµV/m)	Margin (dB)	Meas. Time (ms)	Bandwidth (kHz)	Height (cm)	Pol	Azimuth (deg)
890.184170	39.59	83.72	44.13	1000.0	100.000	100.0	H	279.0
898.194400	42.52	83.72	41.20	1000.0	100.000	100.0	H	112.0
901.211200	50.66	83.72	33.06	1000.0	100.000	100.0	H	292.0
902.195000	103.47	---	---	1000.0	100.000	100.0	H	112.0
902.202800	103.72	---	---	1000.0	100.000	100.0	H	278.0
902.204300	103.71	---	---	1000.0	100.000	100.0	H	278.0
902.205400	103.71	---	---	1000.0	100.000	100.0	H	278.0
928.407600	37.87	83.72	45.85	1000.0	100.000	325.0	H	296.0

**Restricted Band – High Edge**

<b>Test mode condition</b>	Bluetooth Low Energy 1M, High channel (2480 MHz)	
<b>Antenna orientation</b>	Horizontal and Vertical	
<b>Sweep frequency</b>	1 GHz – 18 GHz Upper Band Edge	
<b>Standard</b>	47 CFR FCC Part 15 subpart C	
<b>EUT</b>	A002972080-001	
<b>Ancillary Equipment</b>	-	
<b>Test Engineer</b>	Niall Forrester	Date: 2020-12-23
<b>Chamber details</b>	Chamber: SAC 5	

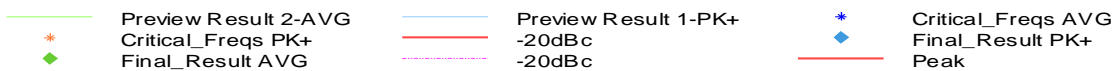
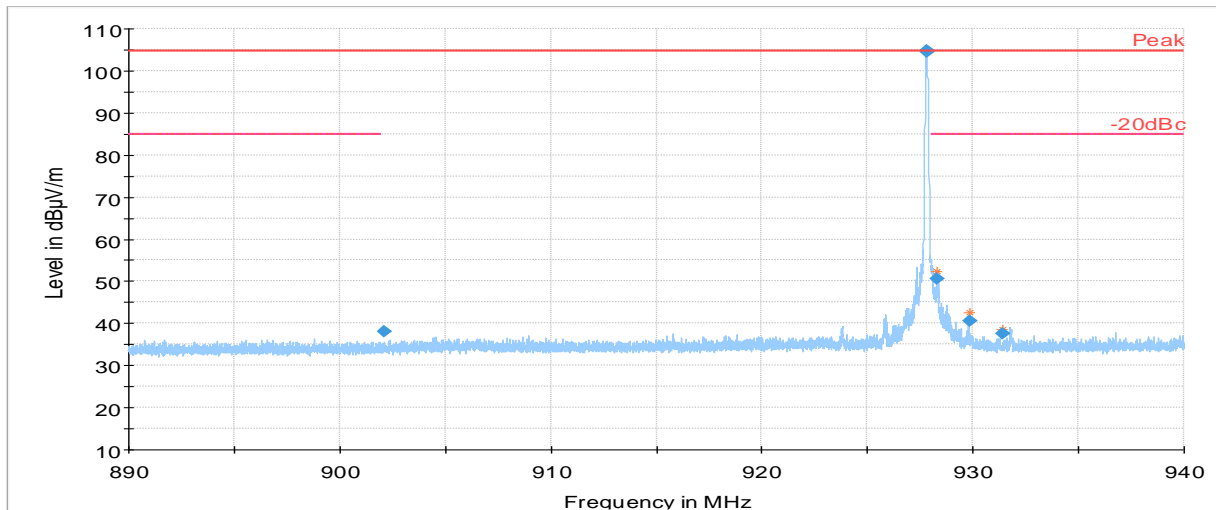

Frequency (MHz)	MaxPeak (dBµV/m)	Limit (dBµV/m)	Margin (dB)	Meas. Time (ms)	Bandwidth (kHz)	Height (cm)	Pol	Azimuth (deg)
902.135300	38.07	---	---	1000.0	100.000	403.0	V	109.0
927.803200	104.67	---	---	1000.0	100.000	100.0	H	112.0
927.803400	104.82	---	---	1000.0	100.000	100.0	H	292.0
927.803700	104.65	---	---	1000.0	100.000	100.0	H	112.0
927.804900	104.59	---	---	1000.0	100.000	100.0	H	278.0
928.312200	50.54	84.82	34.28	1000.0	100.000	100.0	H	267.0
929.818900	40.55	84.82	44.27	1000.0	100.000	100.0	H	266.0
931.390200	37.46	84.82	47.36	1000.0	100.000	370.0	H	22.0



## 4.6 Test Results – 20dB Bandwidth

### 4.6.1 20dB Bandwidth – Test Summary

<b>Test Specification</b>	47 CFR 15.247 (a)(1)			
<b>Test Engineer &amp; Date</b>	Sam Ebadeh	2021.06.24		
<b>EUT and Ancillary Equipment IDs</b>	A002965790-011	-		
<b>EUT Operation Mode(s)</b>	Continuous Tx			
<b>EUT Wireless Configuration(s)</b>	IEEE 802.15.4g Sub-GHz US (see below for details)			
<b>EUT Hardware Configuration(s)</b>	Power from Lab Power Supply.			
<b>Overall Result</b>	PASS			
Test Parameter	Wireless Configuration	Bandwidth (kHz)	Limit (kHz)	Result
20dB Bandwidth	IEEE 802.15.4g Sub-GHz US Low Channel (2-GFSK 902.2 MHz)	103.89	500	PASS
20dB Bandwidth	IEEE 802.15.4g Sub-GHz US Mid Channel (2-GFSK 915.0 MHz)	104.62	500	PASS
20dB Bandwidth	IEEE 802.15.4g Sub-GHz US High Channel (2-GFSK 927.8 MHz)	104.02	500	PASS

4.6.2 20dB Bandwidth – Test Details (Worst Case Plot)

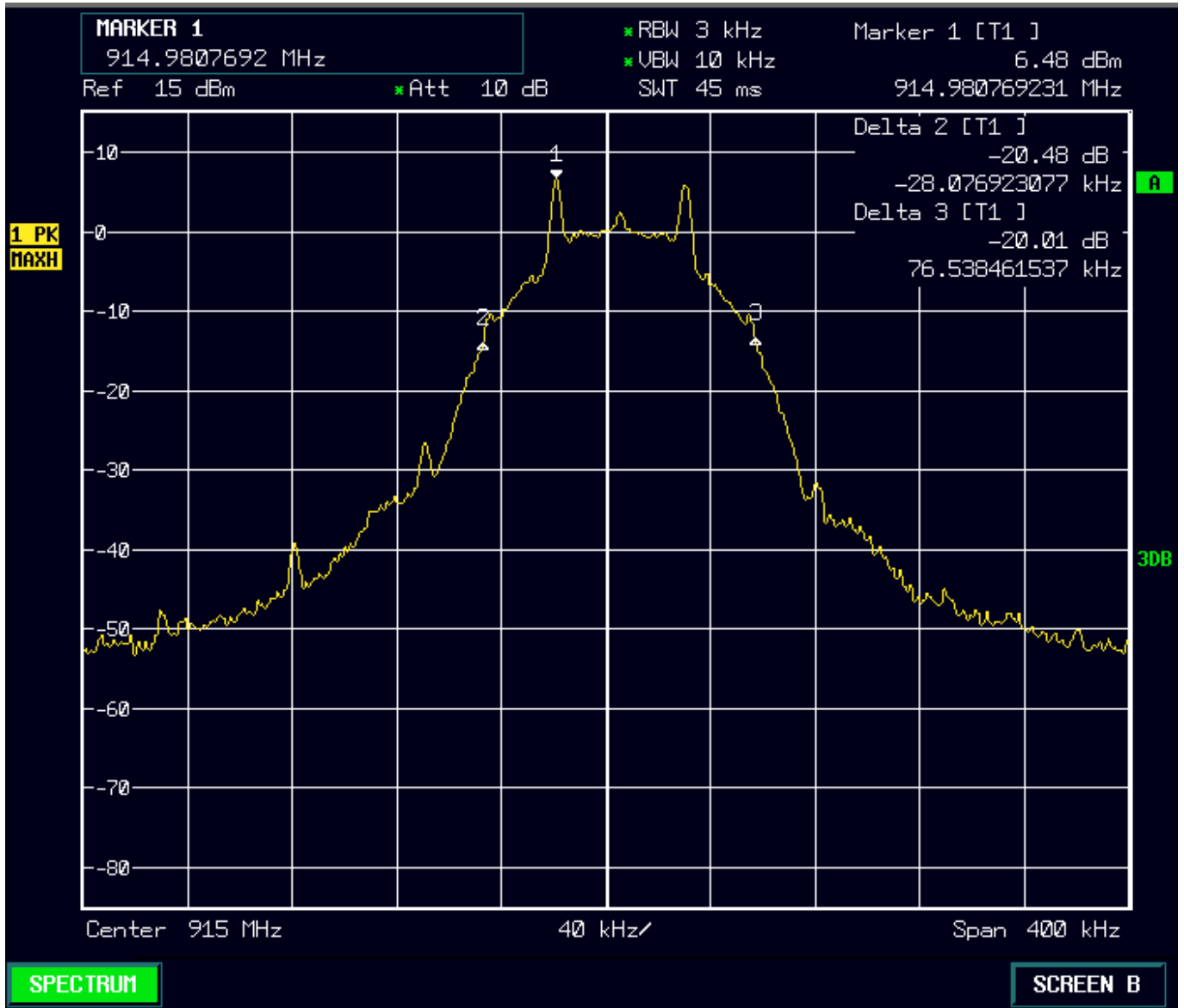

## 4.7 Test Results – Carrier (Hopping Channel) Separation

### 4.7.1 Carrier (Hopping Channel) Separation – Test Summary

<b>Test Specification</b>	47 CFR 15.247 (a)(1)			
<b>Test Engineer &amp; Date</b>	Sam Ebadeh	2021.03.26		
<b>EUT and Ancillary Equipment IDs</b>	A003002493-001	-		
<b>EUT Operation Mode(s)</b>	Continuous Hopping			
<b>EUT Wireless Configuration(s)</b>	IEEE 802.15.4g Sub-GHz US (see below for details)			
<b>EUT Hardware Configuration(s)</b>	Power from USB Charger.			
<b>Overall Result</b>	PASS			
<b>Test Parameter</b>	<b>Wireless Configuration</b>	<b>Separation (kHz)</b>	<b>Limit (kHz)</b>	<b>Result</b>
Carrier Frequency Separation	IEEE 802.15.4g Sub-GHz US Hopping (2-GFSK)	198.80	<500	PASS

#### 4.7.2 Carrier (Hopping Channel) Separation – Test Details (Plot)

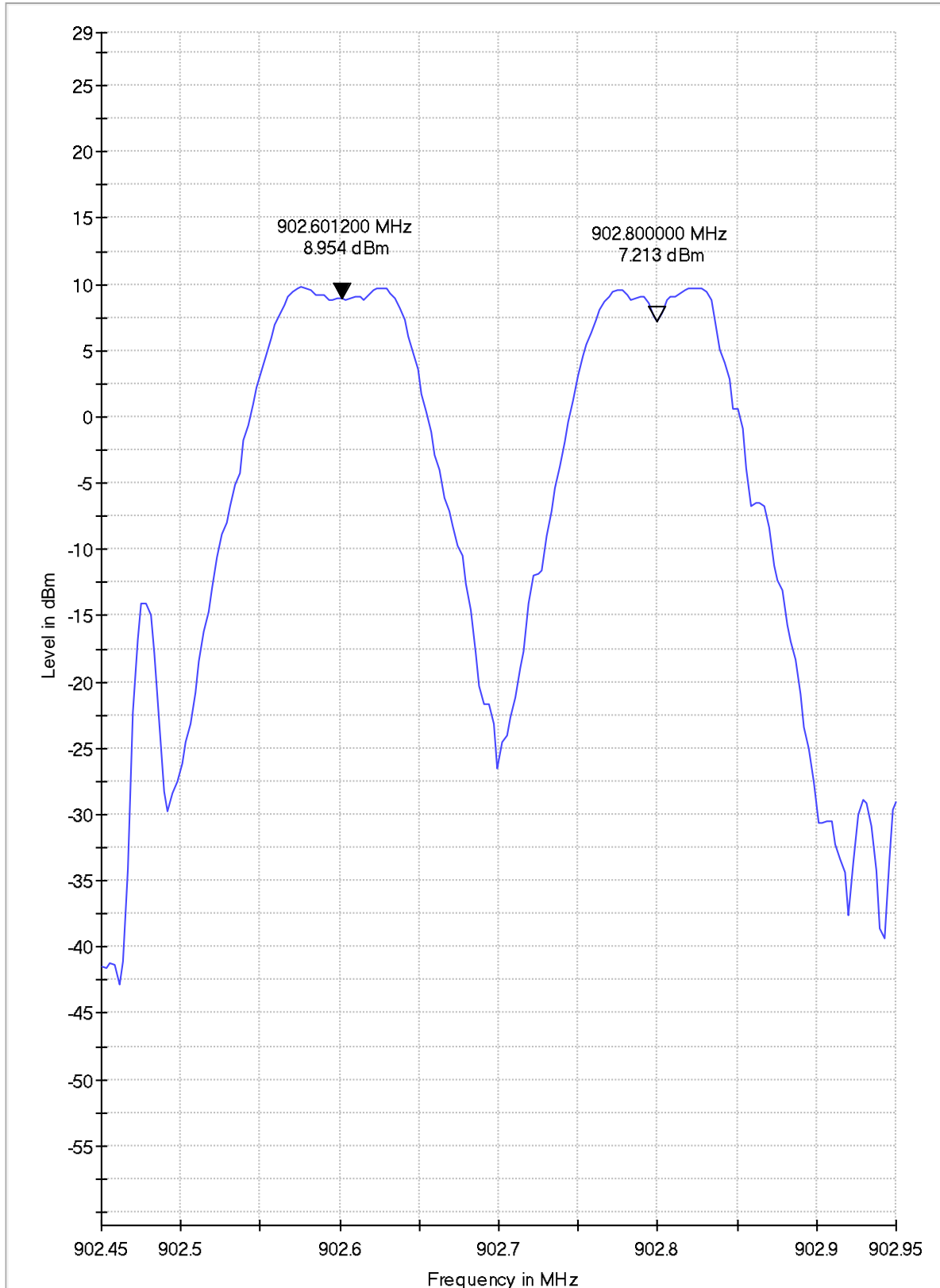

## 4.8 Test Results – Number of Hopping Channels

### 4.8.1 Number of Hopping Channels – Test Summary

<b>Test Specification</b>	47 CFR 15.247 (a)(1)			
<b>Test Engineer &amp; Date</b>	Sam Ebadeh	2021.03.23		
<b>EUT and Ancillary Equipment IDs</b>	A003002493-001	-		
<b>EUT Operation Mode(s)</b>	Continuous Hopping			
<b>EUT Wireless Configuration(s)</b>	IEEE 802.15.4g Sub-GHz US (see below for details)			
<b>EUT Hardware Configuration(s)</b>	Power from USB Charger.			
<b>Overall Result</b>	PASS			
Test Parameter	Wireless Configuration	Measured Number	Limit (Min)	Result
Number of Hopping Channels	IEEE 802.15.4g Sub-GHz US Hopping (2-GFSK)	50	50	PASS

### 4.8.2 Number of Hopping Channels – Test Details

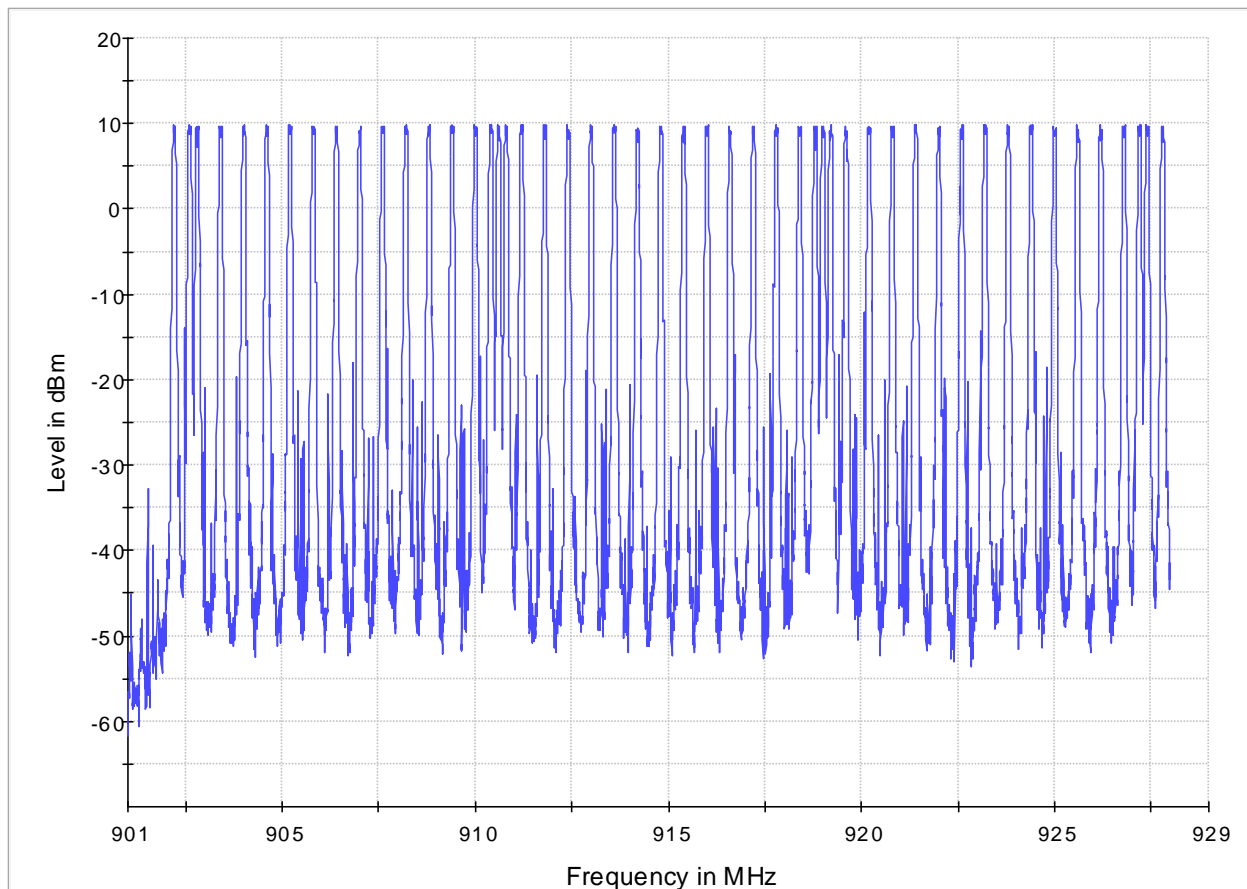

## 4.9 Test Results – Time of Occupancy (Dwell Time)

### 4.9.1 Time of Occupancy (Dwell Time) – Test Summary

Test Specification	47 CFR 15.247 (a)(1)			
Test Engineer & Date	Sam Ebadeh	2021.03.23		
EUT and Ancillary Equipment IDs	A003002493-001	-		
EUT Operation Mode(s)	Continuous Hopping			
EUT Wireless Configuration(s)	IEEE 802.15.4g Sub-GHz US (see below for details)			
EUT Hardware Configuration(s)	Power from USB Charger.			
Overall Result	PASS			
Test Parameter	Wireless Configuration	Measured Time (ms)	Limit (ms)	Result
Dwell Time	IEEE 802.15.4g Sub-GHz US Hopping (2-GFSK)	115.58	400	PASS

### 4.9.2 Time of Occupancy (Dwell Time) – Test Details

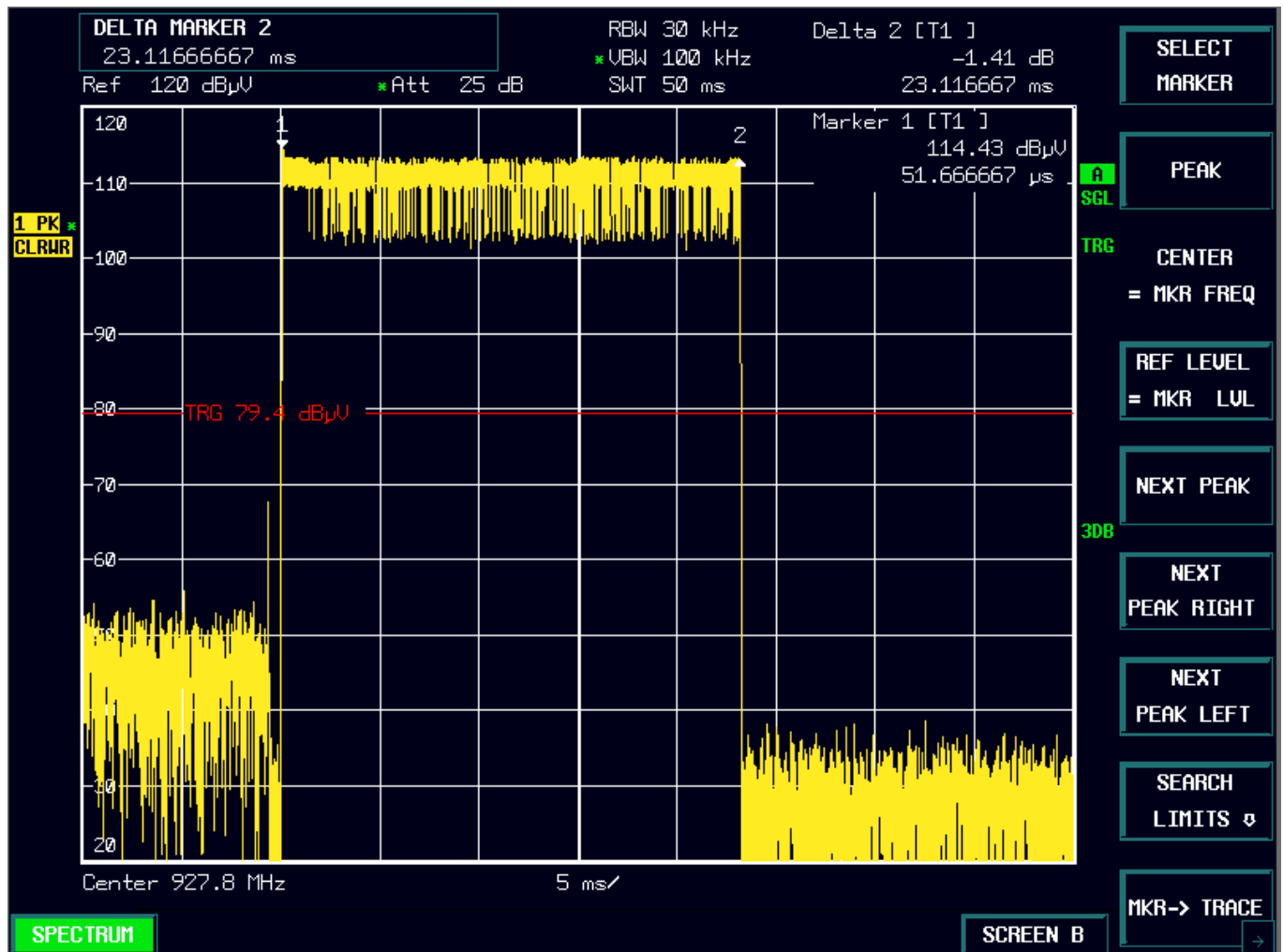

Time of occupancy (Single hop) = 23.116667 mS

Number of hops in 20s period = 5

Average Time of Occupancy = 5 x 23.11667 mS = 115.583335 mS

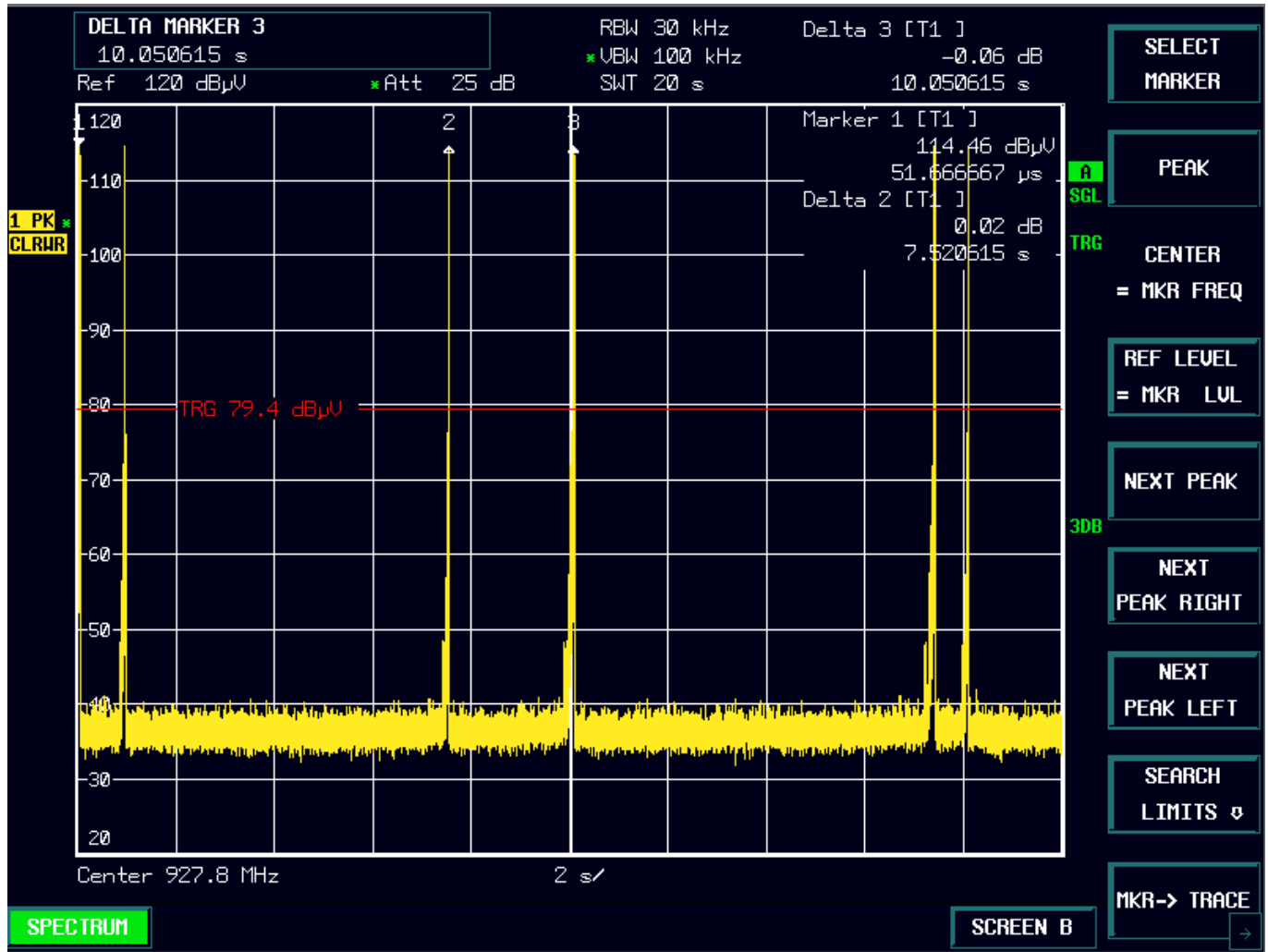

## 4.10 Test Results – 6dB Bandwidth

### 4.10.1 6dB Bandwidth – Test Summary

Requirement is not applicable as the device supports frequency hopping

## 4.11 Test Results – Peak Conducted Output Power

### 4.11.1 Peak Conducted Output Power – Test Summary

<b>Test Specification</b>	47 CFR 15.247(b)	
<b>Test Engineer &amp; Date</b>	Sam Ebadeh	2021.03.15
<b>EUT and Ancillary Equipment IDs</b>	A002965790-011	-
<b>EUT Operation Mode(s)</b>	Continuous Tx	
<b>EUT Wireless Configuration(s)</b>	IEEE 802.15.4g Sub-GHz US (see below for details)	
<b>EUT Hardware Configuration(s)</b>	Power from Lab Power Supply.	
<b>Overall Result</b>	PASS	

Test Parameter	Wireless Configuration	Measured Level (dBm)			Limit (dBm)	Result
		Low 2.40V	Nom 3.70V	High 5.50V		
Peak Conducted Output Power	IEEE 802.15.4g Sub-GHz US Low Channel (2-GFSK 902.2 MHz)	9.30	9.29	9.28	30	PASS
Peak Conducted Output Power	IEEE 802.15.4g Sub-GHz US Mid Channel (2-GFSK 915.0 MHz)	9.20	9.20	9.20	30	PASS
Peak Conducted Output Power	IEEE 802.15.4g Sub-GHz US High Channel (2-GFSK 927.8 MHz)	9.15	9.15	9.15	30	PASS



**4.11.2 Peak Conducted Output Power – Test Details (Worst Case Plot)**  
**IEEE 802.15.4g – Low Channel – Low Voltage**

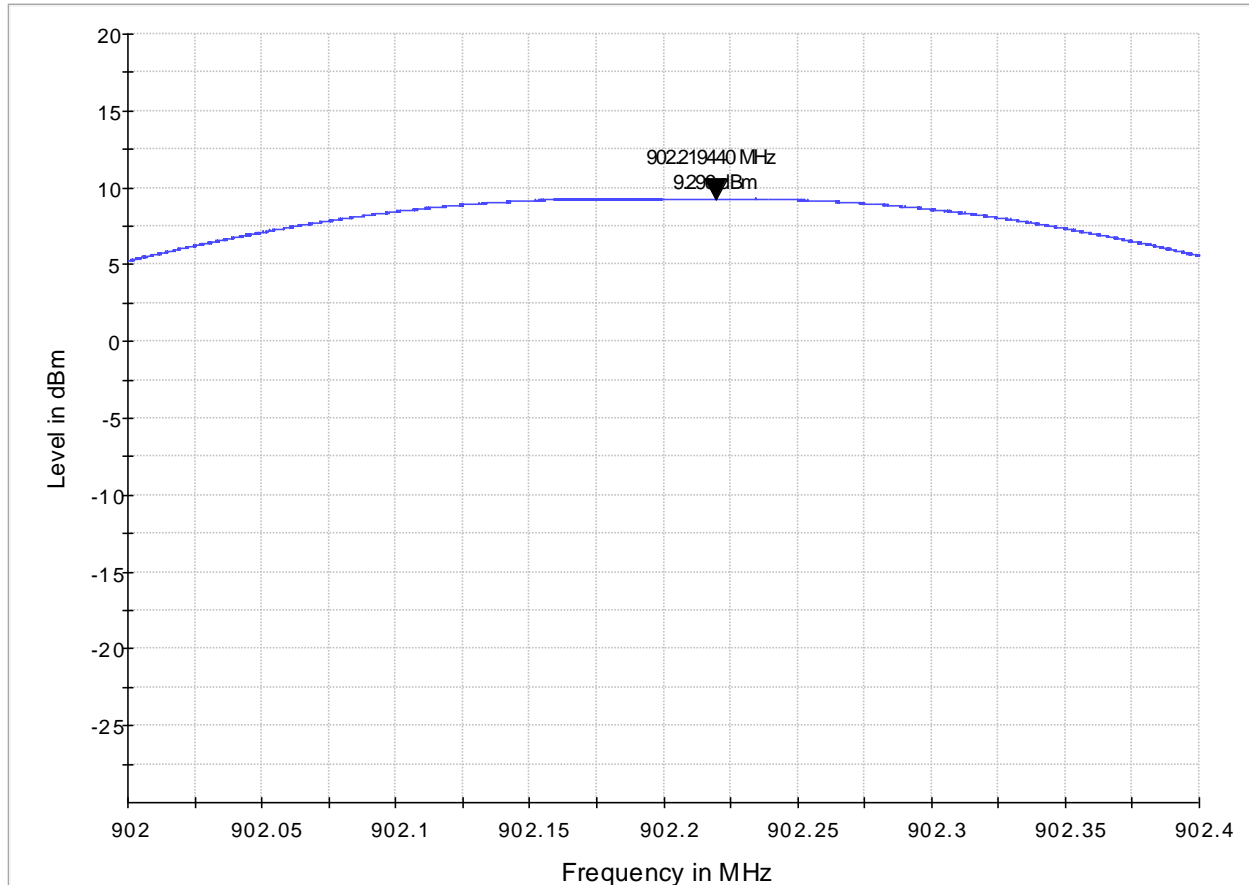

IEEE 802.15.4g – Mid Channel – Low Voltage

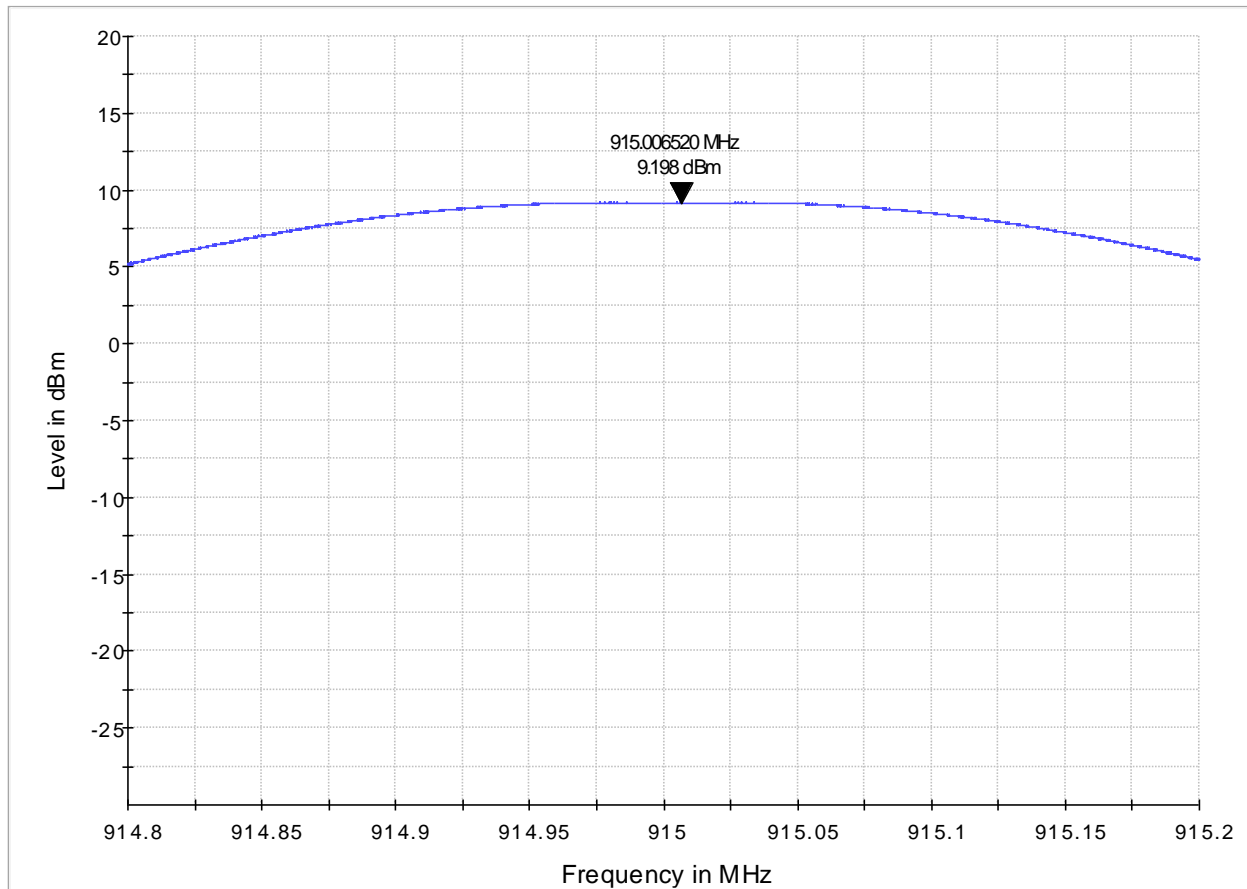

IEEE 802.15.4g – High Channel – Low Voltage

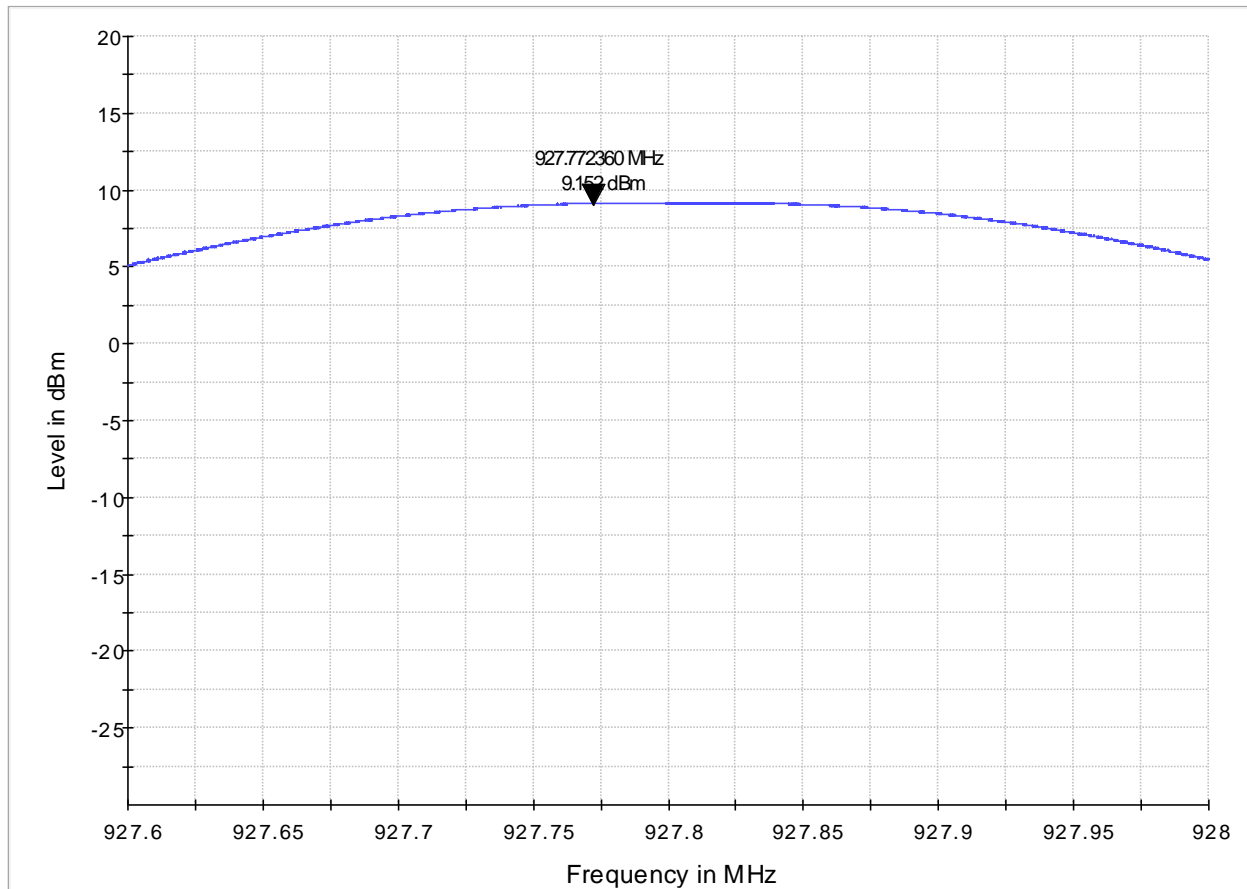

## 4.12 Test Results – Power Spectral Density

### 4.12.1 Power Spectral Density – Test Summary

Requirement is not applicable as the device supports frequency hopping

## 5. TEST EQUIPMENT STATUS

### 5.1 List of Hardware with Calibration Dates

#### 5.1.1 Hardware List – Conducted RF System

Type	Manufacturer	Model	Serial Number / ID	Calibration Date	Calibration Due
Spectrum Analyzer	Rohde & Schwarz	FSU26	100308 2704108	14.07.2020	14.07.2021
Temp. & Humidity Logger	Lufft	Opus 20	113.0118.0802.033 2771025	31.07.2020	31.07.2022

#### 5.1.2 Hardware List – Conducted Emissions System

Type	Manufacturer	Model	Serial Number / ID	Calibration Date	Calibration Due
Two-Line V-network	Rohde & Schwarz	ENV216	101090 2704076	2020.07.16	2021.07.16
Test Receiver 9KHz to 3.5 GHz	Rohde & Schwarz	ESR3	101674 2704016	2020.07.17	2021.07.17

#### 5.1.3 Hardware List – SAC5 System

Type	Manufacturer	Model	Serial Number / ID	Calibration Date	Calibration Due
EMI Test Receiver	Rohde & Schwarz	ESW44	101760 2881044	2020.07.17	2021.07.17
Ultra Broadband Antenna	Rohde & Schwarz	HL562E	100988 2823181	2019.07.23	2021.07.23
Double Ridged Waveguide Horn Antenna	Rohde & Schwarz	HF907	102678 2823164	2019.07.15	2021.07.15
Control Device	Maturo	NCD	NCD/393/2372.01	N/A	N/A
Open Switch & Control Unit	Rohde & Schwarz	OSP150	100081 2884198	2020.08.04	2021.08.04
Open Switch & Control Unit	Rohde & Schwarz	OSP120	100084 2761253	2020.08.04	2021.08.04
Shielded Filter Unit	Rohde & Schwarz	OSP-F Extension 1	101333 2761265	2020.08.04	2021.08.04
Shielded Filter Unit	Rohde & Schwarz	OSP-F Extension 2	101335 2761266	2020.08.04	2021.08.04
Shielded Filter Unit	Rohde & Schwarz	OSP-F Base Unit	101330 2761262	2020.08.04	2021.08.04
Humidity Temperature Probe	Lufft	OPUS 20	1236.0118.0802.033 2771042	2020.07.31	2022.07.31

## 5.2 Software / Firmware Versions

Equipment	Software / Firmware Name	Version
Conducted RF	EMC 32	V10.60.10
Conducted Emissions System	EMC 32	V10.60.10
SAC 5	EMC 32	V10.60.10

## 6. MEASUREMENT UNCERTAINTY

### 6.1 Measurement Uncertainty for Conducted RF

Parameter	Uncertainty (Coverage Factor k=2)
Maximum Output Power (15.247b)	±0.51 dB
6dB / 20dB Channel Bandwidth & 99% Occupied bandwidth (15.247a)	<5%
Carrier Frequency Separation (15.247a)	N/A
Number of Hopping Channels (15.247a)	N/A
Time of Occupancy – Dwell Time (15.247a)	N/A
Band Edge Compliance of Conducted Emissions (15.247a)	±1.04 dB
Conducted Spurious Emissions (15.247d)	±2.98 dB
Power Spectral Density (15.247e)	±0.51 dB

### 6.2 Measurement Uncertainty for Conducted Emissions

Parameter	Uncertainty (Coverage Factor k=2)
Conducted emissions with LISN 150KHz to 30 MHz	2.98 dB

### 6.3 Measurement Uncertainty for SAC 5 (Radiated Emissions & Band Edge)

Parameter	Uncertainty (Coverage Factor $k=2$ )
Field Strength 10 Hz -9 kHz	3.38 dB
Field Strength 9 kHz -30 MHz	3.38 dB
Field Strength 30 MHz -1000 MHz	3.38 dB
Field Strength 1 GHz -18 GHz	4.88 dB
Field Strength 18 GHz - 40 GHz	5.14 dB

## 7. PHOTOGRAPHS

For photographs, see Appendix 1