



# OTA Performance Measurement Report

Report Ref. No.

T141126D01

**Applicant:**

Zeroplus Technology Co.,Ltd

**Date of Application:** 2014/11/26

**Test Period:** 2014/12/1

**Date of Issue:**2014/12/5

**Test Lab Info:**

Compliance Certification Services Inc.  
No.11, Wugong 6<sup>th</sup> Rd., Wugu Industrial Park.  
Taipei Hsien 248, Taiwan, R.O.C.

## Test Item

**Name of Product:**

Antenna Gain

**Brand Name:**

ZEROPLUS

**Model/ Ref. No:**



RDA5875Y

**Name and Address of Manufacturer:**

2F., No. 123, Jian 8th Rd., Zhonghe Dist., New Taipei City 23585, Taiwan

**Remarks:**

2402MHz~2480MHz  
3D Gain Measurement Results

Confirmation	Approved by 	Tested by 
--------------	--	---

*Note: This report shall not be reproduced except in full, without the written approval of Compliance Certification Services Inc. This document may be altered or revised by Compliance Certification Services Inc. personnel only, and shall be noted in the revision section of the document.*



### Revision History

Rev.	Issue Date	Revisions	Effect Page	Revised By
00	2014/12/5	Initial Issue	ALL	Eason.k.liu



## Table Of Contents

<b>1</b>	<b>GENERAL INFORMATION.....</b>	<b>4</b>
1.1	DESCRIPTION OF DEVICE UNDER TEST (DUT) .....	4
1.2	PRODUCT PHOTO .....	4
<b>2</b>	<b>SUMMARY OF TEST RESULT .....</b>	<b>5</b>
2.1	AMBIENT CONDITION .....	6
<b>3</b>	<b>DESCRIPTION FOR DUT TESTING POSITION .....</b>	<b>7</b>
<b>4</b>	<b>2D TEST PLOTTING .....</b>	<b>8</b>
<b>5</b>	<b>3D TEST PLOTTING .....</b>	<b>17</b>



## 1 General Information

### 1.1 Description of Device Under Test (DUT)

Product Feature & Specification	
Brand Name	ZEROPLUS
Model Name	RDA5875Y
Frequency	2402MHz~2480MHz

### 1.2 Product Photo

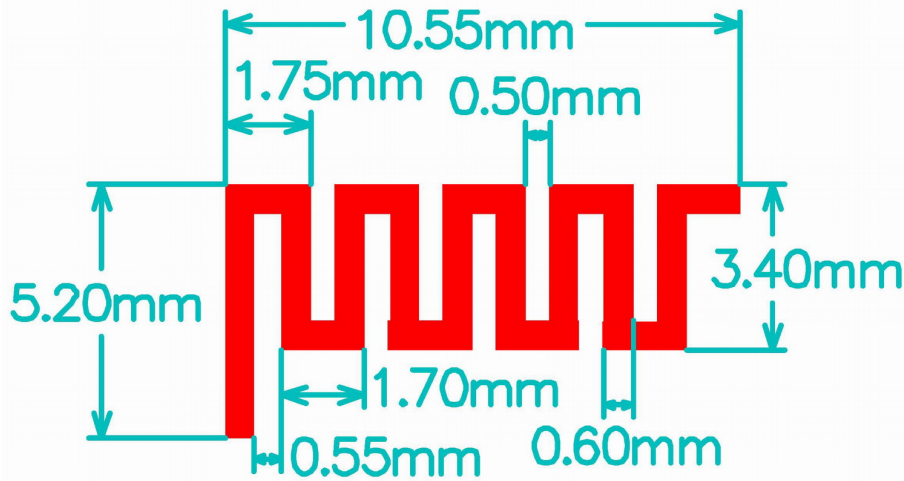



### 1.3 Equipment Photo

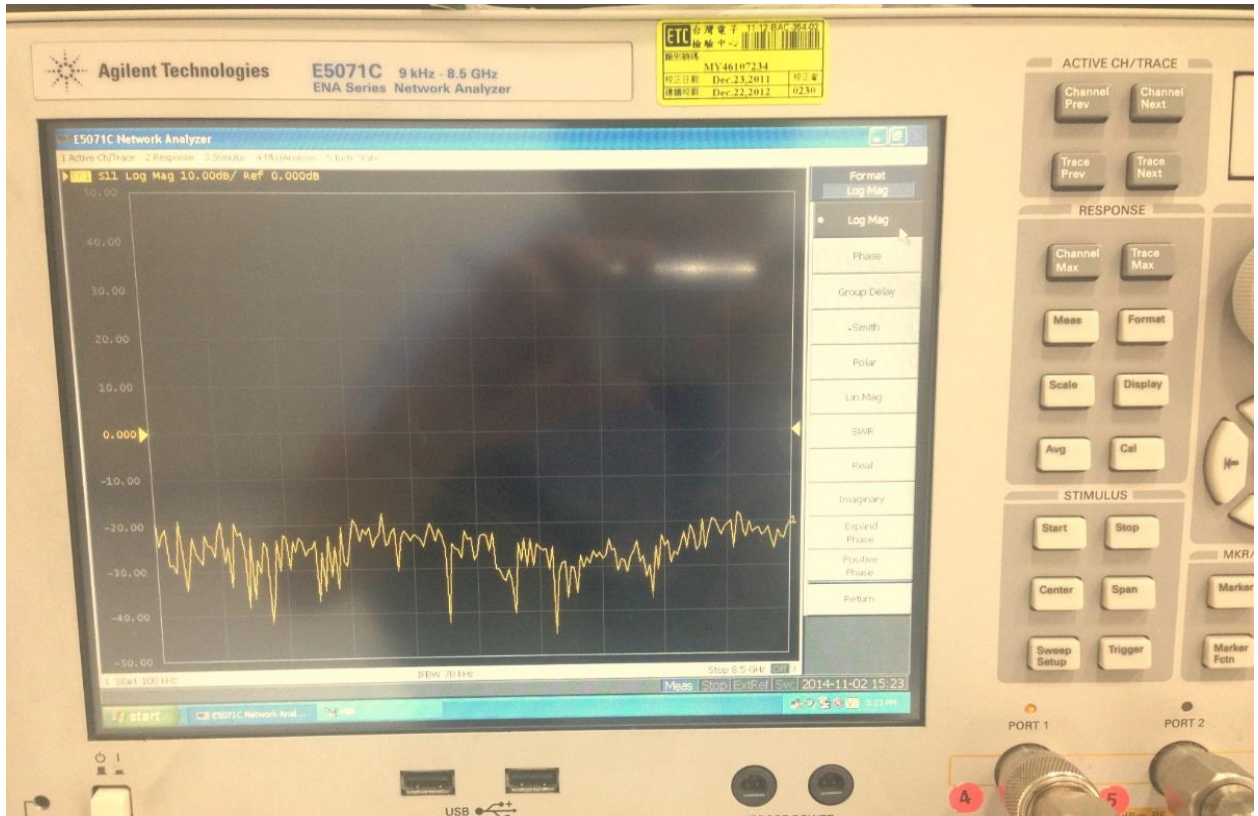



## 2 Summary of Test Result

### 2.1 Ambient Condition

Temperature(°C)	22.4°C	Humidity(°C)	54%
-----------------	--------	--------------	-----

Test / Position	Gain / Free Space		
Frequency	2400	2450	2500
Ant. Port Input Pwr. (dBm)	0	0	0
Tot. Rad. Pwr. (dBm)	-11.8149	-11.5297	-11.8761
Peak EIRP (dBm)	-7.36321	-6.72032	-6.81552
Directivity (dBi)	4.45166	4.80941	5.06058
Efficiency (dB)	-11.8149	-11.5297	-11.8761
Efficiency (%)	6.58435	7.03117	6.49218
Gain (dBi)	-7.36321	-6.72032	-6.81552
NHPRP $\pm\pi/4$ (dBm)	-13.4689	-13.3	-13.7452
NHPRP $\pm\pi/6$ (dBm)	-14.8995	-14.8444	-15.4325
Average Gain (dB)	-11.8149	-11.5297	-11.8761

### Test result RDA5875Y



### 4 2D Test Plotting

The test plotting was shown as below

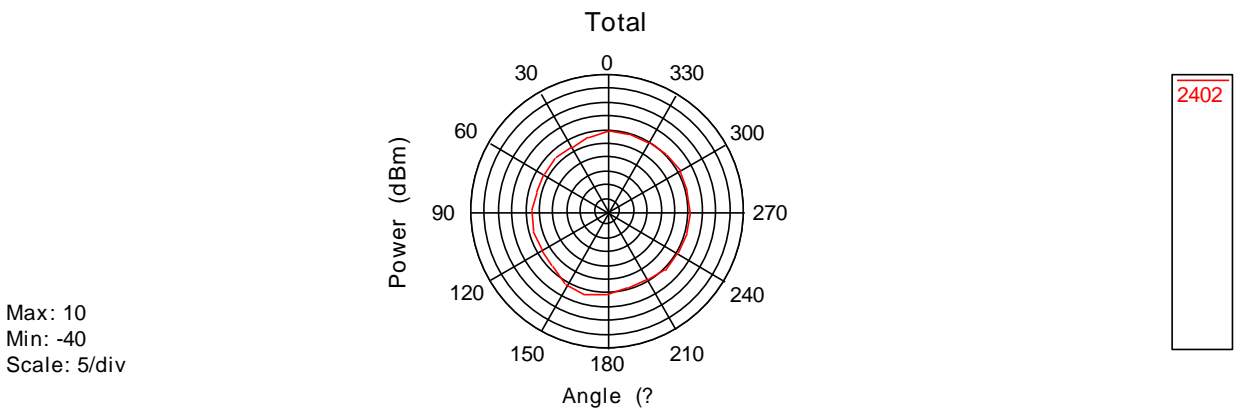
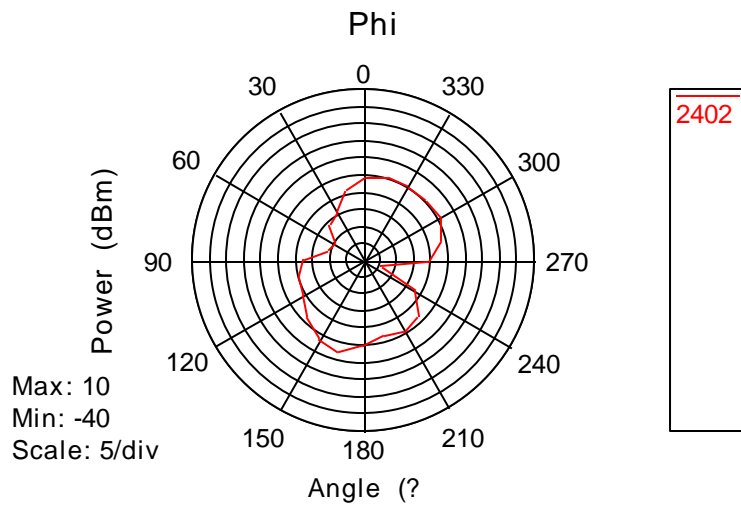
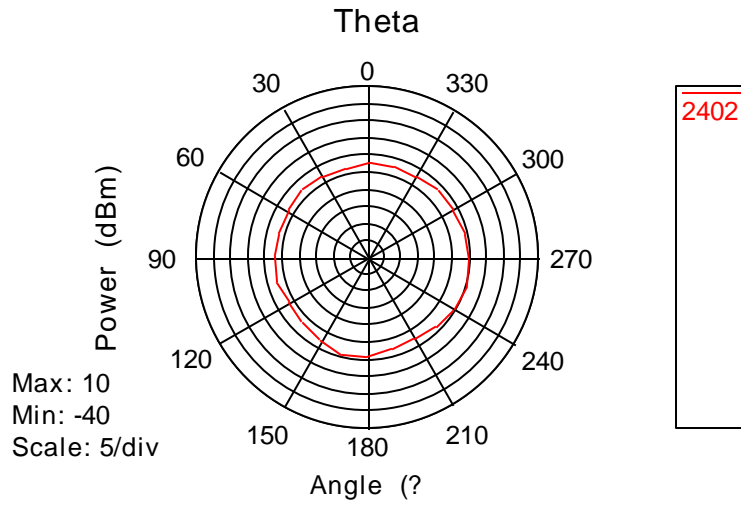

2D(X-Y Plane) RDA5875Y Antenna Gain Free Space-2402MHz

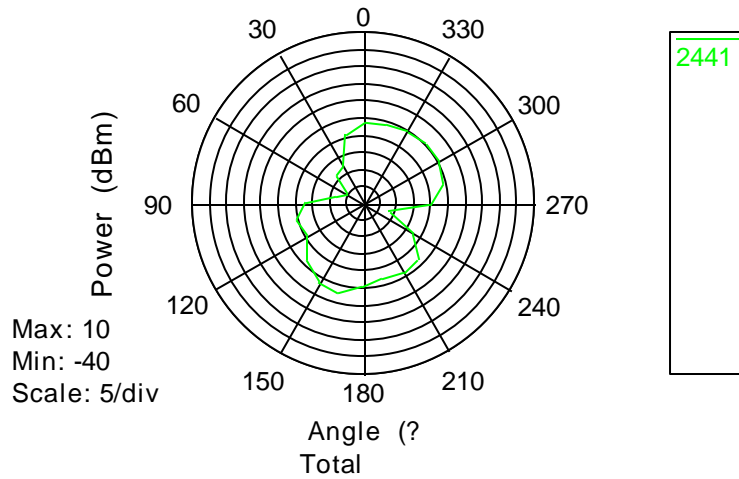
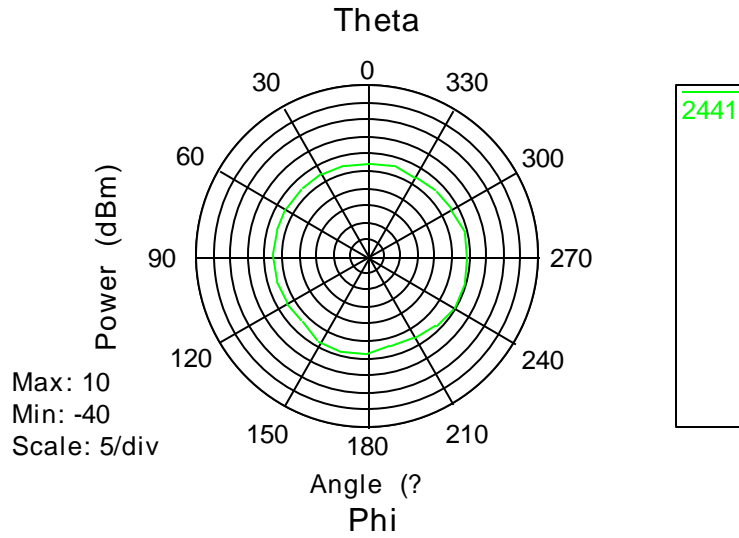

Max: 10  
Min: -40  
Scale: 5/div

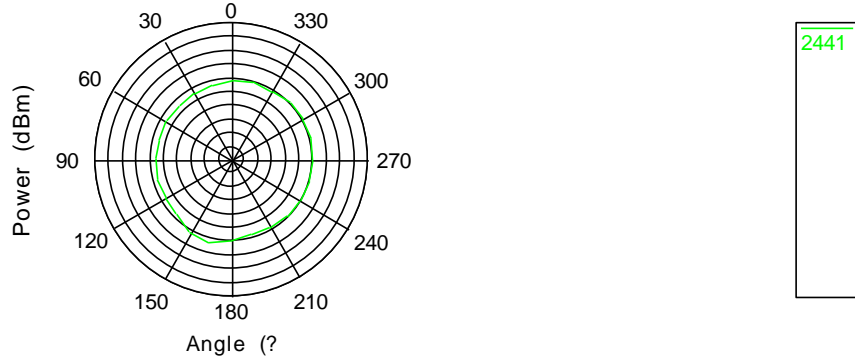

2D(X-Y Plane) RDA5875Y Antenna Gain Free Space-2441MHz



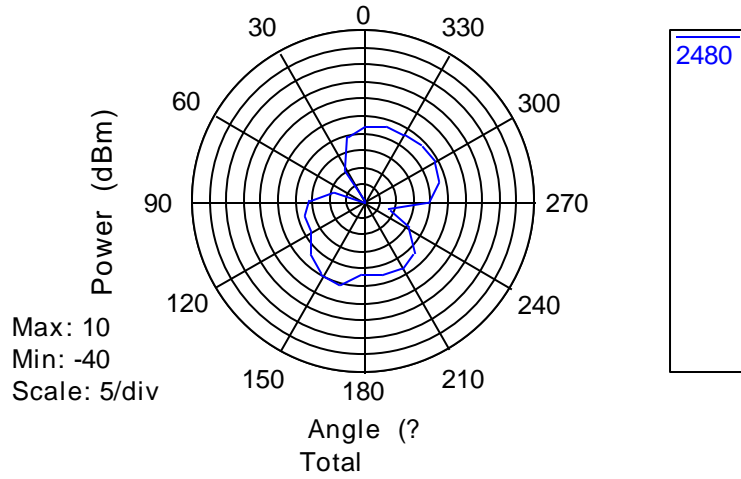
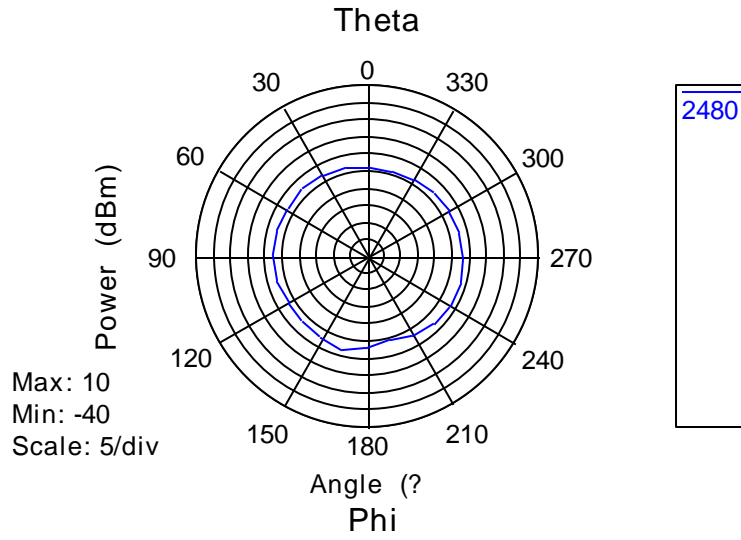

Max: 10  
Min: -40  
Scale: 5/div

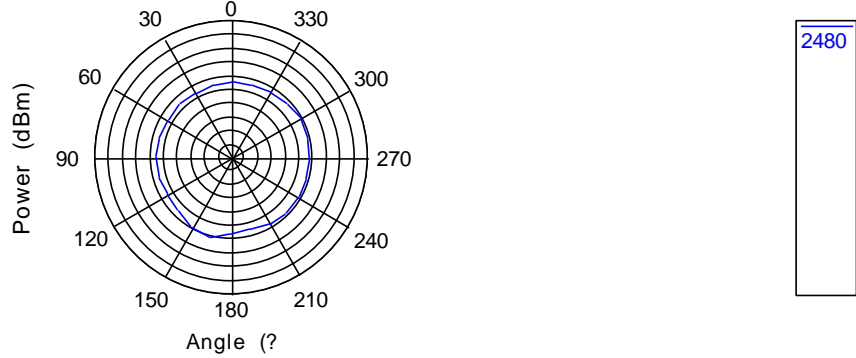

2D(X-Y Plane) RDA5875Y Antenna Gain Free Space-2480MHz

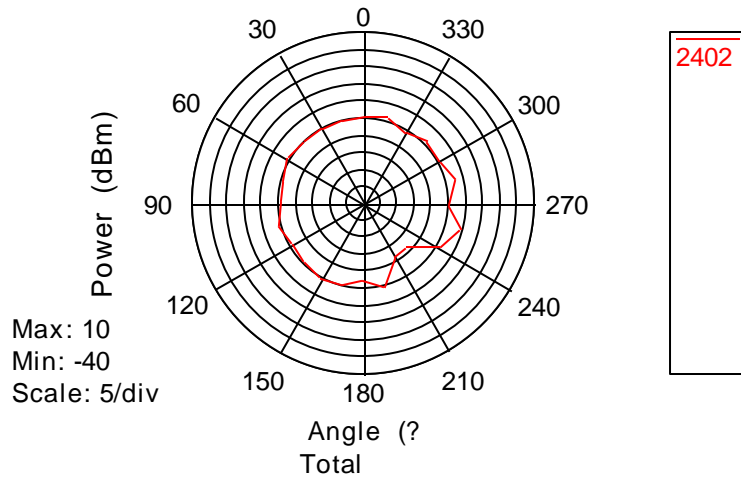
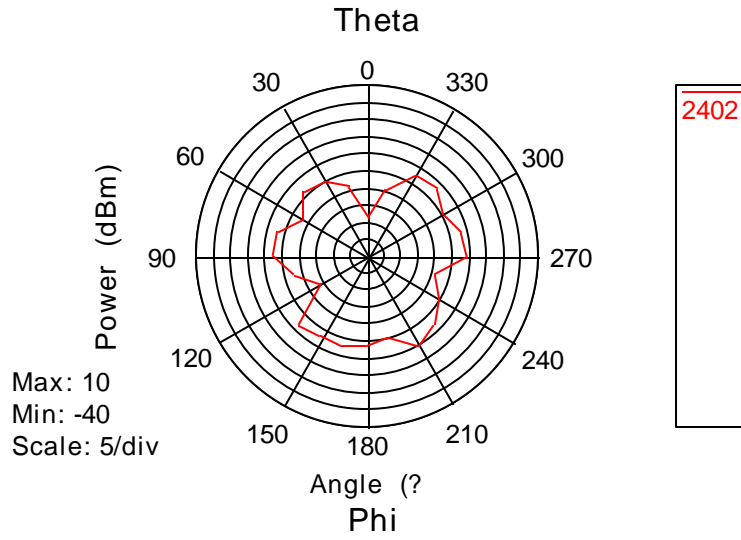

Max: 10  
Min: -40  
Scale: 5/div

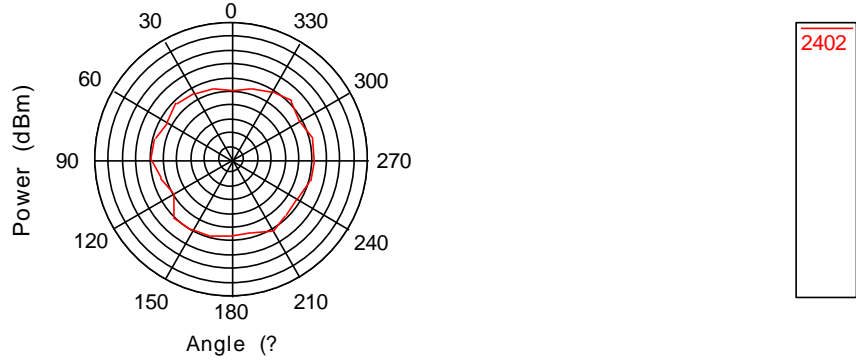

2D(X-Z Plane) RDA5875Y Antenna Gain Free Space-2402MHz

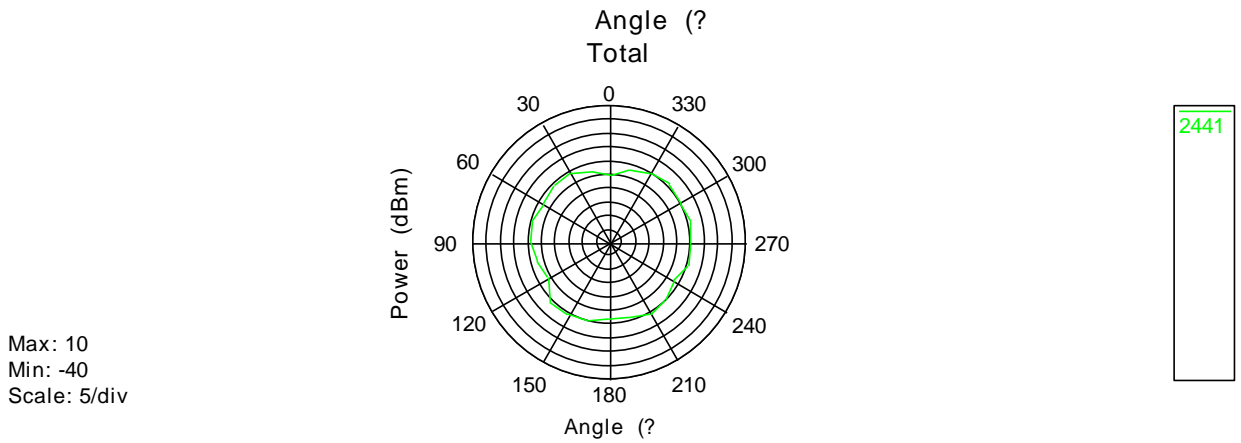
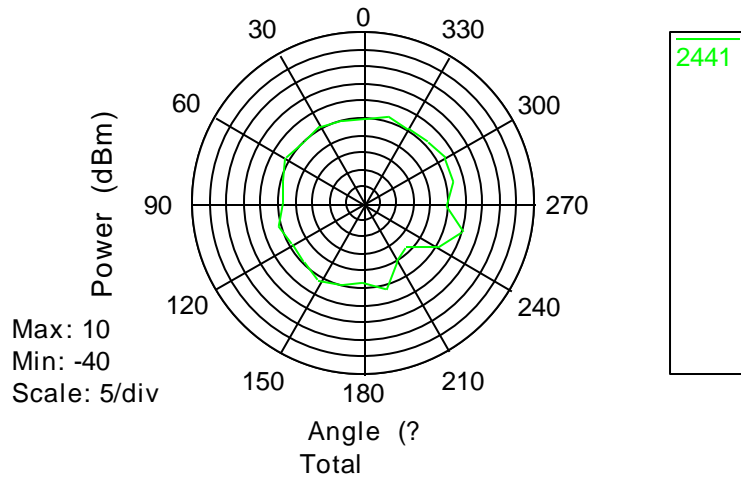
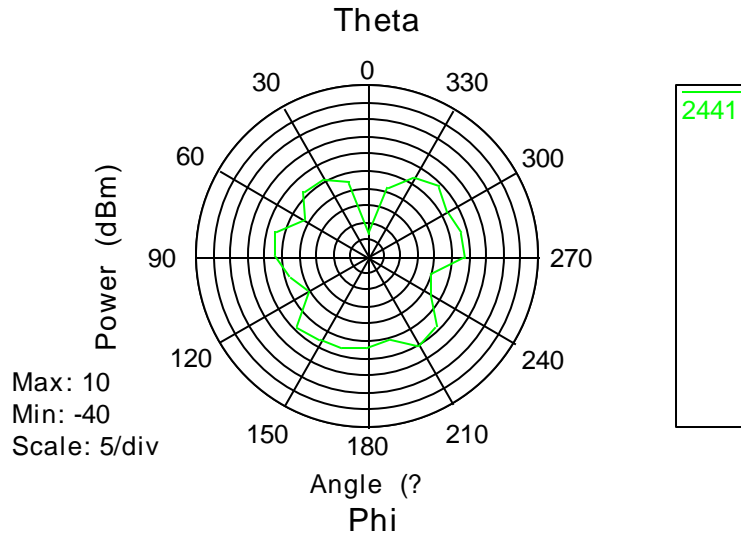

2D(X-Z Plane) RDA5875Y Antenna Gain Free Space-2441MHz

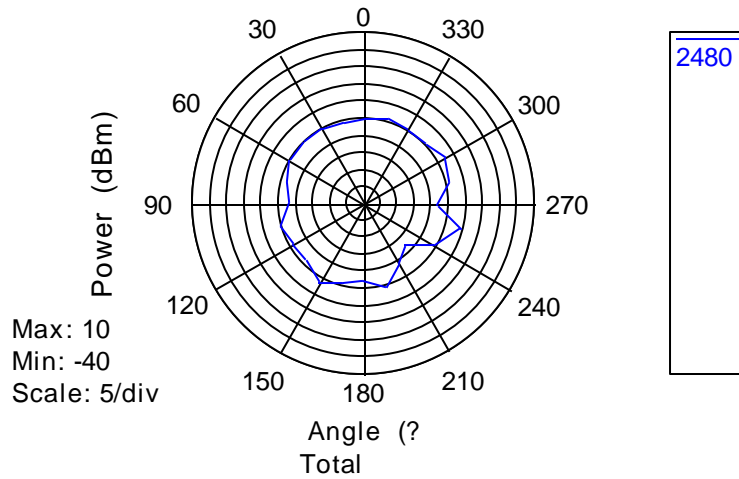
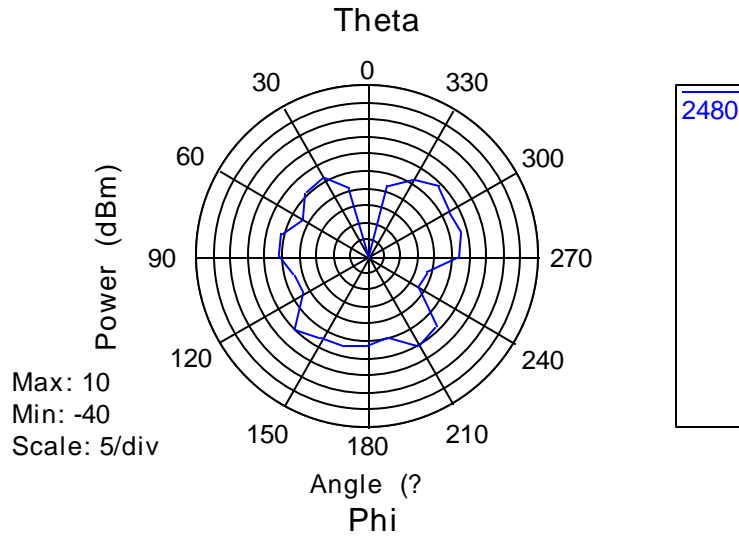

Max: 10  
Min: -40  
Scale: 5/div

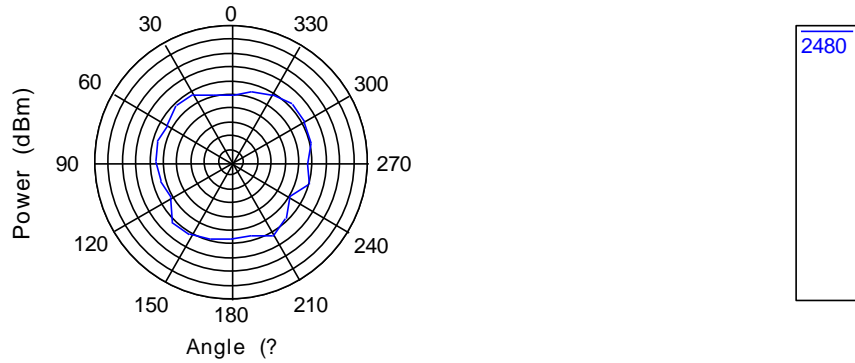

2D(X-Z Plane) RDA5875Y Antenna Gain Free Space-2480MHz

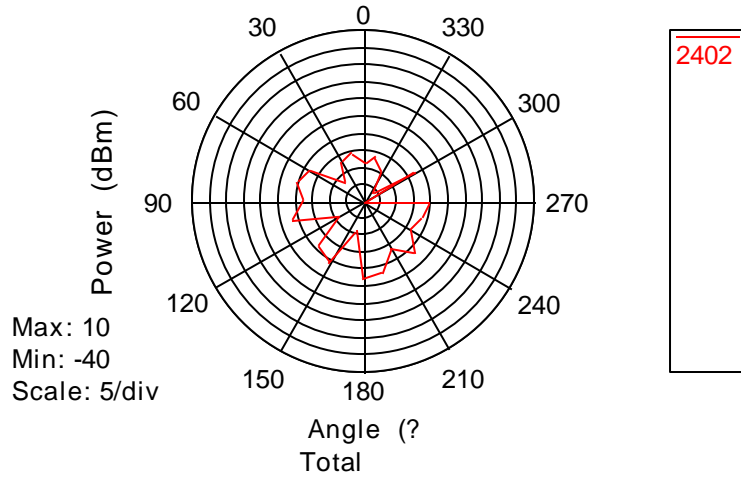
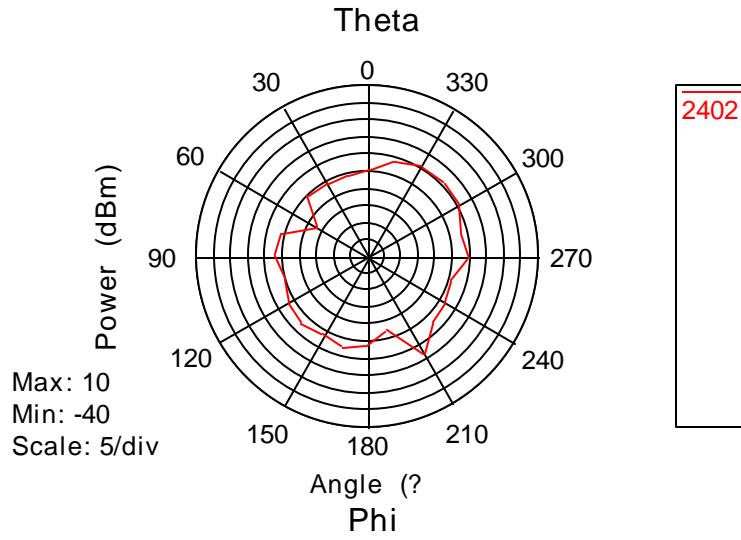

Max: 10  
Min: -40  
Scale: 5/div

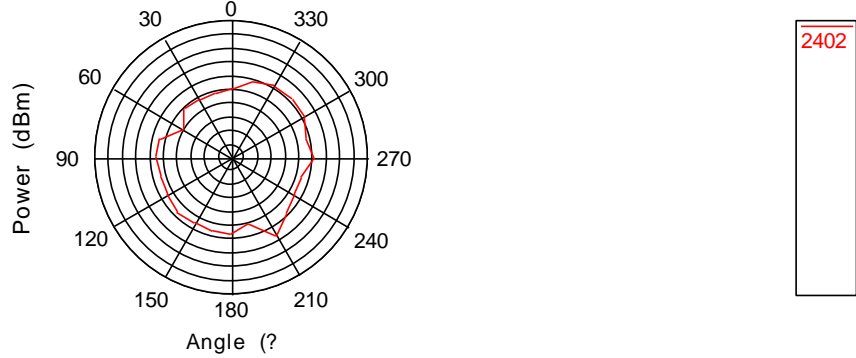

2D(Y-Z Plane) RDA5875Y Antenna Gain Free Space-2402MHz

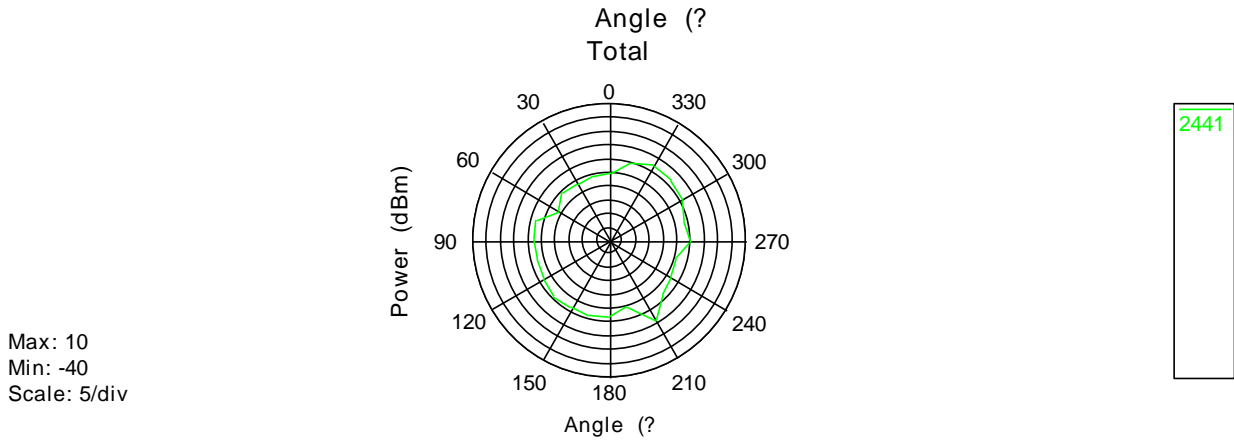
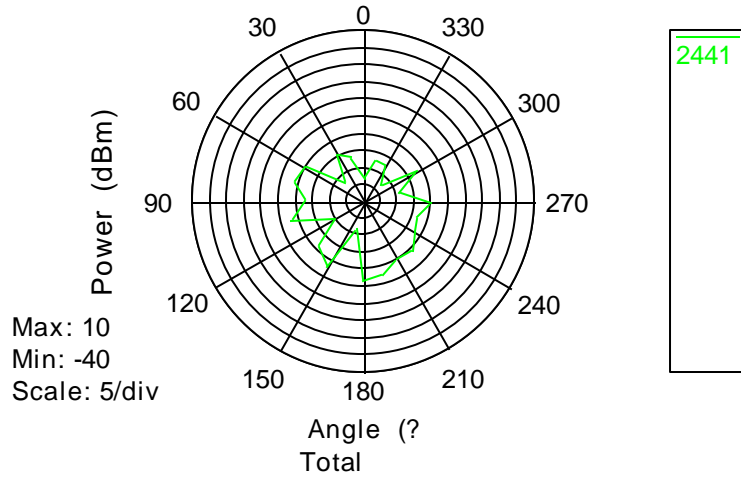
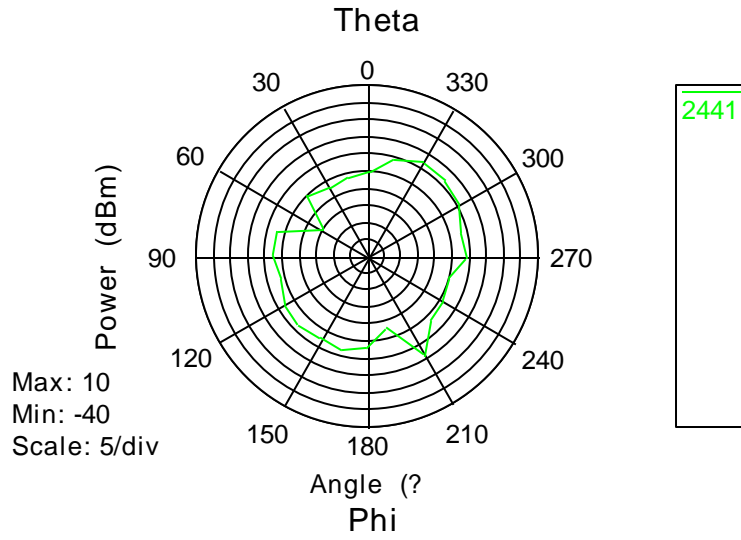

2D(Y-Z Plane) RDA5875Y Antenna Gain Free Space-2441MHz

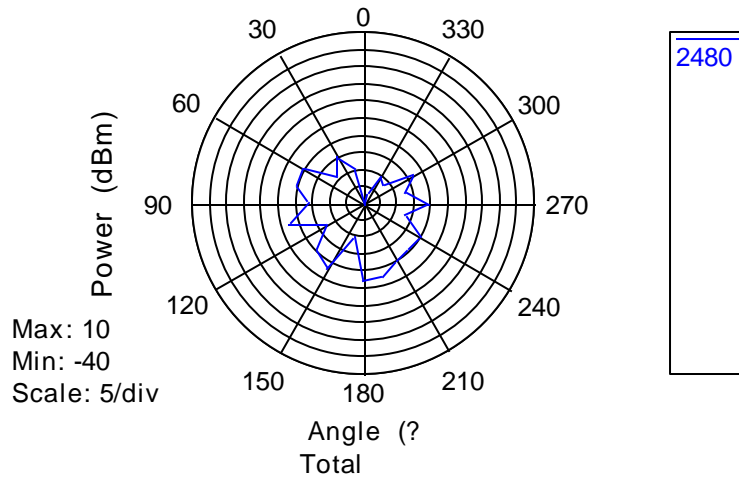
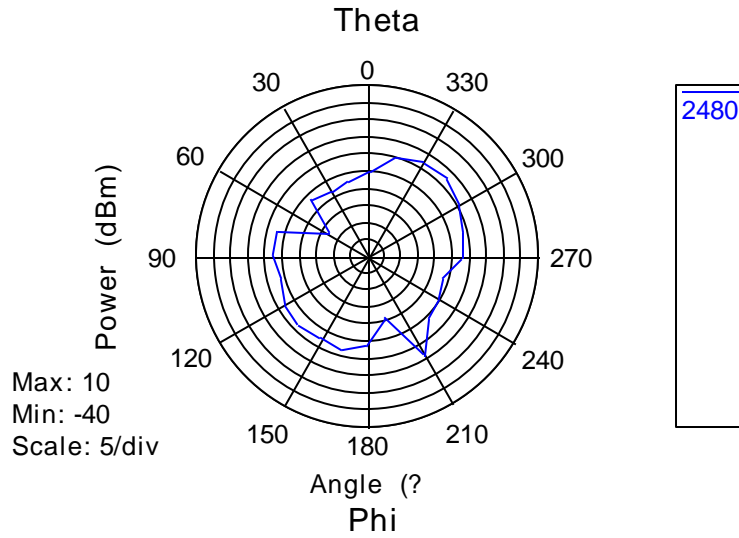

Max: 10  
Min: -40  
Scale: 5/div

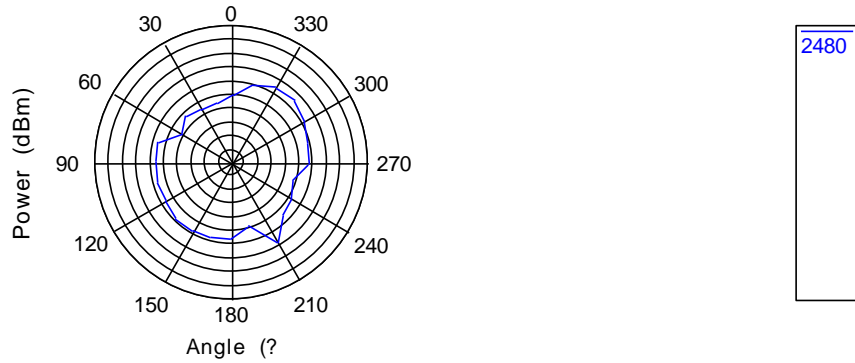

2D(Y-Z Plane) RDA5875Y Antenna Gain Free Space-2480MHz



## 5 3D TEST PLOTTING

The test plotting was shown as below

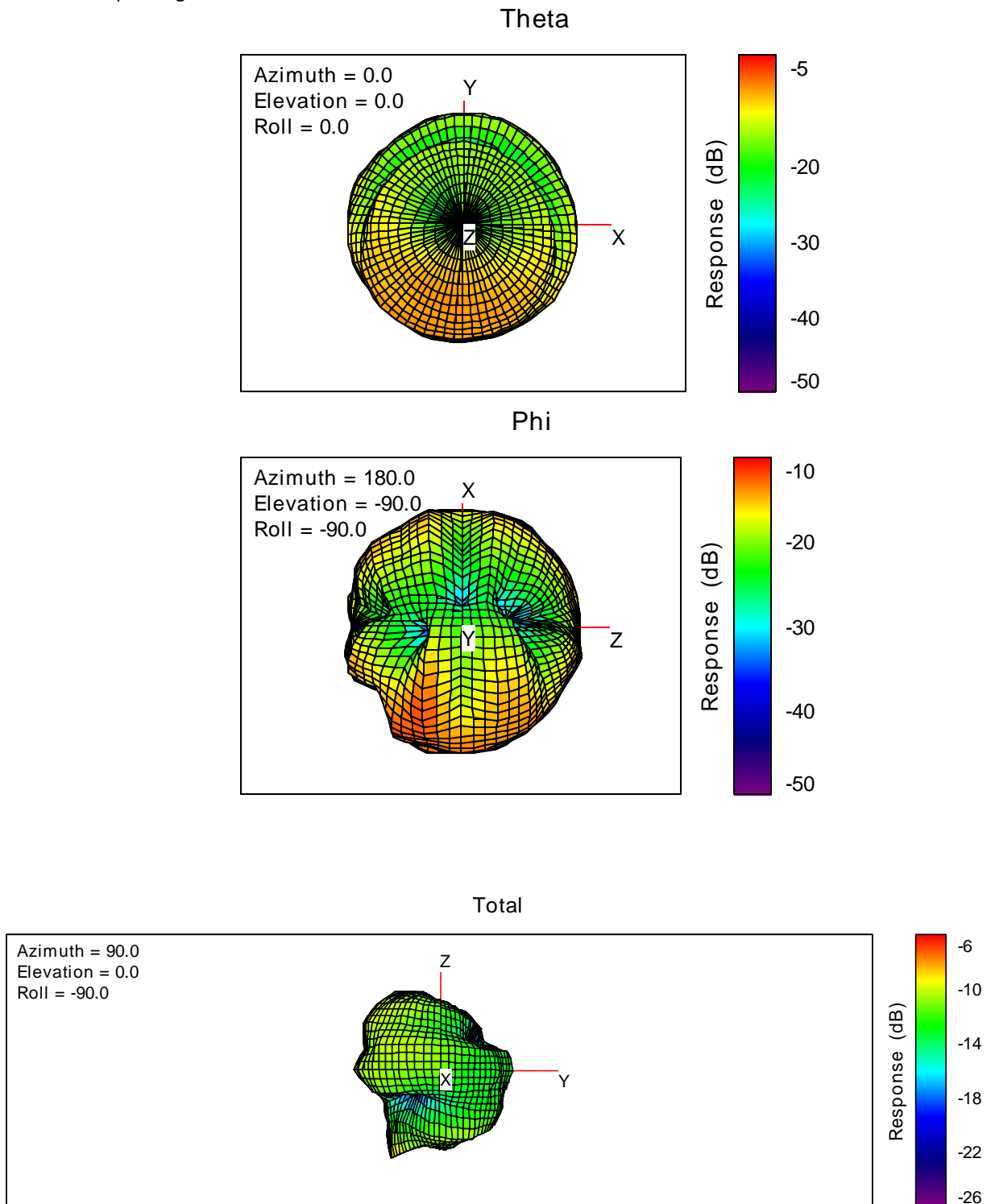





Theta

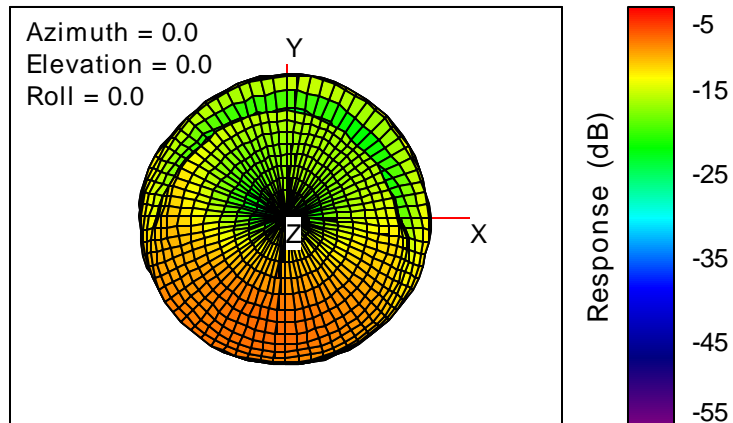

Phi

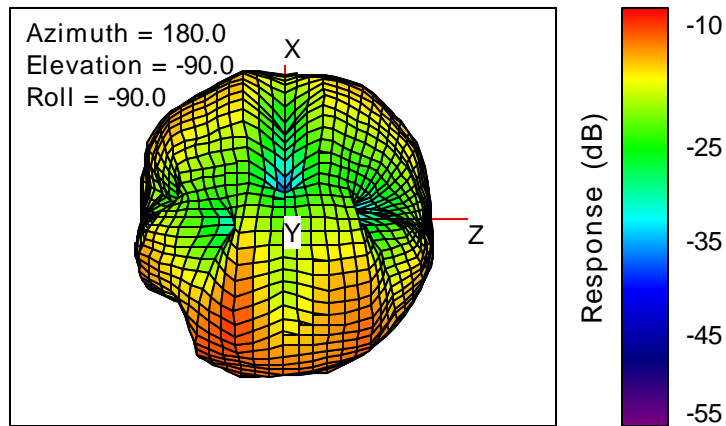

Total

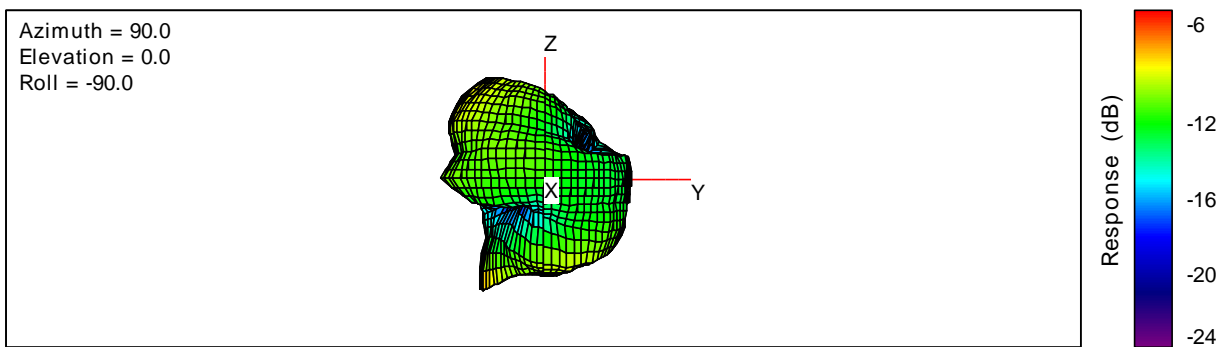

3D RDA5875Y Antenna Gain Free Space-2441MHz



Theta

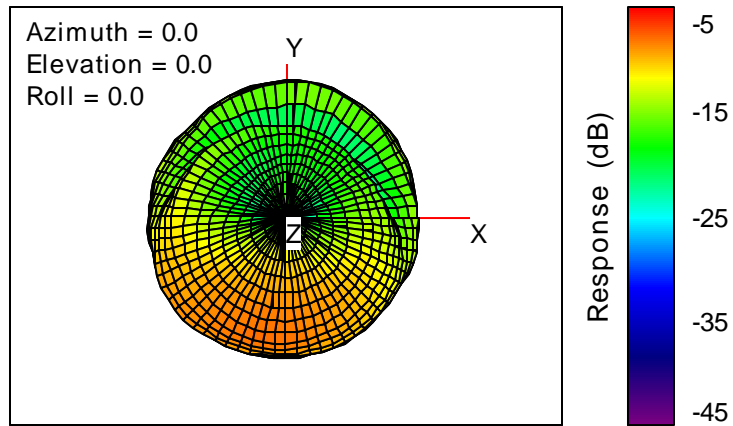

Phi

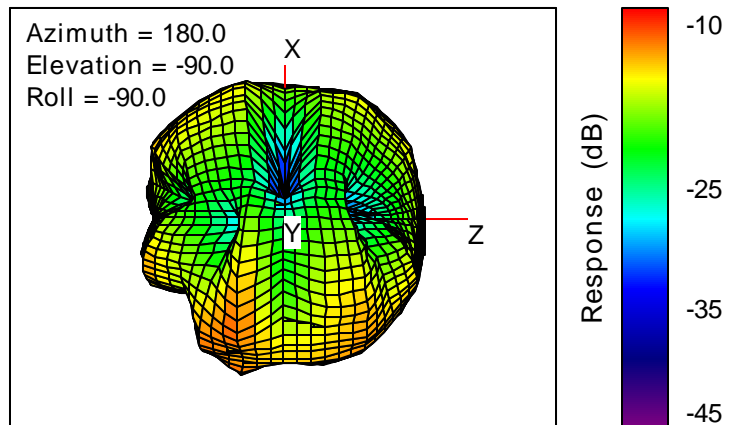

Total

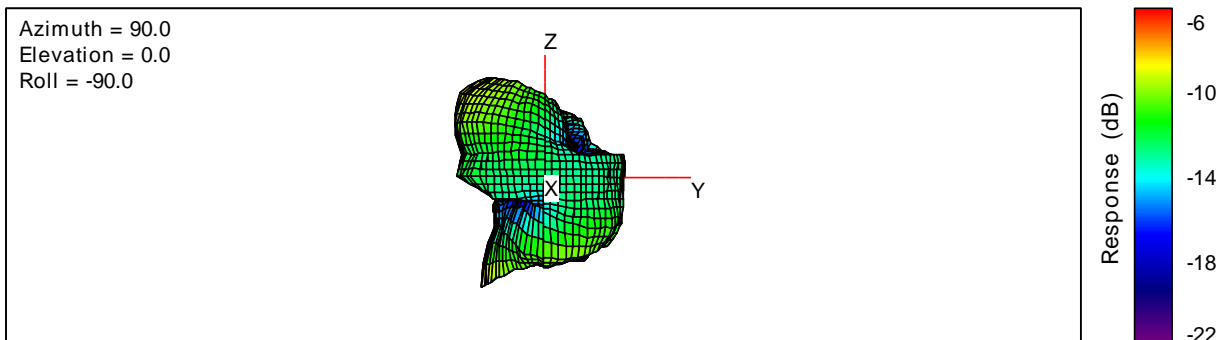

3D RDA5875Y Antenna Gain Free Space-2480MHz