

TEST REPORT

Report No.: BCTC2312542403-1E

Applicant: REOLINK INNOVATION LIMITED

Product Name: WiFi IP Camera

Test Model: E1 Outdoor S

Tested Date: 2023-12-29 to 2024-02-27

Issued Date: 2024-02-28

Shenzhen BCTC Testing Co., Ltd.



FCC ID: 2AYHE-2312B

Product Name: WiFi IP Camera

Trademark: 

Model/Type reference: E1 Outdoor S
E Series E550

Prepared For: REOLINK INNOVATION LIMITED

Address: FLAT/RM 705 7/F FA YUEN COMMERCIAL BUILDING 75-77 FA YUEN STREET MONG KOK KL HONG KONG

Manufacturer: REOLINK INNOVATION LIMITED

Address: FLAT/RM 705 7/F FA YUEN COMMERCIAL BUILDING 75-77 FA YUEN STREET MONG KOK KL HONG KONG

Factory: Shenzhen Reolink Technology Co., Ltd.

Address: 2-4th Floor, Building 2, YuanLing Industrial Park, ShangWu, Shiyan Street, Bao'an District, Shenzhen, China

Prepared By: Shenzhen BCTC Testing Co., Ltd.

Address: 1-2/F., Building B, Pengzhou Industrial Park, No.158, Fuyuan 1st Road, Zhancheng, Fuhai Subdistrict, Bao'an District, Shenzhen, Guangdong, China

Sample Received Date: 2023-12-29

Sample tested Date: 2023-12-29 to 2024-02-27

Issue Date: 2024-02-28

Report No.: BCTC2312542403-1E

Test Standards: FCC Part15.247
ANSI C63.10-2013

Test Results: PASS

Remark: This is WIFI-2.4GHz band radio test report.

Tested by:

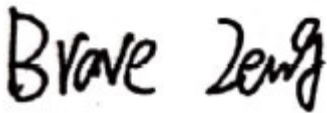

Brave Zeng/ Project Handler

Approved by:

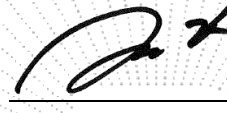

Zero Zhou/Reviewer

The test report is effective only with both signature and specialized stamp. This result(s) shown in this report refer only to the sample(s) tested. Without written approval of Shenzhen BCTC Testing Co., Ltd, this report can't be reproduced except in full. The tested sample(s) and the sample information are provided by the client.

Table Of Content

Test Report Declaration	Page
1. Version	5
2. Test Summary	6
3. Measurement Uncertainty	7
4. Product Information And Test Setup	8
4.1 Product Information.....	8
4.2 Test Setup Configuration	8
4.3 Support Equipment	9
4.4 Channel List.....	9
4.5 Test Mode	10
4.6 Table Of Parameters Of Text Software Setting.....	11
4.7 Antenna.....	11
5. Test Facility And Test Instrument Used.....	12
5.1 Test Facility.....	12
5.2 Test Instrument Used.....	12
6. Conducted Emissions.....	14
6.1 Block Diagram Of Test Setup.....	14
6.2 Limit	14
6.3 Test procedure.....	14
6.4 EUT operating Conditions	14
6.5 Test Result.....	15
7. Radiated Emissions.....	17
7.1 Block Diagram Of Test Setup.....	17
7.2 Limit	18
7.3 Test procedure.....	19
7.4 EUT Operating Conditions	20
7.5 Test Result.....	20
8. Radiated Band Emission Measurement And Restricted Bands Of Operation	29
8.1 Block Diagram Of Test Setup.....	29
8.2 Limit	29
8.3 Test procedure.....	30
8.4 EUT Operating Conditions	30
8.5 Test Result.....	31
9. Power Spectral Density Test	34
9.1 Block Diagram Of Test Setup.....	34
9.2 Limit	34
9.3 Test procedure.....	34
9.4 EUT Operating Conditions	34
9.5 Test Result.....	35
10. Bandwidth Test.....	45
10.1 Block Diagram Of Test Setup.....	45
10.2 Limit	45
10.3 Test procedure.....	45
10.4 EUT Operating Conditions	45
10.5 Test Result.....	46

11. Peak Output Power Test	56
11.1 Block Diagram Of Test Setup.....	56
11.2 Limit	56
11.3 Test Procedure	56
11.4 EUT Operating Conditions	56
11.5 Test Result.....	57
12. 100 kHz Bandwidth Of Frequency Band Edge	58
12.1 Block Diagram Of Test Setup.....	58
12.2 Limit	58
12.3 Test Procedure	58
12.4 EUT Operating Conditions	58
12.5 Test Result.....	58
13. Duty Cycle Of Test Signal	89
13.1 Standard Requirement.....	89
13.2 Formula.....	89
13.3 Test Procedure	89
13.4 Test Result.....	89
14. Antenna Requirement	109
14.1 Limit	109
14.1 Test Result.....	109
15. EUT Photographs.....	110
16. EUT Test Setup Photographs.....	111

(Note: N/A Means Not Applicable)

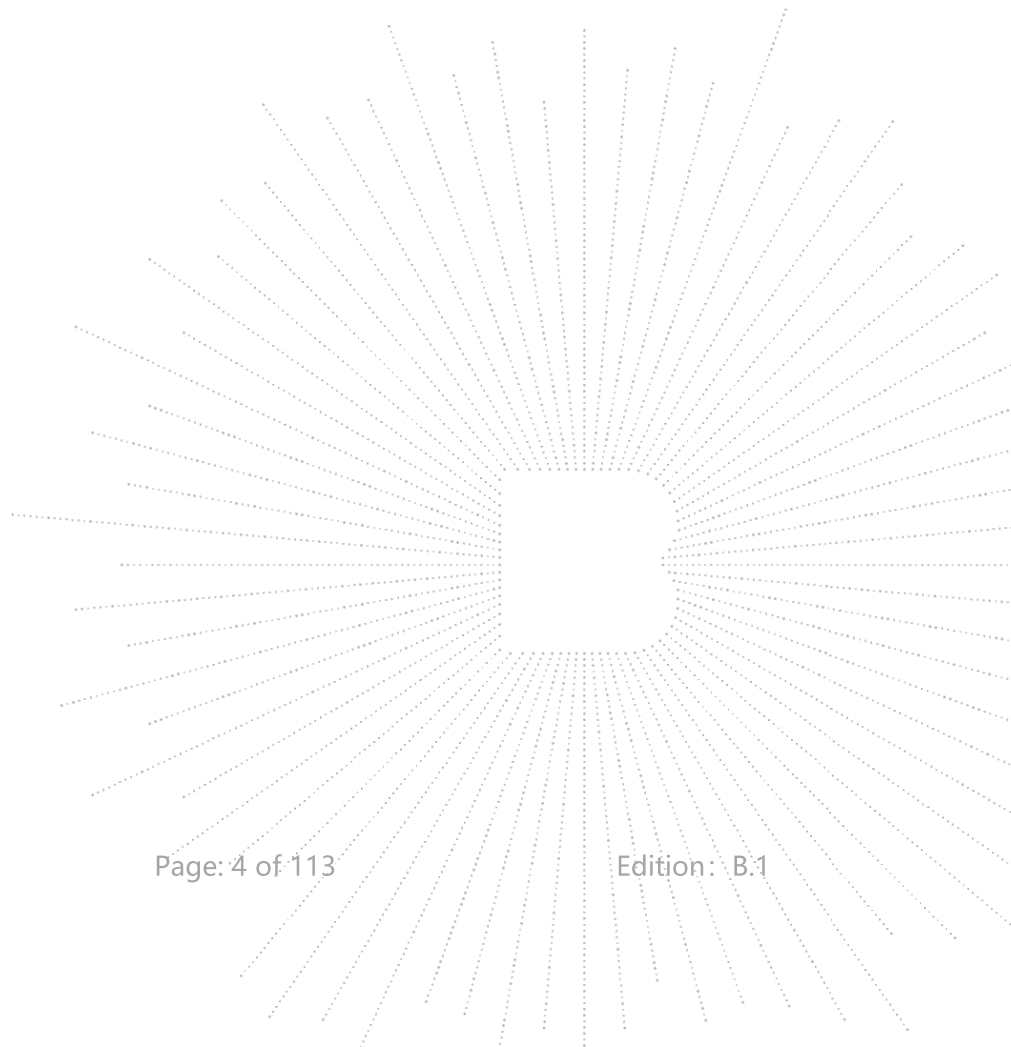

1. Version

Report No.	Issue Date	Description	Approved
BCTC2312542403-1E	2024-02-28	Original	Valid

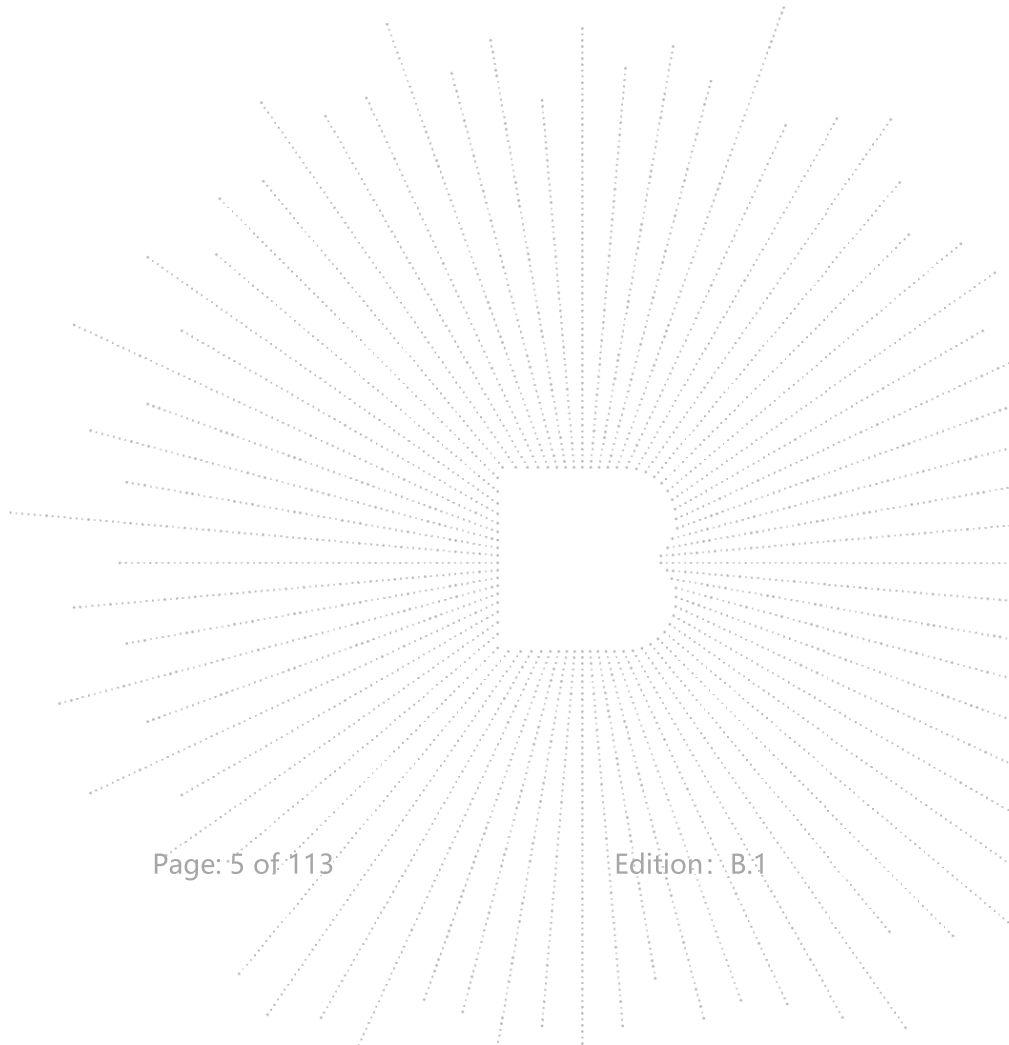

2. Test Summary

The Product has been tested according to the following specifications:

No.	Test Parameter	Clause No.	Results
1	Conducted Emission	15.207	PASS
2	6dB Bandwidth	15.247 (a)(2)	PASS
3	Peak Output Power	15.247 (b)	PASS
4	Radiated Spurious Emission	15.247 (d)	PASS
5	Power Spectral Density	15.247 (e)	PASS
6	Restricted Band of Operation	15.205	PASS
7	Band Edge (Out of Band Emissions)	15.247 (d)	PASS
8	Antenna Requirement	15.203	PASS

3. Measurement Uncertainty

Where relevant, the following measurement uncertainty levels have been estimated for tests performed on the Product as specified in CISPR 16-4-2. This uncertainty represents an expanded uncertainty expressed at approximately the 95% confidence level using a coverage factor of k=2.

No.	Item	Uncertainty
1	3m chamber Radiated spurious emission(30MHz-1GHz)	U=4.3dB
2	3m chamber Radiated spurious emission(9KHz-30MHz)	U=3.7dB
3	3m chamber Radiated spurious emission(1GHz-18GHz)	U=4.5dB
4	3m chamber Radiated spurious emission(18GHz-40GHz)	U=3.34dB
5	Conducted Emission (150kHz-30MHz)	U=3.20dB
6	Conducted Adjacent channel power	U=1.38dB
7	Conducted output power uncertainty Above 1G	U=1.576dB
8	Conducted output power uncertainty below 1G	U=1.28dB
9	humidity uncertainty	U=5.3%
10	Temperature uncertainty	U=0.59°C

4. Product Information And Test Setup

4.1 Product Information

Model/Type reference:	E1 Outdoor S E Series E550
Model differences:	All the model are the same circuit and RF module, except model names.
Hardware Version:	V1.0
Software Version:	3132_2401032100
Operation Frequency:	802.11b/g/n20MHz/ax20MHz:2412~2462 MHz 802.11n40MHz/ax40MHz:2422~2452 MHz
Bit Rate of Transmitter:	802.11b:11/5.5/2/1 Mbps 802.11g:54/48/36/24/18/12/9/6Mbps 802.11n Up to 150Mbps 802.11ax:400Mbps
Type of Modulation:	WIFI: OFDM/DSSS
Number Of Channel:	802.11b/g/n20/ax20MHz:11 CH 802.11n40/ax40MHz: 7 CH
Antenna installation:	Internal antenna*2 Antenna A & B: 3.9 dBi
Antenna Gain:	Remark: <input checked="" type="checkbox"/> The antenna gain of the product comes from the antenna report provided by the customer, and the test data is affected by the customer information. <input type="checkbox"/> The antenna gain of the product is provided by the customer, and the test data is affected by the customer information.
Ratings:	AC 120V/60Hz
Adapter Information:	Model: DCT12W120100US-B0 Input: 100-240V~50/60Hz 0.3A max. Output: DC 12.0V 1.0A

4.2 Test Setup Configuration

See test photographs attached in *EUT TEST SETUP PHOTOGRAPHS* for the actual connections between Product and support equipment.

4.3 Support Equipment

No.	Device Type	Brand	Model	Series No.	Note
E-1	WiFi IP Camera		E1 Outdoor S	N/A	EUT
E-2	Adapter	N/A	DCT12W12010 0US-B0	N/A	Auxiliary
E-3	Router	N/A	N/A	N/A	Auxiliary
E-4	laptop	N/A	N/A	N/A	Auxiliary

Item	Shielded Type	Ferrite Core	Length	Note
C-1	N/A	N/A	3M	DC cable unshielded

Notes:

1. All the equipment/cables were placed in the worst-case configuration to maximize the emission during the test.
2. Grounding was established in accordance with the manufacturer's requirements and conditions for the intended use.

4.4 Channel List

Channel List for 802.11b/g/n(20)/ax(20)					
Channel	Frequency (MHz)	Channel	Frequency (MHz)	Channel	Frequency (MHz)
01	2412	02	2417	03	2422
04	2427	05	2432	06	2437
07	2442	08	2447	09	2452
10	2457	11	2462		

Channel List for 802.11n(40)/ax(40)					
Channel	Frequency (MHz)	Channel	Frequency (MHz)	Channel	Frequency (MHz)
03	2422	04	2427	05	2432
06	2437	07	2442	08	2447
09	2452				

4.5 Test Mode

To investigate the maximum EMI emission characteristics generated from EUT, the test system was pre-scanning tested based on the consideration of following EUT operation mode or test configuration mode which possibly have effect on EMI emission level. Each of these EUT operation mode(s) or test configuration mode(s) mentioned above was evaluated respectively.

For All Mode	Description	Modulation Type
Mode 1	CH 01	802.11b
Mode 2	CH 06	
Mode 3	CH 11	
Mode 4	CH 01	802.11g
Mode 5	CH 06	
Mode 6	CH 11	
Mode 7	CH 01	802.11n20
Mode 8	CH 06	
Mode 9	CH 11	
Mode 10	CH 03	802.11n40
Mode 11	CH 06	
Mode 12	CH 09	
Mode 13	CH 01	802.11ax20
Mode 14	CH 06	
Mode 15	CH 11	
Mode 16	CH 03	802.11ax40
Mode 17	CH 06	
Mode 18	CH 09	
Mode 19	Link mode (Conducted emission and Radiated emission)	

Notes:

1. The measurements are performed at the highest, middle, lowest available channels.
2. The measurements are performed at all Bit Rate of Transmitter, the worst data was reported
3. According to ANSI C63.10 standards, the test results are both the "worst case" and "worst setup" 11Mbps for 802.11b, 6Mbps for 802.11g, 13Mbps for 802.11n(H20), 54Mbps for 802.11n(H40)

4.6 Table Of Parameters Of Text Software Setting

During testing channel & power controlling software provided by the customer was used to control the operating channel as well as the output power level. The RF output power selection is for the setting of RF output power expected by the customer and is going to be fixed on the firmware of the final end product power parameters

Test software Version	CMD		
Frequency	2412 MHz	2437 MHz	2462 MHz
Parameters	DEF	DEF	DEF
Frequency	2422MHz	2437MHz	2452MHz
Parameters	DEF	DEF	DEF

4.7 Antenna

Table for External antenna

Ant.	Brand	Model Name	Antenna Type	Gain (dBi)	NOTE
A	N/A	N/A	Internal antenna	3.9	N/A
B	N/A	N/A	Internal antenna	3.9	N/A

EUT has two Internal antennas with Max gain GANT 3.9 dBi on every antenna, CDD device with one spatial streams, also can operat with one spatial streams according to KDB662911 D01 v02r01, Directional gain= GANT + Array Gain, where Array Gain is as follows.

1)For power spectral density(PSD) measurements,
 Array Gain= $10\log(NANT/NSS)$ dB= $10\log(2/1)$ =3.01dB,
 So the directional gain for PSD is 6.91 dBi

2)For power measurements,
 The Array gain=0 dB for $NANT \leq 4$,
 So the directional gain for Power measurements is 3.9 dBi

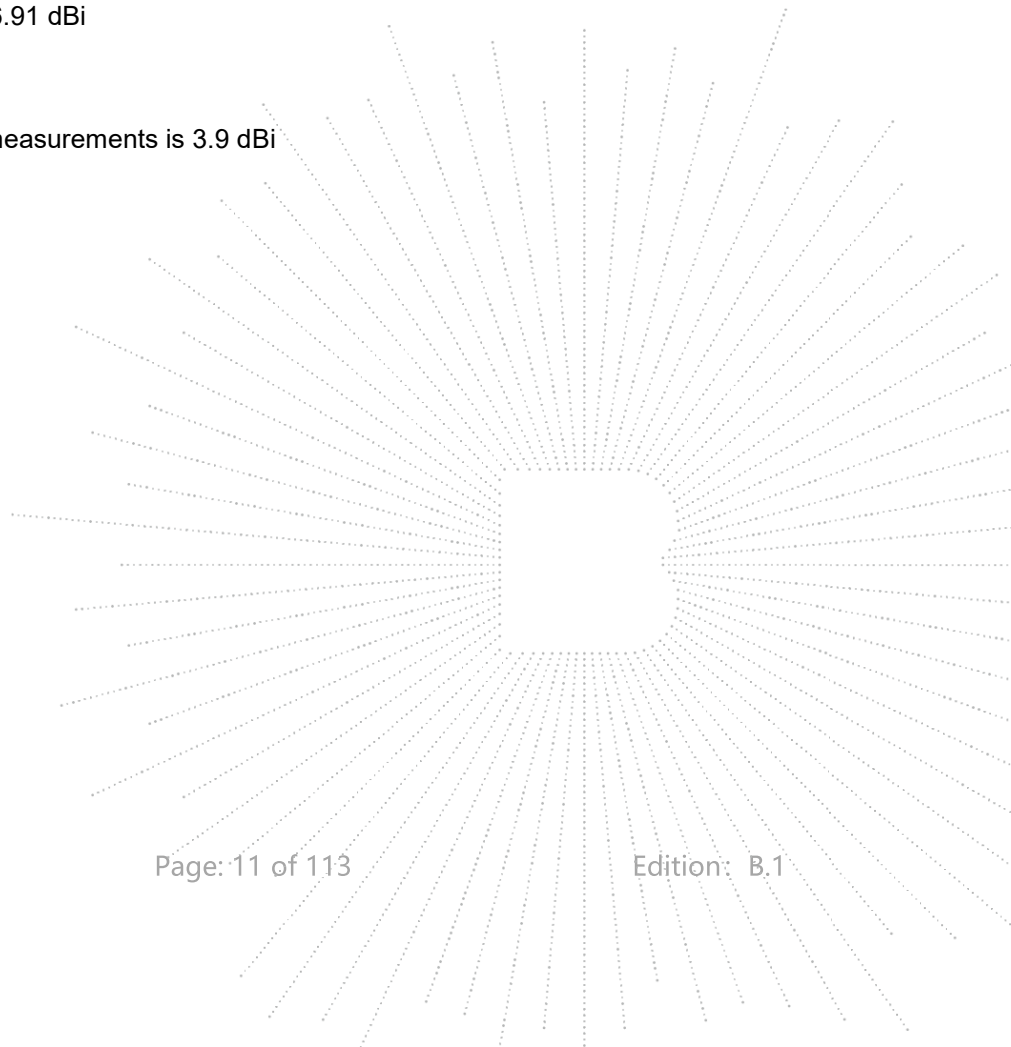

5. Test Facility And Test Instrument Used

5.1 Test Facility

All measurement facilities used to collect the measurement data are located at Shenzhen BCTC Testing Co., Ltd. Address: 1-2/F., Building B, Pengzhou Industrial Park, No.158, Fuyuan 1st Road, Zhancheng, Fuhai Subdistrict, Bao'an District, Shenzhen, Guangdong, China. The site and apparatus are constructed in conformance with the requirements of ANSI C63.4 and CISPR 16-1-1 other equivalent standards.

FCC Test Firm Registration Number: 712850

A2LA certificate registration number is: CN1212

ISED Registered No.: 23583

ISED CAB identifier: CN0017

5.2 Test Instrument Used

Conducted Emissions Test					
Equipment	Manufacturer	Model#	Serial#	Last Cal.	Next Cal.
Receiver	R&S	ESR3	102075	May 15, 2023	May 14, 2024
LISN	R&S	ENV216	101375	May 15, 2023	May 14, 2024
Software	Frad	EZ-EMC	EMC-CON 3A1	\	\
Pulse limiter	Schwarzbeck	VTSD9561-F	01323	Sept. 22, 2023	Sept. 21, 2024

RF Conducted Test					
Equipment	Manufacturer	Model#	Serial#	Last Cal.	Next Cal.
Power meter	Keysight	E4419	\	May 15, 2023	May 14, 2024
Power Sensor (AV)	Keysight	E9300A	\	May 15, 2023	May 14, 2024
Signal Analyzer20kHz-26.5GHz	Keysight	N9020A	MY49100060	May 15, 2023	May 14, 2024
Spectrum Analyzer9kHz-40GHz	R&S	FSP40	100363	May 15, 2023	May 14, 2024
Radio frequency control box	MAIWEI	MW100-RF CB	\	\	\
Software	MAIWEI	MTS 8310	\	\	\

Radiated Emissions Test (966 Chamber01)					
Equipment	Manufacturer	Model#	Serial#	Last Cal.	Next Cal.
966 chamber	ChengYu	966 Room	966	May 15, 2023	May 14, 2026
Receiver	R&S	ESR3	102075	May 15, 2023	May 14, 2024
Receiver	R&S	ESRP	101154	May 15, 2023	May 14, 2024
Amplifier	Schwarzbeck	BBV9744	9744-0037	May 15, 2023	May 14, 2024
TRILOG Broadband Antenna	Schwarzbeck	VULB9163	942	May 29, 2023	May 28, 2024
Loop Antenna(9KHz -30MHz)	Schwarzbeck	FMZB1519B	00014	May 31, 2023	May 30, 2024
Amplifier	SKET	LAPA_01G18 G-45dB	SK202104090 1	May 15, 2023	May 14, 2024
Horn Antenna	Schwarzbeck	BBHA9120D	1541	May 31, 2023	May 30, 2024
Amplifier(18G Hz-40GHz)	MITEQ	TTA1840-35- HG	2034381	May 15, 2023	May 14, 2024
Horn Antenna(18G Hz-40GHz)	Schwarzbeck	BBHA9170	00822	May 31, 2023	May 30, 2024
Spectrum Analyzer9kHz- 40GHz	R&S	FSP40	100363	May 15, 2023	May 14, 2024
Software	Frad	EZ-EMC	FA-03A2 RE	\	\

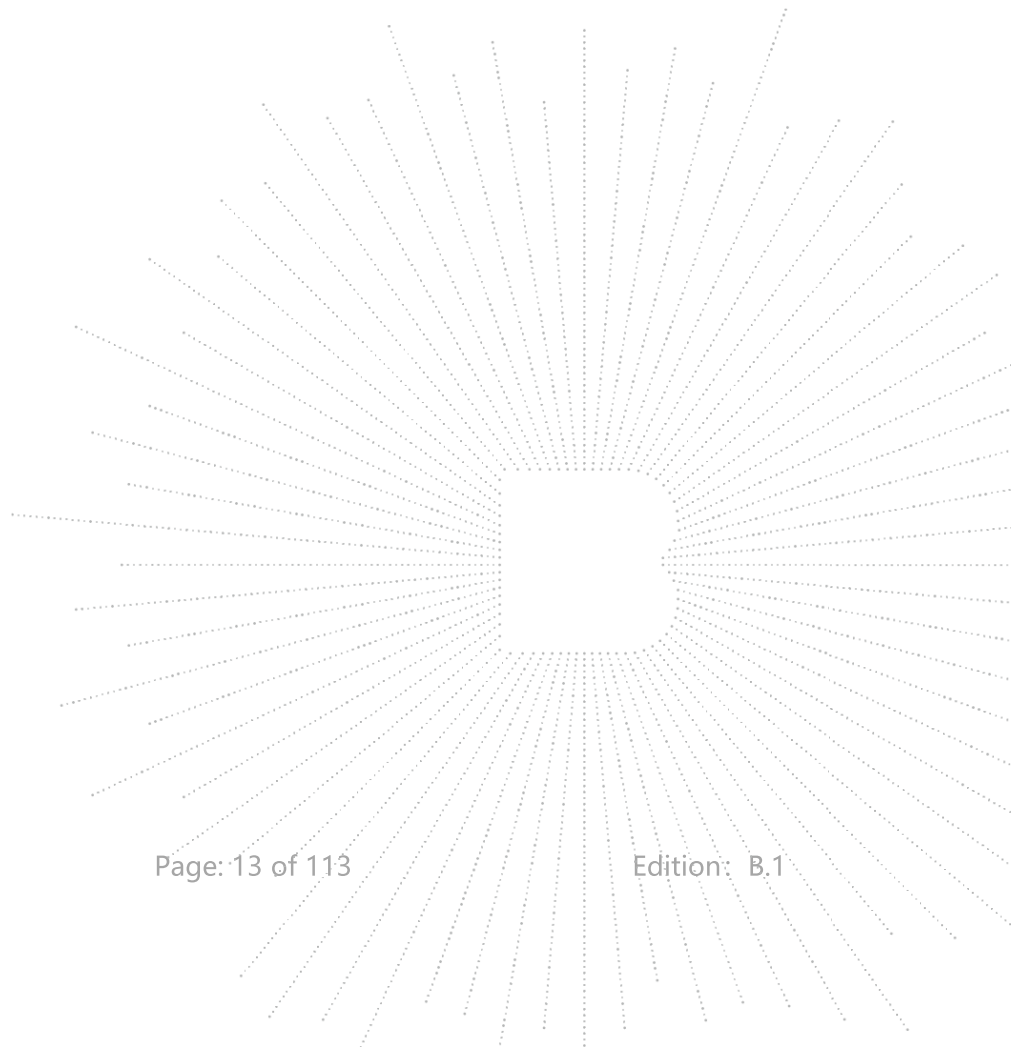

6. Conducted Emissions

6.1 Block Diagram Of Test Setup

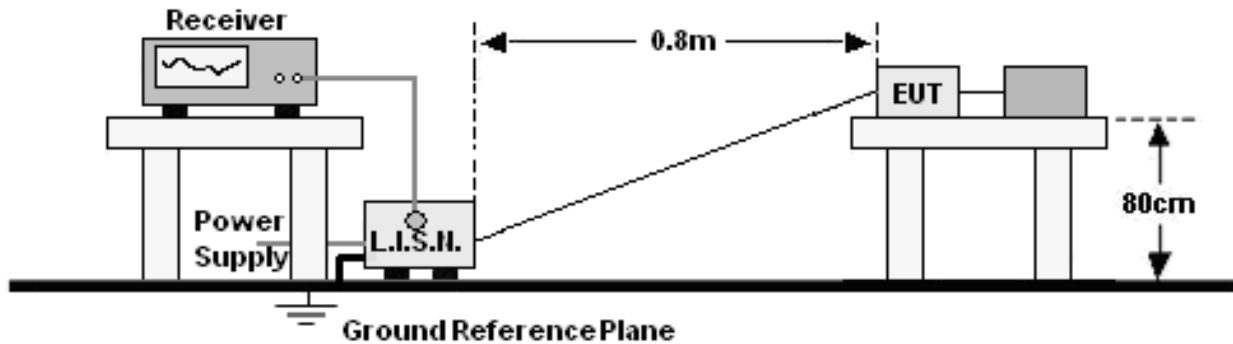

6.2 Limit

Frequency (MHz)	Limit (dBuV)	
	Quas-peak	Average
0.15 -0.5	66 - 56 *	56 - 46 *
0.50 -5.0	56.00	46.00
5.0 -30.0	60.00	50.00

Notes:

- *Decreasing linearly with logarithm of frequency.
- The lower limit shall apply at the transition frequencies.

6.3 Test procedure

Receiver Parameters	Setting
Attenuation	10 dB
Start Frequency	0.15 MHz
Stop Frequency	30 MHz
IF Bandwidth	9 kHz

- The Product was placed on a nonconductive table 0.8 m above the horizontal ground reference plane, and 0.4 m from the vertical ground reference plane, and connected to the main through Line Impedance Stability Network (L.I.S.N).
- The RBW of the receiver was set at 9 kHz in 150 kHz ~ 30MHz with Peak and AVG detector in Max Hold mode. Run the receiver's pre-scan to record the maximum disturbance generated from Product in all power lines in the full band.
- For each frequency whose maximum record was higher or close to limit, measure its QP and AVG values and record.

6.4 EUT operating Conditions

The EUT was configured for testing in a typical fashion (as a customer would normally use it). The EUT has been programmed to continuously transmit during test. This operating condition was tested and used to collect the included data.

6.5 Test Result

Temperature:	26 °C	Relative Humidity:	54%
Pressure:	101KPa	Test Voltage:	AC120V/60Hz
Test Mode:	Mode 19	Polarization :	L

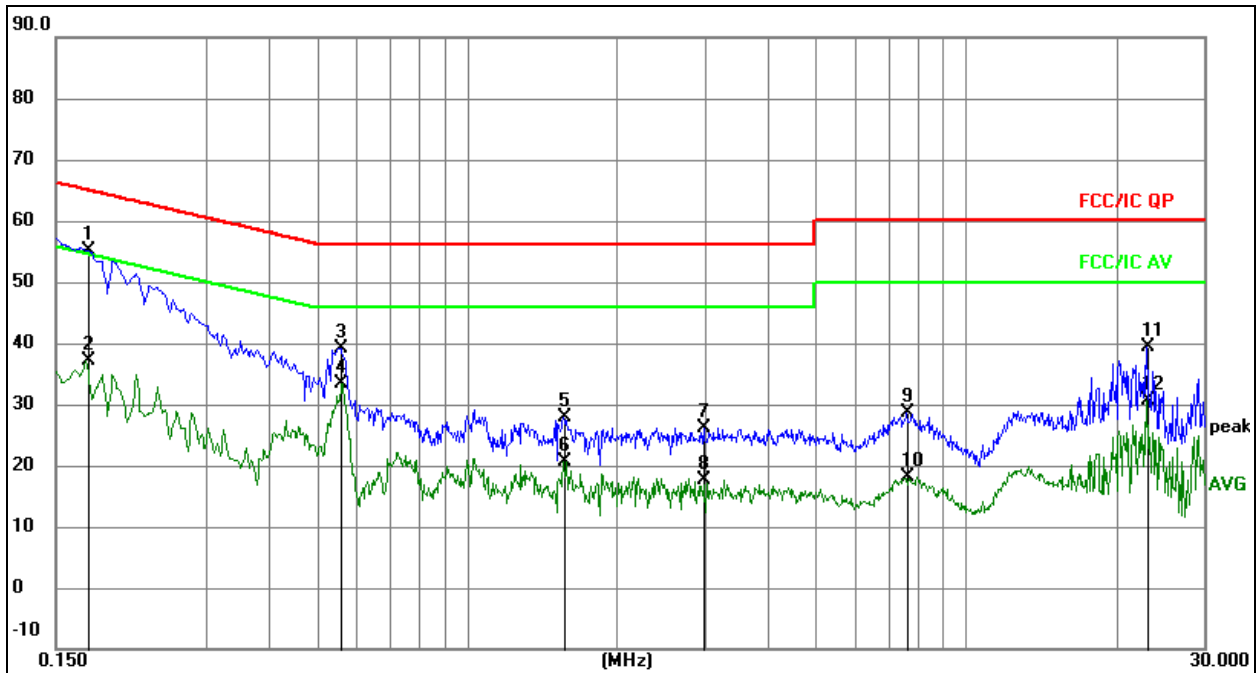

Remark:

1. All readings are Quasi-Peak and Average values.
2. Factor = Insertion Loss + Cable Loss.
3. Measurement = Reading Level + Correct Factor
4. Over = Measurement - Limit

No.	Mk.	Freq. MHz	Reading Level	Correct Factor dB	Measure- ment dBuV	Limit dBuV	Over dB	Detector
1	*	0.1749	35.23	19.78	55.01	64.72	-9.71	QP
2		0.1749	17.46	19.78	37.24	54.72	-17.48	AVG
3		0.5595	19.31	19.84	39.15	56.00	-16.85	QP
4		0.5595	13.58	19.84	33.42	46.00	-12.58	AVG
5		1.5630	7.83	19.95	27.78	56.00	-28.22	QP
6		1.5630	0.76	19.95	20.71	46.00	-25.29	AVG
7		2.9895	5.93	20.30	26.23	56.00	-29.77	QP
8		2.9895	-2.64	20.30	17.66	46.00	-28.34	AVG
9		7.6245	8.69	19.94	28.63	60.00	-31.37	QP
10		7.6245	-1.86	19.94	18.08	50.00	-31.92	AVG
11		23.1315	19.40	19.99	39.39	60.00	-20.61	QP
12		23.1315	10.60	19.99	30.59	50.00	-19.41	AVG

Temperature:	26 °C	Relative Humidity:	54%
Pressure:	101KPa	Test Voltage:	AC120V/60Hz
Test Mode:	Mode 19	Polarization :	N

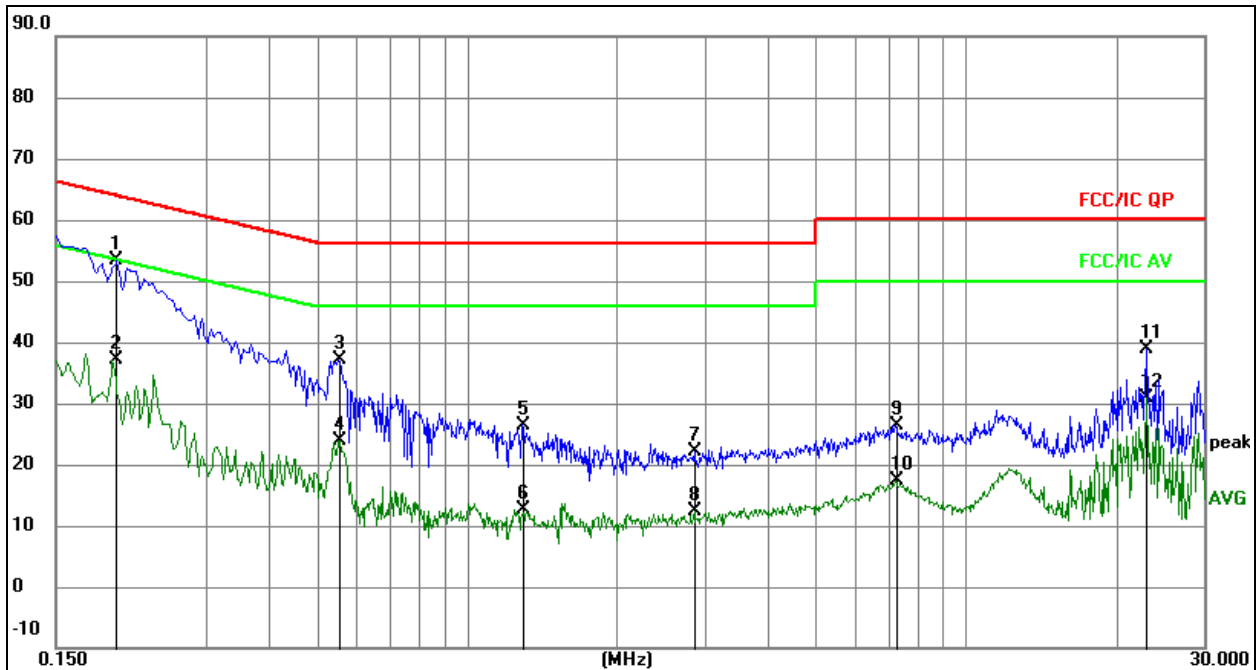
Remark:

1. All readings are Quasi-Peak and Average values.
2. Factor = Insertion Loss + Cable Loss.
3. Measurement = Reading Level + Correct Factor
4. Over = Measurement - Limit

No.	Mk.	Freq. MHz	Reading Level	Correct Factor dB	Measure- ment dBuV	Limit dBuV	Over dB	Detector
1	*	0.1986	33.44	19.83	53.27	63.67	-10.40	QP
2		0.1986	17.26	19.83	37.09	53.67	-16.58	AVG
3		0.5523	17.34	19.84	37.18	56.00	-18.82	QP
4		0.5523	4.13	19.84	23.97	46.00	-22.03	AVG
5		1.2892	6.55	19.95	26.50	56.00	-29.50	QP
6		1.2892	-7.36	19.95	12.59	46.00	-33.41	AVG
7		2.8541	1.99	20.25	22.24	56.00	-33.76	QP
8		2.8541	-7.86	20.25	12.39	46.00	-33.61	AVG
9		7.2135	6.36	19.95	26.31	60.00	-33.69	QP
10		7.2135	-2.65	19.95	17.30	50.00	-32.70	AVG
11		23.0181	18.80	19.99	38.79	60.00	-21.21	QP
12		23.0181	10.88	19.99	30.87	50.00	-19.13	AVG

7. Radiated Emissions

7.1 Block Diagram Of Test Setup

(A) Radiated Emission Test-Up Frequency Below 30MHz

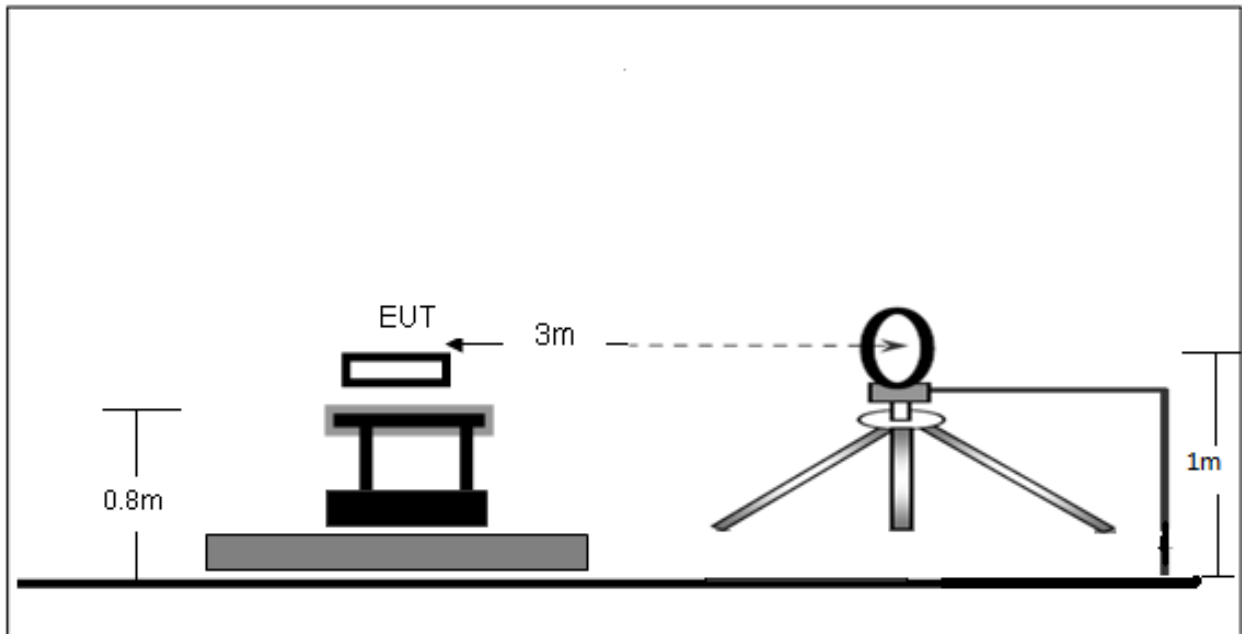

(B) Radiated Emission Test-Up Frequency 30MHz~1GHz

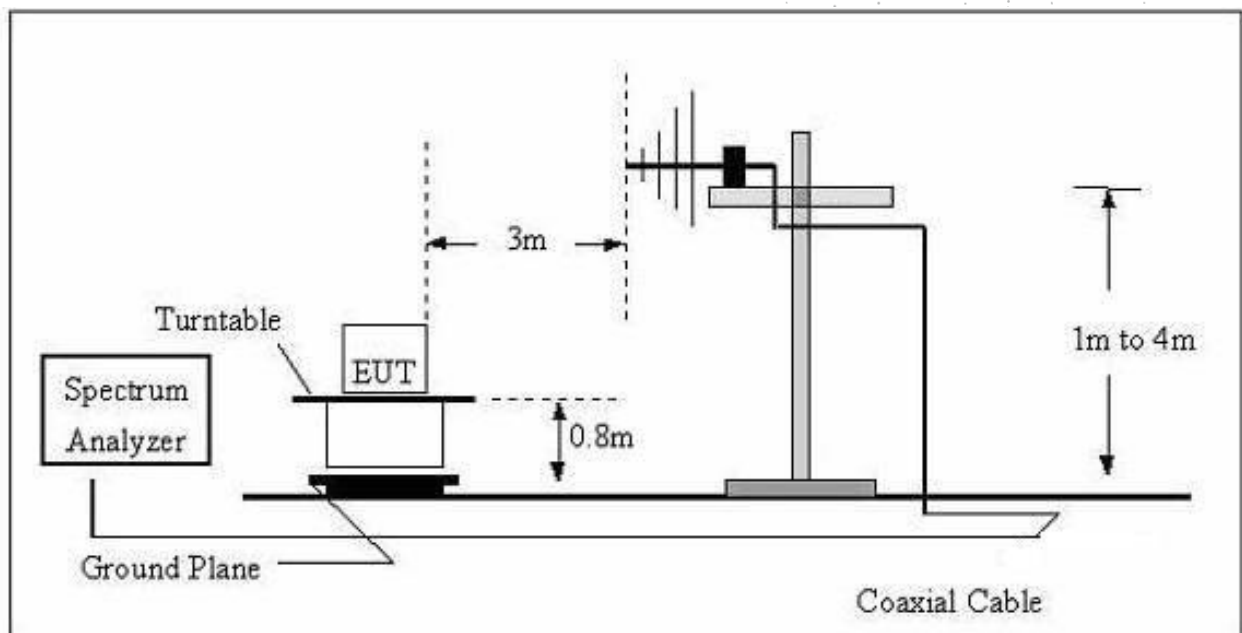

(C) Radiated Emission Test-Up Frequency Above 1GHz

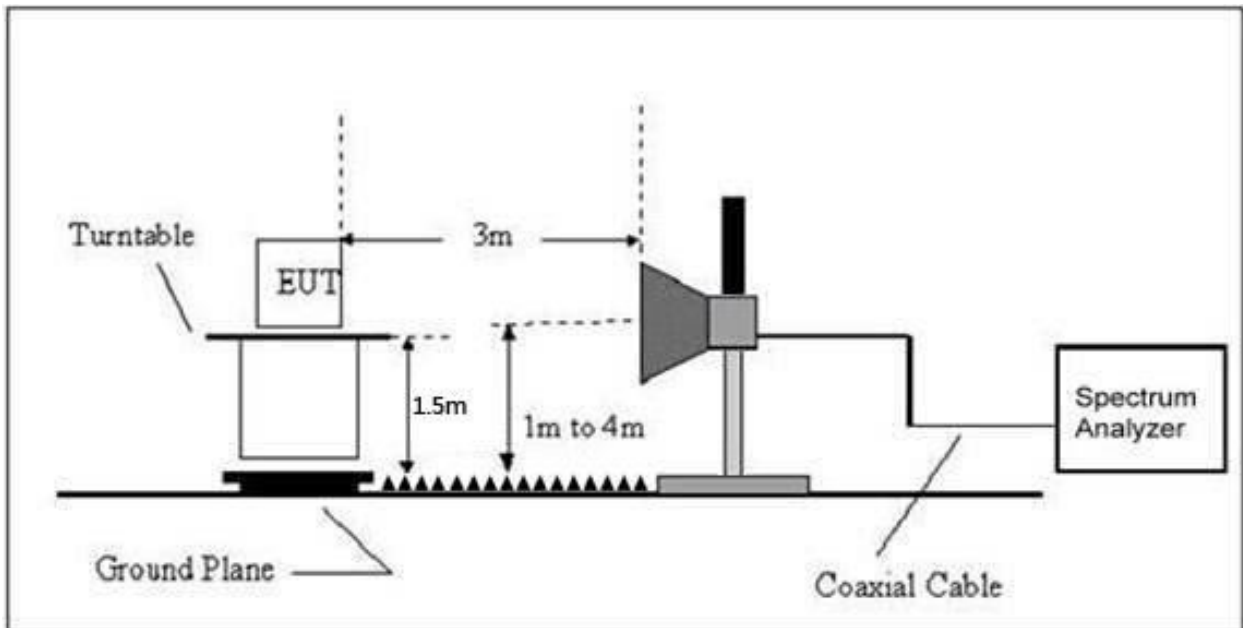

7.2 Limit

20dBc in any 100 kHz bandwidth outside the operating frequency band. In case the emission fall within the restricted band specified on 15.205(a), then the 15.209(a) limit in the table below has to be followed.

Frequency (MHz)	Field Strength uV/m	Distance (m)	Field Strength Limit at 3m Distance	
			uV/m	dBuV/m
0.009 ~ 0.490	$2400/F(\text{kHz})$	300	$10000 * 2400/F(\text{kHz})$	$20\log^{(2400/F(\text{kHz}))} + 80$
0.490 ~ 1.705	$24000/F(\text{kHz})$	30	$100 * 24000/F(\text{kHz})$	$20\log^{(24000/F(\text{kHz}))} + 40$
1.705 ~ 30	30	30	$100 * 30$	$20\log^{(30)} + 40$
30 ~ 88	100	3	100	$20\log^{(100)}$
88 ~ 216	150	3	150	$20\log^{(150)}$
216 ~ 960	200	3	200	$20\log^{(200)}$
Above 960	500	3	500	$20\log^{(500)}$

Limits Of Radiated Emission Measurement (Above 1000MHz)

Frequency (MHz)	Limit (dBuV/m) (at 3M)	
	Peak	Average
Above 1000	74	54

Notes:

- (1)The limit for radiated test was performed according to FCC PART 15C.
- (2)The tighter limit applies at the band edges.
- (3) Emission level (dBuV/m)=20log Emission level (uV/m).

Frequency Range Of Radiated Measurement

(a) For an intentional radiator the spectrum shall be investigated from the lowest radio frequency signal generated in the device, without going below 9 kHz, up to at least the frequency shown in this paragraph:

- (1) If the intentional radiator operates below 10 GHz: to the tenth harmonic of the highest fundamental frequency or to 40 GHz, whichever is lower.
- (2) If the intentional radiator operates at or above 10 GHz and below 30 GHz: to the fifth harmonic of the highest fundamental frequency or to 100 GHz, whichever is lower.
- (3) If the intentional radiator operates at or above 30 GHz: to the fifth harmonic of the highest fundamental frequency or to 200 GHz, whichever is lower, unless specified otherwise elsewhere in the rules.
- (4) If the intentional radiator operates at or above 95 GHz: To the third harmonic of the highest fundamental frequency or to 750 GHz, whichever is lower, unless specified otherwise elsewhere in the rules.
- (5) If the intentional radiator contains a digital device, regardless of whether this digital device controls the functions of the intentional radiator or the digital device is used for additional control or function purposes other than to enable the operation of the intentional radiator, the frequency range shall be investigated up to the range specified in paragraphs (a) (1)through (4) of this section or the range applicable to the digital device, as shown in paragraph (b)(1) of this section, whichever is the higher frequency range of investigation.

7.3 Test procedure

Receiver Parameter	Setting
Attenuation	Auto
9kHz~150kHz	RBW 200Hz for QP
150kHz~30MHz	RBW 9kHz for QP
30MHz~1000MHz	RBW 120kHz for QP

Spectrum Parameter	Setting
1-25GHz	RBW 1 MHz /VBW 1 MHz for Peak, RBW 1 MHz / VBW 10Hz for Average

Below 1GHz test procedure as below:

- a. The EUT was placed on the top of a rotating table 0.8 meters above the ground at a 3 meter semi-anechoic chamber. The table was rotated 360 degrees to determine the position of the highest radiation.
- b. The EUT was set 3 meters away from the interference-receiving antenna, which was mounted on the top of a variable-height antenna tower.
- c. The antenna height is varied from one meter to four meters above the ground to determine the maximum value of the field strength. Both horizontal and vertical polarizations of the antenna are set to make the measurement.
- d. For each suspected emission, the EUT was arranged to its worst case and then the antenna was tuned to heights from 1 meter to 4 meters (for the test frequency of below 30MHz, the antenna was tuned to heights 1 meter) and the rotatable table was turned from 0 degrees to 360 degrees to find the maximum reading.
- e. The test-receiver system was set to Peak Detect Function and Specified Bandwidth with Maximum Hold Mode.
- f. If the emission level of the EUT in peak mode was 10dB lower than the limit specified, then testing could be stopped and the peak values of the EUT would be reported. Otherwise the emissions that did not have 10dB margin would be re-tested one by one using peak, quasi-peak or average method as specified and then reported in a data sheet.

Above 1GHz test procedure as below:

- a. The EUT was placed on the top of a rotating table 1.5 meters above the ground at a 3 meter camber. The table was rotated 360 degrees to determine the position of the highest radiation.
- b. The EUT was set 3 meters away from the interference-receiving antenna, which was mounted on the top of a variable-height antenna tower.
- c. The antenna height is varied from one meter to four meters above the ground to determine the maximum value of the field strength. Both horizontal and vertical polarizations of the antenna are set to make the measurement.
- d. For each suspected emission, the EUT was arranged to its worst case and then the antenna was tuned to heights from 1 meter to 4 meters and the rota table was turned from 0 degrees to 360 degrees to find the maximum reading.
- e. The test-receiver system was set to Peak Detect Function and Specified Bandwidth with Maximum Hold Mode.
- f. If the emission level of the EUT in peak mode was 10dB lower than the limit specified, then testing could be stopped and the peak values of the EUT would be reported. Otherwise the emissions that did not have 10dB margin would be re-tested one by one using peak, quasi-peak or average method as specified and then reported in a data sheet.
- g. Test the EUT in the lowest channel, the middlest channel, the Highest channel.

Note:

Both horizontal and vertical antenna polarities were tested and performed pretest to three orthogonal axis. The worst case emissions were reported.

7.4 EUT Operating Conditions

The EUT was configured for testing in a typical fashion (as a customer would normally use it). The EUT has been programmed to continuously transmit during test. This operating condition was tested and used to collect the included data.

7.5 Test Result

Below 30MHz

Temperature:	26 °C	Relative Humidity:	54%
Pressure:	101KPa	Test Voltage :	AC120V/60Hz
Test Mode:	Mode 19	Polarization:	---

Freq. (MHz)	Reading (dBuV/m)	Limit (dBuV/m)	Margin (dB)	State P/F
--	--	--	--	PASS
--	--	--	--	PASS

Note:

The amplitude of spurious emissions which are attenuated by more than 20dB below the permissible value has no need to be reported.

Distance extrapolation factor = $40 \log(\text{specific distance}/\text{test distance})(\text{dB})$;

Limit line = specific limits(dBuv) + distance extrapolation factor.

Between 30MHz – 1GHz

Temperature:	26 °C	Relative Humidity:	54%
Pressure:	101KPa	Test Voltage:	AC120V/60Hz
Test Mode:	Mode 19	Polarization :	Horizontal

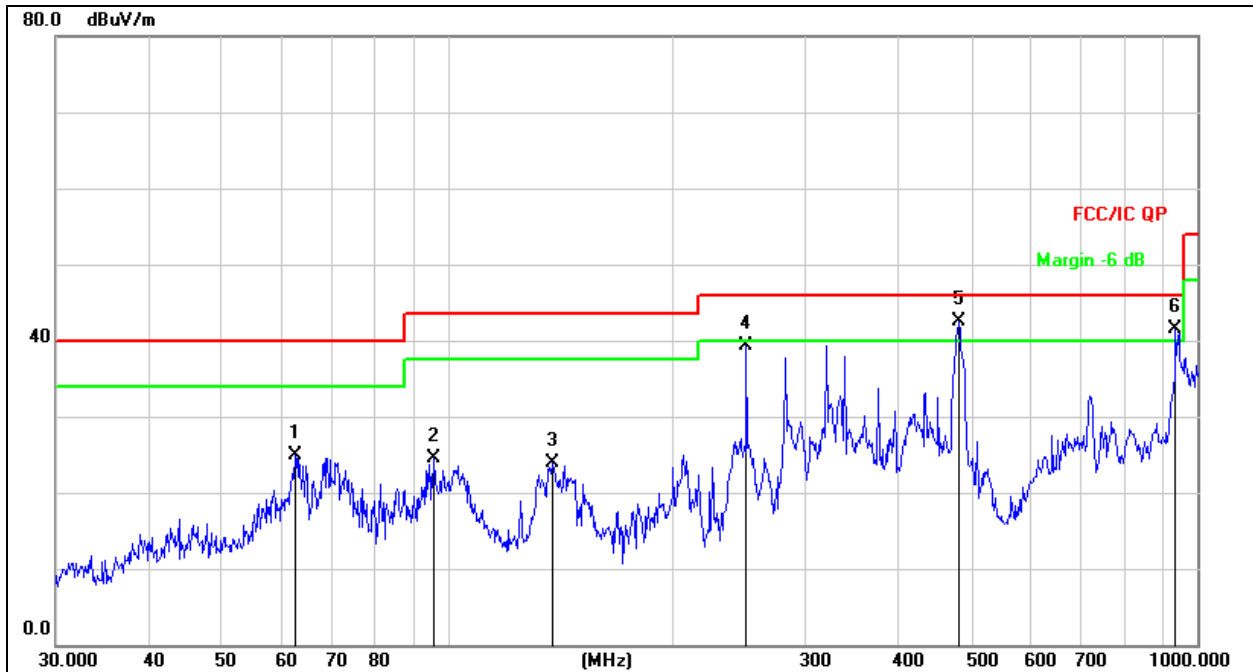

Remark:

1. Factor = Antenna Factor + Cable Loss – Pre-amplifier.
2. Measurement = Reading Level + Correct Factor
3. Over = Measurement - Limit

No.	Mk.	Freq. MHz	Reading Level dBuV	Correct Factor dB	Measure- ment dBuV/m	Limit dB/m	Over dB	Detector
1		62.6507	40.97	-15.98	24.99	40.00	-15.01	QP
2		95.7622	41.04	-16.55	24.49	43.50	-19.01	QP
3		137.9028	42.50	-18.58	23.92	43.50	-19.58	QP
4		250.3012	53.62	-14.28	39.34	46.00	-6.66	QP
5	*	480.5276	51.69	-9.10	42.59	46.00	-3.41	QP
6	!	935.5463	44.54	-2.99	41.55	46.00	-4.45	QP

Temperature:	26 °C	Relative Humidity:	54%
Pressure:	101KPa	Test Voltage:	AC120V/60Hz
Test Mode:	Mode 19	Polarization :	Vertical

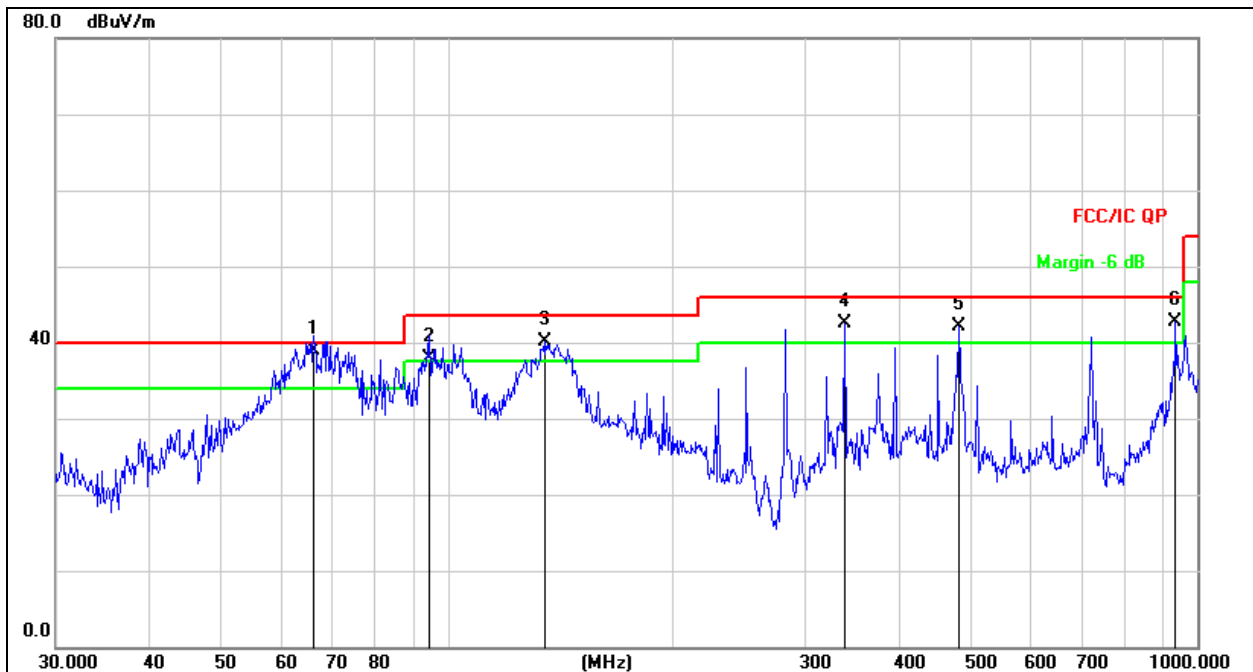
Remark:

1. Factor = Antenna Factor + Cable Loss – Pre-amplifier.
2. Measurement = Reading Level + Correct Factor
3. Over = Measurement - Limit

No.	Mk.	Freq. MHz	Reading Level dBuV	Correct Factor dB	Measure- ment dBuV/m	Limit dB/m	Over dB	Detector
1	*	66.2662	55.94	-16.97	38.97	40.00	-1.03	QP
2	!	94.4284	54.72	-16.75	37.97	43.50	-5.53	QP
3	!	134.5592	58.40	-18.35	40.05	43.50	-3.45	QP
4	!	338.4001	54.34	-11.89	42.45	46.00	-3.55	QP
5	!	480.5276	51.25	-9.10	42.15	46.00	-3.85	QP
6	!	935.5463	45.64	-2.99	42.65	46.00	-3.35	QP

Between 1GHz – 25GHz
802.11b

Polar (H/V)	Fre- quency	Reading Level	Correct Factor	Measure- ment	Limits	Over	Detector Type
	(MHz)	(dBuV/m)	(dB)	(dBuV/m)	(dBuV/m)	(dB)	
Low channel:2412MHz							
V	4824.00	70.64	-19.95	50.69	74.00	-23.31	PK
V	4824.00	60.14	-19.95	40.19	54.00	-13.81	AV
V	7236.00	60.46	-14.14	46.32	74.00	-27.68	PK
V	7236.00	50.45	-14.14	36.31	54.00	-17.69	AV
H	4824.00	69.09	-19.95	49.14	74.00	-24.86	PK
H	4824.00	59.96	-19.95	40.01	54.00	-13.99	AV
H	7236.00	58.28	-14.14	44.14	74.00	-29.86	PK
H	7236.00	51.23	-14.14	37.09	54.00	-16.91	AV
Middle channel:2437MHz							
V	4874.00	67.80	-19.85	47.95	74.00	-26.05	PK
V	4874.00	60.33	-19.85	40.48	54.00	-13.52	AV
V	7311.00	58.99	-13.93	45.06	74.00	-28.94	PK
V	7311.00	50.19	-13.93	36.26	54.00	-17.74	AV
H	4874.00	63.83	-19.85	43.98	74.00	-30.02	PK
H	4874.00	54.37	-19.85	34.52	54.00	-19.48	AV
H	7311.00	56.30	-13.93	42.37	74.00	-31.63	PK
H	7311.00	48.66	-13.93	34.73	54.00	-19.27	AV
High channel:2462MHz							
V	4924.00	70.13	-19.75	50.38	74.00	-23.62	PK
V	4924.00	61.92	-19.75	42.17	54.00	-11.83	AV
V	7386.00	62.87	-13.72	49.15	74.00	-24.85	PK
V	7386.00	52.00	-13.72	38.28	54.00	-15.72	AV
H	4924.00	68.54	-19.75	48.79	74.00	-25.21	PK
H	4924.00	58.45	-19.75	38.70	54.00	-15.30	AV
H	7386.00	59.97	-13.72	46.25	74.00	-27.75	PK
H	7386.00	52.62	-13.72	38.90	54.00	-15.10	AV

Remark:

1. Measurement = Reading Level + Correct Factor,
Correct Factor = Antenna Factor + Cable Loss – Pre-amplifier,
Over= Measurement – Limit
- 2.If peak below the average limit, the average emission was no test.
3. In restricted bands of operation, The spurious emissions below the permissible value more than 20dB
4. The amplitude of spurious emissions which are attenuated by more than 20dB below the permissible value has no need to be reported.
5. The worst case is Antenna A.

802.11g

Polar (H/V)	Fre- quency	Reading Level	Correct Factor	Measure- ment	Limits	Over	Detector Type
	(MHz)	(dBuV/m)	(dB)	(dBuV/m)	(dBuV/m)	(dB)	
Low channel:2412MHz							
V	4824.00	69.49	-19.95	49.54	74.00	-24.46	PK
V	4824.00	59.38	-19.95	39.43	54.00	-14.57	AV
V	7236.00	59.52	-14.14	45.38	74.00	-28.62	PK
V	7236.00	48.58	-14.14	34.44	54.00	-19.56	AV
H	4824.00	64.60	-19.95	44.65	74.00	-29.35	PK
H	4824.00	54.27	-19.95	34.32	54.00	-19.68	AV
H	7236.00	57.79	-14.14	43.65	74.00	-30.35	PK
H	7236.00	50.19	-14.14	36.05	54.00	-17.95	AV
Middle channel:2437MHz							
V	4874.00	66.23	-19.85	46.38	74.00	-27.62	PK
V	4874.00	59.00	-19.85	39.15	54.00	-14.85	AV
V	7311.00	58.13	-13.93	44.20	74.00	-29.80	PK
V	7311.00	49.65	-13.93	35.72	54.00	-18.28	AV
H	4874.00	64.02	-19.85	44.17	74.00	-29.83	PK
H	4874.00	54.88	-19.85	35.03	54.00	-18.97	AV
H	7311.00	56.21	-13.93	42.28	74.00	-31.72	PK
H	7311.00	47.92	-13.93	33.99	54.00	-20.01	AV
High channel:2462MHz							
V	4924.00	67.62	-19.75	47.87	74.00	-26.13	PK
V	4924.00	57.52	-19.75	37.77	54.00	-16.23	AV
V	7386.00	60.72	-13.72	47.00	74.00	-27.00	PK
V	7386.00	51.26	-13.72	37.54	54.00	-16.46	AV
H	4924.00	66.38	-19.75	46.63	74.00	-27.37	PK
H	4924.00	56.99	-19.75	37.24	54.00	-16.76	AV
H	7386.00	59.66	-13.72	45.94	74.00	-28.06	PK
H	7386.00	52.18	-13.72	38.46	54.00	-15.54	AV

Remark:

1. Measurement = Reading Level + Correct Factor,
Correct Factor = Antenna Factor + Cable Loss – Pre-amplifier,
Over= Measurement – Limit
- 2.If peak below the average limit, the average emission was no test.
3. In restricted bands of operation, The spurious emissions below the permissible value more than 20dB
4. The amplitude of spurious emissions which are attenuated by more than 20dB below the permissible value has no need to be reported.
5. The worst case is Antenna A.

802.11n20

Polar (H/V)	Fre- quency	Reading Level	Correct Factor	Measure- ment	Limits	Over	Detector Type
	(MHz)	(dBuV/m)	(dB)	(dBuV/m)	(dBuV/m)	(dB)	
Low channel:2412MHz							
V	4824.00	70.66	-19.95	50.71	74.00	-23.29	PK
V	4824.00	59.88	-19.95	39.93	54.00	-14.07	AV
V	7236.00	62.99	-14.14	48.85	74.00	-25.15	PK
V	7236.00	52.72	-14.14	38.58	54.00	-15.42	AV
H	4824.00	69.08	-19.95	49.13	74.00	-24.87	PK
H	4824.00	59.41	-19.95	39.46	54.00	-14.54	AV
H	7236.00	60.63	-14.14	46.49	74.00	-27.51	PK
H	7236.00	52.50	-14.14	38.36	54.00	-15.64	AV
Middle channel:2437MHz							
V	4874.00	68.88	-19.85	49.03	74.00	-24.97	PK
V	4874.00	60.03	-19.85	40.18	54.00	-13.82	AV
V	7311.00	58.30	-13.93	44.37	74.00	-29.63	PK
V	7311.00	49.37	-13.93	35.44	54.00	-18.56	AV
H	4874.00	65.02	-19.85	45.17	74.00	-28.83	PK
H	4874.00	54.71	-19.85	34.86	54.00	-19.14	AV
H	7311.00	55.78	-13.93	41.85	74.00	-32.15	PK
H	7311.00	48.56	-13.93	34.63	54.00	-19.37	AV
High channel:2462MHz							
V	4924.00	71.34	-19.75	51.59	74.00	-22.41	PK
V	4924.00	62.79	-19.75	43.04	54.00	-10.96	AV
V	7386.00	62.85	-13.72	49.13	74.00	-24.87	PK
V	7386.00	52.67	-13.72	38.95	54.00	-15.05	AV
H	4924.00	69.21	-19.75	49.46	74.00	-24.54	PK
H	4924.00	58.89	-19.75	39.14	54.00	-14.86	AV
H	7386.00	61.06	-13.72	47.34	74.00	-26.66	PK
H	7386.00	52.94	-13.72	39.22	54.00	-14.78	AV

Remark:

1. Measurement = Reading Level + Correct Factor,
Correct Factor = Antenna Factor + Cable Loss – Pre-amplifier,
Over= Measurement – Limit
- 2.If peak below the average limit, the average emission was no test.
3. In restricted bands of operation, The spurious emissions below the permissible value more than 20dB
4. The amplitude of spurious emissions which are attenuated by more than 20dB below the permissible value has no need to be reported.
5. Test Mode is MIMO Mode.

802.11n40

Polar (H/V)	Fre- quency	Reading Level	Correct Factor	Measure- ment	Limits	Over	Detector Type
	(MHz)	(dBuV/m)	(dB)	(dBuV/m)	(dBuV/m)	(dB)	
Low channel:2422MHz							
V	4844.00	69.15	-19.91	49.24	74.00	-24.76	PK
V	4844.00	59.30	-19.91	39.39	54.00	-14.61	AV
V	7266.00	61.03	-14.06	46.97	74.00	-27.03	PK
V	7266.00	51.00	-14.06	36.94	54.00	-17.06	AV
H	4844.00	66.49	-19.91	46.58	74.00	-27.42	PK
H	4844.00	55.72	-19.91	35.81	54.00	-18.19	AV
H	7266.00	58.84	-14.06	44.78	74.00	-29.22	PK
H	7266.00	51.63	-14.06	37.57	54.00	-16.43	AV
Middle channel:2437MHz							
V	4874.00	66.68	-19.85	46.83	74.00	-27.17	PK
V	4874.00	57.99	-19.85	38.14	54.00	-15.86	AV
V	7311.00	56.59	-13.93	42.66	74.00	-31.34	PK
V	7311.00	47.45	-13.93	33.52	54.00	-20.48	AV
H	4874.00	65.67	-19.85	45.82	74.00	-28.18	PK
H	4874.00	55.87	-19.85	36.02	54.00	-17.98	AV
H	7311.00	55.37	-13.93	41.44	74.00	-32.56	PK
H	7311.00	48.31	-13.93	34.38	54.00	-19.62	AV
High channel:2452MHz							
V	4904.00	69.59	-19.79	49.80	74.00	-24.20	PK
V	4904.00	60.31	-19.79	40.52	54.00	-13.48	AV
V	7356.00	61.73	-13.80	47.93	74.00	-26.07	PK
V	7356.00	51.36	-13.80	37.56	54.00	-16.44	AV
H	4904.00	66.60	-19.79	46.81	74.00	-27.19	PK
H	4904.00	56.58	-19.79	36.79	54.00	-17.21	AV
H	7356.00	59.00	-13.80	45.20	74.00	-28.80	PK
H	7356.00	50.20	-13.80	36.40	54.00	-17.60	AV

Remark:

1. Measurement = Reading Level + Correct Factor,
Correct Factor = Antenna Factor + Cable Loss – Pre-amplifier,
Over= Measurement – Limit
- 2.If peak below the average limit, the average emission was no test.
3. In restricted bands of operation, The spurious emissions below the permissible value more than 20dB
4. The amplitude of spurious emissions which are attenuated by more than 20dB below the permissible value has no need to be reported.
5. Test Mode is MIMO Mode.

802.11ax20

Polar (H/V)	Fre- quency	Reading Level	Correct Factor	Measure- ment	Limits	Over	Detector Type
	(MHz)	(dBuV/m)	(dB)	(dBuV/m)	(dBuV/m)	(dB)	
Low channel:2412MHz							
V	4824.00	69.21	-19.95	49.26	74.00	-24.74	PK
V	4824.00	60.39	-19.95	40.44	54.00	-13.56	AV
V	7236.00	61.46	-14.14	47.32	74.00	-26.68	PK
V	7236.00	50.77	-14.14	36.63	54.00	-17.37	AV
H	4824.00	66.88	-19.95	46.93	74.00	-27.07	PK
H	4824.00	56.04	-19.95	36.09	54.00	-17.91	AV
H	7236.00	59.68	-14.14	45.54	74.00	-28.46	PK
H	7236.00	51.43	-14.14	37.29	54.00	-16.71	AV
Middle channel:2437MHz							
V	4874.00	67.58	-19.85	47.73	74.00	-26.27	PK
V	4874.00	59.10	-19.85	39.25	54.00	-14.75	AV
V	7311.00	56.98	-13.93	43.05	74.00	-30.95	PK
V	7311.00	47.45	-13.93	33.52	54.00	-20.48	AV
H	4874.00	63.01	-19.85	43.16	74.00	-30.84	PK
H	4874.00	53.62	-19.85	33.77	54.00	-20.23	AV
H	7311.00	54.29	-13.93	40.36	74.00	-33.64	PK
H	7311.00	46.40	-13.93	32.47	54.00	-21.53	AV
High channel:2462MHz							
V	4924.00	68.85	-19.75	49.10	74.00	-24.90	PK
V	4924.00	59.36	-19.75	39.61	54.00	-14.39	AV
V	7386.00	60.74	-13.72	47.02	74.00	-26.98	PK
V	7386.00	50.76	-13.72	37.04	54.00	-16.96	AV
H	4924.00	66.03	-19.75	46.28	74.00	-27.72	PK
H	4924.00	55.81	-19.75	36.06	54.00	-17.94	AV
H	7386.00	58.63	-13.72	44.91	74.00	-29.09	PK
H	7386.00	51.11	-13.72	37.39	54.00	-16.61	AV

Remark:

1. Measurement = Reading Level + Correct Factor,
Correct Factor = Antenna Factor + Cable Loss – Pre-amplifier,
Over= Measurement – Limit
- 2.If peak below the average limit, the average emission was no test.
3. In restricted bands of operation, The spurious emissions below the permissible value more than 20dB
4. The amplitude of spurious emissions which are attenuated by more than 20dB below the permissible value has no need to be reported.
5. Test Mode is MIMO Mode.

802.11ax40

Polar (H/V)	Fre- quency	Reading Level	Correct Factor	Measure- ment	Limits	Over	Detector Type
	(MHz)	(dBuV/m)	(dB)	(dBuV/m)	(dBuV/m)	(dB)	
Low channel:2422MHz							
V	4844.00	68.07	-19.91	48.16	74.00	-25.84	PK
V	4844.00	59.69	-19.91	39.78	54.00	-14.22	AV
V	7266.00	60.18	-14.06	46.12	74.00	-27.88	PK
V	7266.00	50.86	-14.06	36.80	54.00	-17.20	AV
H	4844.00	65.07	-19.91	45.16	74.00	-28.84	PK
H	4844.00	54.31	-19.91	34.40	54.00	-19.60	AV
H	7266.00	58.35	-14.06	44.29	74.00	-29.71	PK
H	7266.00	51.05	-14.06	36.99	54.00	-17.01	AV
Middle channel:2437MHz							
V	4874.00	65.55	-19.85	45.70	74.00	-28.30	PK
V	4874.00	56.58	-19.85	36.73	54.00	-17.27	AV
V	7311.00	55.93	-13.93	42.00	74.00	-32.00	PK
V	7311.00	45.94	-13.93	32.01	54.00	-21.99	AV
H	4874.00	63.99	-19.85	44.14	74.00	-29.86	PK
H	4874.00	53.40	-19.85	33.55	54.00	-20.45	AV
H	7311.00	53.17	-13.93	39.24	74.00	-34.76	PK
H	7311.00	45.79	-13.93	31.86	54.00	-22.14	AV
High channel:2452MHz							
V	4904.00	66.72	-19.79	46.93	74.00	-27.07	PK
V	4904.00	57.46	-19.79	37.67	54.00	-16.33	AV
V	7356.00	60.39	-13.80	46.59	74.00	-27.41	PK
V	7356.00	49.83	-13.80	36.03	54.00	-17.97	AV
H	4904.00	64.52	-19.79	44.73	74.00	-29.27	PK
H	4904.00	54.92	-19.79	35.13	54.00	-18.87	AV
H	7356.00	58.94	-13.80	45.14	74.00	-28.86	PK
H	7356.00	51.59	-13.80	37.79	54.00	-16.21	AV

Remark:

1. Measurement = Reading Level + Correct Factor,
Correct Factor = Antenna Factor + Cable Loss – Pre-amplifier,
Over= Measurement – Limit
- 2.If peak below the average limit, the average emission was no test.
3. In restricted bands of operation, The spurious emissions below the permissible value more than 20dB
4. The amplitude of spurious emissions which are attenuated by more than 20dB below the permissible value has no need to be reported.
5. Test Mode is MIMO Mode.

8. Radiated Band Emission Measurement And Restricted Bands Of Operation

8.1 Block Diagram Of Test Setup

Radiated Emission Test-Up Frequency Above 1GHz

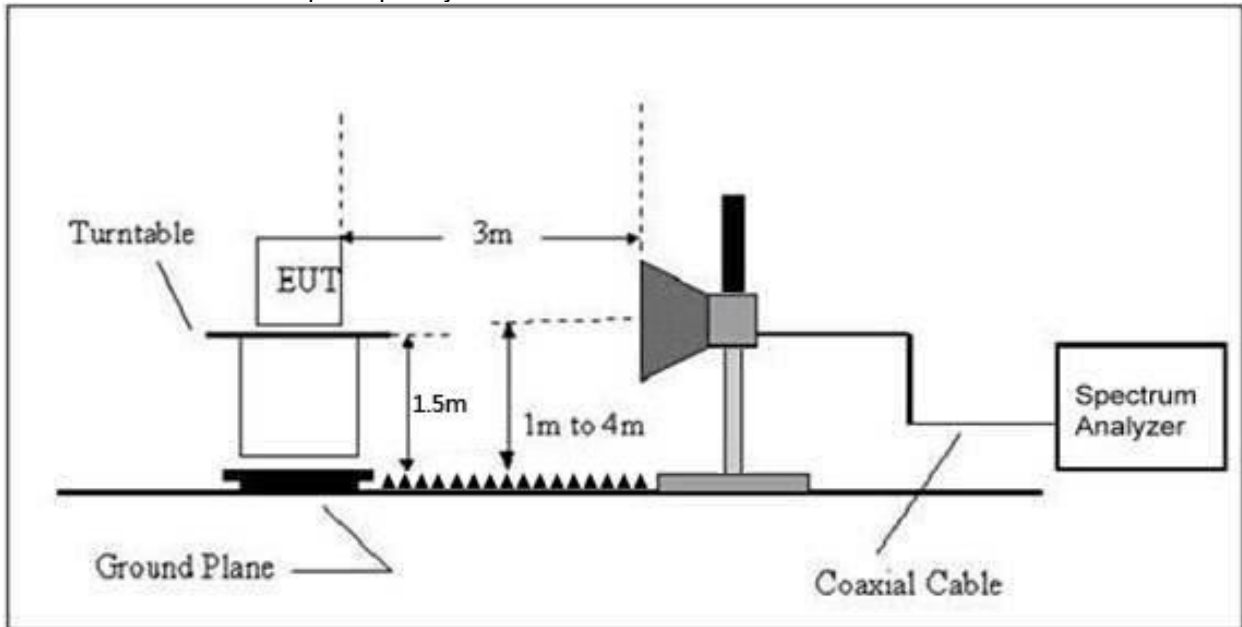

8.2 Limit

FCC Part15 C Section 15.209 and 15.205

(a) Except as shown in paragraph (d) of this section, only spurious emissions are permitted in any of the frequency bands listed below:

MHz	MHz	MHz	GHz
0.090-0.110	16.42-16.423	399.9-410	4.5-5.15
0.495-0.505	16.69475-16.69525	608-614	5.35-5.46
2.1735-2.1905	16.80425-16.80475	960-1240	7.25-7.75
4.125-4.128	25.5-25.67	1300-1427	8.025-8.5
4.17725-4.17775	37.5-38.25	1435-1626.5	9.0-9.2
4.20725-4.20775	73-74.6	1645.5-1646.5	9.3-9.5
6.215-6.218	74.8-75.2	1660-1710	10.6-12.7
6.26775-6.26825	108-121.94	1718.8-1722.2	13.25-13.4
6.31175-6.31225	123-138	2200-2300	14.47-14.5
8.291-8.294	149.9-150.05	2310-2390	15.35-16.2
8.362-8.366	156.52475-156.52525	2483.5-2500	17.7-21.4
8.37625-8.38675	156.7-156.9	2690-2900	22.01-23.12
8.41425-8.41475	162.0125-167.17	3260-3267	23.6-24.0
12.29-12.293	167.72-173.2	3332-3339	31.2-31.8
12.51975-12.52025	240-285	3345.8-3358	36.43-36.5
12.57675-12.57725	322-335.4	3600-4400	(2)
13.36-13.41			

Limits Of Radiated Emission Measurement (Above 1000MHz)

Frequency (MHz)	Limit (dBuV/m) (at 3M)	
	Peak	Average
Above 1000	74	54

Notes:

- (1)The limit for radiated test was performed according to FCC PART 15C.
- (2)The tighter limit applies at the band edges.
- (3)Emission level (dBuV/m)=20log Emission level (uV/m).

8.3 Test procedure

Receiver Parameter	Setting
Attenuation	Auto
Start Frequency	2300MHz
Stop Frequency	2520
RB / VB (emission in restricted band)	1 MHz / 1 MHz for Peak, 1 MHz / 10Hz for Average

Above 1GHz test procedure as below:

- a.The EUT was placed on the top of a rotating table 1.5 meters above the ground at a 3 meter camber. The table was rotated 360 degrees to determine the position of the highest radiation.
- b.The EUT was set 3 meters away from the interference-receiving antenna, which was mounted on the top of a variable-height antenna tower.
- c.The antenna height is varied from one meter to four meters above the ground to determine the maximum value of the field strength. Both horizontal and vertical polarizations of the antenna are set to make the measurement.
- d.For each suspected emission, the EUT was arranged to its worst case and then the antenna was tuned to heights from 1 meter to 4 meters and the rota table was turned from 0 degrees to 360 degrees to find the maximum reading.
- e.The test-receiver system was set to Peak Detect Function and Specified Bandwidth with Maximum Hold Mode.
- f. If the emission level of the EUT in peak mode was 10dB lower than the limit specified, then testing could be stopped and the peak values of the EUT would be reported. Otherwise the emissions that did not have 10dB margin would be re-tested one by one using peak, quasi-peak or average method as specified and then reported in a data sheet.
- g. Test the EUT in the lowest channel, the middlest channel, the Highest channel.

Note:

Both horizontal and vertical antenna polarities were tested and performed pretest to three orthogonal axis. The worst case emissions were reported.

8.4 EUT Operating Conditions

The EUT was configured for testing in a typical fashion (as a customer would normally use it). The EUT has been programmed to continuously transmit during test. This operating condition was tested and used to collect the included data.

8.5 Test Result

Test mode	Polar (H/V)	Frequency (MHz)	Reading Level (dBuV/m)	Correct Factor (dB)	Measurement (dBuV/m)		Over		Result	
					PK	PK	AV	PK		
802.11b	Low Channel 2412MHz									
	H	2390.00	72.33	-25.43	46.90	74.00	54.00	-27.10	PASS	
	H	2400.00	75.82	-25.40	50.42	74.00	54.00	-23.58	PASS	
	V	2390.00	72.19	-25.43	46.76	74.00	54.00	-27.24	PASS	
	V	2400.00	74.18	-25.40	48.78	74.00	54.00	-25.22	PASS	
	High Channel 2462MHz									
	H	2483.50	71.64	-25.15	46.49	74.00	54.00	-27.51	PASS	
	H	2500.00	69.81	-25.10	44.71	74.00	54.00	-29.29	PASS	
	V	2483.50	70.64	-25.15	45.49	74.00	54.00	-28.51	PASS	
	V	2500.00	69.31	-25.10	44.21	74.00	54.00	-29.79	PASS	
	802.11g	Low Channel 2412MHz								
		H	2390.00	73.83	-25.43	48.40	74.00	54.00	-25.60	PASS
H		2400.00	75.87	-25.40	50.47	74.00	54.00	-23.53	PASS	
V		2390.00	73.92	-25.43	48.49	74.00	54.00	-25.51	PASS	
V		2400.00	75.08	-25.40	49.68	74.00	54.00	-24.32	PASS	
High Channel 2462MHz										
H		2483.50	73.31	-25.15	48.16	74.00	54.00	-25.84	PASS	
H		2500.00	71.60	-25.10	46.50	74.00	54.00	-27.50	PASS	
V		2483.50	73.94	-25.15	48.79	74.00	54.00	-25.21	PASS	
V		2500.00	71.50	-25.10	46.40	74.00	54.00	-27.60	PASS	

Remark:

1. Measurement = Reading Level + Correct Factor,
Correct Factor = Antenna Factor + Cable Loss – Pre-amplifier,
Over= Measurement - Limit
2. If the PK measured levels comply with average limit, then the average level were deemed to comply with average limit.
- 3 In restricted bands of operation, The spurious emissions below the permissible value more than 20dB
4. The amplitude of spurious emissions which are attenuated by more than 20dB below the permissible value has no need to be reported.
- 5.The worst case is Antenna A.

Test mode	Polar (H/V)	Frequency (MHz)	Reading Level (dBuV/m)	Correct Factor (dB)	Measurement (dBuV/m)		Measurement (dBuV/m)		Over	Result	
					PK	PK	AV	PK			
802.11 n20	Low Channel 2412MHz										
	H	2390.00	72.84	-25.43	47.41	74.00	54.00	-26.59	PASS		
	H	2400.00	76.93	-25.40	51.53	74.00	54.00	-22.47	PASS		
	V	2390.00	72.08	-25.43	46.65	74.00	54.00	-27.35	PASS		
	V	2400.00	76.01	-25.40	50.61	74.00	54.00	-23.39	PASS		
	High Channel 2462MHz										
	H	2483.50	72.30	-25.15	47.15	74.00	54.00	-26.85	PASS		
	H	2500.00	70.59	-25.10	45.49	74.00	54.00	-28.51	PASS		
	V	2483.50	72.50	-25.15	47.35	74.00	54.00	-26.65	PASS		
	V	2500.00	71.02	-25.10	45.92	74.00	54.00	-28.08	PASS		
	802.11 n40	Low Channel 2422MHz									
		H	2390.00	72.18	-25.43	46.75	74.00	54.00	-27.25	PASS	
H		2400.00	75.81	-25.40	50.41	74.00	54.00	-23.59	PASS		
V		2390.00	71.23	-25.43	45.80	74.00	54.00	-28.20	PASS		
V		2400.00	74.23	-25.40	48.83	74.00	54.00	-25.17	PASS		
High Channel 2452MHz											
H		2483.50	70.96	-25.15	45.81	74.00	54.00	-28.19	PASS		
H		2500.00	68.64	-25.10	43.54	74.00	54.00	-30.46	PASS		
V		2483.50	69.23	-25.15	44.08	74.00	54.00	-29.92	PASS		
V		2500.00	67.19	-25.10	42.09	74.00	54.00	-31.91	PASS		

Remark:

- Measurement = Reading Level + Correct Factor,
Correct Factor = Antenna Factor + Cable Loss – Pre-amplifier,
Over= Measurement - Limit
- If the PK measured levels comply with average limit, then the average level were deemed to comply with average limit.
- In restricted bands of operation, The spurious emissions below the permissible value more than 20dB
- The amplitude of spurious emissions which are attenuated by more than 20dB below the permissible value has no need to be reported.
- The worst case is MIMO mode.

Test mode	Polar (H/V)	Frequency (MHz)	Reading Level (dBuV/m)	Correct Factor (dB)	Measurement (dBuV/m)		Over		Result	
					PK	PK	AV	PK		
802.11 ax20	Low Channel 2412MHz									
	H	2390.00	72.21	-25.43	46.78	74.00	54.00	-27.22	PASS	
	H	2400.00	76.20	-25.40	50.80	74.00	54.00	-23.20	PASS	
	V	2390.00	71.55	-25.43	46.12	74.00	54.00	-27.88	PASS	
	V	2400.00	75.29	-25.40	49.89	74.00	54.00	-24.11	PASS	
	High Channel 2462MHz									
	H	2483.50	71.39	-25.15	46.24	74.00	54.00	-27.76	PASS	
	H	2500.00	69.80	-25.10	44.70	74.00	54.00	-29.30	PASS	
	V	2483.50	71.44	-25.15	46.29	74.00	54.00	-27.71	PASS	
	V	2500.00	69.70	-25.10	44.60	74.00	54.00	-29.40	PASS	
	802.11 ax40	Low Channel 2422MHz								
		H	2390.00	73.20	-25.43	47.77	74.00	54.00	-26.23	PASS
H		2400.00	76.76	-25.40	51.36	74.00	54.00	-22.64	PASS	
V		2390.00	72.43	-25.43	47.00	74.00	54.00	-27.00	PASS	
V		2400.00	76.32	-25.40	50.92	74.00	54.00	-23.08	PASS	
High Channel 2452MHz										
H		2483.50	72.16	-25.15	47.01	74.00	54.00	-26.99	PASS	
H		2500.00	71.20	-25.10	46.10	74.00	54.00	-27.90	PASS	
V		2483.50	72.48	-25.15	47.33	74.00	54.00	-26.67	PASS	
V		2500.00	71.09	-25.10	45.99	74.00	54.00	-28.01	PASS	

Remark:

1. Measurement = Reading Level + Correct Factor,
Correct Factor = Antenna Factor + Cable Loss – Pre-amplifier,
Over= Measurement - Limit
2. If the PK measured levels comply with average limit, then the average level were deemed to comply with average limit.
- 3 In restricted bands of operation, The spurious emissions below the permissible value more than 20dB
4. The amplitude of spurious emissions which are attenuated by more than 20dB below the permissible value has no need to be reported.
5. The worst case is MIMO mode.

9. Power Spectral Density Test

9.1 Block Diagram Of Test Setup



9.2 Limit

FCC Part15 (15.247) , Subpart C				
Section	Test Item	Limit	Frequency Range (MHz)	Result
15.247	Power Spectral Density	8 dBm (in any 3KHz)	2400-2483.5	PASS

Limits Of Radiated Emission Measurement (Above 1000MHz)

9.3 Test procedure

1. Set analyzer center frequency to DTS channel center frequency.
2. Set the span to 1.5 times the DTS bandwidth.
3. Set the RBW to: 3 kHz
4. Set the VBW $\geq 3 \times$ RBW.
5. Detector = peak.
6. Sweep time = auto couple.
7. Trace mode = max hold.
8. Allow trace to fully stabilize.
9. Use the peak marker function to determine the maximum amplitude level within the RBW.
10. If measured value exceeds limit, reduce RBW (no less than 3 kHz) and repeat.

9.4 EUT Operating Conditions

The EUT tested system was configured as the statements of 4.6 Unless otherwise a special operating condition is specified in the follows during the testing.

Note: Power Spectral Density(dBm)=Reading+Cable Loss

9.5 Test Result

Temperature:	26 °C	Relative Humidity:	54%
Pressure:	101KPa	Test Voltage:	AC120V/60Hz

Test Mode	Fre- quency (MHz)	Ant. A Conducted PSD (dBm/3kHz)	Ant. B Conducted PSD (dBm/3kHz)	Total PSD (dBm/3KHz)	Limit (dBm/3kHz)
b	2412	-13.46	-13.03	/	8
b	2437	-13.69	-13.36	/	8
b	2462	-13.74	-13.62	/	8
g	2412	-19.68	-19.11	/	8
g	2437	-20.14	-19.33	/	8
g	2462	-19.9	-19.29	/	8
n20	2412	-18.6	-20.44	-16.41	7.09
n20	2437	-19.36	-20.15	-16.73	7.09
n20	2462	-19.14	-20.34	-16.69	7.09
n40	2422	-22.13	-21.57	-18.83	7.09
n40	2437	-20.88	-22.66	-18.67	7.09
n40	2452	-22	-22.43	-19.20	7.09
ax20	2412	-20.95	-21.16	-18.04	7.09
ax20	2437	-21.45	-21.27	-18.35	7.09
ax20	2462	-21.23	-21.64	-18.42	7.09
ax40	2422	-24.75	-24.9	-21.81	7.09
ax40	2437	-25.1	-25.27	-22.17	7.09
ax40	2452	-25.24	-25.53	-22.37	7.09

Note:

Antenna A gain: 3.9 dBi, Antenna B gain: 3.9 dBi, Directional gain=[GainANT + 10 log(NANT/NSS) dBi]
 =6.91 dBi>6dbi

Limit=8-(6.91-6)=7.09 dbi

Note: A(B) Represent the value of antenna A and B, The worst data is Antenna B, only shown Antenna B Plot.



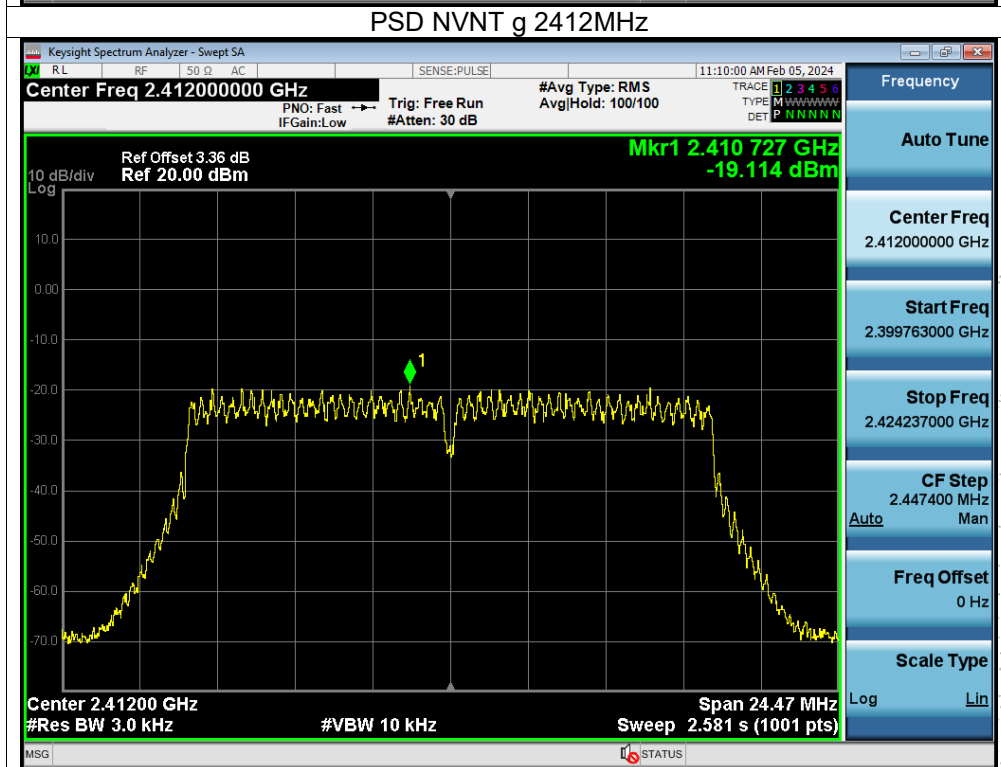
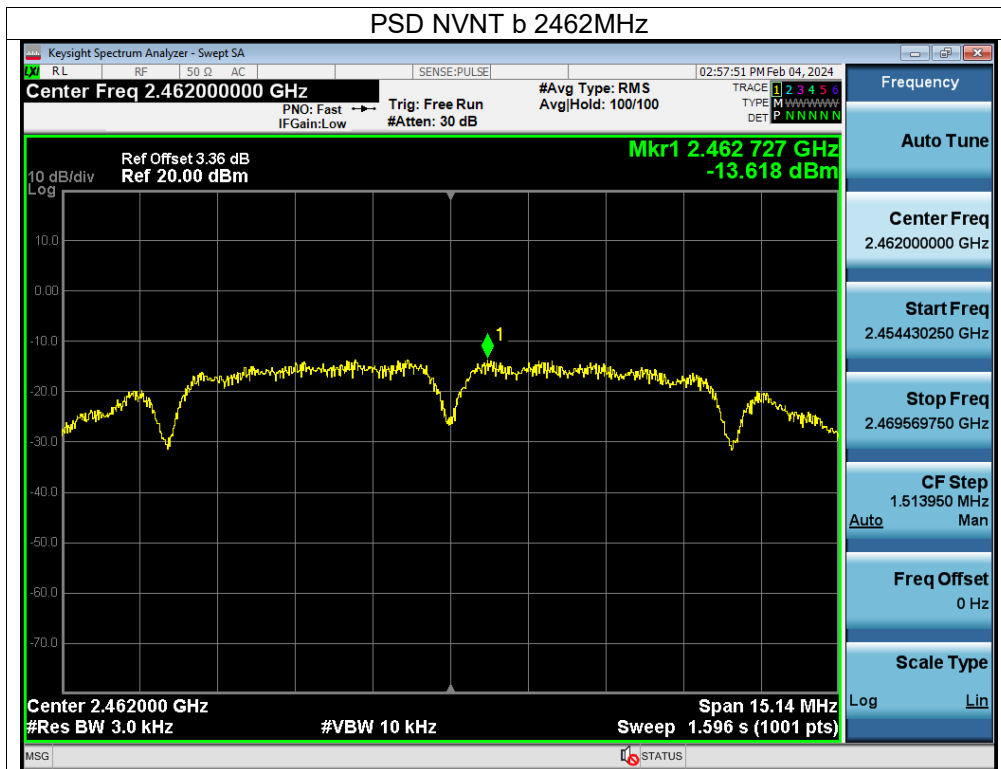

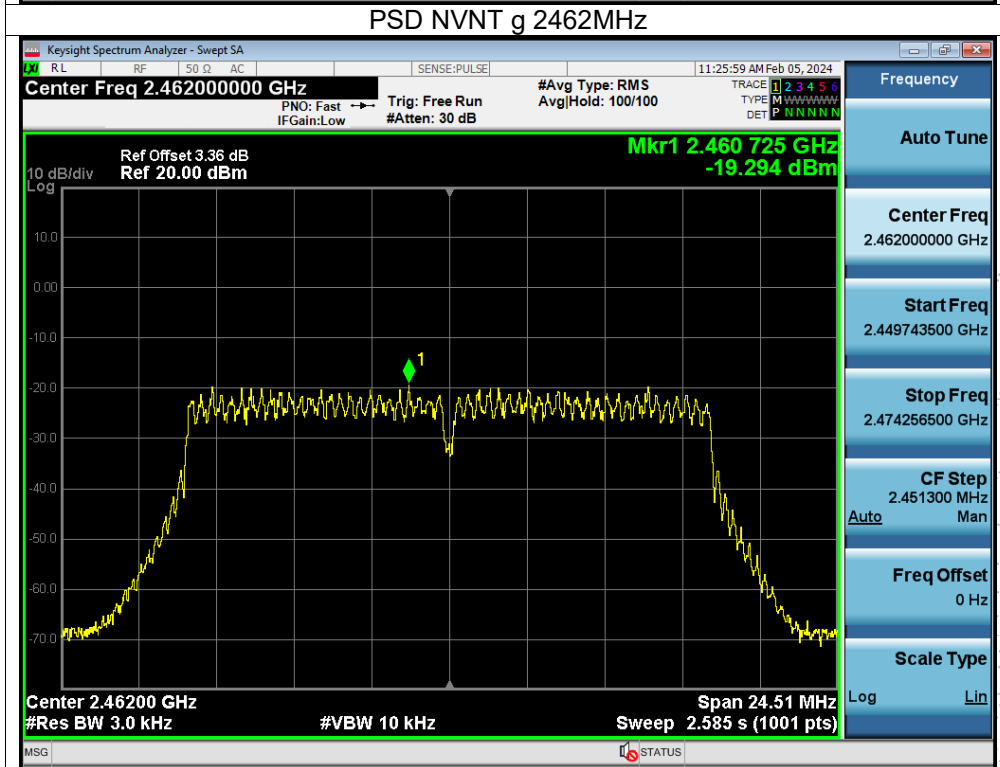
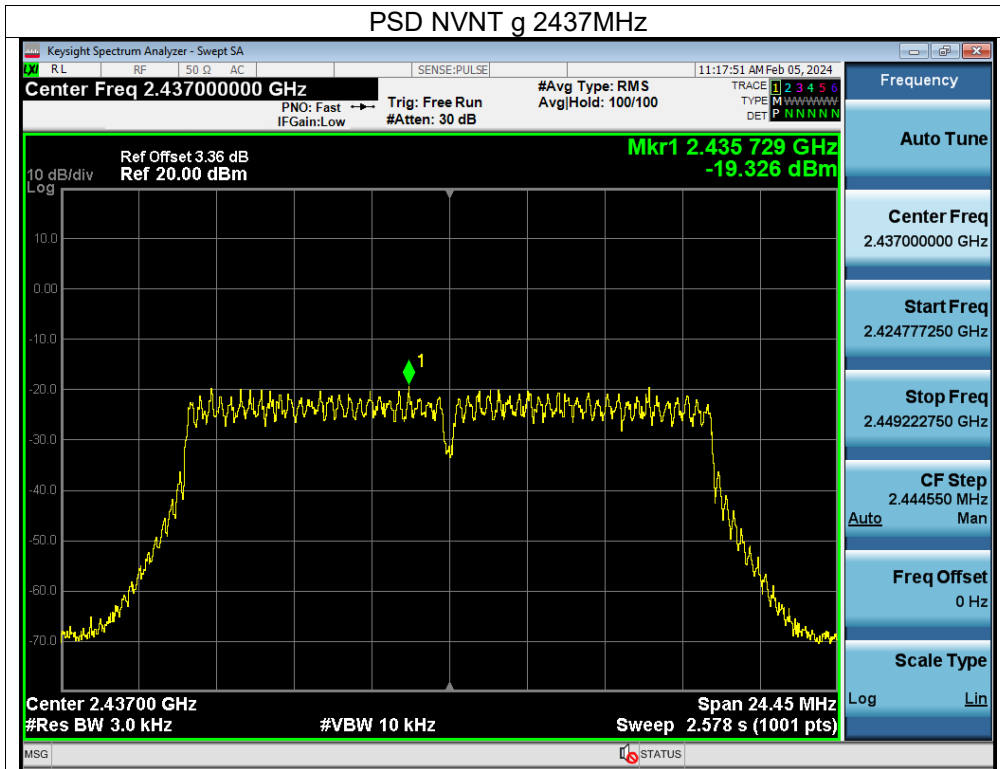

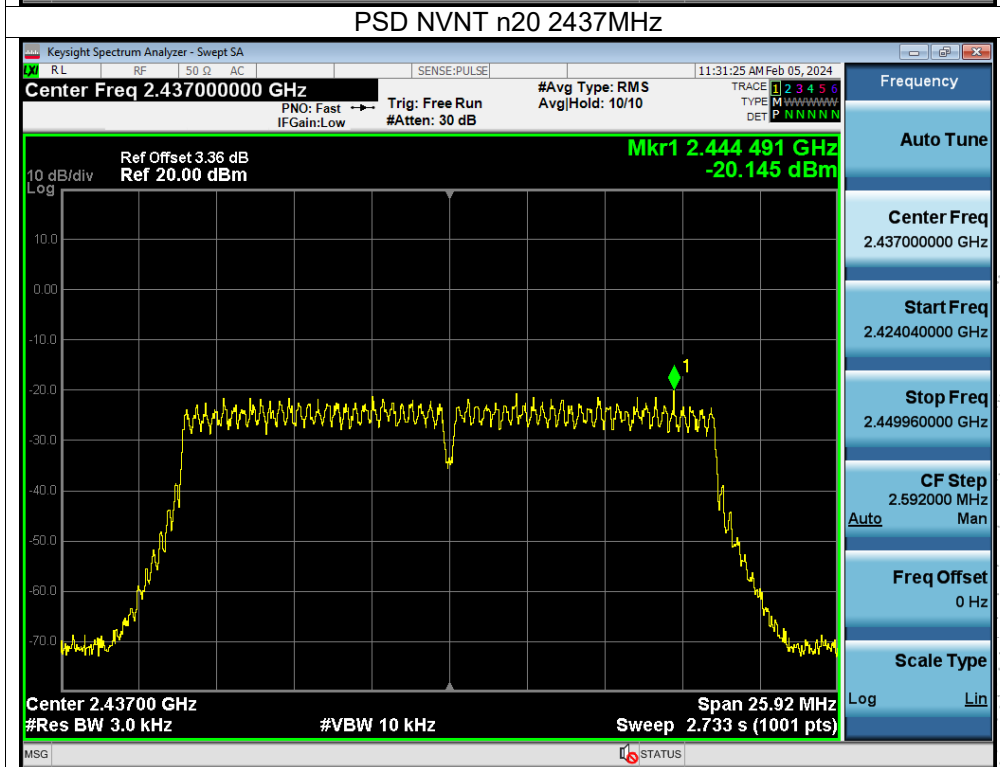
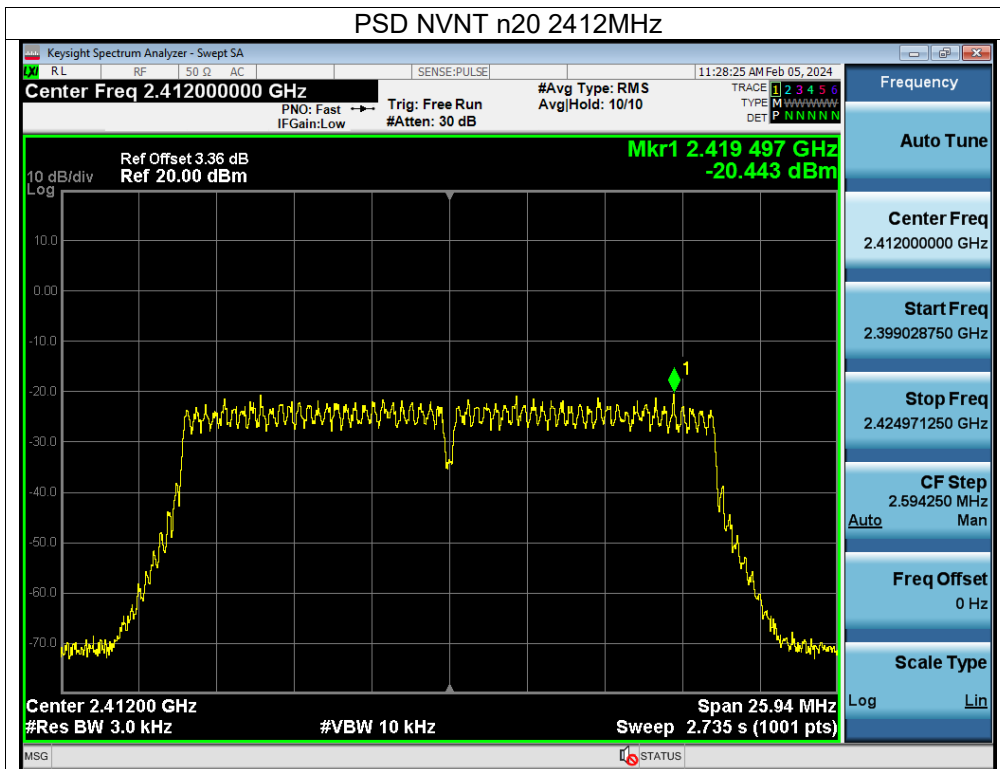

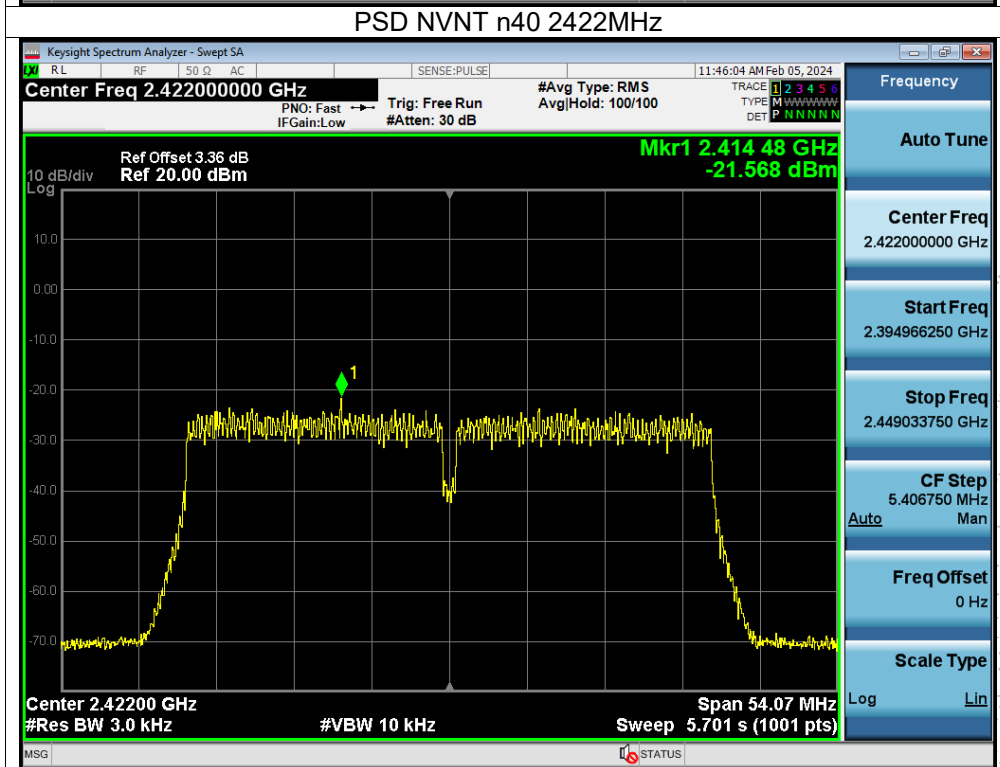
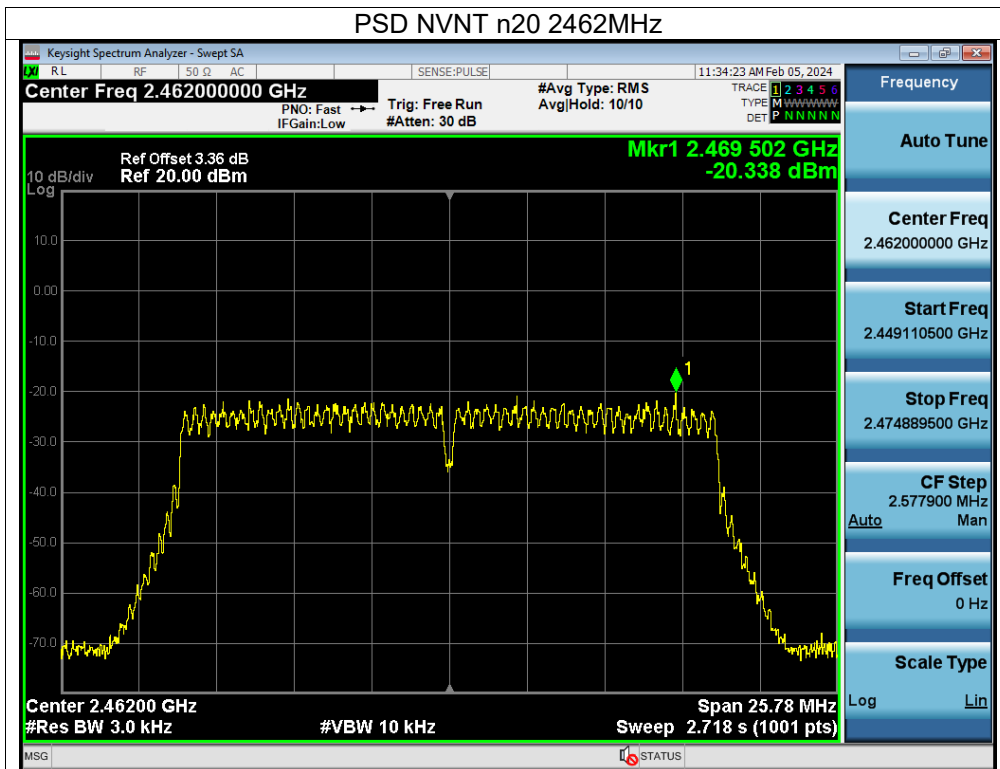

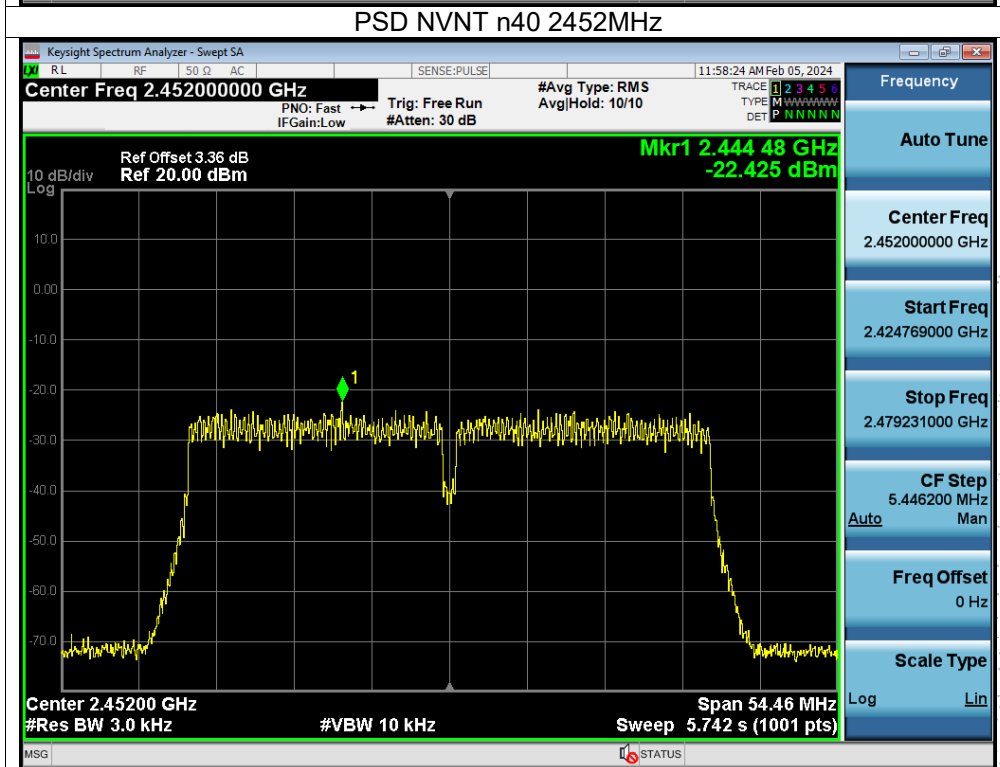
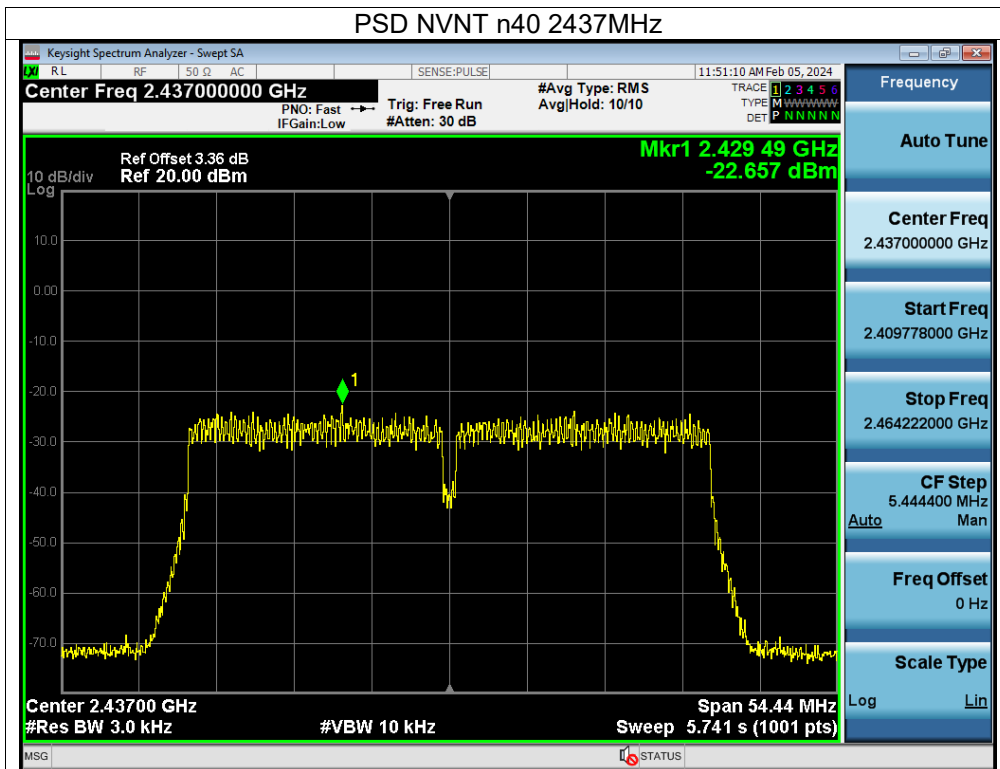

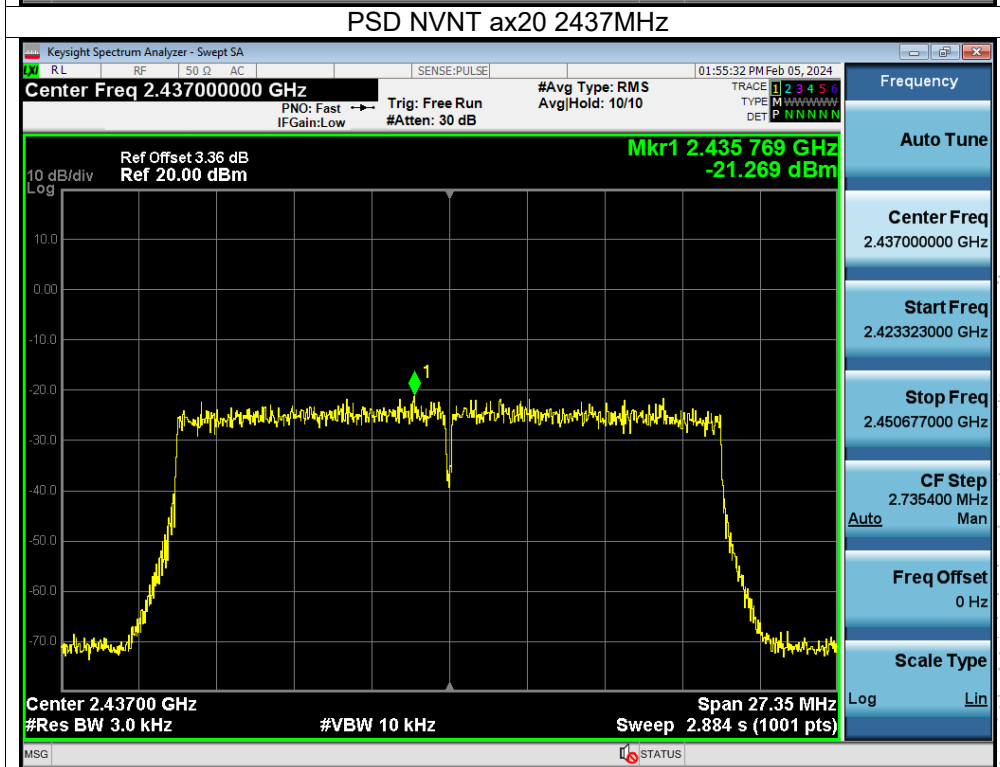
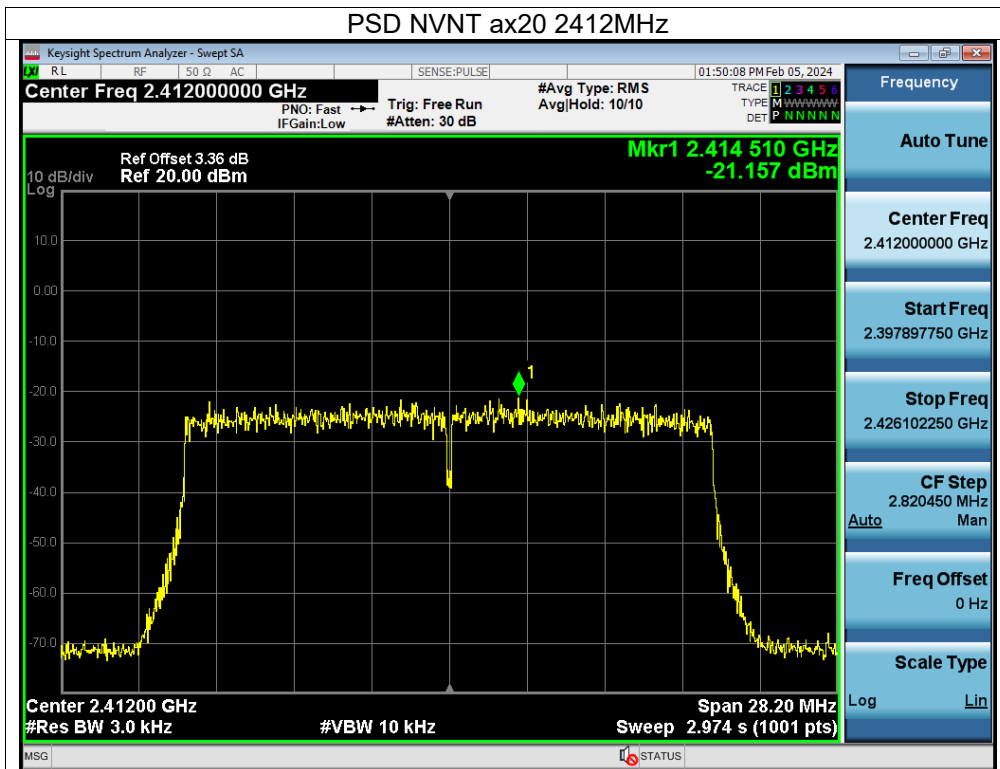

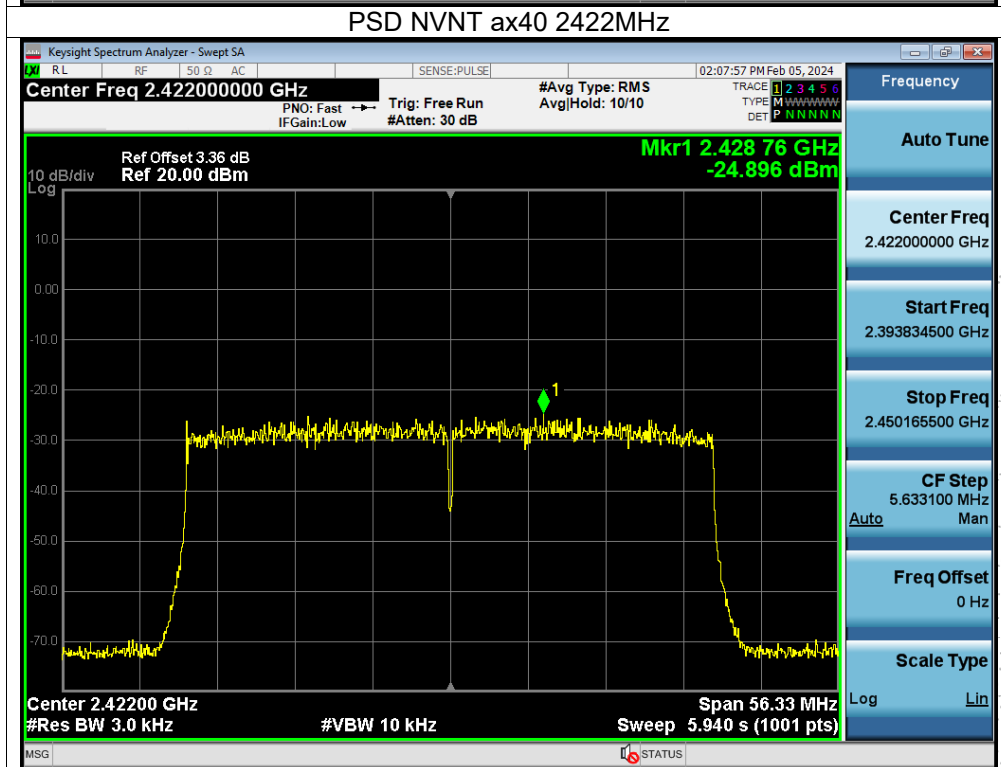
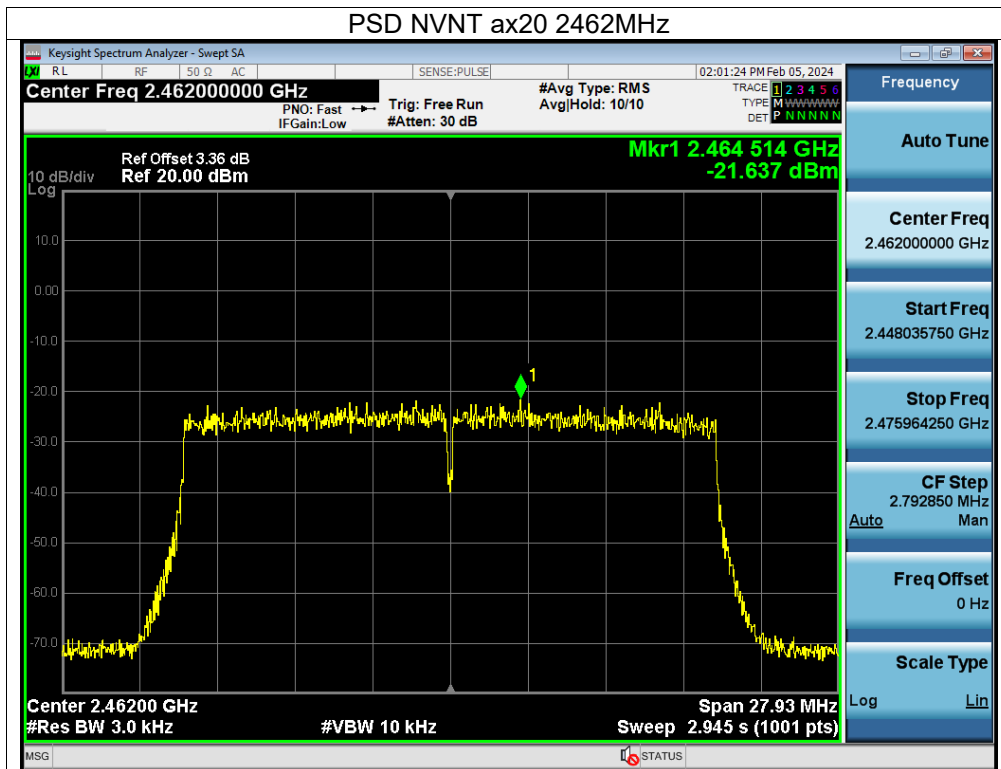

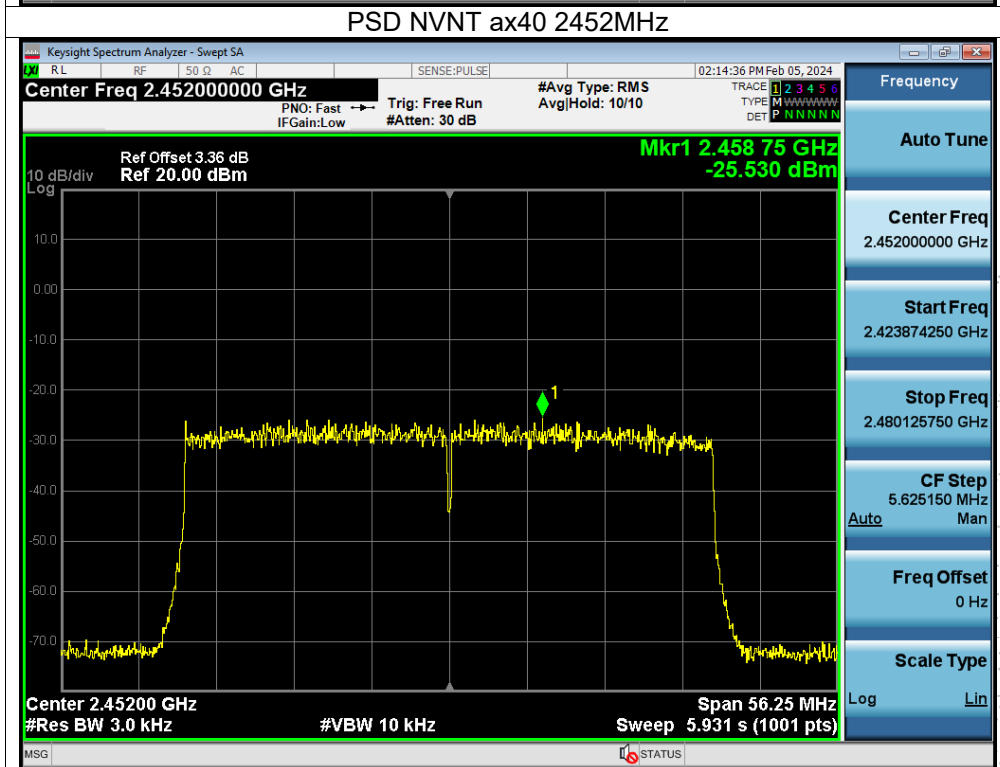
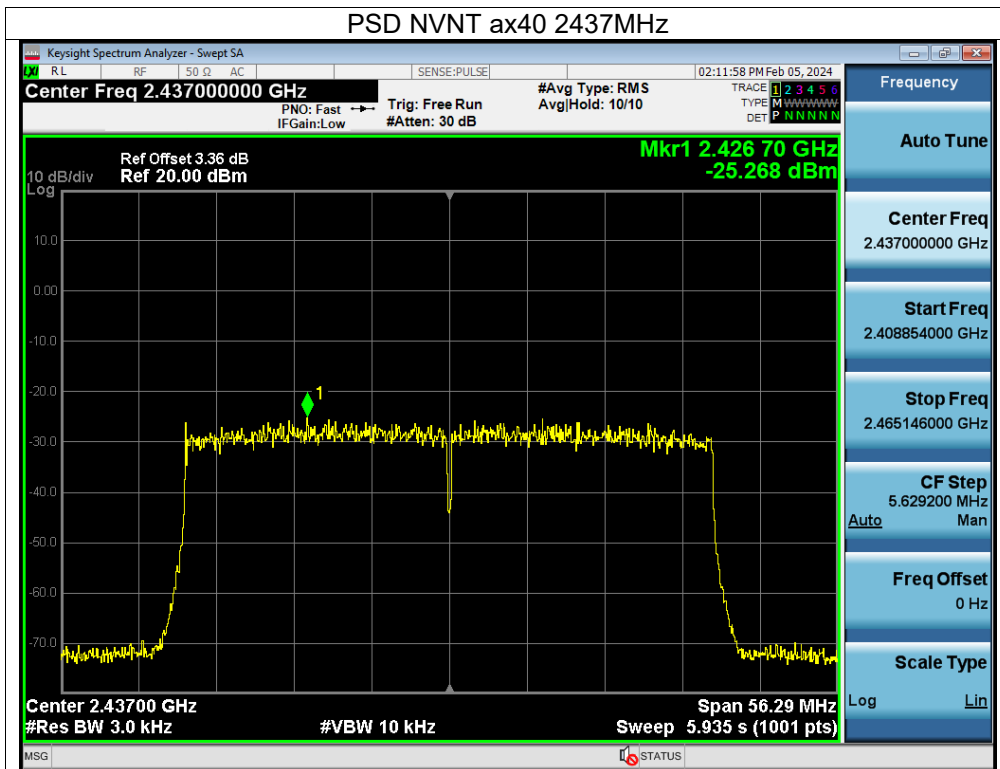

10. Bandwidth Test

10.1 Block Diagram Of Test Setup

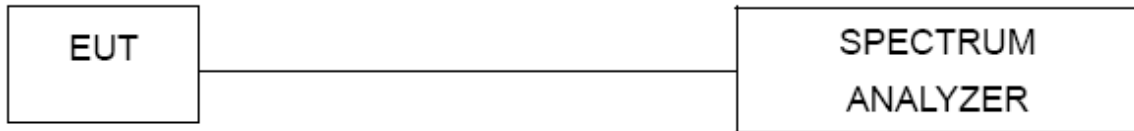

10.2 Limit

FCC Part15 (15.247) , Subpart C				
Section	Test Item	Limit	Frequency Range (MHz)	Result
15.247(a)(2)	Bandwidth	$\geq 500\text{KHz}$ (-6dB bandwidth)	2400-2483.5	PASS

10.3 Test procedure

1. Set RBW = 100 kHz.
2. Set the video bandwidth (VBW) $\geq 3 \times$ RBW.
3. Detector = Peak.
4. Trace mode = max hold.
5. Sweep = auto couple.
6. Allow the trace to stabilize.
7. Measure the maximum width of the emission that is constrained by the frequencies associated with the two outermost amplitude points (upper and lower frequencies) that are attenuated by 6 dB relative to the maximum level measured in the fundamental emission.

10.4 EUT Operating Conditions

The EUT tested system was configured as the statements of 4.6 Unless otherwise a special operating condition is specified in the follows during the testing.

Note: Power Spectral Density(dBm)=Reading+Cable Loss

10.5 Test Result

Temperature:	26 °C	Relative Humidity:	54%
Pressure:	101KPa	Test Voltage :	AC120V/60Hz

Test Mode	Frequency (MHz)	Ant. A -6dB bandwidth (MHz)	Ant. B -6dB bandwidth (MHz)	-6dB bandwidth Limit (kHz)	Result
b	2412	10.126	11.072	500	Pass
b	2437	11.083	11.059	500	Pass
b	2462	11.054	10.093	500	Pass
g	2412	16.342	16.316	500	Pass
g	2437	16.313	16.297	500	Pass
g	2462	16.327	16.342	500	Pass
n20	2412	17.529	17.295	500	Pass
n20	2437	17.522	17.28	500	Pass
n20	2462	16.668	17.186	500	Pass
n40	2422	36.308	36.045	500	Pass
n40	2437	36.326	36.296	500	Pass
n40	2452	36.279	36.308	500	Pass
ax20	2412	18.317	18.803	500	Pass
ax20	2437	18.81	18.236	500	Pass
ax20	2462	18.506	18.619	500	Pass
ax40	2422	37.511	37.554	500	Pass
ax40	2437	37.527	37.528	500	Pass
ax40	2452	37.951	37.501	500	Pass

Note: A(B) Represent the value of antenna A and B, The worst data is Antenna A, only shown Antenna A Plot.



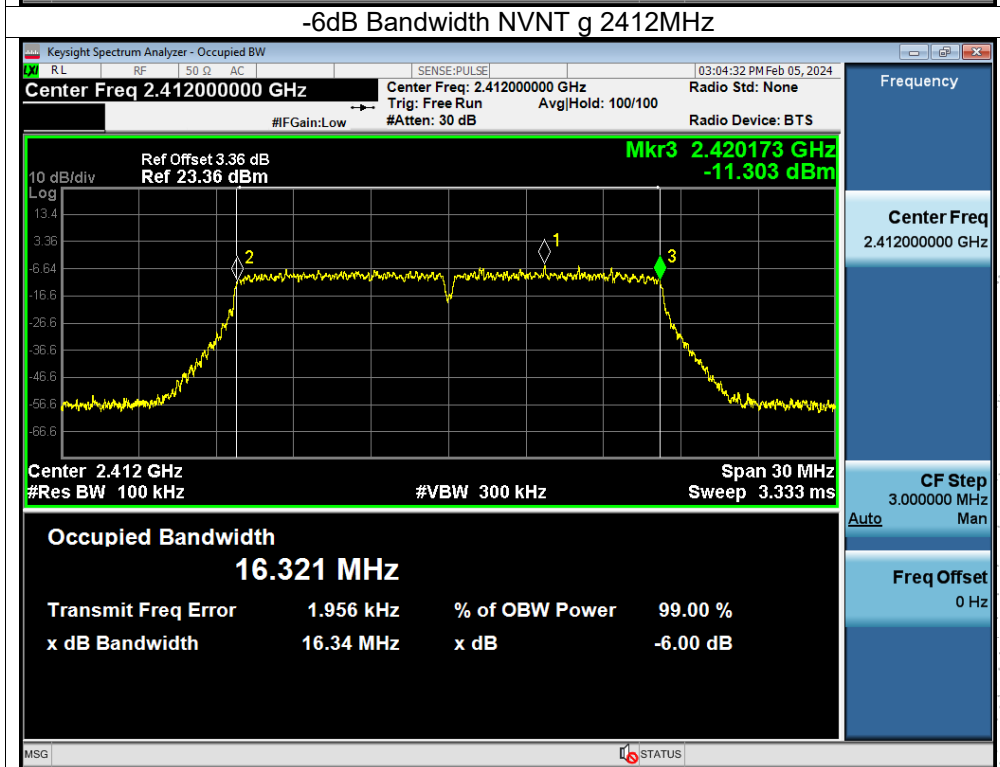
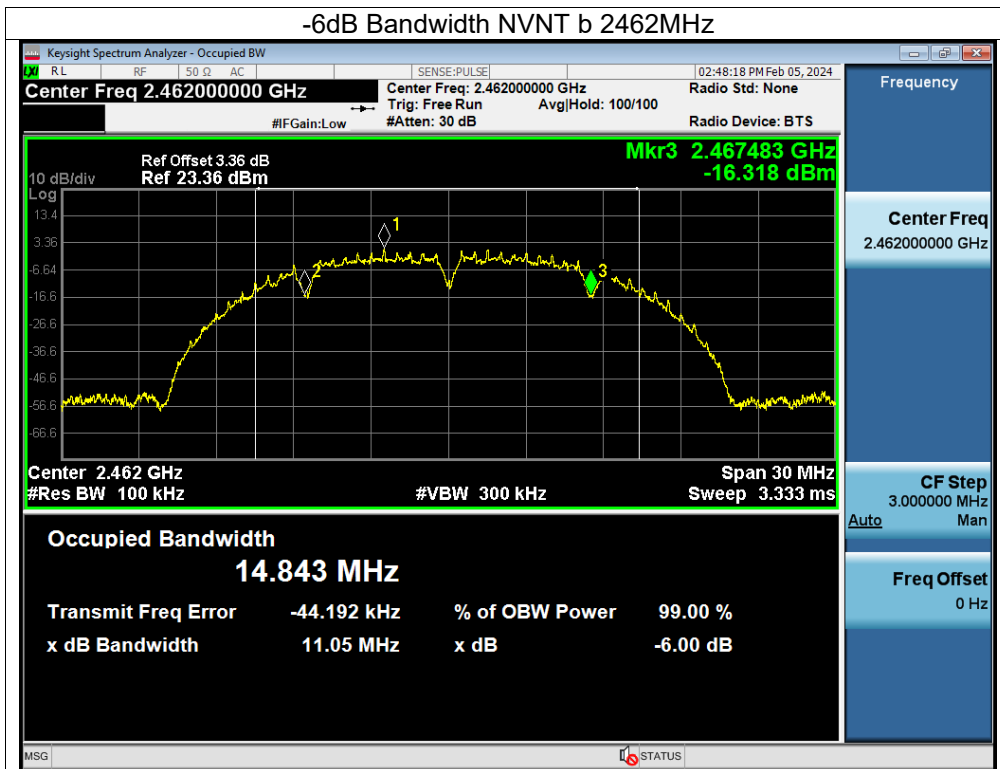

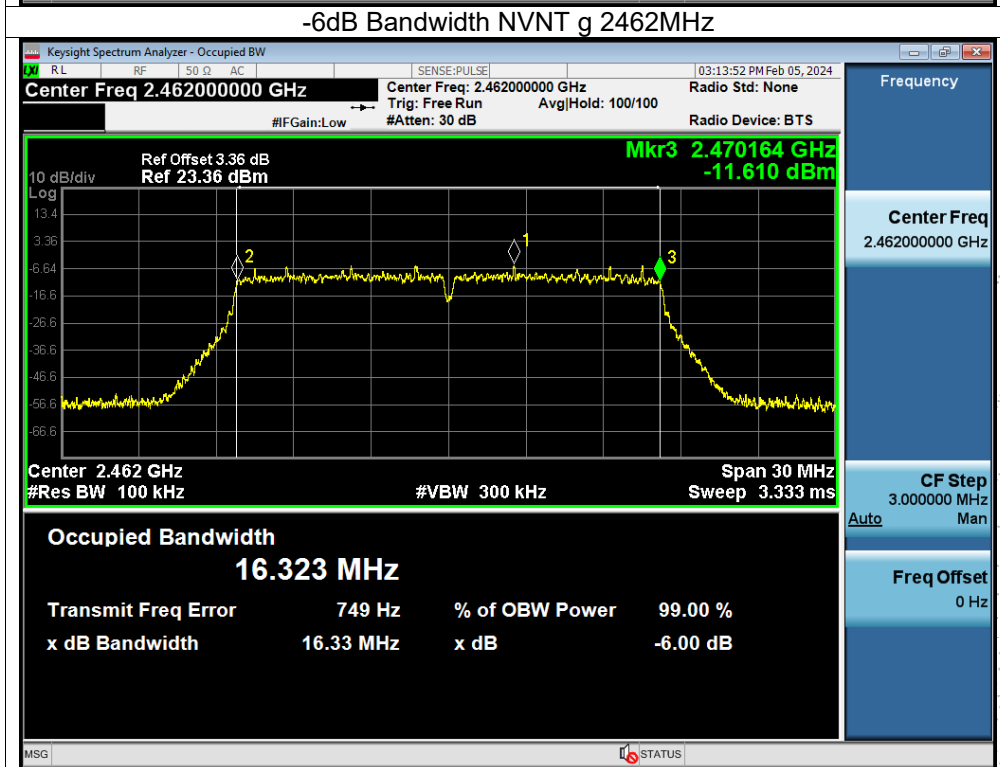
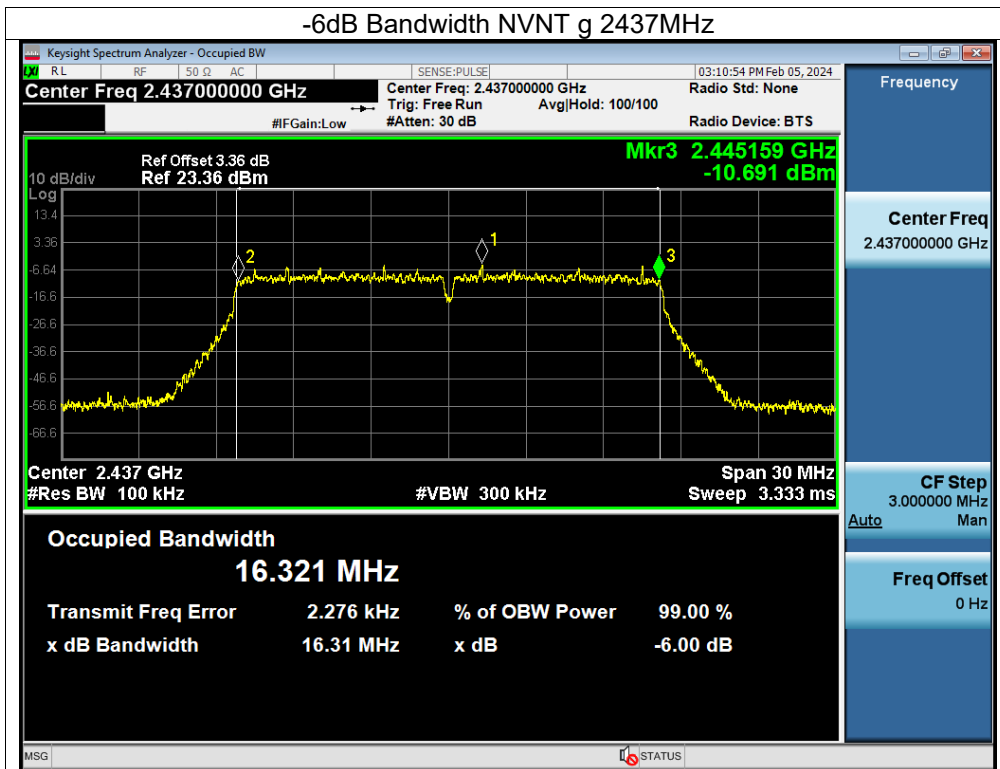

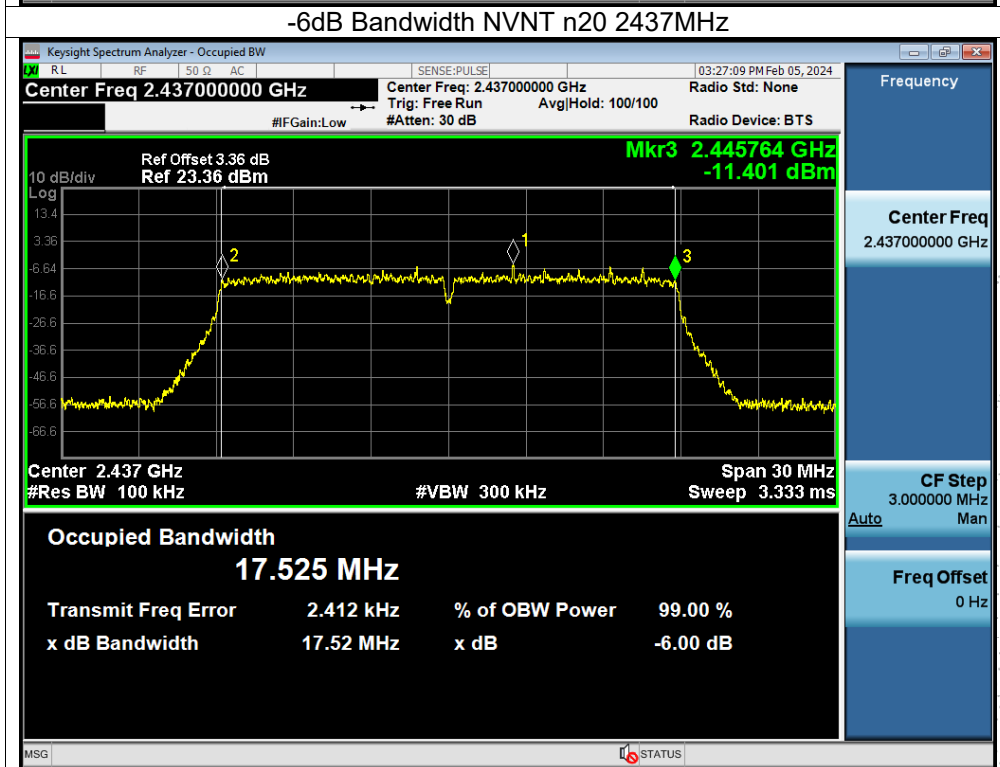
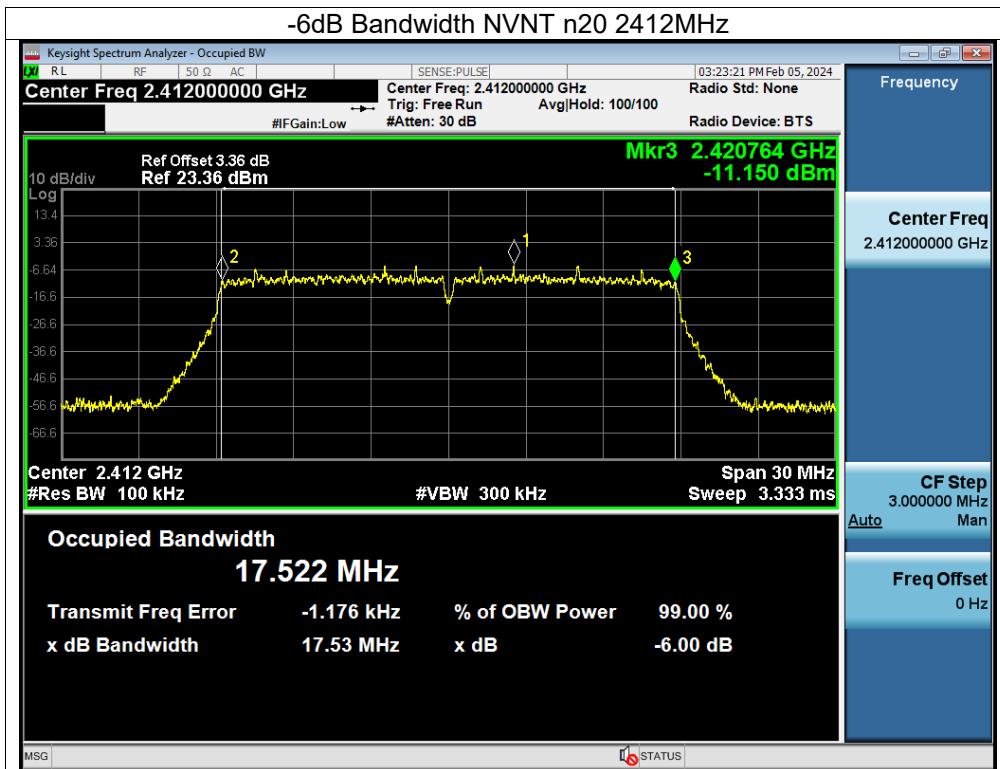

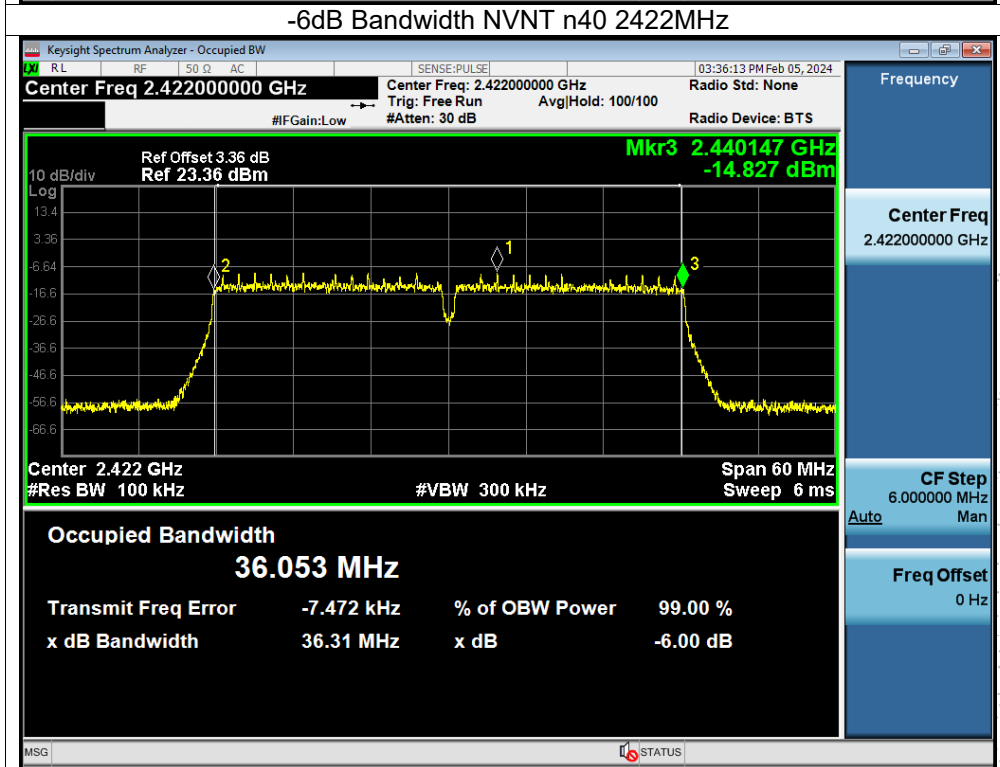
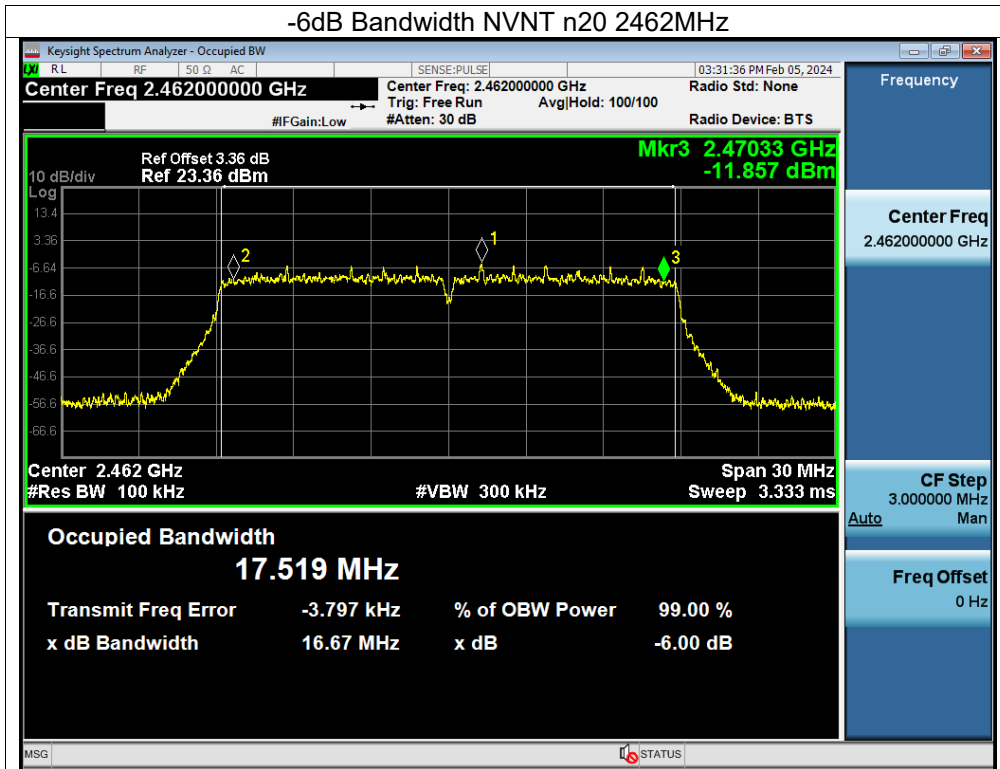

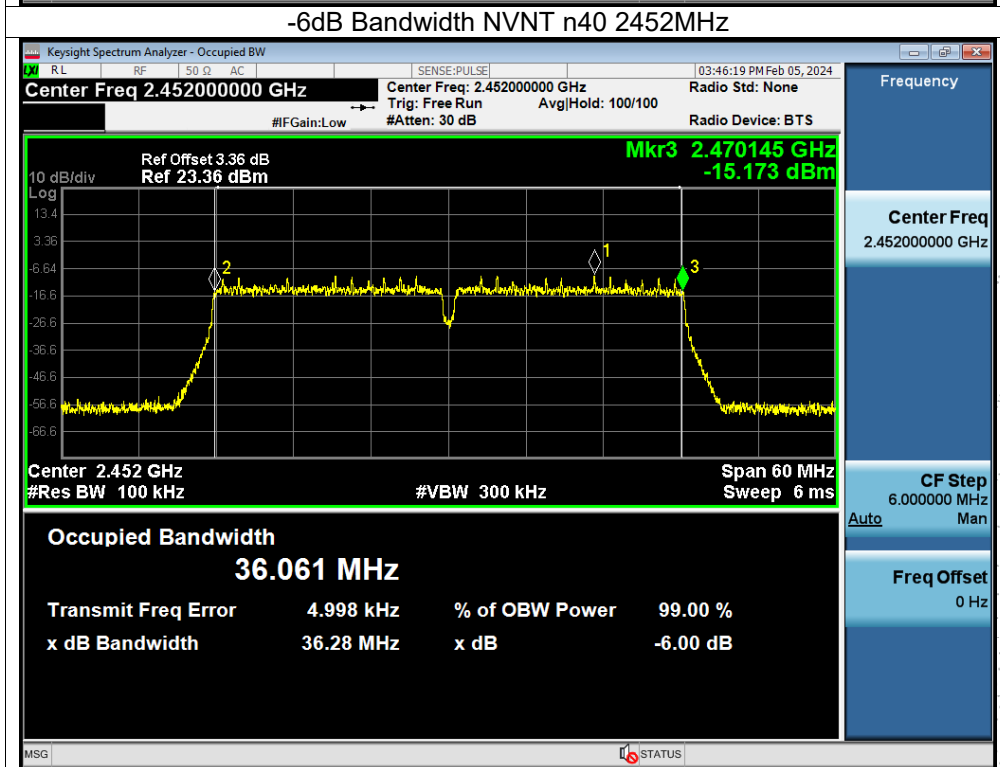
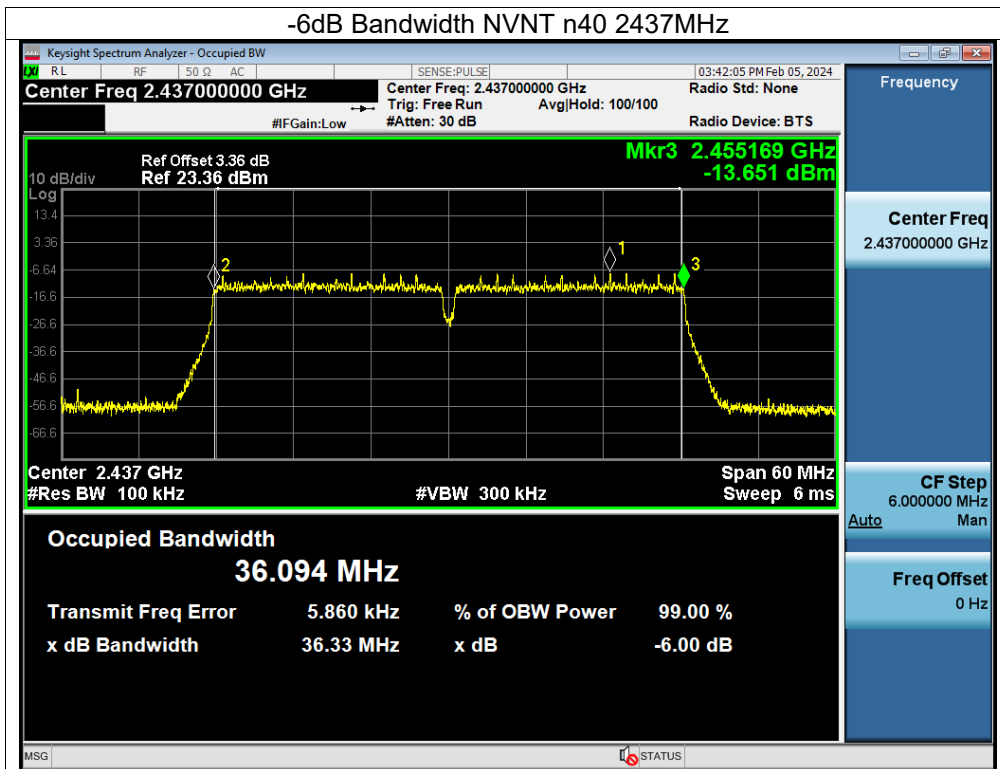

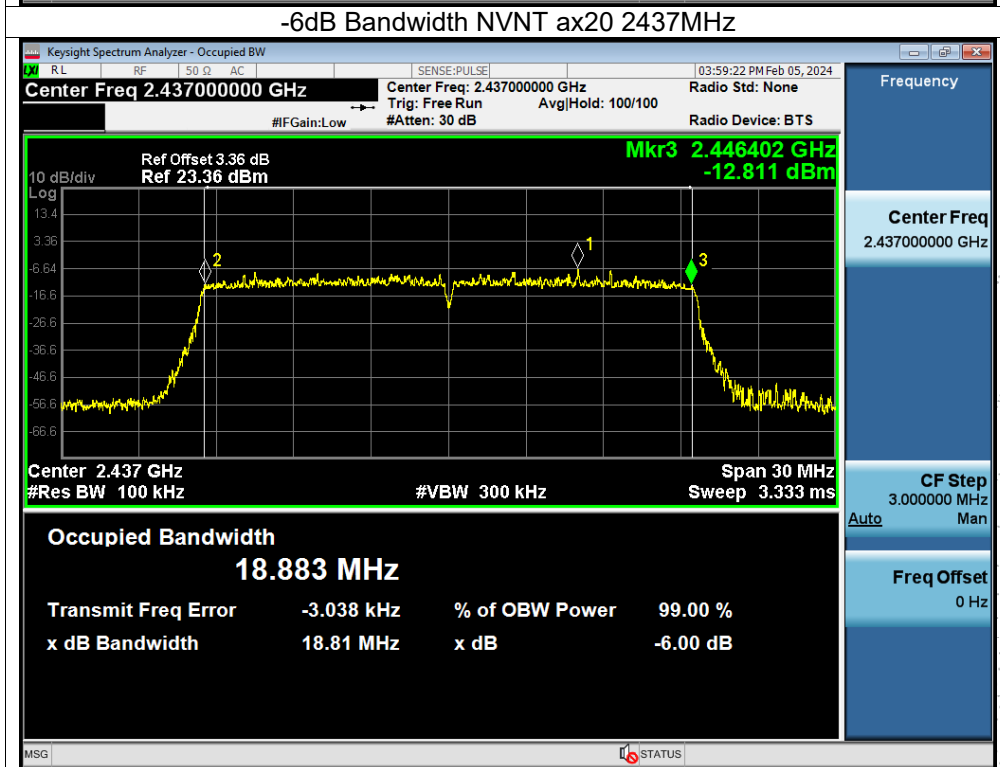
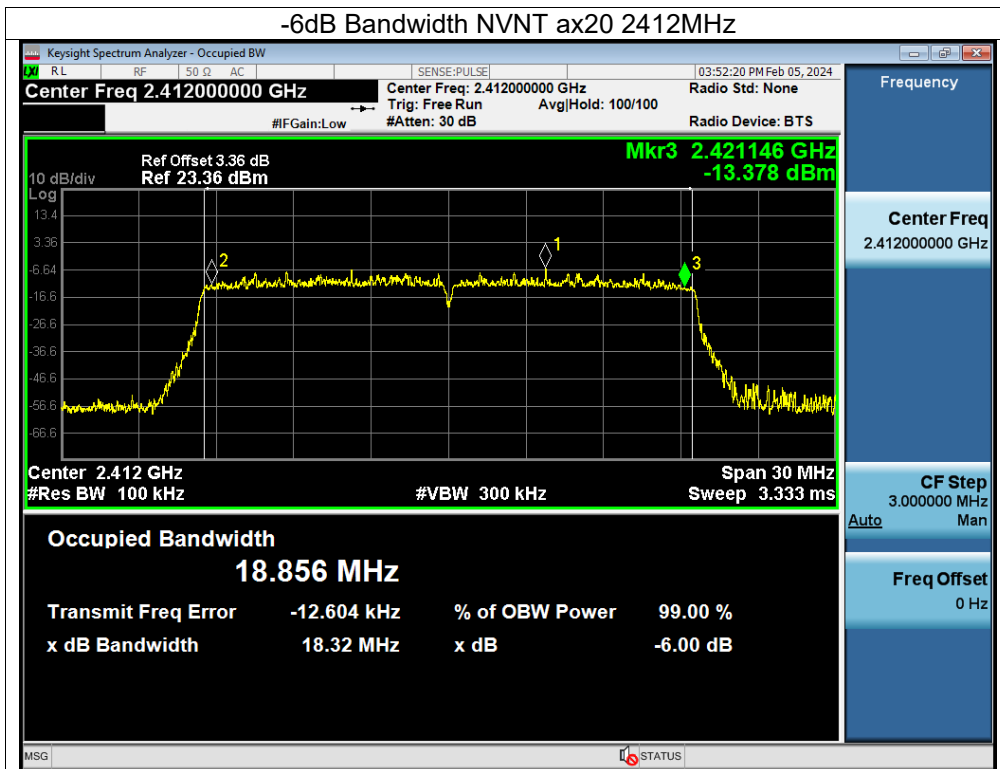

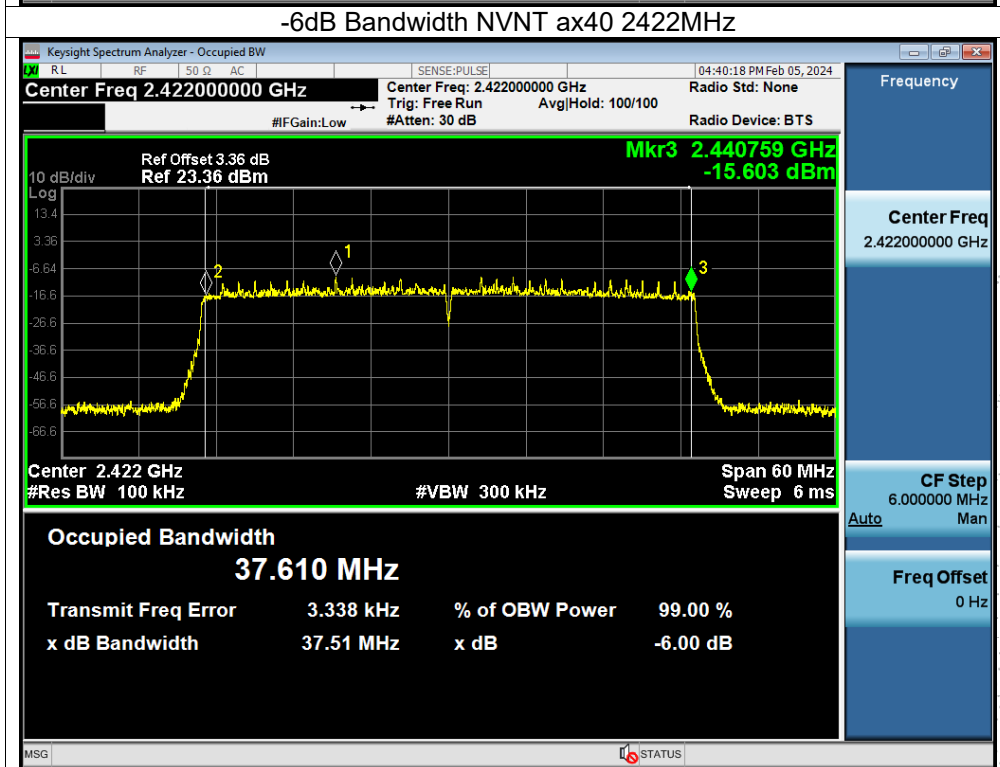
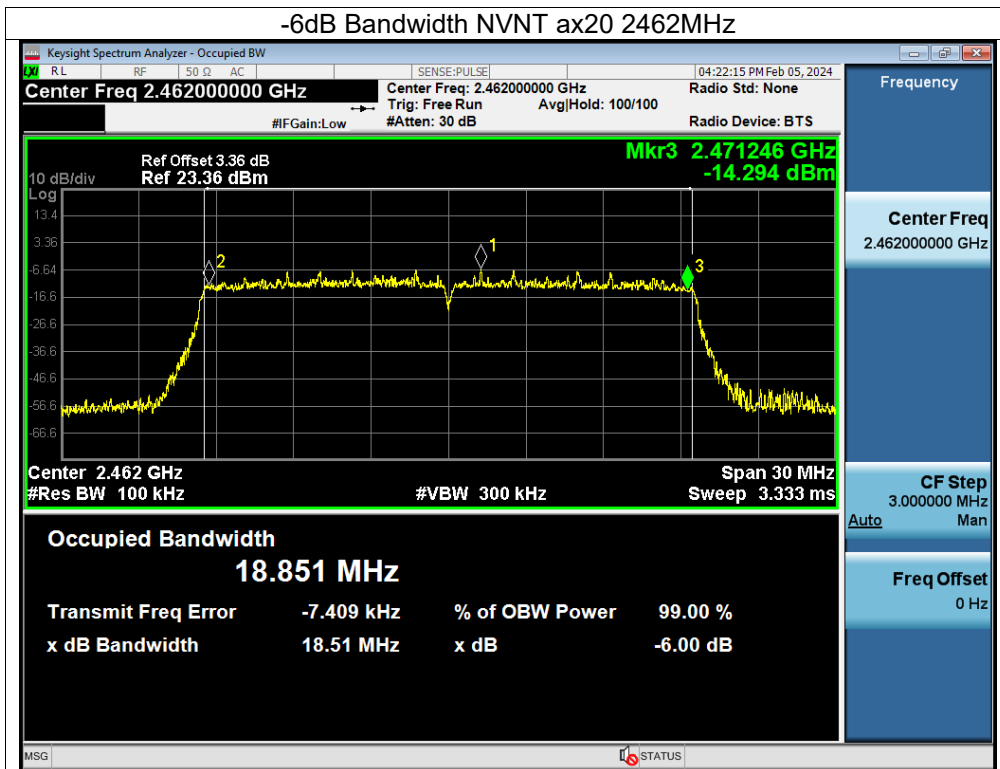

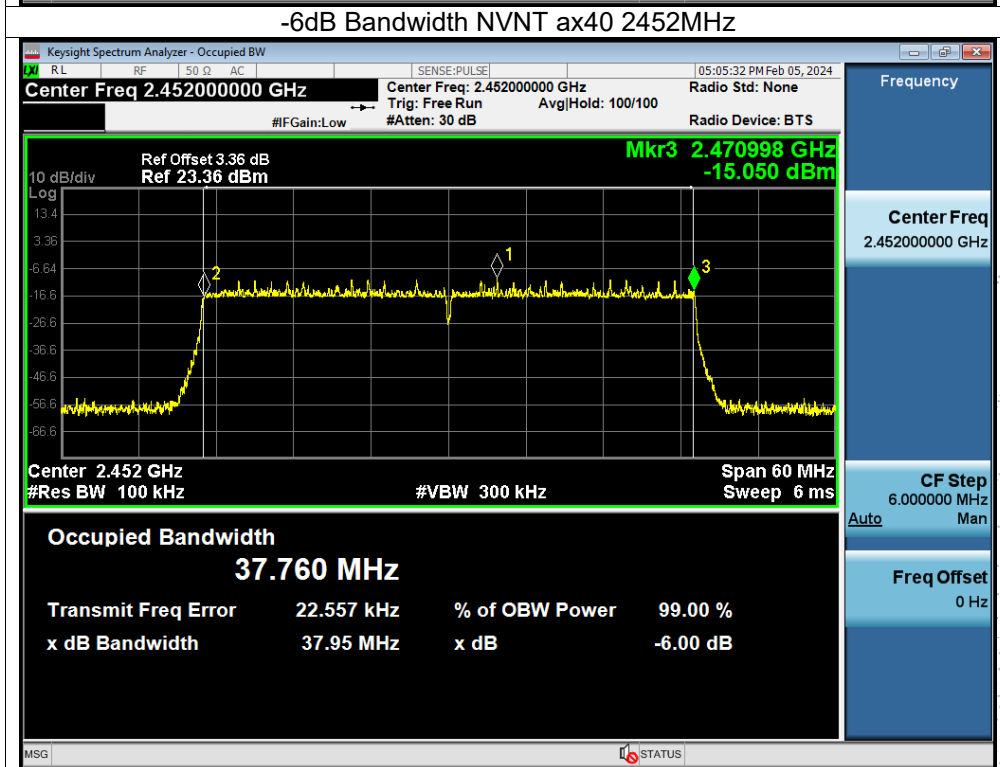
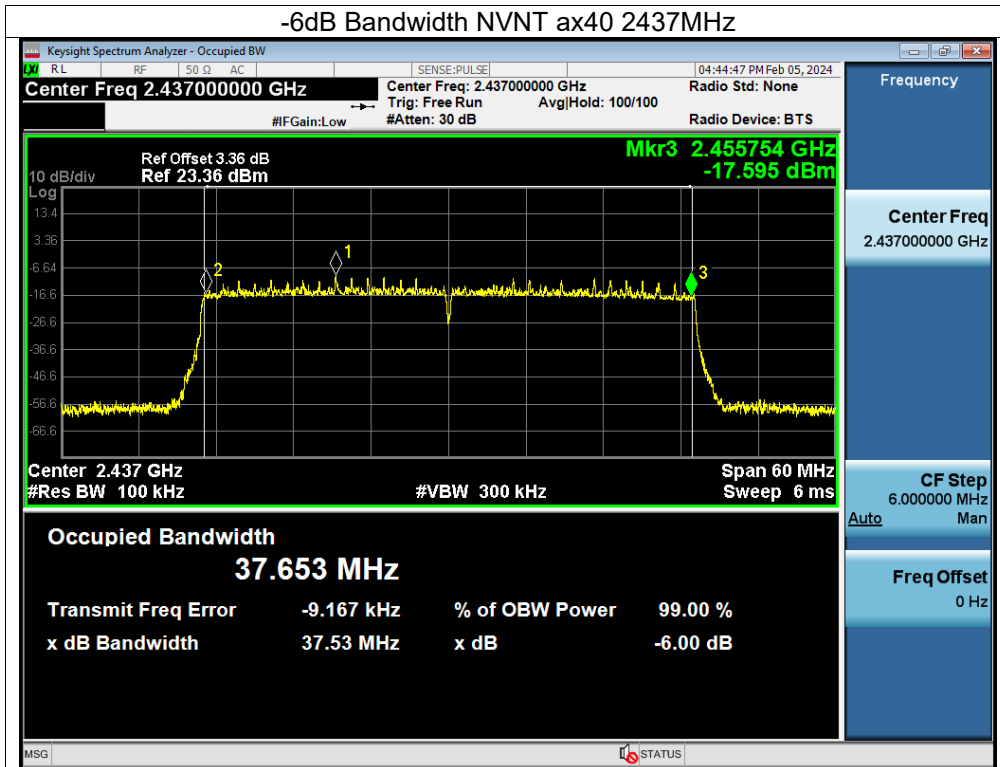

11. Peak Output Power Test

11.1 Block Diagram Of Test Setup

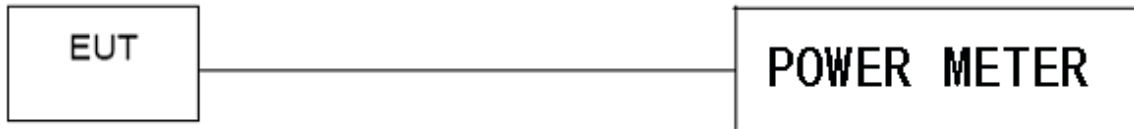

11.2 Limit

FCC Part15 (15.247) , Subpart C				
Section	Test Item	Limit	Frequency Range (MHz)	Result
15.247(b)(3)	Peak Output Power	1 watt or 30dBm	2400-2483.5	PASS

11.3 Test Procedure

- a. The EUT was directly connected to the Power meter

11.4 EUT Operating Conditions

The EUT tested system was configured as the statements of 4.6 Unless otherwise a special operating condition is specified in the follows during the testing.

Note: Power Spectral Density(dBm)=Reading+Cable Loss

11.5 Test Result

Temperature:	26 °C	Relative Humidity:	54%
Pressure:	101KPa	Test Voltage:	AC120V/60Hz

Test Mode	Frequency (MHz)	Ant A Conducted Power (dBm)	Ant B Conducted Power (dBm)	Total Power (dBm)	Limit (dBm)
b	2412	12.23	12.86	/	30
b	2437	12.23	12.23	/	30
b	2462	12.06	12.45	/	30
g	2412	11.48	11.81	/	30
g	2437	11.25	11.63	/	30
g	2462	11.08	11.69	/	30
n20	2412	10.99	10.95	13.98	30
n20	2437	10.65	10.61	13.64	30
n20	2462	10.46	10.24	13.36	30
n40	2422	9.98	9.88	12.94	30
n40	2437	9.69	9.56	12.64	30
n40	2452	9.57	9.59	12.59	30
ax20	2412	10.92	10.84	13.89	30
ax20	2437	10.51	10.57	13.55	30
ax20	2462	10.42	10.02	13.23	30
ax40	2422	9.82	9.89	12.87	30
ax40	2437	9.57	9.66	12.63	30
ax40	2452	9.58	9.34	12.47	30

Note:

The Array gain=0 for $NANT \leq 4$,

So the directional gain for Power measurements is 3.9 dBi

12. 100 kHz Bandwidth Of Frequency Band Edge

12.1 Block Diagram Of Test Setup



12.2 Limit

In any 100 kHz bandwidth outside the frequency band in which the spread spectrum intentional radiator is operating, the radio frequency power that is produced by the intentional radiator shall be at least 20 dB below that in the 100 kHz bandwidth within the band that contains the highest level of the desired power, based on either an RF conducted or a radiated measurement.

12.3 Test Procedure

Using the following spectrum analyzer setting:

- Set the RBW = 100KHz.
- Set the VBW = 300KHz.
- Sweep time = auto couple.
- Detector function = peak.
- Trace mode = max hold.
- Allow trace to fully stabilize..

12.4 EUT Operating Conditions

The EUT tested system was configured as the statements of 4.6 Unless otherwise a special operating condition is specified in the follows during the testing.

Note: Power Spectral Density(dBm)=Reading+Cable Loss

12.5 Test Result

Temperature:	26 °C	Relative Humidity:	54%
Pressure:	101KPa	Test Voltage:	AC120V/60Hz

Note: A(B) Represent the value of antenna A and B, The worst data is Antenna A, only shown Antenna A Plot.

