

TEST REPORT

Report No.: BCTC2401848209-2E

Applicant: REOLINK INNOVATION LIMITED

Product Name: WiFi IP Camera

Test Model: RLC-823S1W

Tested Date: 2024-01-09 to 2024-01-29

Issued Date: 2024-01-30

Shenzhen BCTC Testing Co., Ltd.



FCC ID: 2AYHE-2310C

Product Name: WiFi IP Camera

Trademark: 

Model/Type reference: RLC-823S1W
W840

Prepared For: REOLINK INNOVATION LIMITED

Address: FLAT/RM 705 7/F FA YUEN COMMERCIAL BUILDING 75-77 FA YUEN STREET MONG KOK KL HONG KONG

Manufacturer: REOLINK INNOVATION LIMITED

Address: FLAT/RM 705 7/F FA YUEN COMMERCIAL BUILDING 75-77 FA YUEN STREET MONG KOK KL HONG KONG

Factory: Shenzhen Reolink Technology Co., Ltd.

Address: 2-4th Floor, Building 2, YuanLing Industrial Park, ShangWu, Shiyan Street, Bao'an District, Shenzhen, China

Prepared By: Shenzhen BCTC Testing Co., Ltd.

Address: 1-2/F., Building B, Pengzhou Industrial Park, No.158, Fuyuan 1st Road, Zhancheng, Fuhai Subdistrict, Bao'an District, Shenzhen, Guangdong, China

Sample Received Date: 2024-01-09

Sample tested Date: 2024-01-09 to 2024-01-29

Issue Date: 2024-01-30

Report No.: BCTC2401848209-2E

Test Standards: FCC Part15 15.407
ANSI C63.10-2013
KDB 662911 D01 v02r01
KDB 789033 D02 v02r01

Test Results: PASS

Tested by:

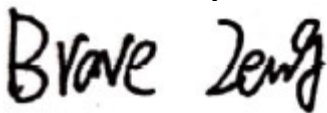

Brave Zeng/ Project Handler

Approved by:



Zero Zhou/Reviewer

The test report is effective only with both signature and specialized stamp. This result(s) shown in this report refer only to the sample(s) tested. Without written approval of Shenzhen BCTC Testing Co., Ltd, this report can't be reproduced except in full. The tested sample(s) and the sample information are provided by the client.

Table Of Content

	Page
Test Report Declaration	
1. Version	5
2. Test Summary	6
3. Measurement Uncertainty	7
4. Product Information And Test Setup	8
4.1 Product Information.....	8
4.2 Test Setup Configuration	9
4.3 Support Equipment	9
4.4 Channel List	10
4.5 Test Mode	11
4.6 Table Of Parameters Of Text Software Setting.....	11
4.7 Antenna.....	11
5. Test Facility And Test Instrument Used.....	12
5.1 Test Facility.....	12
5.2 Test Instrument Used.....	12
6. Conducted Emissions.....	14
6.1 Block Diagram Of Test Setup.....	14
6.2 Limit	14
6.3 Test Procedure	14
6.4 EUT Operating Conditions	14
6.5 Test Result.....	15
7. Radiated Emissions.....	17
7.1 Block Diagram Of Test Setup.....	17
7.2 Limit	18
7.3 Test Procedure	19
7.4 EUT Operating Conditions	20
7.5 Test Result.....	20
8. Power Spectral Density Test	59
8.1 Block Diagram Of Test Setup.....	59
8.2 Limit	59
8.3 Test Procedure	60
8.4 EUT Operating Conditions	60
8.5 Test Result.....	61
9. 26dB & 6dB & 99% Emission Bandwidth	107
9.1 Block Diagram Of Test Setup.....	107
9.2 Limit	107
9.3 Test Procedure	107
9.4 EUT Operating Conditions	108
9.5 Test Result.....	109
10. Maximum Conducted Output Power.....	197
10.1 Block Diagram Of Test Setup.....	197
10.2 Limit	197
10.3 Test Procedure	197
10.4 EUT Operating Conditions	198

10.5	Test Result.....	199
11.	Out Of Band Emissions	203
11.1	Block Diagram Of Test Setup.....	203
11.2	Limit	203
11.3	Test Procedure	203
11.4	EUT Operating Conditions	203
11.5	Test Result.....	204
12.	Spurious RF Conducted Emissions.....	239
12.1	Block Diagram Of Test Setup.....	239
12.2	Limit	239
12.3	Test Procedure	239
12.4	Test Result.....	239
13.	Frequency Stability Measurement	282
13.1	Block Diagram Of Test Setup.....	282
13.2	Limit	282
13.3	Test Procedure	282
13.4	Test Result.....	283
14.	Duty Cycle Of Test Signal	295
14.1	Standard Requirement.....	295
14.2	Formula.....	295
14.3	Test Procedure	295
14.4	Test Result.....	295
15.	Antenna Requirement	341
15.1	Limit	341
15.2	Test Result.....	341
16.	EUT Photographs.....	342
17.	EUT Test Setup Photographs.....	343

(Note: N/A Means Not Applicable)

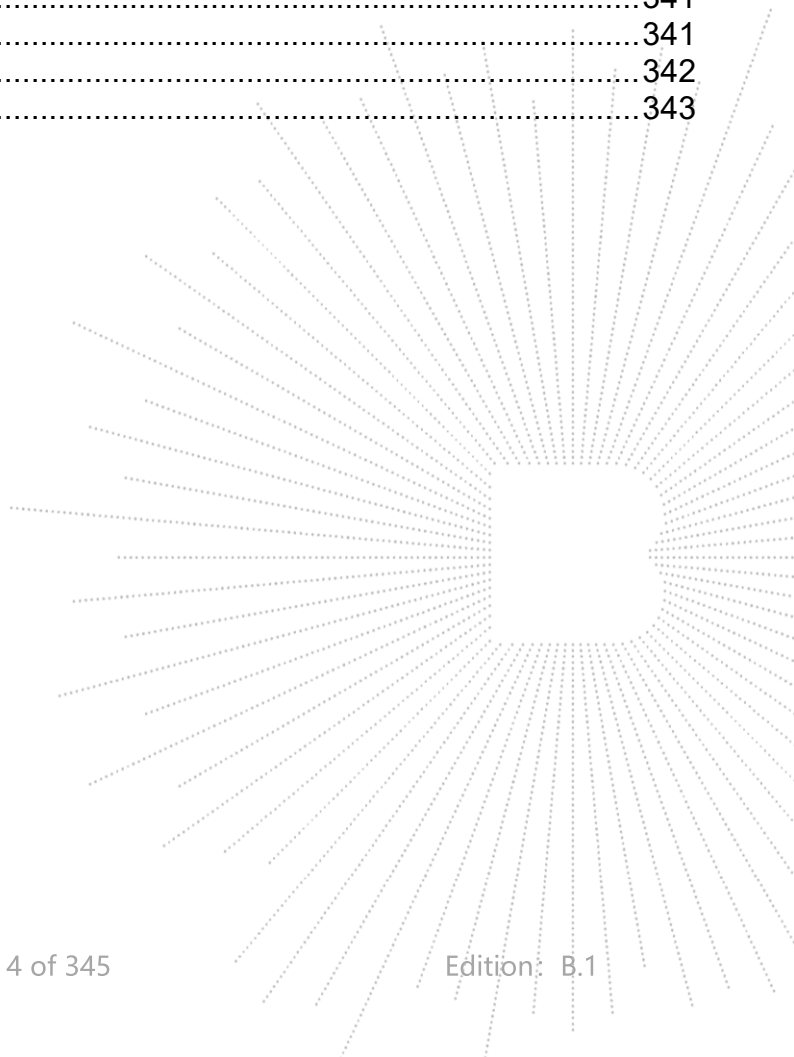

1. Version

Report No.	Issue Date	Description	Approved
BCTC2401848209-2E	2024-01-30	Original	Valid

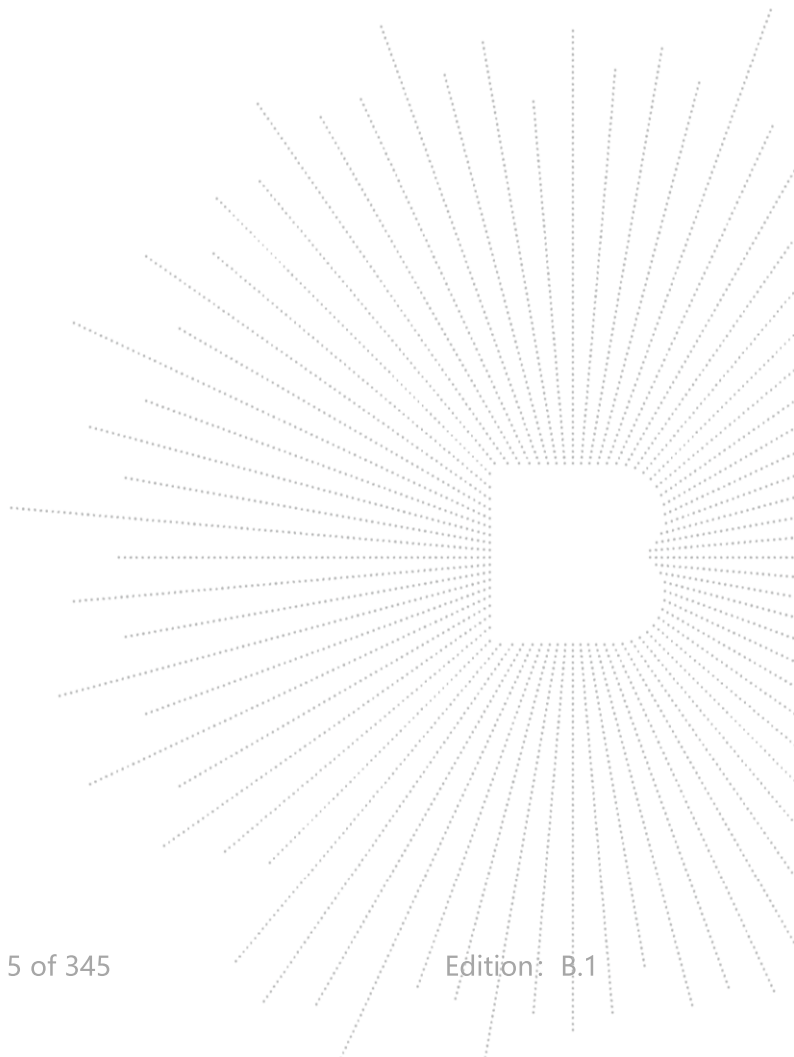

2. Test Summary

The Product has been tested according to the following specifications:

No.	Test Parameter	Clause No.	Results
1	Spurious Radiated Emissions	15.209(a) 15.407 (b)	PASS
2	Conducted Emission	15.207	PASS
3	26 dB and 99% Emission Bandwidth	15.407 a 15.1049	PASS
4	Minimum 6 dB bandwidth	15.407(e)	PASS
5	Maximum Conducted Output Power	15.407 a	PASS
6	Band Edge	15.407 b	PASS
7	Power Spectral Density	15.407 a	PASS
8	Spurious Emissions at Antenna Terminals	15.407 b	PASS
9	Antenna Requirement	15.203	PASS

Note: The device shall automatically discontinue transmission in case of either absence of information to transmit or operational failure.

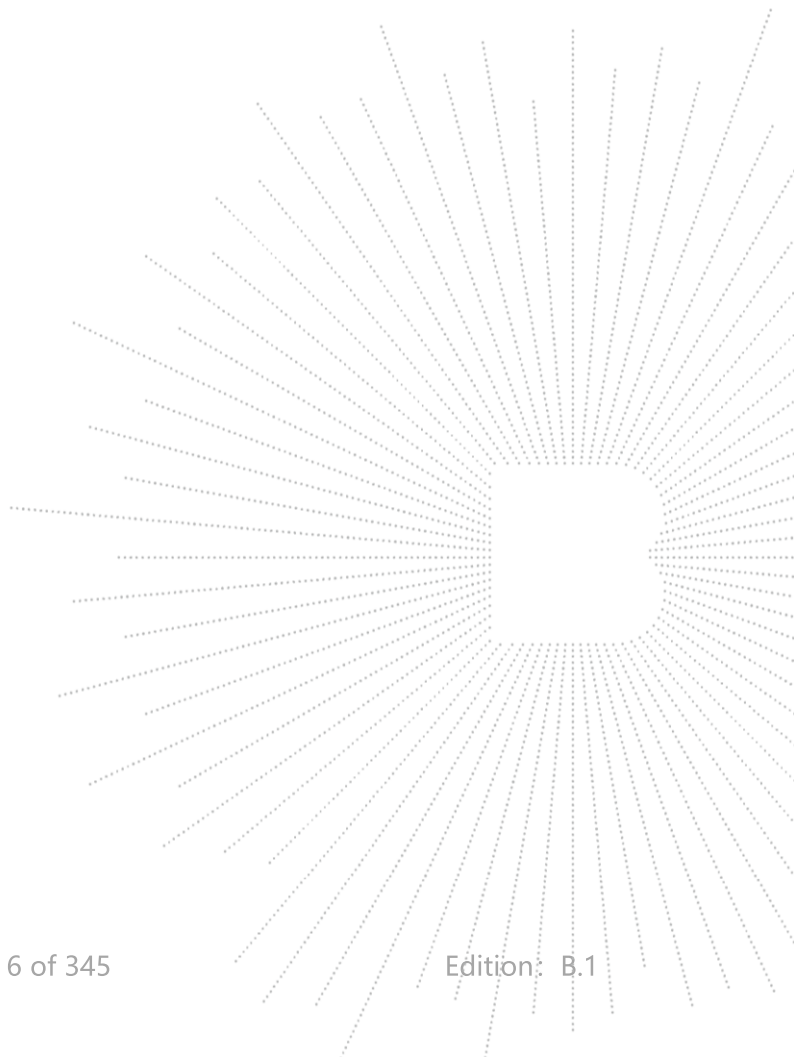

3. Measurement Uncertainty

Where relevant, the following measurement uncertainty levels have been estimated for tests performed on the Product as specified in CISPR 16-4-2. This uncertainty represents an expanded uncertainty expressed at approximately the 95% confidence level using a coverage factor of k=2.

No.	Item	Uncertainty
1	3m chamber Radiated spurious emission(9kHz-30MHz)	U=3.7dB
2	3m chamber Radiated spurious emission(30MHz-1GHz)	U=4.3dB
3	3m chamber Radiated spurious emission(1GHz-18GHz)	U=4.5dB
4	3m chamber Radiated spurious emission(18GHz-40GHz)	U=3.34dB
5	Conducted Emission(150kHz-30MHz)	U=3.20dB
6	Conducted Adjacent channel power	U=1.38dB
7	Conducted output power uncertainty Above 1G	U=1.576dB
8	Conducted output power uncertainty below 1G	U=1.28dB
9	humidity uncertainty	U=5.3%
10	Temperature uncertainty	U=0.59°C

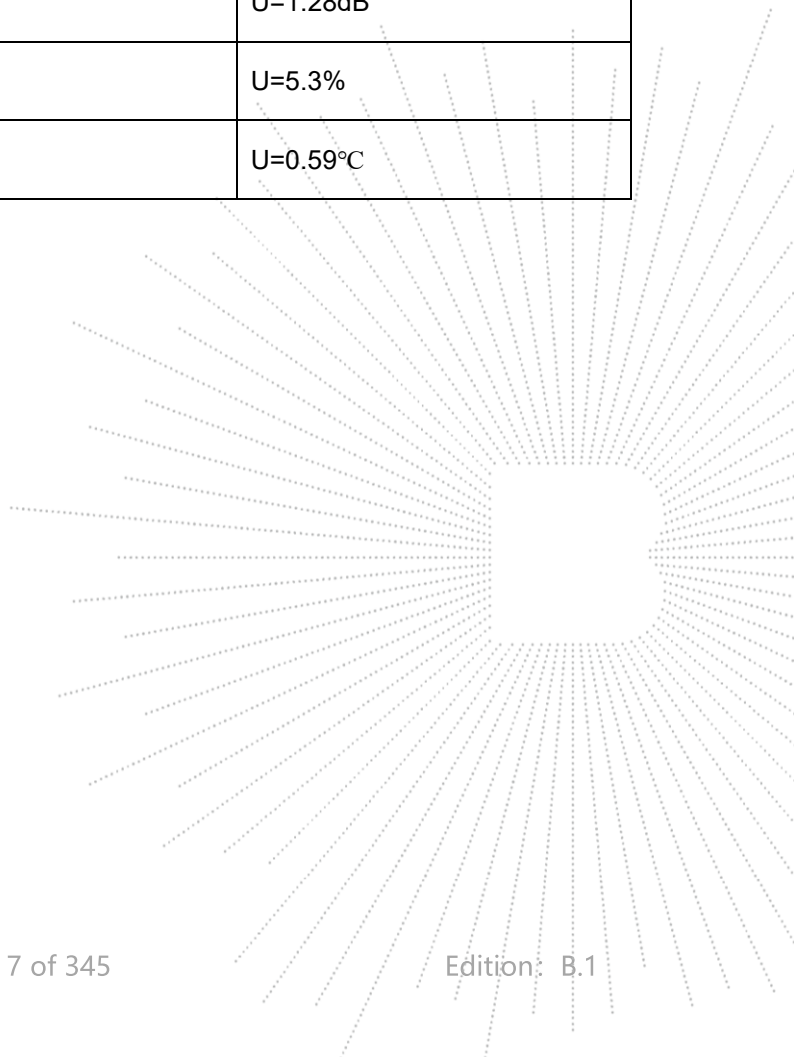

4. Product Information And Test Setup

4.1 Product Information

Model/Type reference:	RLC-823S1W W840
Model differences:	All the model are the same circuit and RF module, except model names.
Hardware Version:	V1.0
Software Version:	V1.0
IEEE 802.11 WLAN Mode Supported	802.11a/n/ac/ax(20MHz channel bandwidth) 802.11n/ac/ax(40MHz channel bandwidth) 802.11ac/ax(80MHz channel bandwidth) 5180-5240MHz for 802.11a/n/ac(HT20)/ax(HT20); 5190-5230MHz for 802.11n/ac(HT40)/ax(HT40); 5210MHz for 802.11 ac80/ax80; 5260-5320MHz for 802.11a/n/ac(HT20)/ax(HT20); 5270-5310MHz for 802.11n/ac(HT40)/ax(HT40); 5290MHz for 802.11 ac80/ax80;
Operation Frequency:	5500-5700MHz for 802.11a/n/ac(HT20)/ax(HT20); 5410-5670MHz for 802.11n/ac(HT40)/ax(HT40); 5530MHz for 802.11 ac80/ax80; 5745-5825 MHz for 802.11a/n/ac(HT20)/ax(HT20); 5755-5795 MHz for 802.11n/ac(HT40)/ax(HT40); 5775MHz for 802.11 ac80/ax80
Data Rate	802.11a: 6,9,12,18,24,36,48,54Mbps; 802.11n(HT20/HT40):MCS0-MCS15; 802.11ac/ax(VHT20): NSS1, MCS0-MCS8 802.11ac/ax(VHT40/VHT80):NSS1, MCS0-MCS9
Type of Modulation:	OFDM with BPSK/QPSK/16QAM/64QAM/256QAM for 802.11a/n/ac/ax;
Antenna installation:	External antenna*2 5G: Antenna A & B: 2.55 dBi
Antenna Gain:	Remark: <input checked="" type="checkbox"/> The antenna gain of the product comes from the antenna report provided by the customer, and the test data is affected by the customer information. <input type="checkbox"/> The antenna gain of the product is provided by the customer, and the test data is affected by the customer information.
Ratings:	AC 120V/60Hz
Adapter Information:	Model: DCT24W120200US-A0 Input: 100-240V~ 50/60Hz 0.7A max. Output: DC 12.0V 2.0A

4.2 Test Setup Configuration

See test photographs attached in *EUT TEST SETUP PHOTOGRAPHS* for the actual connections between Product and support equipment.

4.3 Support Equipment

No.	Device Type	Brand	Model	Series No.	Note
E-1	WiFi IP Camera		RLC-823S1W	N/A	EUT
E-2	Adapter	N/A	DCT24W12020 0US-A0	N/A	Auxiliary
E-3	Router	N/A	N/A	N/A	Auxiliary
E-4	laptop	N/A	N/A	N/A	Auxiliary

Item	Shielded Type	Ferrite Core	Length	Note
C-1	N/A	N/A	3M	DC cable unshielded

Notes:

1. All the equipment/cables were placed in the worst-case configuration to maximize the emission during the test.
2. Grounding was established in accordance with the manufacturer's requirements and conditions for the intended use.

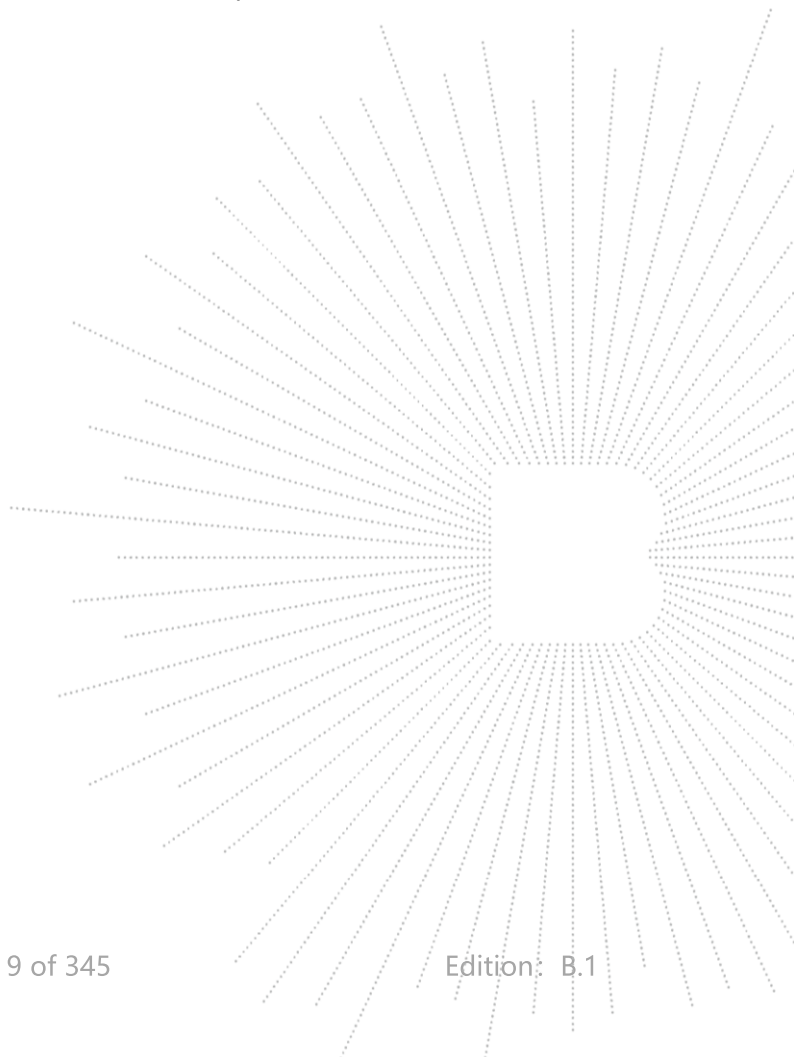

4.4 Channel List

(U-NII-1) 5180MHz-5240MHz				
Bandwidth	Channel	Frequency (MHz)	Channel	Frequency
20MHz	36	5180	40	5200
	44	5220	48	5240
40MHz	38	5190	46	5230
80MHz	42	5210		
(U-NII-2A) 5260MHz-5320MHz				
Bandwidth	Channel	Frequency (MHz)	Channel	Frequency
20MHz	52	5260	56	5280
	60	5300	64	5320
40MHz	54	5270	62	5310
80MHz	58	5290		
(U-NII-2C) 5500MHz-5700MHz				
Bandwidth	Channel	Frequency (MHz)	Channel	Frequency
20MHz	100	5500	105	5520
	108	5540	112	5560
	116	5580	132	5660
	136	5680	140	5700
40MHz	102	5510	110	5550
	134	5670	142	5710
80MHz	106	5530		
(U-NII-3) 5745MHz-5825MHz				
Bandwidth	Channel	Frequency (MHz)	Channel	Frequency
20MHz	149	5745	153	5765
	157	5785	161	5805
	165	5825		
40MHz	151	5775	159	5795
80MHz	155	5775		

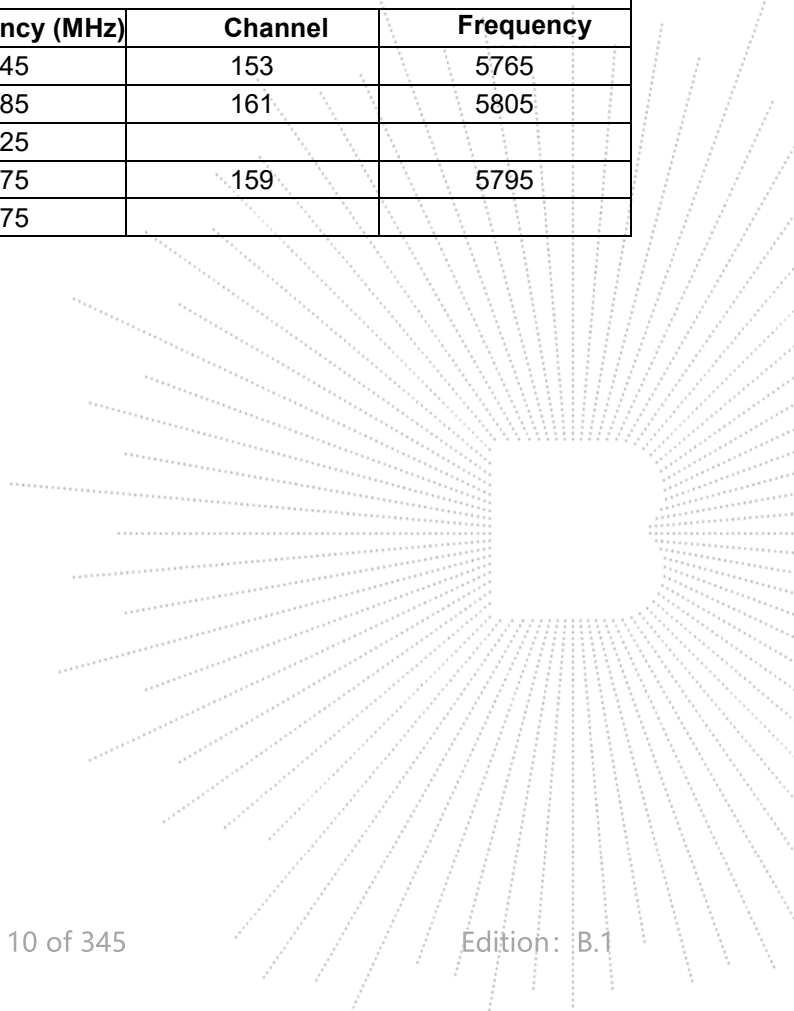

4.5 Test Mode

To investigate the maximum EMI emission characteristics generates from EUT, the test system was pre-scanning tested base on the consideration of following EUT operation mode or test configuration mode which possible have effect on EMI emission level. Each of these EUT operation mode(s) or test configuration mode(s) mentioned above was evaluated respectively.

Pretest Mode	Description
Mode 1	802.11a / n/ ac 20/ax 20 CH36/ CH40/ CH 48 802.11a / n/ ac 20/ax 20 CH52/ CH56/ CH 64 802.11a / n/ ac 20/ax 20 CH100/ CH116/ CH 140 802.11a /n/ ac 20/ax 20 CH149/ CH157/ CH 165
Mode 2	802.11n/ ac40/ax 40 CH38/ CH 46 802.11n/ ac40/ax 40 CH54/ CH 62 802.11n/ ac40/ax 40 CH102/ CH 110/CH134 802.11n/ ac40/ax 40 CH 151 / CH 159
Mode 3	802.11 ac80/ax 80 CH 42/ CH 58/ CH 106/ CH 155
Mode 4	Link Mode

Note:

(1) The measurements are performed at all Bit Rate of Transmitter, the worst data was reported.

4.6 Table Of Parameters Of Text Software Setting

During testing channel & power controlling software provided by the customer was used to control the operating channel as well as the output power level. The RF output power selection is for the setting of RF output power expected by the customer and is going to be fixed on the firmware of the final end product power parameters

Test software Version	CMD		
Parameters	DEF	DEF	DEF

4.7 Antenna

5.1G&5.3G&5.6G&5.8G

Ant.	Brand	Model Name	Antenna Type	Gain (dBi)	NOTE
A	N/A	N/A	External antenna	2.55	N/A
B	N/A	N/A	External antenna	2.55	N/A

EUT has two External antenna with Max gain GANT 2.55 dBi on every antenna, CDD device with one spatial streams, also can operat with one spatial streams according to KDB662911 D01 v02r01, Directional gain= GANT + Array Gain, where Array Gain is as follows.

- 1)For power spectral density(PSD) measurements,
 $\text{Array Gain} = 10 \log(\text{NANT}/\text{NSS}) \text{dB} = 10 \log(2/1) = 3.01 \text{ dBi}$
 So the directional gain for PSD is 5.56 dBi
- 2)For power measurements,
 The Array gain=0 for $\text{NANT} \leq 4$,
 So the directional gain for Power measurements is 2.55 dBi

5. Test Facility And Test Instrument Used

5.1 Test Facility

All measurement facilities used to collect the measurement data are located at Shenzhen BCTC Testing Co., Ltd. Address: 1-2/F., Building B, Pengzhou Industrial Park, No.158, Fuyuan 1st Road, Zhancheng, Fuhai Subdistrict, Bao'an District, Shenzhen, Guangdong, China. The site and apparatus are constructed in conformance with the requirements of ANSI C63.4 and CISPR 16-1-1 other equivalent standards.

FCC Test Firm Registration Number: 712850

A2LA certificate registration number is: CN1212

ISED Registered No.: 23583

ISED CAB identifier: CN0017

5.2 Test Instrument Used

Conducted Emissions Test					
Equipment	Manufacturer	Model#	Serial#	Last Cal.	Next Cal.
Receiver	R&S	ESR3	102075	May 15, 2023	May 14, 2024
LISN	R&S	ENV216	101375	May 15, 2023	May 14, 2024
Software	Frad	EZ-EMC	EMC-CON 3A1	\	\
Pulse limiter	Schwarzbeck	VTSD9561-F	01323	Sept. 22, 2023	Sept. 21, 2024

RF Conducted Test					
Equipment	Manufacturer	Model#	Serial#	Last Cal.	Next Cal.
Power meter	Keysight	E4419	\	May 15, 2023	May 14, 2024
Power Sensor (AV)	Keysight	E9300A	\	May 15, 2023	May 14, 2024
Signal Analyzer20kHz-26.5GHz	Keysight	N9020A	MY49100060	May 15, 2023	May 14, 2024
Spectrum Analyzer9kHz-40GHz	R&S	FSP40	100363	May 15, 2023	May 14, 2024
Radio frequency control box	MAIWEI	MW100-RFC B	\	\	\
Software	MAIWEI	MTS 8310	\	\	\

Radiated Emissions Test (966 Chamber01)					
Equipment	Manufacturer	Model#	Serial#	Last Cal.	Next Cal.
966 chamber	ChengYu	966 Room	966	May 15, 2023	May 14, 2026
Receiver	R&S	ESR3	102075	May 15, 2023	May 14, 2024
Receiver	R&S	ESRP	101154	May 15, 2023	May 14, 2024
Amplifier	Schwarzbeck	BBV9744	9744-0037	May 15, 2023	May 14, 2024
TRILOG Broadband Antenna	Schwarzbeck	VULB9163	942	May 29, 2023	May 28, 2024
Loop Antenna(9KHz -30MHz)	Schwarzbeck	FMZB1519B	00014	May 31, 2023	May 30, 2024
Amplifier	SKET	LAPA_01G18 G-45dB	SK2021040901	May 15, 2023	May 14, 2024
Horn Antenna	Schwarzbeck	BBHA9120D	1541	May 31, 2023	May 30, 2024
Amplifier(18G Hz-40GHz)	MITEQ	TTA1840-35-HG	2034381	May 15, 2023	May 14, 2024
Horn Antenna(18G Hz-40GHz)	Schwarzbeck	BBHA9170	00822	May 31, 2023	May 30, 2024
Spectrum Analyzer9kHz-40GHz	R&S	FSP40	100363	May 15, 2023	May 14, 2024
Software	Frad	EZ-EMC	FA-03A2 RE	\	\

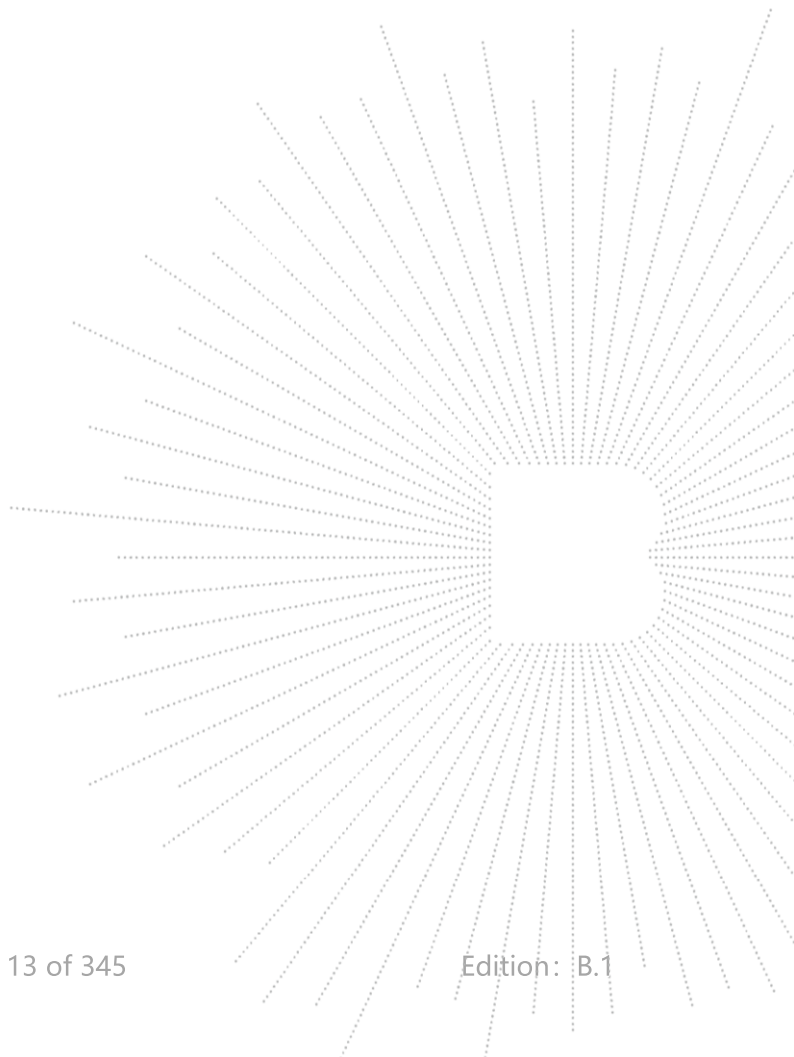

6. Conducted Emissions

6.1 Block Diagram Of Test Setup

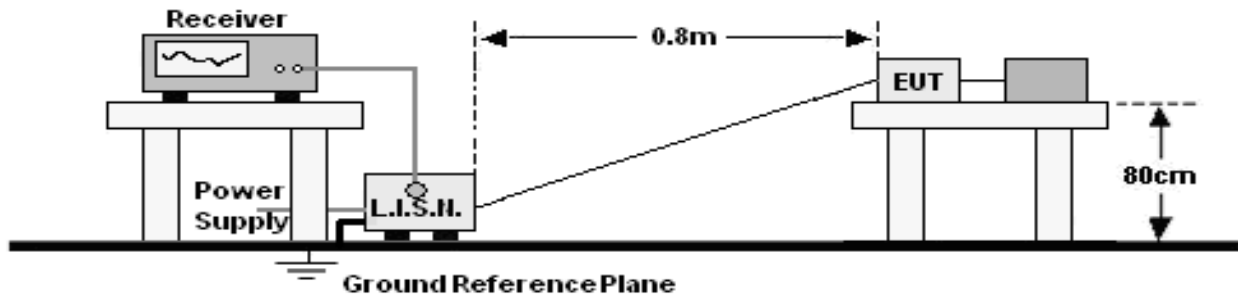

6.2 Limit

Frequency (MHz)	Limit (dBuV)	
	Quas-peak	Average
0.15 -0.5	66 - 56 *	56 - 46 *
0.50 -5.0	56.00	46.00
5.0 -30.0	60.00	50.00

Notes:

- *Decreasing linearly with logarithm of frequency.
- The lower limit shall apply at the transition frequencies.

6.3 Test Procedure

Receiver Parameters	Setting
Attenuation	10 dB
Start Frequency	0.15 MHz
Stop Frequency	30 MHz
IF Bandwidth	9 kHz

- The Product was placed on a nonconductive table 0.8 m above the horizontal ground reference plane, and 0.4 m from the vertical ground reference plane, and connected to the main through Line Impedance Stability Network (L.I.S.N).
- The RBW of the receiver was set at 9 kHz in 150 kHz ~ 30MHz with Peak and AVG detector in Max Hold mode. Run the receiver's pre-scan to record the maximum disturbance generated from Product in all power lines in the full band.
- For each frequency whose maximum record was higher or close to limit, measure its QP and AVG values and record.

6.4 EUT Operating Conditions

The EUT was configured for testing in a typical fashion (as a customer would normally use it). The EUT has been programmed to continuously transmit during test. This operating condition was tested and used to collect the included data.

6.5 Test Result

Temperature:	26 °C	Relative Humidity:	54%
Pressure:	101KPa	Test Voltage:	AC120V/60Hz
Test Mode:	Mode 1	Polarization :	L

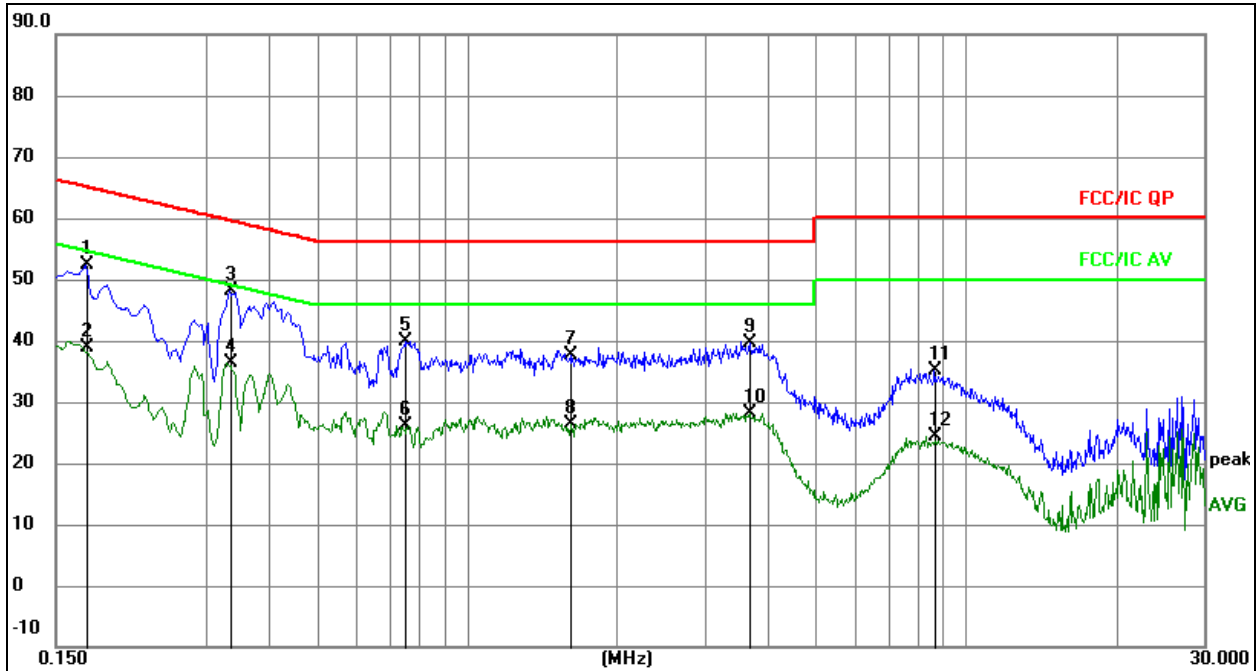

Remark:

1. All readings are Quasi-Peak and Average values.
2. Factor = Insertion Loss + Cable Loss.
3. Measurement = Reading Level + Correct Factor
4. Over = Measurement - Limit

No.	Mk.	Freq. MHz	Reading Level	Correct Factor dB	Measure- ment dBuV	Limit dBuV	Over dB	Detector
1		0.1725	32.66	19.78	52.44	64.84	-12.40	QP
2		0.1725	19.20	19.78	38.98	54.84	-15.86	AVG
3	*	0.3345	28.19	19.83	48.02	59.34	-11.32	QP
4		0.3345	16.60	19.83	36.43	49.34	-12.91	AVG
5		0.7530	19.99	19.86	39.85	56.00	-16.15	QP
6		0.7530	6.35	19.86	26.21	46.00	-19.79	AVG
7		1.6125	17.73	19.95	37.68	56.00	-18.32	QP
8		1.6125	6.55	19.95	26.50	46.00	-19.50	AVG
9		3.6870	18.97	20.55	39.52	56.00	-16.48	QP
10		3.6870	7.55	20.55	28.10	46.00	-17.90	AVG
11		8.6459	15.10	19.92	35.02	60.00	-24.98	QP
12		8.6459	4.51	19.92	24.43	50.00	-25.57	AVG

Temperature:	26 °C	Relative Humidity:	54%
Pressure:	101KPa	Test Voltage:	AC120V/60Hz
Test Mode:	Mode 1	Polarization :	N

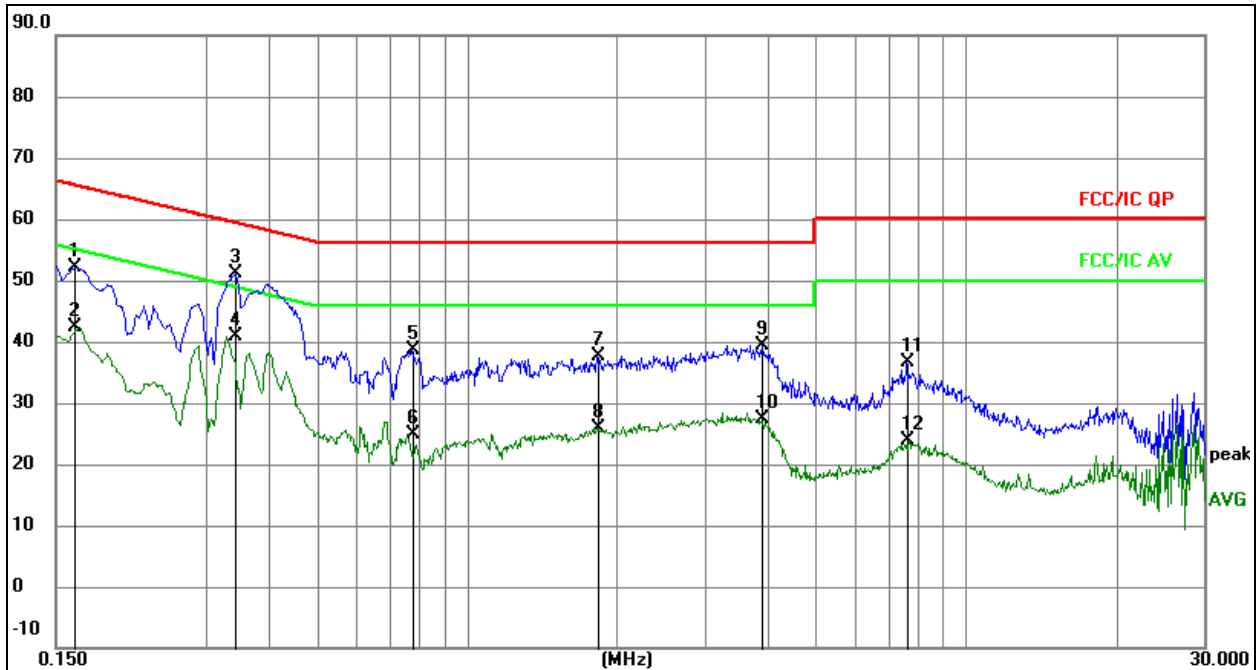
Remark:

1. All readings are Quasi-Peak and Average values.
2. Factor = Insertion Loss + Cable Loss.
3. Measurement = Reading Level + Correct Factor
4. Over = Measurement - Limit

No.	Mk.	Freq. MHz	Reading Level	Correct Factor dB	Measure- ment dBuV	Limit dBuV	Over dB	Detector
1		0.1633	32.38	19.76	52.14	65.29	-13.15	QP
2		0.1633	22.70	19.76	42.46	55.29	-12.83	AVG
3	*	0.3428	31.22	19.83	51.05	59.14	-8.09	QP
4		0.3428	21.15	19.83	40.98	49.14	-8.16	AVG
5		0.7752	18.79	19.87	38.66	56.00	-17.34	QP
6		0.7752	4.96	19.87	24.83	46.00	-21.17	AVG
7		1.8192	17.74	19.95	37.69	56.00	-18.31	QP
8		1.8192	5.92	19.95	25.87	46.00	-20.13	AVG
9		3.9014	18.80	20.62	39.42	56.00	-16.58	QP
10		3.9014	6.83	20.62	27.45	46.00	-18.55	AVG
11		7.6060	16.69	19.94	36.63	60.00	-23.37	QP
12		7.6060	3.82	19.94	23.76	50.00	-26.24	AVG

7. Radiated Emissions

7.1 Block Diagram Of Test Setup

(A) Radiated Emission Test-Up Frequency Below 30MHz

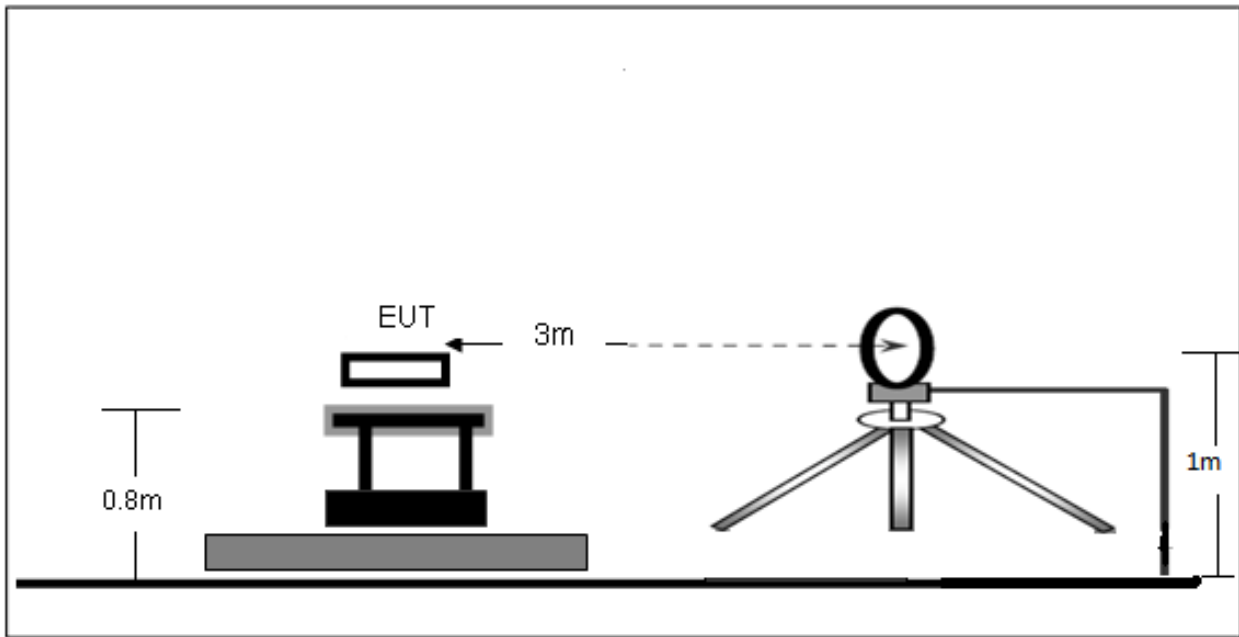

(B) Radiated Emission Test-Up Frequency 30MHz~1GHz

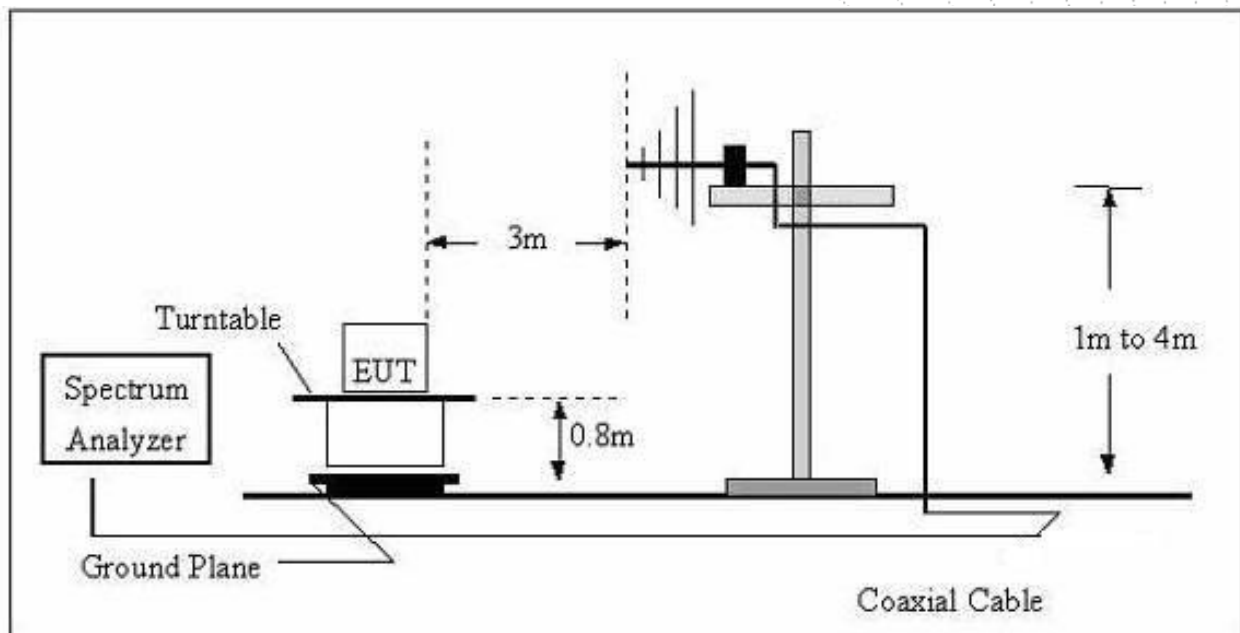

(C) Radiated Emission Test-Up Frequency Above 1GHz

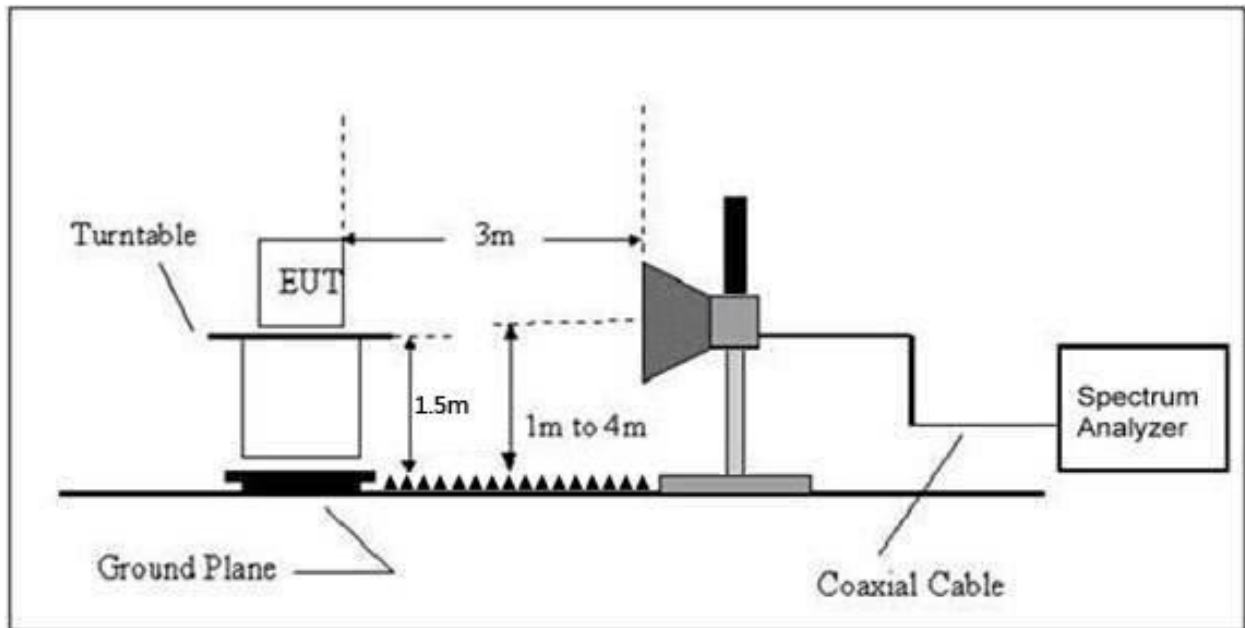

7.2 Limit

20dBc in any 100 kHz bandwidth outside the operating frequency band. In case the emission fall within the restricted band specified on 15.205(a), then the 15.209(a) limit in the table below has to be followed.

Frequency (MHz)	Field Strength uV/m	Distance (m)	Field Strength Limit at 3m Distance	
			uV/m	dBuV/m
0.009 ~ 0.490	2400/F(kHz)	300	10000 * 2400/F(kHz)	20log ^{(2400/F(kHz))} + 80
0.490 ~ 1.705	24000/F(kHz)	30	100 * 24000/F(kHz)	20log ^{(24000/F(kHz))} + 40
1.705 ~ 30	30	30	100 * 30	20log ⁽³⁰⁾ + 40
30 ~ 88	100	3	100	20log ⁽¹⁰⁰⁾
88 ~ 216	150	3	150	20log ⁽¹⁵⁰⁾
216 ~ 960	200	3	200	20log ⁽²⁰⁰⁾
Above 960	500	3	500	20log ⁽⁵⁰⁰⁾

Limits Of Radiated Emission Measurement (Above 1000MHz)

Frequency (MHz)	Limit (dBuV/m) (at 3M)	
	Peak	Average
Above 1000	74	54

Notes:

- (1)The limit for radiated test was performed according to FCC PART 15C.
- (2)The tighter limit applies at the band edges.
- (3) Emission level (dBuV/m)=20log Emission level (uV/m).

7.3 Test Procedure

The test site semi-anechoic chamber has met the requirement of NSA tolerance 4 dB according to the standards: ANSI C63.10-2013. The test distance is 3m. The setup is according to the requirements in Section 13.1.4.1 of ANSI C63.10-2013 and CAN/CSA-CEI/IEC CISPR 22.

This test is required for any spurious emission that falls in a Restricted Band, as defined in Section 15.205.

It must be performed with the highest gain of each type of antenna proposed for use with the EUT. Use the following spectrum analyzer settings:

Spectrum Parameter	Setting
Attenuation	Auto
Start Frequency	1000 MHz
Stop Frequency	10th carrier harmonic
RB / VB (emission in restricted band)	1 MHz / 1 MHz for Peak, 1 MHz / 10Hz for Average

Receiver Parameter	Setting
Attenuation	Auto
Start ~ Stop Frequency	9kHz~150kHz / RB 200Hz for QP
Start ~ Stop Frequency	150kHz~30MHz / RB 9kHz for QP
Start ~ Stop Frequency	30MHz~1000MHz / RB 120kHz for QP

- The measuring distance of at 3 m shall be used for measurements at frequency up to 1GHz. For frequencies above 1GHz, any suitable measuring distance may be used.
- The EUT was placed on the top of a rotating table 0.8 m for below 1GHz and 1.5m for above 1GHz the ground at a 3 meter. The table was rotated 360 degrees to determine the position of the highest radiation.
- The height of the equipment or of the substitution antenna shall be 0.8 m for below 1GHz and 1.5m for above 1GHz; the height of the test antenna shall vary between 1 m to 4 m. Both horizontal and vertical polarizations of the antenna are set to make the measurement.
- The initial step in collecting conducted emission data is a spectrum analyzer peak detector mode pre-scanning the measurement frequency range. Significant peaks are then marked and then Quasi Peak detector mode re-measured.
- If the Peak Mode measured value compliance with and lower than Quasi Peak Mode Limit, the EUT shall be deemed to meet QP Limits and then no additional QP Mode measurement performed.
- For the actual test configuration, please refer to the related Item –EUT Test Photos.

Note:

Both horizontal and vertical antenna polarities were tested and performed pretest to three orthogonal axis. The worst case emissions were reported

During the radiated emission test, the Spectrum Analyzer was set with the following configurations:

Frequency Band (MHz)	Function	Resolution bandwidth	Video Bandwidth
30 to 1000	QP	120 kHz	300 kHz
Above 1000	Peak	1 MHz	1 MHz
	Average	1 MHz	10 Hz

Note: for the frequency ranges below 30 MHz, a narrower RBW is used for these ranges but the measured value should add a RBW correction factor (RBWCF) where $RBWCF [dB] = 10 \cdot \lg(100 [kHz] / \text{narrower RBW} [kHz])$. , the narrower RBW is 1 kHz and RBWCF is 20 dB for the frequency 9 kHz to 150 kHz, and the narrower RBW is 10 kHz and RBWCF is 10 dB for the frequency 150 kHz to 30 MHz.

7.4 EUT Operating Conditions

The EUT was configured for testing in a typical fashion (as a customer would normally use it). The EUT has been programmed to continuously transmit during test. This operating condition was tested and used to collect the included data.

7.5 Test Result

Below 30MHz

Temperature:	26°C	Relative Humidity:	24%
Pressure:	101 kPa	Test Voltage :	AC 120V/60Hz
Test Mode:	Mode 1	Polarization:	--

Freq. (MHz)	Reading (dBuV/m)	Limit (dBuV/m)	Margin (dB)	State P/F
--	--	--	--	PASS
--	--	--	--	PASS

Note:

The amplitude of spurious emissions which are attenuated by more than 20dB below the permissible value has no need to be reported.

Distance extrapolation factor = $40 \log(\text{specific distance/test distance})(\text{dB})$;

Limit line = specific limits(dBuv) + distance extrapolation factor.

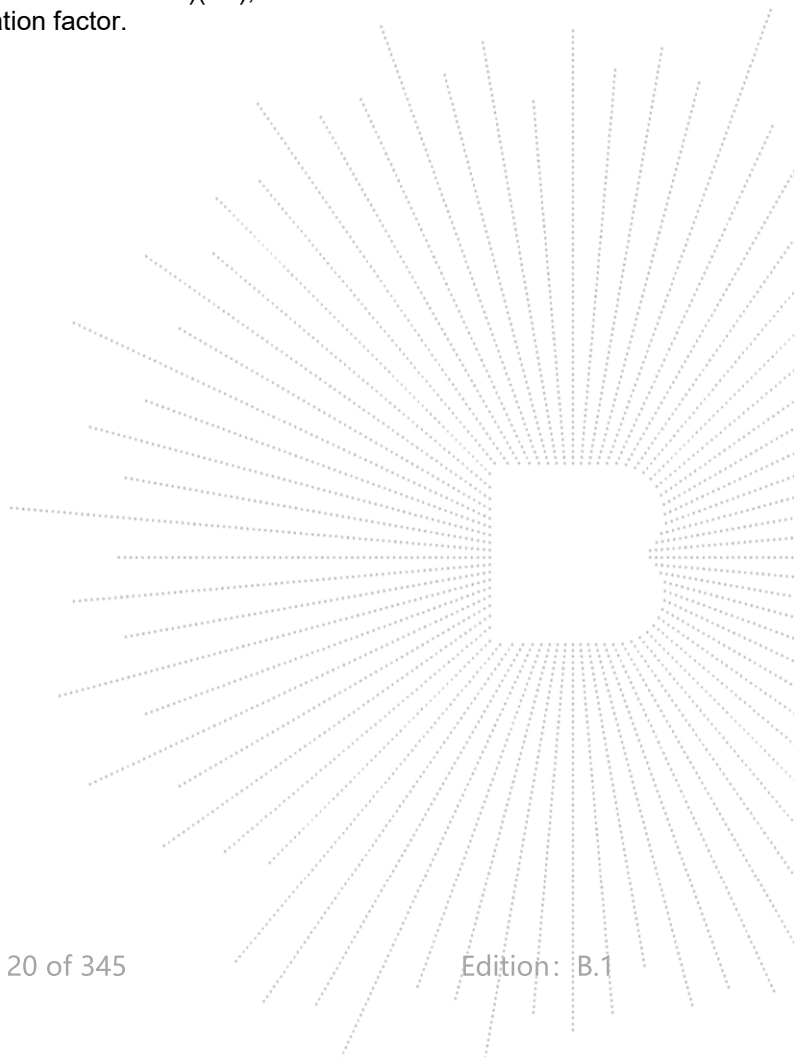

Between 30MHz – 1GHz

Temperature:	26 °C	Relative Humidity:	54%
Pressure:	101KPa	Test Voltage:	AC120V/60Hz
Test Mode:	Mode 1	Polarization :	Horizontal

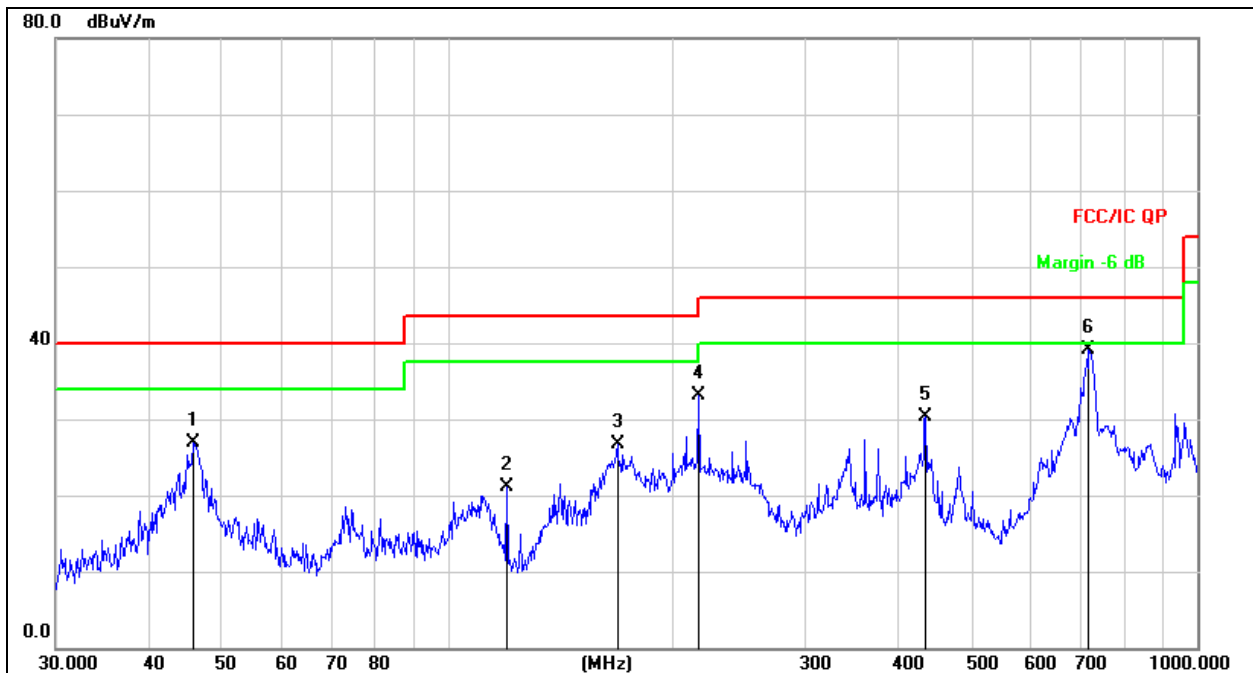
Remark:

1. Factor = Antenna Factor + Cable Loss – Pre-amplifier.
2. Measurement = Reading Level + Correct Factor
3. Over = Measurement - Limit

No. Mk.	Freq. MHz	Reading Level dBuV	Correct Factor dB	Measure- ment dBuV/m	Limit dB/m	Over dB	Detector
1	45.6948	41.07	-14.25	26.82	40.00	-13.18	QP
2	119.8556	38.48	-17.32	21.16	43.50	-22.34	QP
3	168.4138	44.74	-18.06	26.68	43.50	-16.82	QP
4	216.0240	48.40	-15.26	33.14	46.00	-12.86	QP
5	434.0651	40.43	-10.17	30.26	46.00	-15.74	QP
6 *	716.6820	44.51	-5.47	39.04	46.00	-6.96	QP

Temperature:	26 °C	Relative Humidity:	54%
Pressure:	101KPa	Test Voltage:	AC120V/60Hz
Test Mode:	Mode 1	Polarization :	Vertical

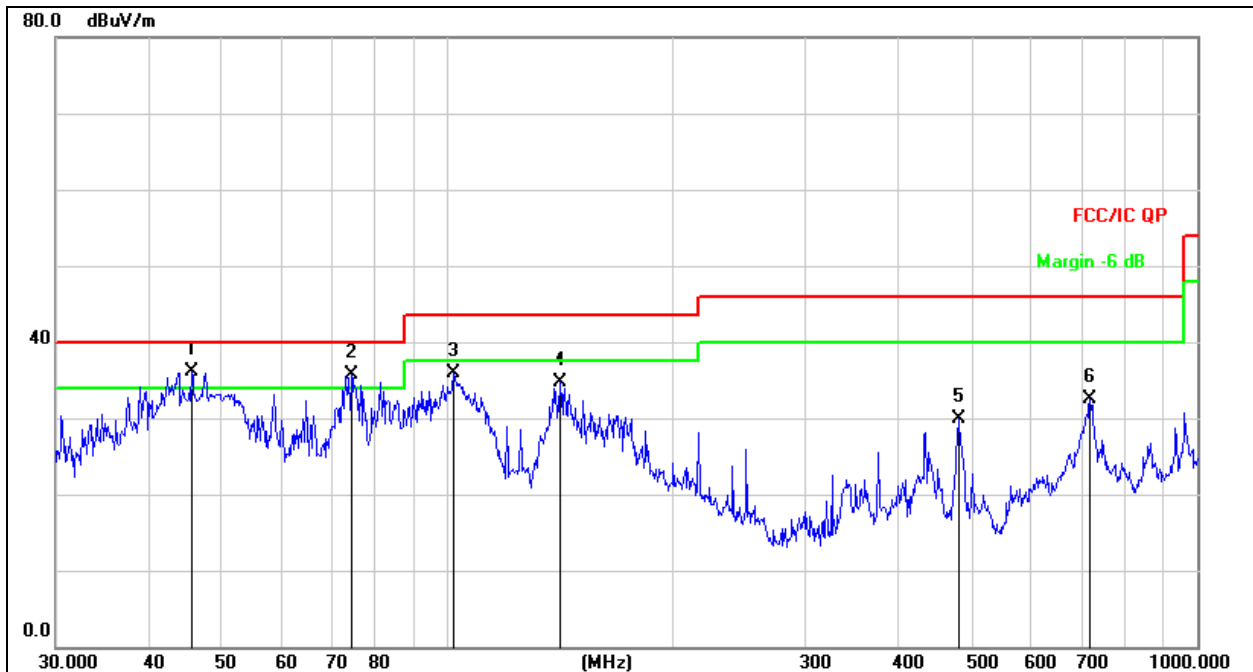
Remark:

1. Factor = Antenna Factor + Cable Loss – Pre-amplifier.
2. Measurement = Reading Level + Correct Factor
3. Over = Measurement - Limit

No.	Mk.	Freq. MHz	Reading Level dBuV	Correct Factor dB	Measure- ment dBuV/m	Limit dB/m	Over dB	Detector
1	*	45.5348	50.43	-14.27	36.16	40.00	-3.84	QP
2	!	74.3955	54.47	-18.77	35.70	40.00	-4.30	QP
3		102.0014	52.05	-16.07	35.98	43.50	-7.52	QP
4		141.3298	53.62	-18.82	34.80	43.50	-8.70	QP
5		480.5276	38.97	-9.10	29.87	46.00	-16.13	QP
6		719.1995	37.91	-5.43	32.48	46.00	-13.52	QP

Test Mode:	TX(5.1G) - 802.11a
------------	--------------------

Polar (H/V)	Fre- quency (MHz)	Reading Level (dBuV/m)	Correct Factor (dB)	Measure- ment (dBuV/m)	Limits (dBuV/m)	Over (dB)	Detector Type
Low Channel (5180 MHz)-Above 1G							
Vertical	4434.19	70.76	-20.73	50.02	68.20	-18.18	PK
Vertical	4434.19	59.49	-20.73	38.76	54.00	-15.24	AV
Vertical	10360.02	63.82	-9.36	54.46	68.20	-13.74	PK
Vertical	10360.02	49.03	-9.36	39.67	54.00	-14.33	AV
Vertical	15540.04	62.39	-7.84	54.55	74.00	-19.45	PK
Vertical	15540.04	49.23	-7.84	41.39	54.00	-12.61	AV
Horizontal	4434.12	74.59	-20.73	53.86	68.20	-14.34	PK
Horizontal	4434.12	59.39	-20.73	38.66	54.00	-15.34	AV
Horizontal	10360.13	60.44	-9.36	51.08	68.20	-17.12	PK
Horizontal	10360.13	49.51	-9.36	40.15	54.00	-13.85	AV
Horizontal	15540.13	62.94	-7.84	55.10	74.00	-18.90	PK
Horizontal	15540.13	49.99	-7.84	42.15	54.00	-11.85	AV
middle Channel (5200 MHz)-Above 1G							
Vertical	4592.05	73.40	-20.42	52.98	74.00	-21.02	PK
Vertical	4592.05	59.10	-20.42	38.68	54.00	-15.32	AV
Vertical	10400.18	62.12	-9.30	52.82	68.20	-15.38	PK
Vertical	10400.18	49.27	-9.30	39.97	54.00	-14.03	AV
Vertical	15600.09	62.26	-7.82	54.44	74.00	-19.56	PK
Vertical	15600.09	49.80	-7.82	41.98	54.00	-12.02	AV
Horizontal	4592.04	72.81	-20.42	52.40	74.00	-21.60	PK
Horizontal	4592.04	59.55	-20.42	39.14	54.00	-14.86	AV
Horizontal	10400.15	64.91	-9.30	55.61	68.20	-12.59	PK
Horizontal	10400.15	49.24	-9.30	39.94	54.00	-14.06	AV
Horizontal	15600.02	62.96	-7.82	55.14	74.00	-18.86	PK
Horizontal	15600.02	49.15	-7.82	41.33	54.00	-12.67	AV
High Channel (5240 MHz)-Above 1G							
Vertical	4739.04	71.08	-20.12	50.96	74.00	-23.04	PK
Vertical	4739.04	59.97	-20.12	39.85	54.00	-14.15	AV
Vertical	10480.10	63.76	-9.18	54.58	68.20	-13.62	PK
Vertical	10480.10	49.57	-9.18	40.39	54.00	-13.61	AV
Vertical	15720.07	63.30	-7.78	55.52	74.00	-18.48	PK
Vertical	15720.07	49.23	-7.78	41.45	54.00	-12.55	AV
Horizontal	4739.08	74.03	-20.12	53.91	74.00	-20.09	PK
Horizontal	4739.08	59.84	-20.12	39.72	54.00	-14.28	AV
Horizontal	10480.12	62.12	-9.18	52.94	68.20	-15.26	PK
Horizontal	10480.12	49.89	-9.18	40.71	54.00	-13.29	AV
Horizontal	15720.06	60.69	-7.78	52.91	74.00	-21.09	PK
Horizontal	15720.06	49.79	-7.78	42.01	54.00	-11.99	AV

Note: PK value is lower than the Average value limit, So average didn't record.

The 26.5-40G amplitude of spurious emissions that are attenuated by more than 20dB below the permissible value has no need to be reported.

Emission level (dBuV/m) = 20 log Emission level (uV/m).

Corrected Reading: Antenna Factor + Cable Loss + Read Level - Preamp Factor = Level.

The worst case is Antenna A.

Test Mode:	TX(5.1G) - 802.11n-HT20
------------	-------------------------

Polar (H/V)	Fre- quency (MHz)	Reading Level (dBuV/m)	Correct Factor (dB)	Measure- ment (dBuV/m)	Limits (dBuV/m)	Over (dB)	Detector Type
Low Channel (5180 MHz)-Above 1G							
Vertical	4434.08	73.77	-20.73	53.04	68.20	-15.16	PK
Vertical	4434.08	59.05	-20.73	38.31	54.00	-15.69	AV
Vertical	10360.05	64.80	-9.36	55.44	68.20	-12.76	PK
Vertical	10360.05	49.83	-9.36	40.47	54.00	-13.53	AV
Vertical	15540.19	64.24	-7.84	56.40	74.00	-17.60	PK
Vertical	15540.19	49.57	-7.84	41.73	54.00	-12.27	AV
Horizontal	4434.04	72.73	-20.73	52.00	68.20	-16.20	PK
Horizontal	4434.04	59.33	-20.73	38.60	54.00	-15.40	AV
Horizontal	10360.02	63.25	-9.36	53.89	68.20	-14.31	PK
Horizontal	10360.02	49.91	-9.36	40.55	54.00	-13.45	AV
Horizontal	15540.14	64.75	-7.84	56.91	74.00	-17.09	PK
Horizontal	15540.14	49.01	-7.84	41.17	54.00	-12.83	AV
middle Channel (5200 MHz)-Above 1G							
Vertical	4592.15	70.81	-20.42	50.40	74.00	-23.60	PK
Vertical	4592.15	59.88	-20.42	39.46	54.00	-14.54	AV
Vertical	10400.14	62.07	-9.30	52.77	68.20	-15.43	PK
Vertical	10400.14	49.01	-9.30	39.71	54.00	-14.29	AV
Vertical	15600.10	63.24	-7.82	55.42	74.00	-18.58	PK
Vertical	15600.10	49.75	-7.82	41.93	54.00	-12.07	AV
Horizontal	4592.13	72.42	-20.42	52.01	74.00	-21.99	PK
Horizontal	4592.13	59.76	-20.42	39.34	54.00	-14.66	AV
Horizontal	10400.08	63.81	-9.30	54.51	68.20	-13.69	PK
Horizontal	10400.08	49.09	-9.30	39.79	54.00	-14.21	AV
Horizontal	15600.01	64.89	-7.82	57.07	74.00	-16.93	PK
Horizontal	15600.01	49.77	-7.82	41.95	54.00	-12.05	AV
High Channel (5240 MHz)-Above 1G							
Vertical	4739.02	70.42	-20.12	50.30	74.00	-23.70	PK
Vertical	4739.02	59.02	-20.12	38.90	54.00	-15.10	AV
Vertical	10480.05	62.75	-9.18	53.57	68.20	-14.63	PK
Vertical	10480.05	49.34	-9.18	40.16	54.00	-13.84	AV
Vertical	15720.06	63.43	-7.78	55.65	74.00	-18.35	PK
Vertical	15720.06	49.15	-7.78	41.37	54.00	-12.63	AV
Horizontal	4739.00	71.23	-20.12	51.11	74.00	-22.89	PK
Horizontal	4739.00	59.85	-20.12	39.73	54.00	-14.27	AV
Horizontal	10480.18	60.76	-9.18	51.58	68.20	-16.62	PK
Horizontal	10480.18	49.31	-9.18	40.13	54.00	-13.87	AV
Horizontal	15720.16	63.49	-7.78	55.71	74.00	-18.29	PK
Horizontal	15720.16	49.21	-7.78	41.43	54.00	-12.57	AV

Note: PK value is lower than the Average value limit, So average didn't record.
 The 26.5-40G amplitude of spurious emissions that are attenuated by more than 20dB below the permissible value has no need to be reported.
 Emission level (dBuV/m) = 20 log Emission level (uV/m).
 Corrected Reading: Antenna Factor + Cable Loss + Read Level - Preamp Factor = Level.
 Test Mode is MIMO Mode.

Test Mode:	TX(5.1G) - 802.11n-HT40
------------	-------------------------

Polar (H/V)	Fre- quency (MHz)	Reading Level (dBuV/m)	Correct Factor (dB)	Measure- ment (dBuV/m)	Limits (dBuV/m)	Over (dB)	Detector Type
Low Channel (5190 MHz)-Above 1G							
Vertical	4434.20	72.50	-20.73	51.77	68.20	-16.43	PK
Vertical	4434.20	59.55	-20.73	38.82	54.00	-15.18	AV
Vertical	10380.17	61.16	-9.33	51.83	68.20	-16.37	PK
Vertical	10380.17	49.49	-9.33	40.16	54.00	-13.84	AV
Vertical	15570.01	61.85	-7.83	54.02	74.00	-19.98	PK
Vertical	15570.01	49.84	-7.83	42.01	54.00	-11.99	AV
Horizontal	4434.10	70.15	-20.73	49.42	74.00	-24.58	PK
Horizontal	4434.10	59.08	-20.73	38.35	54.00	-15.65	AV
Horizontal	10380.20	60.94	-9.33	51.61	68.20	-16.59	PK
Horizontal	10380.20	49.91	-9.33	40.58	54.00	-13.42	AV
Horizontal	15570.14	62.36	-7.83	54.53	74.00	-19.47	PK
Horizontal	15570.14	49.41	-7.83	41.58	54.00	-12.42	AV
High Channel (5230 MHz)-Above 1G							
Vertical	4739.05	71.89	-20.12	51.77	68.20	-16.43	PK
Vertical	4739.05	59.50	-20.12	39.38	54.00	-14.62	AV
Vertical	10460.09	60.90	-9.21	51.69	68.20	-16.51	PK
Vertical	10460.09	49.57	-9.21	40.36	54.00	-13.64	AV
Vertical	15690.06	61.74	-7.79	53.95	74.00	-20.05	PK
Vertical	15690.06	49.89	-7.79	42.10	54.00	-11.90	AV
Horizontal	4739.08	70.10	-20.12	49.98	68.20	-18.22	PK
Horizontal	4739.08	59.42	-20.12	39.30	54.00	-14.70	AV
Horizontal	10460.04	63.58	-9.21	54.37	68.20	-13.83	PK
Horizontal	10460.04	49.86	-9.21	40.65	54.00	-13.35	AV
Horizontal	15690.16	63.85	-7.79	56.06	74.00	-17.94	PK
Horizontal	15690.16	49.38	-7.79	41.59	54.00	-12.41	AV

Note: PK value is lower than the Average value limit, So average didn't record.
 The 26.5-40G amplitude of spurious emissions that are attenuated by more than 20dB below the permissible value has no need to be reported.
 Emission level (dBuV/m) = 20 log Emission level (uV/m).
 Corrected Reading: Antenna Factor + Cable Loss + Read Level - Preamp Factor = Level.
 Test Mode is MIMO Mode.

Test Mode:	TX(5.1G) - 802.11ac-HT20
------------	--------------------------

Polar (H/V)	Fre- quency (MHz)	Reading Level (dBuV/m)	Correct Factor (dB)	Measure- ment (dBuV/m)	Limits (dBuV/m)	Over (dB)	Detector Type
Low Channel (5180 MHz)-Above 1G							
Vertical	4434.05	74.08	-20.73	53.35	68.20	-14.85	PK
Vertical	4434.05	59.82	-20.73	39.09	54.00	-14.91	AV
Vertical	10360.00	60.01	-9.36	50.65	68.20	-17.55	PK
Vertical	10360.00	49.32	-9.36	39.96	54.00	-14.04	AV
Vertical	15540.18	61.53	-7.84	53.69	74.00	-20.31	PK
Vertical	15540.18	49.41	-7.84	41.57	54.00	-12.43	AV
Horizontal	4434.07	70.11	-20.73	49.38	68.20	-18.82	PK
Horizontal	4434.07	59.42	-20.73	38.68	54.00	-15.32	AV
Horizontal	10360.09	61.51	-9.36	52.15	68.20	-16.05	PK
Horizontal	10360.09	49.97	-9.36	40.61	54.00	-13.39	AV
Horizontal	15540.06	60.20	-7.84	52.36	74.00	-21.64	PK
Horizontal	15540.06	49.08	-7.84	41.24	54.00	-12.76	AV
middle Channel (5200 MHz)-Above 1G							
Vertical	4592.04	73.46	-20.42	53.04	74.00	-20.96	PK
Vertical	4592.04	59.03	-20.42	38.61	54.00	-15.39	AV
Vertical	10400.10	61.82	-9.30	52.52	68.20	-15.68	PK
Vertical	10400.10	49.81	-9.30	40.51	54.00	-13.49	AV
Vertical	15600.02	61.47	-7.82	53.65	74.00	-20.35	PK
Vertical	15600.02	49.87	-7.82	42.05	54.00	-11.95	AV
Horizontal	4592.06	71.91	-20.42	51.49	74.00	-22.51	PK
Horizontal	4592.06	59.21	-20.42	38.79	54.00	-15.21	AV
Horizontal	10400.13	62.63	-9.30	53.33	68.20	-14.87	PK
Horizontal	10400.13	49.32	-9.30	40.02	54.00	-13.98	AV
Horizontal	15600.06	64.91	-7.82	57.09	74.00	-16.91	PK
Horizontal	15600.06	49.07	-7.82	41.25	54.00	-12.75	AV
High Channel (5240 MHz)-Above 1G							
Vertical	4739.06	74.83	-20.12	54.71	74.00	-19.29	PK
Vertical	4739.06	59.94	-20.12	39.82	54.00	-14.18	AV
Vertical	10480.17	63.97	-9.18	54.79	68.20	-13.41	PK
Vertical	10480.17	49.23	-9.18	40.05	54.00	-13.95	AV
Vertical	15720.17	63.91	-7.78	56.13	74.00	-17.87	PK
Vertical	15720.17	50.00	-7.78	42.22	54.00	-11.78	AV
Horizontal	4739.16	71.46	-20.12	51.34	74.00	-22.66	PK
Horizontal	4739.16	59.68	-20.12	39.56	54.00	-14.44	AV
Horizontal	10480.11	62.21	-9.18	53.03	68.20	-15.17	PK
Horizontal	10480.11	49.88	-9.18	40.70	54.00	-13.30	AV
Horizontal	15720.00	64.04	-7.78	56.26	74.00	-17.74	PK
Horizontal	15720.00	49.38	-7.78	41.60	54.00	-12.40	AV

Note: PK value is lower than the Average value limit, So average didn't record.
 The 26.5-40G amplitude of spurious emissions that are attenuated by more than 20dB below the permissible value has no need to be reported.
 Emission level (dBuV/m) = 20 log Emission level (uV/m).
 Corrected Reading: Antenna Factor + Cable Loss + Read Level - Preamp Factor = Level.
 Test Mode is MIMO Mode.

Test Mode:	TX(5.1G) - 802.11ac-HT40
------------	--------------------------

Polar (H/V)	Fre- quency (MHz)	Reading Level (dBuV/m)	Correct Factor (dB)	Measure- ment (dBuV/m)	Limits (dBuV/m)	Over (dB)	Detector Type
Low Channel (5190 MHz)-Above 1G							
Vertical	4434.14	74.91	-20.73	54.18	68.20	-14.02	PK
Vertical	4434.14	59.99	-20.73	39.26	54.00	-14.74	AV
Vertical	10380.14	60.18	-9.33	50.85	68.20	-17.35	PK
Vertical	10380.14	49.26	-9.33	39.93	54.00	-14.07	AV
Vertical	15570.04	60.80	-7.83	52.97	74.00	-21.03	PK
Vertical	15570.04	49.25	-7.83	41.42	54.00	-12.58	AV
Horizontal	4434.15	73.91	-20.73	53.18	74.00	-20.82	PK
Horizontal	4434.15	59.94	-20.73	39.21	54.00	-14.79	AV
Horizontal	10380.17	63.37	-9.33	54.04	68.20	-14.16	PK
Horizontal	10380.17	49.90	-9.33	40.57	54.00	-13.43	AV
Horizontal	15570.13	63.66	-7.83	55.83	74.00	-18.17	PK
Horizontal	15570.13	49.27	-7.83	41.44	54.00	-12.56	AV
High Channel (5230 MHz)-Above 1G							
Vertical	4739.09	70.22	-20.12	50.10	68.20	-18.10	PK
Vertical	4739.09	59.28	-20.12	39.15	54.00	-14.85	AV
Vertical	10460.16	60.72	-9.21	51.51	68.20	-16.69	PK
Vertical	10460.16	49.45	-9.21	40.24	54.00	-13.76	AV
Vertical	15690.12	61.22	-7.79	53.43	74.00	-20.57	PK
Vertical	15690.12	49.59	-7.79	41.80	54.00	-12.20	AV
Horizontal	4739.12	72.90	-20.12	52.78	68.20	-15.42	PK
Horizontal	4739.12	59.77	-20.12	39.65	54.00	-14.35	AV
Horizontal	10460.15	61.47	-9.21	52.26	68.20	-15.94	PK
Horizontal	10460.15	49.57	-9.21	40.36	54.00	-13.64	AV
Horizontal	15690.19	61.93	-7.79	54.14	74.00	-19.86	PK
Horizontal	15690.19	49.35	-7.79	41.56	54.00	-12.44	AV

Note: PK value is lower than the Average value limit, So average didn't record.
 The 26.5-40G amplitude of spurious emissions that are attenuated by more than 20dB below the permissible value has no need to be reported.
 Emission level (dBuV/m) = 20 log Emission level (uV/m).
 Corrected Reading: Antenna Factor + Cable Loss + Read Level - Preamp Factor = Level.
 Test Mode is MIMO Mode.

Test Mode:	TX(5.1G) - 802.11ac-HT80
------------	--------------------------

Polar (H/V)	Fre- quency (MHz)	Reading Level (dBuV/m)	Correct Factor (dB)	Measure- ment (dBuV/m)	Limits (dBuV/m)	Over (dB)	Detector Type
(5210 MHz)-Above 1G							
Vertical	4434.08	72.71	-20.73	51.98	68.20	-16.22	PK
Vertical	4434.08	59.79	-20.73	39.06	54.00	-14.94	AV
Vertical	10420.12	60.14	-9.27	50.87	68.20	-17.33	PK
Vertical	10420.12	49.31	-9.27	40.04	54.00	-13.96	AV
Vertical	15630.02	61.75	-7.81	53.94	74.00	-20.06	PK
Vertical	15630.02	49.67	-7.81	41.86	54.00	-12.14	AV
Horizontal	4434.14	72.05	-20.73	51.32	68.20	-16.88	PK
Horizontal	4434.14	49.95	-20.73	29.21	54.00	-24.79	AV
Horizontal	10420.04	42.32	9.27	51.59	68.20	-16.61	PK
Horizontal	10420.04	29.41	9.27	38.68	54.00	-15.32	AV
Horizontal	15630.19	63.73	-7.81	55.92	74.00	-18.08	PK
Horizontal	15630.19	49.65	-7.81	41.84	54.00	-12.16	AV

Note: PK value is lower than the Average value limit, So average didn't record.
 The 26.5-40G amplitude of spurious emissions that are attenuated by more than 20dB below the permissible value has no need to be reported.
 Emission level (dBuV/m) = 20 log Emission level (uV/m).
 Corrected Reading: Antenna Factor + Cable Loss + Read Level - Preamp Factor = Level.
 Test Mode is MIMO Mode.

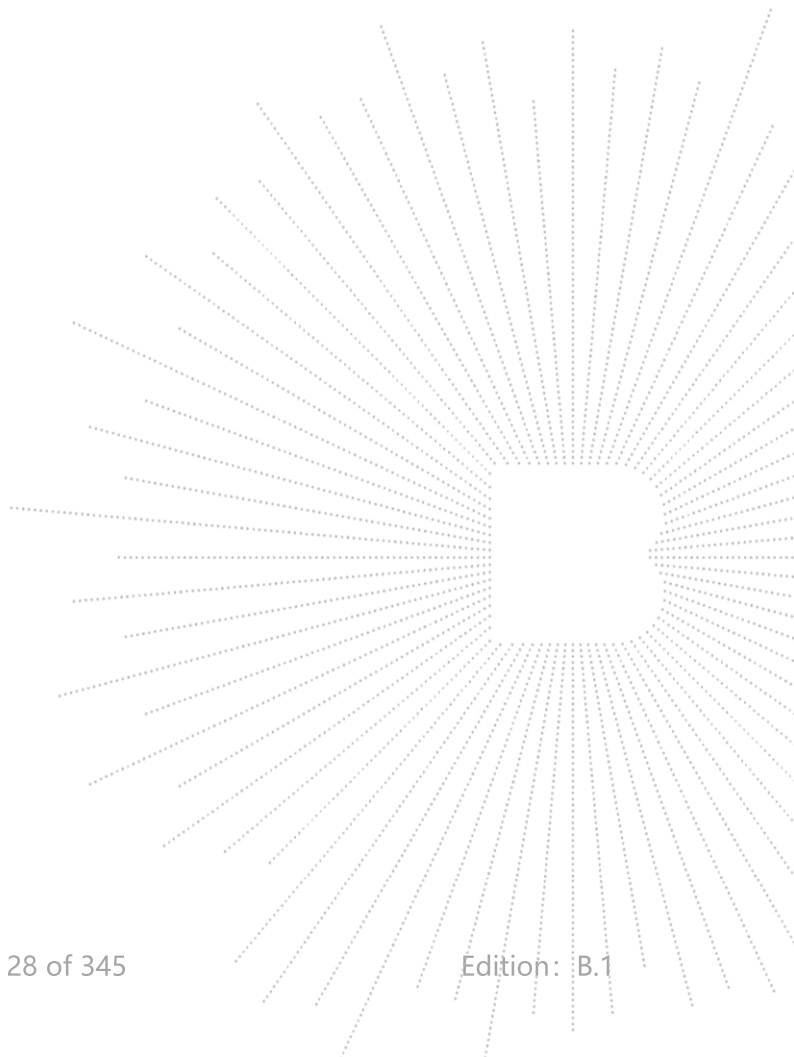

Test Mode:	TX(5.1G) - 802.11ax-HT20
------------	--------------------------

Polar (H/V)	Fre- quency (MHz)	Reading Level (dBuV/m)	Correct Factor (dB)	Measure- ment (dBuV/m)	Limits (dBuV/m)	Over (dB)	Detector Type
Low Channel (5180 MHz)-Above 1G							
Vertical	4434.02	70.25	-20.73	49.52	68.20	-18.68	PK
Vertical	4434.02	59.54	-20.73	38.81	54.00	-15.19	AV
Vertical	10360.09	60.02	-9.36	50.66	68.20	-17.54	PK
Vertical	10360.09	49.62	-9.36	40.26	54.00	-13.74	AV
Vertical	15540.01	61.20	-7.84	53.36	74.00	-20.64	PK
Vertical	15540.01	49.02	-7.84	41.18	54.00	-12.82	AV
Horizontal	4434.15	72.89	-20.73	52.16	68.20	-16.04	PK
Horizontal	4434.15	59.70	-20.73	38.96	54.00	-15.04	AV
Horizontal	10360.08	62.68	-9.36	53.32	68.20	-14.88	PK
Horizontal	10360.08	49.57	-9.36	40.21	54.00	-13.79	AV
Horizontal	15540.18	64.57	-7.84	56.73	74.00	-17.27	PK
Horizontal	15540.18	49.37	-7.84	41.53	54.00	-12.47	AV
middle Channel (5200 MHz)-Above 1G							
Vertical	4592.05	71.50	-20.42	51.09	74.00	-22.91	PK
Vertical	4592.05	59.01	-20.42	38.59	54.00	-15.41	AV
Vertical	10400.14	61.38	-9.30	52.08	68.20	-16.12	PK
Vertical	10400.14	49.81	-9.30	40.51	54.00	-13.49	AV
Vertical	15600.13	63.04	-7.82	55.22	74.00	-18.78	PK
Vertical	15600.13	49.78	-7.82	41.96	54.00	-12.04	AV
Horizontal	4592.05	72.47	-20.42	52.06	74.00	-21.94	PK
Horizontal	4592.05	59.09	-20.42	38.67	54.00	-15.33	AV
Horizontal	10400.06	62.59	-9.30	53.29	68.20	-14.91	PK
Horizontal	10400.06	49.84	-9.30	40.54	54.00	-13.46	AV
Horizontal	15600.06	61.93	-7.82	54.11	74.00	-19.89	PK
Horizontal	15600.06	49.05	-7.82	41.23	54.00	-12.77	AV
High Channel (5240 MHz)-Above 1G							
Vertical	4739.08	70.01	-20.12	49.89	74.00	-24.11	PK
Vertical	4739.08	59.67	-20.12	39.54	54.00	-14.46	AV
Vertical	10480.02	63.46	-9.18	54.28	68.20	-13.92	PK
Vertical	10480.02	49.02	-9.18	39.84	54.00	-14.16	AV
Vertical	15720.16	64.05	-7.78	56.27	74.00	-17.73	PK
Vertical	15720.16	49.87	-7.78	42.09	54.00	-11.91	AV
Horizontal	4739.03	72.70	-20.12	52.58	74.00	-21.42	PK
Horizontal	4739.03	59.13	-20.12	39.01	54.00	-14.99	AV
Horizontal	10480.05	64.06	-9.18	54.88	68.20	-13.32	PK
Horizontal	10480.05	49.33	-9.18	40.15	54.00	-13.85	AV
Horizontal	15720.19	63.07	-7.78	55.29	74.00	-18.71	PK
Horizontal	15720.19	49.19	-7.78	41.41	54.00	-12.59	AV

Note: PK value is lower than the Average value limit, So average didn't record.
 The 26.5-40G amplitude of spurious emissions that are attenuated by more than 20dB below the permissible value has no need to be reported.
 Emission level (dBuV/m) = 20 log Emission level (uV/m).
 Corrected Reading: Antenna Factor + Cable Loss + Read Level - Preamp Factor = Level.
 Test Mode is MIMO Mode.

Test Mode:	TX(5.1G) - 802.11ax-HT40
------------	--------------------------

Polar (H/V)	Fre- quency (MHz)	Reading Level (dBuV/m)	Correct Factor (dB)	Measure- ment (dBuV/m)	Limits (dBuV/m)	Over (dB)	Detector Type
Low Channel (5190 MHz)-Above 1G							
Vertical	4434.20	71.23	-20.73	50.50	68.20	-17.70	PK
Vertical	4434.20	59.46	-20.73	38.73	54.00	-15.27	AV
Vertical	10380.00	62.24	-9.33	52.91	68.20	-15.29	PK
Vertical	10380.00	49.38	-9.33	40.05	54.00	-13.95	AV
Vertical	15570.16	61.66	-7.83	53.83	74.00	-20.17	PK
Vertical	15570.16	49.57	-7.83	41.74	54.00	-12.26	AV
Horizontal	4434.09	70.86	-20.73	50.13	74.00	-23.87	PK
Horizontal	4434.09	59.30	-20.73	38.57	54.00	-15.43	AV
Horizontal	10380.05	64.85	-9.33	55.52	68.20	-12.68	PK
Horizontal	10380.05	49.87	-9.33	40.54	54.00	-13.46	AV
Horizontal	15570.14	64.05	-7.83	56.22	74.00	-17.78	PK
Horizontal	15570.14	49.13	-7.83	41.30	54.00	-12.70	AV
High Channel (5230 MHz)-Above 1G							
Vertical	4739.01	74.13	-20.12	54.00	68.20	-14.20	PK
Vertical	4739.01	59.10	-20.12	38.98	54.00	-15.02	AV
Vertical	10460.12	62.21	-9.21	53.00	68.20	-15.20	PK
Vertical	10460.12	49.77	-9.21	40.56	54.00	-13.44	AV
Vertical	15690.10	63.43	-7.79	55.64	74.00	-18.36	PK
Vertical	15690.10	49.85	-7.79	42.06	54.00	-11.94	AV
Horizontal	4739.18	74.95	-20.12	54.82	68.20	-13.38	PK
Horizontal	4739.18	59.14	-20.12	39.02	54.00	-14.98	AV
Horizontal	10460.10	63.31	-9.21	54.10	68.20	-14.10	PK
Horizontal	10460.10	49.44	-9.21	40.23	54.00	-13.77	AV
Horizontal	15690.08	60.06	-7.79	52.27	74.00	-21.73	PK
Horizontal	15690.08	49.67	-7.79	41.88	54.00	-12.12	AV

Note: PK value is lower than the Average value limit, So average didn't record.
 The 26.5-40G amplitude of spurious emissions that are attenuated by more than 20dB below the permissible value has no need to be reported.
 Emission level (dBuV/m) = 20 log Emission level (uV/m).
 Corrected Reading: Antenna Factor + Cable Loss + Read Level - Preamp Factor = Level.
 Test Mode is MIMO Mode.

Test Mode:	TX(5.1G) - 802.11ax-HT80
------------	--------------------------

Polar (H/V)	Fre- quency (MHz)	Reading Level (dBuV/m)	Correct Factor (dB)	Measure- ment (dBuV/m)	Limits (dBuV/m)	Over (dB)	Detector Type
(5210 MHz)-Above 1G							
Vertical	4434.20	72.81	-20.73	52.07	68.20	-16.13	PK
Vertical	4434.20	59.22	-20.73	38.49	54.00	-15.51	AV
Vertical	10420.02	62.44	-9.27	53.17	68.20	-15.03	PK
Vertical	10420.02	49.24	-9.27	39.97	54.00	-14.03	AV
Vertical	15630.02	62.03	-7.81	54.22	74.00	-19.78	PK
Vertical	15630.02	49.16	-7.81	41.35	54.00	-12.65	AV
Horizontal	4434.16	73.46	-20.73	52.72	68.20	-15.48	PK
Horizontal	4434.16	49.67	-20.73	28.94	54.00	-25.06	AV
Horizontal	10420.01	41.75	9.27	51.02	68.20	-17.18	PK
Horizontal	10420.01	29.85	9.27	39.12	54.00	-14.88	AV
Horizontal	15630.17	61.74	-7.81	53.93	74.00	-20.07	PK
Horizontal	15630.17	49.70	-7.81	41.89	54.00	-12.11	AV

Note: PK value is lower than the Average value limit, So average didn't record.
 The 26.5-40G amplitude of spurious emissions that are attenuated by more than 20dB below the permissible value has no need to be reported.
 Emission level (dBuV/m) = 20 log Emission level (uV/m).
 Corrected Reading: Antenna Factor + Cable Loss + Read Level - Preamp Factor = Level.
 Test Mode is MIMO Mode.

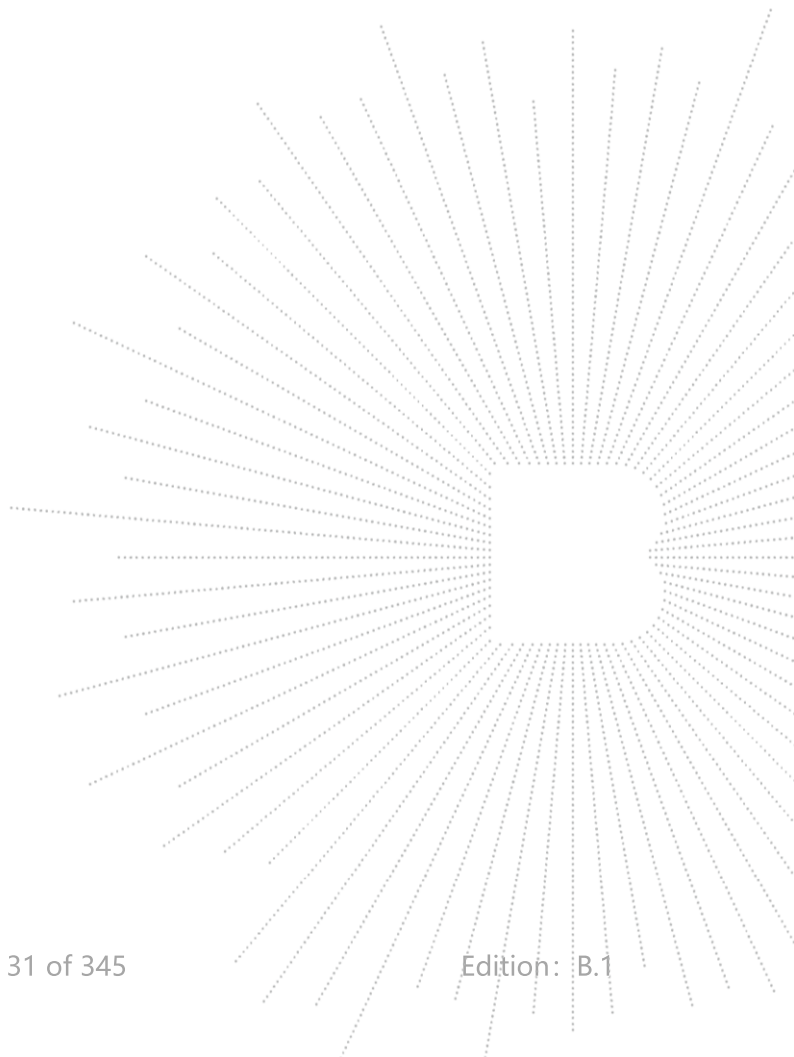

Test Mode:	TX(5.3G) - 802.11a
------------	--------------------

Polar (H/V)	Fre- quency (MHz)	Reading Level (dBuV/m)	Correct Factor (dB)	Measure- ment (dBuV/m)	Limits (dBuV/m)	Over (dB)	Detector Type
Low Channel (5260 MHz)-Above 1G							
Vertical	4434.15	72.77	-20.73	52.04	68.20	-16.16	PK
Vertical	4434.15	59.09	-20.73	38.36	54.00	-15.64	AV
Vertical	10520.08	62.48	-9.12	53.36	68.20	-14.84	PK
Vertical	10520.08	49.03	-9.12	39.91	54.00	-14.09	AV
Vertical	15780.16	64.12	-7.77	56.35	74.00	-17.65	PK
Vertical	15780.16	49.11	-7.77	41.34	54.00	-12.66	AV
Horizontal	4434.13	70.61	-20.73	49.88	68.20	-18.32	PK
Horizontal	4434.13	59.29	-20.73	38.56	54.00	-15.44	AV
Horizontal	10520.10	60.19	-9.12	51.07	68.20	-17.13	PK
Horizontal	10520.10	49.81	-9.12	40.69	54.00	-13.31	AV
Horizontal	15780.12	63.74	-7.77	55.97	74.00	-18.03	PK
Horizontal	15780.12	49.90	-7.77	42.13	54.00	-11.87	AV
middle Channel (5280 MHz)-Above 1G							
Vertical	4592.18	72.38	-20.42	51.97	74.00	-22.03	PK
Vertical	4592.18	59.28	-20.42	38.87	54.00	-15.13	AV
Vertical	10560.04	64.64	-9.06	55.58	68.20	-12.62	PK
Vertical	10560.04	49.81	-9.06	40.75	54.00	-13.25	AV
Vertical	15840.01	60.35	-7.75	52.60	74.00	-21.40	PK
Vertical	15840.01	49.32	-7.75	41.57	54.00	-12.43	AV
Horizontal	4592.07	73.98	-20.42	53.56	74.00	-20.44	PK
Horizontal	4592.07	59.18	-20.42	38.76	54.00	-15.24	AV
Horizontal	10560.13	62.73	-9.06	53.67	68.20	-14.53	PK
Horizontal	10560.13	49.02	-9.06	39.96	54.00	-14.04	AV
Horizontal	15840.05	60.11	-7.75	52.36	74.00	-21.64	PK
Horizontal	15840.05	49.27	-7.75	41.52	54.00	-12.48	AV
High Channel (5320 MHz)-Above 1G							
Vertical	4739.17	70.88	-20.12	50.76	74.00	-23.24	PK
Vertical	4739.17	59.41	-20.12	39.29	54.00	-14.71	AV
Vertical	10640.07	64.91	-8.94	55.97	68.20	-12.23	PK
Vertical	10640.07	49.83	-8.94	40.89	54.00	-13.11	AV
Vertical	15960.12	64.84	-7.71	57.13	74.00	-16.87	PK
Vertical	15960.12	49.88	-7.71	42.17	54.00	-11.83	AV
Horizontal	4739.12	70.35	-20.12	50.23	74.00	-23.77	PK
Horizontal	4739.12	59.64	-20.12	39.52	54.00	-14.48	AV
Horizontal	10640.10	63.91	-8.94	54.97	68.20	-13.23	PK
Horizontal	10640.10	49.83	-8.94	40.89	54.00	-13.11	AV
Horizontal	15960.04	60.44	-7.71	52.73	74.00	-21.27	PK
Horizontal	15960.04	49.03	-7.71	41.32	54.00	-12.68	AV

Note: PK value is lower than the Average value limit, So average didn't record.
 The 26.5-40G amplitude of spurious emissions that are attenuated by more than 20dB below the permissible value has no need to be reported.
 Emission level (dBuV/m) = 20 log Emission level (uV/m).
 Corrected Reading: Antenna Factor + Cable Loss + Read Level - Preamp Factor = Level.
 The worst case is Antenna A.

Test Mode:	TX(5.3G) - 802.11n-HT20
------------	-------------------------

Polar (H/V)	Fre- quency (MHz)	Reading Level (dBuV/m)	Correct Factor (dB)	Measure- ment (dBuV/m)	Limits (dBuV/m)	Over (dB)	Detector Type
Low Channel (5260 MHz)-Above 1G							
Vertical	4434.06	73.53	-20.73	52.79	68.20	-15.41	PK
Vertical	4434.06	59.74	-20.73	39.01	54.00	-14.99	AV
Vertical	10520.08	60.91	-9.12	51.79	68.20	-16.41	PK
Vertical	10520.08	49.94	-9.12	40.82	54.00	-13.18	AV
Vertical	15780.00	64.96	-7.77	57.19	74.00	-16.81	PK
Vertical	15780.00	49.52	-7.77	41.75	54.00	-12.25	AV
Horizontal	4434.03	70.74	-20.73	50.00	68.20	-18.20	PK
Horizontal	4434.03	59.95	-20.73	39.22	54.00	-14.78	AV
Horizontal	10520.15	61.77	-9.12	52.65	68.20	-15.55	PK
Horizontal	10520.15	49.98	-9.12	40.86	54.00	-13.14	AV
Horizontal	15780.20	64.50	-7.77	56.73	74.00	-17.27	PK
Horizontal	15780.20	49.14	-7.77	41.37	54.00	-12.63	AV
middle Channel (5280 MHz)-Above 1G							
Vertical	4592.12	70.71	-20.42	50.30	74.00	-23.70	PK
Vertical	4592.12	59.49	-20.42	39.07	54.00	-14.93	AV
Vertical	10560.14	64.02	-9.06	54.96	68.20	-13.24	PK
Vertical	10560.14	49.31	-9.06	40.25	54.00	-13.75	AV
Vertical	15840.14	64.30	-7.75	56.55	74.00	-17.45	PK
Vertical	15840.14	49.99	-7.75	42.24	54.00	-11.76	AV
Horizontal	4592.00	71.69	-20.42	51.27	74.00	-22.73	PK
Horizontal	4592.00	59.83	-20.42	39.41	54.00	-14.59	AV
Horizontal	10560.12	63.46	-9.06	54.40	68.20	-13.80	PK
Horizontal	10560.12	49.07	-9.06	40.01	54.00	-13.99	AV
Horizontal	15840.19	60.91	-7.75	53.16	74.00	-20.84	PK
Horizontal	15840.19	49.51	-7.75	41.76	54.00	-12.24	AV
High Channel (5320 MHz)-Above 1G							
Vertical	4739.00	72.11	-20.12	51.99	74.00	-22.01	PK
Vertical	4739.00	59.06	-20.12	38.94	54.00	-15.06	AV
Vertical	10640.02	64.53	-8.94	55.59	68.20	-12.61	PK
Vertical	10640.02	49.53	-8.94	40.59	54.00	-13.41	AV
Vertical	15960.11	60.21	-7.71	52.50	74.00	-21.50	PK
Vertical	15960.11	49.38	-7.71	41.67	54.00	-12.33	AV
Horizontal	4739.17	74.86	-20.12	54.74	74.00	-19.26	PK
Horizontal	4739.17	59.21	-20.12	39.08	54.00	-14.92	AV
Horizontal	10640.05	60.55	-8.94	51.61	68.20	-16.59	PK
Horizontal	10640.05	49.91	-8.94	40.97	54.00	-13.03	AV
Horizontal	15960.18	63.76	-7.71	56.05	74.00	-17.95	PK
Horizontal	15960.18	49.57	-7.71	41.86	54.00	-12.14	AV

Note: PK value is lower than the Average value limit, So average didn't record.
 The 26.5-40G amplitude of spurious emissions that are attenuated by more than 20dB below the permissible value has no need to be reported.
 Emission level (dBuV/m) = 20 log Emission level (uV/m).
 Corrected Reading: Antenna Factor + Cable Loss + Read Level - Preamp Factor = Level.
 Test Mode is MIMO Mode.

Test Mode:	TX(5.3G) - 802.11n-HT40
------------	-------------------------

Polar (H/V)	Fre- quency (MHz)	Reading Level (dBuV/m)	Correct Factor (dB)	Measure- ment (dBuV/m)	Limits (dBuV/m)	Over (dB)	Detector Type
Low Channel (5270 MHz)-Above 1G							
Vertical	4434.10	73.28	-20.73	52.55	68.20	-15.65	PK
Vertical	4434.10	59.98	-20.73	39.25	54.00	-14.75	AV
Vertical	10540.17	62.80	-9.09	53.71	68.20	-14.49	PK
Vertical	10540.17	49.99	-9.09	40.90	54.00	-13.10	AV
Vertical	15810.16	61.95	-7.76	54.19	74.00	-19.81	PK
Vertical	15810.16	49.22	-7.76	41.46	54.00	-12.54	AV
Horizontal	4434.17	73.04	-20.73	52.31	74.00	-21.69	PK
Horizontal	4434.17	59.32	-20.73	38.58	54.00	-15.42	AV
Horizontal	10540.20	64.87	-9.09	55.78	68.20	-12.42	PK
Horizontal	10540.20	49.77	-9.09	40.68	54.00	-13.32	AV
Horizontal	15810.05	61.90	-7.76	54.14	74.00	-19.86	PK
Horizontal	15810.05	49.82	-7.76	42.06	54.00	-11.94	AV
High Channel (5310 MHz)-Above 1G							
Vertical	4739.01	71.65	-20.12	51.53	68.20	-16.67	PK
Vertical	4739.01	59.90	-20.12	39.78	54.00	-14.22	AV
Vertical	10620.08	63.51	-8.97	54.54	68.20	-13.66	PK
Vertical	10620.08	49.69	-8.97	40.72	54.00	-13.28	AV
Vertical	15930.08	64.07	-7.72	56.35	74.00	-17.65	PK
Vertical	15930.08	49.77	-7.72	42.05	54.00	-11.95	AV
Horizontal	4739.19	71.87	-20.12	51.75	68.20	-16.45	PK
Horizontal	4739.19	59.31	-20.12	39.19	54.00	-14.81	AV
Horizontal	10620.16	62.58	-8.97	53.61	68.20	-14.59	PK
Horizontal	10620.16	49.56	-8.97	40.59	54.00	-13.41	AV
Horizontal	15930.15	60.45	-7.72	52.73	74.00	-21.27	PK
Horizontal	15930.15	49.73	-7.72	42.01	54.00	-11.99	AV

Note: PK value is lower than the Average value limit, So average didn't record.
 The 26.5-40G amplitude of spurious emissions that are attenuated by more than 20dB below the permissible value has no need to be reported.
 Emission level (dBuV/m) = 20 log Emission level (uV/m).
 Corrected Reading: Antenna Factor + Cable Loss + Read Level - Preamp Factor = Level.
 Test Mode is MIMO Mode.

Test Mode:	TX(5.3G) - 802.11ac-HT20
------------	--------------------------

Polar (H/V)	Fre- quency (MHz)	Reading Level (dBuV/m)	Correct Factor (dB)	Measure- ment (dBuV/m)	Limits (dBuV/m)	Over (dB)	Detector Type
Low Channel (5260 MHz)-Above 1G							
Vertical	4434.12	71.80	-20.73	51.07	68.20	-17.13	PK
Vertical	4434.12	59.52	-20.73	38.78	54.00	-15.22	AV
Vertical	10520.03	62.90	-9.12	53.78	68.20	-14.42	PK
Vertical	10520.03	49.18	-9.12	40.06	54.00	-13.94	AV
Vertical	15780.18	63.51	-7.77	55.74	74.00	-18.26	PK
Vertical	15780.18	49.27	-7.77	41.50	54.00	-12.50	AV
Horizontal	4434.03	73.45	-20.73	52.72	68.20	-15.48	PK
Horizontal	4434.03	59.97	-20.73	39.24	54.00	-14.76	AV
Horizontal	10520.02	64.48	-9.12	55.36	68.20	-12.84	PK
Horizontal	10520.02	49.43	-9.12	40.31	54.00	-13.69	AV
Horizontal	15780.09	61.74	-7.77	53.97	74.00	-20.03	PK
Horizontal	15780.09	49.79	-7.77	42.02	54.00	-11.98	AV
middle Channel (5280 MHz)-Above 1G							
Vertical	4592.17	72.13	-20.42	51.71	74.00	-22.29	PK
Vertical	4592.17	59.40	-20.42	38.98	54.00	-15.02	AV
Vertical	10560.10	64.86	-9.06	55.80	68.20	-12.40	PK
Vertical	10560.10	49.76	-9.06	40.70	54.00	-13.30	AV
Vertical	15840.06	64.63	-7.75	56.88	74.00	-17.12	PK
Vertical	15840.06	49.29	-7.75	41.54	54.00	-12.46	AV
Horizontal	4592.18	70.47	-20.42	50.05	74.00	-23.95	PK
Horizontal	4592.18	59.37	-20.42	38.95	54.00	-15.05	AV
Horizontal	10560.19	60.19	-9.06	51.13	68.20	-17.07	PK
Horizontal	10560.19	49.47	-9.06	40.41	54.00	-13.59	AV
Horizontal	15840.11	61.31	-7.75	53.56	74.00	-20.44	PK
Horizontal	15840.11	49.16	-7.75	41.41	54.00	-12.59	AV
High Channel (5320 MHz)-Above 1G							
Vertical	4739.16	73.87	-20.12	53.75	74.00	-20.25	PK
Vertical	4739.16	59.74	-20.12	39.62	54.00	-14.38	AV
Vertical	10640.18	63.96	-8.94	55.02	68.20	-13.18	PK
Vertical	10640.18	49.63	-8.94	40.69	54.00	-13.31	AV
Vertical	15960.18	63.38	-7.71	55.67	74.00	-18.33	PK
Vertical	15960.18	49.98	-7.71	42.27	54.00	-11.73	AV
Horizontal	4739.07	70.00	-20.12	49.88	74.00	-24.12	PK
Horizontal	4739.07	59.05	-20.12	38.93	54.00	-15.07	AV
Horizontal	10640.08	61.42	-8.94	52.48	68.20	-15.72	PK
Horizontal	10640.08	49.82	-8.94	40.88	54.00	-13.12	AV
Horizontal	15960.06	62.42	-7.71	54.71	74.00	-19.29	PK
Horizontal	15960.06	49.25	-7.71	41.54	54.00	-12.46	AV

Note: PK value is lower than the Average value limit, So average didn't record.
 The 26.5-40G amplitude of spurious emissions that are attenuated by more than 20dB below the permissible value has no need to be reported.
 Emission level (dBuV/m) = 20 log Emission level (uV/m).
 Corrected Reading: Antenna Factor + Cable Loss + Read Level - Preamp Factor = Level.
 Test Mode is MIMO Mode.

Test Mode:	TX(5.3G) - 802.11ac-HT40
------------	--------------------------

Polar (H/V)	Fre- quency (MHz)	Reading Level (dBuV/m)	Correct Factor (dB)	Measure- ment (dBuV/m)	Limits (dBuV/m)	Over (dB)	Detector Type
Low Channel (5270 MHz)-Above 1G							
Vertical	4434.07	74.06	-20.73	53.33	68.20	-14.87	PK
Vertical	4434.07	59.15	-20.73	38.41	54.00	-15.59	AV
Vertical	10540.01	63.50	-9.09	54.41	68.20	-13.79	PK
Vertical	10540.01	49.28	-9.09	40.19	54.00	-13.81	AV
Vertical	15810.17	63.87	-7.76	56.11	74.00	-17.89	PK
Vertical	15810.17	49.78	-7.76	42.02	54.00	-11.98	AV
Horizontal	4434.05	70.23	-20.73	49.50	74.00	-24.50	PK
Horizontal	4434.05	59.37	-20.73	38.64	54.00	-15.36	AV
Horizontal	10540.10	60.08	-9.09	50.99	68.20	-17.21	PK
Horizontal	10540.10	49.32	-9.09	40.23	54.00	-13.77	AV
Horizontal	15810.00	60.63	-7.76	52.87	74.00	-21.13	PK
Horizontal	15810.00	49.62	-7.76	41.86	54.00	-12.14	AV
High Channel (5310 MHz)-Above 1G							
Vertical	4739.08	74.63	-20.12	54.51	68.20	-13.69	PK
Vertical	4739.08	59.71	-20.12	39.59	54.00	-14.41	AV
Vertical	10620.18	60.33	-8.97	51.36	68.20	-16.84	PK
Vertical	10620.18	49.14	-8.97	40.17	54.00	-13.83	AV
Vertical	15930.01	61.60	-7.72	53.88	74.00	-20.12	PK
Vertical	15930.01	49.32	-7.72	41.60	54.00	-12.40	AV
Horizontal	4739.00	71.43	-20.12	51.31	68.20	-16.89	PK
Horizontal	4739.00	59.17	-20.12	39.05	54.00	-14.95	AV
Horizontal	10620.10	64.13	-8.97	55.16	68.20	-13.04	PK
Horizontal	10620.10	49.45	-8.97	40.48	54.00	-13.52	AV
Horizontal	15930.05	64.65	-7.72	56.93	74.00	-17.07	PK
Horizontal	15930.05	49.50	-7.72	41.78	54.00	-12.22	AV

Note: PK value is lower than the Average value limit, So average didn't record.
 The 26.5-40G amplitude of spurious emissions that are attenuated by more than 20dB below the permissible value has no need to be reported.
 Emission level (dBuV/m) = 20 log Emission level (uV/m).
 Corrected Reading: Antenna Factor + Cable Loss + Read Level - Preamp Factor = Level.
 Test Mode is MIMO Mode.

Test Mode:	TX(5.3G) - 802.11ac-HT80
------------	--------------------------

Polar (H/V)	Fre- quency (MHz)	Reading Level (dBuV/m)	Correct Factor (dB)	Measure- ment (dBuV/m)	Limits (dBuV/m)	Over (dB)	Detector Type
(5290 MHz)-Above 1G							
Vertical	4434.05	71.02	-20.73	50.28	68.20	-17.92	PK
Vertical	4434.05	59.68	-20.73	38.94	54.00	-15.06	AV
Vertical	10580.13	62.83	-9.03	53.80	68.20	-14.40	PK
Vertical	10580.13	49.18	-9.03	40.15	54.00	-13.85	AV
Vertical	15870.08	61.21	-7.74	53.47	74.00	-20.53	PK
Vertical	15870.08	49.15	-7.74	41.41	54.00	-12.59	AV
Horizontal	4434.16	72.13	-20.73	51.40	68.20	-16.80	PK
Horizontal	4434.16	59.26	-20.73	38.52	54.00	-15.48	AV
Horizontal	10580.13	64.38	-9.03	55.35	68.20	-12.85	PK
Horizontal	10580.13	49.91	-9.03	40.88	54.00	-13.12	AV
Horizontal	15870.03	60.74	-7.74	53.00	74.00	-21.00	PK
Horizontal	15870.03	49.31	-7.74	41.57	54.00	-12.43	AV

Note: PK value is lower than the Average value limit, So average didn't record.
 The 26.5-40G amplitude of spurious emissions that are attenuated by more than 20dB below the permissible value has no need to be reported.
 Emission level (dBuV/m) = 20 log Emission level (uV/m).
 Corrected Reading: Antenna Factor + Cable Loss + Read Level - Preamp Factor = Level.
 Test Mode is MIMO Mode.

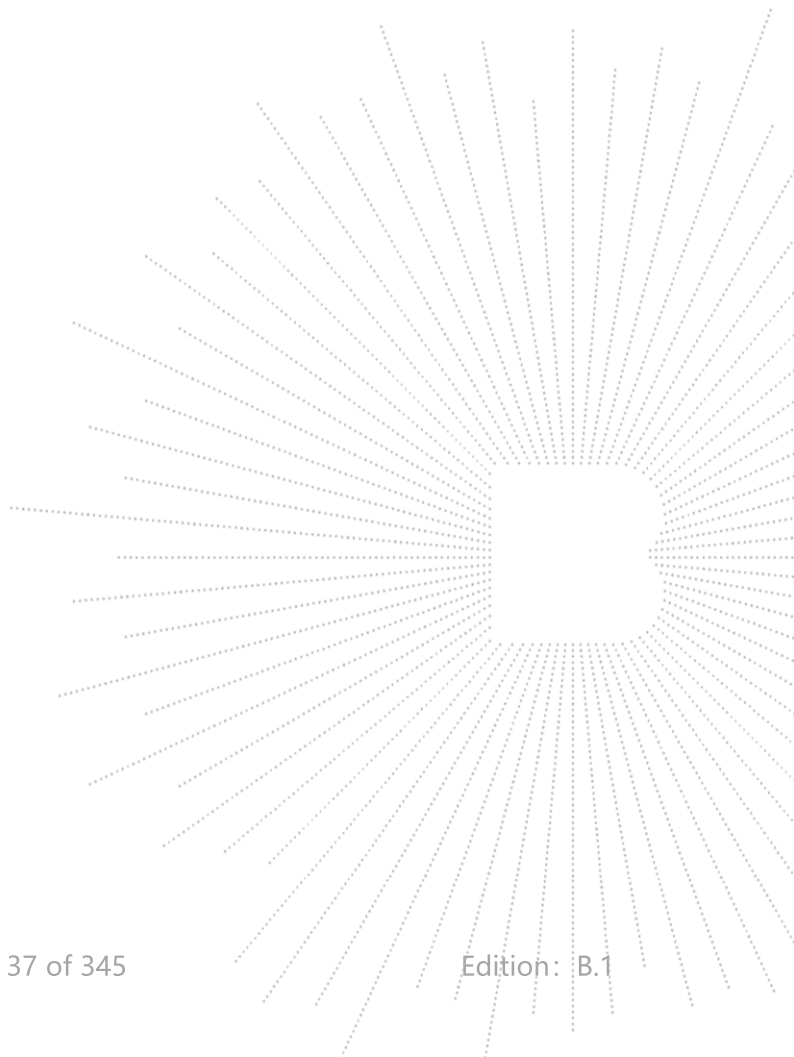

Test Mode:	TX(5.3G) - 802.11ax-HT20
------------	--------------------------

Polar (H/V)	Fre- quency (MHz)	Reading Level (dBuV/m)	Correct Factor (dB)	Measure- ment (dBuV/m)	Limits (dBuV/m)	Over (dB)	Detector Type
Low Channel (5260 MHz)-Above 1G							
Vertical	4434.03	70.39	-20.73	49.65	68.20	-18.55	PK
Vertical	4434.03	59.09	-20.73	38.36	54.00	-15.64	AV
Vertical	10520.14	60.24	-9.12	51.12	68.20	-17.08	PK
Vertical	10520.14	49.94	-9.12	40.82	54.00	-13.18	AV
Vertical	15780.02	64.60	-7.77	56.83	74.00	-17.17	PK
Vertical	15780.02	49.39	-7.77	41.62	54.00	-12.38	AV
Horizontal	4434.04	72.74	-20.73	52.00	68.20	-16.20	PK
Horizontal	4434.04	59.58	-20.73	38.85	54.00	-15.15	AV
Horizontal	10520.01	61.81	-9.12	52.69	68.20	-15.51	PK
Horizontal	10520.01	49.85	-9.12	40.73	54.00	-13.27	AV
Horizontal	15780.20	63.19	-7.77	55.42	74.00	-18.58	PK
Horizontal	15780.20	49.79	-7.77	42.02	54.00	-11.98	AV
middle Channel (5280 MHz)-Above 1G							
Vertical	4592.14	71.89	-20.42	51.48	74.00	-22.52	PK
Vertical	4592.14	59.22	-20.42	38.80	54.00	-15.20	AV
Vertical	10560.08	62.42	-9.06	53.36	68.20	-14.84	PK
Vertical	10560.08	49.11	-9.06	40.05	54.00	-13.95	AV
Vertical	15840.07	64.46	-7.75	56.71	74.00	-17.29	PK
Vertical	15840.07	49.73	-7.75	41.98	54.00	-12.02	AV
Horizontal	4592.04	74.52	-20.42	54.10	74.00	-19.90	PK
Horizontal	4592.04	59.90	-20.42	39.48	54.00	-14.52	AV
Horizontal	10560.03	62.59	-9.06	53.53	68.20	-14.67	PK
Horizontal	10560.03	49.90	-9.06	40.84	54.00	-13.16	AV
Horizontal	15840.07	60.43	-7.75	52.68	74.00	-21.32	PK
Horizontal	15840.07	49.79	-7.75	42.04	54.00	-11.96	AV
High Channel (5320 MHz)-Above 1G							
Vertical	4739.10	74.40	-20.12	54.28	74.00	-19.72	PK
Vertical	4739.10	59.37	-20.12	39.25	54.00	-14.75	AV
Vertical	10640.13	63.85	-8.94	54.91	68.20	-13.29	PK
Vertical	10640.13	49.67	-8.94	40.73	54.00	-13.27	AV
Vertical	15960.03	60.86	-7.71	53.15	74.00	-20.85	PK
Vertical	15960.03	49.75	-7.71	42.04	54.00	-11.96	AV
Horizontal	4739.17	71.24	-20.12	51.12	74.00	-22.88	PK
Horizontal	4739.17	59.01	-20.12	38.89	54.00	-15.11	AV
Horizontal	10640.16	60.46	-8.94	51.52	68.20	-16.68	PK
Horizontal	10640.16	49.36	-8.94	40.42	54.00	-13.58	AV
Horizontal	15960.18	61.75	-7.71	54.04	74.00	-19.96	PK
Horizontal	15960.18	49.69	-7.71	41.98	54.00	-12.02	AV

Note: PK value is lower than the Average value limit, So average didn't record.
 The 26.5-40G amplitude of spurious emissions that are attenuated by more than 20dB below the permissible value has no need to be reported.
 Emission level (dBuV/m) = 20 log Emission level (uV/m).
 Corrected Reading: Antenna Factor + Cable Loss + Read Level - Preamp Factor = Level.
 Test Mode is MIMO Mode.

Test Mode:	TX(5.3G) - 802.11ax-HT40
------------	--------------------------

Polar (H/V)	Fre- quency (MHz)	Reading Level (dBuV/m)	Correct Factor (dB)	Measure- ment (dBuV/m)	Limits (dBuV/m)	Over (dB)	Detector Type
Low Channel (5270 MHz)-Above 1G							
Vertical	4434.06	72.00	-20.73	51.27	68.20	-16.93	PK
Vertical	4434.06	59.88	-20.73	39.15	54.00	-14.85	AV
Vertical	10540.13	63.37	-9.09	54.28	68.20	-13.92	PK
Vertical	10540.13	49.24	-9.09	40.15	54.00	-13.85	AV
Vertical	15810.14	60.78	-7.76	53.02	74.00	-20.98	PK
Vertical	15810.14	49.38	-7.76	41.62	54.00	-12.38	AV
Horizontal	4434.04	73.90	-20.73	53.17	74.00	-20.83	PK
Horizontal	4434.04	59.95	-20.73	39.22	54.00	-14.78	AV
Horizontal	10540.04	61.49	-9.09	52.40	68.20	-15.80	PK
Horizontal	10540.04	49.97	-9.09	40.88	54.00	-13.12	AV
Horizontal	15810.02	60.30	-7.76	52.54	74.00	-21.46	PK
Horizontal	15810.02	49.50	-7.76	41.74	54.00	-12.26	AV
High Channel (5310 MHz)-Above 1G							
Vertical	4739.18	70.13	-20.12	50.01	68.20	-18.19	PK
Vertical	4739.18	59.71	-20.12	39.59	54.00	-14.41	AV
Vertical	10620.11	63.31	-8.97	54.34	68.20	-13.86	PK
Vertical	10620.11	49.36	-8.97	40.39	54.00	-13.61	AV
Vertical	15930.07	60.19	-7.72	52.47	74.00	-21.53	PK
Vertical	15930.07	49.46	-7.72	41.74	54.00	-12.26	AV
Horizontal	4739.02	70.96	-20.12	50.84	68.20	-17.36	PK
Horizontal	4739.02	59.36	-20.12	39.23	54.00	-14.77	AV
Horizontal	10620.13	64.03	-8.97	55.06	68.20	-13.14	PK
Horizontal	10620.13	49.80	-8.97	40.83	54.00	-13.17	AV
Horizontal	15930.16	63.49	-7.72	55.77	74.00	-18.23	PK
Horizontal	15930.16	49.39	-7.72	41.67	54.00	-12.33	AV

Note: PK value is lower than the Average value limit, So average didn't record.
 The 26.5-40G amplitude of spurious emissions that are attenuated by more than 20dB below the permissible value has no need to be reported.
 Emission level (dBuV/m) = 20 log Emission level (uV/m).
 Corrected Reading: Antenna Factor + Cable Loss + Read Level - Preamp Factor = Level.
 Test Mode is MIMO Mode.

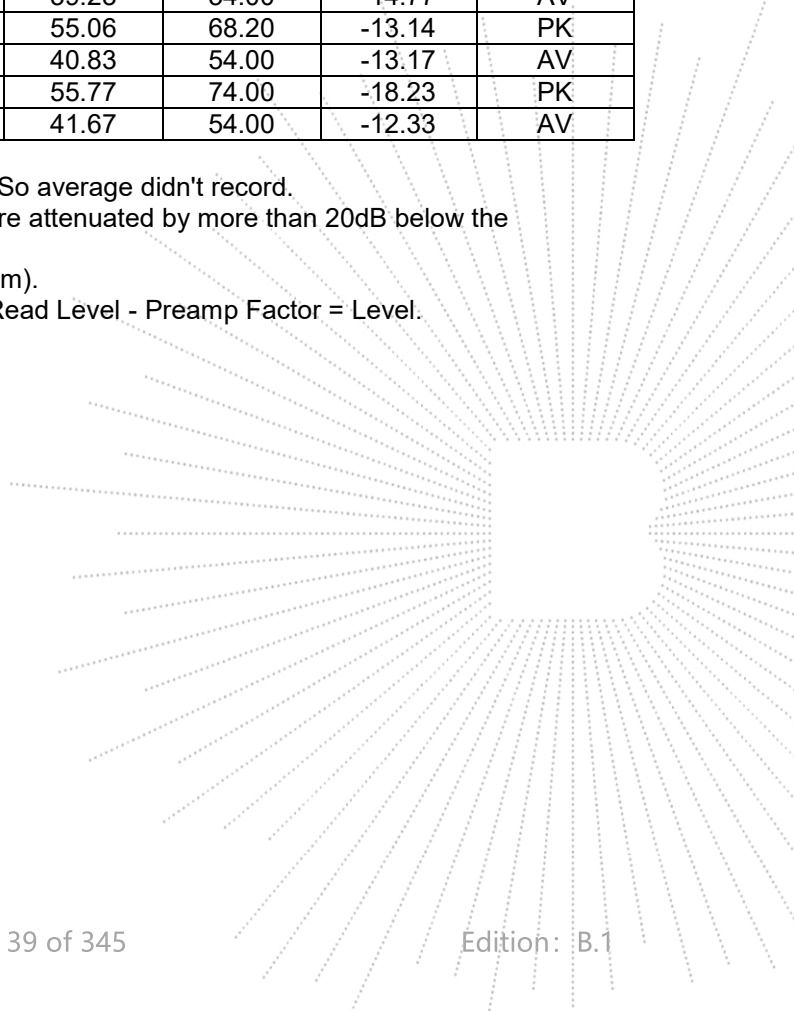

Test Mode:	TX(5.3G) - 802.11axn-HT80
------------	---------------------------

Polar (H/V)	Fre- quency (MHz)	Reading Level (dBuV/m)	Correct Factor (dB)	Measure- ment (dBuV/m)	Limits (dBuV/m)	Over (dB)	Detector Type
(5290 MHz)-Above 1G							
Vertical	4434.06	70.44	-20.73	49.71	68.20	-18.49	PK
Vertical	4434.06	59.94	-20.73	39.21	54.00	-14.79	AV
Vertical	10580.10	63.98	-9.03	54.95	68.20	-13.25	PK
Vertical	10580.10	49.22	-9.03	40.19	54.00	-13.81	AV
Vertical	15870.12	63.86	-7.74	56.12	74.00	-17.88	PK
Vertical	15870.12	49.78	-7.74	42.04	54.00	-11.96	AV
Horizontal	4434.02	72.19	-20.73	51.46	68.20	-16.74	PK
Horizontal	4434.02	59.41	-20.73	38.68	54.00	-15.32	AV
Horizontal	10580.11	64.14	-9.03	55.11	68.20	-13.09	PK
Horizontal	10580.11	49.45	-9.03	40.42	54.00	-13.58	AV
Horizontal	15870.18	62.48	-7.74	54.74	74.00	-19.26	PK
Horizontal	15870.18	49.16	-7.74	41.42	54.00	-12.58	AV

Note: PK value is lower than the Average value limit, So average didn't record.
 The 26.5-40G amplitude of spurious emissions that are attenuated by more than 20dB below the permissible value has no need to be reported.
 Emission level (dBuV/m) = 20 log Emission level (uV/m).
 Corrected Reading: Antenna Factor + Cable Loss + Read Level - Preamp Factor = Level.
 Test Mode is MIMO Mode.

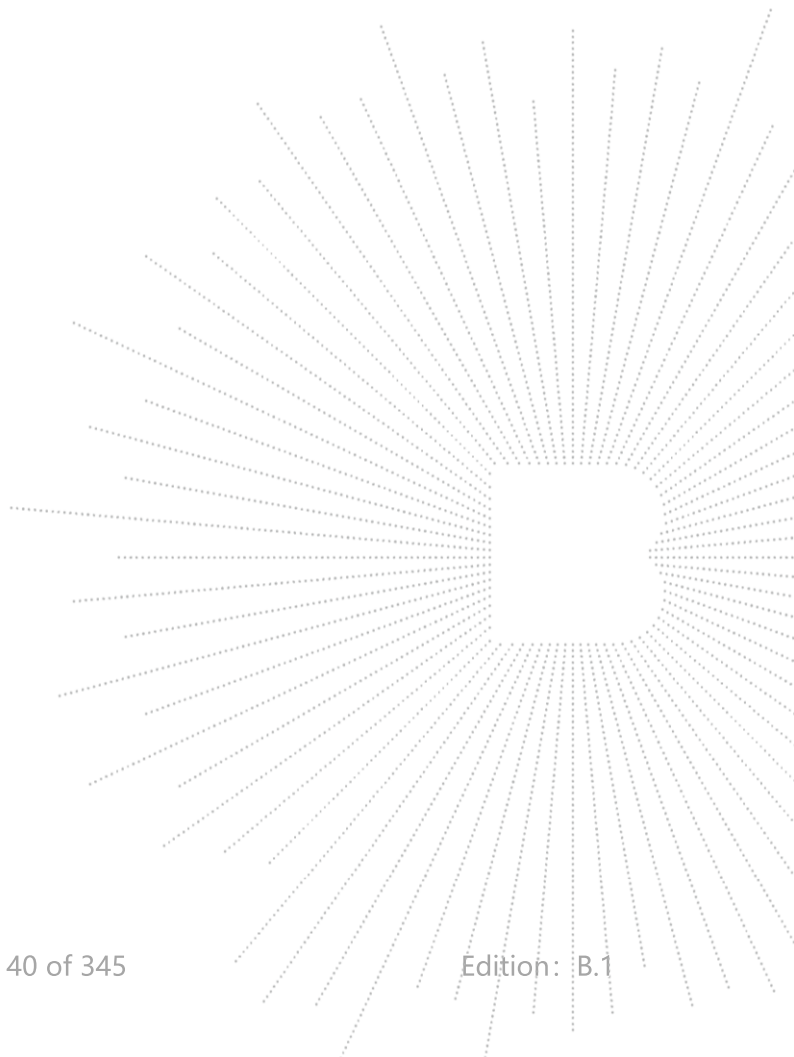

Test Mode:	TX(5.6G) - 802.11a
------------	--------------------

Polar (H/V)	Fre- quency (MHz)	Reading Level (dBuV/m)	Correct Factor (dB)	Measure- ment (dBuV/m)	Limits (dBuV/m)	Over (dB)	Detector Type
Low Channel (5500 MHz)-Above 1G							
Vertical	4434.12	72.46	-20.73	51.73	68.20	-16.47	PK
Vertical	4434.12	59.83	-20.73	39.10	54.00	-14.90	AV
Vertical	11000.09	60.76	-8.40	52.36	68.20	-15.84	PK
Vertical	11000.09	49.67	-8.40	41.27	54.00	-12.73	AV
Vertical	16500.07	63.41	-6.09	57.32	74.00	-16.68	PK
Vertical	16500.07	49.77	-6.09	43.68	54.00	-10.32	AV
Horizontal	4434.02	70.51	-20.73	49.78	68.20	-18.42	PK
Horizontal	4434.02	59.07	-20.73	38.34	54.00	-15.66	AV
Horizontal	11000.11	61.03	-8.40	52.63	68.20	-15.57	PK
Horizontal	11000.11	49.58	-8.40	41.18	54.00	-12.82	AV
Horizontal	16500.08	63.14	-6.09	57.05	74.00	-16.95	PK
Horizontal	16500.08	49.50	-6.09	43.41	54.00	-10.59	AV
middle Channel (5580 MHz)-Above 1G							
Vertical	4592.17	70.57	-20.42	50.15	74.00	-23.85	PK
Vertical	4592.17	59.55	-20.42	39.13	54.00	-14.87	AV
Vertical	11160.02	62.15	-8.53	53.62	68.20	-14.58	PK
Vertical	11160.02	49.35	-8.53	40.82	54.00	-13.18	AV
Vertical	16740.06	64.84	-5.31	59.53	74.00	-14.47	PK
Vertical	16740.06	49.69	-5.31	44.38	54.00	-9.62	AV
Horizontal	4592.10	71.15	-20.42	50.74	74.00	-23.26	PK
Horizontal	4592.10	59.90	-20.42	39.48	54.00	-14.52	AV
Horizontal	11160.00	60.69	-8.53	52.16	68.20	-16.04	PK
Horizontal	11160.00	49.72	-8.53	41.19	54.00	-12.81	AV
Horizontal	16740.10	63.70	-5.31	58.39	74.00	-15.61	PK
Horizontal	16740.10	49.94	-5.31	44.63	54.00	-9.37	AV
High Channel (5700 MHz)-Above 1G							
Vertical	4739.01	70.34	-20.12	50.22	74.00	-23.78	PK
Vertical	4739.01	59.28	-20.12	39.16	54.00	-14.84	AV
Vertical	11400.17	62.41	-8.72	53.69	68.20	-14.51	PK
Vertical	11400.17	49.16	-8.72	40.44	54.00	-13.56	AV
Vertical	17100.01	61.88	-3.92	57.96	74.00	-16.04	PK
Vertical	17100.01	49.36	-3.92	45.44	54.00	-8.56	AV
Horizontal	4739.15	71.27	-20.12	51.15	74.00	-22.85	PK
Horizontal	4739.15	59.97	-20.12	39.85	54.00	-14.15	AV
Horizontal	11400.13	63.95	-8.72	55.23	68.20	-12.97	PK
Horizontal	11400.13	49.29	-8.72	40.57	54.00	-13.43	AV
Horizontal	17100.11	62.89	-3.92	58.97	74.00	-15.03	PK
Horizontal	17100.11	49.29	-3.92	45.37	54.00	-8.63	AV

Note: PK value is lower than the Average value limit, So average didn't record.
 The 26.5-40G amplitude of spurious emissions that are attenuated by more than 20dB below the permissible value has no need to be reported.
 Emission level (dBuV/m) = 20 log Emission level (uV/m).
 Corrected Reading: Antenna Factor + Cable Loss + Read Level - Preamp Factor = Level.
 The worst case is Antenna A.

Test Mode:	TX(5.6G) - 802.11n-HT20
------------	-------------------------

Polar (H/V)	Fre- quency (MHz)	Reading Level (dBuV/m)	Correct Factor (dB)	Measure- ment (dBuV/m)	Limits (dBuV/m)	Over (dB)	Detector Type
Low Channel (5500 MHz)-Above 1G							
Vertical	4434.12	74.32	-20.73	53.59	68.20	-14.61	PK
Vertical	4434.12	59.47	-20.73	38.74	54.00	-15.26	AV
Vertical	11000.05	64.40	-8.40	56.00	68.20	-12.20	PK
Vertical	11000.05	49.44	-8.40	41.04	54.00	-12.96	AV
Vertical	16500.03	62.44	-6.09	56.35	74.00	-17.65	PK
Vertical	16500.03	49.95	-6.09	43.86	54.00	-10.14	AV
Horizontal	4434.14	73.24	-20.73	52.50	68.20	-15.70	PK
Horizontal	4434.14	59.65	-20.73	38.92	54.00	-15.08	AV
Horizontal	11000.03	61.16	-8.40	52.76	68.20	-15.44	PK
Horizontal	11000.03	49.16	-8.40	40.76	54.00	-13.24	AV
Horizontal	16500.05	64.47	-6.09	58.38	74.00	-15.62	PK
Horizontal	16500.05	50.00	-6.09	43.91	54.00	-10.09	AV
middle Channel (5580 MHz)-Above 1G							
Vertical	4592.15	71.13	-20.42	50.71	74.00	-23.29	PK
Vertical	4592.15	59.85	-20.42	39.44	54.00	-14.56	AV
Vertical	11160.03	60.58	-8.53	52.05	68.20	-16.15	PK
Vertical	11160.03	49.89	-8.53	41.36	54.00	-12.64	AV
Vertical	16740.15	62.21	-5.31	56.90	74.00	-17.10	PK
Vertical	16740.15	49.05	-5.31	43.74	54.00	-10.26	AV
Horizontal	4592.07	70.18	-20.42	49.77	74.00	-24.23	PK
Horizontal	4592.07	59.54	-20.42	39.13	54.00	-14.87	AV
Horizontal	11160.09	62.87	-8.53	54.34	68.20	-13.86	PK
Horizontal	11160.09	49.58	-8.53	41.05	54.00	-12.95	AV
Horizontal	16740.14	63.37	-5.31	58.06	74.00	-15.94	PK
Horizontal	16740.14	49.11	-5.31	43.80	54.00	-10.20	AV
High Channel (5700 MHz)-Above 1G							
Vertical	4739.17	71.65	-20.12	51.53	74.00	-22.47	PK
Vertical	4739.17	59.05	-20.12	38.93	54.00	-15.07	AV
Vertical	11400.12	64.98	-8.72	56.26	68.20	-11.94	PK
Vertical	11400.12	49.12	-8.72	40.40	54.00	-13.60	AV
Vertical	17100.12	64.94	-3.92	61.02	74.00	-12.98	PK
Vertical	17100.12	49.77	-3.92	45.85	54.00	-8.15	AV
Horizontal	4739.05	70.32	-20.12	50.19	74.00	-23.81	PK
Horizontal	4739.05	59.48	-20.12	39.36	54.00	-14.64	AV
Horizontal	11400.14	61.77	-8.72	53.05	68.20	-15.15	PK
Horizontal	11400.14	49.54	-8.72	40.82	54.00	-13.18	AV
Horizontal	17100.13	60.48	-3.92	56.56	74.00	-17.44	PK
Horizontal	17100.13	49.37	-3.92	45.45	54.00	-8.55	AV

Note: PK value is lower than the Average value limit, So average didn't record.
 The 26.5-40G amplitude of spurious emissions that are attenuated by more than 20dB below the permissible value has no need to be reported.
 Emission level (dBuV/m) = 20 log Emission level (uV/m).
 Corrected Reading: Antenna Factor + Cable Loss + Read Level - Preamp Factor = Level.
 Test Mode is MIMO Mode.

Test Mode:	TX(5.6G) - 802.11n-HT40
------------	-------------------------

Polar (H/V)	Fre- quency (MHz)	Reading Level (dBuV/m)	Correct Factor (dB)	Measure- ment (dBuV/m)	Limits (dBuV/m)	Over (dB)	Detector Type
Low Channel (5510 MHz)-Above 1G							
Vertical	4434.09	61.70	-20.73	40.96	68.20	-27.24	PK
Vertical	4434.09	43.03	-20.73	22.29	54.00	-31.71	AV
Vertical	11020.02	61.48	-8.42	53.06	68.20	-15.14	PK
Vertical	11020.02	43.84	-8.42	35.42	54.00	-18.58	AV
Vertical	16530.08	61.18	-5.99	55.19	74.00	-18.81	PK
Vertical	16530.08	43.55	-5.99	37.56	54.00	-16.44	AV
Horizontal	4434.08	64.97	-20.73	44.23	74.00	-29.77	PK
Horizontal	4434.08	43.74	-20.73	23.01	54.00	-30.99	AV
Horizontal	11020.04	50.40	-8.42	41.98	68.20	-26.22	PK
Horizontal	11020.04	42.59	-8.42	34.17	54.00	-19.83	AV
Horizontal	16530.04	54.60	-5.99	48.61	74.00	-25.39	PK
Horizontal	16530.04	40.47	-5.99	34.48	54.00	-19.52	AV
middle Channel (5550 MHz)-Above 1G							
Vertical	4592.18	63.88	-20.42	43.46	74.00	-30.54	PK
Vertical	4592.18	43.35	-20.42	22.93	54.00	-31.07	AV
Vertical	11100.01	63.25	-8.40	54.85	68.20	-13.35	PK
Vertical	11100.01	43.06	-8.40	34.66	54.00	-19.34	AV
Vertical	16650.09	62.84	-5.60	57.24	74.00	-16.76	PK
Vertical	16650.09	43.44	-5.60	37.84	54.00	-16.16	AV
Horizontal	4592.12	60.48	-20.42	40.06	74.00	-33.94	PK
Horizontal	4592.12	43.61	-20.42	23.19	54.00	-30.81	AV
Horizontal	11100.15	50.32	-8.40	41.92	68.20	-26.28	PK
Horizontal	11100.15	43.47	-8.40	35.07	54.00	-18.93	AV
Horizontal	16650.08	52.51	-5.60	46.91	74.00	-27.09	PK
Horizontal	16650.08	44.66	-5.60	39.06	54.00	-14.94	AV
High Channel (5670 MHz)-Above 1G							
Vertical	4739.02	63.75	-20.12	43.63	68.20	-24.57	PK
Vertical	4739.02	43.33	-20.12	23.21	54.00	-30.79	AV
Vertical	11340.01	60.91	-8.67	52.24	68.20	-15.96	PK
Vertical	11340.01	43.37	-8.67	34.70	54.00	-19.30	AV
Vertical	17010.00	62.95	-4.41	58.54	74.00	-15.46	PK
Vertical	17010.00	43.59	-4.41	39.18	54.00	-14.82	AV
Horizontal	4739.01	62.13	-20.12	42.00	68.20	-26.20	PK
Horizontal	4739.01	43.45	-20.12	23.33	54.00	-30.67	AV
Horizontal	11340.13	50.94	-8.67	42.27	68.20	-25.93	PK
Horizontal	11340.13	41.76	-8.67	33.09	54.00	-20.91	AV
Horizontal	17010.06	53.42	-4.41	49.01	74.00	-24.99	PK
Horizontal	17010.06	43.30	-4.41	38.89	54.00	-15.11	AV

Note: PK value is lower than the Average value limit, So average didn't record.
 The 26.5-40G amplitude of spurious emissions that are attenuated by more than 20dB below the permissible value has no need to be reported.
 Emission level (dBuV/m) = 20 log Emission level (uV/m).
 Corrected Reading: Antenna Factor + Cable Loss + Read Level - Preamp Factor = Level.
 Test Mode is MIMO Mode.

Test Mode:	TX(5.6G) - 802.11ac-HT20
------------	--------------------------

Polar (H/V)	Fre- quency (MHz)	Reading Level (dBuV/m)	Correct Factor (dB)	Measure- ment (dBuV/m)	Limits (dBuV/m)	Over (dB)	Detector Type
Low Channel (5500 MHz)-Above 1G							
Vertical	4434.06	70.23	-20.73	49.49	68.20	-18.71	PK
Vertical	4434.06	59.65	-20.73	38.92	54.00	-15.08	AV
Vertical	11000.05	61.75	-8.40	53.35	68.20	-14.85	PK
Vertical	11000.05	49.45	-8.40	41.05	54.00	-12.95	AV
Vertical	16500.13	60.07	-6.09	53.98	74.00	-20.02	PK
Vertical	16500.13	49.06	-6.09	42.97	54.00	-11.03	AV
Horizontal	4434.19	71.08	-20.73	50.35	68.20	-17.85	PK
Horizontal	4434.19	59.93	-20.73	39.20	54.00	-14.80	AV
Horizontal	11000.01	64.55	-8.40	56.15	68.20	-12.05	PK
Horizontal	11000.01	49.63	-8.40	41.23	54.00	-12.77	AV
Horizontal	16500.02	60.19	-6.09	54.10	74.00	-19.90	PK
Horizontal	16500.02	49.78	-6.09	43.69	54.00	-10.31	AV
middle Channel (5580 MHz)-Above 1G							
Vertical	4592.10	73.63	-20.42	53.21	74.00	-20.79	PK
Vertical	4592.10	59.87	-20.42	39.46	54.00	-14.54	AV
Vertical	11160.10	61.52	-8.53	52.99	68.20	-15.21	PK
Vertical	11160.10	49.78	-8.53	41.25	54.00	-12.75	AV
Vertical	16740.02	60.84	-5.31	55.53	74.00	-18.47	PK
Vertical	16740.02	49.69	-5.31	44.38	54.00	-9.62	AV
Horizontal	4592.01	70.19	-20.42	49.77	74.00	-24.23	PK
Horizontal	4592.01	59.95	-20.42	39.54	54.00	-14.46	AV
Horizontal	11160.05	64.88	-8.53	56.35	68.20	-11.85	PK
Horizontal	11160.05	49.99	-8.53	41.46	54.00	-12.54	AV
Horizontal	16740.05	62.23	-5.31	56.92	74.00	-17.08	PK
Horizontal	16740.05	49.80	-5.31	44.49	54.00	-9.51	AV
High Channel (5700 MHz)-Above 1G							
Vertical	4739.17	72.93	-20.12	52.81	74.00	-21.19	PK
Vertical	4739.17	59.73	-20.12	39.60	54.00	-14.40	AV
Vertical	11400.01	60.38	-8.72	51.66	68.20	-16.54	PK
Vertical	11400.01	49.57	-8.72	40.85	54.00	-13.15	AV
Vertical	17100.10	63.29	-3.92	59.37	74.00	-14.63	PK
Vertical	17100.10	49.92	-3.92	46.00	54.00	-8.00	AV
Horizontal	4739.07	71.28	-20.12	51.16	74.00	-22.84	PK
Horizontal	4739.07	59.35	-20.12	39.22	54.00	-14.78	AV
Horizontal	11400.01	64.75	-8.72	56.03	68.20	-12.17	PK
Horizontal	11400.01	49.38	-8.72	40.66	54.00	-13.34	AV
Horizontal	17100.08	64.86	-3.92	60.94	74.00	-13.06	PK
Horizontal	17100.08	49.68	-3.92	45.76	54.00	-8.24	AV

Note: PK value is lower than the Average value limit, So average didn't record.

The 26.5-40G amplitude of spurious emissions that are attenuated by more than 20dB below the permissible value has no need to be reported.

Emission level (dBuV/m) = 20 log Emission level (uV/m).

Corrected Reading: Antenna Factor + Cable Loss + Read Level - Preamp Factor = Level.

Test Mode is MIMO Mode.

Test Mode:	TX(5.6G) - 802.11ac-HT40
------------	--------------------------

Polar (H/V)	Fre- quency (MHz)	Reading Level (dBuV/m)	Correct Factor (dB)	Measure- ment (dBuV/m)	Limits (dBuV/m)	Over (dB)	Detector Type
Low Channel (5510 MHz)-Above 1G							
Vertical	4434.16	62.19	-20.73	41.46	68.20	-26.74	PK
Vertical	4434.16	43.28	-20.73	22.55	54.00	-31.45	AV
Vertical	11020.01	61.64	-8.42	53.22	68.20	-14.98	PK
Vertical	11020.01	43.31	-8.42	34.89	54.00	-19.11	AV
Vertical	16530.05	63.04	-5.99	57.05	74.00	-16.95	PK
Vertical	16530.05	43.28	-5.99	37.29	54.00	-16.71	AV
Horizontal	4434.05	63.46	-20.73	42.73	74.00	-31.27	PK
Horizontal	4434.05	43.20	-20.73	22.47	54.00	-31.53	AV
Horizontal	11020.11	54.26	-8.42	45.84	68.20	-22.36	PK
Horizontal	11020.11	40.79	-8.42	32.37	54.00	-21.63	AV
Horizontal	16530.13	54.43	-5.99	48.44	74.00	-25.56	PK
Horizontal	16530.13	44.56	-5.99	38.57	54.00	-15.43	AV
middle Channel (5550 MHz)-Above 1G							
Vertical	4592.01	63.26	-20.42	42.84	74.00	-31.16	PK
Vertical	4592.01	43.67	-20.42	23.26	54.00	-30.74	AV
Vertical	11100.01	60.51	-8.40	52.11	68.20	-16.09	PK
Vertical	11100.01	43.90	-8.40	35.50	54.00	-18.50	AV
Vertical	16650.07	62.47	-5.60	56.87	74.00	-17.13	PK
Vertical	16650.07	43.81	-5.60	38.21	54.00	-15.79	AV
Horizontal	4592.16	62.28	-20.42	41.86	74.00	-32.14	PK
Horizontal	4592.16	43.99	-20.42	23.58	54.00	-30.42	AV
Horizontal	11100.14	50.33	-8.40	41.93	68.20	-26.27	PK
Horizontal	11100.14	43.92	-8.40	35.52	54.00	-18.48	AV
Horizontal	16650.16	50.30	-5.60	44.70	74.00	-29.30	PK
Horizontal	16650.16	42.76	-5.60	37.16	54.00	-16.84	AV
High Channel (5670 MHz)-Above 1G							
Vertical	4739.18	64.05	-20.12	43.93	68.20	-24.27	PK
Vertical	4739.18	43.77	-20.12	23.65	54.00	-30.35	AV
Vertical	11340.02	60.05	-8.67	51.38	68.20	-16.82	PK
Vertical	11340.02	43.75	-8.67	35.08	54.00	-18.92	AV
Vertical	17010.11	63.23	-4.41	58.82	74.00	-15.18	PK
Vertical	17010.11	43.38	-4.41	38.97	54.00	-15.03	AV
Horizontal	4739.19	62.49	-20.12	42.36	68.20	-25.84	PK
Horizontal	4739.19	43.27	-20.12	23.14	54.00	-30.86	AV
Horizontal	11340.19	52.20	-8.67	43.53	68.20	-24.67	PK
Horizontal	11340.19	42.08	-8.67	33.41	54.00	-20.59	AV
Horizontal	17010.08	53.78	-4.41	49.37	74.00	-24.63	PK
Horizontal	17010.08	41.22	-4.41	36.81	54.00	-17.19	AV

Note: PK value is lower than the Average value limit, So average didn't record.
 The 26.5-40G amplitude of spurious emissions that are attenuated by more than 20dB below the permissible value has no need to be reported.
 Emission level (dBuV/m) = 20 log Emission level (uV/m).
 Corrected Reading: Antenna Factor + Cable Loss + Read Level - Preamp Factor = Level.
 Test Mode is MIMO Mode.

Test Mode:	TX(5.6G) - 802.11ac-HT80
------------	--------------------------

Polar (H/V)	Fre- quency (MHz)	Reading Level (dBuV/m)	Correct Factor (dB)	Measure- ment (dBuV/m)	Limits (dBuV/m)	Over (dB)	Detector Type
(5530 MHz)-Above 1G							
Vertical	4434.08	60.37	-20.73	39.64	68.20	-28.56	PK
Vertical	4434.08	43.94	-20.73	23.21	54.00	-30.79	AV
Vertical	11060.13	61.05	-8.45	52.60	68.20	-15.60	PK
Vertical	11060.13	43.62	-8.45	35.17	54.00	-18.83	AV
Vertical	16590.03	60.84	-5.79	55.05	74.00	-18.95	PK
Vertical	16590.03	43.38	-5.79	37.59	54.00	-16.41	AV
Horizontal	4434.04	62.74	-20.73	42.01	68.20	-26.19	PK
Horizontal	4434.04	43.67	-20.73	22.93	54.00	-31.07	AV
Horizontal	11060.01	53.21	-8.45	44.76	68.20	-23.44	PK
Horizontal	11060.01	42.67	-8.45	34.22	54.00	-19.78	AV
Horizontal	16590.05	51.54	-5.79	45.75	74.00	-28.25	PK
Horizontal	16590.05	43.91	-5.79	38.12	54.00	-15.88	AV

Note: PK value is lower than the Average value limit, So average didn't record.
 The 26.5-40G amplitude of spurious emissions that are attenuated by more than 20dB below the permissible value has no need to be reported.
 Emission level (dBuV/m) = 20 log Emission level (uV/m).
 Corrected Reading: Antenna Factor + Cable Loss + Read Level - Preamp Factor = Level.
 Test Mode is MIMO Mode.

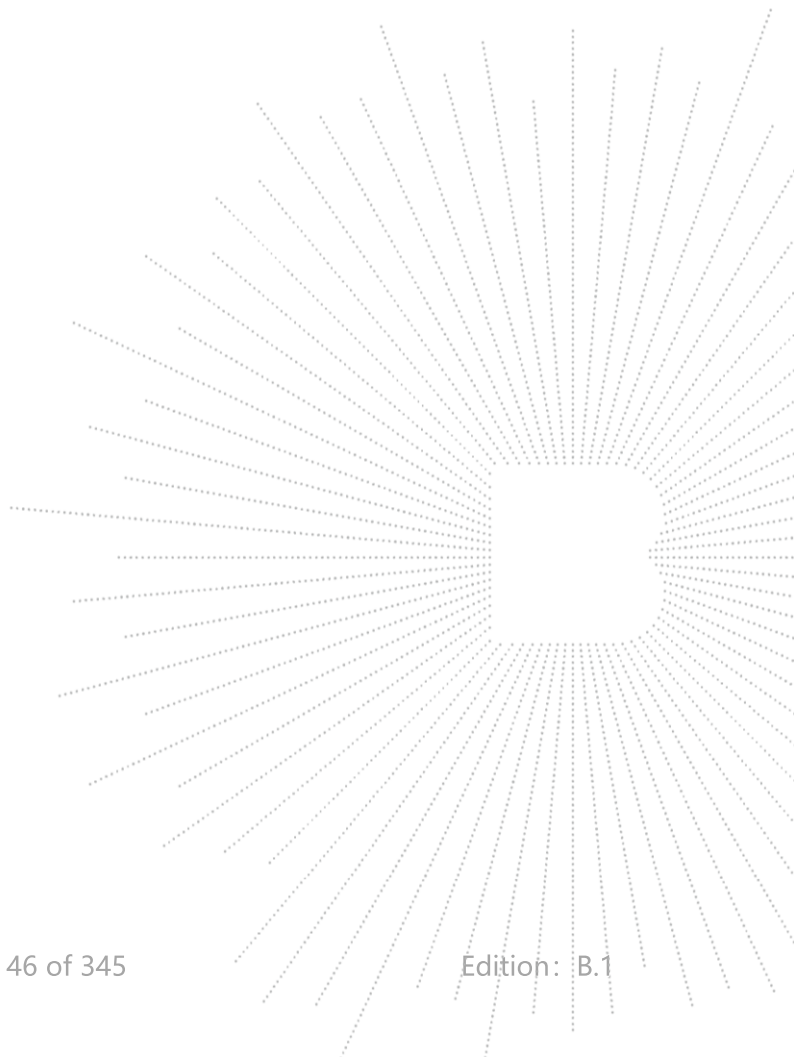

Test Mode:	TX(5.6G) - 802.11ax-HT20
------------	--------------------------

Polar (H/V)	Fre- quency (MHz)	Reading Level (dBuV/m)	Correct Factor (dB)	Measure- ment (dBuV/m)	Limits (dBuV/m)	Over (dB)	Detector Type
Low Channel (5500 MHz)-Above 1G							
Vertical	4434.06	74.91	-20.73	54.18	68.20	-14.02	PK
Vertical	4434.06	59.01	-20.73	38.28	54.00	-15.72	AV
Vertical	11000.09	61.82	-8.40	53.42	68.20	-14.78	PK
Vertical	11000.09	49.81	-8.40	41.41	54.00	-12.59	AV
Vertical	16500.10	61.60	-6.09	55.51	74.00	-18.49	PK
Vertical	16500.10	49.95	-6.09	43.86	54.00	-10.14	AV
Horizontal	4434.08	73.62	-20.73	52.89	68.20	-15.31	PK
Horizontal	4434.08	59.40	-20.73	38.67	54.00	-15.33	AV
Horizontal	11000.10	61.89	-8.40	53.49	68.20	-14.71	PK
Horizontal	11000.10	49.50	-8.40	41.10	54.00	-12.90	AV
Horizontal	16500.07	60.02	-6.09	53.93	74.00	-20.07	PK
Horizontal	16500.07	49.78	-6.09	43.69	54.00	-10.31	AV
middle Channel (5580 MHz)-Above 1G							
Vertical	4592.15	73.00	-20.42	52.58	74.00	-21.42	PK
Vertical	4592.15	59.37	-20.42	38.96	54.00	-15.04	AV
Vertical	11160.09	63.86	-8.53	55.33	68.20	-12.87	PK
Vertical	11160.09	49.10	-8.53	40.57	54.00	-13.43	AV
Vertical	16740.03	60.34	-5.31	55.03	74.00	-18.97	PK
Vertical	16740.03	49.04	-5.31	43.73	54.00	-10.27	AV
Horizontal	4592.06	70.62	-20.42	50.20	74.00	-23.80	PK
Horizontal	4592.06	59.44	-20.42	39.03	54.00	-14.97	AV
Horizontal	11160.17	60.03	-8.53	51.50	68.20	-16.70	PK
Horizontal	11160.17	49.48	-8.53	40.95	54.00	-13.05	AV
Horizontal	16740.13	62.11	-5.31	56.80	74.00	-17.20	PK
Horizontal	16740.13	49.79	-5.31	44.48	54.00	-9.52	AV
High Channel (5700 MHz)-Above 1G							
Vertical	4739.03	71.68	-20.12	51.56	74.00	-22.44	PK
Vertical	4739.03	59.73	-20.12	39.60	54.00	-14.40	AV
Vertical	11400.08	62.16	-8.72	53.44	68.20	-14.76	PK
Vertical	11400.08	49.54	-8.72	40.82	54.00	-13.18	AV
Vertical	17100.11	64.84	-3.92	60.92	74.00	-13.08	PK
Vertical	17100.11	49.87	-3.92	45.95	54.00	-8.05	AV
Horizontal	4739.19	70.97	-20.12	50.85	74.00	-23.15	PK
Horizontal	4739.19	59.52	-20.12	39.40	54.00	-14.60	AV
Horizontal	11400.04	60.00	-8.72	51.28	68.20	-16.92	PK
Horizontal	11400.04	49.43	-8.72	40.71	54.00	-13.29	AV
Horizontal	17100.07	60.35	-3.92	56.43	74.00	-17.57	PK
Horizontal	17100.07	49.90	-3.92	45.98	54.00	-8.02	AV

Note: PK value is lower than the Average value limit, So average didn't record.

The 26.5-40G amplitude of spurious emissions that are attenuated by more than 20dB below the permissible value has no need to be reported.

Emission level (dBuV/m) = 20 log Emission level (uV/m).

Corrected Reading: Antenna Factor + Cable Loss + Read Level - Preamp Factor = Level.

Test Mode is MIMO Mode.

Test Mode:	TX(5.6G) - 802.11ax-HT40
------------	--------------------------

Polar (H/V)	Fre- quency (MHz)	Reading Level (dBuV/m)	Correct Factor (dB)	Measure- ment (dBuV/m)	Limits (dBuV/m)	Over (dB)	Detector Type
Low Channel (5510 MHz)-Above 1G							
Vertical	4434.02	60.10	-20.73	39.37	68.20	-28.83	PK
Vertical	4434.02	43.61	-20.73	22.88	54.00	-31.12	AV
Vertical	11020.13	63.14	-8.42	54.72	68.20	-13.48	PK
Vertical	11020.13	43.85	-8.42	35.43	54.00	-18.57	AV
Vertical	16530.09	61.00	-5.99	55.01	74.00	-18.99	PK
Vertical	16530.09	43.96	-5.99	37.97	54.00	-16.03	AV
Horizontal	4434.13	63.87	-20.73	43.13	74.00	-30.87	PK
Horizontal	4434.13	43.41	-20.73	22.68	54.00	-31.32	AV
Horizontal	11020.15	54.97	-8.42	46.55	68.20	-21.65	PK
Horizontal	11020.15	40.77	-8.42	32.35	54.00	-21.65	AV
Horizontal	16530.13	51.06	-5.99	45.07	74.00	-28.93	PK
Horizontal	16530.13	40.05	-5.99	34.06	54.00	-19.94	AV
middle Channel (5550 MHz)-Above 1G							
Vertical	4592.18	63.16	-20.42	42.74	74.00	-31.26	PK
Vertical	4592.18	43.52	-20.42	23.10	54.00	-30.90	AV
Vertical	11100.20	61.23	-8.40	52.83	68.20	-15.37	PK
Vertical	11100.20	43.44	-8.40	35.04	54.00	-18.96	AV
Vertical	16650.16	64.75	-5.60	59.15	74.00	-14.85	PK
Vertical	16650.16	43.41	-5.60	37.81	54.00	-16.19	AV
Horizontal	4592.19	60.80	-20.42	40.39	74.00	-33.61	PK
Horizontal	4592.19	43.03	-20.42	22.61	54.00	-31.39	AV
Horizontal	11100.09	52.61	-8.40	44.21	68.20	-23.99	PK
Horizontal	11100.09	43.09	-8.40	34.69	54.00	-19.31	AV
Horizontal	16650.20	53.97	-5.60	48.37	74.00	-25.63	PK
Horizontal	16650.20	40.49	-5.60	34.89	54.00	-19.11	AV
High Channel (5670 MHz)-Above 1G							
Vertical	4739.08	60.52	-20.12	40.40	68.20	-27.80	PK
Vertical	4739.08	43.64	-20.12	23.52	54.00	-30.48	AV
Vertical	11340.20	62.83	-8.67	54.16	68.20	-14.04	PK
Vertical	11340.20	43.33	-8.67	34.66	54.00	-19.34	AV
Vertical	17010.10	61.62	-4.41	57.21	74.00	-16.79	PK
Vertical	17010.10	43.81	-4.41	39.40	54.00	-14.60	AV
Horizontal	4739.05	61.94	-20.12	41.82	68.20	-26.38	PK
Horizontal	4739.05	43.36	-20.12	23.23	54.00	-30.77	AV
Horizontal	11340.08	52.84	-8.67	44.17	68.20	-24.03	PK
Horizontal	11340.08	40.11	-8.67	31.44	54.00	-22.56	AV
Horizontal	17010.08	50.19	-4.41	45.78	74.00	-28.22	PK
Horizontal	17010.08	41.27	-4.41	36.86	54.00	-17.14	AV

Note: PK value is lower than the Average value limit, So average didn't record.
 The 26.5-40G amplitude of spurious emissions that are attenuated by more than 20dB below the permissible value has no need to be reported.
 Emission level (dBuV/m) = 20 log Emission level (uV/m).
 Corrected Reading: Antenna Factor + Cable Loss + Read Level - Preamp Factor = Level.
 Test Mode is MIMO Mode.

Test Mode:	TX(5.6G) - 802.11ax-HT80
------------	--------------------------

Polar (H/V)	Fre- quency (MHz)	Reading Level (dBuV/m)	Correct Factor (dB)	Measure- ment (dBuV/m)	Limits (dBuV/m)	Over (dB)	Detector Type
(5530 MHz)-Above 1G							
Vertical	4434.02	61.27	-20.73	40.54	68.20	-27.66	PK
Vertical	4434.02	43.53	-20.73	22.80	54.00	-31.20	AV
Vertical	11060.11	62.36	-8.45	53.91	68.20	-14.29	PK
Vertical	11060.11	43.09	-8.45	34.64	54.00	-19.36	AV
Vertical	16590.11	60.81	-5.79	55.02	74.00	-18.98	PK
Vertical	16590.11	43.37	-5.79	37.58	54.00	-16.42	AV
Horizontal	4434.09	62.01	-20.73	41.28	68.20	-26.92	PK
Horizontal	4434.09	43.30	-20.73	22.56	54.00	-31.44	AV
Horizontal	11060.20	50.41	-8.45	41.96	68.20	-26.24	PK
Horizontal	11060.20	44.95	-8.45	36.50	54.00	-17.50	AV
Horizontal	16590.01	51.32	-5.79	45.53	74.00	-28.47	PK
Horizontal	16590.01	44.20	-5.79	38.41	54.00	-15.59	AV

Note: PK value is lower than the Average value limit, So average didn't record.

The 26.5-40G amplitude of spurious emissions that are attenuated by more than 20dB below the permissible value has no need to be reported.

Emission level (dBuV/m) = 20 log Emission level (uV/m).

Corrected Reading: Antenna Factor + Cable Loss + Read Level - Preamp Factor = Level.

Test Mode is MIMO Mode.

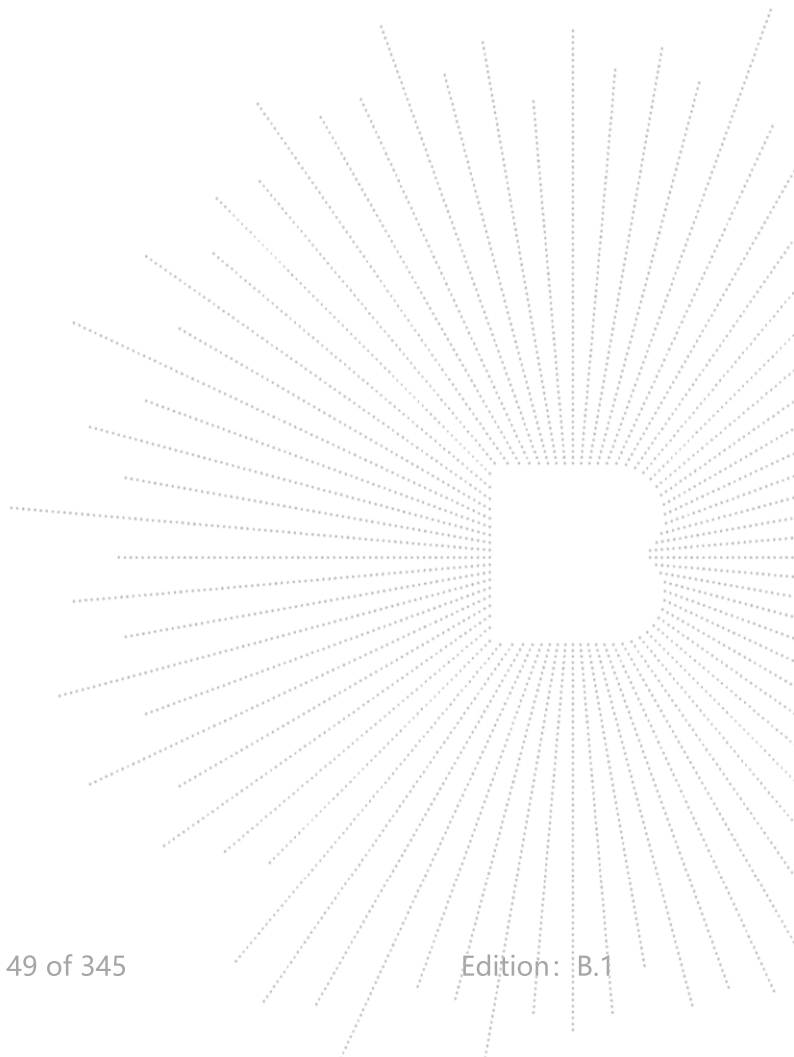

Test Mode:	TX(5.8G) - 802.11a
------------	--------------------

Polar (H/V)	Fre- quency (MHz)	Reading Level (dBuV/m)	Correct Factor (dB)	Measure- ment (dBuV/m)	Limits (dBuV/m)	Over (dB)	Detector Type
Low Channel (5745 MHz)-Above 1G							
Vertical	4679.00	71.57	-20.24	51.33	74.00	-22.67	PK
Vertical	4679.00	59.21	-20.24	38.97	54.00	-15.03	AV
Vertical	11490.06	63.27	-8.79	54.48	68.20	-13.72	PK
Vertical	11490.06	49.85	-8.79	41.06	54.00	-12.94	AV
Vertical	17235.19	56.68	-3.18	53.50	68.20	-14.70	PK
Vertical	17235.19	44.13	-3.18	40.95	54.00	-13.05	AV
Horizontal	4679.17	74.08	-20.73	53.35	74.00	-20.65	PK
Horizontal	4679.17	59.80	-20.73	39.07	54.00	-14.93	AV
Horizontal	11490.08	61.79	-8.79	53.00	68.20	-15.20	PK
Horizontal	11490.08	49.88	-8.79	41.09	54.00	-12.91	AV
Horizontal	17235.16	58.72	-3.18	55.54	68.20	-12.66	PK
Horizontal	17235.16	44.91	-3.18	41.73	54.00	-12.27	AV
middle Channel (5785 MHz)-Above 1G							
Vertical	4592.12	72.67	-20.42	52.25	74.00	-21.75	PK
Vertical	4592.12	59.93	-20.42	39.52	54.00	-14.48	AV
Vertical	11570.05	64.80	-8.86	55.94	68.20	-12.26	PK
Vertical	11570.05	49.66	-8.86	40.80	54.00	-13.20	AV
Vertical	17355.13	58.92	-2.52	56.40	68.20	-11.80	PK
Vertical	17355.13	44.58	-2.52	42.06	54.00	-11.94	AV
Horizontal	4592.03	71.69	-20.42	51.27	74.00	-22.73	PK
Horizontal	4592.03	59.58	-20.42	39.16	54.00	-14.84	AV
Horizontal	11570.06	61.34	-8.86	52.48	68.20	-15.72	PK
Horizontal	11570.06	49.71	-8.86	40.85	54.00	-13.15	AV
Horizontal	17355.20	56.79	-2.52	54.27	68.20	-13.93	PK
Horizontal	17355.20	44.65	-2.52	42.13	54.00	-11.87	AV
High Channel (5825 MHz)-Above 1G							
Vertical	6039.01	73.52	-18.93	54.59	68.20	-13.61	PK
Vertical	6039.01	59.24	-18.93	40.31	54.00	-13.69	AV
Vertical	11650.04	60.46	-8.92	51.54	74.00	-22.46	PK
Vertical	11650.04	49.38	-8.92	40.46	54.00	-13.54	AV
Vertical	17475.18	57.74	-1.86	55.88	68.20	-12.32	PK
Vertical	17475.18	44.28	-1.86	42.42	54.00	-11.58	AV
Horizontal	6039.06	72.01	-18.93	53.07	68.20	-15.13	PK
Horizontal	6039.06	59.20	-18.93	40.27	54.00	-13.73	AV
Horizontal	11650.06	63.98	-8.92	55.06	74.00	-18.94	PK
Horizontal	11650.06	49.82	-8.92	40.90	54.00	-13.10	AV
Horizontal	17475.02	57.21	-1.86	55.35	68.20	-12.85	PK
Horizontal	17475.02	44.82	-1.86	42.96	54.00	-11.04	AV

Note: PK value is lower than the Average value limit, So average didn't record.

The 26.5-40G amplitude of spurious emissions that are attenuated by more than 20dB below the permissible value has no need to be reported.

Emission level (dBuV/m) = 20 log Emission level (uV/m).

Corrected Reading: Antenna Factor + Cable Loss + Read Level - Preamp Factor = Level.

The worst case is Antenna A.

Test Mode:	TX(5.8G) - 802.11n-HT20
------------	-------------------------

Polar (H/V)	Fre- quency (MHz)	Reading Level (dBuV/m)	Correct Factor (dB)	Measure- ment (dBuV/m)	Limits (dBuV/m)	Over (dB)	Detector Type
Low Channel (5745 MHz)-Above 1G							
Vertical	4679.10	72.45	-20.24	52.20	74.00	-21.80	PK
Vertical	4679.10	59.53	-20.24	39.29	54.00	-14.71	AV
Vertical	11490.04	63.81	-8.79	55.02	68.20	-13.18	PK
Vertical	11490.04	49.50	-8.79	40.71	54.00	-13.29	AV
Vertical	17235.10	58.16	-3.18	54.98	68.20	-13.22	PK
Vertical	17235.10	44.65	-3.18	41.47	54.00	-12.53	AV
Horizontal	4679.14	70.63	-20.24	50.39	74.00	-23.61	PK
Horizontal	4679.14	59.75	-20.24	39.50	54.00	-14.50	AV
Horizontal	11490.12	64.22	-8.79	55.43	68.20	-12.77	PK
Horizontal	11490.12	49.40	-8.79	40.61	54.00	-13.39	AV
Horizontal	17235.16	58.25	-3.18	55.07	68.20	-13.13	PK
Horizontal	17235.16	44.56	-3.18	41.38	54.00	-12.62	AV
middle Channel (5785 MHz)-Above 1G							
Vertical	4592.12	72.56	-20.42	52.15	74.00	-21.85	PK
Vertical	4592.12	59.19	-20.42	38.77	54.00	-15.23	AV
Vertical	11570.10	63.74	-8.86	54.88	68.20	-13.32	PK
Vertical	11570.10	49.60	-8.86	40.74	54.00	-13.26	AV
Vertical	17355.10	59.48	-2.52	56.96	68.20	-11.24	PK
Vertical	17355.10	44.37	-2.52	41.85	54.00	-12.15	AV
Horizontal	4592.15	72.51	-20.42	52.10	74.00	-21.90	PK
Horizontal	4592.15	59.13	-20.42	38.72	54.00	-15.28	AV
Horizontal	11570.04	60.13	-8.86	51.27	68.20	-16.93	PK
Horizontal	11570.04	49.90	-8.86	41.04	54.00	-12.96	AV
Horizontal	17355.20	58.87	-2.52	56.35	68.20	-11.85	PK
Horizontal	17355.20	44.12	-2.52	41.60	54.00	-12.40	AV
High Channel (5825 MHz)-Above 1G							
Vertical	6039.07	72.31	-18.93	53.38	68.20	-14.82	PK
Vertical	6039.07	59.59	-18.93	40.66	54.00	-13.34	AV
Vertical	11650.04	62.00	-8.92	53.08	74.00	-20.92	PK
Vertical	11650.04	49.73	-8.92	40.81	54.00	-13.19	AV
Vertical	17475.15	59.73	-1.86	57.87	68.20	-10.33	PK
Vertical	17475.15	44.65	-1.86	42.79	54.00	-11.21	AV
Horizontal	6039.13	72.32	-18.93	53.39	68.20	-14.81	PK
Horizontal	6039.13	59.39	-18.93	40.45	54.00	-13.55	AV
Horizontal	11650.04	60.79	-8.92	51.87	74.00	-22.13	PK
Horizontal	11650.04	49.90	-8.92	40.98	54.00	-13.02	AV
Horizontal	17475.02	59.22	-1.86	57.36	68.20	-10.84	PK
Horizontal	17475.02	44.62	-1.86	42.76	54.00	-11.24	AV

Note: PK value is lower than the Average value limit, So average didn't record.
 The 26.5-40G amplitude of spurious emissions that are attenuated by more than 20dB below the permissible value has no need to be reported.
 Emission level (dBuV/m) = 20 log Emission level (uV/m).
 Corrected Reading: Antenna Factor + Cable Loss + Read Level - Preamp Factor = Level.
 Test Mode is MIMO Mode.

Test Mode:	TX(5.8G) - 802.11n-HT40
------------	-------------------------

Polar	Fre- quency	Reading Level	Correct Factor	Measure- ment	Limits	Over	Detector Type
(H/V)	(MHz)	(dBuV/m)	(dB)	(dBuV/m)	(dBuV/m)	(dB)	
Low Channel (5755 MHz)-Above 1G							
Vertical	4679.13	71.04	-20.24	50.79	74.00	-23.21	PK
Vertical	4679.13	59.34	-20.24	39.10	54.00	-14.90	AV
Vertical	11510.02	64.69	-8.81	55.88	74.00	-18.12	PK
Vertical	11510.02	49.43	-8.81	40.62	54.00	-13.38	AV
Vertical	17265.06	55.62	-3.01	52.61	68.20	-15.59	PK
Vertical	17265.06	44.53	-3.01	41.52	54.00	-12.48	AV
Horizontal	4679.10	73.66	-20.24	53.42	74.00	-20.58	PK
Horizontal	4679.10	59.62	-20.24	39.38	54.00	-14.62	AV
Horizontal	11510.15	64.56	-8.81	55.75	74.00	-18.25	PK
Horizontal	11510.15	49.85	-8.81	41.04	54.00	-12.96	AV
Horizontal	17265.10	58.06	-3.01	55.05	68.20	-13.15	PK
Horizontal	17265.10	44.92	-3.01	41.91	54.00	-12.09	AV
High Channel (5795 MHz)-Above 1G							
Vertical	6039.18	70.11	-18.93	51.18	68.20	-17.02	PK
Vertical	6039.18	59.02	-18.93	40.09	54.00	-13.91	AV
Vertical	11590.09	60.09	-8.87	51.22	74.00	-22.78	PK
Vertical	11590.09	49.54	-8.87	40.67	54.00	-13.33	AV
Vertical	17385.15	55.39	-2.35	53.04	68.20	-15.16	PK
Vertical	17385.15	44.60	-2.35	42.25	54.00	-11.75	AV
Horizontal	6039.05	71.10	-18.93	52.17	68.20	-16.03	PK
Horizontal	6039.05	59.16	-18.93	40.22	54.00	-13.78	AV
Horizontal	11590.05	60.02	-8.87	51.15	74.00	-22.85	PK
Horizontal	11590.05	49.95	-8.87	41.08	54.00	-12.92	AV
Horizontal	17385.08	56.00	-2.35	53.65	68.20	-14.55	PK
Horizontal	17385.08	44.11	-2.35	41.76	54.00	-12.24	AV

Note: PK value is lower than the Average value limit, So average didn't record.

The 26.5-40G amplitude of spurious emissions that are attenuated by more than 20dB below the permissible value has no need to be reported.

Emission level (dBuV/m) = 20 log Emission level (uV/m).

Corrected Reading: Antenna Factor + Cable Loss + Read Level - Preamp Factor = Level.

Test Mode is MIMO Mode.

Test Mode:	TX(5.8G) - 802.11ac-HT20
------------	--------------------------

Polar (H/V)	Fre- quency (MHz)	Reading Level (dBuV/m)	Correct Factor (dB)	Measure- ment (dBuV/m)	Limits (dBuV/m)	Over (dB)	Detector Type
Low Channel (5745 MHz)-Above 1G							
Vertical	4679.15	70.06	-20.24	49.82	74.00	-24.18	PK
Vertical	4679.15	59.88	-20.24	39.64	54.00	-14.36	AV
Vertical	11490.15	64.85	-8.79	56.06	68.20	-12.14	PK
Vertical	11490.15	49.88	-8.79	41.09	54.00	-12.91	AV
Vertical	17235.17	59.70	-3.18	56.52	68.20	-11.68	PK
Vertical	17235.17	44.37	-3.18	41.19	54.00	-12.81	AV
Horizontal	4679.10	71.44	-20.24	51.20	74.00	-22.80	PK
Horizontal	4679.10	59.59	-20.24	39.35	54.00	-14.65	AV
Horizontal	11490.06	63.10	-8.79	54.31	68.20	-13.89	PK
Horizontal	11490.06	50.00	-8.79	41.21	54.00	-12.79	AV
Horizontal	17235.00	59.84	-3.18	56.66	68.20	-11.54	PK
Horizontal	17235.00	44.75	-3.18	41.57	54.00	-12.43	AV
middle Channel (5785 MHz)-Above 1G							
Vertical	4592.10	70.92	-20.42	50.51	74.00	-23.49	PK
Vertical	4592.10	59.82	-20.42	39.40	54.00	-14.60	AV
Vertical	11570.13	60.34	-8.86	51.48	68.20	-16.72	PK
Vertical	11570.13	49.47	-8.86	40.61	54.00	-13.39	AV
Vertical	17355.06	59.48	-2.52	56.96	68.20	-11.24	PK
Vertical	17355.06	44.19	-2.52	41.67	54.00	-12.33	AV
Horizontal	4592.18	71.00	-20.42	50.59	74.00	-23.41	PK
Horizontal	4592.18	59.43	-20.42	39.02	54.00	-14.98	AV
Horizontal	11570.16	64.94	-8.86	56.08	68.20	-12.12	PK
Horizontal	11570.16	49.80	-8.86	40.94	54.00	-13.06	AV
Horizontal	17355.03	58.11	-2.52	55.59	68.20	-12.61	PK
Horizontal	17355.03	44.84	-2.52	42.32	54.00	-11.68	AV
High Channel (5825 MHz)-Above 1G							
Vertical	6039.05	71.32	-18.93	52.39	68.20	-15.81	PK
Vertical	6039.05	59.93	-18.93	41.00	54.00	-13.00	AV
Vertical	11650.04	63.95	-8.92	55.03	74.00	-18.97	PK
Vertical	11650.04	49.02	-8.92	40.10	54.00	-13.90	AV
Vertical	17475.03	55.46	-1.86	53.60	68.20	-14.60	PK
Vertical	17475.03	44.99	-1.86	43.13	54.00	-10.87	AV
Horizontal	6039.01	73.56	-18.93	54.63	68.20	-13.57	PK
Horizontal	6039.01	59.14	-18.93	40.20	54.00	-13.80	AV
Horizontal	11650.13	63.95	-8.92	55.03	74.00	-18.97	PK
Horizontal	11650.13	49.85	-8.92	40.93	54.00	-13.07	AV
Horizontal	17475.01	59.75	-1.86	57.89	68.20	-10.31	PK
Horizontal	17475.01	44.82	-1.86	42.96	54.00	-11.04	AV

Note: PK value is lower than the Average value limit, So average didn't record.

The 26.5-40G amplitude of spurious emissions that are attenuated by more than 20dB below the permissible value has no need to be reported.

Emission level (dBuV/m) = 20 log Emission level (uV/m).

Corrected Reading: Antenna Factor + Cable Loss + Read Level - Preamp Factor = Level.

Test Mode is MIMO Mode.

Test Mode:	TX(5.8G) - 802.11ac-HT40
------------	--------------------------

Polar	Fre- quency	Reading Level	Correct Factor	Measure- ment	Limits	Over	Detector Type
(H/V)	(MHz)	(dBuV/m)	(dB)	(dBuV/m)	(dBuV/m)	(dB)	
Low Channel (5755 MHz)-Above 1G							
Vertical	4679.03	70.15	-20.24	49.91	74.00	-24.09	PK
Vertical	4679.03	59.99	-20.24	39.75	54.00	-14.25	AV
Vertical	11510.15	61.21	-8.81	52.40	74.00	-21.60	PK
Vertical	11510.15	49.26	-8.81	40.45	54.00	-13.55	AV
Vertical	17265.01	55.67	-3.01	52.66	68.20	-15.54	PK
Vertical	17265.01	44.44	-3.01	41.43	54.00	-12.57	AV
Horizontal	4679.08	73.62	-20.24	53.37	74.00	-20.63	PK
Horizontal	4679.08	59.27	-20.24	39.03	54.00	-14.97	AV
Horizontal	11510.05	63.85	-8.81	55.04	74.00	-18.96	PK
Horizontal	11510.05	49.42	-8.81	40.61	54.00	-13.39	AV
Horizontal	17265.18	59.16	-3.01	56.15	68.20	-12.05	PK
Horizontal	17265.18	44.75	-3.01	41.74	54.00	-12.26	AV
High Channel (5795 MHz)-Above 1G							
Vertical	6039.01	72.49	-18.93	53.56	68.20	-14.64	PK
Vertical	6039.01	59.66	-18.93	40.73	54.00	-13.27	AV
Vertical	11590.18	64.14	-8.87	55.27	74.00	-18.73	PK
Vertical	11590.18	49.06	-8.87	40.19	54.00	-13.81	AV
Vertical	17385.03	59.55	-2.35	57.20	68.20	-11.00	PK
Vertical	17385.03	44.65	-2.35	42.30	54.00	-11.70	AV
Horizontal	6039.03	73.15	-18.93	54.21	68.20	-13.99	PK
Horizontal	6039.03	60.00	-18.93	41.07	54.00	-12.93	AV
Horizontal	11590.06	62.83	-8.87	53.96	74.00	-20.04	PK
Horizontal	11590.06	49.61	-8.87	40.74	54.00	-13.26	AV
Horizontal	17385.13	58.68	-2.35	56.33	68.20	-11.87	PK
Horizontal	17385.13	44.52	-2.35	42.17	54.00	-11.83	AV

Note: PK value is lower than the Average value limit, So average didn't record.

The 26.5-40G amplitude of spurious emissions that are attenuated by more than 20dB below the permissible value has no need to be reported.

Emission level (dBuV/m) = 20 log Emission level (uV/m).

Corrected Reading: Antenna Factor + Cable Loss + Read Level - Preamp Factor = Level.

Test Mode is MIMO Mode.

Test Mode:	TX(5.8G) - 802.11ac-HT80
------------	--------------------------

Polar (H/V)	Fre- quency (MHz)	Reading Level (dBuV/m)	Correct Factor (dB)	Measure- ment (dBuV/m)	Limits (dBuV/m)	Over (dB)	Detector Type
(5775 MHz)-Above 1G							
Vertical	4679.05	73.52	-20.24	53.28	74.00	-20.72	PK
Vertical	4679.05	59.85	-20.24	39.61	54.00	-14.39	AV
Vertical	11550.14	64.27	-8.84	55.43	74.00	-18.57	PK
Vertical	11550.14	49.05	-8.84	40.21	54.00	-13.79	AV
Vertical	17325.06	59.53	-2.68	56.85	68.20	-11.35	PK
Vertical	17325.06	44.48	-2.68	41.80	54.00	-12.20	AV
Horizontal	4679.13	73.64	-20.24	53.40	74.00	-20.60	PK
Horizontal	4679.13	59.86	-20.24	39.62	54.00	-14.38	AV
Horizontal	11550.06	61.35	-8.84	52.51	74.00	-21.49	PK
Horizontal	11550.06	49.44	-8.84	40.60	54.00	-13.40	AV
Horizontal	17325.03	58.13	-2.68	55.45	68.20	-12.75	PK
Horizontal	17325.03	44.13	-2.68	41.45	54.00	-12.55	AV

Note: PK value is lower than the Average value limit, So average didn't record.
 The 26.5-40G amplitude of spurious emissions that are attenuated by more than 20dB below the permissible value has no need to be reported.
 Emission level (dBuV/m) = 20 log Emission level (uV/m).
 Corrected Reading: Antenna Factor + Cable Loss + Read Level - Preamp Factor = Level.
 Test Mode is MIMO Mode.

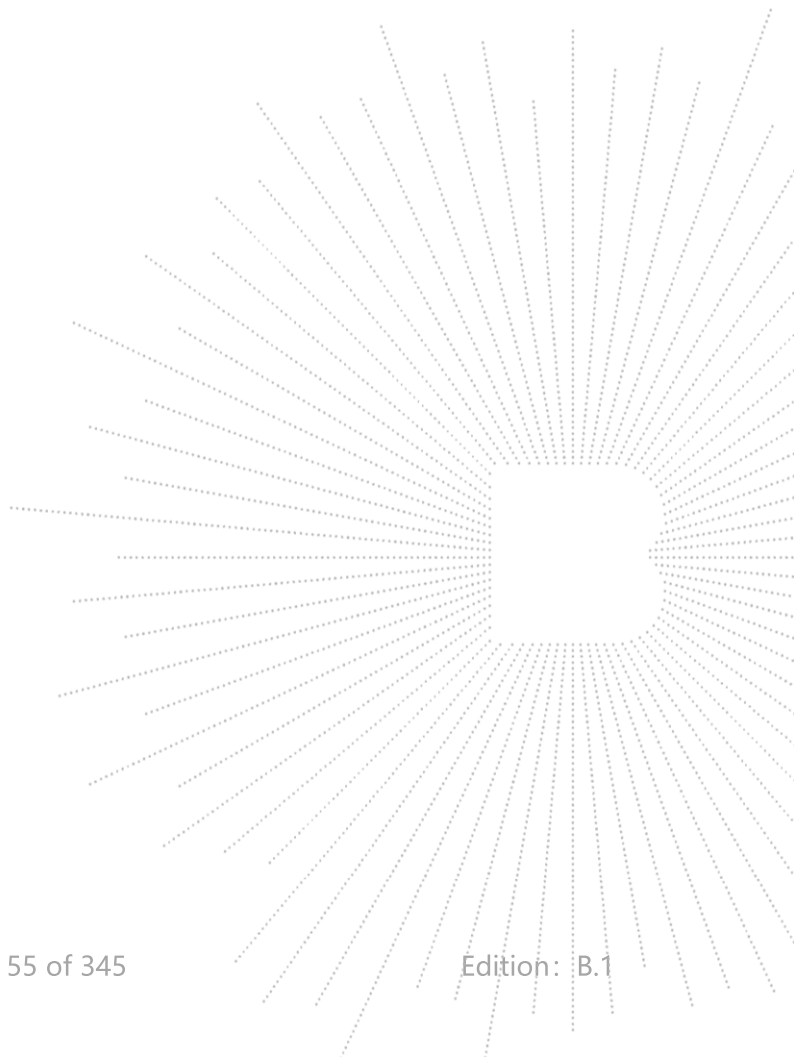

Test Mode:	TX(5.8G) - 802.11ax-HT20
------------	--------------------------

Polar (H/V)	Fre- quency (MHz)	Reading Level (dBuV/m)	Correct Factor (dB)	Measure- ment (dBuV/m)	Limits (dBuV/m)	Over (dB)	Detector Type
Low Channel (5745 MHz)-Above 1G							
Vertical	4679.04	71.23	-20.24	50.99	74.00	-23.01	PK
Vertical	4679.04	59.25	-20.24	39.00	54.00	-15.00	AV
Vertical	11490.00	64.38	-8.79	55.59	68.20	-12.61	PK
Vertical	11490.00	49.23	-8.79	40.44	54.00	-13.56	AV
Vertical	17235.11	59.39	-3.18	56.21	68.20	-11.99	PK
Vertical	17235.11	44.73	-3.18	41.55	54.00	-12.45	AV
Horizontal	4679.18	72.56	-20.24	52.32	74.00	-21.68	PK
Horizontal	4679.18	59.28	-20.24	39.04	54.00	-14.96	AV
Horizontal	11490.02	61.36	-8.79	52.57	68.20	-15.63	PK
Horizontal	11490.02	49.48	-8.79	40.69	54.00	-13.31	AV
Horizontal	17235.07	58.10	-3.18	54.92	68.20	-13.28	PK
Horizontal	17235.07	45.00	-3.18	41.82	54.00	-12.18	AV
middle Channel (5785 MHz)-Above 1G							
Vertical	4592.06	71.56	-20.42	51.15	74.00	-22.85	PK
Vertical	4592.06	59.34	-20.42	38.93	54.00	-15.07	AV
Vertical	11570.19	63.34	-8.86	54.48	68.20	-13.72	PK
Vertical	11570.19	49.78	-8.86	40.92	54.00	-13.08	AV
Vertical	17355.08	58.14	-2.52	55.62	68.20	-12.58	PK
Vertical	17355.08	44.35	-2.52	41.83	54.00	-12.17	AV
Horizontal	4592.19	74.79	-20.42	54.37	74.00	-19.63	PK
Horizontal	4592.19	59.68	-20.42	39.27	54.00	-14.73	AV
Horizontal	11570.01	60.15	-8.86	51.29	68.20	-16.91	PK
Horizontal	11570.01	49.24	-8.86	40.38	54.00	-13.62	AV
Horizontal	17355.18	57.82	-2.52	55.30	68.20	-12.90	PK
Horizontal	17355.18	44.70	-2.52	42.18	54.00	-11.82	AV
High Channel (5825 MHz)-Above 1G							
Vertical	6039.10	70.81	-18.93	51.88	68.20	-16.32	PK
Vertical	6039.10	59.19	-18.93	40.26	54.00	-13.74	AV
Vertical	11650.13	60.96	-8.92	52.04	74.00	-21.96	PK
Vertical	11650.13	49.08	-8.92	40.16	54.00	-13.84	AV
Vertical	17475.17	57.73	-1.86	55.87	68.20	-12.33	PK
Vertical	17475.17	44.54	-1.86	42.68	54.00	-11.32	AV
Horizontal	6039.15	72.87	-18.93	53.94	68.20	-14.26	PK
Horizontal	6039.15	59.86	-18.93	40.92	54.00	-13.08	AV
Horizontal	11650.09	61.18	-8.92	52.26	74.00	-21.74	PK
Horizontal	11650.09	49.54	-8.92	40.62	54.00	-13.38	AV
Horizontal	17475.09	55.78	-1.86	53.92	68.20	-14.28	PK
Horizontal	17475.09	44.26	-1.86	42.40	54.00	-11.60	AV

Note: PK value is lower than the Average value limit, So average didn't record.
 The 26.5-40G amplitude of spurious emissions that are attenuated by more than 20dB below the permissible value has no need to be reported.
 Emission level (dBuV/m) = 20 log Emission level (uV/m).
 Corrected Reading: Antenna Factor + Cable Loss + Read Level - Preamp Factor = Level.
 Test Mode is MIMO Mode.

Test Mode:	TX(5.8G) - 802.11ax-HT40
------------	--------------------------

Polar (H/V)	Fre- quency (MHz)	Reading Level (dBuV/m)	Correct Factor (dB)	Measure- ment (dBuV/m)	Limits (dBuV/m)	Over (dB)	Detector Type
Low Channel (5755 MHz)-Above 1G							
Vertical	4679.10	71.43	-20.24	51.18	74.00	-22.82	PK
Vertical	4679.10	59.89	-20.24	39.65	54.00	-14.35	AV
Vertical	11510.03	63.47	-8.81	54.66	74.00	-19.34	PK
Vertical	11510.03	49.41	-8.81	40.60	54.00	-13.40	AV
Vertical	17265.07	58.76	-3.01	55.75	68.20	-12.45	PK
Vertical	17265.07	44.43	-3.01	41.42	54.00	-12.58	AV
Horizontal	4679.06	70.30	-20.24	50.06	74.00	-23.94	PK
Horizontal	4679.06	59.33	-20.24	39.09	54.00	-14.91	AV
Horizontal	11510.01	60.26	-8.81	51.45	74.00	-22.55	PK
Horizontal	11510.01	49.98	-8.81	41.17	54.00	-12.83	AV
Horizontal	17265.03	56.13	-3.01	53.12	68.20	-15.08	PK
Horizontal	17265.03	44.77	-3.01	41.76	54.00	-12.24	AV
High Channel (5795 MHz)-Above 1G							
Vertical	6039.17	71.22	-18.93	52.29	68.20	-15.91	PK
Vertical	6039.17	59.27	-18.93	40.34	54.00	-13.66	AV
Vertical	11590.05	62.11	-8.87	53.24	74.00	-20.76	PK
Vertical	11590.05	49.17	-8.87	40.30	54.00	-13.70	AV
Vertical	17385.19	56.53	-2.35	54.18	68.20	-14.02	PK
Vertical	17385.19	44.64	-2.35	42.29	54.00	-11.71	AV
Horizontal	6039.05	70.80	-18.93	51.87	68.20	-16.33	PK
Horizontal	6039.05	59.29	-18.93	40.36	54.00	-13.64	AV
Horizontal	11590.08	60.49	-8.87	51.62	74.00	-22.38	PK
Horizontal	11590.08	49.16	-8.87	40.29	54.00	-13.71	AV
Horizontal	17385.06	58.76	-2.35	56.41	68.20	-11.79	PK
Horizontal	17385.06	44.96	-2.35	42.61	54.00	-11.39	AV

Note: PK value is lower than the Average value limit, So average didn't record.

The 26.5-40G amplitude of spurious emissions that are attenuated by more than 20dB below the permissible value has no need to be reported.

Emission level (dBuV/m) = 20 log Emission level (uV/m).

Corrected Reading: Antenna Factor + Cable Loss + Read Level - Preamp Factor = Level.

Test Mode is MIMO Mode.

Test Mode:	TX(5.8G) - 802.11ax-HT80
------------	--------------------------

Polar	Fre- quency	Reading Level	Correct Factor	Measure- ment	Limits	Over	Detector Type
(H/V)	(MHz)	(dBuV/m)	(dB)	(dBuV/m)	(dBuV/m)	(dB)	
(5775 MHz)-Above 1G							
Vertical	4679.04	70.17	-20.24	49.93	74.00	-24.07	PK
Vertical	4679.04	59.11	-20.24	38.86	54.00	-15.14	AV
Vertical	11550.18	62.17	-8.84	53.33	74.00	-20.67	PK
Vertical	11550.18	49.17	-8.84	40.33	54.00	-13.67	AV
Vertical	17325.08	58.31	-2.68	55.63	68.20	-12.57	PK
Vertical	17325.08	44.15	-2.68	41.47	54.00	-12.53	AV
Horizontal	4679.19	72.15	-20.24	51.91	74.00	-22.09	PK
Horizontal	4679.19	59.78	-20.24	39.54	54.00	-14.46	AV
Horizontal	11550.15	61.41	-8.84	52.57	74.00	-21.43	PK
Horizontal	11550.15	49.76	-8.84	40.92	54.00	-13.08	AV
Horizontal	17325.07	57.90	-2.68	55.22	68.20	-12.98	PK
Horizontal	17325.07	44.30	-2.68	41.62	54.00	-12.38	AV

Note: PK value is lower than the Average value limit, So average didn't record.

The 26.5-40G amplitude of spurious emissions that are attenuated by more than 20dB below the permissible value has no need to be reported.

Emission level (dBuV/m) = 20 log Emission level (uV/m).

Corrected Reading: Antenna Factor + Cable Loss + Read Level - Preamp Factor = Level.

Test Mode is MIMO Mode.

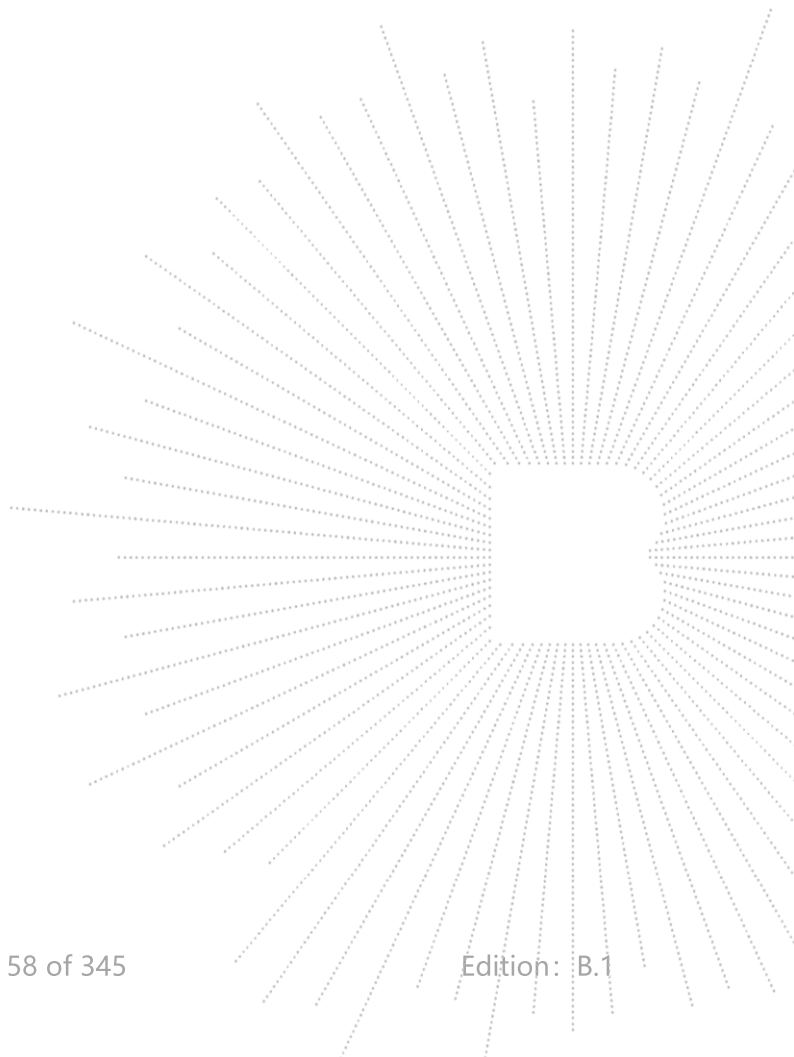

8. Power Spectral Density Test

8.1 Block Diagram Of Test Setup



8.2 Limit

For the band 5.15-5.25 GHz,

(i) For an outdoor access point operating in the band 5.15-5.25 GHz, the maximum power spectral density shall not exceed 17 dBm in any 1 megahertz band. If transmitting antennas of directional gain greater than 6 dBi are used, both the maximum conducted output power and the maximum power spectral density shall be reduced by the amount in dB that the directional gain of the antenna exceeds 6 dBi. The maximum e.i.r.p. at any elevation angle above 30 degrees as measured from the horizon must not exceed 125 mW (21 dBm).

(ii) For an indoor access point operating in the band 5.15-5.25 GHz, the maximum power spectral density shall not exceed 17 dBm in any 1 megahertz band. If transmitting antennas of directional gain greater than 6 dBi are used, both the maximum conducted output power and the maximum power spectral density shall be reduced by the amount in dB that the directional gain of the antenna exceeds 6 dBi.

(iii) For fixed point-to-point access points operating in the band 5.15-5.25 GHz, the maximum power spectral density shall not exceed 17 dBm in any 1 megahertz band. Fixed point-to-point U-NII devices may employ antennas with directional gain up to 23 dBi without any corresponding reduction in the maximum conducted output power or maximum power spectral density. For fixed point-to-point transmitters that employ a directional antenna gain greater than 23 dBi, a 1 dB reduction in maximum conducted output power and maximum power spectral density is required for each 1 dB of antenna gain in excess of 23 dBi. Fixed, point-to-point operations exclude the use of point-to-multipoint systems, omnidirectional applications, and multiple collocated transmitters transmitting the same information. The operator of the U-NII device, or if the equipment is professionally installed, the installer, is responsible for ensuring that systems employing high gain directional antennas are used exclusively for fixed, point-to-point operations.

(iv) For client devices in the 5.15-5.25 GHz band, the maximum power spectral density shall not exceed 11 dBm in any 1 megahertz band. If transmitting antennas of directional gain greater than 6 dBi are used, both the maximum conducted output power and the maximum power spectral density shall be reduced by the amount in dB that the directional gain of the antenna exceeds 6 dBi.

For the band 5.725-5.85 GHz

For the 5.25-5.35 GHz and 5.47-5.725 GHz bands

(b) (2) The maximum conducted output power over the frequency bands of operation shall not exceed the lesser of 250 mW or $11 \text{ dBm} + 10 \log B$, where B is the 26 dB emission bandwidth in megahertz. In addition, the maximum power spectral density shall not exceed 11 dBm in any 1 megahertz band. If transmitting antennas of directional gain greater than 6 dBi are used, both the maximum conducted output power and the maximum power spectral density shall be reduced by the amount in dB that the directional gain of the antenna exceeds 6 dBi.

(3) For the band 5.725-5.85 GHz, the maximum power spectral density shall not exceed 30 dBm in any 500-kHz band. If transmitting antennas of directional gain greater than 6 dBi are used, both the maximum conducted output power and the maximum power spectral density shall be reduced by the amount in dB that the directional gain of the antenna exceeds 6 dBi.

8.3 Test Procedure

For devices operating in the bands 5.15-5.25 GHz, 5.25-5.35 GHz, and 5.47-5.725 GHz, the above procedures make use of 1 MHz RBW to satisfy directly the 1 MHz reference bandwidth specified in § 15.407(a)(5). For devices operating in the band 5.725-5.85 GHz, the rules specify a measurement bandwidth of 500 kHz. Many spectrum analyzers do not have 500 kHz RBW, thus a narrower RBW may need to be used. The rules permit the use of a RBWs less than 1 MHz, or 500 kHz, "provided that the measured power is integrated over the full reference bandwidth" to show the total power over the specified measurement bandwidth (i.e., 1 MHz, or 500 kHz). If measurements are performed using a reduced resolution bandwidth (< 1 MHz, or < 500 kHz) and integrated over 1 MHz, or 500 kHz bandwidth, the following adjustments to the procedures apply:

- a) Set $RBW \geq 1/T$, where T is defined in section II.B.I.a).
- b) Set $VBW \geq 3 RBW$.
- c) If measurement bandwidth of Maximum PSD is specified in 500 kHz, add $10\log(500\text{kHz}/RBW)$ to the measured result, whereas RBW (< 500 kHz) is the reduced resolution bandwidth of the spectrum analyzer set during measurement.
- d) If measurement bandwidth of Maximum PSD is specified in 1 MHz, add $10\log(1\text{MHz}/RBW)$ to the measured result, whereas RBW (< 1 MHz) is the reduced resolution bandwidth of spectrum analyzer set during measurement.
- e) Care must be taken to ensure that the measurements are performed during a period of continuous transmission or are corrected upward for duty cycle.

Note: As a practical matter, it is recommended to use reduced RBW of 100 kHz for the sections 5.c) and 5.d) above, since RBW=100 kHz is available on nearly all spectrum analyzers.

8.4 EUT Operating Conditions

The EUT was configured for testing in a typical fashion (as a customer would normally use it). The EUT has been programmed to continuously transmit during test. This operating condition was tested and used to collect the included data.

8.5 Test Result

Temperature:	26 °C	Relative Humidity:	54%
Pressure:	101KPa	Test Voltage:	AC 120V/60Hz
Test Mode:	(5180-5240MHz)		

Condition	Mode	Frequency (MHz)	Conducted PSD (dBm/MHz)		Total (dBm/MHz)	Limit (dBm/MHz)	Verdict
			Ant A	Ant B			
NVNT	a	5180	0.93	1.42	/	11	Pass
NVNT	a	5200	1.68	1.51	/	11	Pass
NVNT	a	5240	1.39	0.91	/	11	Pass
NVNT	n20	5180	0.75	0.44	3.61	11	Pass
NVNT	n20	5200	0.35	0.04	3.21	11	Pass
NVNT	n20	5240	-0.03	-0.82	2.60	11	Pass
NVNT	n40	5190	-3.6	-3.85	-0.71	11	Pass
NVNT	n40	5230	-4.92	-4.52	-1.71	11	Pass
NVNT	ac20	5180	0.47	0.19	3.34	11	Pass
NVNT	ac20	5200	0.15	-0.12	3.03	11	Pass
NVNT	ac20	5240	-1.04	-0.61	2.19	11	Pass
NVNT	ac40	5190	-3.79	-3.94	-0.85	11	Pass
NVNT	ac40	5230	-5.03	-4.57	-1.78	11	Pass
NVNT	ac80	5210	-6.77	-7.34	-4.04	11	Pass
NVNT	ax20	5180	-0.23	0.14	2.97	11	Pass
NVNT	ax20	5200	0.19	-0.3	2.96	11	Pass
NVNT	ax20	5240	-1.03	-0.22	2.40	11	Pass
NVNT	ax40	5190	-3.88	-3.97	-0.91	11	Pass
NVNT	ax40	5230	-5.03	-4.65	-1.83	11	Pass
NVNT	ax80	5210	-6.74	-6.76	-3.74	11	Pass

Note:

Antenna A gain:2.55 dBi, Antenna B gain: 2.55 dBi, Directional gain=[GainANT + 10 log(NANT/NSS) dBi]

=5.56 dBi < 6dBi

EIRP Limit=10 dBi

Note: A(B) Represent the value of antenna A and B, The worst data is Antenna A, only shown Antenna A Plot.

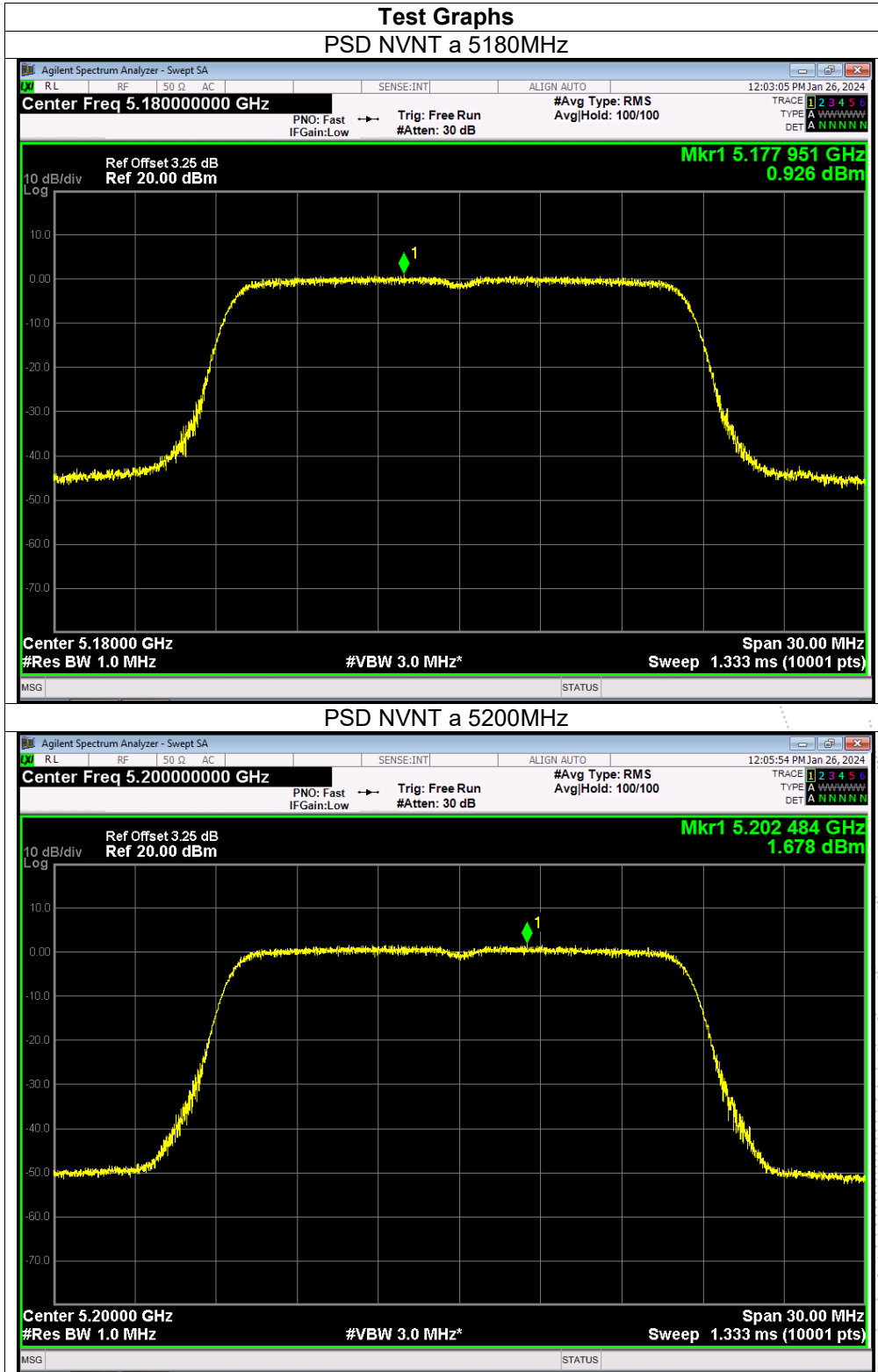

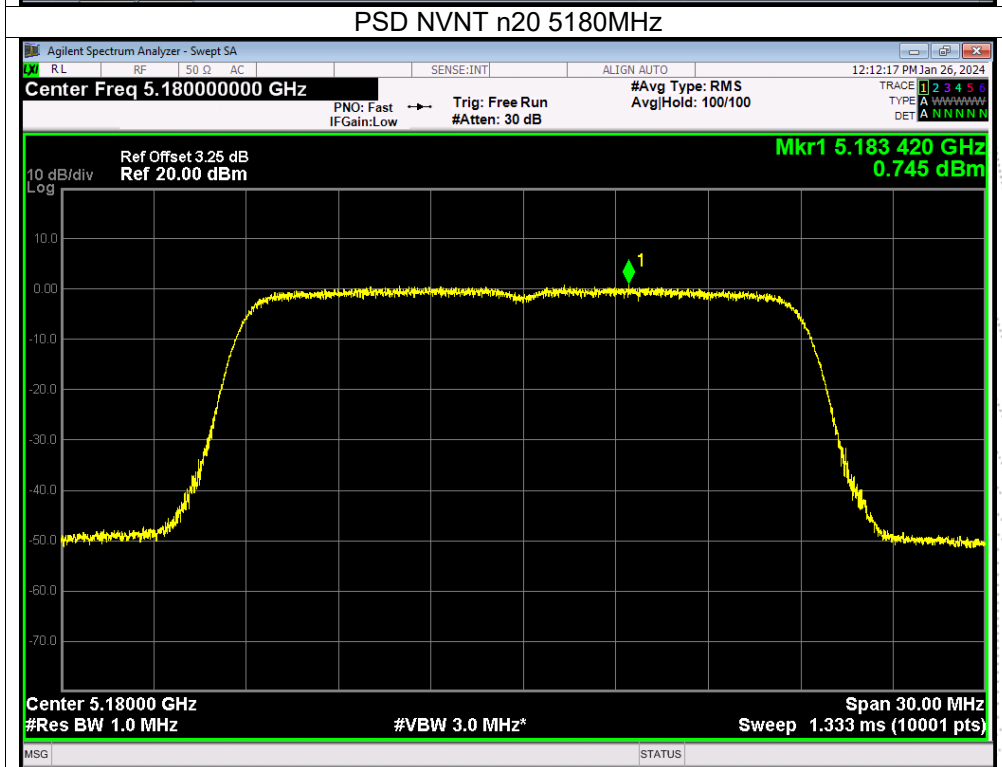
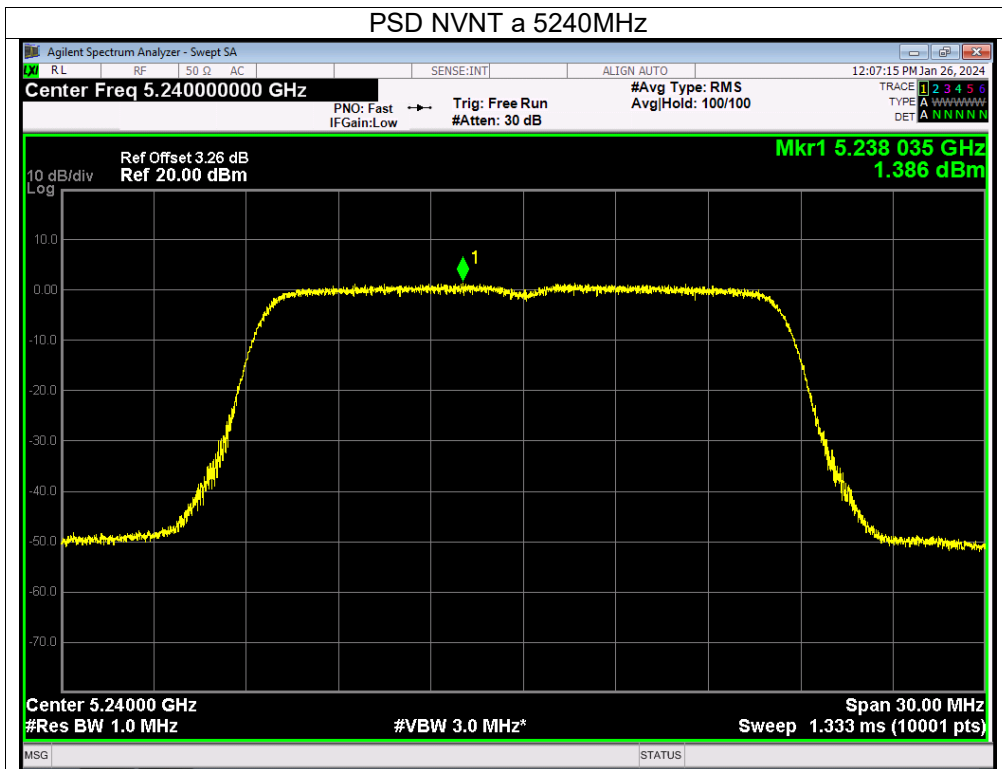

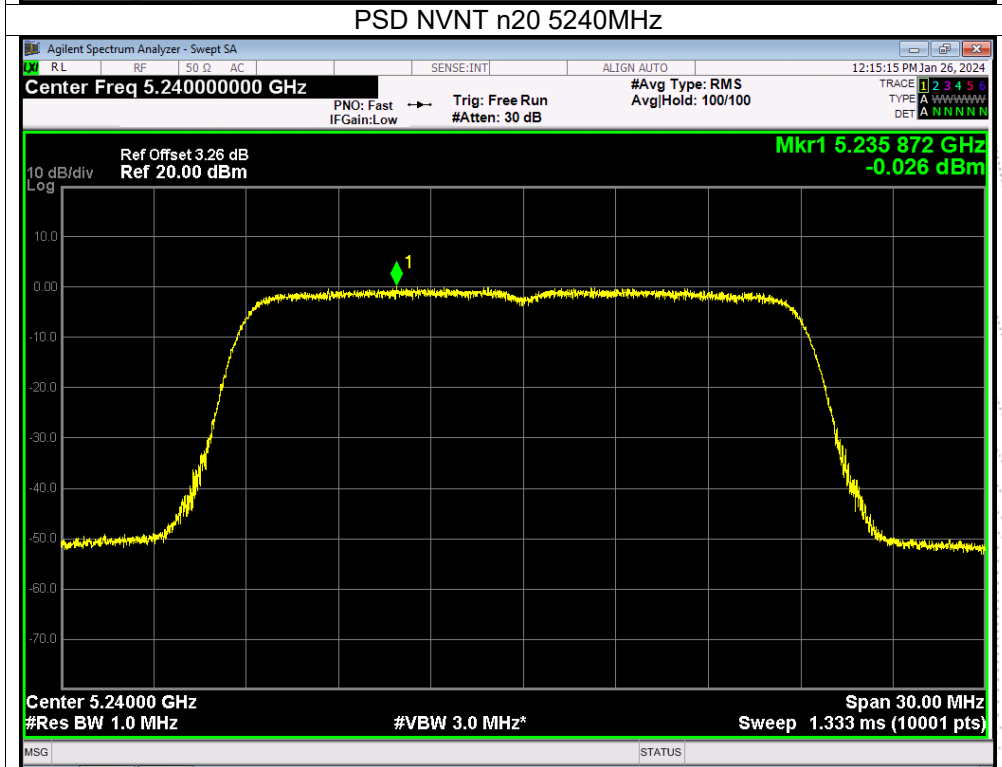
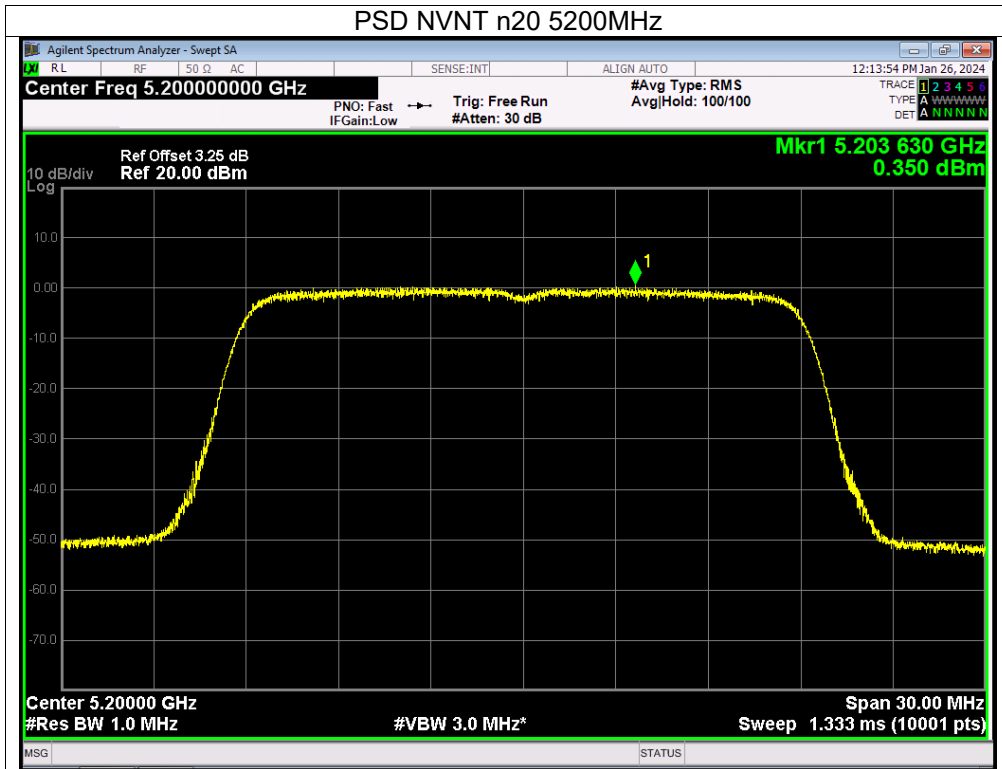

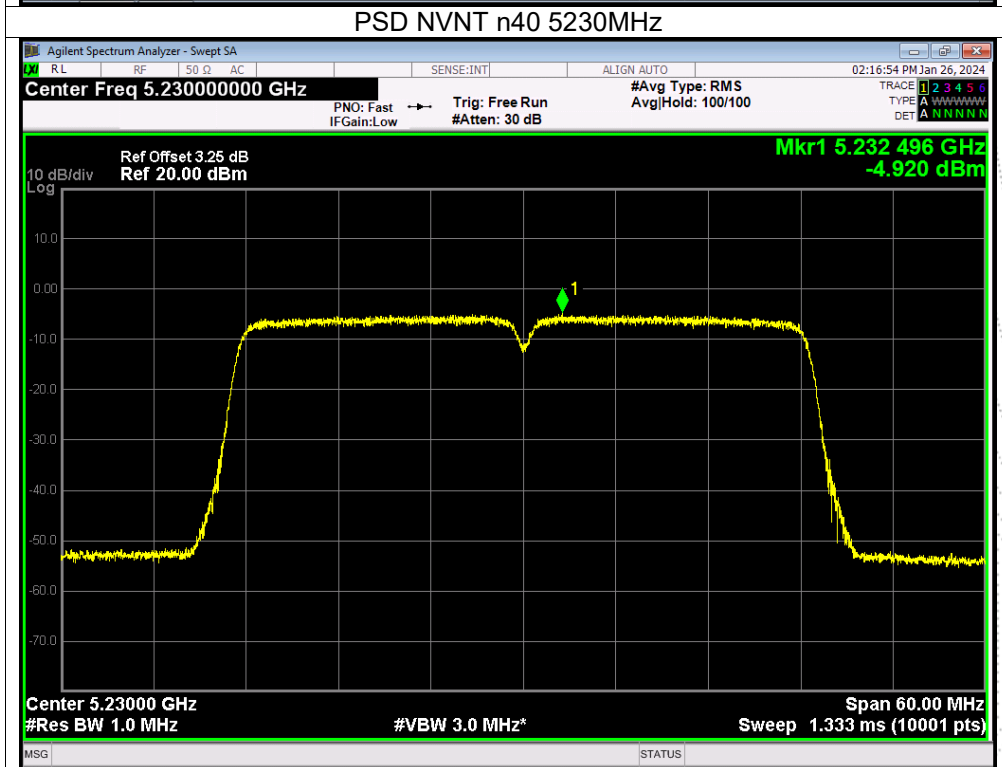
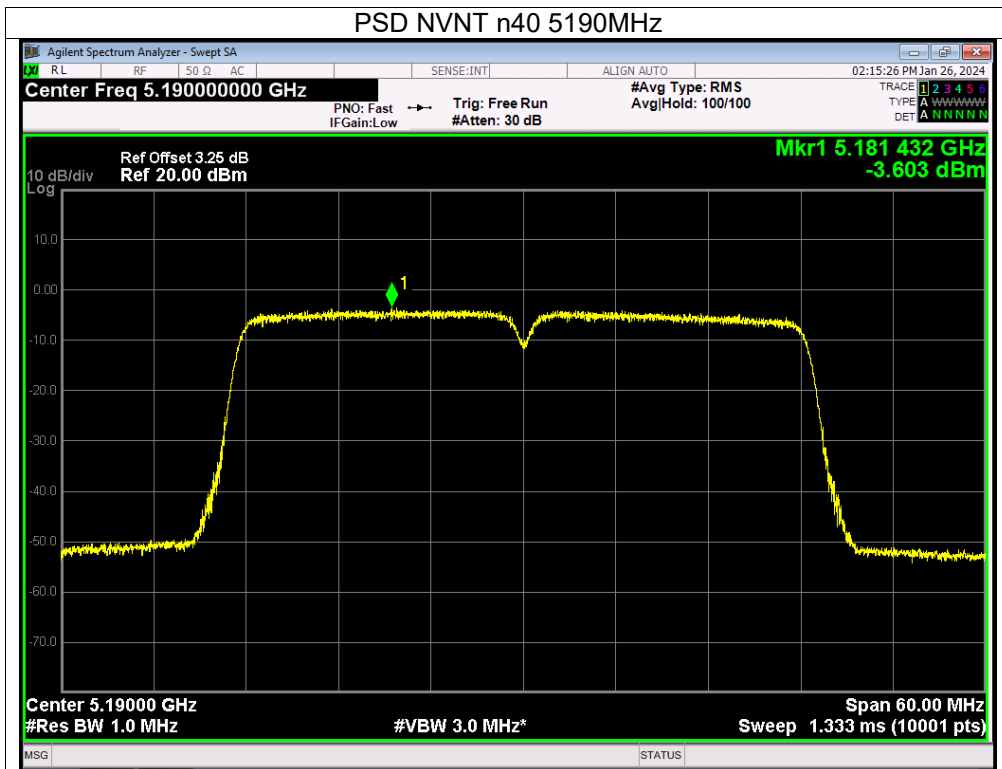

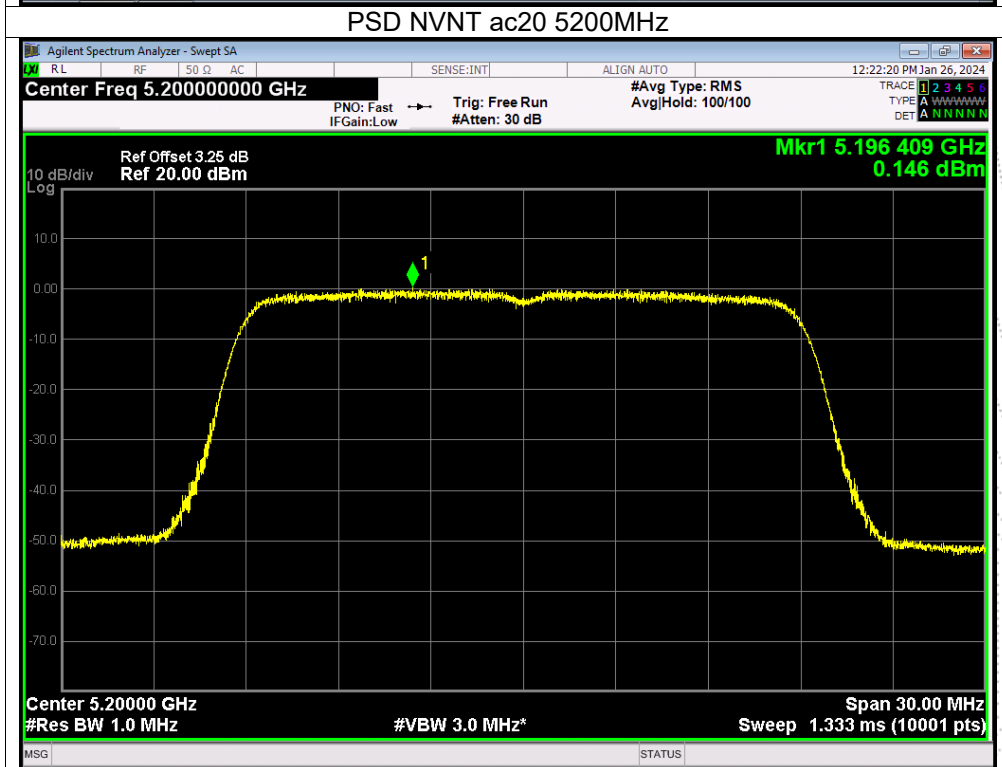
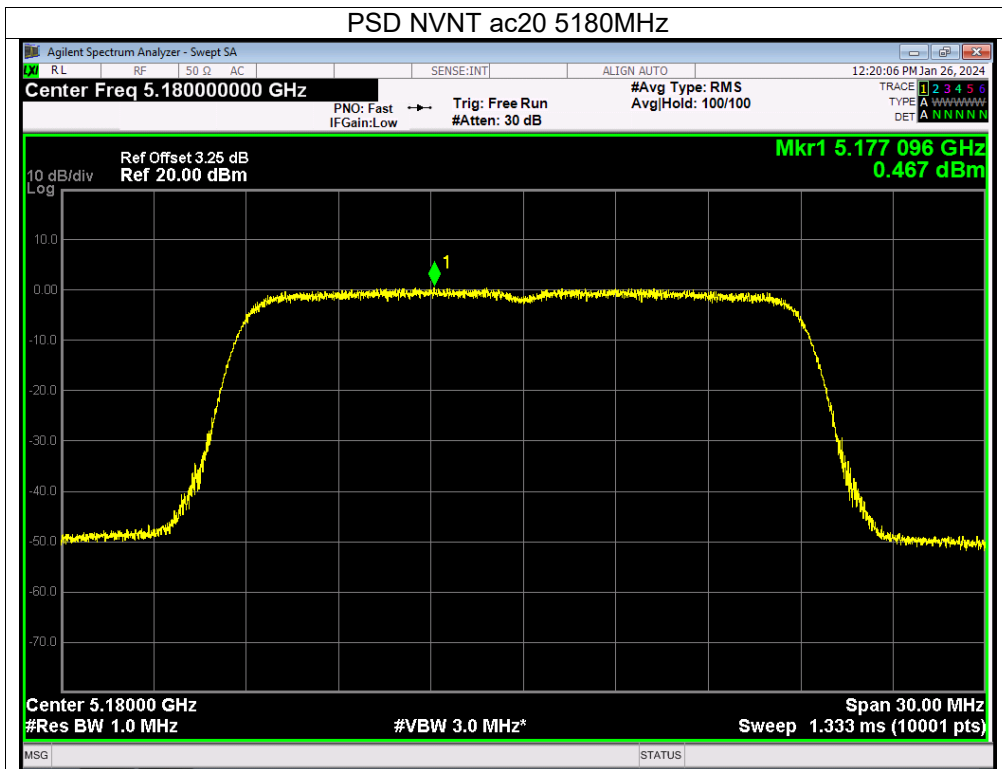

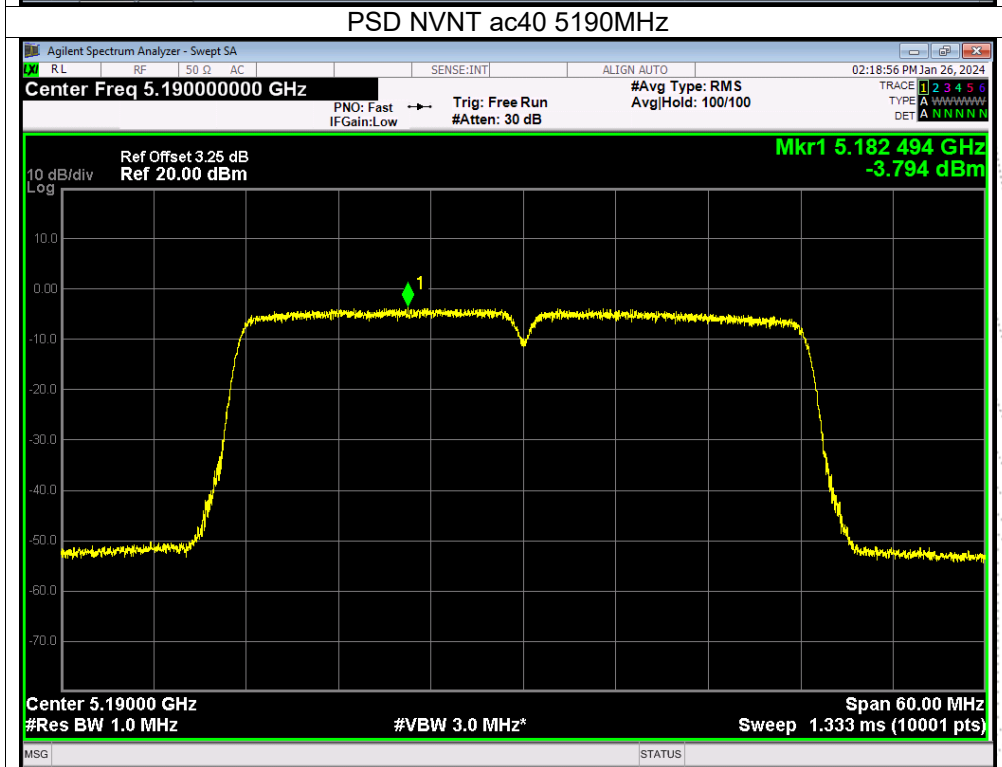
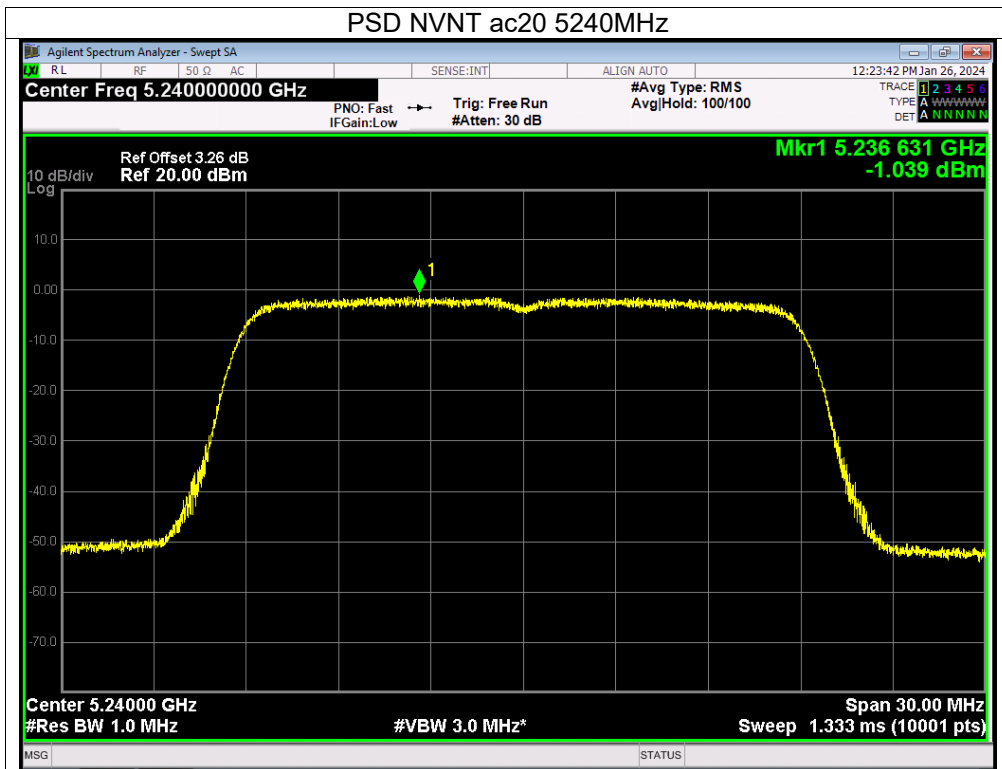

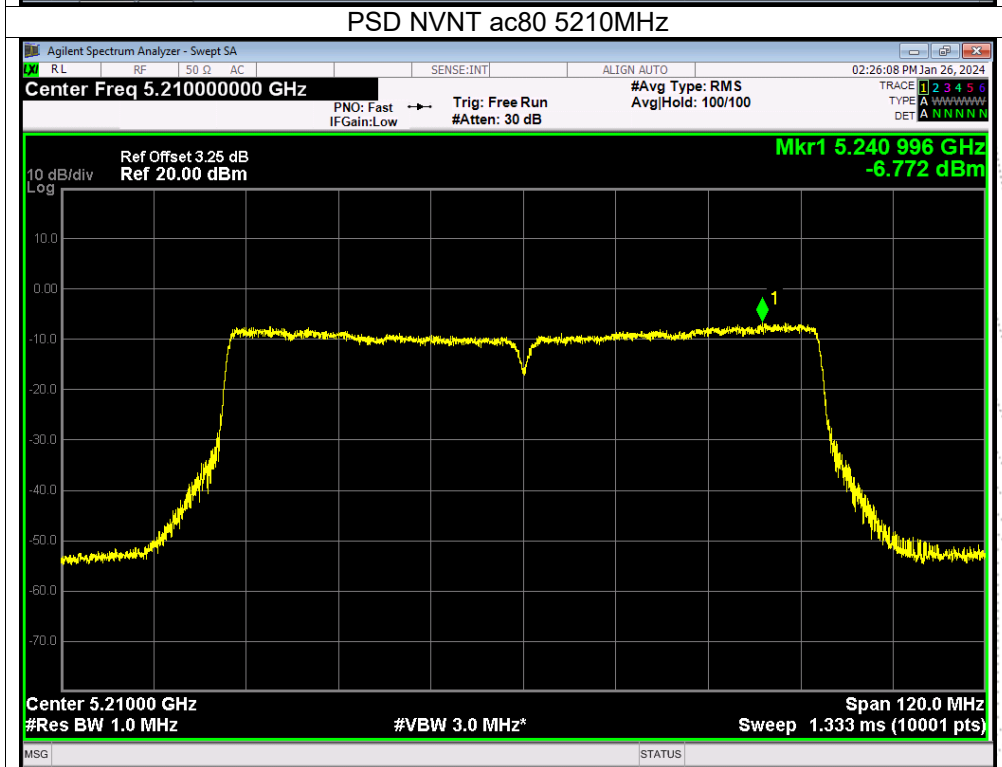
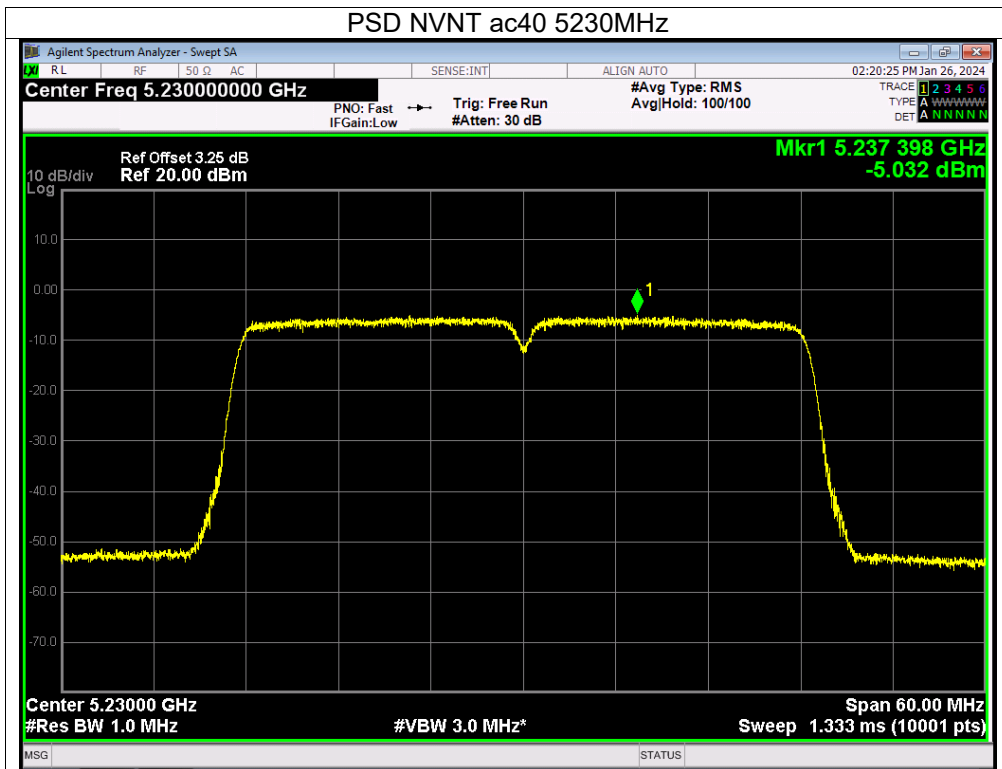

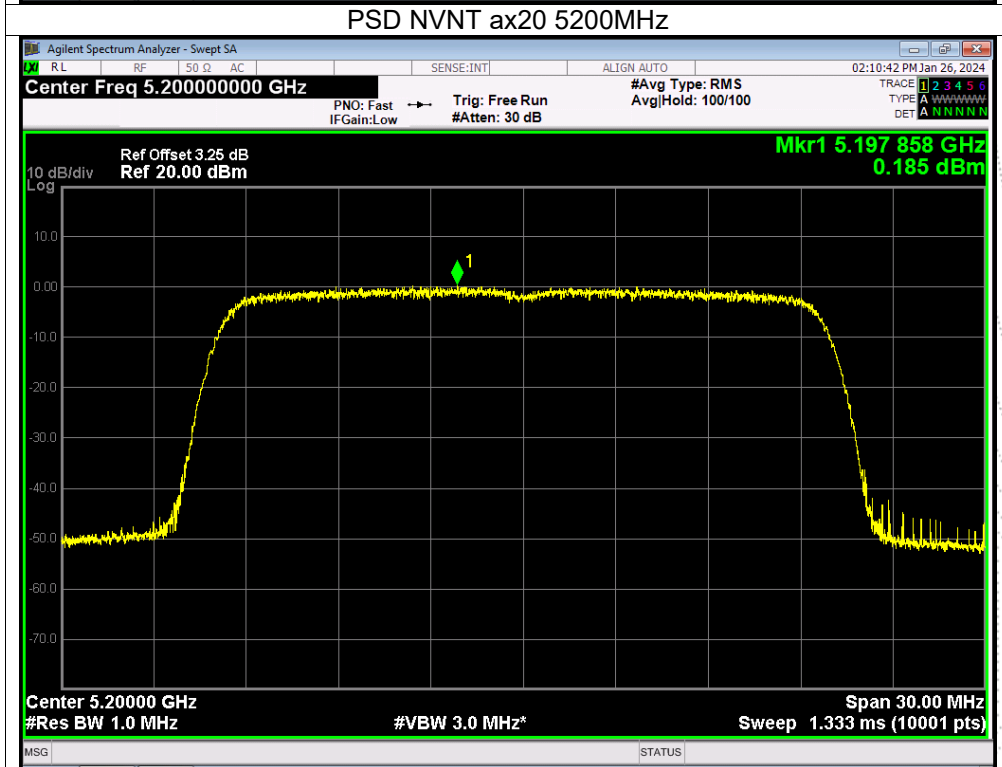
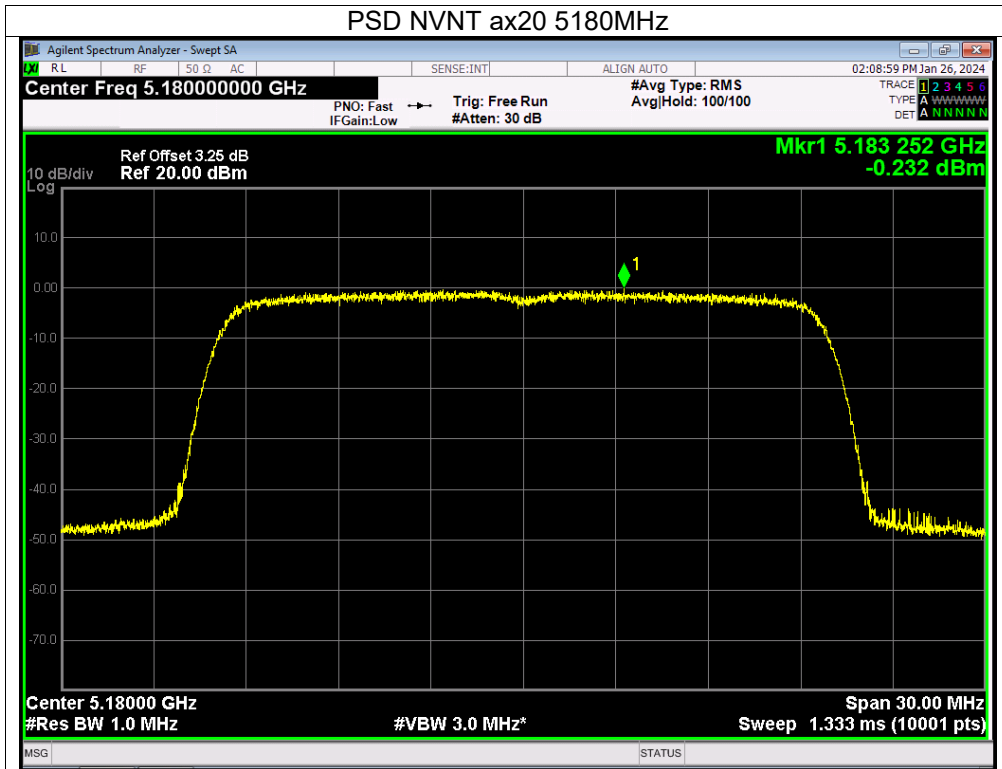

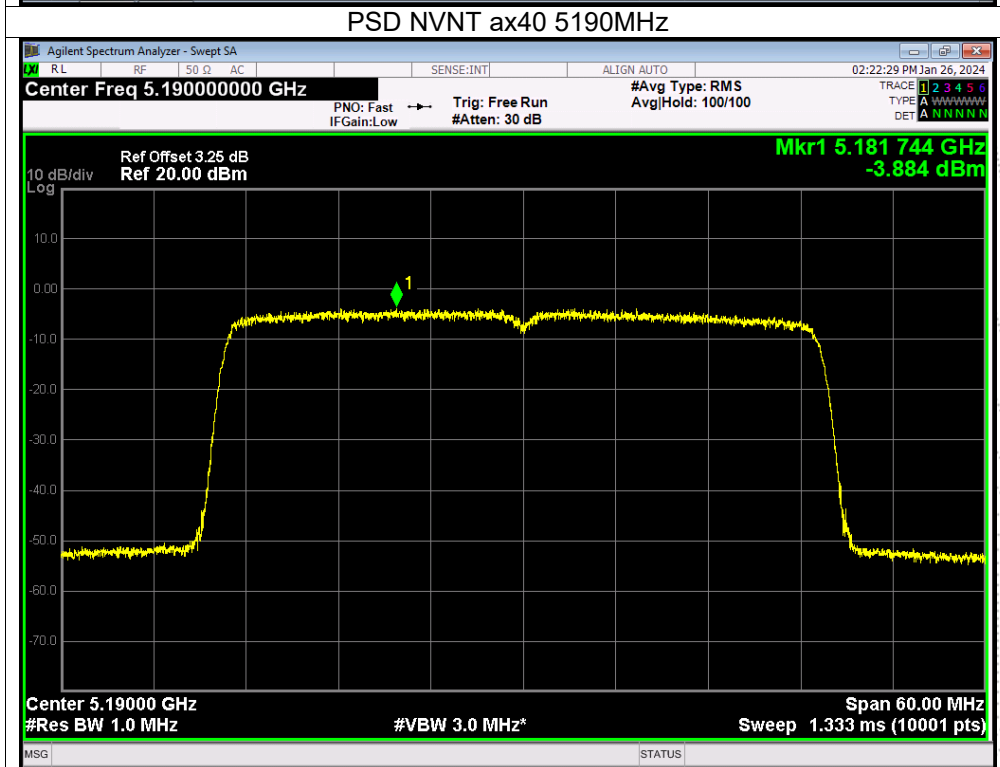
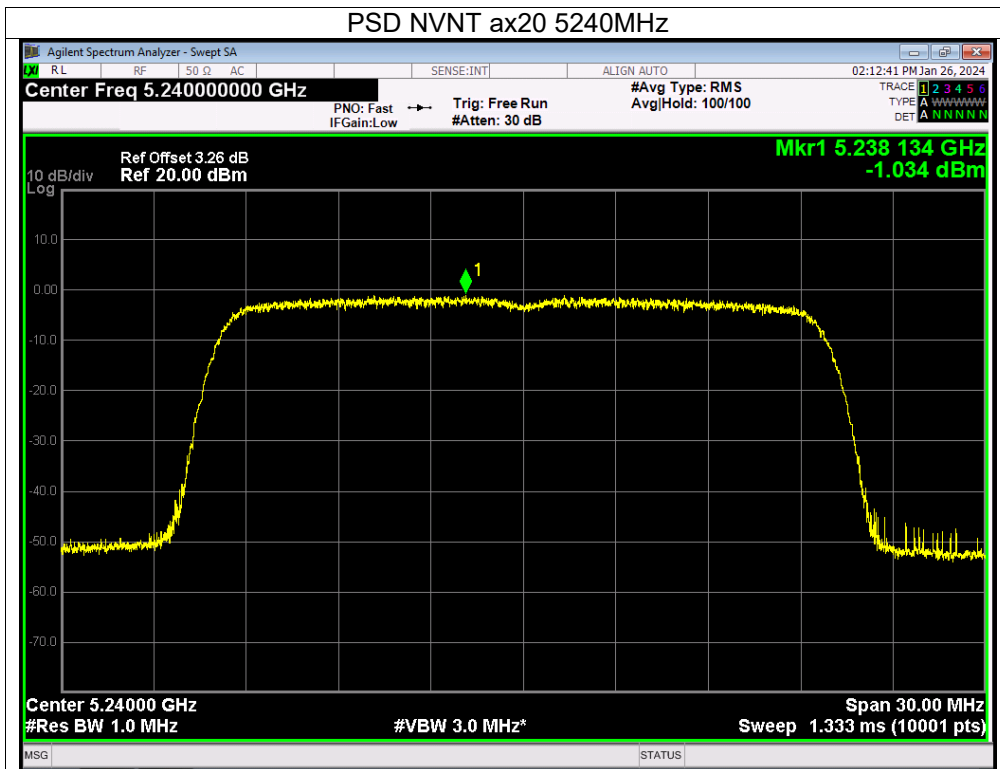

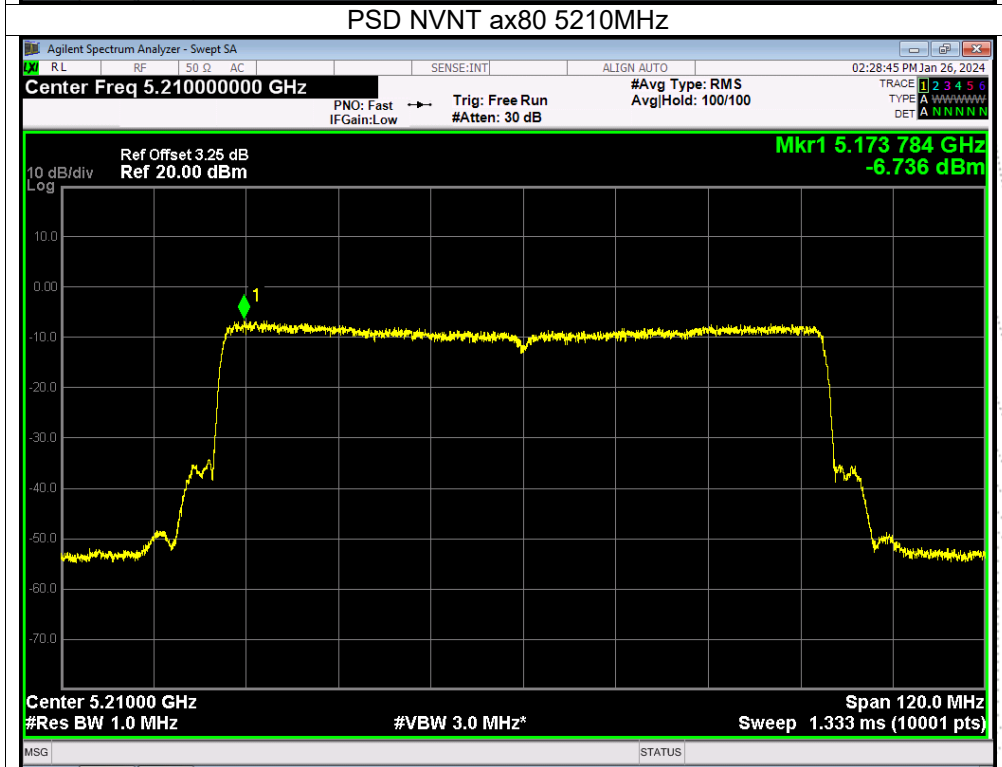
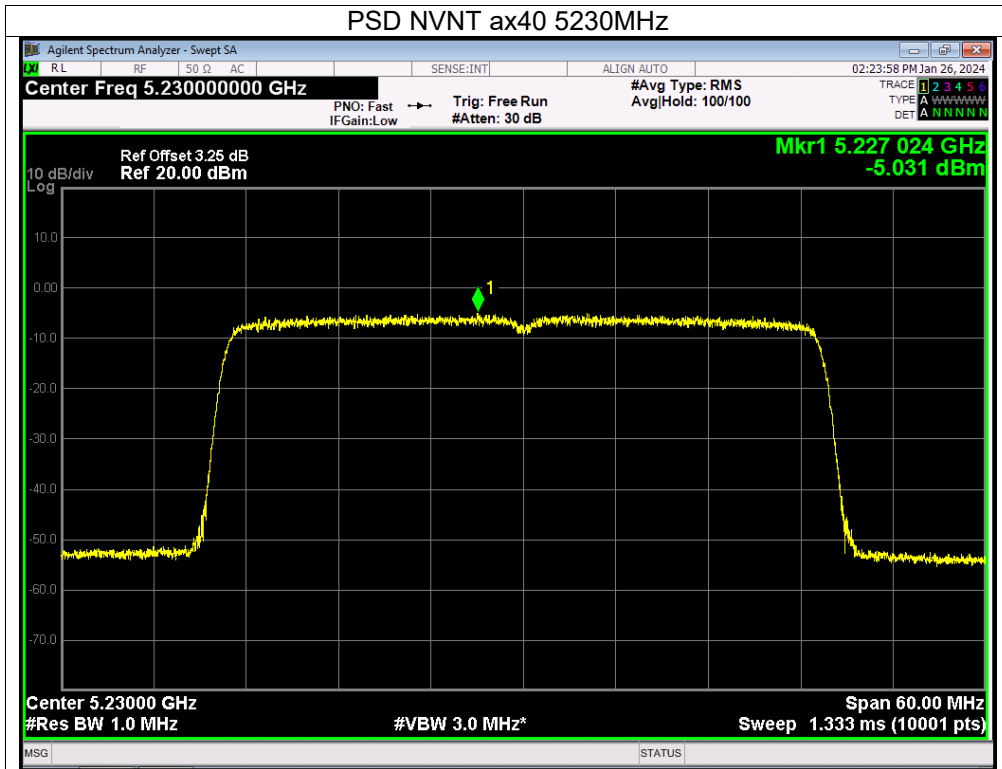

Temperature:	26 °C	Relative Humidity:	54%
Pressure:	101KPa	Test Voltage:	AC 120V/60Hz
Test Mode:	(5260-5320MHz)		

Condition	Mode	Frequency (MHz)	Conducted PSD (dBm/MHz)		Total (dBm/MHz)	Limit (dBm/MHz)	Verdict
			Ant A	Ant B			
NVNT	a	5260	1.7	2.15	/	11	Pass
NVNT	a	5280	1.72	1.69	/	11	Pass
NVNT	a	5320	0.41	-0.15	/	11	Pass
NVNT	n20	5260	0.76	1.07	3.93	11	Pass
NVNT	n20	5280	0.33	0.56	3.46	11	Pass
NVNT	n20	5320	-0.81	-0.68	2.27	11	Pass
NVNT	n40	5270	-3.2	-4.42	-0.76	11	Pass
NVNT	n40	5310	-3.86	-4.96	-1.36	11	Pass
NVNT	ac20	5260	0.88	0.65	3.78	11	Pass
NVNT	ac20	5280	0.54	-0.58	3.03	11	Pass
NVNT	ac20	5320	-0.66	-1.44	1.98	11	Pass
NVNT	ac40	5270	-2.87	-4.37	-0.55	11	Pass
NVNT	ac40	5310	-4.06	-5.17	-1.57	11	Pass
NVNT	ac80	5290	-7.29	-7.94	-4.59	11	Pass
NVNT	ax20	5260	0.61	-0.01	3.32	11	Pass
NVNT	ax20	5280	0.34	-0.56	2.92	11	Pass
NVNT	ax20	5320	-0.99	-1.16	1.94	11	Pass
NVNT	ax40	5270	-3.26	-3.68	-0.45	11	Pass
NVNT	ax40	5310	-4.23	-5.44	-1.78	11	Pass
NVNT	ax80	5290	-7.42	-7.99	-4.69	11	Pass

Note:

Antenna A gain:2.55 dBi, Antenna B gain: 2.55 dBi, Directional gain=[GainANT + 10 log(NANT/NSS) dBi]
 =5.56 dBi < 6dBi
 Limit=11 dBi

Note: A(B) Represent the value of antenna A and B, The worst data is Antenna B, only shown Antenna B Plot.

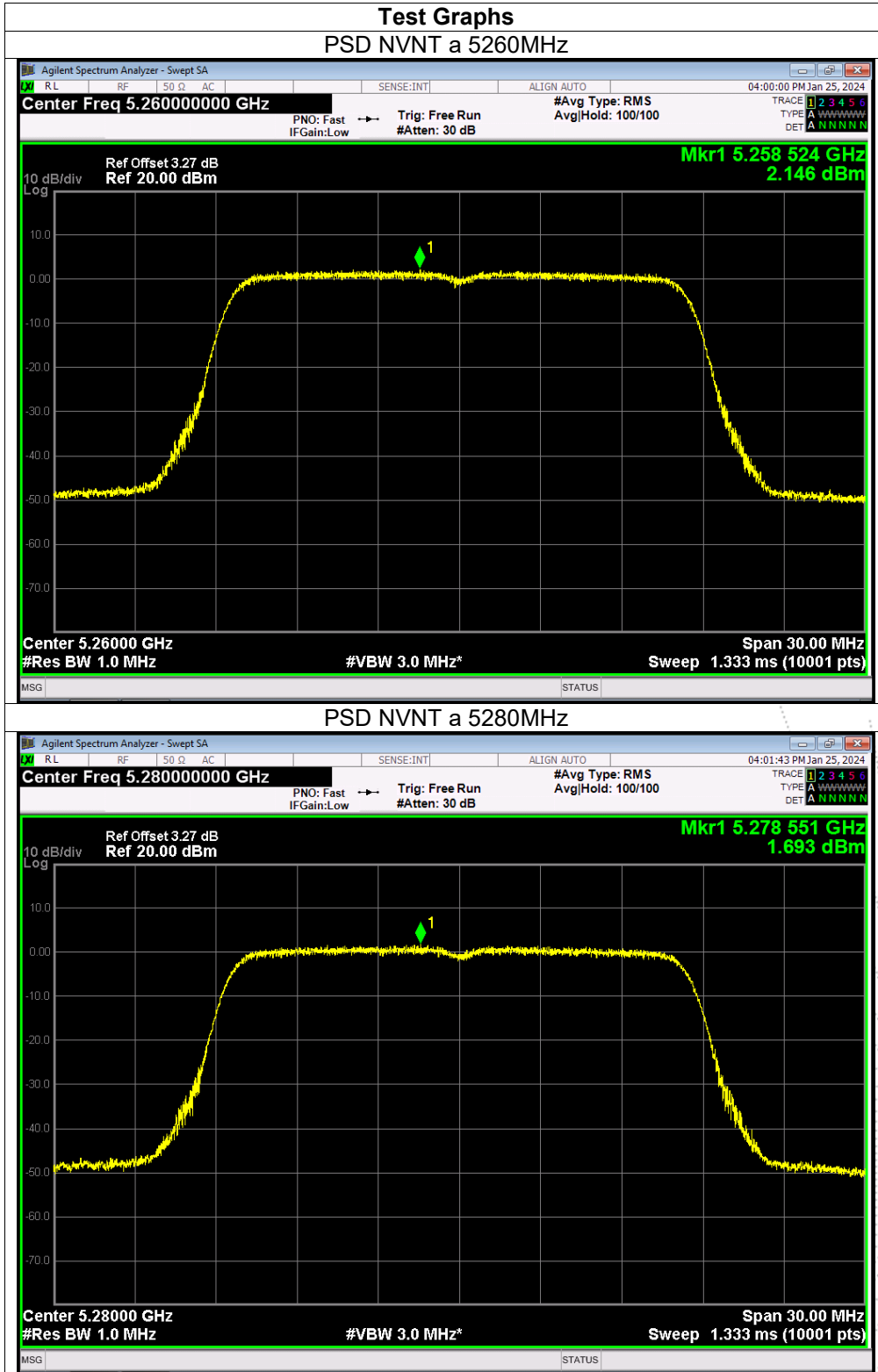

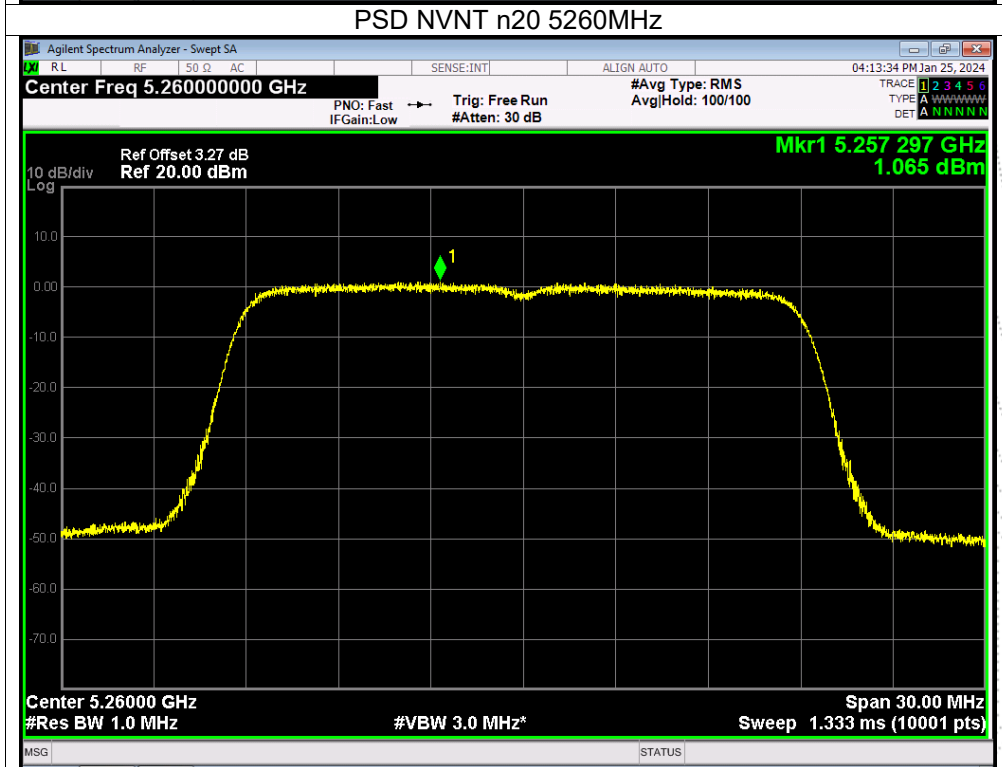
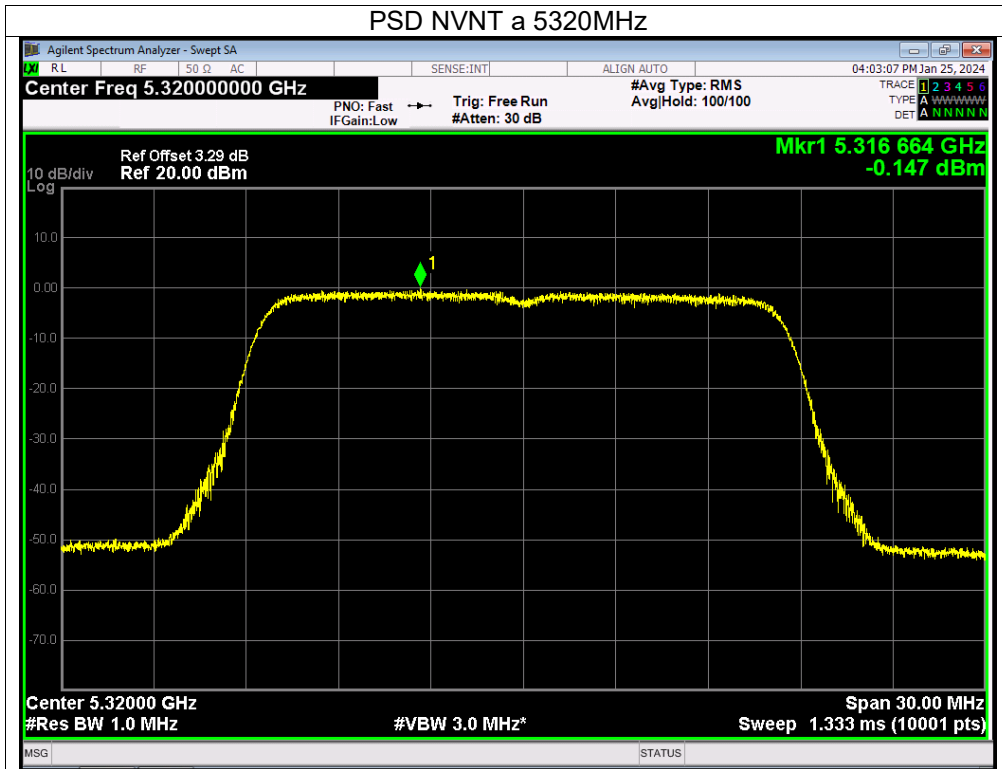

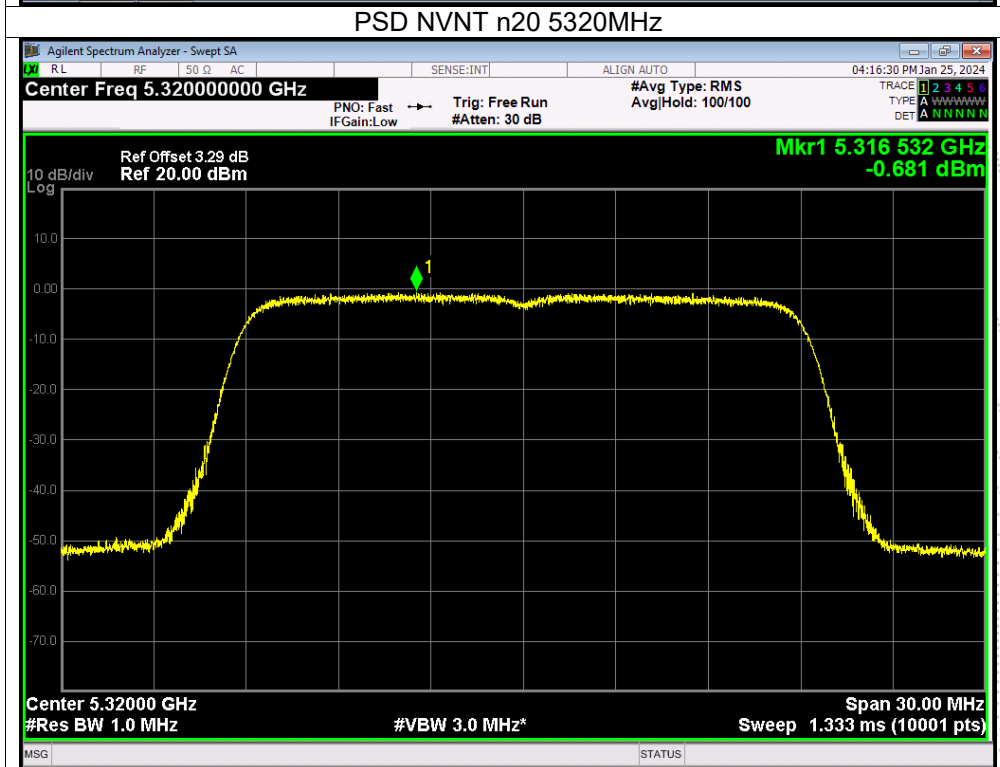
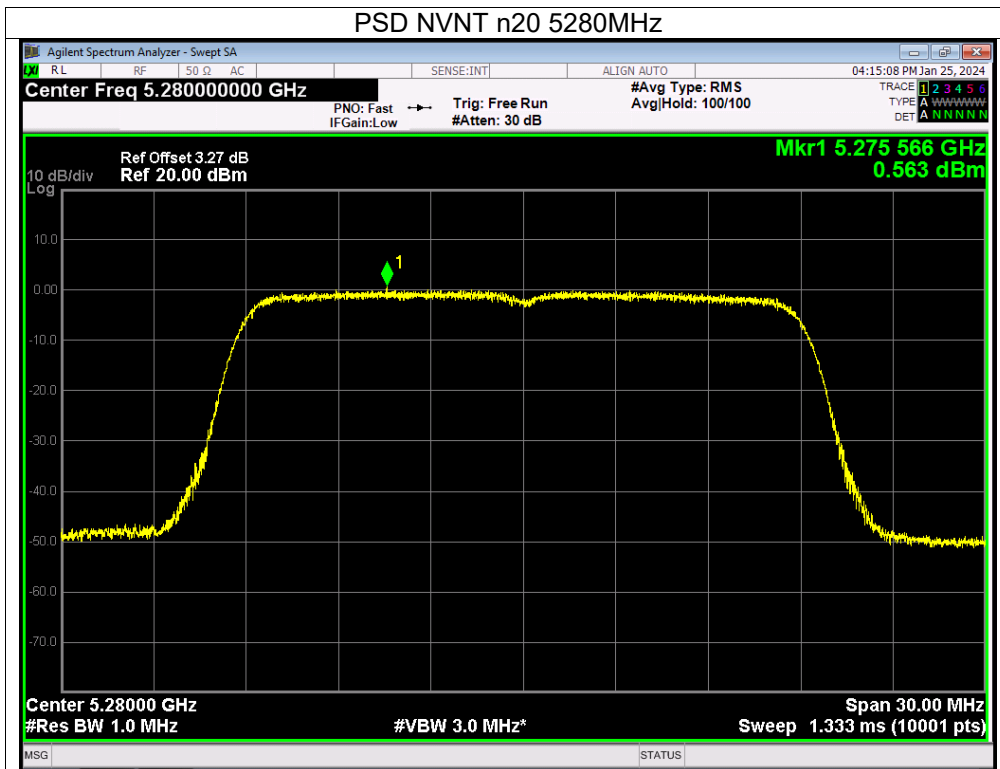

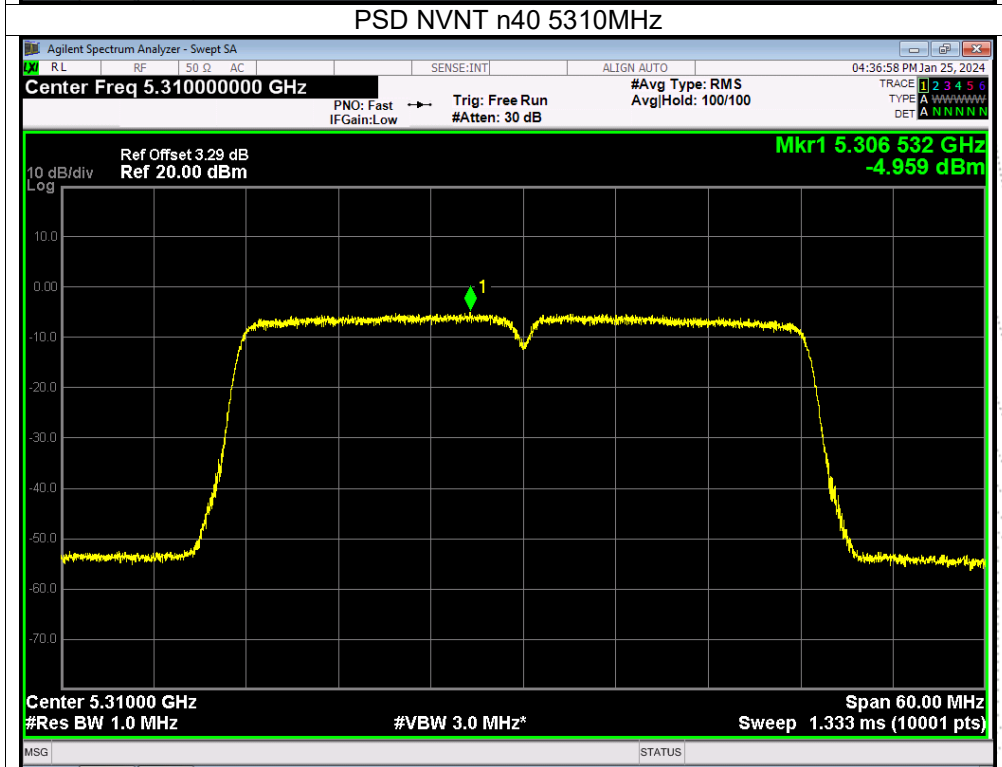
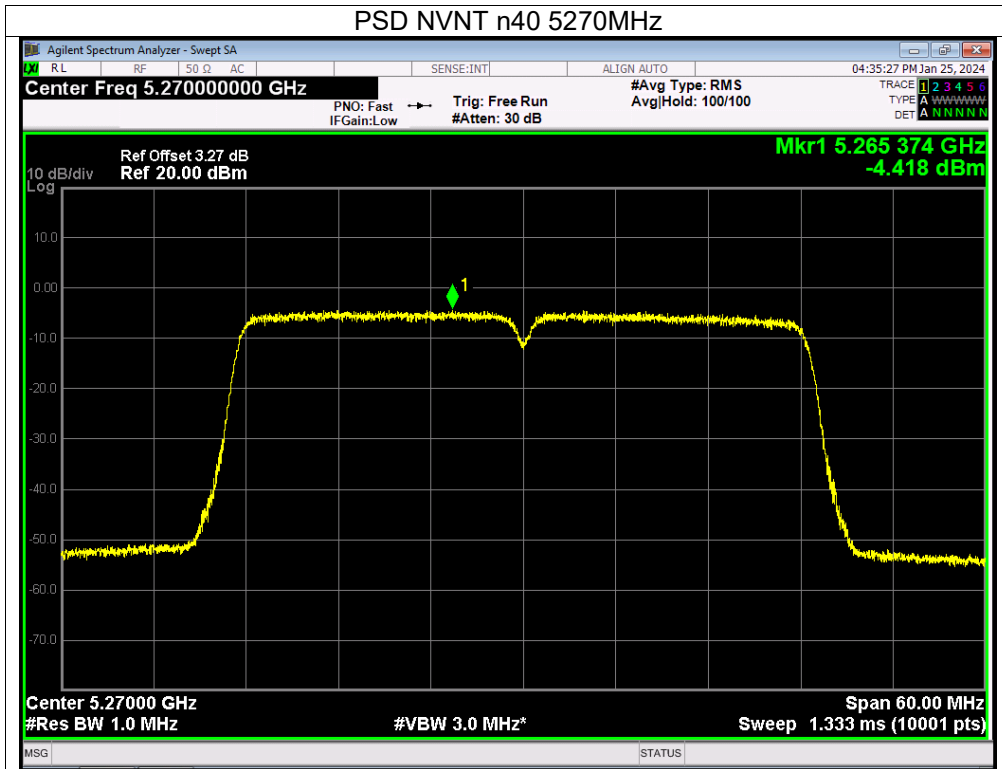

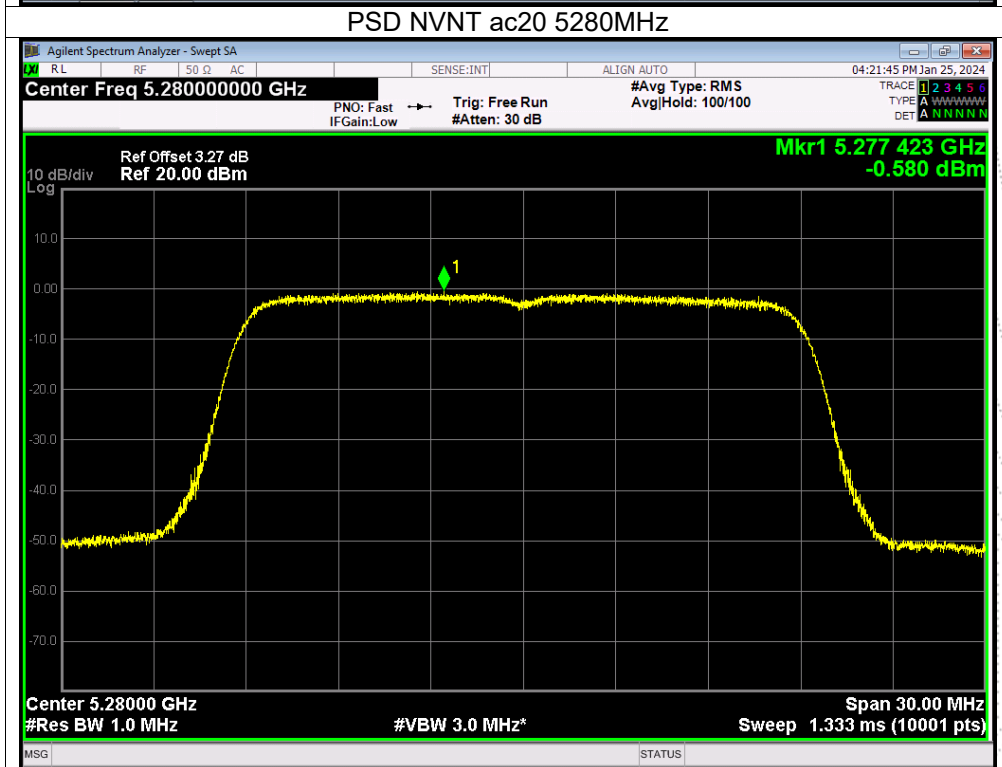
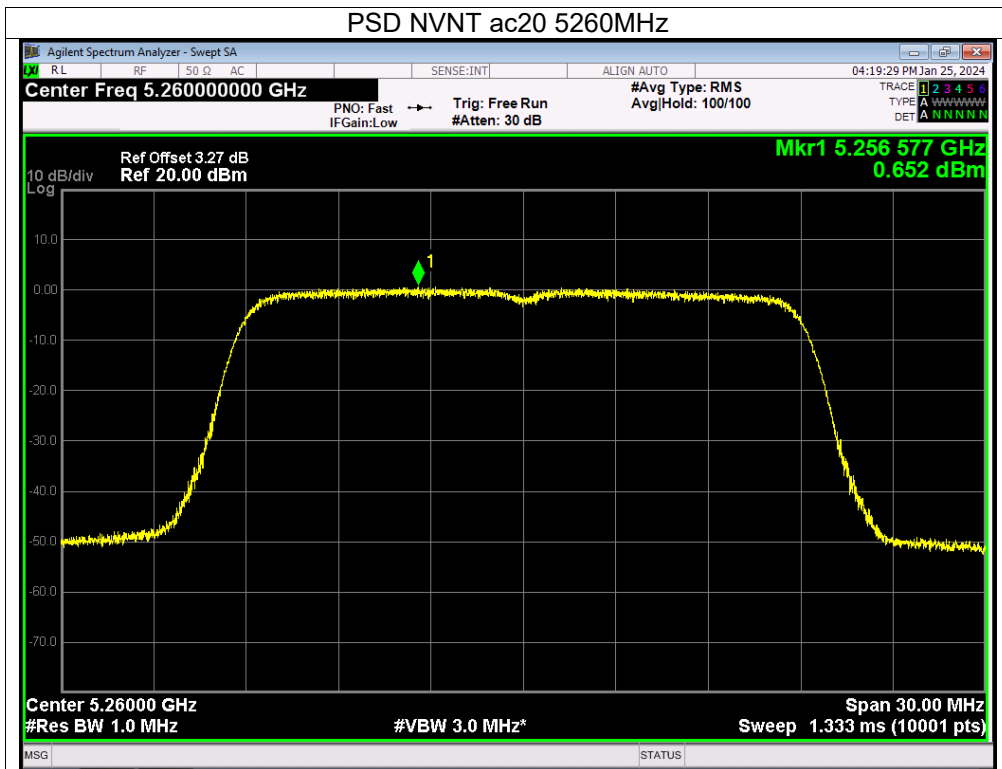

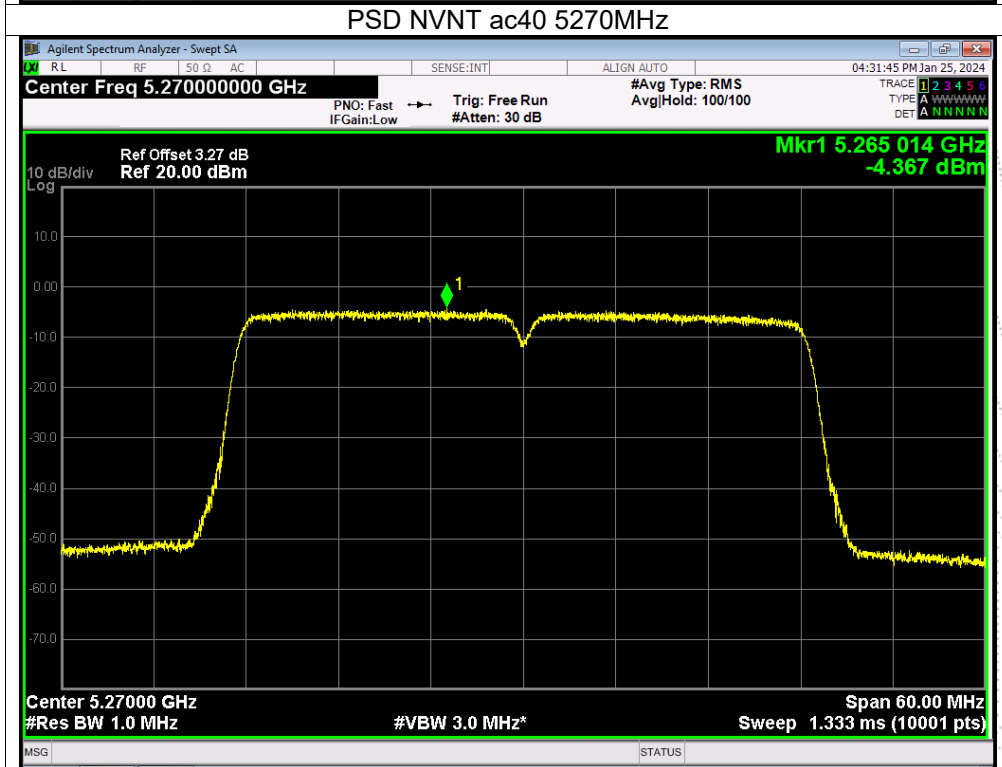
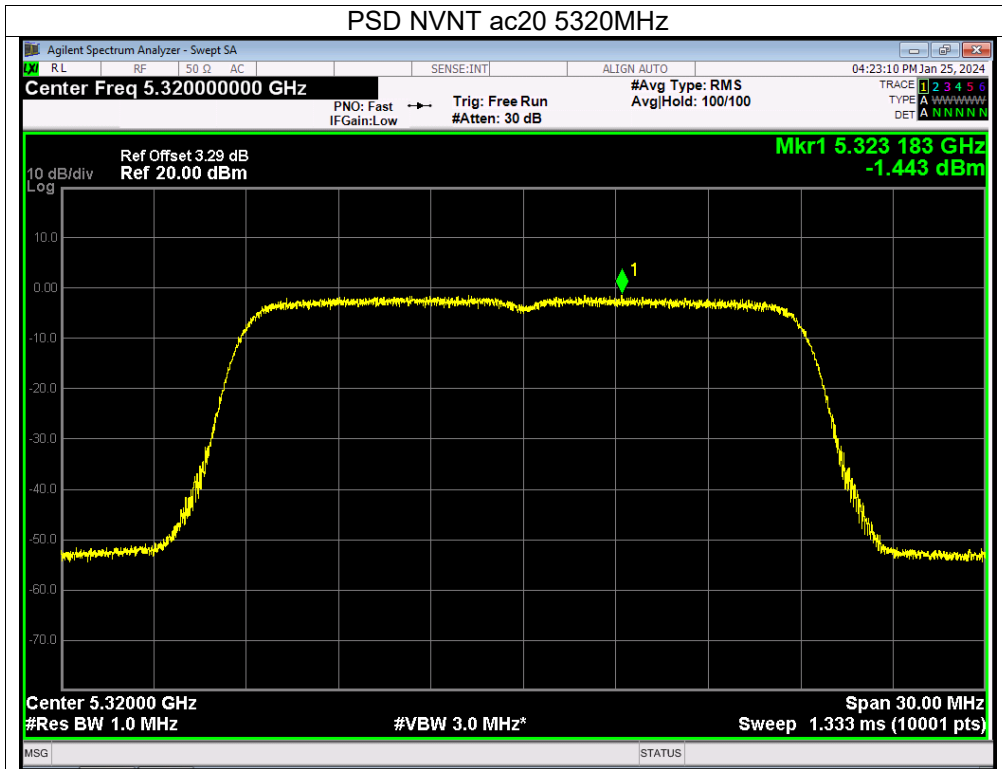

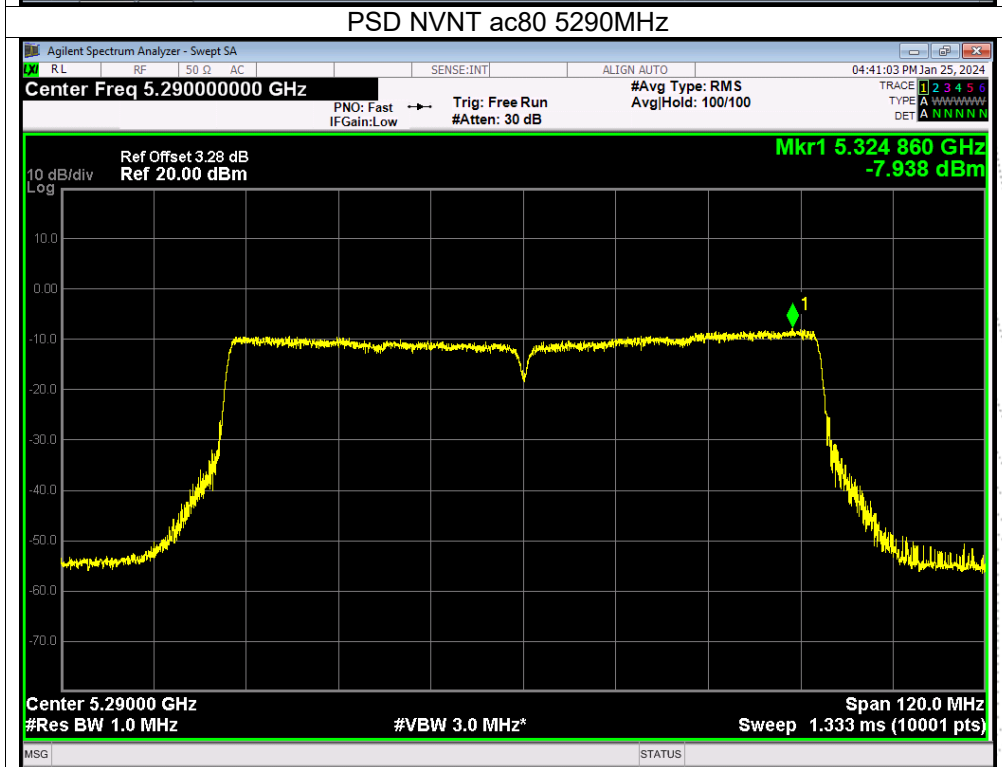
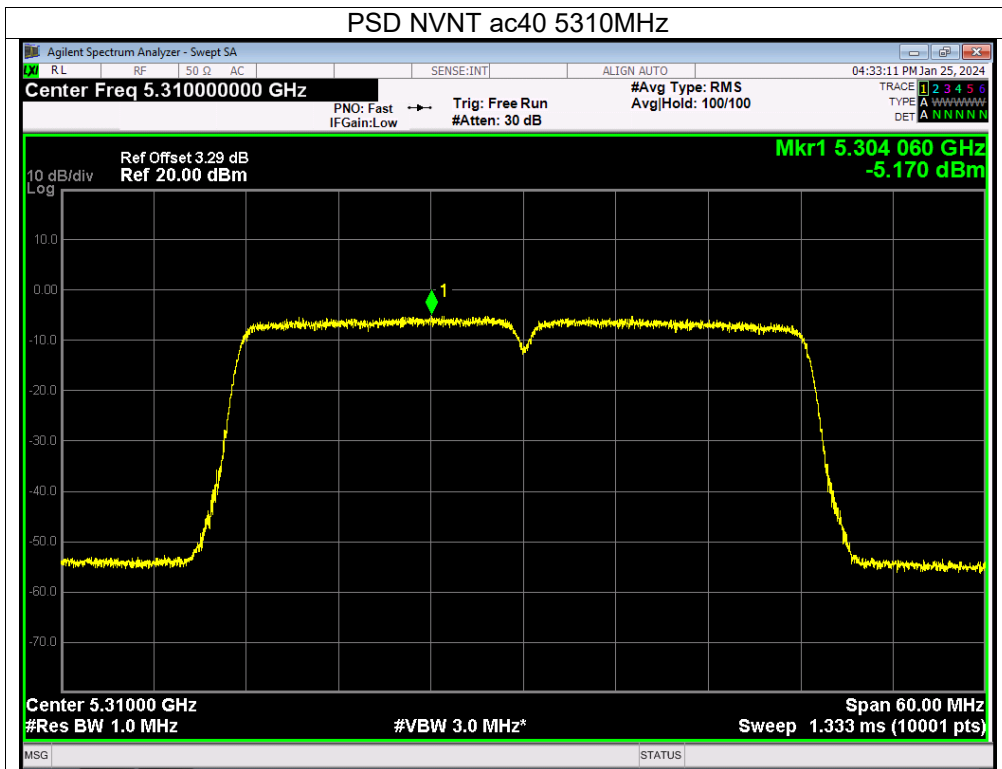

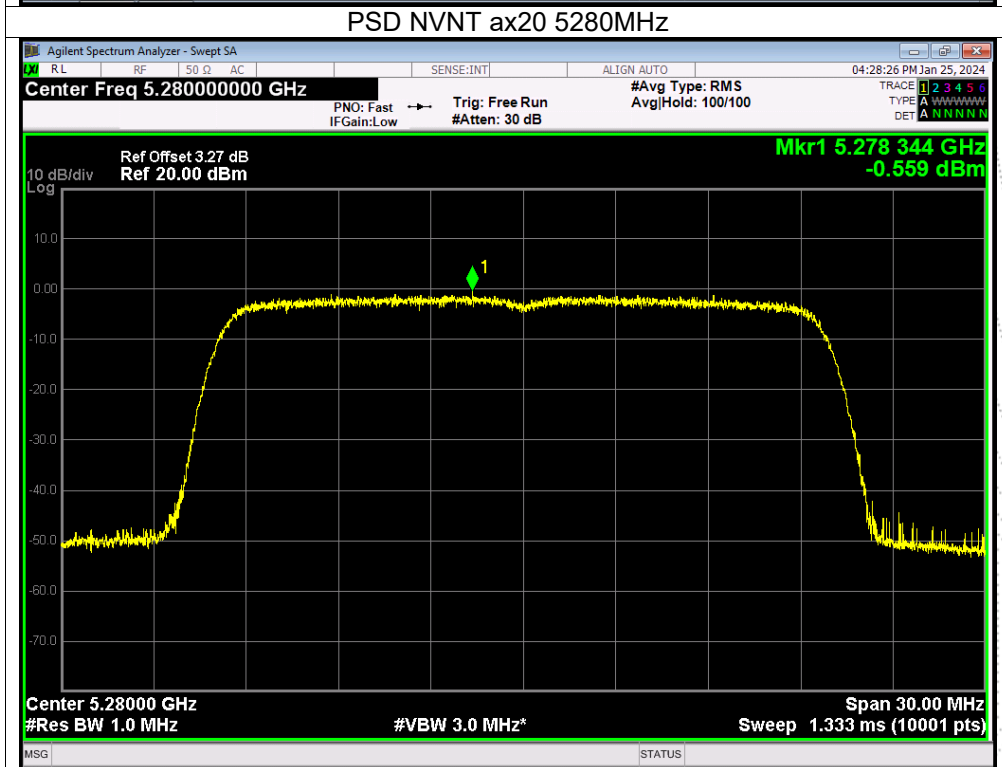
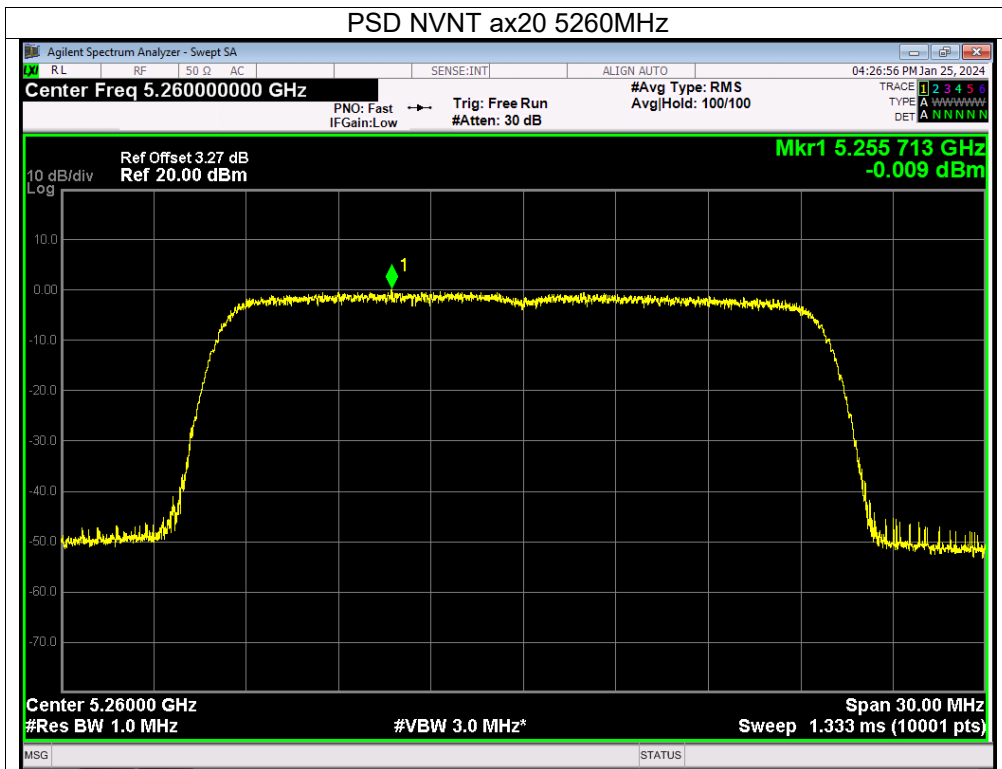

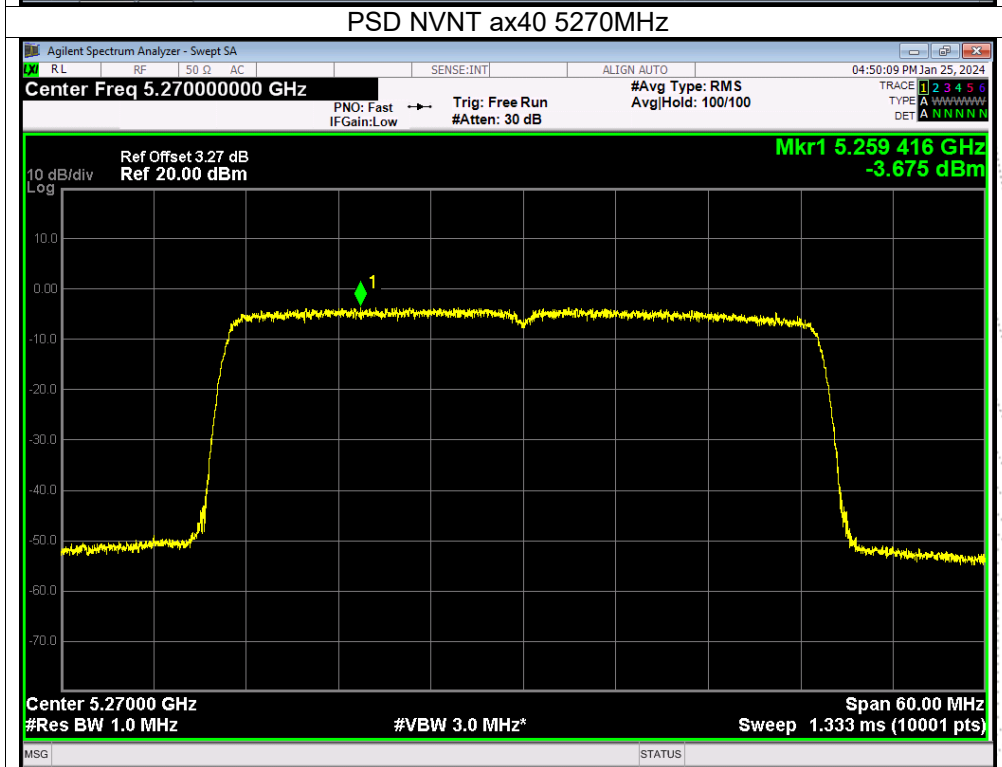
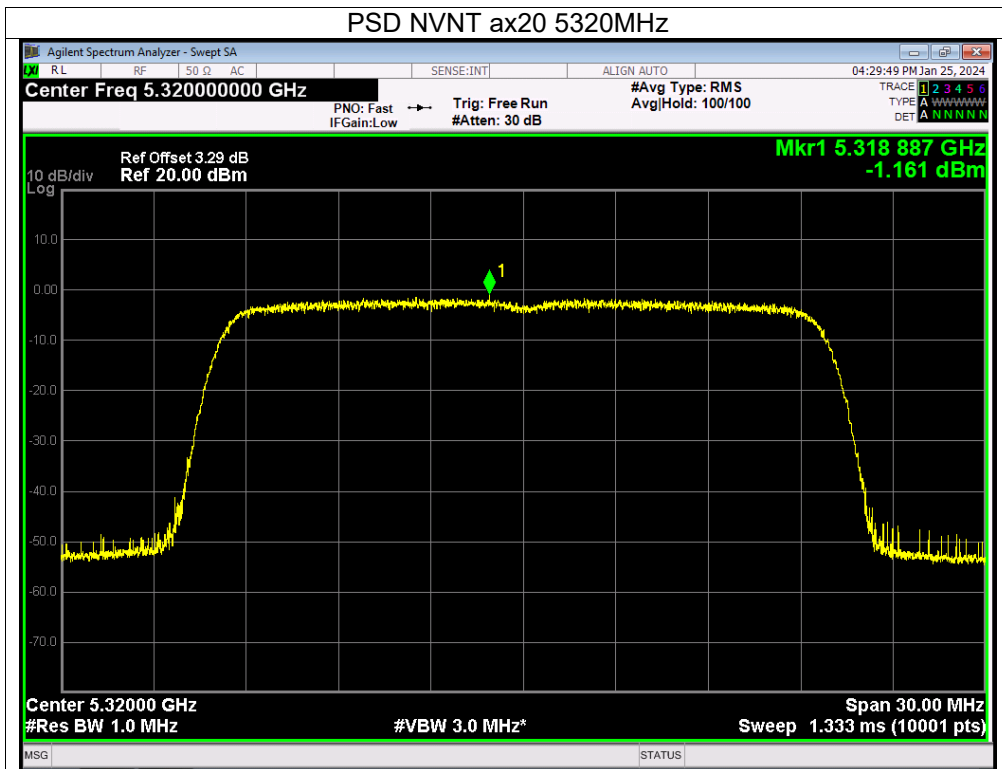

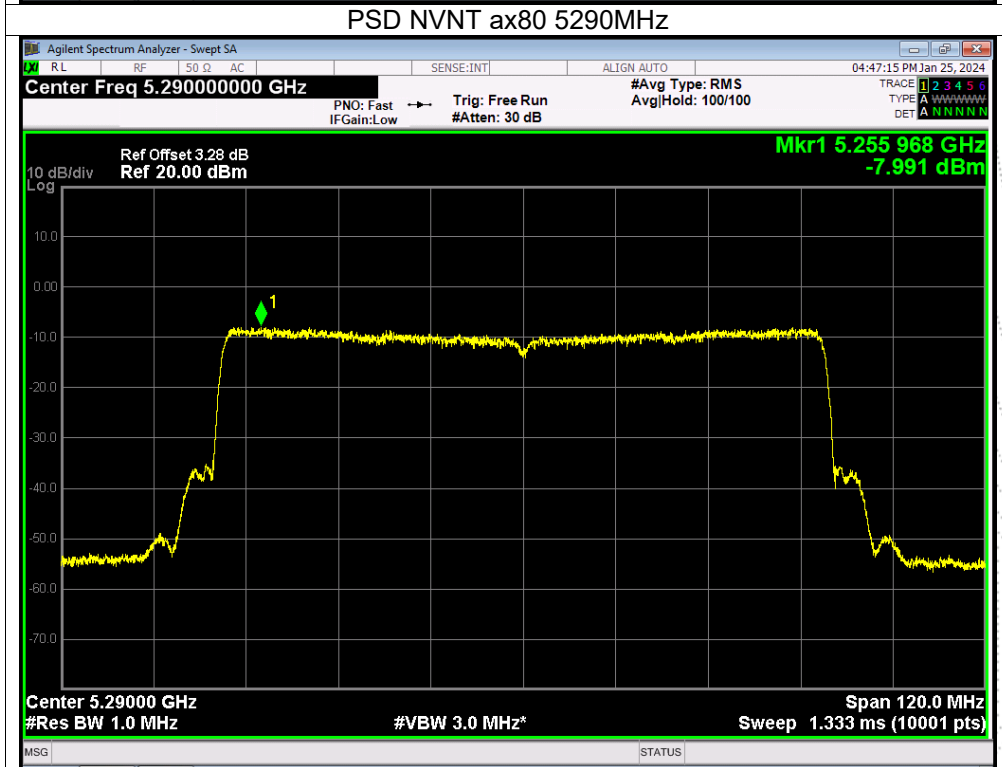
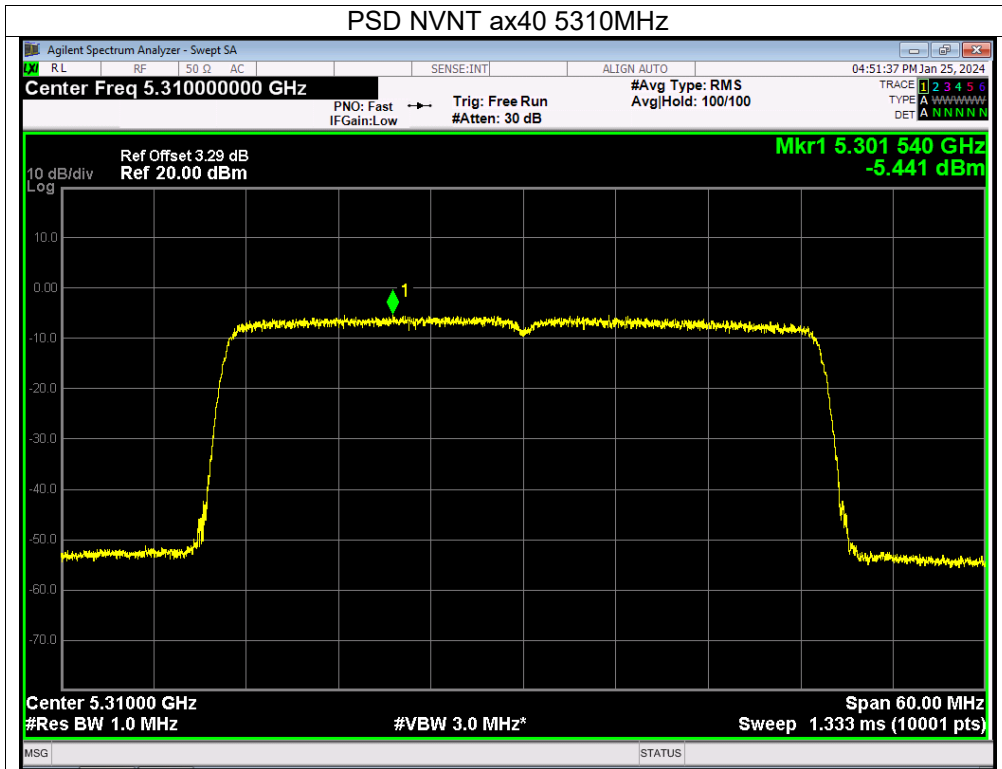

Temperature:	26 °C	Relative Humidity:	54%
Pressure:	101KPa	Test Voltage:	AC 120V/60Hz
Test Mode:	(5500-5700MHz)		

Condition	Mode	Frequency (MHz)	Conducted PSD (dBm/MHz)		Total (dBm/MHz)	Limit (dBm/MHz)	Verdict
			Ant A	Ant B			
NVNT	a	5500	-2.16	-1.49	/	11	Pass
NVNT	a	5580	-0.43	-0.93	/	11	Pass
NVNT	a	5700	2.1	2.22	/	11	Pass
NVNT	n20	5500	-3.46	-2.78	-0.10	11	Pass
NVNT	n20	5580	-1.55	-2	1.24	11	Pass
NVNT	n20	5700	0.58	0.44	3.52	11	Pass
NVNT	n40	5510	-3.26	-6.01	-1.41	11	Pass
NVNT	n40	5550	-3.29	-5.53	-1.26	11	Pass
NVNT	n40	5670	-2.64	-2.99	0.20	11	Pass
NVNT	ac20	5500	-3.61	-2.85	-0.20	11	Pass
NVNT	ac20	5580	-1.86	-2.14	1.01	11	Pass
NVNT	ac20	5700	0.62	0.33	3.49	11	Pass
NVNT	ac40	5510	-3.65	-5.88	-1.61	11	Pass
NVNT	ac40	5550	-2.64	-5.37	-0.78	11	Pass
NVNT	ac40	5670	-2.93	-2.85	0.12	11	Pass
NVNT	ac80	5530	-7.06	-8.41	-4.67	11	Pass
NVNT	ax20	5500	-0.9	-2.55	1.36	11	Pass
NVNT	ax20	5580	-0.15	-2.23	1.94	11	Pass
NVNT	ax20	5700	0.77	0.42	3.61	11	Pass
NVNT	ax40	5510	-3.73	-6.05	-1.73	11	Pass
NVNT	ax40	5550	-4.03	-5.66	-1.76	11	Pass
NVNT	ax40	5670	-2.74	-3.16	0.07	11	Pass
NVNT	ax80	5530	-6.69	-8.82	-4.62	11	Pass

Note:

Antenna A gain:2.55 dBi, Antenna B gain: 2.55 dBi, Directional gain=[GainANT + 10 log(NANT/NSS) dBi]

=5.56 dBi < 6dBi

Limit=11 dBi

Note: A(B) Represent the value of antenna A and B, The worst data is Antenna A, only shown Antenna A Plot. Note:

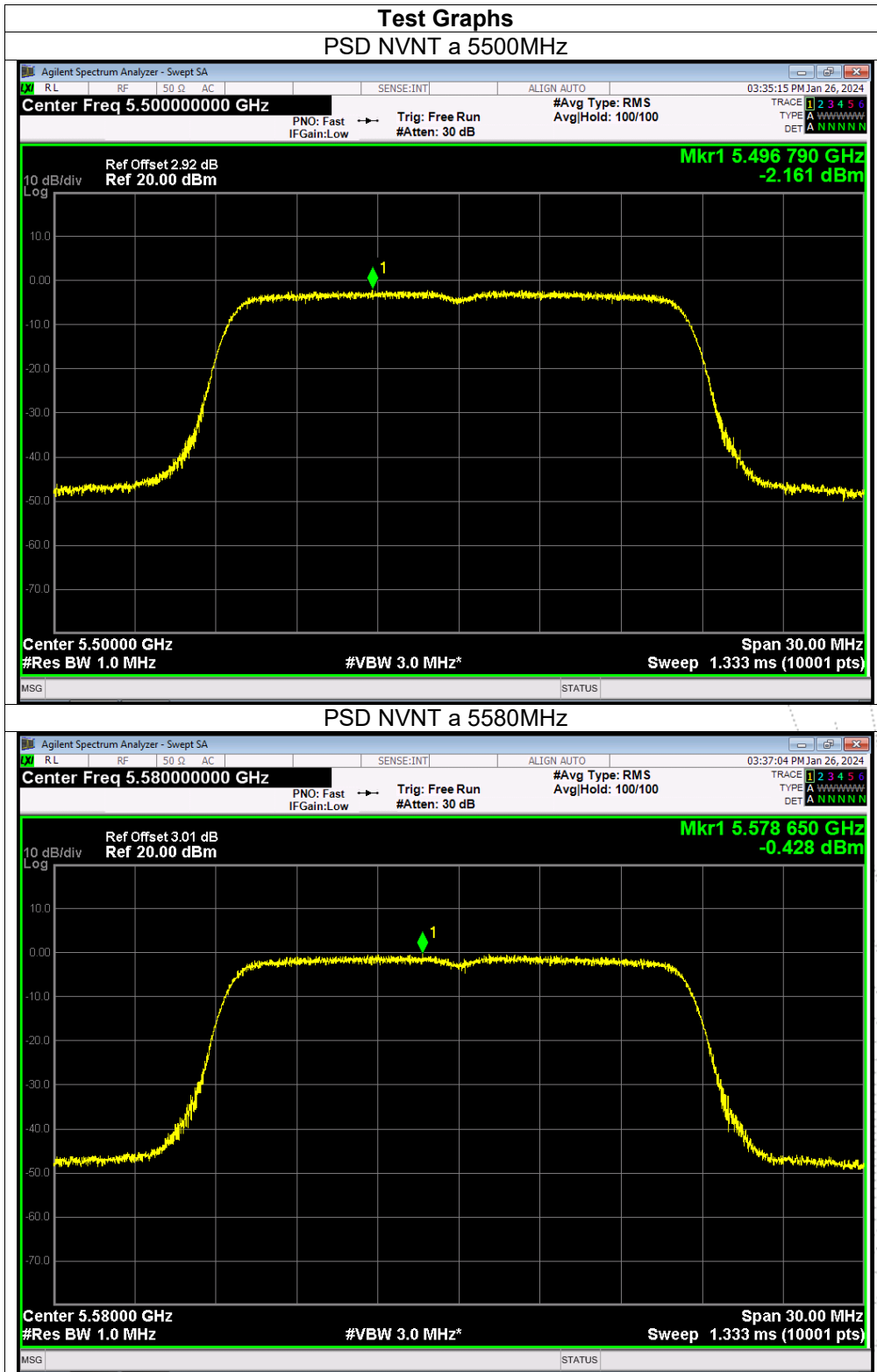

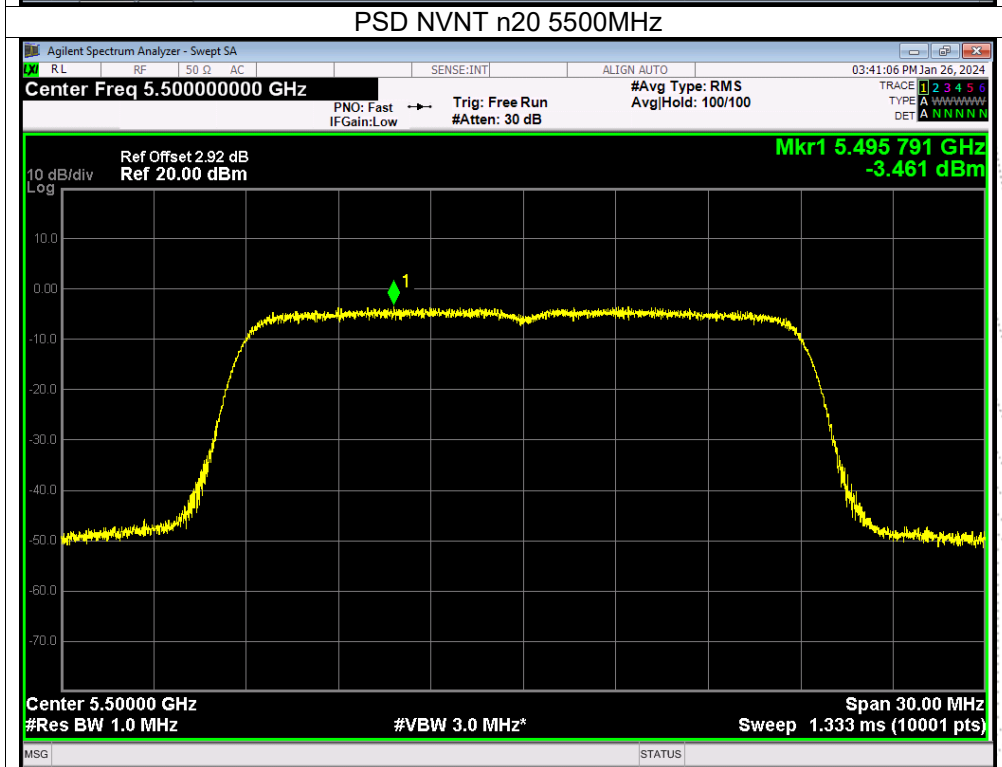
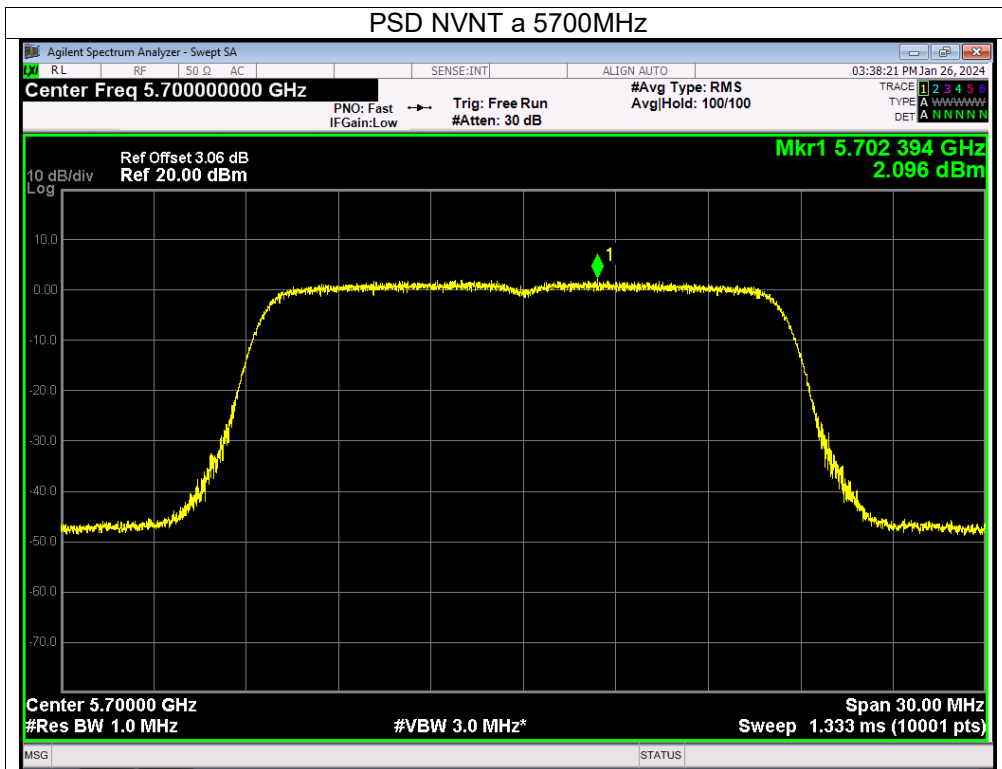

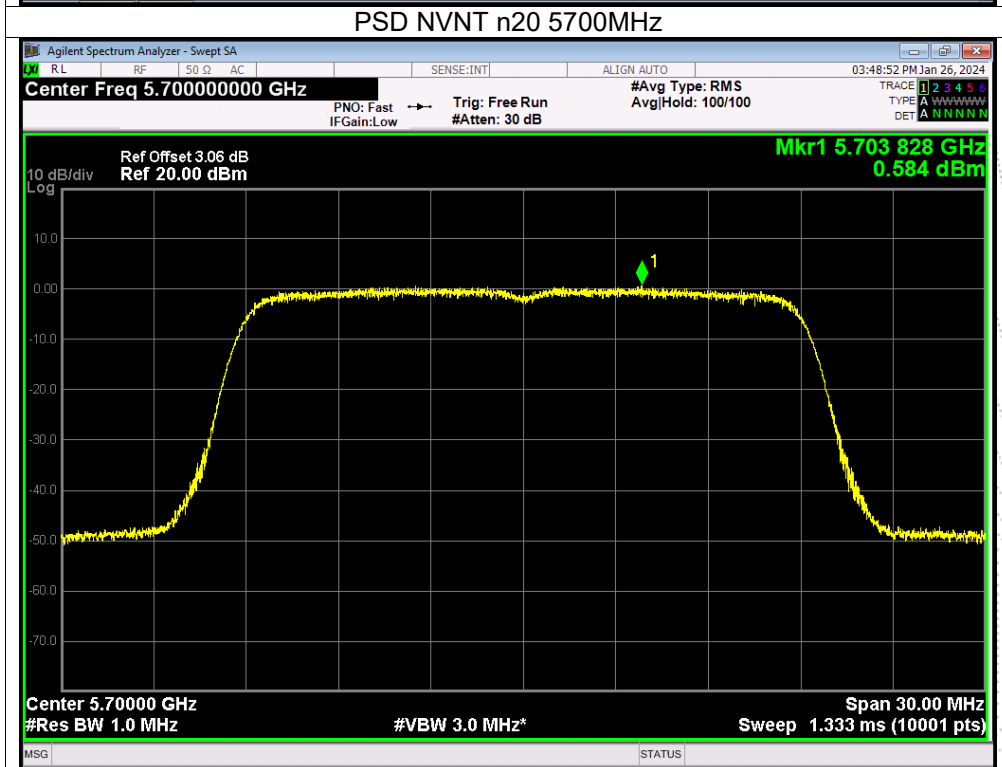
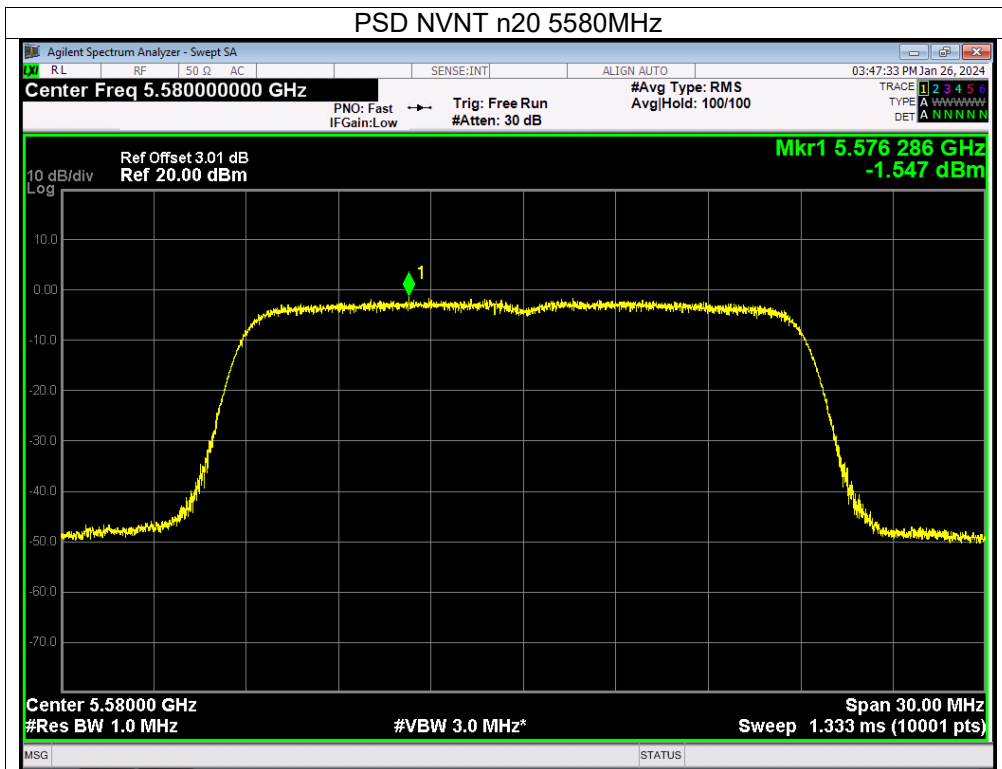

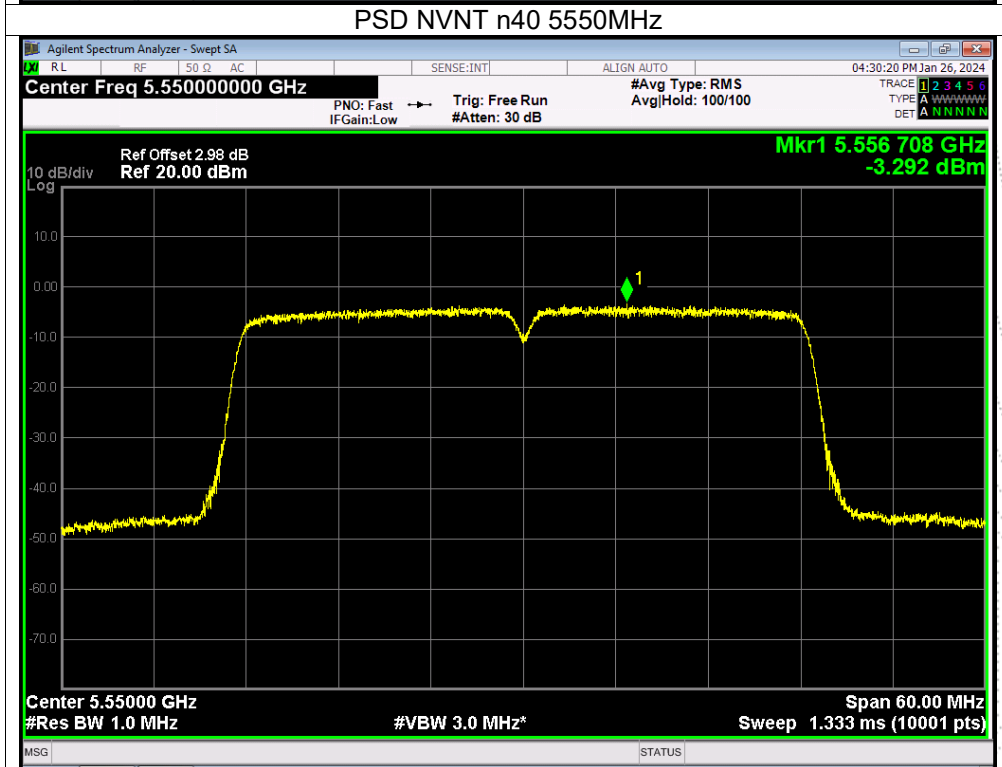
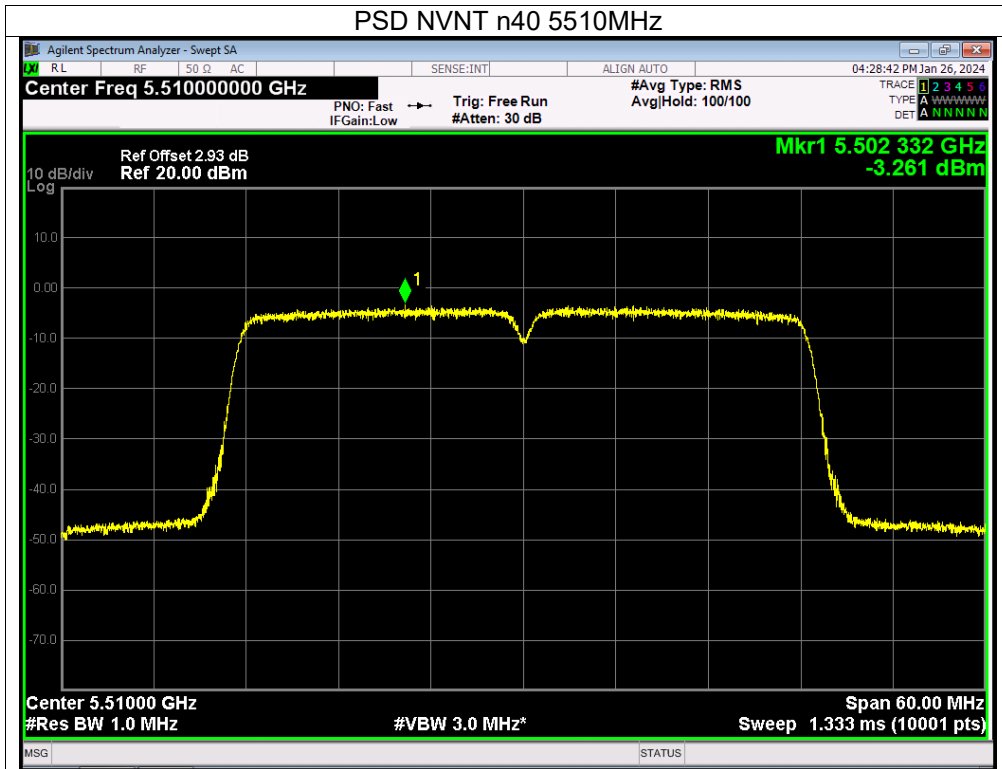

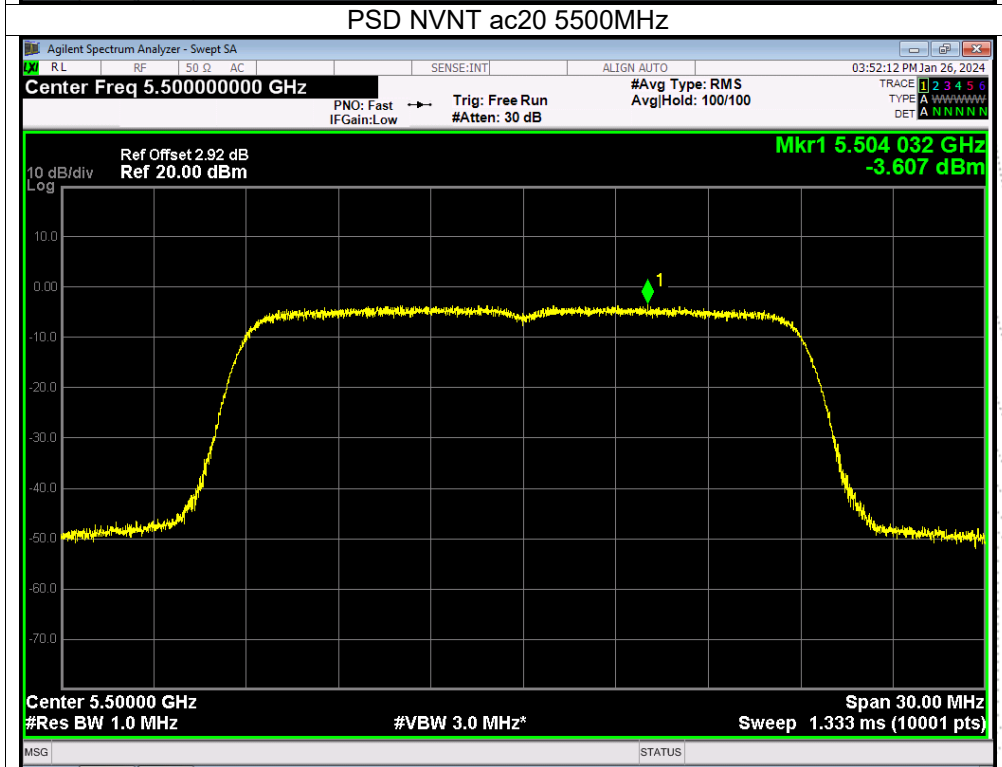
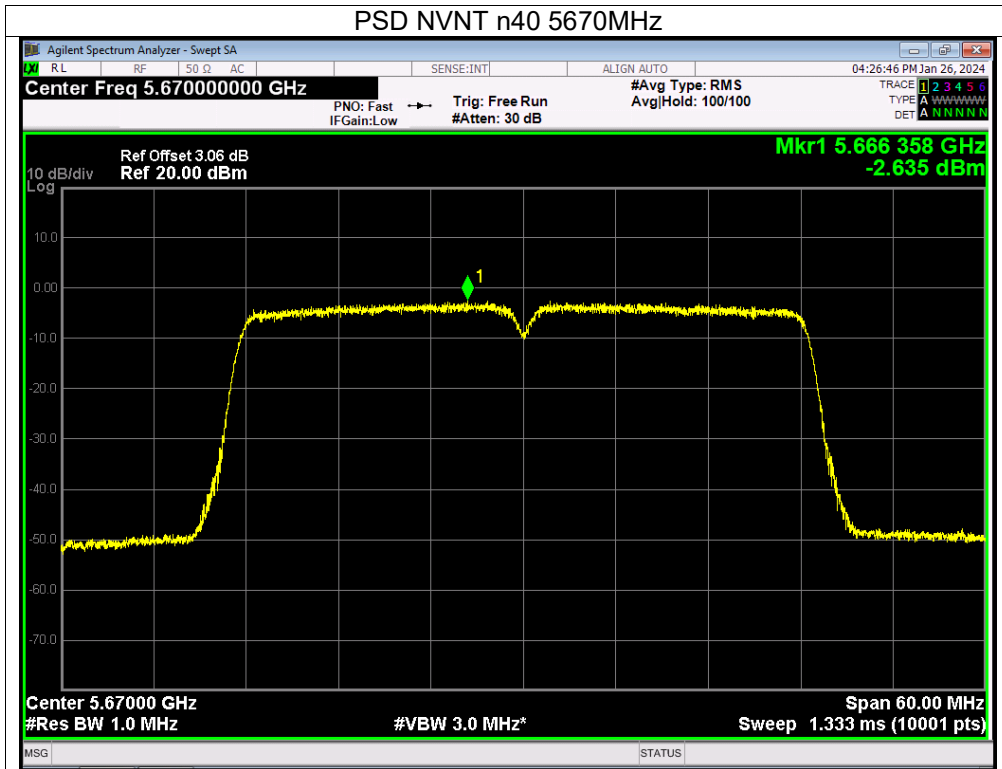

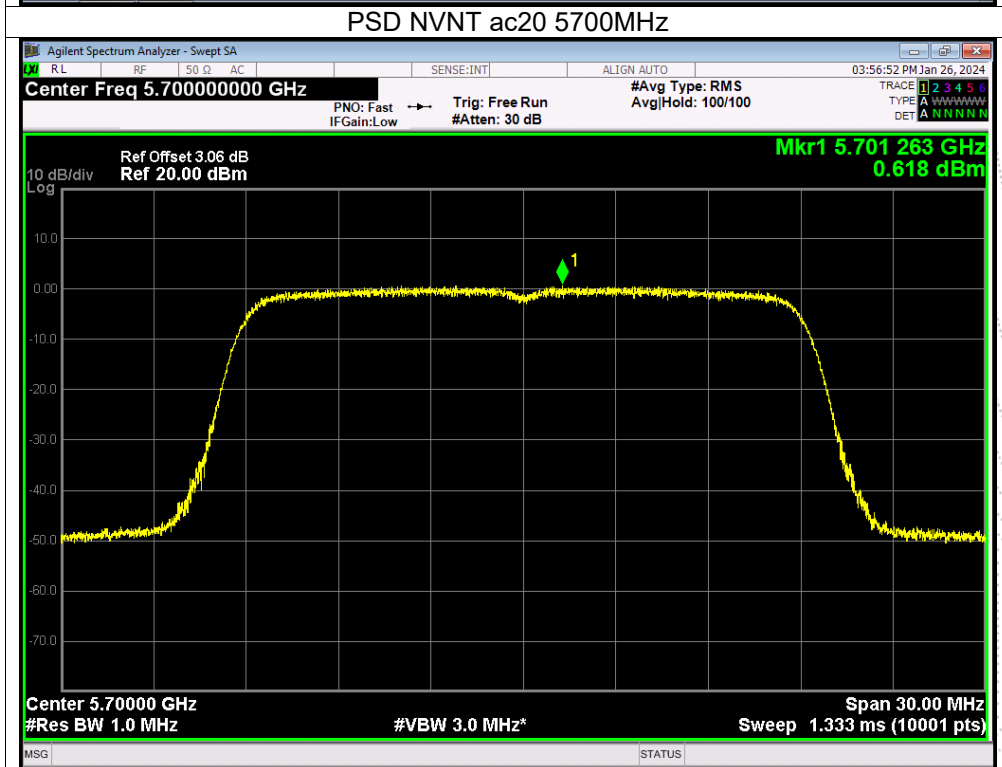
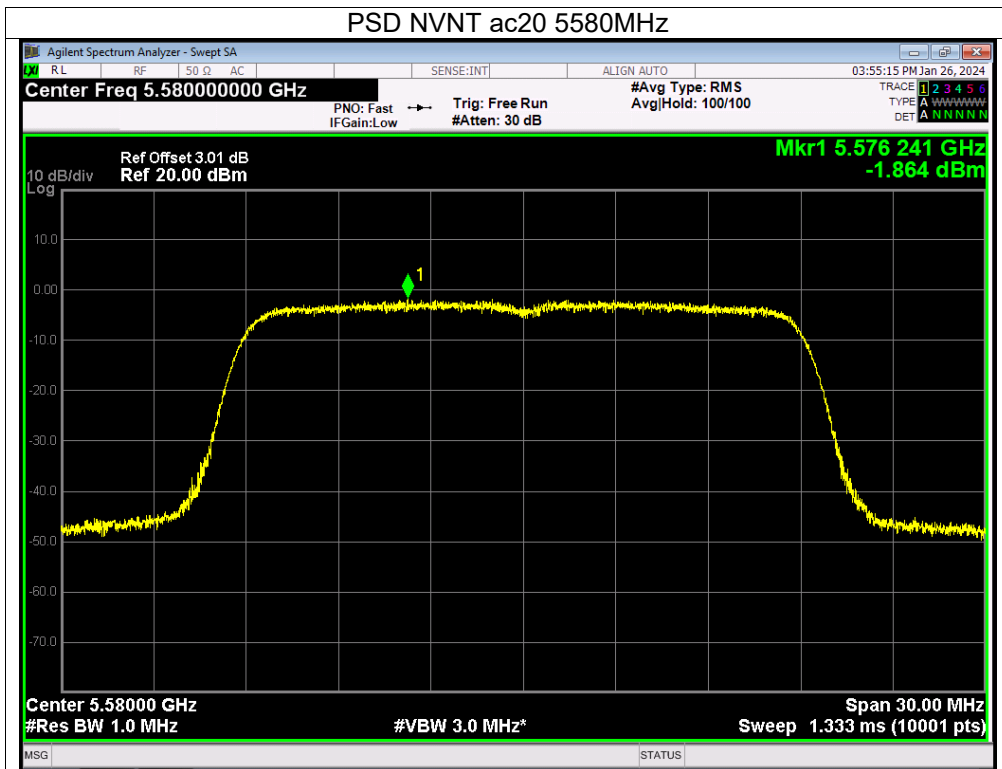

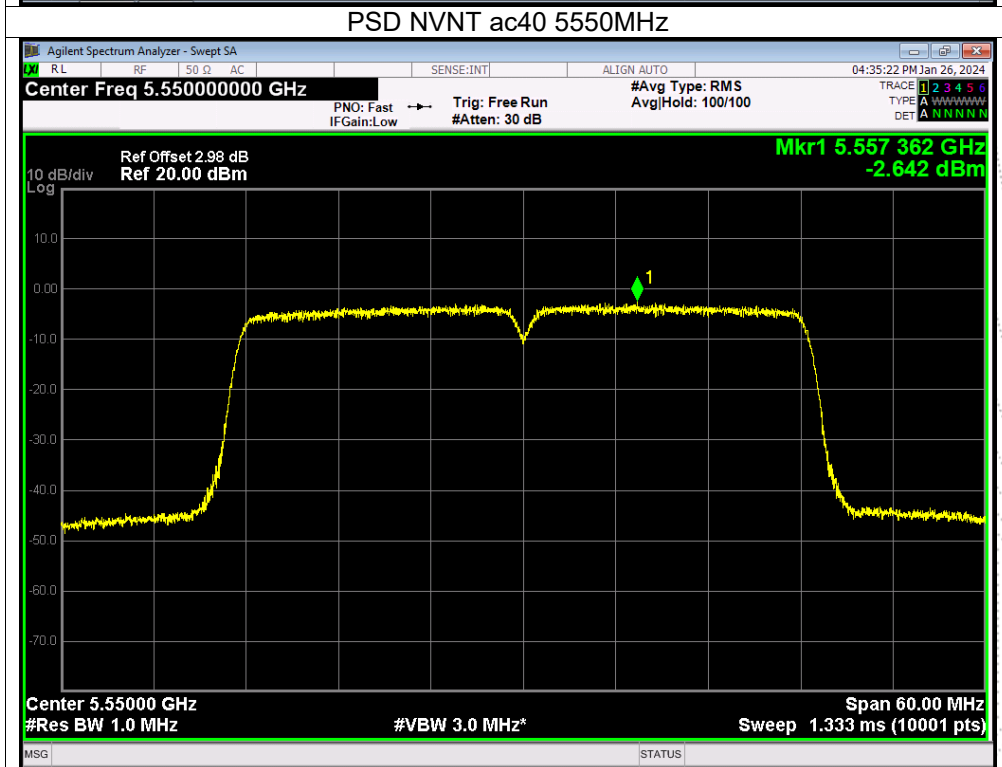
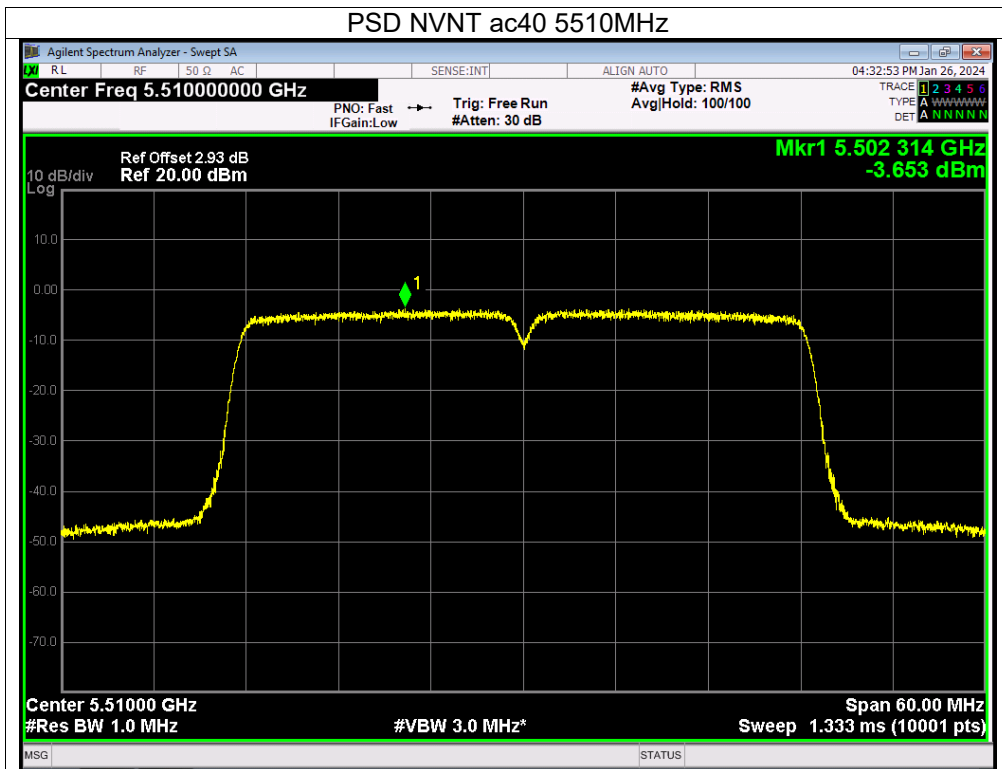

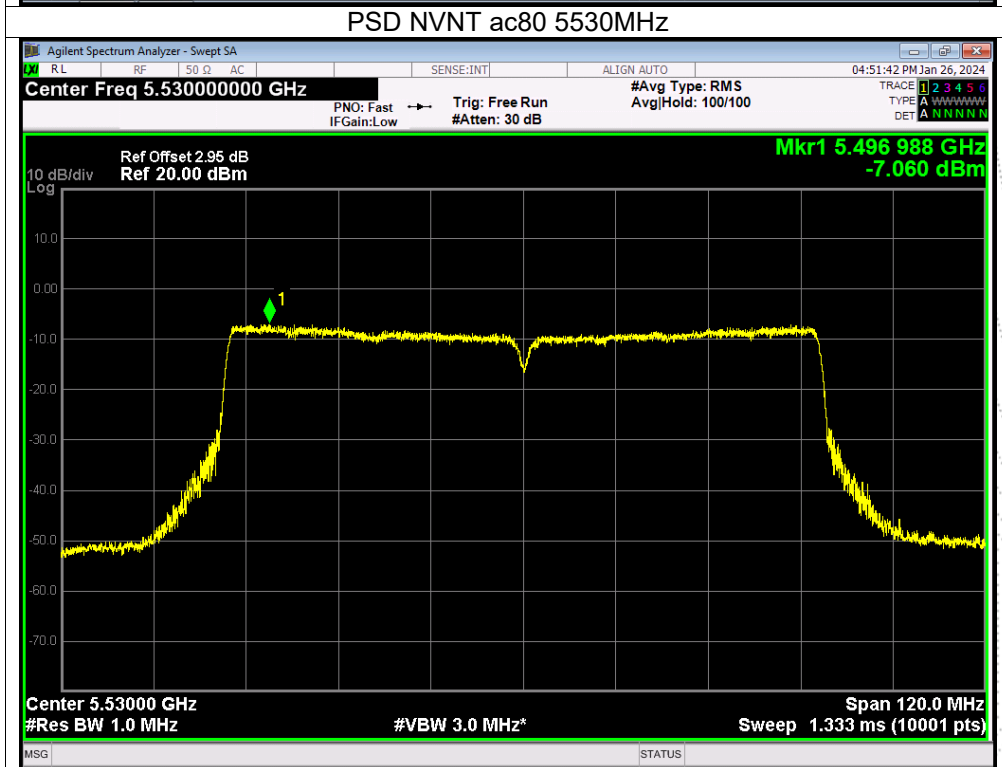
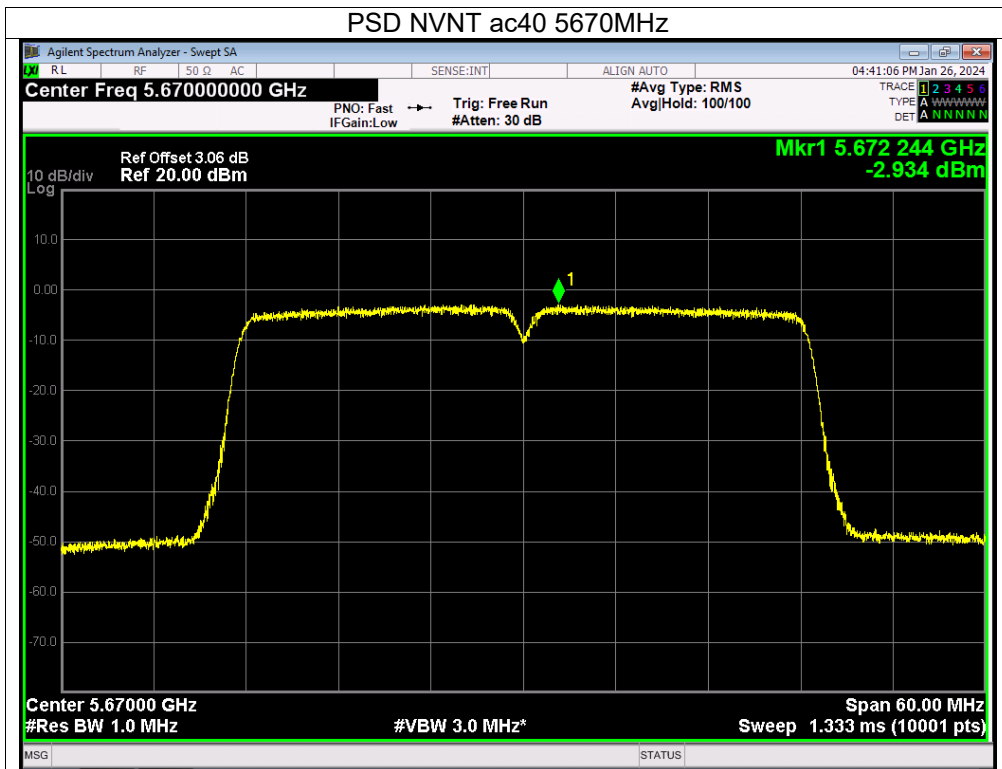

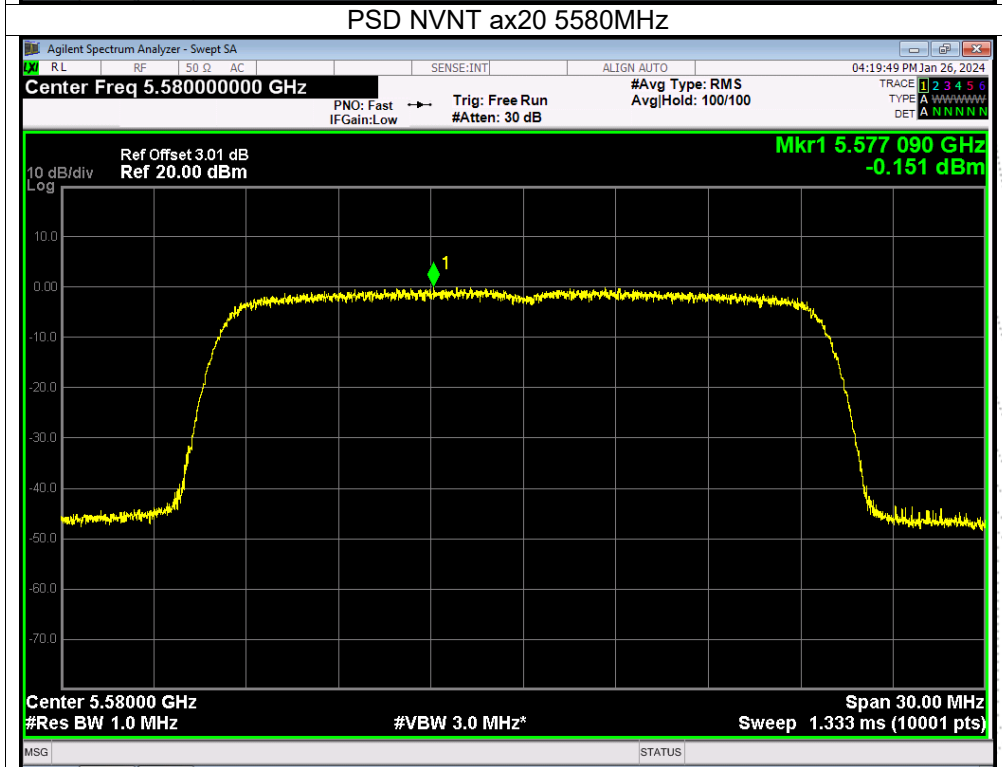
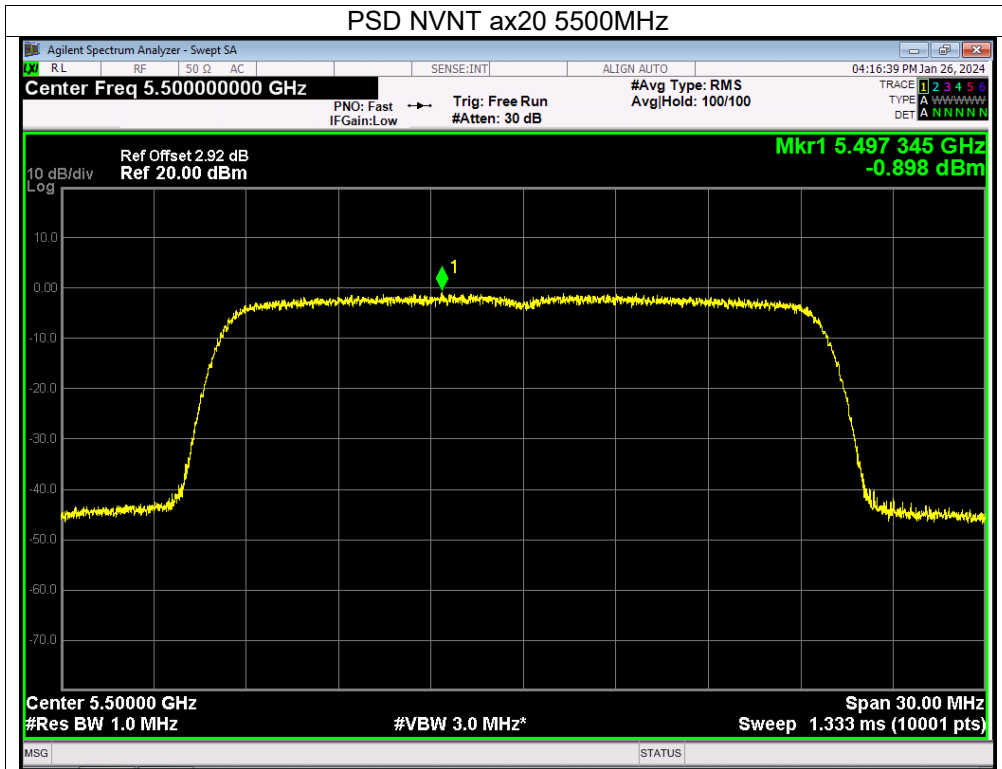

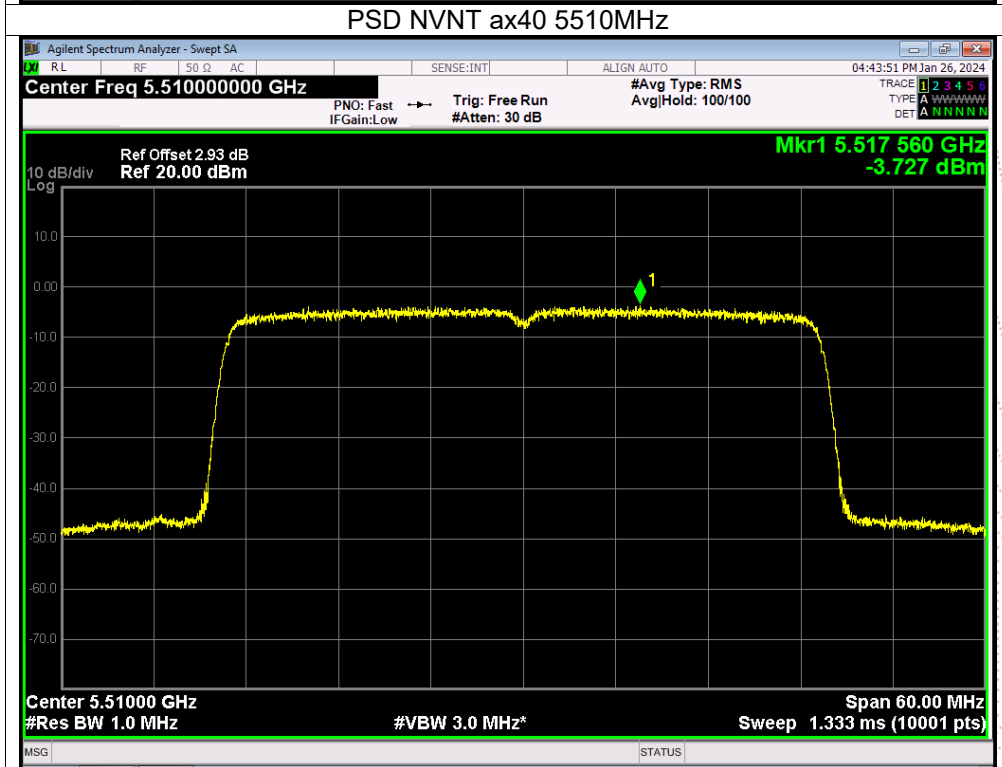
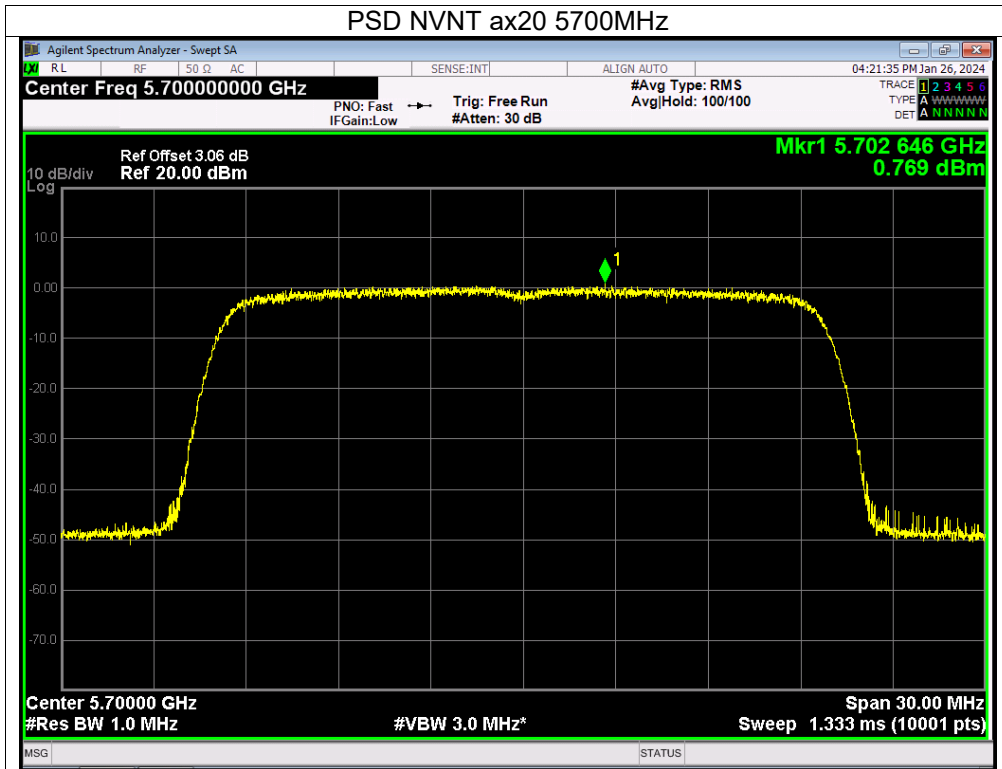

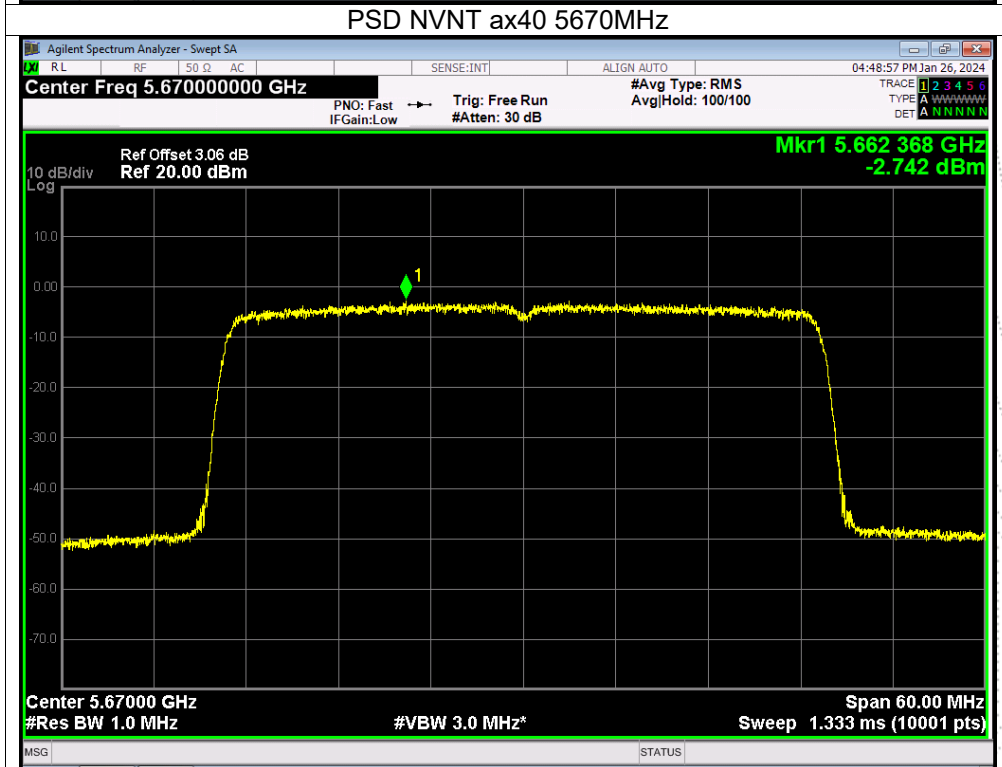
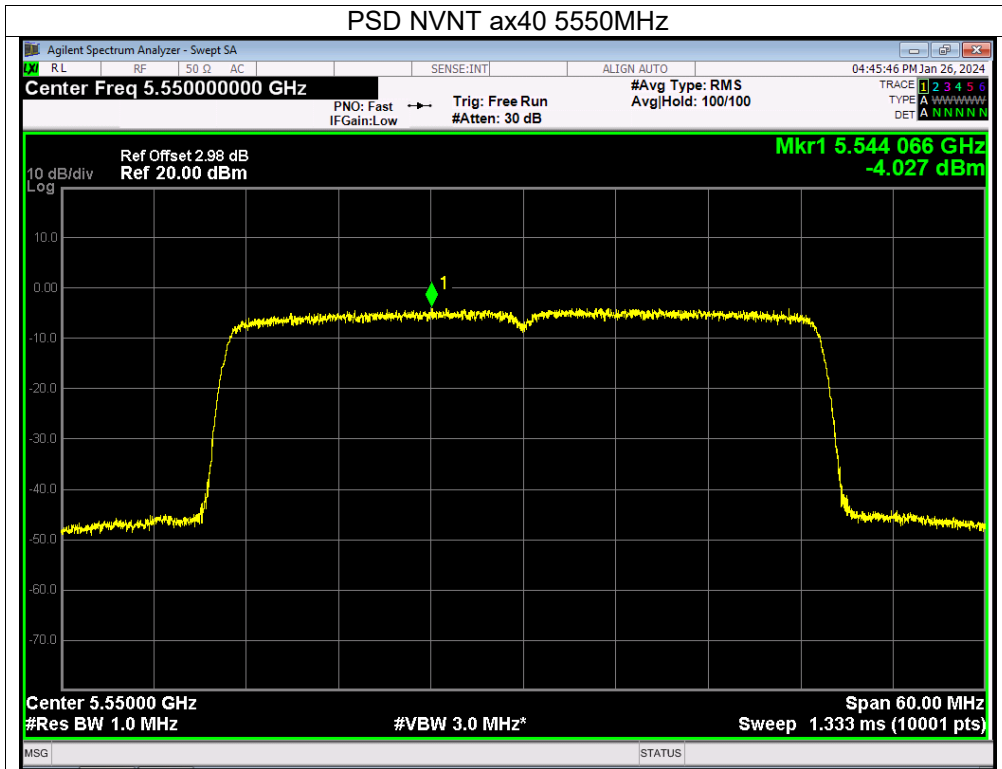

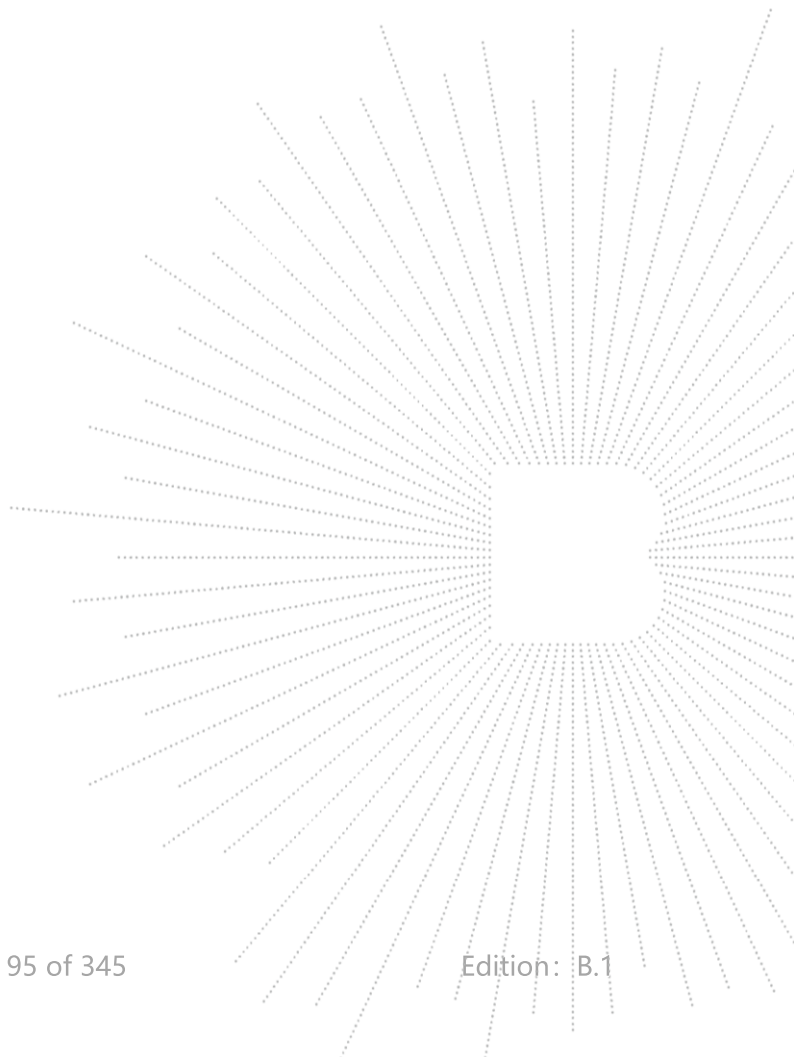
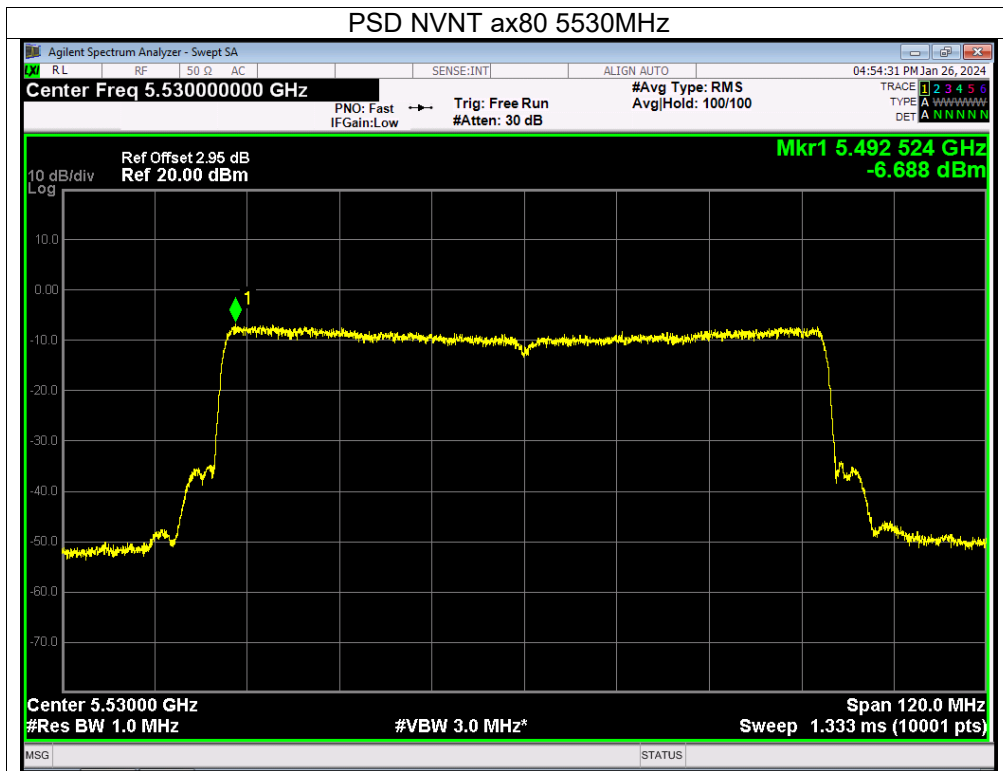

Temperature:	26 °C	Relative Humidity:	54%
Pressure:	101KPa	Test Voltage:	AC 120V/60Hz
Test Mode:	(5745-5825MHz)		

Condition	Mode	Fre- quency (MHz)	Conducted PSD (dBm/510KHz)		Conducted PSD (dBm/500KHz)		Total (dBm/ 500KHz)	Limit (dBm/ 500KHz)	Verdict
			Ant A	Ant B	Ant A	Ant B			
NVNT	a	5745	-1.51	-2.1	-1.596	-2.186	/	30	Pass
NVNT	a	5785	-1.85	-2.38	-1.936	-2.466	/	30	Pass
NVNT	a	5825	-2.17	-2.4	-2.256	-2.486	/	30	Pass
NVNT	n20	5745	-2.91	-3.57	-2.996	-3.656	-0.30	30	Pass
NVNT	n20	5785	-3.12	-2.94	-3.206	-3.026	-0.10	30	Pass
NVNT	n20	5825	-3.64	-3.32	-3.726	-3.406	-0.55	30	Pass
NVNT	n40	5755	-6.58	-7.02	-6.666	-7.106	-3.87	30	Pass
NVNT	n40	5795	-6.83	-7.27	-6.916	-7.356	-4.12	30	Pass
NVNT	ac20	5745	-2.85	-2.71	-2.936	-2.796	0.14	30	Pass
NVNT	ac20	5785	-3.01	-2.87	-3.096	-2.956	-0.02	30	Pass
NVNT	ac20	5825	-3.43	-3.51	-3.516	-3.596	-0.55	30	Pass
NVNT	ac40	5755	-6.78	-7.52	-6.866	-7.606	-4.21	30	Pass
NVNT	ac40	5795	-6.87	-8.21	-6.956	-8.296	-4.56	30	Pass
NVNT	ac80	5775	-9.83	-10.45	-9.916	-10.536	-7.20	30	Pass
NVNT	ax20	5745	-3.13	-2.77	-3.216	-2.856	-0.02	30	Pass
NVNT	ax20	5785	-3.13	-3.01	-3.216	-3.096	-0.15	30	Pass
NVNT	ax20	5825	-3.76	-3.73	-3.846	-3.816	-0.82	30	Pass
NVNT	ax40	5755	-6.57	-7.91	-6.656	-7.996	-4.26	30	Pass
NVNT	ax40	5795	-7.37	-7.76	-7.456	-7.846	-4.64	30	Pass
NVNT	ax80	5775	-9.92	-11.18	-10.006	-11.266	-7.58	30	Pass

Note: Correction Factor = $10\log(500\text{KHz}/\text{RBW in measurement}) = -0.086$

Note:

Antenna A gain: 2.55 dBi, Antenna B gain: 2.55 dBi, Directional gain = [GainANT + 10 log(NANT) dBi] = 5.56 dBi < 6 dBi

EIRP Limit = 30 dBi

Note: A(B) Represent the value of antenna A and B, The worst data is Antenna A, only shown Antenna A Plot.

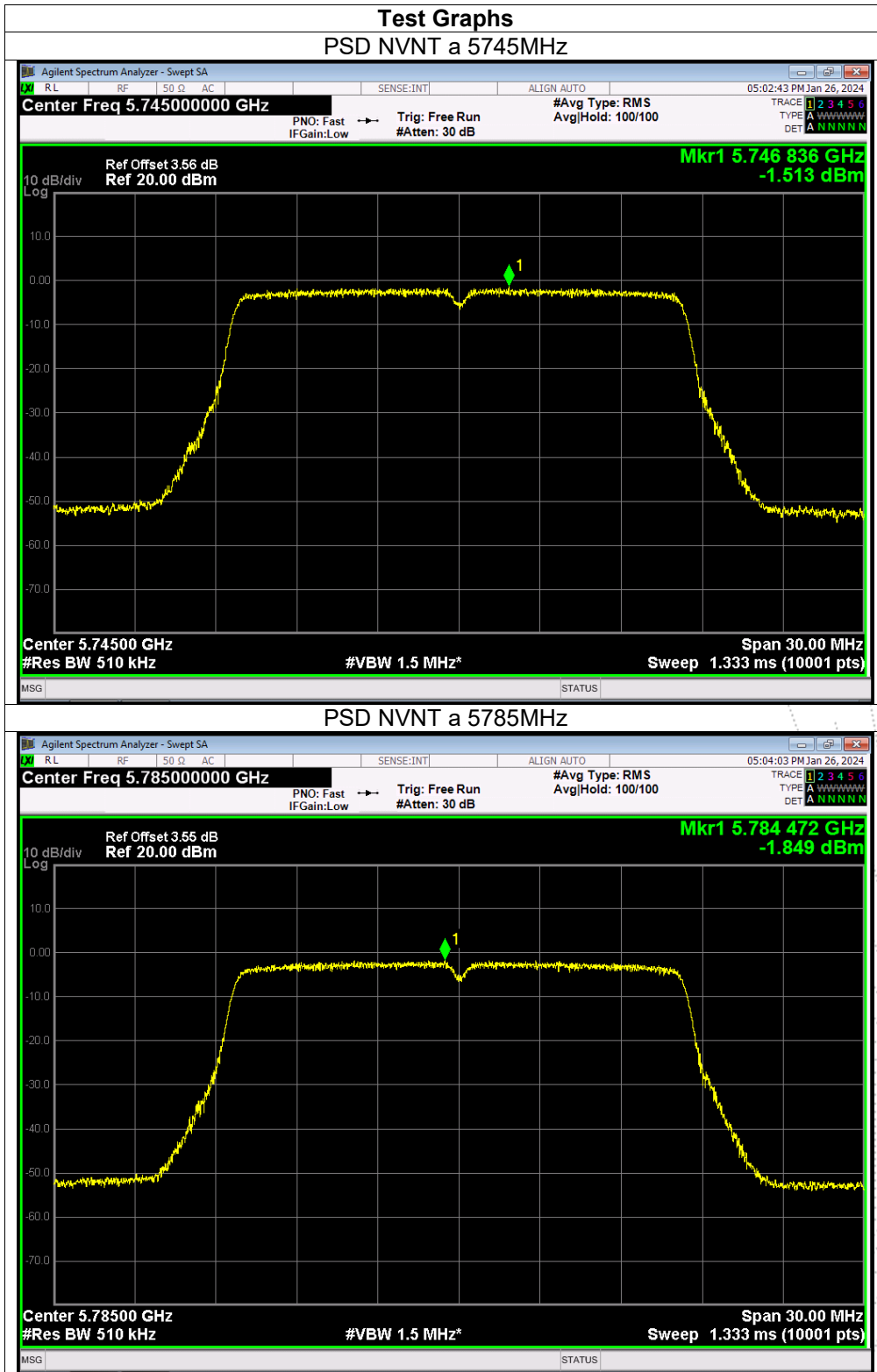

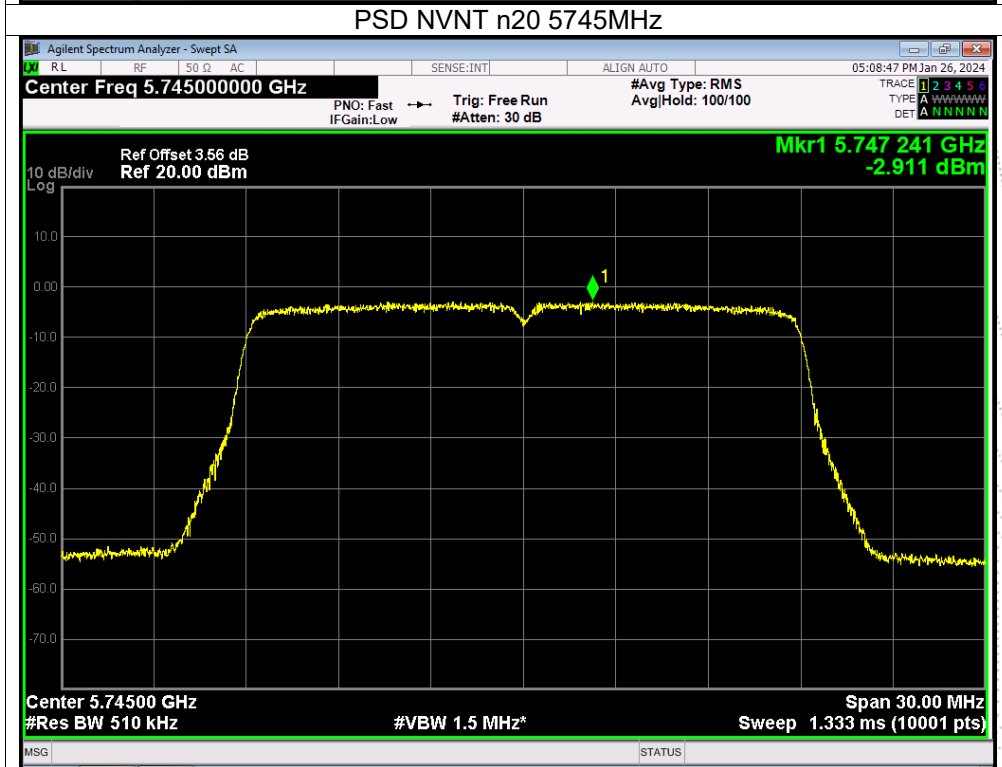
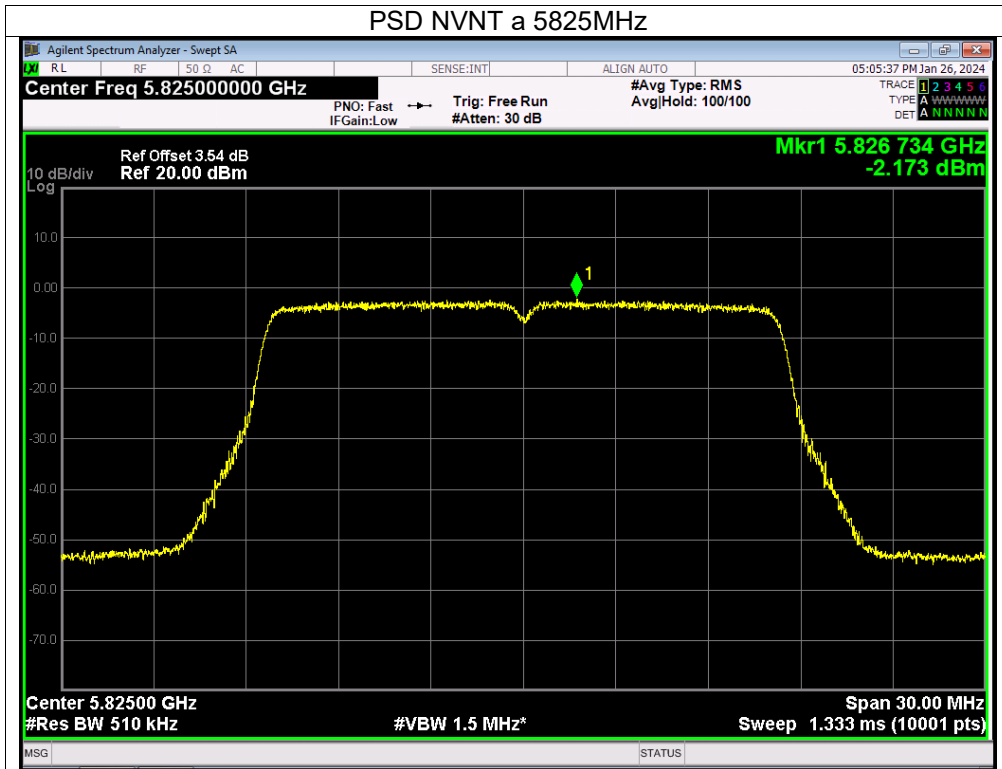

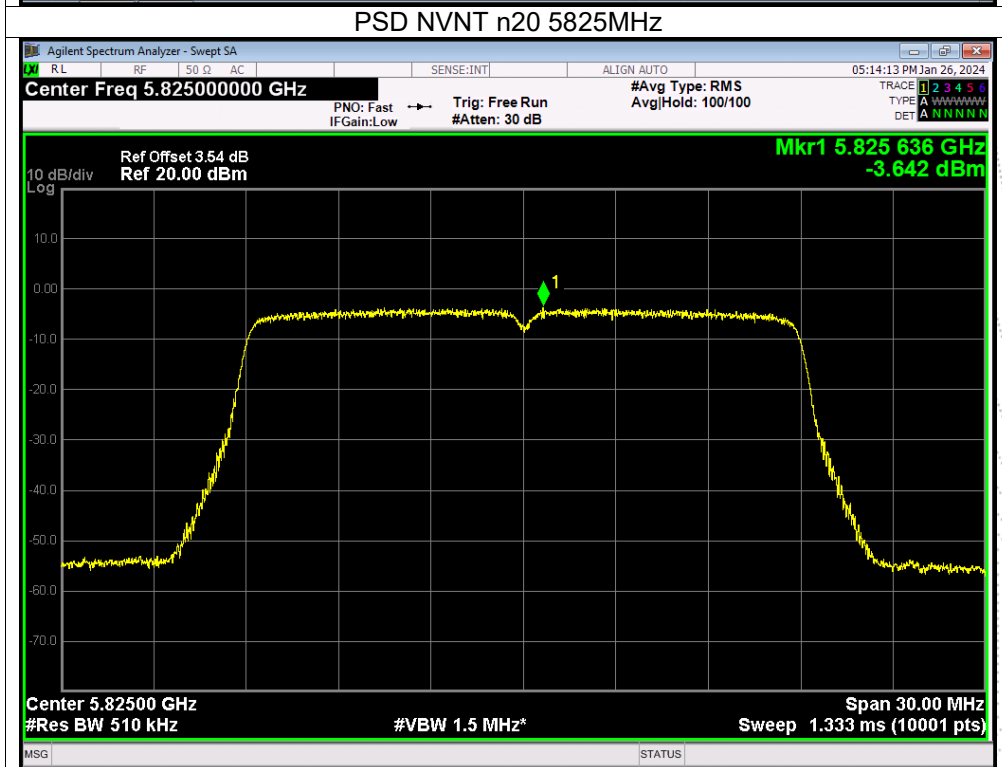
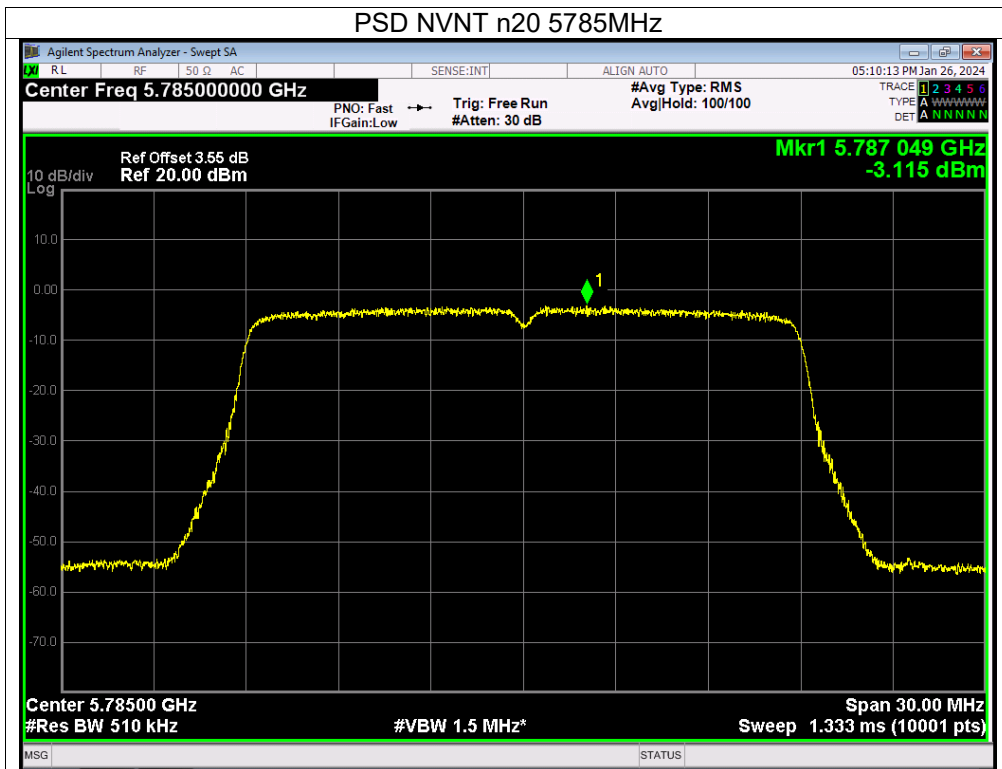

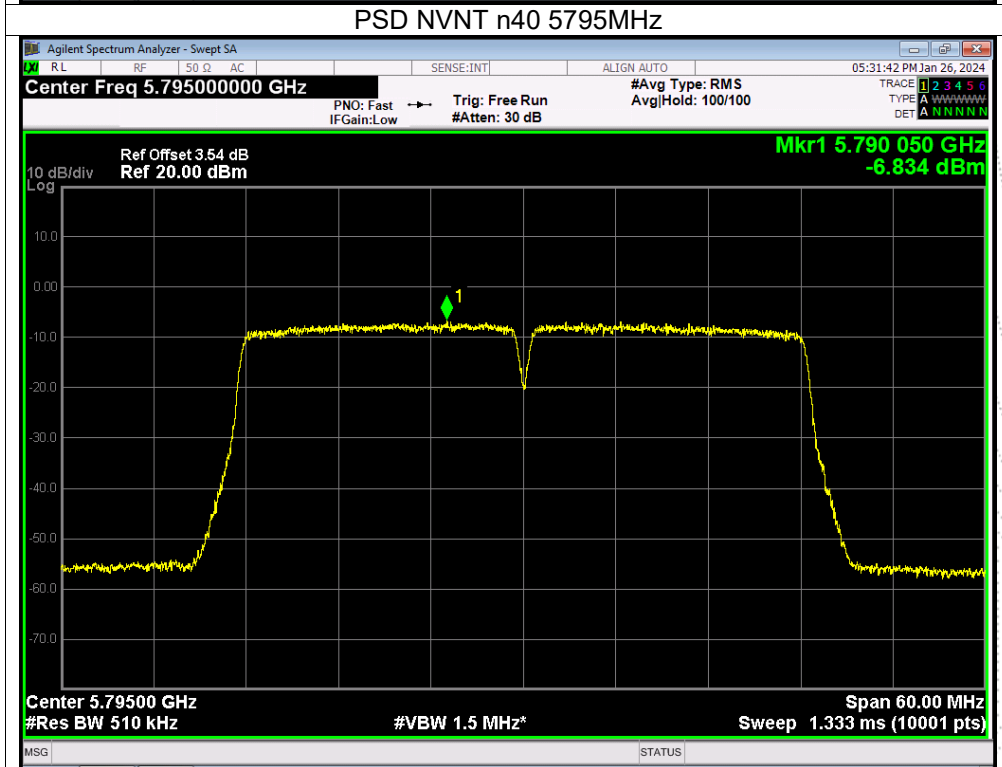
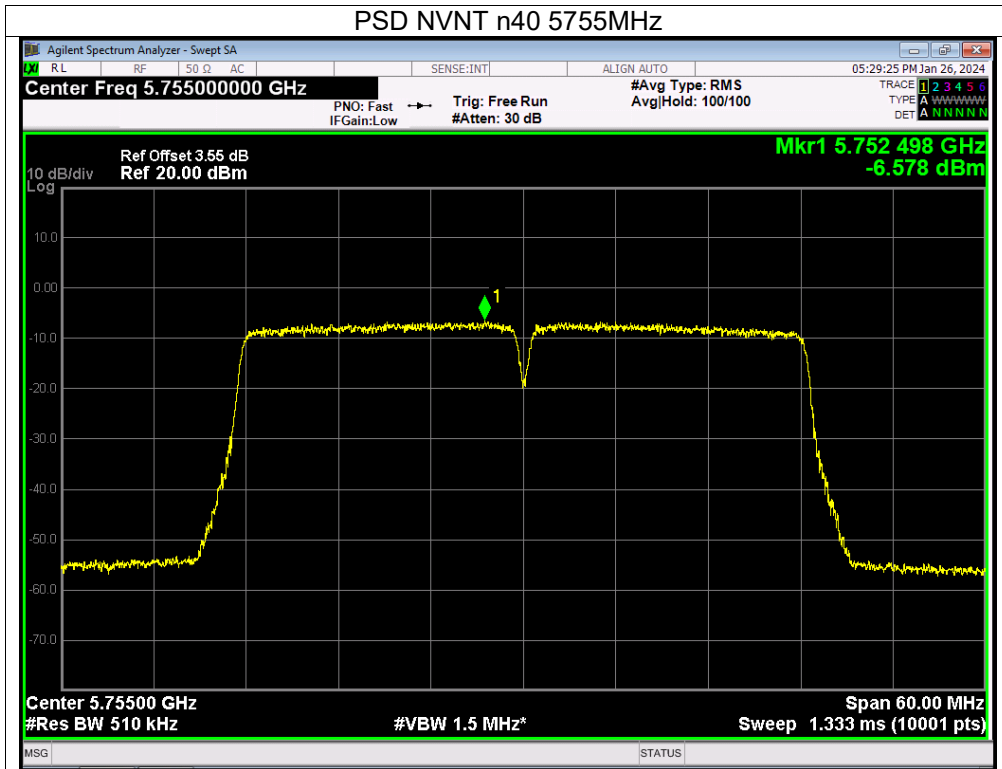

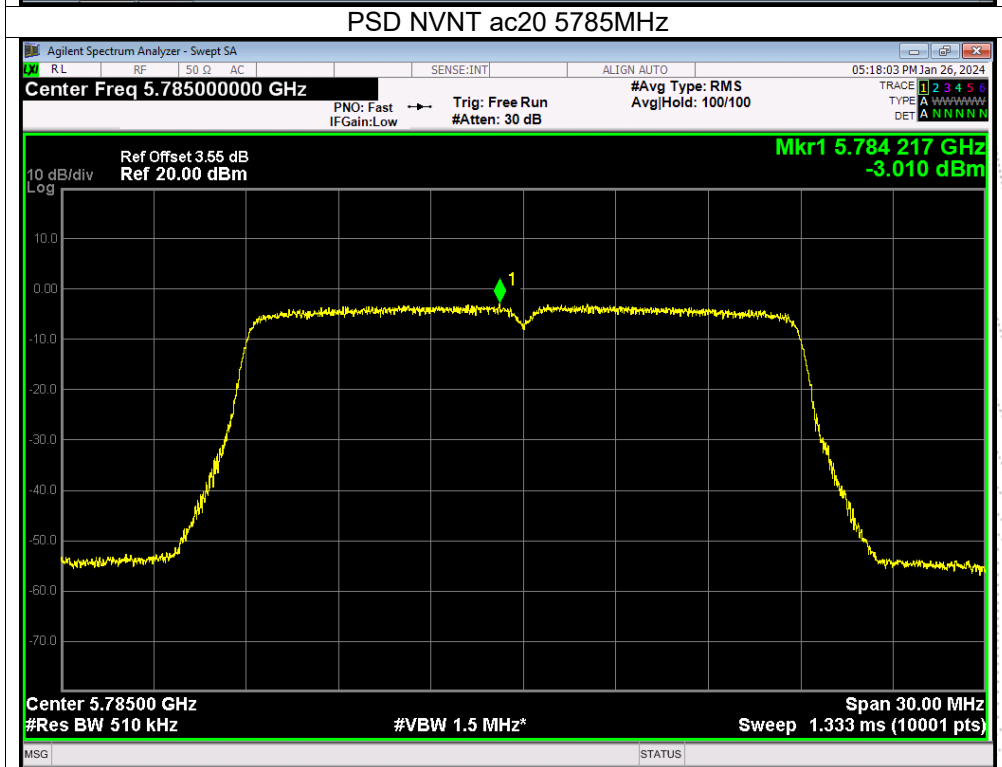
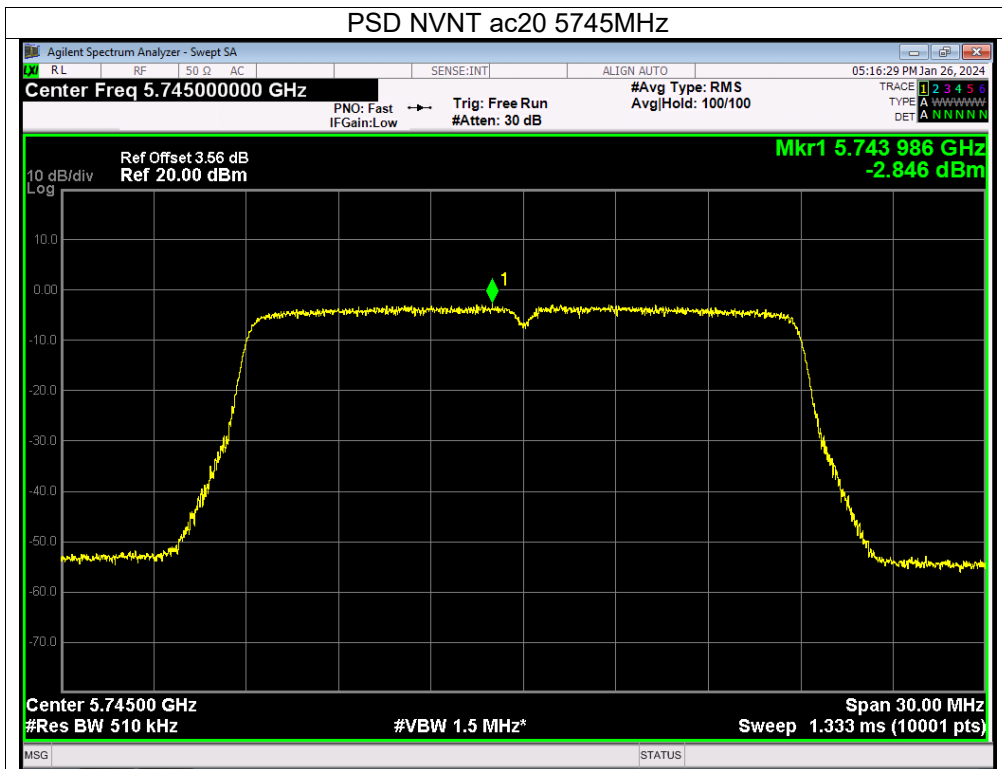

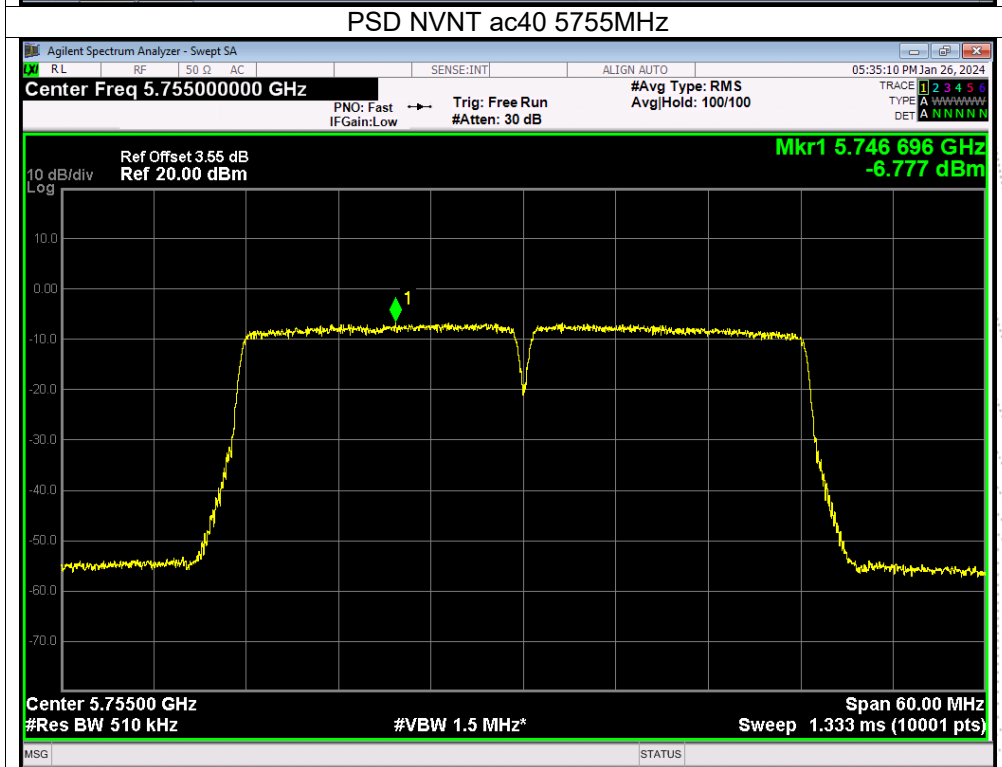
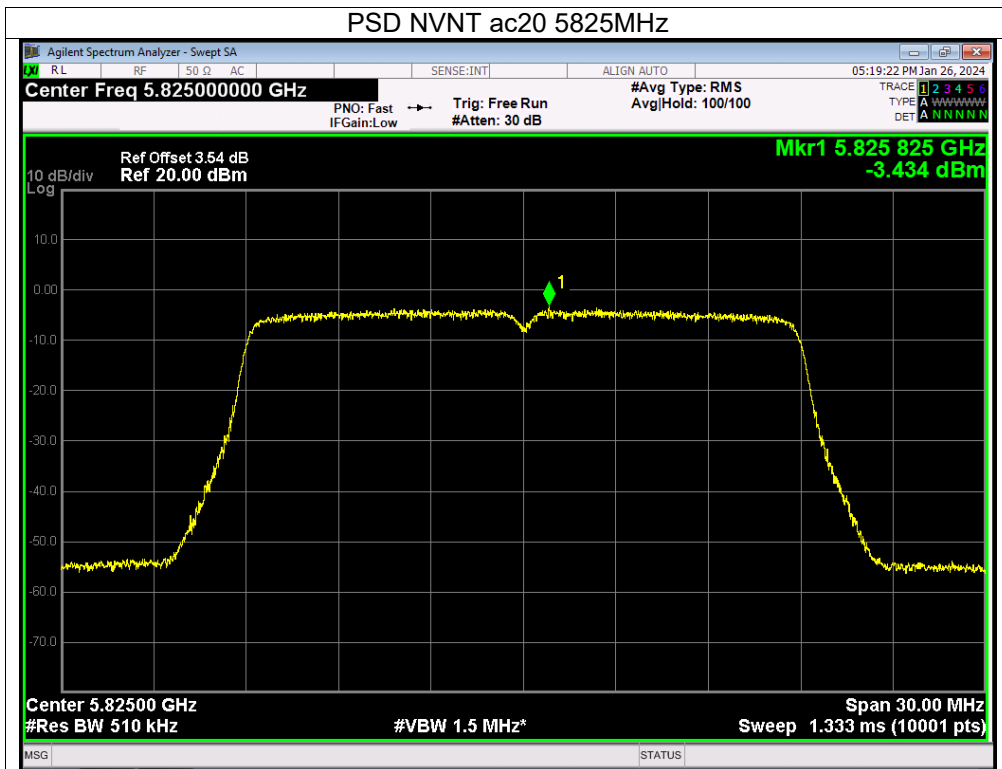

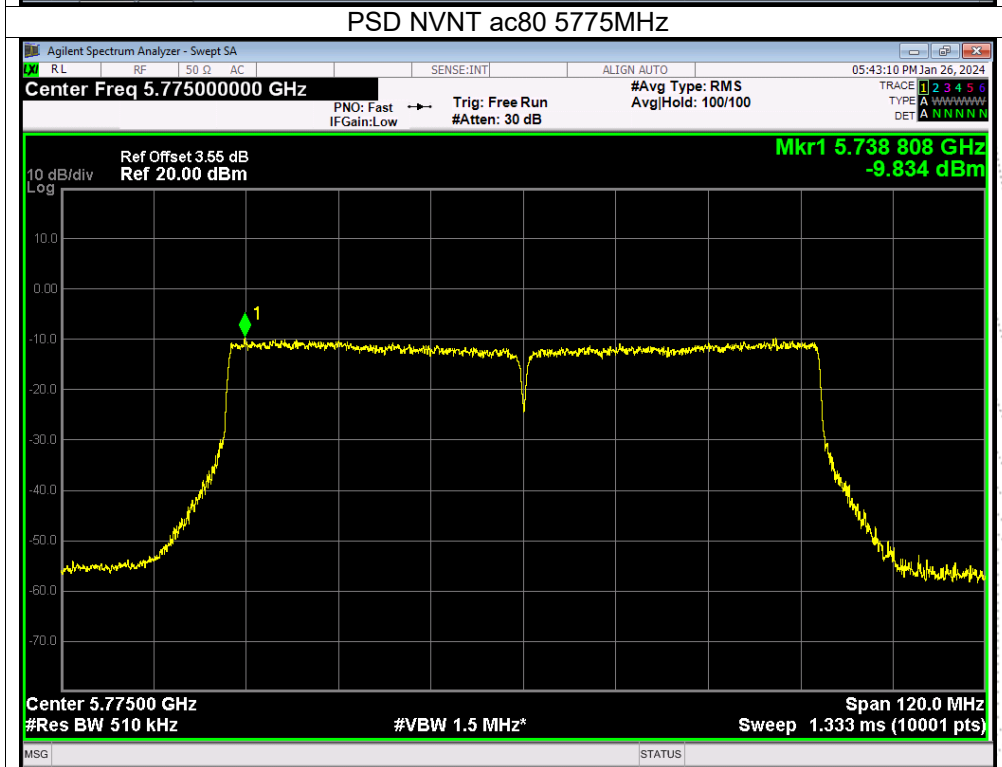
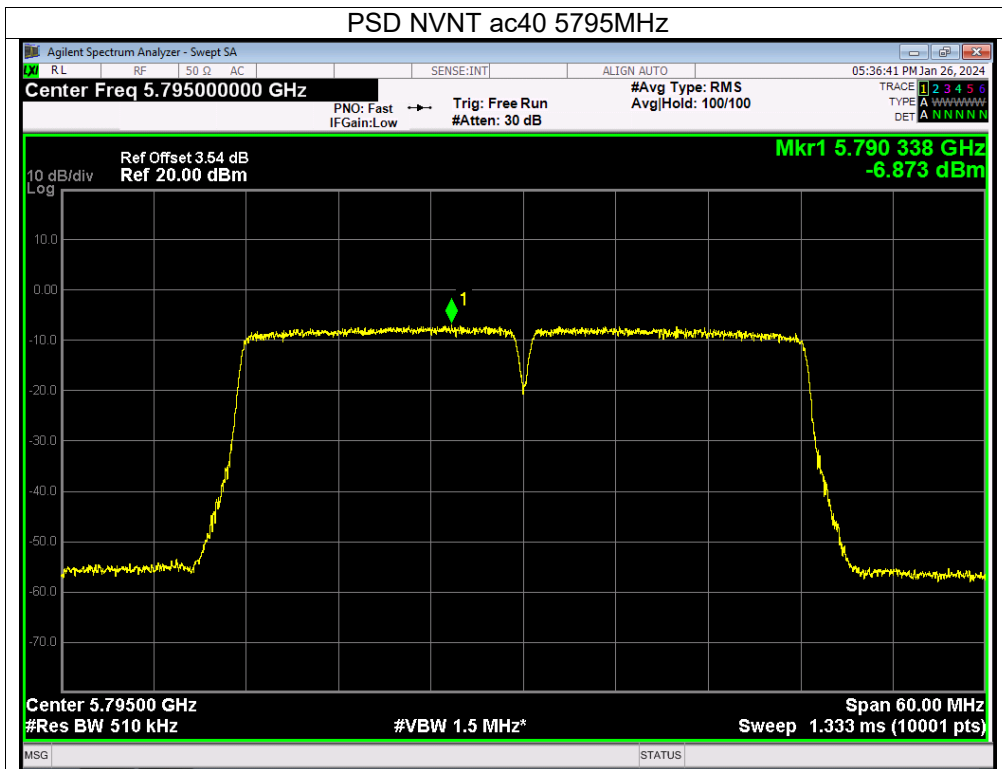

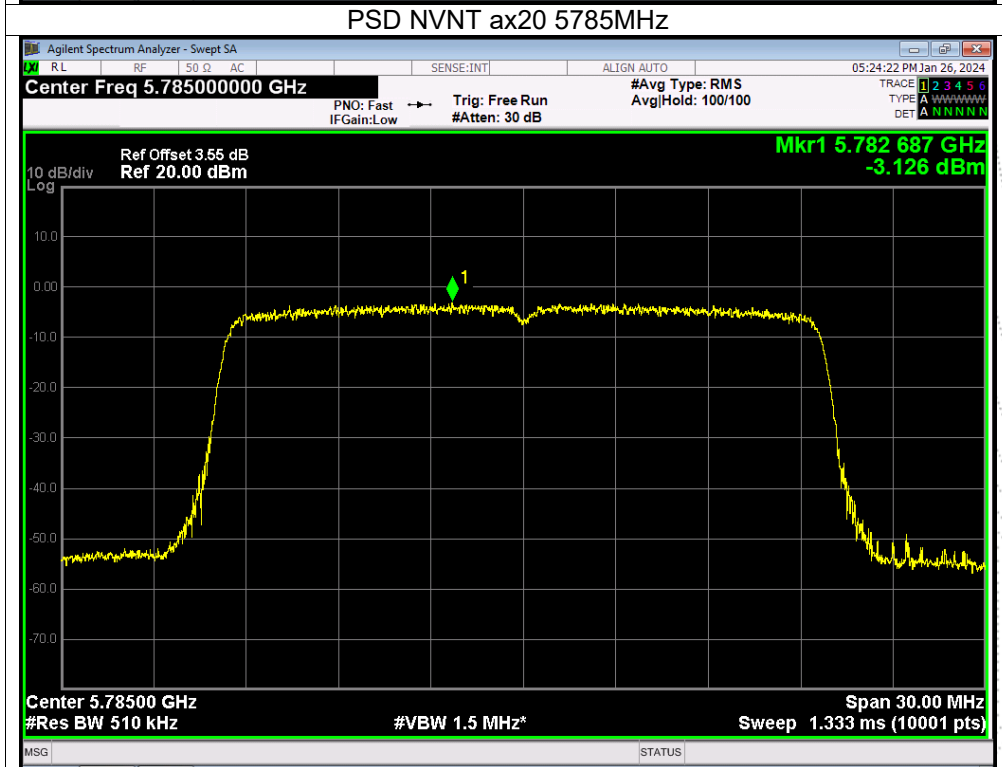
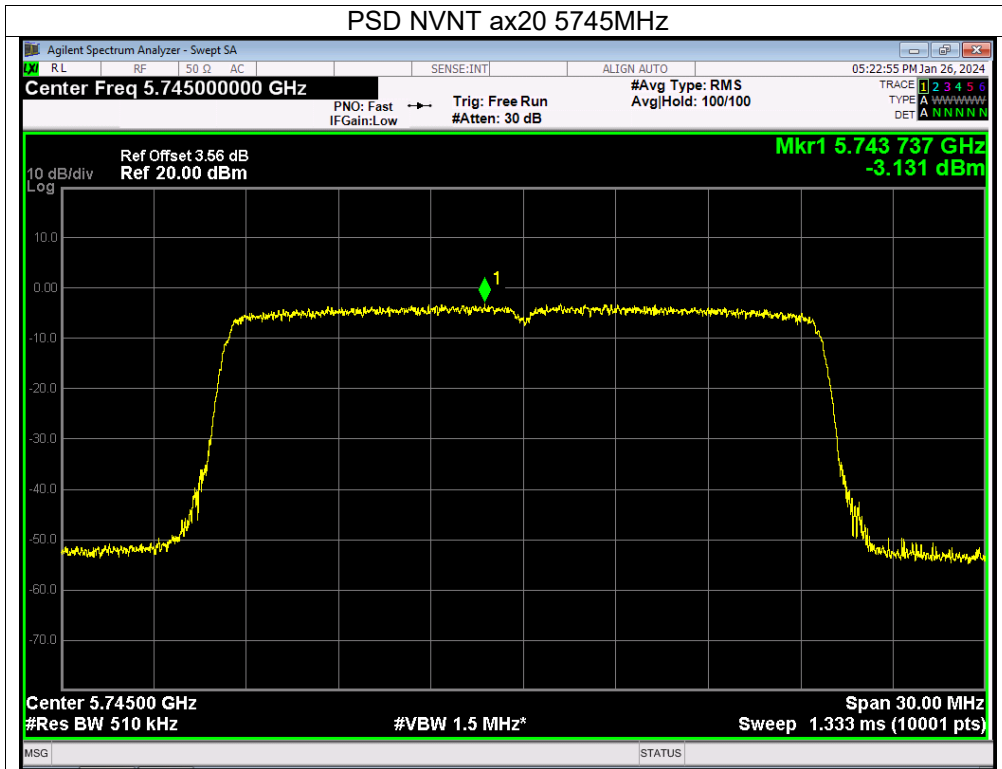

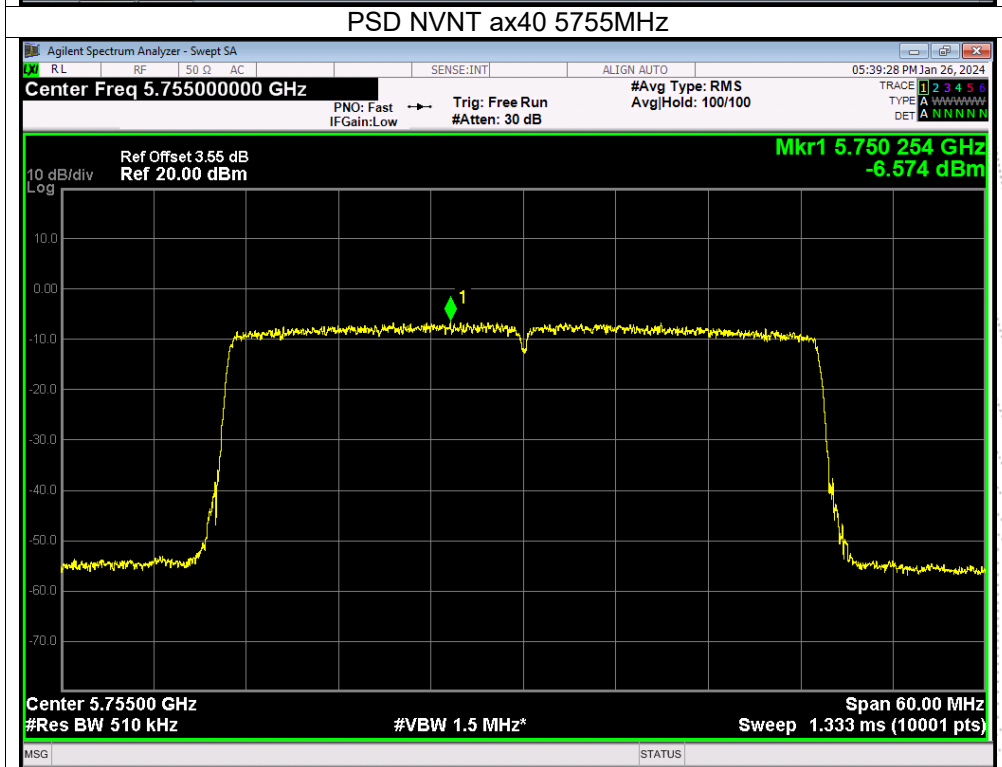
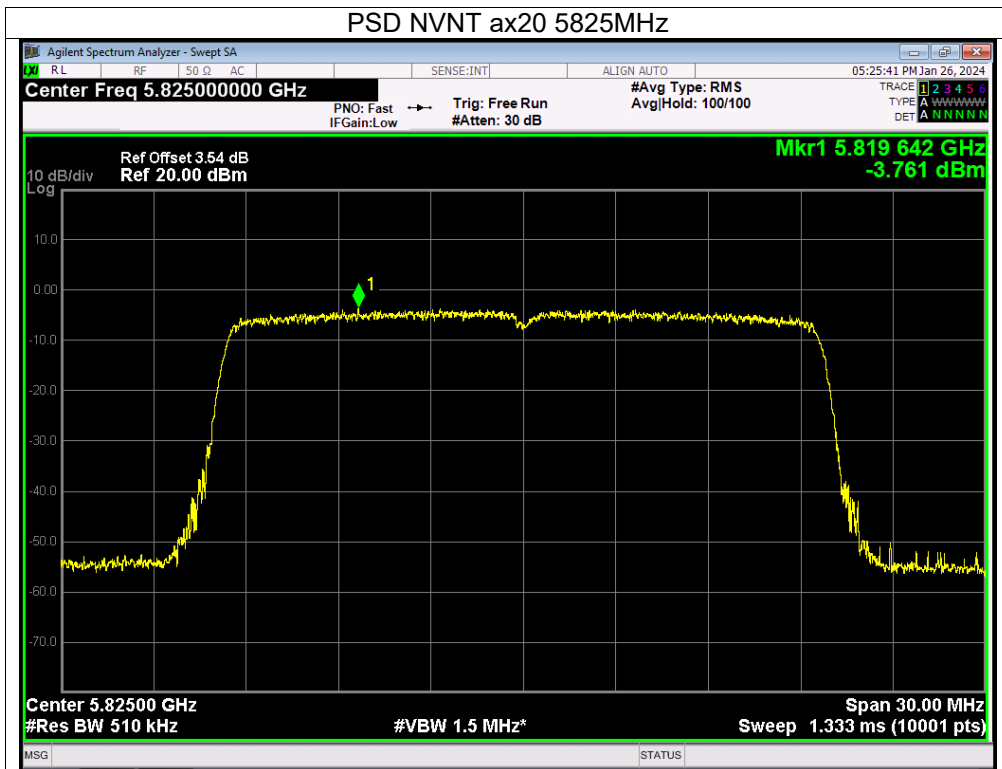

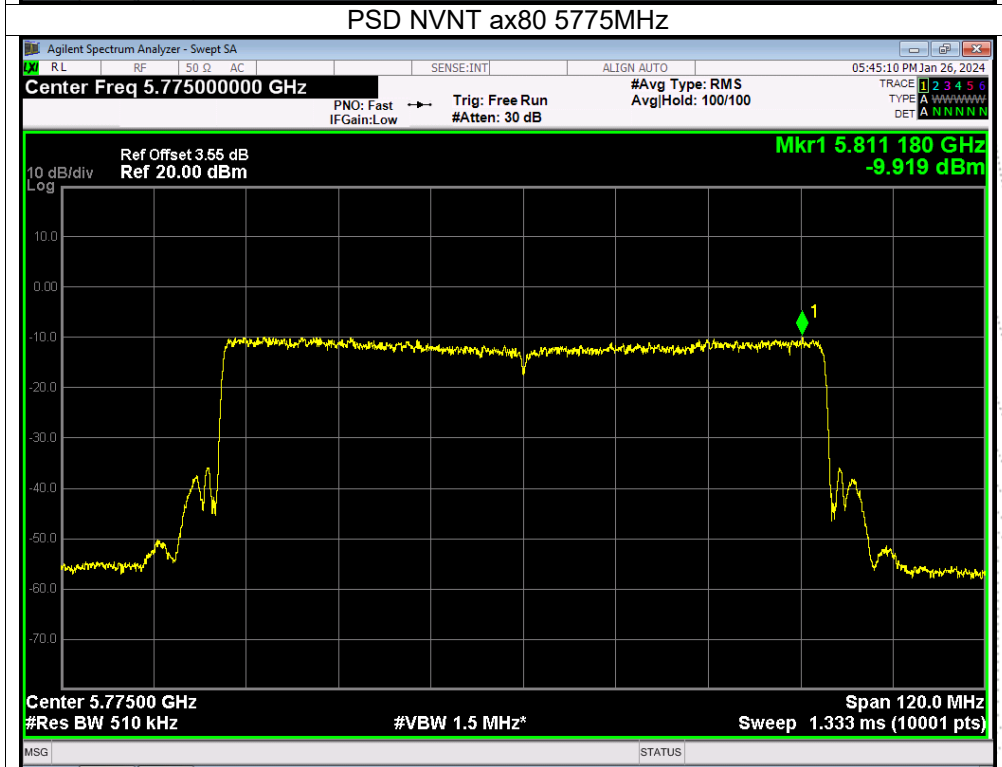
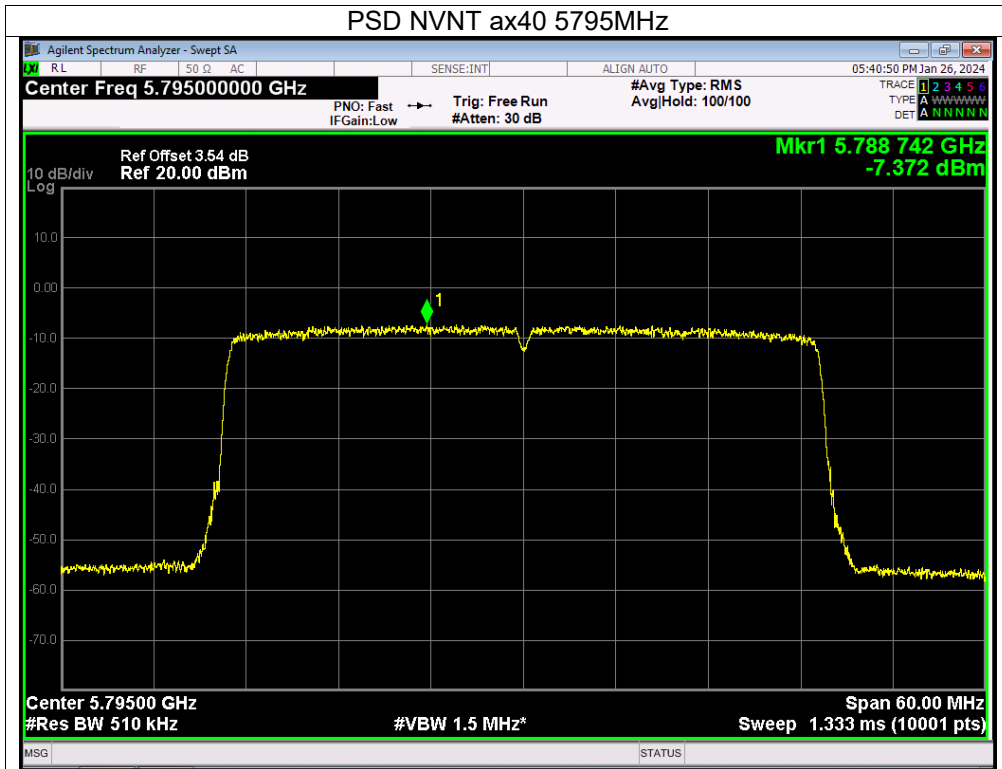

9. 26dB & 6dB & 99% Emission Bandwidth

9.1 Block Diagram Of Test Setup

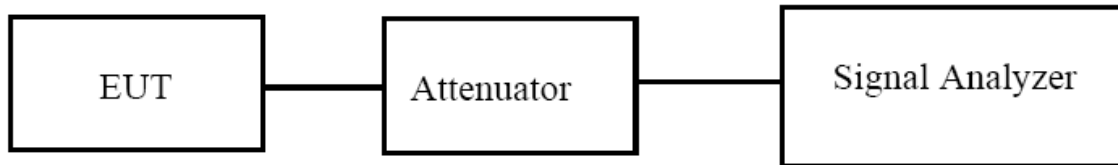

9.2 Limit

(1) For the band 5.15-5.25 GHz.

(iv) For mobile and portable client devices in the 5.15-5.25 GHz band, the maximum conducted output power over the frequency band of operation shall not exceed 250 mW provided the maximum antenna gain does not exceed 6 dBi. In addition, the maximum power spectral density shall not exceed 11 dBm in any 1 megahertz band. If transmitting antennas of directional gain greater than 6 dBi are used, both the maximum conducted output power and the maximum power spectral density shall be reduced by the amount in dB that the directional gain of the antenna exceeds 6 dBi.

(2) For the 5.25-5.35 GHz and 5.47-5.725 GHz bands, the maximum conducted output power over the frequency bands of operation shall not exceed the lesser of 250 mW or $11 \text{ dBm} + 10 \log B$, where B is the 26 dB emission bandwidth in megahertz. In addition, the maximum power spectral density shall not exceed 11 dBm in any 1 megahertz band. If transmitting antennas of directional gain greater than 6 dBi are used, both the maximum conducted output power and the maximum power spectral density shall be reduced by the amount in dB that the directional gain of the antenna exceeds 6 dBi.

(3) For the band 5.725-5.85 GHz, the maximum conducted output power over the frequency band of operation shall not exceed 1 W. In addition, the maximum power spectral density shall not exceed 30 dBm in any 500-kHz band. If transmitting antennas of directional gain greater than 6 dBi are used, both the maximum conducted output power and the maximum power spectral density shall be reduced by the amount in dB that the directional gain of the antenna exceeds 6 dBi. However, fixed point-to-point U-NII devices operating in this band may employ transmitting antennas with directional gain greater than 6 dBi without any corresponding reduction in transmitter conducted power. Fixed, point-to-point operations exclude the use of point-to-multipoint systems, omnidirectional applications, and multiple collocated transmitters transmitting the same information. The operator of the U-NII device, or if the equipment is professionally installed, the installer, is responsible for ensuring that systems employing high gain directional antennas are used exclusively for fixed, point-to-point operations.

9.3 Test Procedure

- Set RBW = approximately 1% of the emission bandwidth.
- Set the VBW > RBW.
- Detector = Peak.
- Trace mode = max hold.
- Measure the maximum width of the emission that is 26 dB down from the maximum of the emission. Compare this with the RBW setting of the analyzer. Readjust RBW and repeat measurement as needed until the RBW/EBW ratio is approximately 1%.

The following procedure shall be used for measuring (99 %) power bandwidth:

- Set center frequency to the nominal EUT channel center frequency.
- Set span = 1.5 times to 5.0 times the OBW.

3. Set RBW = 1 % to 5 % of the OBW
4. Set VBW $\geq 3 \cdot$ RBW
5. Video averaging is not permitted. Where practical, a sample detection and single sweep mode shall be used. Otherwise, peak detection and max hold mode (until the trace stabilizes) shall be used.
6. Use the 99 % power bandwidth function of the instrument (if available).
7. If the instrument does not have a 99 % power bandwidth function, the trace data points are recovered and directly summed in power units. The recovered amplitude data points, beginning at the lowest frequency, are placed in a running sum until 0.5 % of the total is reached; that frequency is recorded as the lower frequency. The process is repeated until 99.5 % of the total is reached; that frequency is recorded as the upper frequency. The 99% occupied bandwidth is the difference between these two frequencies.

9.4 EUT Operating Conditions

The EUT was configured for testing in a typical fashion (as a customer would normally use it). The EUT has been programmed to continuously transmit during test. This operating condition was tested and used to collect the included data.

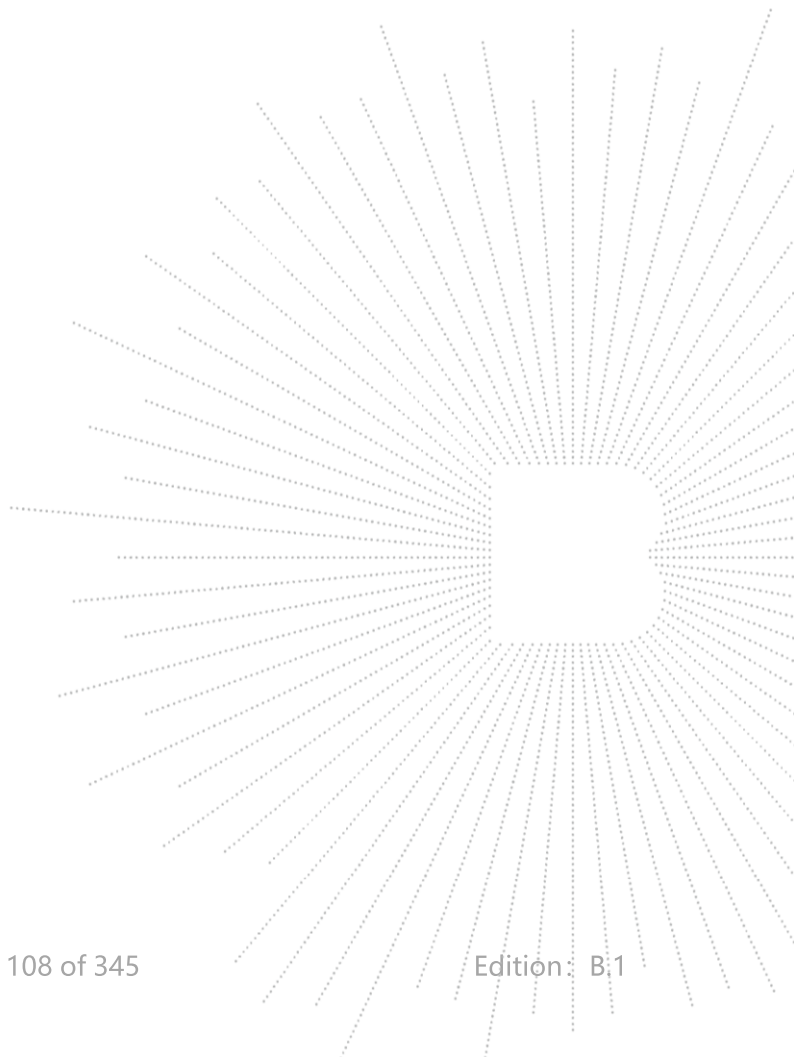

9.5 Test Result

Temperature:	26 °C	Relative Humidity:	54%
Pressure:	101KPa	Test Voltage:	AC 120V/60Hz
Test Mode:	(5180-5240MHz)		

Condition	Mode	Frequency (MHz)	-26 dB Bandwidth (MHz)		99% OBW (MHz)		Verdict
			Ant A	Ant B	Ant A	Ant B	
NVNT	a	5180	18.713	18.64	16.362	16.327	Pass
NVNT	a	5200	18.685	18.518	16.33	16.35	Pass
NVNT	a	5240	18.723	18.703	16.339	16.33	Pass
NVNT	n20	5180	19.689	19.435	17.508	17.521	Pass
NVNT	n20	5200	19.714	19.651	17.497	17.495	Pass
NVNT	n20	5240	19.691	19.457	17.525	17.504	Pass
NVNT	n40	5190	40.17	40.086	35.967	36.037	Pass
NVNT	n40	5230	40.056	40.2	36.023	36.03	Pass
NVNT	ac20	5180	19.664	19.602	17.498	17.507	Pass
NVNT	ac20	5200	19.689	19.561	17.511	17.492	Pass
NVNT	ac20	5240	19.659	19.653	17.511	17.516	Pass
NVNT	ac40	5190	39.952	39.886	36.045	36.069	Pass
NVNT	ac40	5230	39.866	39.697	36.103	36.076	Pass
NVNT	ac80	5210	87.967	88.247	76.229	76.189	Pass
NVNT	ax20	5180	20.628	20.631	18.896	18.908	Pass
NVNT	ax20	5200	20.664	20.633	18.873	18.841	Pass
NVNT	ax20	5240	20.607	20.651	18.902	18.893	Pass
NVNT	ax40	5190	39.66	39.61	37.602	37.638	Pass
NVNT	ax40	5230	39.628	39.611	37.646	37.645	Pass
NVNT	ax80	5210	82.11	79.781	77.323	77.231	Pass

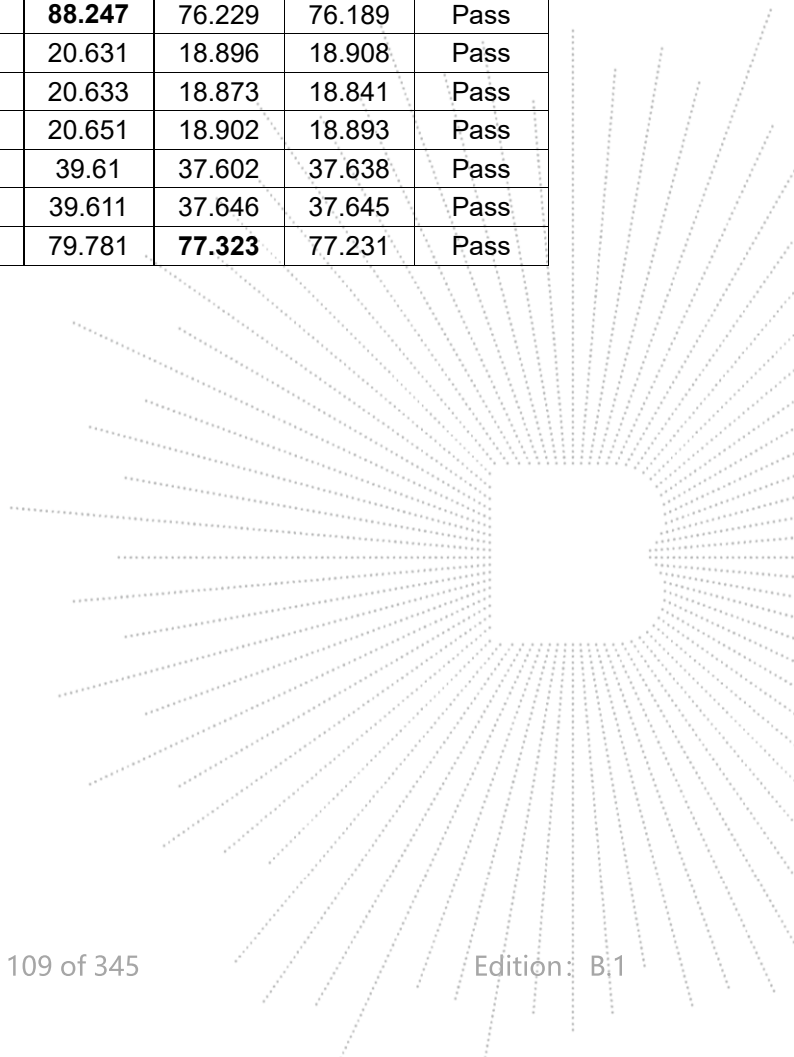

Note: A(B) Represent the value of antenna A and B, The worst data is Antenna B, only shown Antenna B Plot.

