

Quick Start Guide

Apply to: FE-W

Content

What's in the Box	2
Camera Introduction	3
Set up the Camera	5
Mount the Camera	7
Troubleshooting	12
Specifications	13
Notification of Compliance	14

What's in the Box

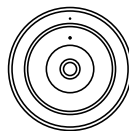

Camera



Mount Base

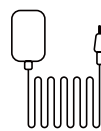

Power Adapter

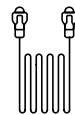

1m Ethernet Cable

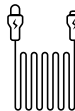

Power Extension Cable

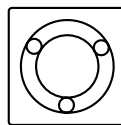

Mounting Hole Template



Quick Start Guide



Surveillance Sign

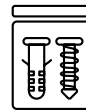

Pack of Screws

Camera Introduction

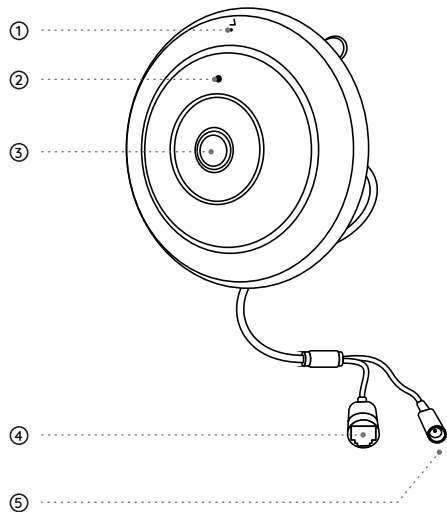

- ① Built-in Mic
- ② Daylight Sensor
- ③ Lens
- ④ Ethernet Port
- ⑤ Power Port

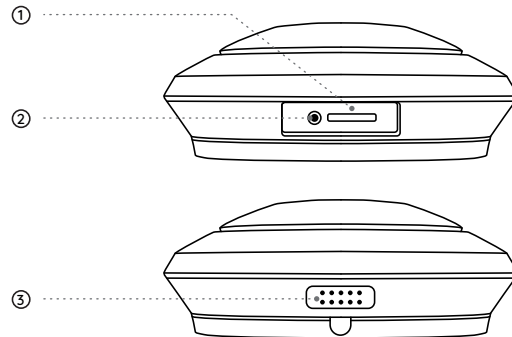

- ① Micro SD Card Slot
- ② Reset Button
* Press the reset button with a pin to restore factory settings.
- ③ Speaker

Set up the Camera

Set up the Camera on Phone

Step 1 Scan to download the Reolink App from the App Store or Google Play Store.



NOTE: If the Reolink App is already existed, please check if it is the newest; if no, please update it.

Step 2 Power on the camera.

Step 3 Launch the Reolink App. Click the “+” button in the top right corner and scan the QR code on the camera to add it.

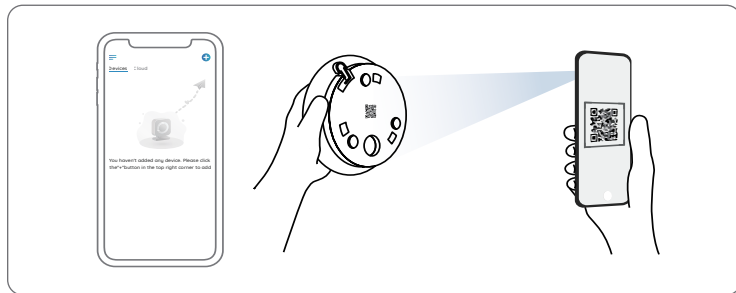

Step 4 Follow the onscreen instructions to finish the initial setup.

Set up the Camera on PC (Optional)

Step 1 Download and install the Reolink Client. Go to <https://reolink.com> > Support > App & Client

Step 2 Power on the camera.

Step 3 Launch the Reolink Client. Click the “+” button and input the UID number of the camera to add it.

Step 4 Follow the onscreen instructions to finish the initial setup.

Mount the Camera

Installation Tips

- Do not face the camera towards any light sources.
- Do not point the camera towards a glass window. Or, it may result in poor image quality because of the window glare by infrared LEDs, ambient lights or status lights.
- Do not place the camera in a shaded area and point it towards a well-lit area. Or, it may result in poor image quality. To ensure best image quality, the lighting condition for both the camera and the capture object shall be the same.
- To ensure better image quality, it's recommended to clean the lens with a soft cloth from time to time.
- Make sure the power ports are not directly exposed to water or moisture and not blocked by dirt or other elements.
- Do not install the camera at places where rain and snow can hit the lens directly.

Mount the Camera to the Wall

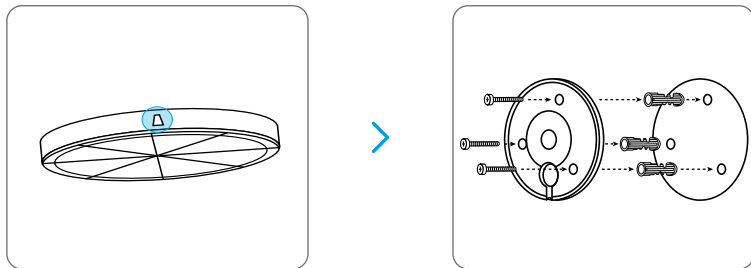

1. Before drilling the required holes, mark the direction of the lock printed on the mounting base. Make sure the lock is facing up, as shown in the diagram. This will help you align the mount base in the same orientation when installing.
2. Drill holes in accordance with the mounting hole template. Use the drywall anchors included in the package if needed. And use screws to secure the mount base to the wall with its cable groove facing downward.
3. Run the cable of the fisheye camera through the cable groove on the mount base.

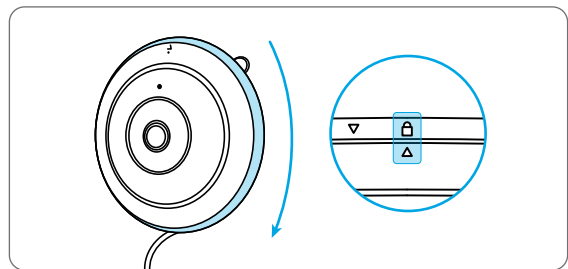

4. Attach the camera to the base and rotate the camera clockwise to lock it in position. Make sure the orientation arrow on the camera and the lock on the base are aligned.

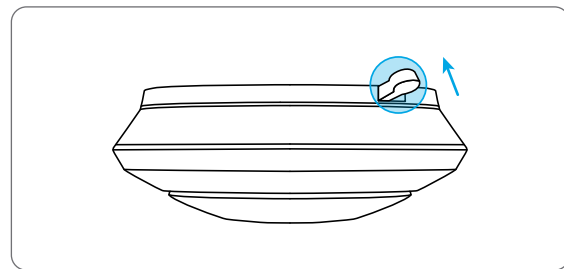

5. If you want to remove the camera from the mount base, press the release mechanism and rotate the camera counterclockwise.

Mount the Camera to Ceiling

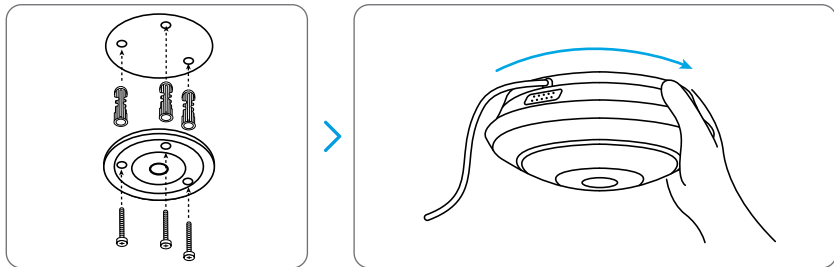

1. Drill holes in accordance with the mounting hole template. Use the drywall anchors included in the package if needed.
2. Secure the mount base to the ceiling with screws.
3. Run the cable of the fisheye camera through the cable groove on the mount base, and rotate the camera counterclockwise to lock it in position.

NOTE: Fit the three mounting holes of the camera into the mount base.

Troubleshooting

Infrared LEDs Stop Working

If the Infrared LEDs of your camera stop working, please try the following solutions:

- Enable infrared lights on Device Settings page via Reolink App/Client.
- Check if the Day/Night mode is enabled and set up auto infrared lights at night on Live View page via Reolink App/Client.
- Upgrade the firmware of your camera to the latest version.
- Restore the camera to factory settings and check out the infrared light settings again.

If these won't work, contact Reolink Support <https://support.reolink.com/>.

Failed to Upgrade the Firmware

If you fail to upgrade the firmware for the camera, try the following solutions:

- Check out the current camera firmware and see if it is the latest one.
- Make sure that you download the correct firmware from Download Center.
- Make sure that your PC is working on a stable network.

If these won't work, contact Reolink Support <https://support.reolink.com/>.

Specifications

Hardware Features

Night Vision: 8 Meters

Day/Night Mode: Auto Switchover

General

Operating Temperature: -10°C to 55°C (14°F to 131°F)

Operating Humidity: 10%-90%

For more specifications, visit <https://reolink.com/>.

Notification of Compliance

FCC Compliance Statement

This device complies with Part 15 of the FCC Rules. Operation is subject to the following two conditions:

this device may not cause harmful interference, and this device must accept any interference received, including interference that may cause undesired operation.

NOTE: This equipment has been tested and found to comply with the limits for a Class B digital device, pursuant to part 15 of the FCC Rules. These limits are designed to provide reasonable protection against harmful interference in a residential installation. This equipment generates uses and can radiate radio frequency energy and, if not installed and used in accordance with the instructions, may cause harmful interference to radio communications. However, there is no guarantee that interference will not occur in a particular installation. If this equipment does cause harmful interference to radio or television reception, which can be determined by turning the equipment off and on, the user is encouraged to try to correct the interference by one or more of the following measures:

- Reorient or relocate the receiving antenna.

- Increase the separation between the equipment and receiver.
- Connect the equipment into an outlet on a circuit different from that to which the receiver is connected.
- Consult the dealer or an experienced radio/TV technician for help.

Changes or modifications not expressly approved by the party responsible for compliance could void the user's authority to operate the equipment.

FCC RF Exposure Warning Statements

This equipment complies with FCC radiation exposure limits set forth for an uncontrolled environment. This equipment shall be installed and operated with minimum distance 20cm between the radiator & body.

Simplified EU Declaration of Conformity

Reolink declares that the WiFi camera is in compliance with the essential requirements and other relevant provisions of Directive 2014/53/EU, the PoE camera and NVR is in compliance with Directive 2014/30/EU.



Correct Disposal of This Product

This marking indicates that this product should not be disposed with other household wastes throughout the EU. To prevent possible harm to the environment or human health from uncontrolled waste disposal, recycle it responsibly to promote the sustainable reuse of material resources. To return your used device, please use the return and collection systems or contact the retailer where the product was purchased. They can take this product for environment safe recycling.

Limited Warranty

This product comes with a 2-year limited warranty that is valid only if purchased from Reolink Official Store or a Reolink authorized reseller. Learn more: <https://reolink.com/warranty-and-return/>.

NOTE: We hope that you enjoy the new purchase. But if you are not satisfied with the product and plan to return, we strongly suggest that you reset the camera to factory default settings and take out the inserted SD card before returning.

Terms and Privacy

Use of the product is subject to your agreement to the Terms of Service and Privacy Policy at reolink.com. Keep out of reach of children.

End User License Agreement

By using the Product Software that is embedded on the Reolink product, you agree to the terms of this End User License Agreement (“EULA”) between you and Reolink. Learn more: <https://reolink.com/eula/>.

ISED Statements

This device contains licence-exempt transmitter(s)/receiver(s) that comply with Innovation, Science and Economic Development Canada’s licence-exempt RSS(s). Operation is subject to the following two conditions:

- (1) This device may not cause interference.
- (2) This device must accept any interference, including interference that may cause

undesired operation of the device.

L’émetteur/récepteur exempt de licence contenu dans le présent appareil est conforme aux CNR d’Innovation, Sciences et Développement économique Canada

applicables aux appareils radio exempts de licence. L’exploitation est autorisée aux deux conditions suivantes :

- (1) L’ appareil ne doit pas produire de brouillage;
- (2) L’ appareil doit accepter tout brouillage radioélectrique subi, même si le brouillage est susceptible d’ en compromettre le fonctionnement.

Radio Frequency Exposure Statement for IC

This transmitter must not be co-located or operating in conjunction with any other antenna or transmitter. This equipment should be installed and operated with a minimum distance of 20 centimeters between the radiator and your body.

Cet émetteur ne doit pas être Co-placé ou ne fonctionnant en même temps qu’aucune autre antenne ou émetteur. Cet équipement devrait être installé et actionné avec une distance minimum de 20 centimètres entre le radiateur et votre corps.

NOTE: 5150-5250MHz for indoor use

Remarque: utilisation intérieure 5150 - 5250 MHz

OPERATING FREQUENCY(For WiFi Version)
(the maximum transmitted power)

Technical Support

If you need any technical help, please visit our official support site and contact our support team before returning the products, <https://support.reolink.com>.