

SPECIFICATION FOR APPROVAL

CUSTOMER :	睿睿联联
PART NAME :	B17
PART NO. :	
DZZ NO. :	N12-6822-R0BB
REV. :	

	MANUFACTURERR SIGNATURE	CUSTOMER SIGNATURE
APPROVED BY:		
DATE:		

Shenzhen be-comfortable technology.co.,LTD

深圳市得自在科技有限公司

Address: No.1606,Build C6,HengFeng industrial city,xixiang street,baoan district,Shenzhen

shanghai mengju technology co., LTD

上海市盟钜科技有限公司

103B, Build10, No.198 Zhang Heng Road , Pudong New Area,Shanghai

CONTENTS

Item	Description	Page
1. Antenna specification tablebl... ..	1
2.Test report	3~9
3.drdrawinga.....	10
4.Packaging method.....	11

Antenna Assembly

Specification(With housing)

1.Electrical Properties

- 1.1 Frequency range.....2.4~2.5/5150-5850GHz/5.55.85
- 1.2 Impedance.....50Ω Norminal
- 1.3 VSWR <3.05
- 1.4 Radiation.....Omni
- 1.5 Gain(Peak).....: 2.4G:2dBi/5G:2.5dBi
- 1.6 Polarization.....Linear
- 1.7 Admitted Power.....1W
- 1.8 Connector.....

2.Physical Properties

- 2.1 Working Temperature.....-30°C~+75°C
- 2.2 Storage Temperature.....-30°C~+75°C

Antenna Design for 1663

Document Number	DZZ-2022/11/156
Released Date	119/156/2022
Author	bBing Zhanging Zhang
Review By	Huiping Feng

1. Antennas' setup and enviroment With housing

Single antenna



2. Analyzer Measurement

2.1 Ant3 2.4G/5 WIFI-2 passive

test results

Single antenna standing wave less than 3.0

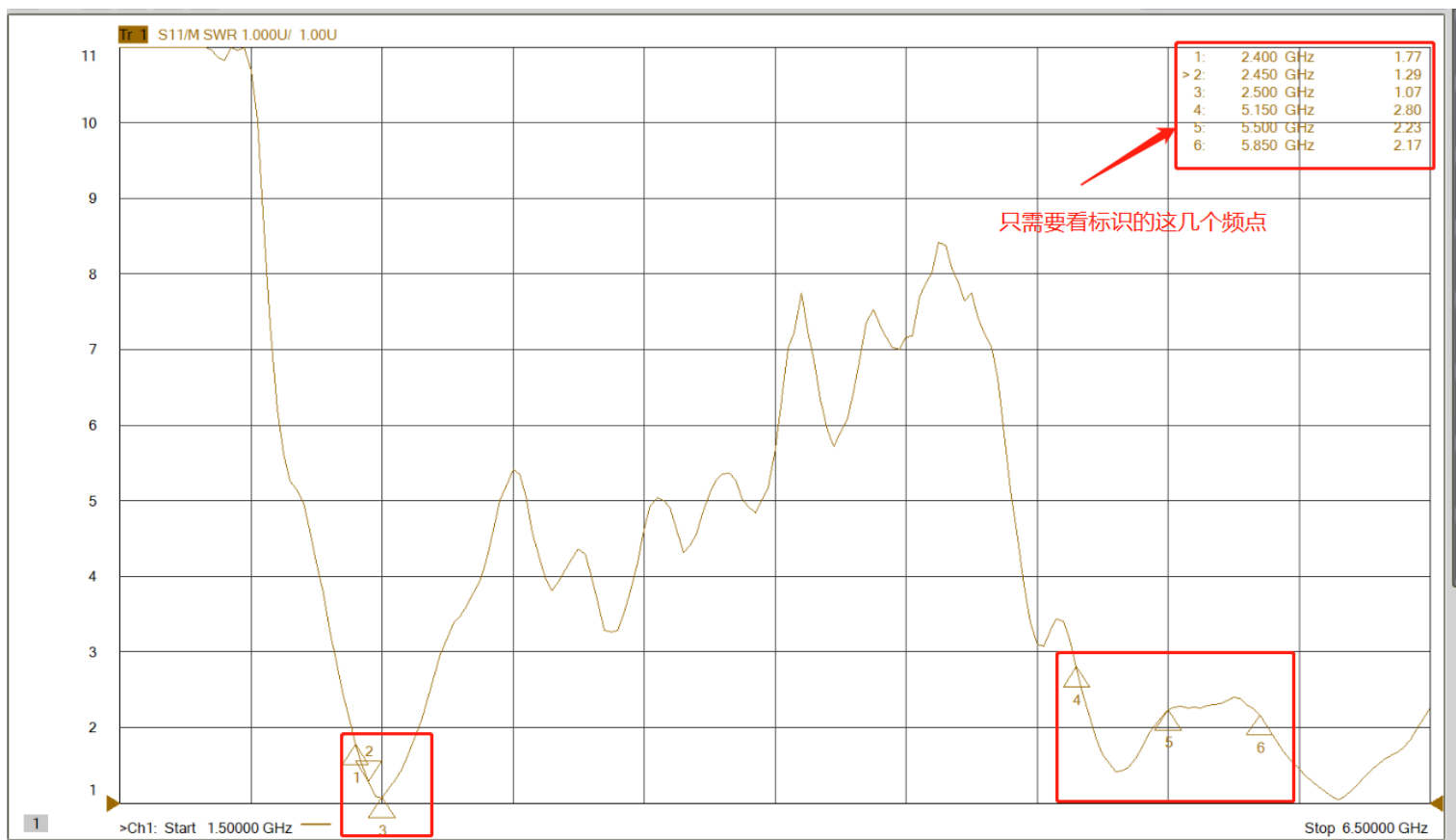

4.1 WiFi Gain & Efficiency

Frequency ID	1	2	3	4	5	6	7	8	9	10	11
Frequency (MHz)	2400.0	2410.0	2420.0	2430.0	2440.0	2450.0	2460.0	2470.0	2480.0	2490.0	2500.0
Gain (dBi)	2.29	1.40	1.18	1.36	2.29	2.77	2.55	2.08	1.85	1.67	1.68
Efficiency (%)	72.04	68.24	63.06	61.90	63.88	63.51	63.17	65.05	69.68	68.89	69.63

Frequency ID	12	14	16	17	19	20	21	22	25	26
Frequency (MHz)	5150.0	5250.0	5350.0	5400.0	5500.0	5550.0	5600.0	5650.0	5800.0	5850.0
Gain (dBi)	2.97	2.95	2.85	3.36	2.95	3.83	3.20	2.47	1.46	1.25
Efficiency (%)	55.64	57.08	59.30	61.76	56.50	66.54	57.25	48.72	50.97	50.95

3D Pattern @2400-2500/5150-5850MHZ

2400MHZ

XZ

YZ

XY

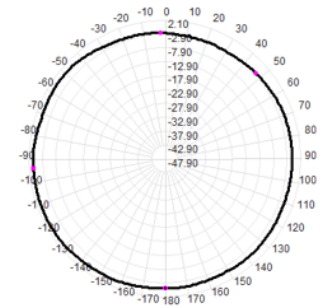
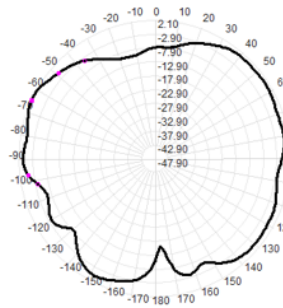
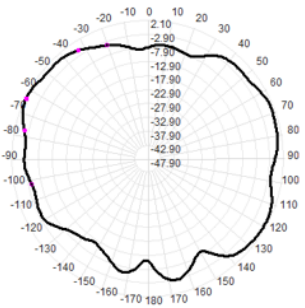
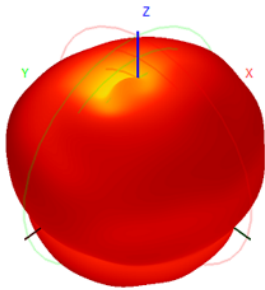

2500MHZ

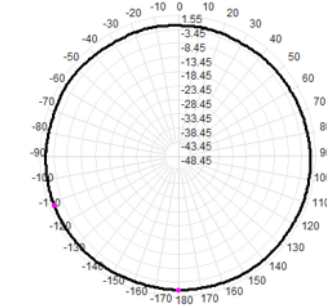
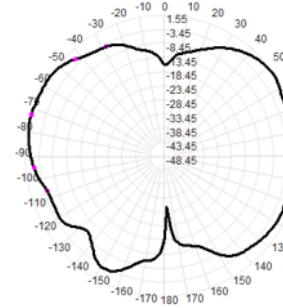
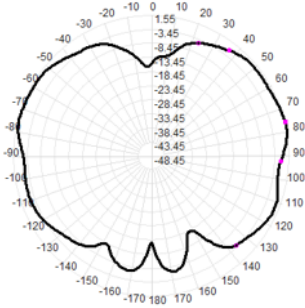
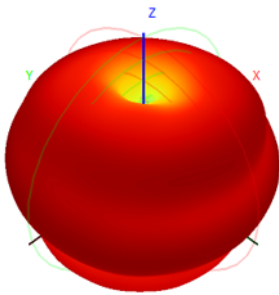

5150MHZ

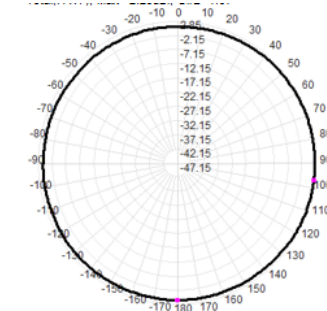
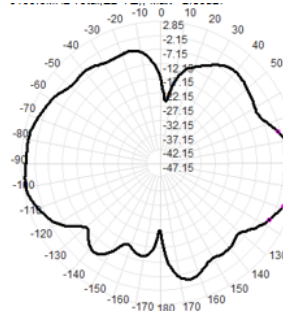
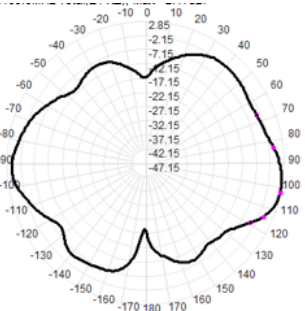
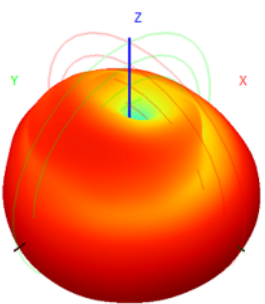

5850MHZ

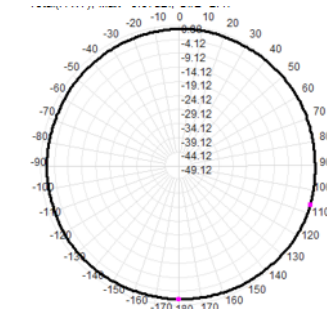
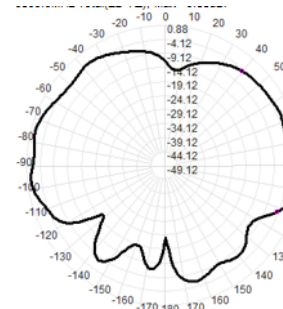
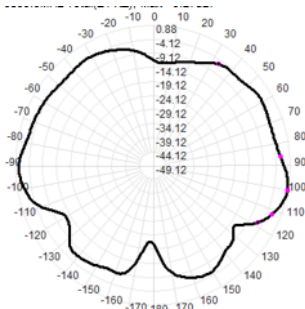
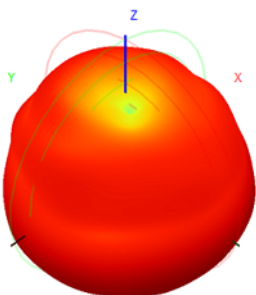

Product packaging specification

DATE:2022-11-15

page: 1 of 1

Products Name: B17-WIFI	Version:A
	Customer:睿联

1: Antenna products

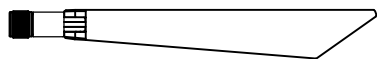

2: Bagging, each PE bag contains 50pcs of products; The terminal shall be wrapped with foam.

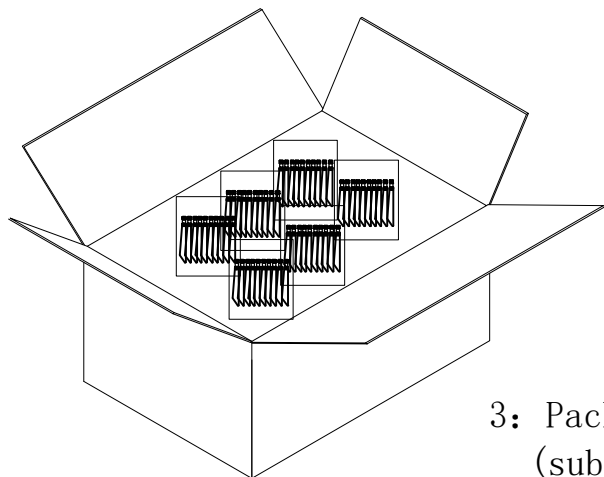

3: Packing 12 bags per box, 600PCS in total (subject to the actual packaging)

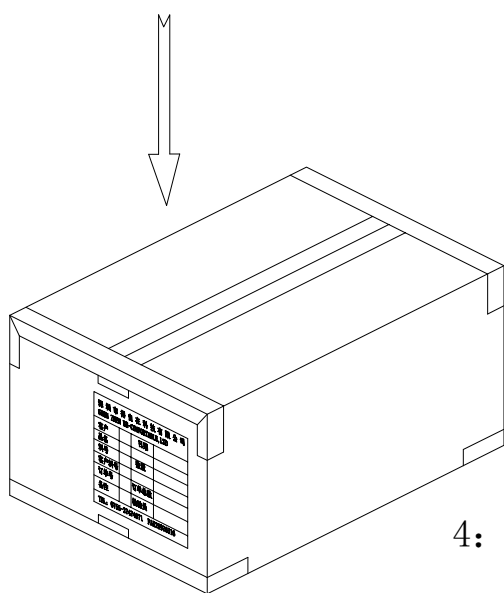

4: Our production label and RoHS label are pasted on the outer case.

由 Autodesk 教育版产品制作

Approved: _____ Checked: _____ Designed: 李从放