

Reolink Argus Eco

Quick Start Guide

Contents

What's in the Box	2
Camera Introduction	3
Set up the Camera	4
Charge the Battery	5
Install the Camera	6
Notes on PIR Motion Sensor	9
Important Notes on Rechargeable Battery Usage	11
Troubleshooting	12
Specifications	13
Notification of Compliance	13

What's in the Box



Argus Eco
(with Battery)



Antenna



Outdoor Security Mount
(with a hook & loop strap)



Reset Needle



Surveillance Sign

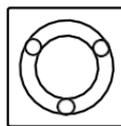

Mounting
Hole Template



Micro USB Cable



Pack of Screws



Quick Start Guide

Camera Introduction

- Built-in Mic
- Status LED
- Lens
- Daylight Sensor
- Built-in PIR Sensor
- Reset hole
*Press the reset button with a pin to restore camera to factory settings.
- Power Switch
- Micro SD CardSlot
*Always keep the rubber plug closed firmly.
- Speaker
- Antenna
- Micro USB Port
- Battery Status LED

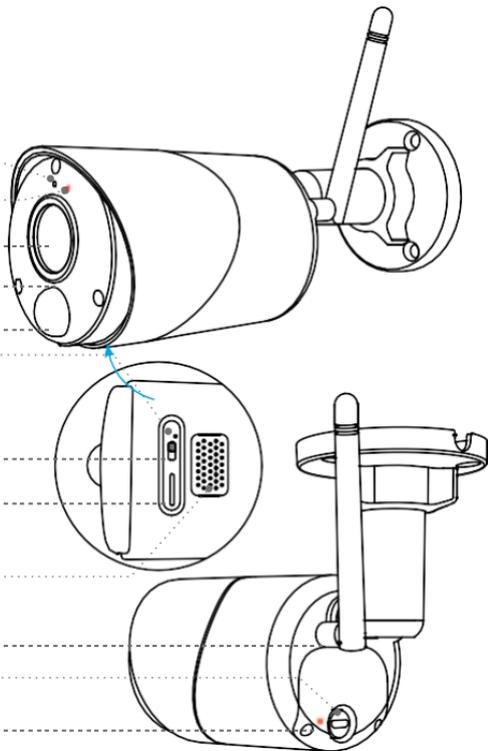

Different states of the status LED:

- Red Light: WiFi connection failed
- Blue Light: WiFi connection succeeded

- Blinking: Standby status
- On: Working status

Set up the Camera

Download and Launch the Reolink App or Client software, and follow the onscreen instructions to finish initial setup.

• On Smartphone

Scan to download the Reolink App.



• On PC

Download path of the Reolink Client: Go to <https://reolink.com> > Support > App & Client.

Charge the Battery

It's recommended to fully charge the battery before mounting the camera outdoors.

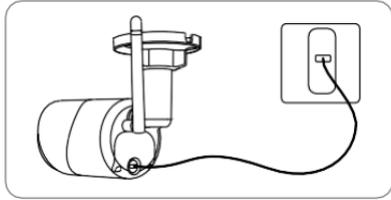

Charge the battery with a power adapter.

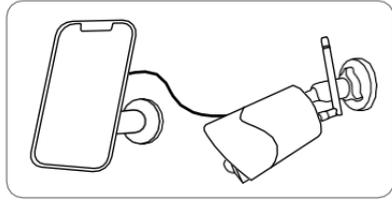

Charge the battery with Reolink solar panel.

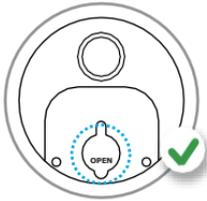

For better weatherproof performance, please always cover the USB charging port with the rubber plug after charging the battery.

Charging indicator:

- Orange LED: Charging
- Green LED: Fully charged

NOTE: The solar panel is NOT included in the package. You can buy one from Reolink official online stores.

Install the Camera

- Install the camera 2-3 meters (7-10 ft) above the ground. This height maximizes the detection range of the PIR motion sensor.

- For better motion detection performance, please install the camera angularly.

NOTE: If a moving object approaches the PIR sensor vertically, the camera may fail to detect motion.

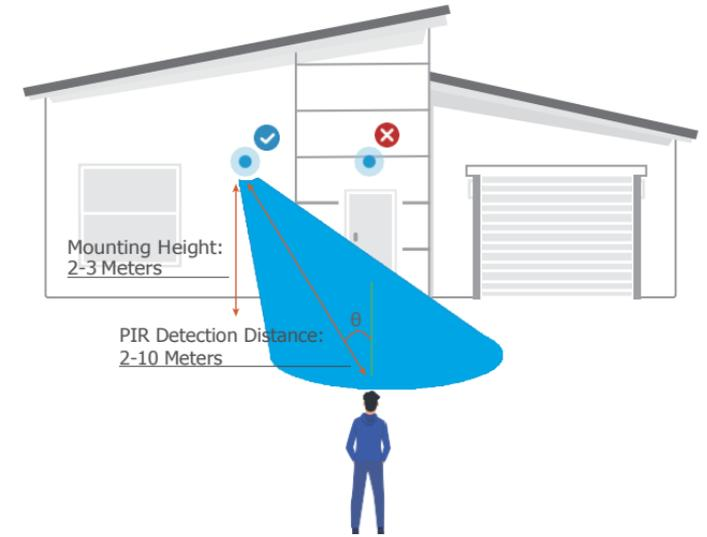

Mount the Camera

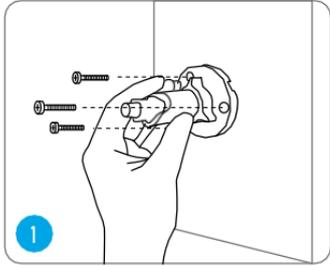

Drill holes in accordance with a mounting hole template and screw the security mount into the wall. If you are mounting the camera on any hard surface, insert plastic anchors into the holes first.

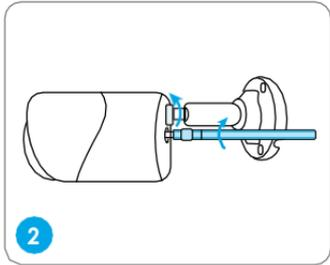

Screw the antenna to the camera and then install the camera to the security mount.

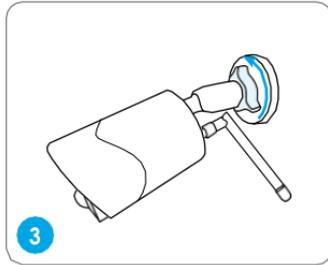

Loose the adjusting knob on the mount and adjust the camera to the proper direction.

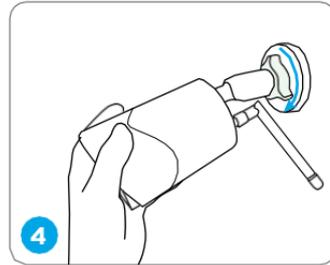

Stiffen the adjustment knob to lock the camera.

Attach the Camera to a Tree

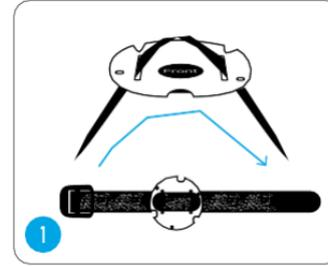

Thread the provided strap to the mounting plate.

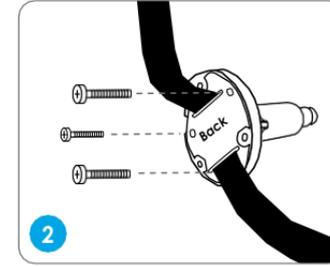

Attach the plate to the security mount with the smaller screws.

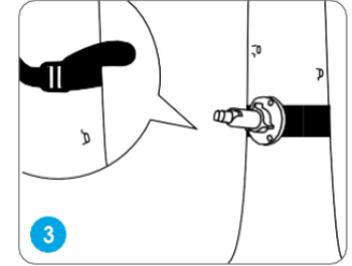

Fasten the security mount to a tree.

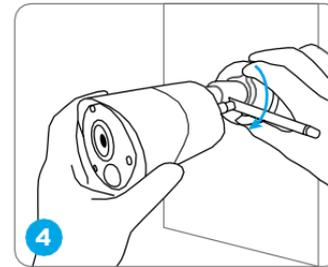

Install the camera and adjust the camera angles as instructed in step 3 in the previous installation guide.

Notes on PIR Motion Sensor

PIR Sensor Detection Distance

The PIR detection range can be customized to meet your specific needs. You can refer to the following table to set it up in Device Settings via Reolink App.

Sensitivity	Value	Detection Distance (For moving and living objects)
Low	0 - 50	Up to 5 meters (16ft)
Mid	51 - 80	Up to 8 meters (26ft)
High	81 - 100	Up to 10 meters (33ft)

NOTE: Higher sensitivity offers longer detection distance but it may lead to more false alarms. It's recommended to set up the sensitivity level to "Low" or "Mid" when you install the camera outdoors.



Important Notes on Reducing False Alarms

- Do not face the camera towards any objects with bright lights, including sunshine, bright lamp lights, etc.
- Do not place the camera too close to a place with heavy traffic. Based on our numerous tests, the recommended distance between the camera and the vehicle would be 16 meters (52ft).
- Do not place the camera near outlets, including the air conditioner vents, humidifier outlets, the heat transfer vents of projectors, etc.
- Do not install the camera at places with strong wind.
- Do not face the camera towards a mirror.
- Keep the camera at least 1 meter away from any wireless devices, including WiFi routers and phones in order to avoid wireless interference.

Important Notes on Rechargeable Battery Usage

Reolink Argus Eco is not designed for 24/7 full capacity running or around-the-clock live streaming. It's designed to record motion events and remotely view live streaming only when you need it. Learn useful tips on how to extend the battery life in this post: <https://support.reolink.com/hc/en-us/articles/360006991893>

1. Charge the rechargeable battery with a standard and high-quality DC 5V/9V battery charger or Reolink solar panel. Do not charge the battery with solar panels from any other brands.
2. Charge the battery when temperatures are between 0°C and 45°C and always use the battery when temperatures are between -20°C and 60°C.
3. Keep the USB charging port dry, clean and free of any debris and cover the USB charging port with the rubber plug when the battery is fully charged.
4. Do not charge, use or store the battery near any ignition sources, such as fire or heaters.
5. Do not disassemble, cut, puncture, short-circuit the battery, or dispose of the battery in water, fire, microwave ovens and pressure vessels.
6. Do not use the battery if it gives off an odor, generates heat, becomes discolored or deformed, or appears abnormal in any ways. If the battery is being used or charged, remove the battery from the device or the charger immediately, and stop using it.
7. Always follow the local waste and recycle laws when you get rid of the used battery.

Troubleshooting

Camera Is Not Powering on

If your camera is not powering on, please apply the following solutions:

- Make sure the power switch is turned on.
- Charge the battery with a DC 5V/2A power adapter. When the green light is on, the battery is fully charged.

If these won't work, please contact Reolink Support <https://support.reolink.com/>.

Failed to Scan the QR Code on the Phone

If you cannot scan the QR code on your phone, please try the following solutions:

- Remove the protective film from the camera lens.
- Wipe the camera lens with a dry paper/towel/tissue.
- Vary the distance between your camera and the mobile phone so that the camera can focus better.

- Try to scan the QR code under sufficient lighting.

If these won't work, please contact Reolink Support <https://support.reolink.com/>.

WiFi Connection Failed During Initial Setup Process

If the camera fails to connect to WiFi, please try the following solutions:

- Please make sure the WiFi band is 2.4GHz, the camera does not support 5GHz.
- Put the camera closer to your router to ensure a strong WiFi signal.
- Change the encryption method of the WiFi network to WPA2-PSK/WPA-PSK (safer encryption) on your router interface.
- Change your WiFi SSID or password and make sure that SSID is within 31 characters and password is within 64 characters.
- Set your password using only the characters available on the keyboard.

If these won't work, please contact Reolink Support <https://support.reolink.com/>.

Specifications

Video

Video Resolution: 1080p HD at 15 frames/sec
Field of View: 100° diagonal
Night Vision: Up to 10 m (33 ft)

PIR Detection & Alerts

PIR Detection Distance:
Adjustable/up to 10m (33ft)
PIR Detection Angle: 100° horizontal
Audio Alert:
Customized voice-recordable alerts
Other Alerts:
Instant email alerts and push notifications

General

Operating Temperature:
-10°C to 55°C (14°F to 131°F)
Weather Resistance:
IP65 certified weatherproof
Size: 71 x 186 mm
Weight (Battery included): 320g (11.2 oz)

Antenna List
External Antenna, 2dBi, 2400-2500MHz

Notification of Compliance

FCC Compliance Statement

This device complies with Part 15 of the FCC Rules. Operation is subject to the following two conditions: (1) this device may not cause harmful interference, and (2) this device must accept any interference received, including interference that may cause undesired operation. Changes or modifications not expressly approved by the party responsible for compliance could void the user's authority to operate the equipment.

NOTE: This equipment has been tested and found to comply with the limits for a Class B digital device, pursuant to Part 15 of the FCC Rules. These limits are designed to provide reasonable protection against harmful interference in a residential installation. This equipment generates, uses and can radiate radio frequency energy and, if not installed and used in accordance with the instructions, may cause harmful interference to radio communications. However, there is no

guarantee that interference will not occur in a particular installation. If this equipment does cause harmful interference to radio or television reception, which can be determined by turning the equipment off and on, the user is encouraged to try to correct the interference by one or more of the following measures:

- Reorient or relocate the receiving antenna.
- Increase the separation between the equipment and receiver.
- Connect the equipment into an outlet on a circuit different from that to which the receiver is connected.
- Consult the dealer or an experienced radio/TV technician for help.

FCC RF warning statement:
This equipment complies with FCC radiation exposure limits set forth for an uncontrolled environment. This equipment shall be installed and operated with minimum distance 20cm between the radiator & body.



Simplified EU Declaration of Conformity

Reolink declares that this device is in compliance with the essential requirements and other relevant provisions of Directive 2014/53/EU.



Correct Disposal of This Product

This marking indicates that this product should not be disposed with other household wastes throughout the EU. To prevent possible harm to the environment or human health from uncontrolled waste disposal, recycle it responsibly to promote the sustainable reuse of material resources. To return your used device, please use the return and collection systems or contact the retailer where the product was purchased. They can take this product for environment safe recycling.

Limited Warranty

This product comes with a 2-year limited warranty that is valid only if purchased from Reolink Official Store or a Reolink authorized reseller. Learn more:

<https://reolink.com/warranty-and-return/>.

NOTE: We hope that you enjoy the new purchase. But if you are not satisfied with the product and plan to return, we strongly suggest that you reset the camera to factory default settings and take out the inserted SD card before returning.

Terms and Privacy

Use of the product is subject to your agreement to the Terms of Service and Privacy Policy at reolink.com. Keep out of reach of children.

End User License Agreement

By using the Product Software that is embedded on the Reolink product, you agree to the terms of this End User License Agreement ("EULA") between you and Reolink. Learn more: <https://reolink.com/eula/>.

ISED Radiation Exposure Statement

This equipment complies with RSS-102 radiation exposure limits set forth for an uncontrolled environment. This equipment should be installed and operated with minimum distance 20cm between the radiator & your body.
Cet équipement est conforme aux limites d'exposition IC établies pour un environnement non contrôlé. Cet équipement doit être installé et utilisé avec une distance minimale de 20 cm entre le radiateur et le corps.

OPERATING FREQUENCY

(the maximum transmitted power)

2412MHz—2472MHz (18dBm)

Technical Support

If you need any technical help, please visit our official support site and contact our support team before returning the products, <https://support.reolink.com>.

This device contains licence-exempt transmitter(s)/receiver(s) that comply with Innovation, Science and Economic Development Canada's licence-exempt RSS(s). Operation is subject to the following two conditions:

- (1) This device may not cause interference.
- (2) This device must accept any interference, including interference that may cause undesired operation of the device.

L'émetteur/récepteur exempt de licence contenu dans le présent appareil est conforme aux CNR d'Innovation, Sciences et Développement économique Canada applicables aux appareils radio exempts de licence. L'exploitation est autorisée aux deux conditions suivantes:

- (1) L' appareil ne doit pas produire de brouillage;
- (2) L' appareil doit accepter tout brouillage radioélectrique subi, même si le brouillage est susceptible d' en compromettre le fonctionnement.

This radio transmitter [IC: 26839-2204B] has been approved by Innovation, Science and Economic Development Canada to operate with the antenna types listed below, with the maximum permissible gain indicated. Antenna types not included in this list that have a gain greater than the maximum gain indicated for any type listed are strictly prohibited for use with this device.

Cet émetteur radio [IC: 26839-2204B] a été approuvé par Innovation, Sciences et Développement économique Canada pour fonctionner avec les types d'antenne énumérés ci-dessous, avec le gain maximal admissible indiqué. Les types d'antenne non inclus dans cette liste qui ont un gain supérieur au gain maximum indiqué pour tout type répertorié sont strictement interdits pour une utilisation avec cet appareil.