

RLC-410W

# Quick Start Guide

## Contents

What's in the Box .....	2
Camera Introduction .....	3
Connection Diagram .....	4
Set up the Camera .....	5
Install the Camera .....	6
Troubleshooting .....	10
Specifications .....	11
Notification of Compliance .....	11

## What's in the Box

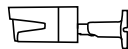

Camera



Antenna

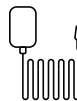

Power Adapter



1m  
Network Cable



4.5m Power  
Extension Cable

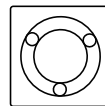

Mounting  
Template

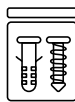

Pack  
of Screws



Surveillance Sign



Quick Start Guide

**NOTE:** Camera and accessories vary with different camera models that you purchase.

## Camera Introduction

Antenna

Mount

Metal Aluminum Case

Infrared Lights

High Definition Lens

Daylight Sensor

Built-in Mic

Network Cable

Reset Button

\* Press for about 10 seconds to restore factory settings.

Power Cable

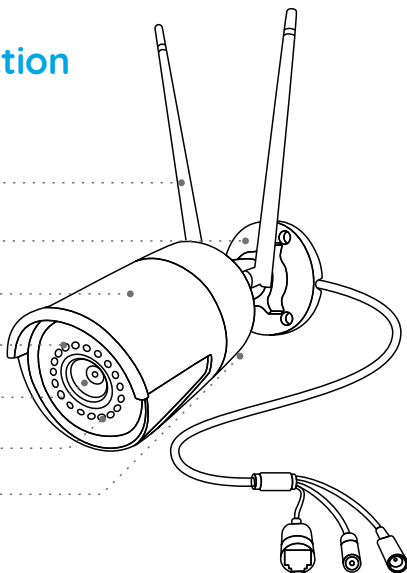

## Connection Diagram

Before initial setup, follow the steps below to connect your camera.

1. Connect the camera to a LAN port on your router with an Ethernet cable.
2. Power on the camera with a power adapter.

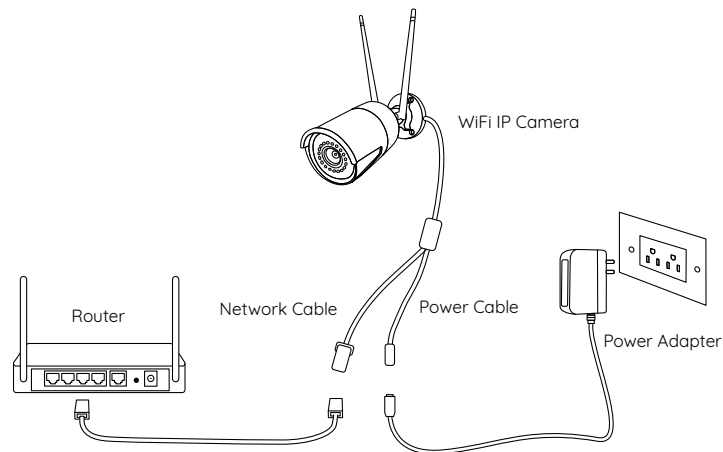

## Set up the Camera

Download and Launch the Reolink App or Client software, and follow the onscreen instructions to finish initial setup.

### • On Smartphone

Scan to download the Reolink App.



### • On PC

Download path of the Reolink Client: Go to <https://reolink.com> > Support > App & Client.

## Install the Camera

### Installation Tips

- Do not face the camera towards any light sources.
- Do not point the camera towards a glass window. Or, it may result in poor image performance because of the window glare by infrared LEDs, ambient lights or status lights.
- Do not place the camera in a shaded area and point it towards a well-lit area. Or, it may result in poor image performance. For better image quality, please make sure that the lighting condition for both the camera and the capture object is the same.
- For better image quality, it's recommended to clean the lens with a soft cloth from time to time.
- Make sure the power ports are not exposed to water or moisture or blocked by dirt or other elements.
- Do not install the camera at places where rain and snow may hit the lens directly.
- The camera may work in extreme cold conditions as low as -25°C. Because when it is powered on, the camera will produce heat. You may power on the camera indoors for a few minutes before installing it outdoors.

**NOTE:** There are two different types of mounts for bullet cameras. Please check out the mount included in the package and follow the corresponding instruction to install the camera properly.

## Mount the Camera

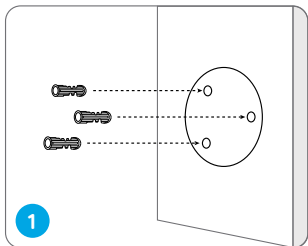

Drill holes in accordance with the mounting hole template.

**NOTE:** Use the drywall anchors included in the package if needed.

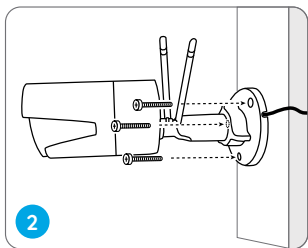

Install the mount base with the mounting screws included in the package.

**NOTE:** Run the cable through the cable notch on the mount base.

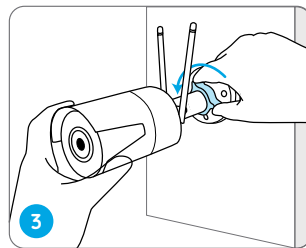

To get the best field of view, loosen the adjustment knob on security mount and turn the camera.

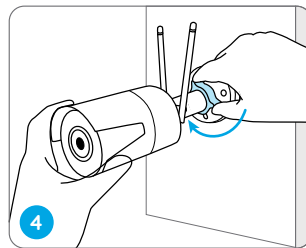

Stiffen the adjustment knob to lock the camera.

**NOTE:** If your camera has another mount without the adjusting knob, please loosen the adjusting screw with the provided hex key and turn the camera as shown below to adjust the angle.

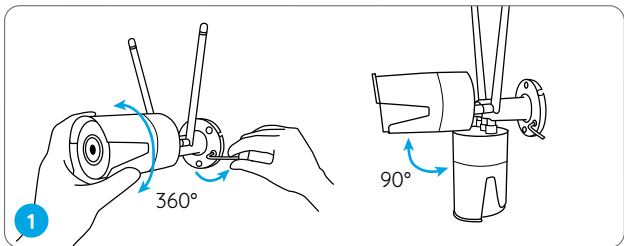

Twist the screws with the wrench to unlock the camera and adjust its direction.

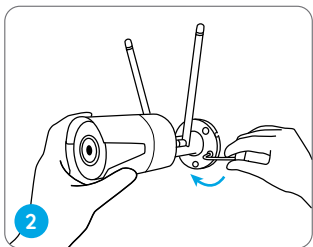

After adjustment, twist the screws back to lock the camera.

## Troubleshooting

### IP Camera Is Not Powering on

If you find your camera is not powering on, try the following solutions:

- Please check whether the outlet is working properly or not. Try to plug the camera into a different outlet and see if it works.
- Please check whether the DC adapter is working or not. If you have another 12V DC power adapter which is working, please use another power adapter and see if it works.

If these won't work, please contact Reolink Support

<https://support.reolink.com>

### IR LEDs Stop Working

If you find the IR LEDs of your camera stop working, try the following solutions:

- Go to Device Settings and check whether you have enabled Infrared LEDs. If the LEDs are disabled, please enable them.
- Please go to Live View and check the Day/Night mode. Set the mode to Auto to activate the IR lights.
- Upgrade your camera's firmware to the latest version.
- Restore the camera to the factory settings and check the IR light settings again.

If these won't work, please contact Reolink Support  
<https://support.reolink.com>

## Specifications

### Hardware Features

IR Distance: 30 meters (100ft)  
Day/Night Mode: Auto switchover

### General

Operating Temperature: -10°C to 55°C (14°F to 131°F)  
Operating Humidity: 10%-90%  
Weather Resistance: IP66 certified weatherproof

## Notification of Compliance

### FCC Compliance Statement

This device complies with Part 15 of the FCC Rules. Operation is subject to the following two conditions:

- this device may not cause harmful interference, and
- this device must accept any interference received, including interference that may cause undesired operation.

**NOTE:** This equipment has been tested and found to comply with the limits for a Class B digital device, pursuant to part 15 of the FCC Rules. These limits are designed to provide reasonable protection against harmful interference in a residential installation. This equipment generates uses and can radiate radio frequency energy and, if not installed and used in accordance with the instructions, may cause harmful interference to radio communications. However, there is no guarantee that interference will not occur in a particular installation. If this equipment does cause harmful interference to radio or television reception, which can be determined by turning the equipment off and on, the user is encouraged to try to correct the interference by one or more of the following measures:

- Reorient or relocate the receiving antenna.
- Increase the separation between the equipment and receiver.
- Connect the equipment into an outlet on a circuit different from that to which the receiver is connected.
- Consult the dealer or an experienced radio/TV technician for help.

Changes or modifications not expressly approved by the party responsible for compliance could void the user's authority to operate the equipment.

### FCC RF Exposure Warning Statements

This equipment complies with FCC radiation exposure limits set forth for an uncontrolled environment. This equipment shall be installed and operated with minimum distance 20cm between the radiator & body.

## Simplified EU Declaration of Conformity

Reolink declares that this device is in compliance with the essential requirements and other relevant provisions of Directive 2014/53/EU.



## Correct Disposal of This Product

This marking indicates that this product should not be disposed with other household wastes throughout the EU. To prevent possible harm to the environment or human health from uncontrolled waste disposal, recycle it responsibly to promote the sustainable reuse of material resources. To return your used device, please use the return and collection systems or contact the retailer where the product was purchased. They can take this product for environmentally safe recycling.

## Limited Warranty

This product comes with a 2-year limited warranty that is valid only if purchased from Reolink official stores or Reolink authorized resellers. Learn more: <https://reolink.com/warranty-and-return/>.

**NOTE:** We hope that you enjoy the new purchase. But if you are not satisfied with the product and plan to return, we strongly suggest that you reset the camera to factory default settings and take out the inserted SD card before returning.

## Terms and Privacy

Use of the product is subject to your agreement to the Terms of Service and Privacy Policy at [reolink.com](https://reolink.com). Keep out of the reach of children.

## End User License Agreement

By using the Product Software that is embedded on the Reolink product, you agree to the terms of this End User License Agreement (“EULA”) between you and Reolink. Learn more: <https://reolink.com/eula/>.

## ISED Statements

This device contains licence-exempt transmitter(s)/receiver(s) that comply with Innovation, Science and Economic Development Canada’s licence-exempt RSS(s). Operation is subject to the following two conditions:

- (1) This device may not cause interference.
- (2) This device must accept any interference, including interference that may cause undesired operation of the device.

L’émetteur/récepteur exempt de licence contenu dans le présent appareil est conforme aux CNR d’Innovation, Sciences et Développement économique Canada applicables aux appareils radio exempts de licence. L’exploitation est autorisée aux deux conditions suivantes :

- (1) L’appareil ne doit pas produire de brouillage;
- (2) L’appareil doit accepter tout brouillage radioélectrique subi, même si



le brouillage est susceptible d' en compromettre le fonctionnement.

### **Radio Frequency Exposure Statement for IC**

The device has been evaluated to meet general RF exposure requirements. The device can be used in mobile exposure conditions. The min separation distance is 20cm.

Déclaration d'exposition aux radiofréquences pour IC

L'appareil a été évalué pour répondre aux exigences générales en matière d'exposition aux RF. L'appareil peut être utilisé dans des conditions d'exposition mobiles. La distance de séparation minimale est de 20cm.

Operation of this device is restricted to indoor use only. (5180-5240MHz)  
Le fonctionnement de cet appareil est limité à une utilisation en intérieur uniquement. (5180-5240MHz)

### **Technical Support**

If you need any technical help, please visit our official support site and contact our support team before returning the products,  
<https://support.reolink.com>

This radio transmitter [IC: 26839-2201D] has been approved by Innovation, Science and Economic Development Canada to operate with the antenna types listed below, with the maximum permissible gain indicated. Antenna types not included in this list that have a gain greater than the maximum gain indicated for any type listed are strictly prohibited for use with this device.

Cet émetteur radio [IC: 26839-2201D] a été approuvé par Innovation, Sciences et Développement économique Canada pour fonctionner avec les types d'antenne énumérés ci-dessous, avec le gain maximal admissible indiqué. Les types d'antenne non inclus dans cette liste qui ont un gain supérieur au gain maximum indiqué pour tout type répertorié sont strictement interdits pour une utilisation avec cet appareil.

### Antennas

Antenna Type	Manufacturer	Model/Part No.	Gain (dBi)	Frequency Range (MHz)
omnidirectional antenna	Shenzhen Yingjiachuang Electronic Technology Co., Ltd.	YJC-80302-W27	2.89	2400-2500
omnidirectional antenna	Shenzhen Yingjiachuang Electronic Technology Co., Ltd.	YJC-80302-W27	2.55	5150-5850