

FCC - TEST REPORT

Report Number : **68.950.22.0092.01** Date of Issue: **2022-04-19**

Model : **M200F, M2ABCDEYXX (A=00-99; B=A, S, U; C=C, G, N; D=A, F, E, M; E=0000-9999; Y=A-Z)**

Product Type : **M200 Series Handheld Thermal Camera**

Applicant : **IRay Technology Co., Ltd.**

Address : **11GUIYANG STREET, YANTAI ECONOMY AND TECHNOLOGY DEVELOPMENT DISTRICT, YANTAI SHANDONG P. R. CHINA**

Manufacturer : **IRay Technology Co., Ltd.**

Address : **11GUIYANG STREET, YANTAI ECONOMY AND TECHNOLOGY DEVELOPMENT DISTRICT, YANTAI SHANDONG P. R. CHINA**

Test Result : **Positive** **Negative**

Total pages including Appendices : **57**

Any use for advertising purposes must be granted in writing. This technical report may only be quoted in full. This report is the result of a single examination of the object in question and is not generally applicable evaluation of the quality of other products in regular production. For further details, please see testing and certification regulation, chapter A-3.4.



1 Table of Contents

1	Table of Contents.....	2
2	Details about the Test Laboratory.....	3
3	Description of the Equipment Under Test.....	4
4	Summary of Test Standards	5
5	Summary of Test Results.....	6
6	General Remarks	7
7	Test Setups	8
8	Systems test configuration.....	9
9	Technical Requirement	10
9.1	Conducted peak output power	10
9.2	6dB bandwidth and 99% Occupied Bandwidth	12
9.3	Power spectral density	21
9.4	Spurious RF conducted emissions.....	25
9.5	Band edge testing.....	36
9.6	Spurious radiated emissions for transmitter	40
10	Test Equipment List	56
11	System Measurement Uncertainty	57

2 Details about the Test Laboratory

Details about the Test Laboratory

Test Site 1

Company name: TÜV SÜD Certification and Testing (China) Co., Ltd. Shenzhen Branch
Building 12 & 13, Zhiheng Wisdomland Business Park, Nantou Checkpoint
Road 2, Nanshan District
Shenzhen 518052
P.R. China

Telephone: 86 755 8828 6998

Fax: 86 755 8828 5299

FCC Registration No.: 514049

FCC Designation Number: CA5009

3 Description of the Equipment Under Test

Product:	M200 Series Handheld Thermal Camera
Model no.:	M200F, M2ABCDEYXX (A=00-99; B=A, S, U; C=C, G, N; D=A, F, E, M; E=0000-9999; Y=A-Z)
FCC ID:	2AYGT-M200F
Rating:	3.6VDC by Rechargeable Lithium-ion battery
Options and accessories:	Adapter, Battery Charger, and USB Cable
Adapter information:	Model: JZB110-050200WU Input: 100-240VAC, 50/60Hz; 0.35A Output: 5.0Vdc, 2.0A (10W)
Battery:	Rechargeable Lithium-ion battery: 3.6VDC 4500mAh 16.2Wh
Battery Charger:	Model: LX042200CH Input: 5VDC; 2A
RF Transmission Frequency:	2412MHz-2462MHz
No. of Operated Channel:	11
Modulation:	DSSS, OFDM
Antenna Type:	Integrated antenna
Antenna Gain:	2.5dbi
Description of the EUT:	The Equipment Under Test (EUT) is a M200 Series Handheld Thermal Camera which support Wi-Fi. The TX and RX range is 2412MHz – 2462MHz for 2.4GHz Wi-Fi

4 Summary of Test Standards

Test Standards	
FCC Part 15 Subpart C 10-1-2020 Edition	PART 15 - RADIO FREQUENCY DEVICES Subpart C - Intentional Radiators

All the test methods were according to
KDB 558074 D01 15.247 Meas Guidance v05r02,
ANSI C63.10 (2013).

5 Summary of Test Results

Technical Requirements						
FCC Part 15 Subpart C						
Test Condition	Pages	Test Site	Test Result			
			Pass	Fail	N/A	
§15.207	Conducted emission AC power port	---	---	<input type="checkbox"/>	<input type="checkbox"/>	<input checked="" type="checkbox"/>
§15.247 (b) (1)	Conducted peak output power	13	Site 1	<input checked="" type="checkbox"/>	<input type="checkbox"/>	<input type="checkbox"/>
§15.247(a)(1)	20dB bandwidth	---	---	<input type="checkbox"/>	<input type="checkbox"/>	<input checked="" type="checkbox"/>
§15.247(a)(1)	Carrier frequency separation	---	---	<input type="checkbox"/>	<input type="checkbox"/>	<input checked="" type="checkbox"/>
§15.247(a)(1)(iii)	Number of hopping frequencies	---	---	<input type="checkbox"/>	<input type="checkbox"/>	<input checked="" type="checkbox"/>
§15.247(a)(1)(iii)	Dwell Time	---	---	<input type="checkbox"/>	<input type="checkbox"/>	<input checked="" type="checkbox"/>
§15.247(a)(2)	6dB bandwidth and 99% Occupied Bandwidth	15	Site 1	<input checked="" type="checkbox"/>	<input type="checkbox"/>	<input type="checkbox"/>
§15.247(e)	Power spectral density	24	Site 1	<input checked="" type="checkbox"/>	<input type="checkbox"/>	<input type="checkbox"/>
§15.247(d)	Spurious RF conducted emissions	28	Site 1	<input checked="" type="checkbox"/>	<input type="checkbox"/>	<input type="checkbox"/>
§15.247(d)	Band edge	39	Site 1	<input checked="" type="checkbox"/>	<input type="checkbox"/>	<input type="checkbox"/>
§15.247(d)	Spurious radiated emissions for transmitter	43	Site 1	<input checked="" type="checkbox"/>	<input type="checkbox"/>	<input type="checkbox"/>
§15.203	Antenna requirement	See note 2		<input checked="" type="checkbox"/>	<input type="checkbox"/>	<input type="checkbox"/>

Note 1: N/A=Not Applicable.

Note 2: The EUT uses an internal antenna, which gain is 2.5dBi. In accordance to §15.203, It is considered sufficiently to comply with the provisions of this section.

Note 2: The EUT power by battery.

6 General Remarks

Remarks

This submittal(s) (test report) is intended for FCC ID: 2AYGT-M200F, complies with Section 15.207, 15.209, 15.247 of the FCC Part 15, Subpart C rules.

The EuT RF module as same as FCC ID: 2A3PM-APX200 and the antenna position different, and the RF Conducted test data refer to report no: 68.950.21.0859.01, the other data need to update.

The M2ABCDEYXX (A=00-99; B=A, S, U; C=C, G, N; D=A, F, E, M; E=0000-9999; Y=A-Z) have the same technical construction including circuit diagram, PCB Layout, components and component layout, all electrical construction and mechanical construction, with M200 Series Handheld Thermal Camera, M200F. The difference lies only in the model 's name of the different models.

The EMC test with model M200F, the other test items are deemed to fulfil relevant EMC requirement without further test.

SUMMARY:

All tests according to the regulations cited on page 5 were

- Performed

- **Not** Performed

The Equipment Under Test

- **Fulfills** the general approval requirements.

- **Does not** fulfill the general approval requirements.

Sample Received Date: 2022-01-05

Testing Start Date: 2022-01-05

Testing End Date: 2022-04-12

TÜV SÜD Certification and Testing (China) Co., Ltd. Shenzhen Branch

Reviewed by:

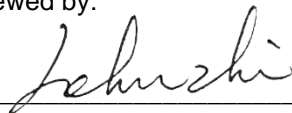

John Zhi
Project Manager

Prepared by:

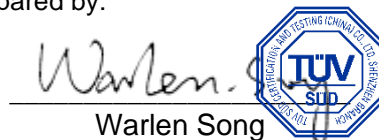

Warlen Song
Project Engineer

Tested by:

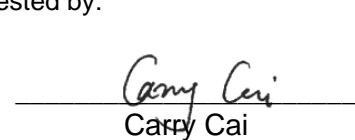

Carry Cai
Test Engineer

7 Test Setups

7.1 AC Power Line Conducted Emission test setups

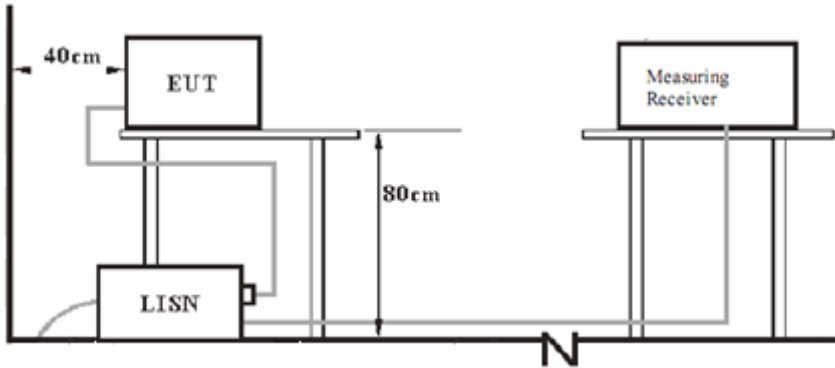

7.2 Radiated test setups Below 1GHz

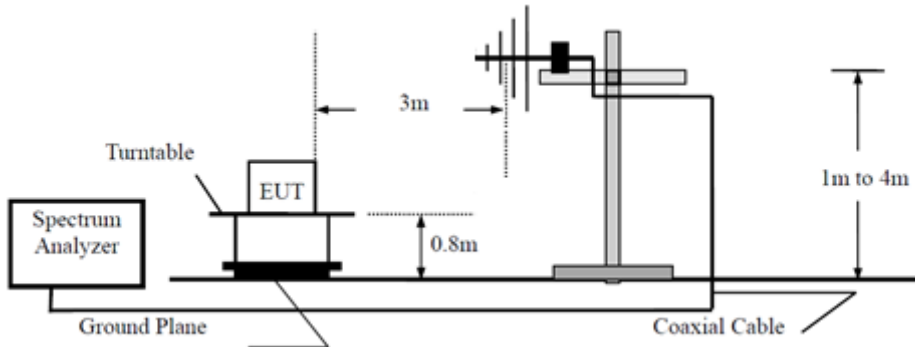

Above 1GHz

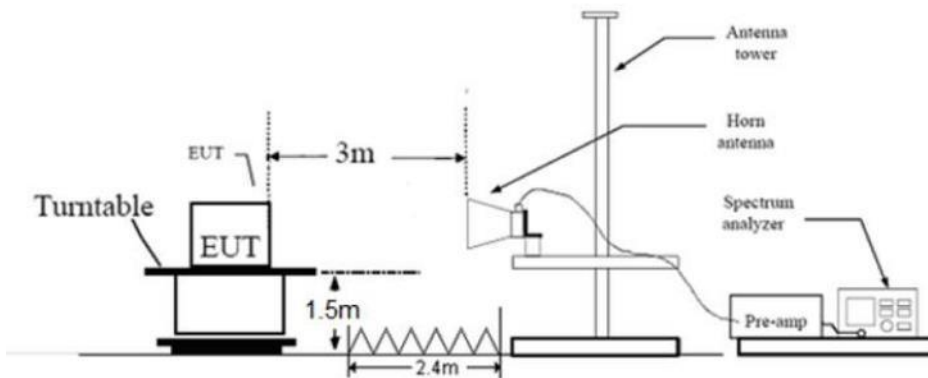

7.3 Conducted RF test setups

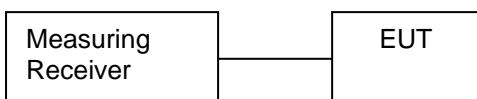

8 Systems test configuration

Auxiliary Equipment Used during Test:

DESCRIPTION	MANUFACTURER	MODEL NO.(SHIELD)	S/N(LENGTH)
PC	Lenovo	X240	---

The system was configured to non-hopping mode.

Non-hopping mode: The system was configured to operate at a signal channel transmitting. The test software allows the configuration and operation at the worst-case duty and the highest transmit power.

9 Technical Requirement

9.1 Conducted peak output power

Test Method

1. The EUT was placed on 0.8m height table, the RF output of EUT was connected to the power meter by RF cable. The path loss was compensated to the results for each measurement.
2. Setting the highest output power level of the EUT
3. Record the power value.

Limits

According to §15.247 (b) (3), conducted peak output power limit as below:

Frequency Range MHz	Limit W	Limit dBm
2400-2483.5	≤1	≤30

Test result as below table

802.11b_ modulation Test Result

Frequency (MHz)	Conducted Peak Output Power (dBm)	Result
	Ant 0	
Low channel 2412MHz	7.8	Pass
Middle channel 2437MHz	8.7	Pass
High channel 2462MHz	8.8	Pass

802.11g_ modulation Test Result

Frequency (MHz)	Conducted Peak Output Power (dBm)	Result
	Ant 0	
Low channel 2412MHz	13,3	Pass
Middle channel 2437MHz	14.2	Pass
High channel 2462MHz	14.3	Pass

802.11n20_modulation Test Result

Frequency (MHz)	Conducted Peak Output Power (dBm)	Result
	Ant0	
Low channel 2412MHz	12.9	Pass
Middle channel 2437MHz	13.6	Pass
High channel 2462MHz	13.7	Pass

9.2 6dB bandwidth and 99% Occupied Bandwidth

Test Method for 6 dB Bandwidth

1. Use the following spectrum analyzer settings:
RBW=100K, VBW \geq 3RBW, Sweep = auto, Detector function = peak, Trace = max hold
2. Use the automatic bandwidth measurement capability of an instrument, may be employed using the X dB bandwidth mode with X set to 6 dB, care shall be taken so that the bandwidth measurement is not influenced by any intermediate power nulls in the fundamental emission that might be \geq 6 dB.
3. Allow the trace to stabilize, record the X dB Bandwidth value.

Test Method for 99 % Bandwidth

1. Use the following spectrum analyzer settings:
RBW=1% to 5% of the actual occupied, VBW \geq 3RBW, Sweep = auto, Detector function = peak, Trace = max hold
2. Use the automatic bandwidth measurement capability of an instrument, care shall be taken so that the bandwidth measurement is not influenced by any intermediate power nulls in the fundamental emission that might be \geq 6 dB.
3. Allow the trace to stabilize, record the X dB Bandwidth value.

Limit

Limit [kHz]

\geq 500

6dB Bandwidth

TestMode	Antenna	Channel [MHz]	DTS BW [MHz]	FL[MHz]	FH[MHz]	Limit [MHz]	Verdict
11B	Ant0	2412	8.600	2408.440	2417.040	0.5	PASS
	Ant0	2437	8.640	2431.920	2440.560	0.5	PASS
	Ant0	2462	9.120	2457.440	2466.560	0.5	PASS
11G	Ant0	2412	16.400	2403.800	2420.200	0.5	PASS
	Ant0	2437	16.400	2428.800	2445.200	0.5	PASS
	Ant0	2462	16.400	2453.800	2470.200	0.5	PASS
11N20	Ant0	2412	17.640	2403.200	2420.840	0.5	PASS
	Ant0	2437	17.600	2428.200	2445.800	0.5	PASS
	Ant0	2462	17.640	2453.160	2470.800	0.5	PASS

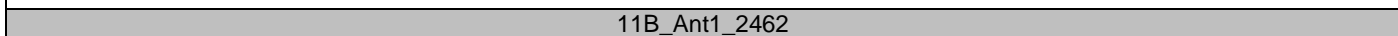
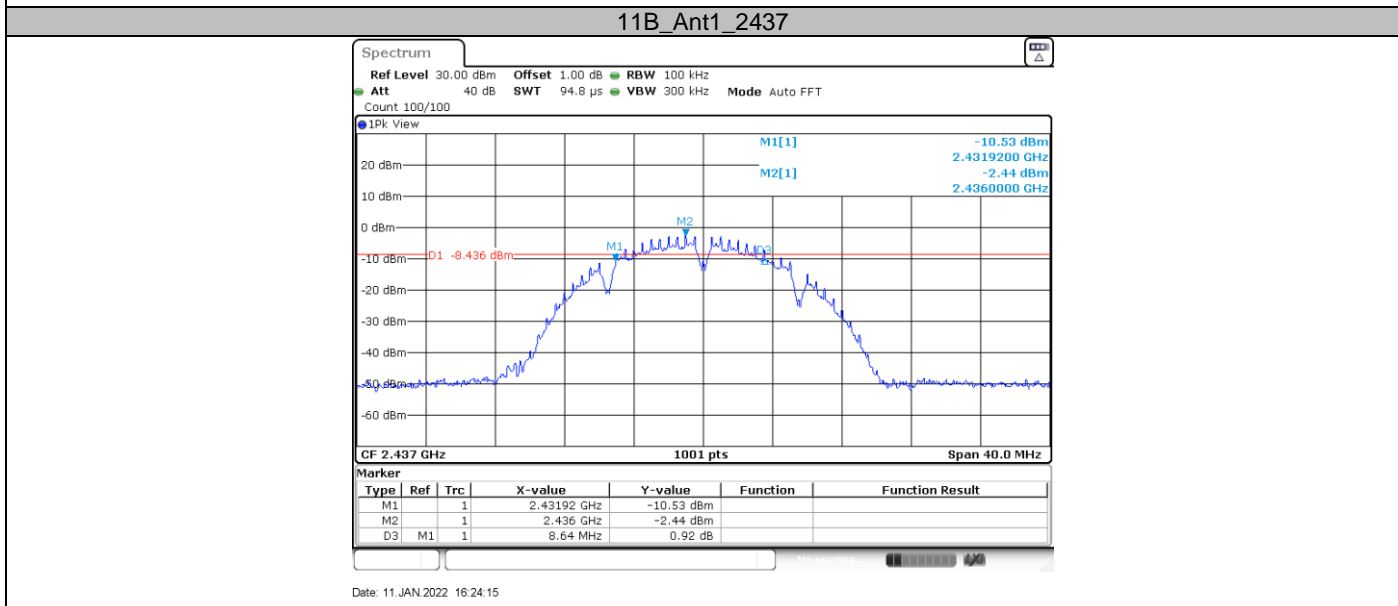
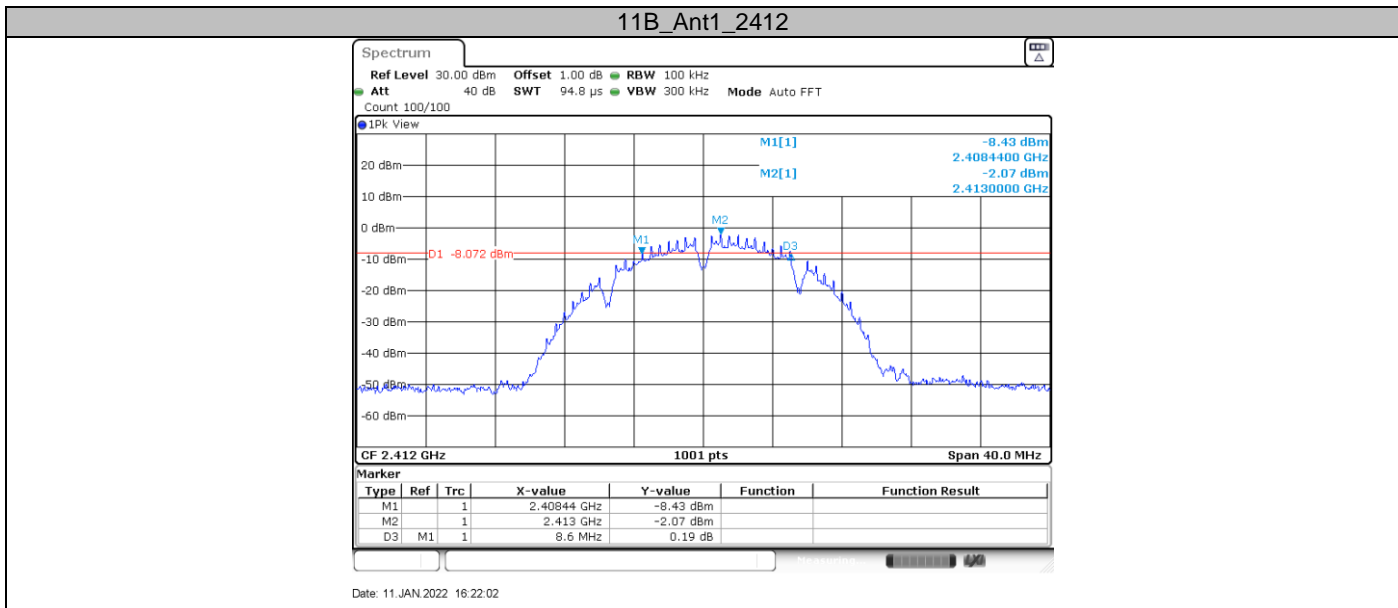

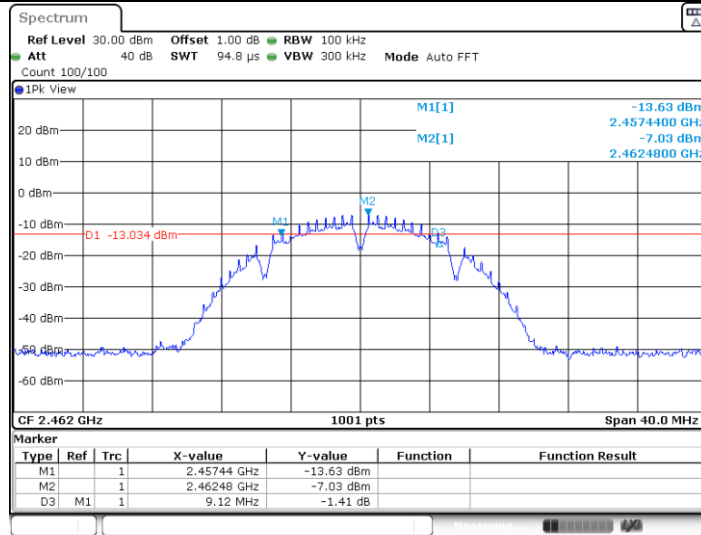

Date: 11.JAN.2022 16:26:02

11G_Ant1_2412

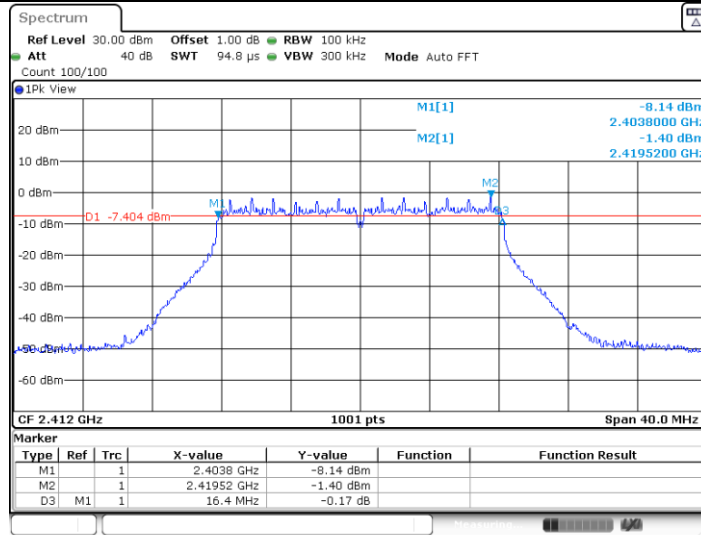

Date: 21.DEC.2021 11:08:13

11G_Ant1_2437

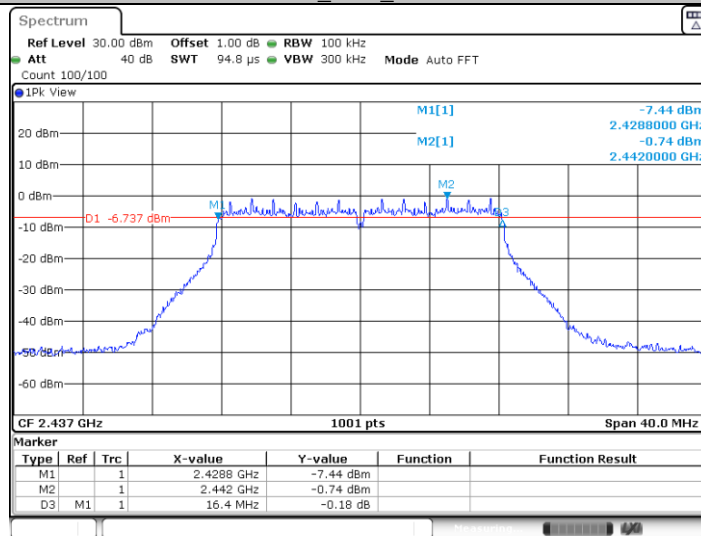

Date: 21.DEC.2021 11:10:17

11G_Ant1_2462

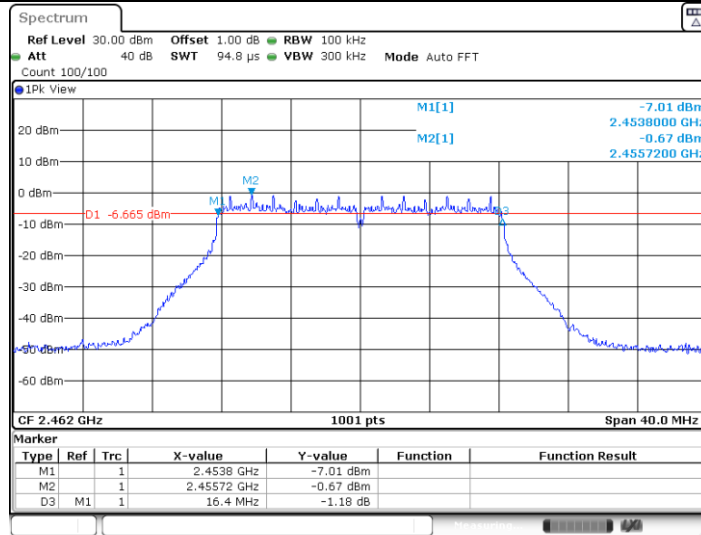

Date: 21.DEC.2021 11:12:22

11N20SISO_Ant1_2412

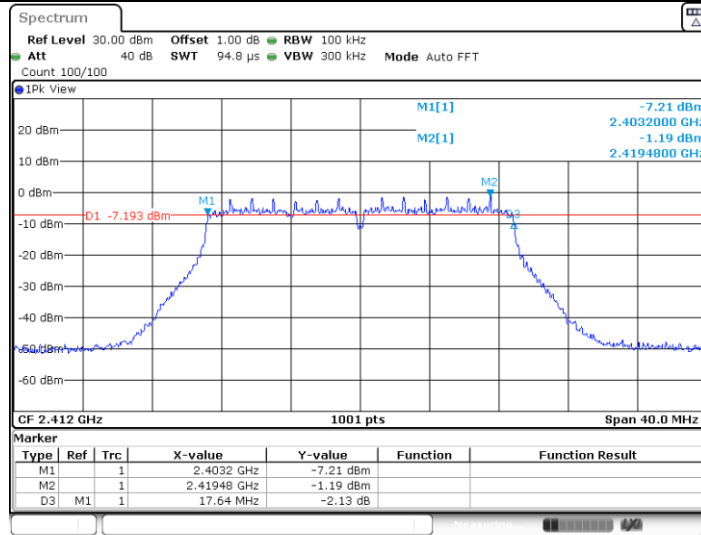

Date: 21.DEC.2021 11:23:28

11N20SISO_Ant1_2437

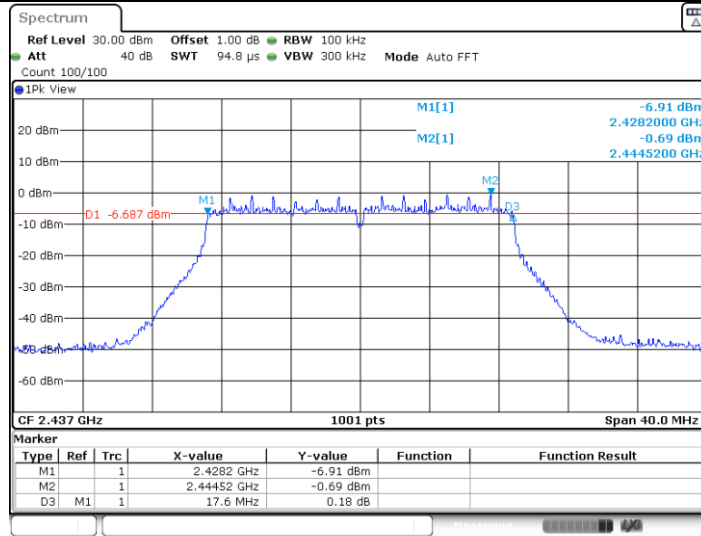

Date: 21.DEC.2021 11:25:57

11N20SISO_Ant1_2462

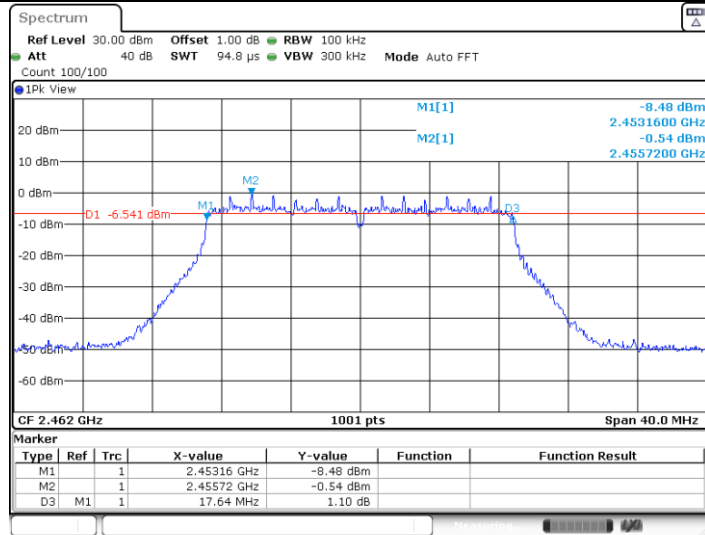

Date: 21.DEC.2021 11:28:00

99% Bandwidth

TestMode	Antenna	Channel [MHz]	OCB [MHz]	FL[MHz]	FH[MHz]	Limit[MHz]	Verdict
11B	Ant0	2412	13.666	2405.726	2419.393	---	PASS
		2437	13.786	2429.647	2443.434	---	PASS
		2462	13.946	2455.007	2468.953	---	PASS
11G	Ant0	2412	17.343	2403.289	2420.631	---	PASS
		2437	17.343	2428.289	2445.631	---	PASS
		2462	17.303	2453.249	2470.551	---	PASS
11N20SISO	Ant0	2412	18.342	2402.929	2421.271	---	PASS
		2437	18.302	2427.929	2446.231	---	PASS
		2462	18.302	2452.889	2471.191	---	PASS

11B_Ant1_2412

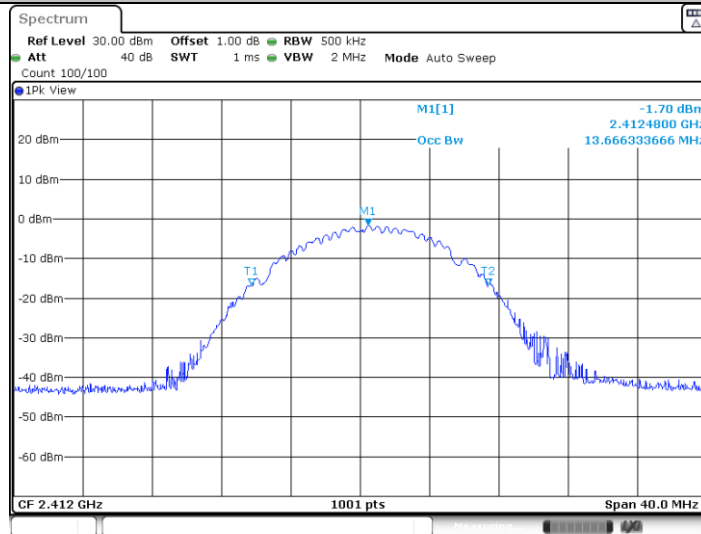

Date: 11 JAN 2022 16:22:48

11B_Ant1_2437

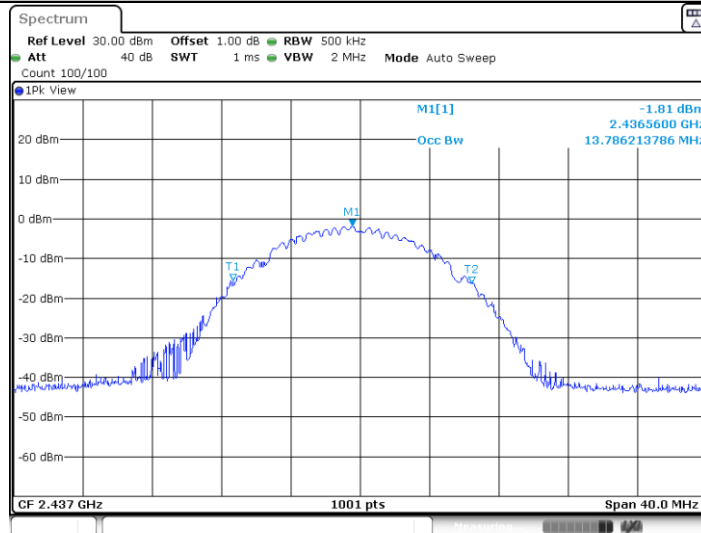

Date: 11 JAN 2022 16:24:26

11B_Ant1_2462

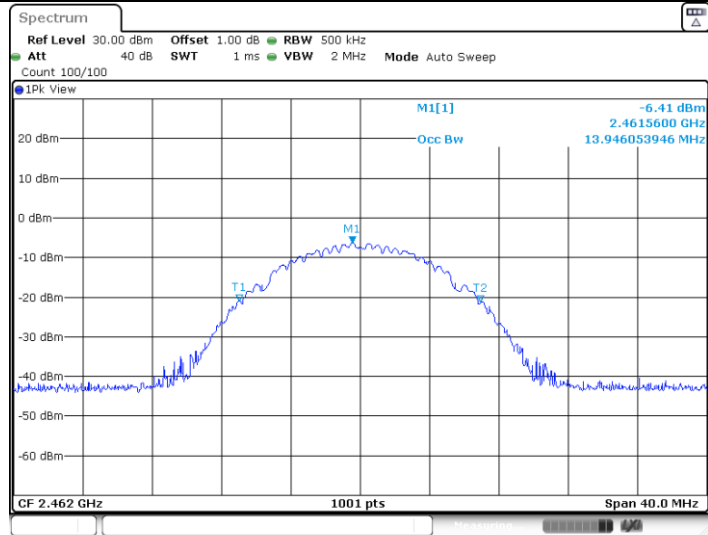

Date: 11.JAN.2022 16:26:13

11G_Ant1_2412

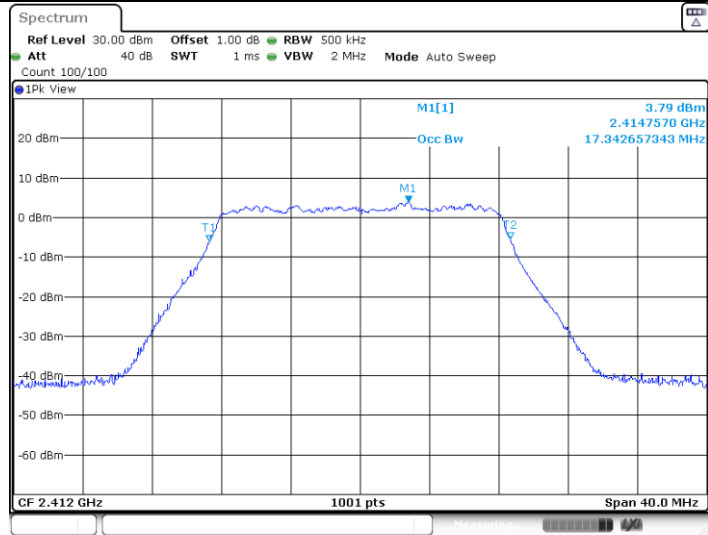

Date: 21.DEC.2021 11:08:24

11G_Ant1_2437

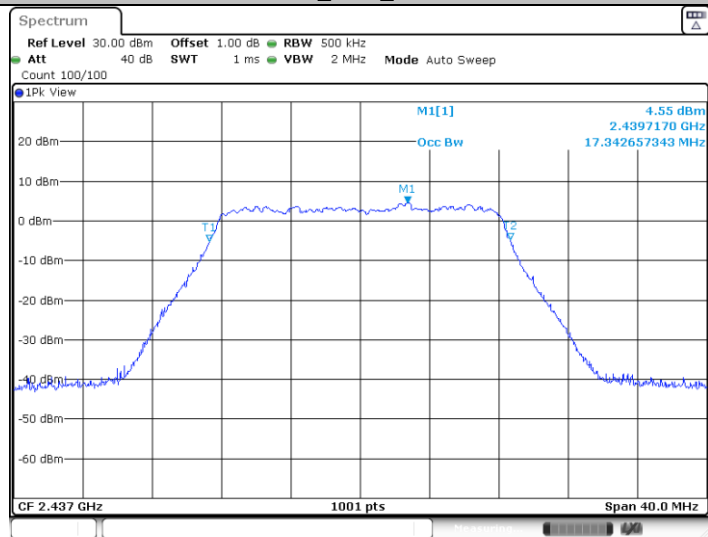

Date: 21.DEC.2021 11:10:27

11G_Ant1_2462

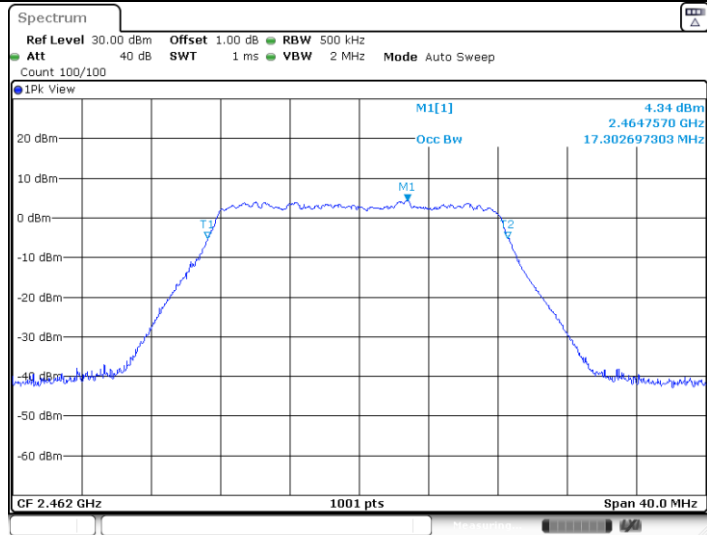

Date: 21.DEC.2021 11:12:33

11N20SISO_Ant1_2412

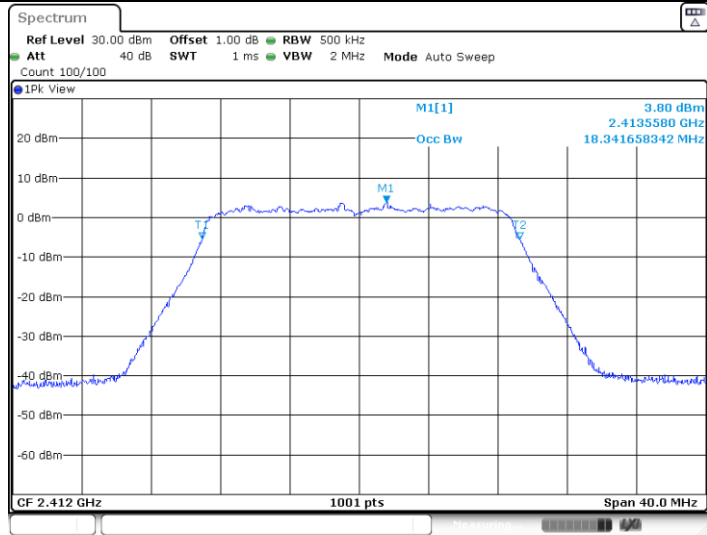

Date: 21.DEC.2021 11:23:39

11N20SISO_Ant1_2437

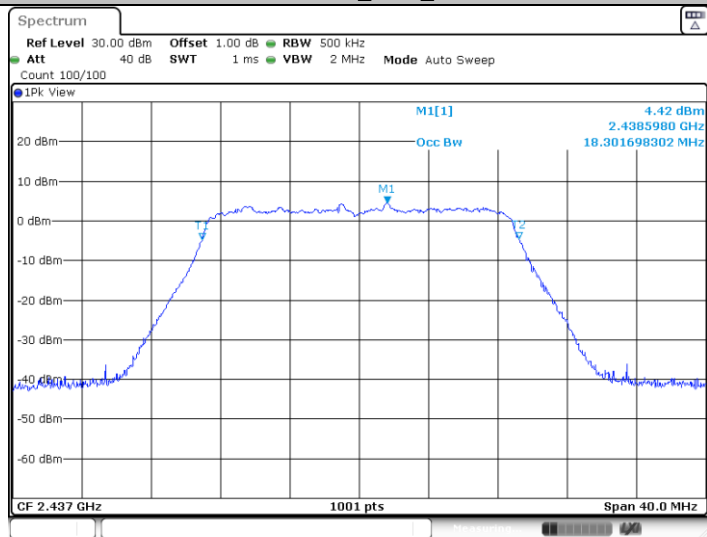

Date: 21.DEC.2021 11:26:08

11N20SISO_Ant1_2462

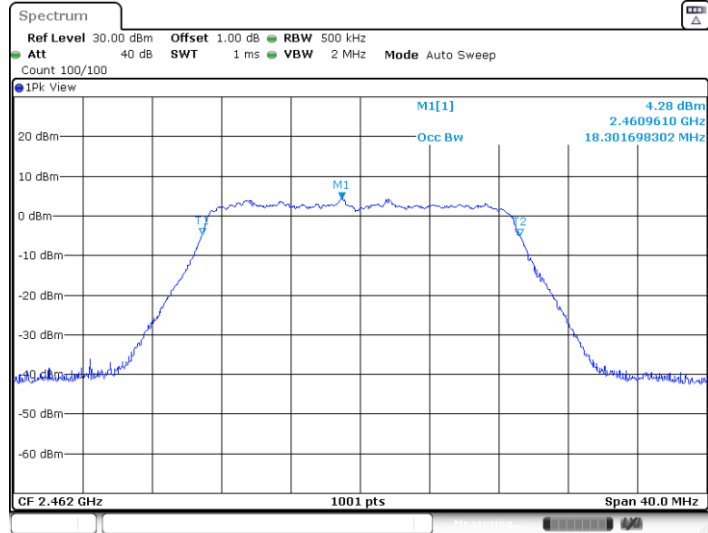

9.3 Power spectral density

Test Method

This procedure shall be used if maximum peak conducted output power was used to demonstrate compliance:

1. The RF output of EUT was connected to the test receiver by RF cable. The path loss was compensated to the results for each measurement.
2. Set analyzer center frequency to DTS channel center frequency. RBW=3kHz, VBW≥3RBW, Span=1.5 times DTS bandwidth, Detector=Peak, Sweep=auto, Trace= max hold.
3. Allow trace to fully stabilize, use the peak marker function to determine the maximum amplitude level within the RBW.
4. Repeat above procedures until other frequencies measured were completed.

Limit

Limit [dBm/3KHz]

≤8

802.11b modulation Test Result

Frequency (MHz)	Power spectral density (dBm/3KHz)	Limit (dBm/3KHz)	Result
	Ant 0		
Low channel 2412MHz	-15.83	8	Pass
Middle channel 2437MHz	-15.97	8	Pass
High channel 2462MHz	-18.95	8	Pass

802.11g modulation Test Result

Frequency (MHz)	Power spectral density (dBm/3KHz)	Limit (dBm/3KHz)	Result
	Ant 0		
Low channel 2412MHz	-14.95	8	Pass
Middle channel 2437MHz	-14.03	8	Pass
High channel 2462MHz	-14.1	8	Pass

802.11n_HT20 modulation Test Result

Frequency (MHz)	Power spectral density (dBm/3KHz)	Limit (dBm/3KHz)	Result
	Ant 0		
Low channel 2412MHz	-15.88	8	Pass
Middle channel 2437MHz	-15.06	8	Pass
High channel 2462MHz	-14.8	8	Pass

11B_Ant1_2412

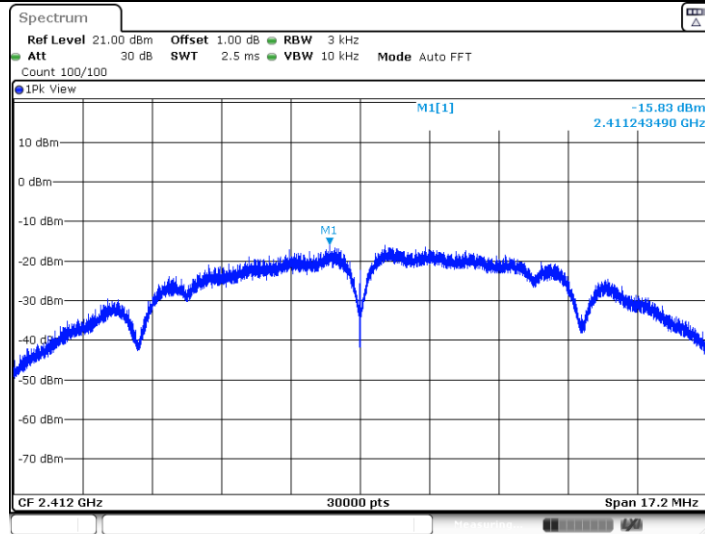

Date: 11.JAN.2022 16:23:00

11B_Ant1_2437

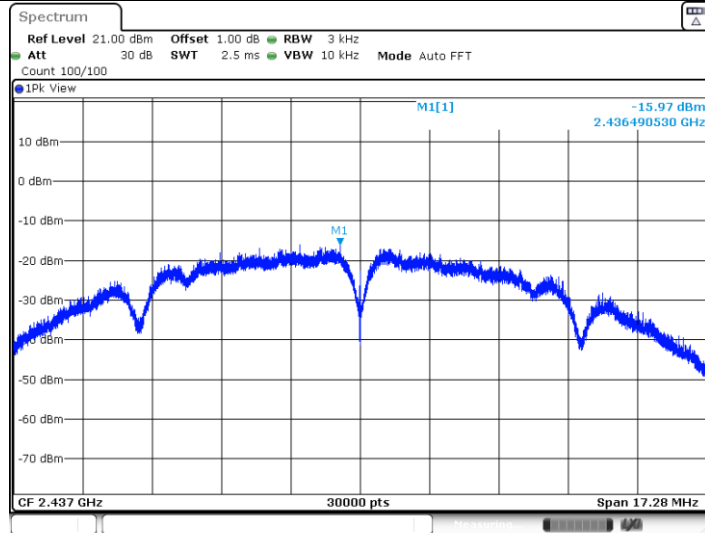

Date: 11.JAN.2022 16:24:31

11B_Ant1_2462

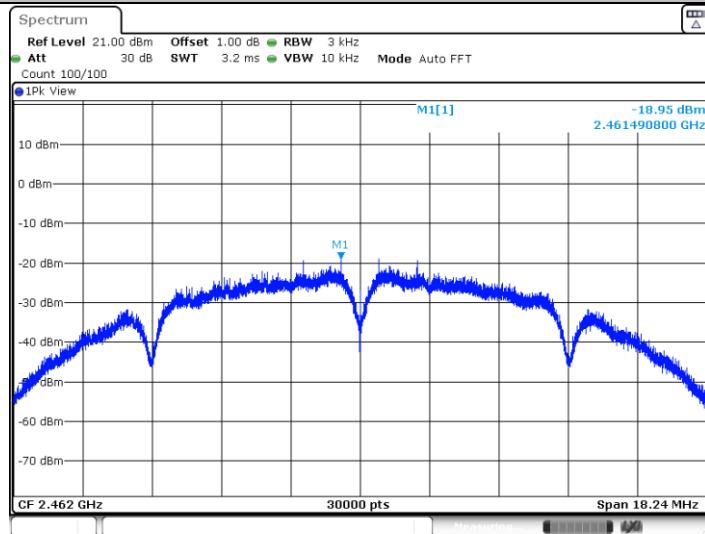

Date: 11.JAN.2022 16:26:19

11G_Ant1_2412

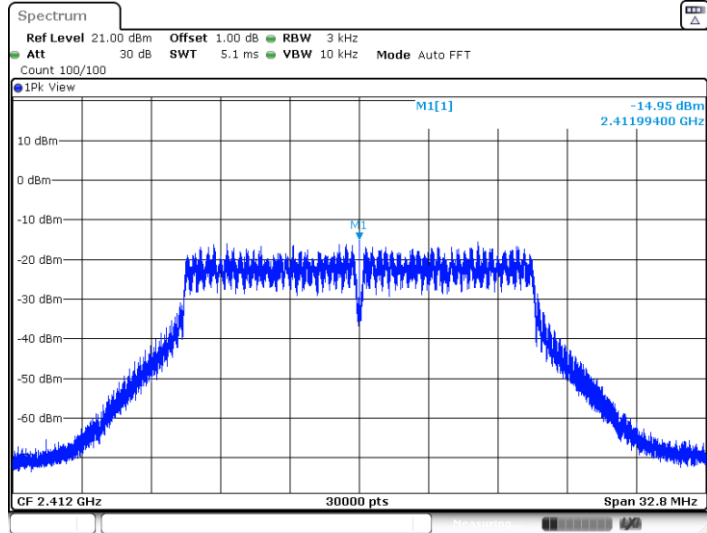

Date: 21.DEC.2021 11:08:30

11G_Ant1_2437

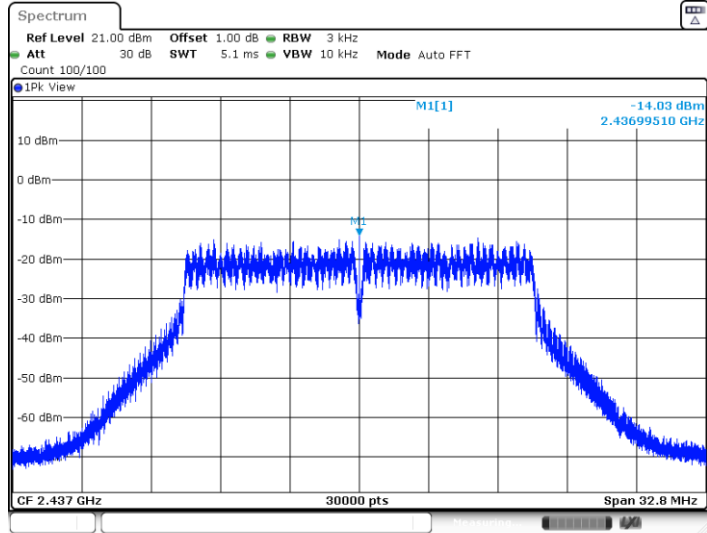

Date: 21.DEC.2021 11:10:33

11G_Ant1_2462

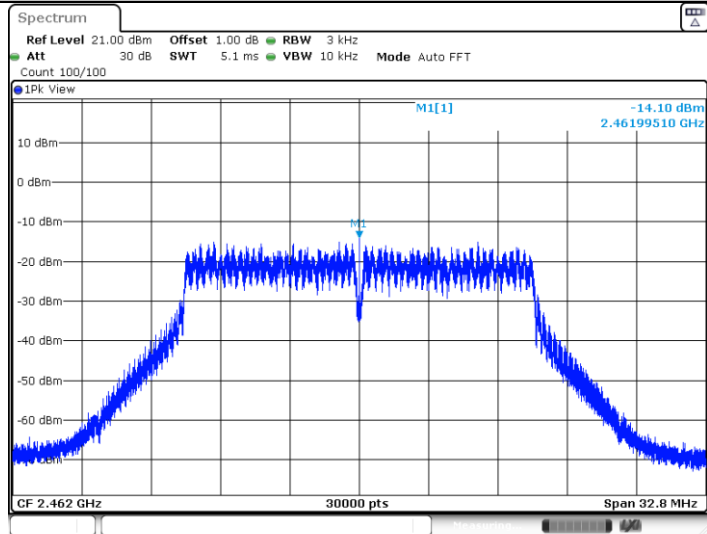

Date: 21.DEC.2021 11:12:39

11N20SISO_Ant1_2412

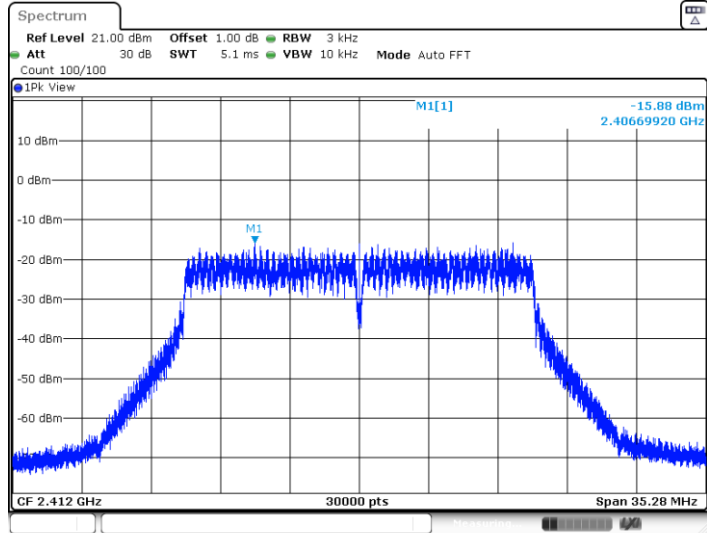

Date: 21.DEC.2021 11:23:45

11N20SISO_Ant1_2437

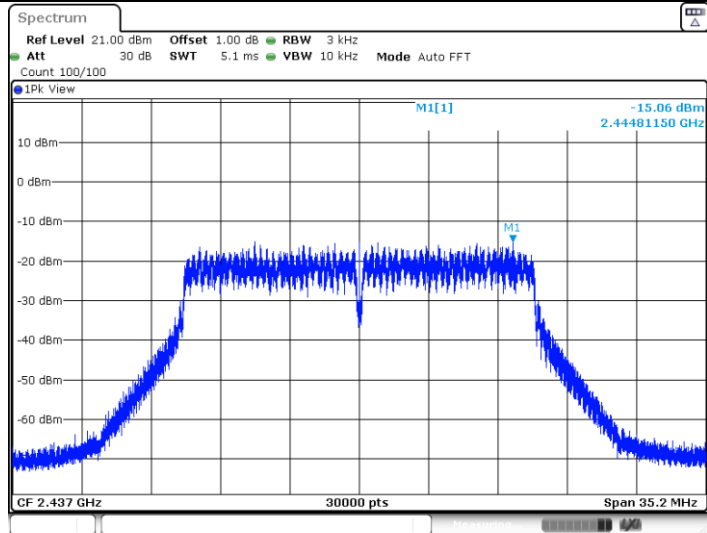

Date: 21.DEC.2021 11:26:14

11N20SISO_Ant1_2462

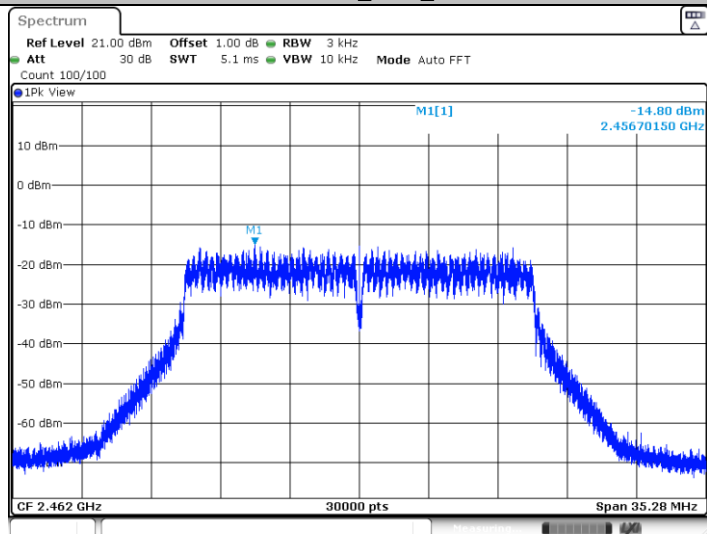

Date: 21.DEC.2021 11:28:17

9.4 Spurious RF conducted emissions

Test Method

1. The RF output of EUT was connected to the spectrum analyzer by RF cable. The path loss was compensated to the results for each measurement.
2. Use the following spectrum analyzer settings:
Span = wide enough to capture the peak level of the in-band emission and all spurious emissions (e.g., harmonics) from the lowest frequency generated in the EUT up through the 10th harmonic. Typically, several plots are required to cover this entire span.
RBW = 100 kHz, VBW \geq RBW, Sweep = auto, Detector function = peak, Trace = max hold
3. Allow the trace to stabilize. Set the marker on the peak of any spurious emission recorded.
4. The level displayed must comply with the limit specified in this Section. Submit these plots.
5. Repeat above procedures until all frequencies measured were complete.

Limit

Frequency Range MHz	Limit (dBm)
30-25000	-20

Spurious RF conducted emissions

TestMode	Antenna	Channel(dBm)	FreqRange(MHz)	RefLevel	Result(dBm)	Limit(dBm)	Verdict
11B	Ant0	2412	Reference	6.93 dBm	6.93	---	PASS
			30~1000	30~1000 MHz	-68.16	<=-13.07	PASS
			1000~26500	1000~26500 MHz	-25.51	<=-13.07	PASS
	Ant0	2437	Reference	7.26 dBm	7.26	---	PASS
			30~1000	30~1000 MHz	-68.11	<=-12.74	PASS
			1000~26500	1000~26500 MHz	-25.48	<=-12.74	PASS
	Ant0	2462	Reference	7.58 dBm	7.58	---	PASS
			30~1000	30~1000 MHz	-68.26	<=-12.42	PASS
			1000~26500	1000~26500 MHz	-26.15	<=-12.42	PASS
11G	Ant0	2412	Reference	-2.12 dBm	-2.12	---	PASS
			30~1000	30~1000 MHz	-67.19	<=-22.12	PASS
			1000~26500	1000~26500 MHz	-43.07	<=-22.12	PASS
	Ant0	2437	Reference	-1.32 dBm	-1.32	---	PASS
			30~1000	30~1000 MHz	-68.23	<=-21.32	PASS
			1000~26500	1000~26500 MHz	-44.83	<=-21.32	PASS
	Ant0	2462	Reference	-1.13 dBm	-1.13	---	PASS
			30~1000	30~1000 MHz	-68.02	<=-21.13	PASS
			1000~26500	1000~26500 MHz	-44.15	<=-21.13	PASS
11N20SISO	Ant0	2412	Reference	-1.83 dBm	-1.83	---	PASS
			30~1000	30~1000 MHz	-67.52	<=-21.83	PASS
			1000~26500	1000~26500 MHz	-38.87	<=-21.83	PASS
	Ant0	2437	Reference	-0.94 dBm	-0.94	---	PASS
			30~1000	30~1000 MHz	-67.6	<=-20.94	PASS
			1000~26500	6.93 dBm	6.93	---	PASS
	Ant0	2462	Reference	30~1000 MHz	-68.16	<=-13.07	PASS
			30~1000	1000~26500 MHz	-25.51	<=-13.07	PASS
			1000~26500	7.26 dBm	7.26	---	PASS

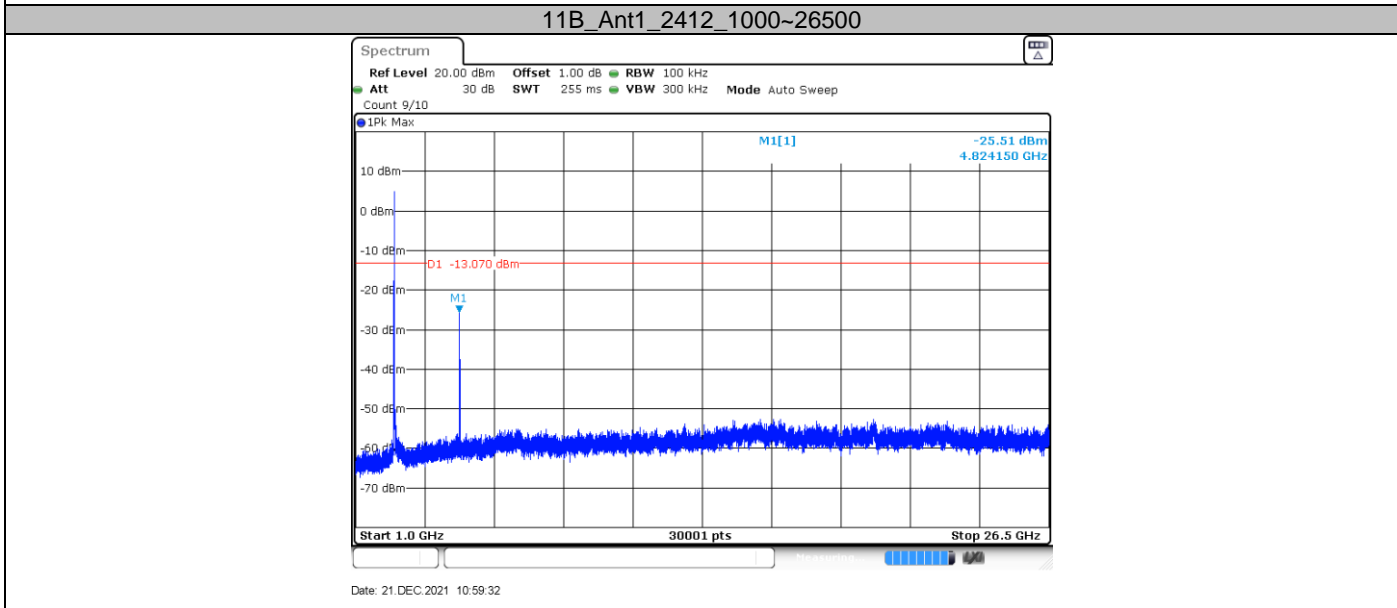
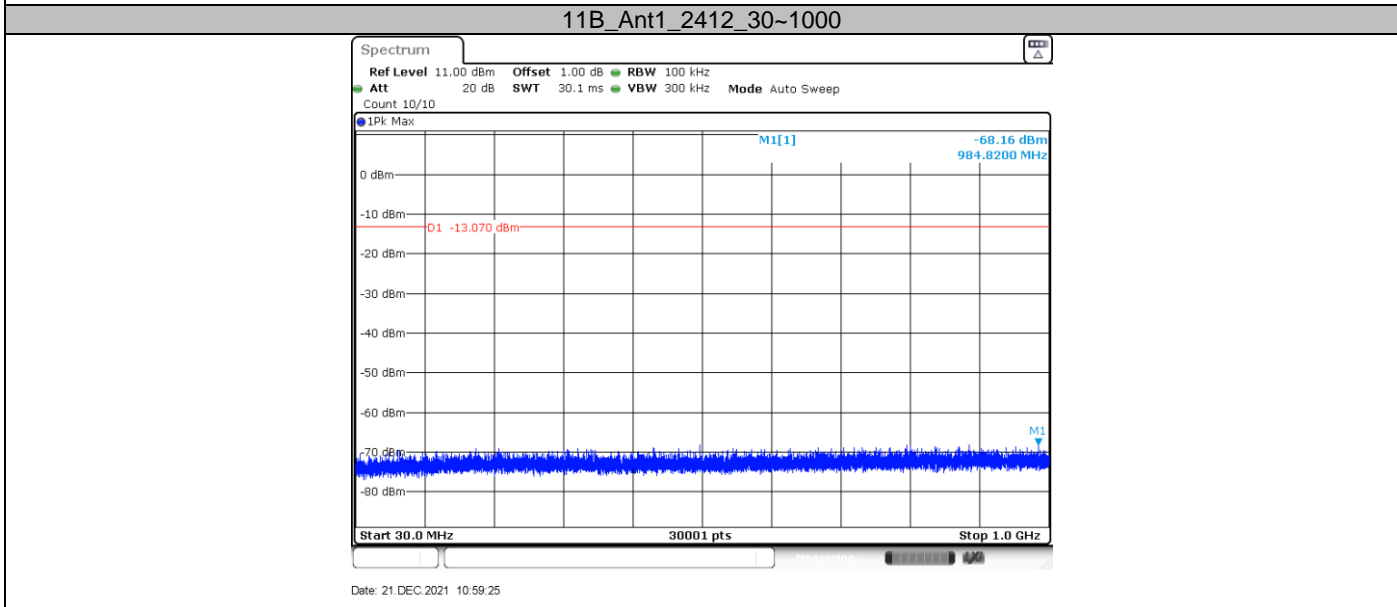
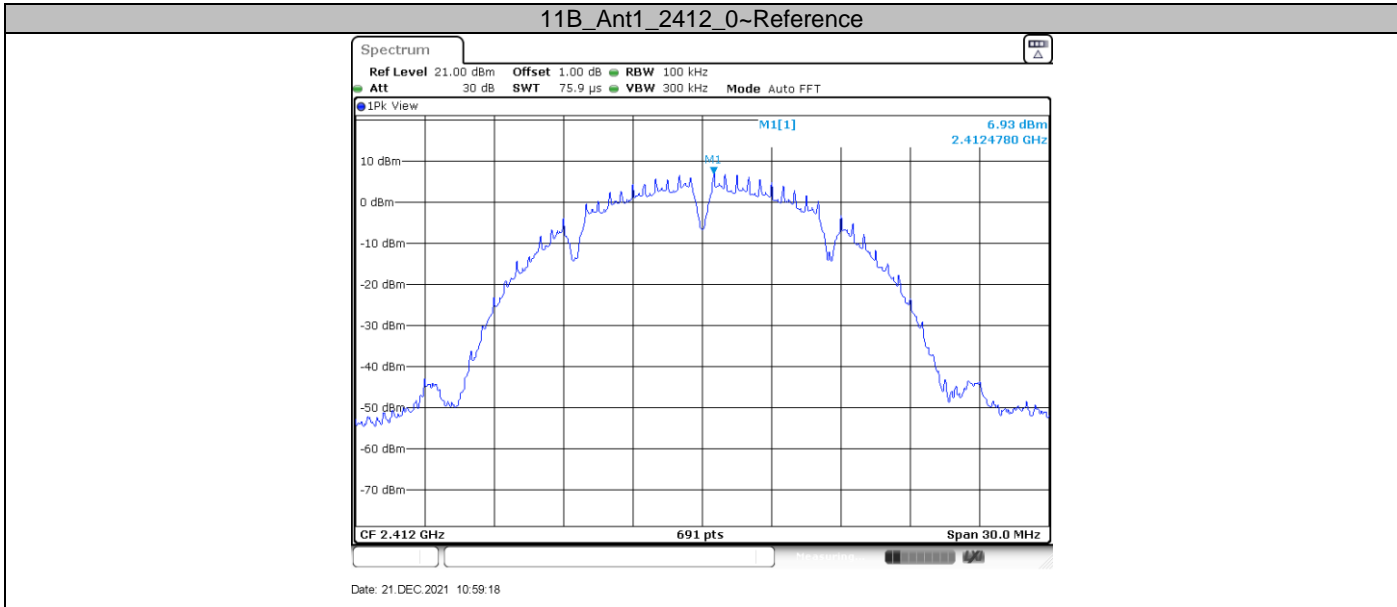

11B_Ant1_2437_0~Reference

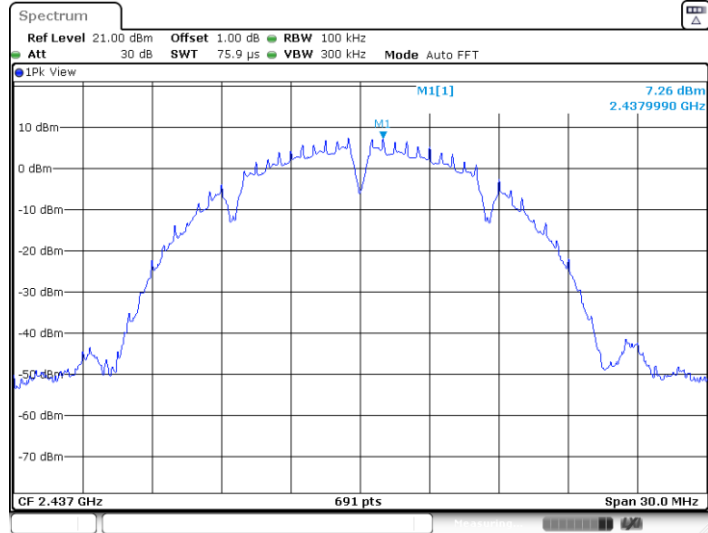

Date: 21.DEC.2021 11:01:06

11B_Ant1_2437_30~1000

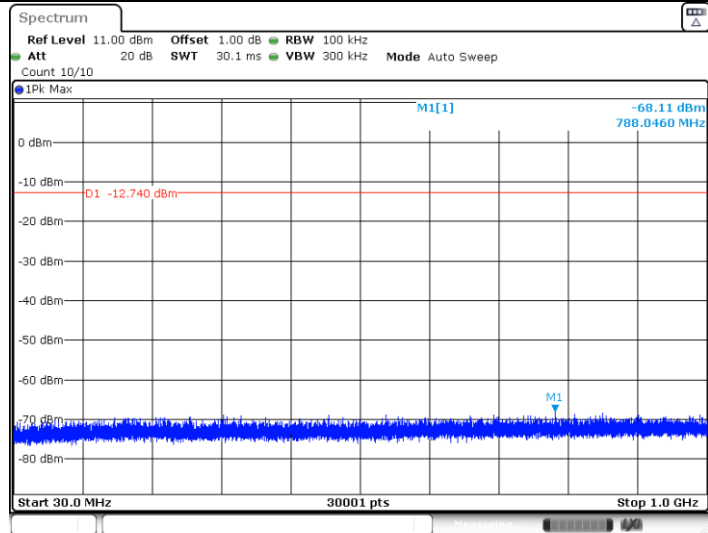

Date: 21.DEC.2021 11:01:12

11B_Ant1_2437_1000~26500

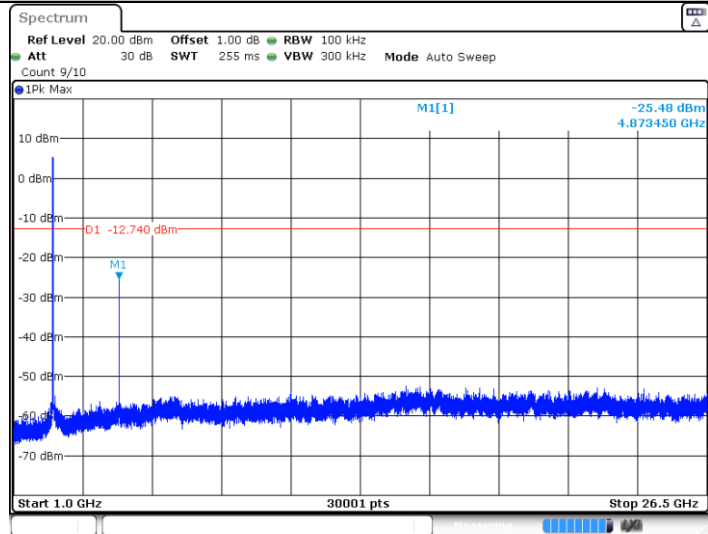

Date: 21.DEC.2021 11:01:20

11B_Ant1_2462_0~Reference

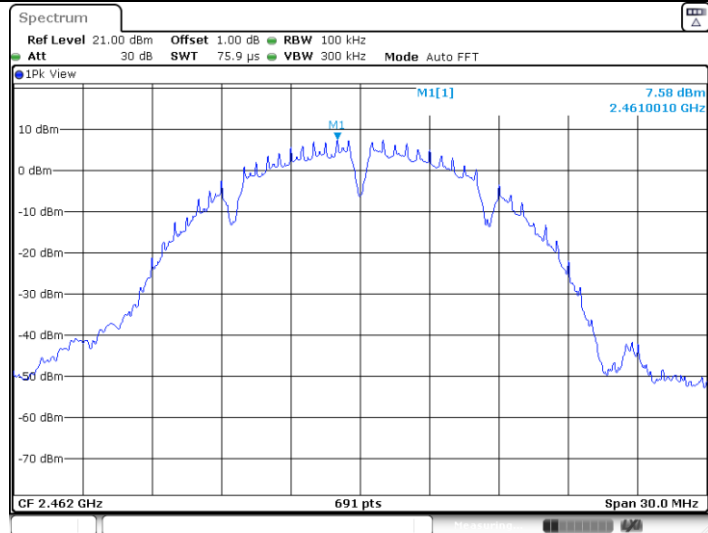

Date: 21.DEC.2021 11:03:53

11B_Ant1_2462_30~1000

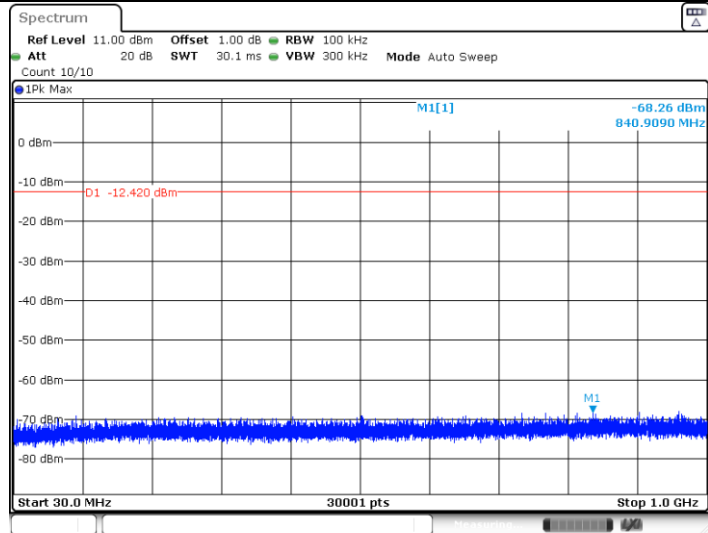

Date: 21.DEC.2021 11:03:59

11B_Ant1_2462_1000~26500

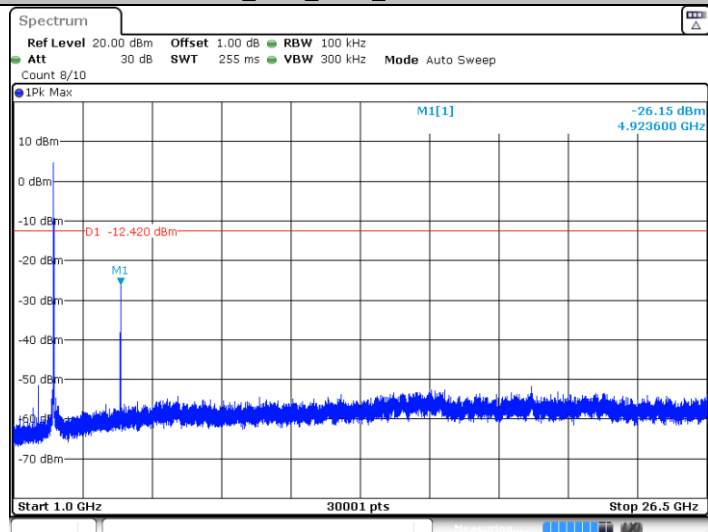

Date: 21.DEC.2021 11:04:07

11G_Ant1_2412_0~Reference

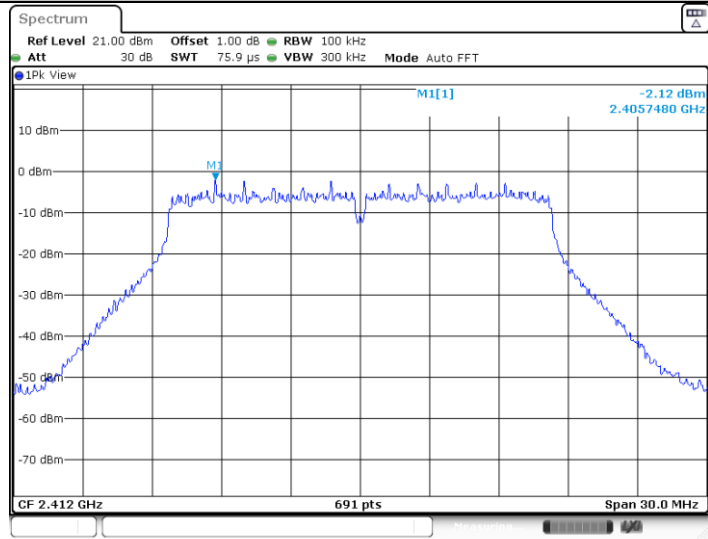

Date: 21.DEC.2021 11:08:44

11G_Ant1_2412_30~1000

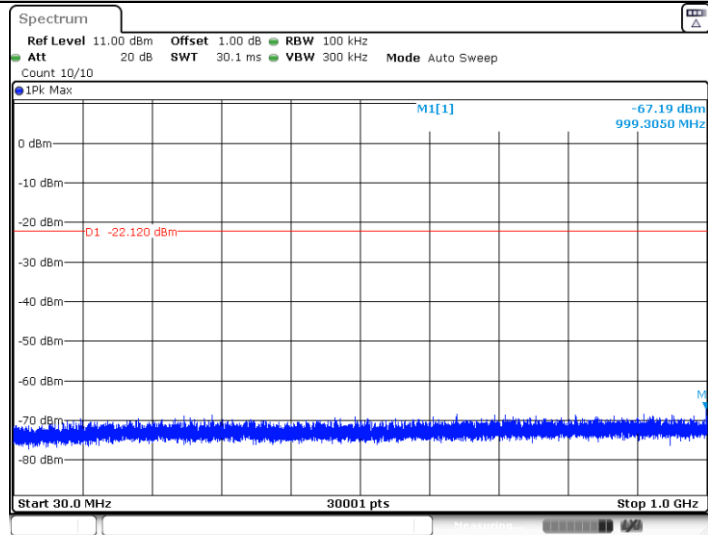

Date: 21.DEC.2021 11:08:51

11G_Ant1_2412_1000~26500

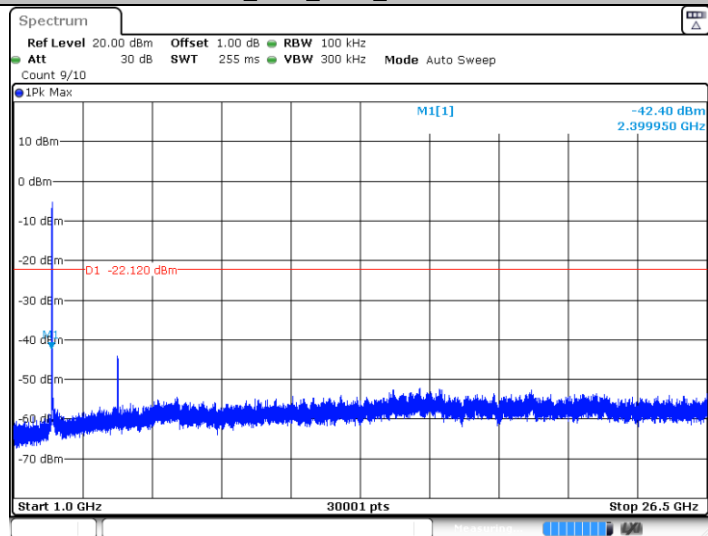

Date: 21.DEC.2021 11:08:58

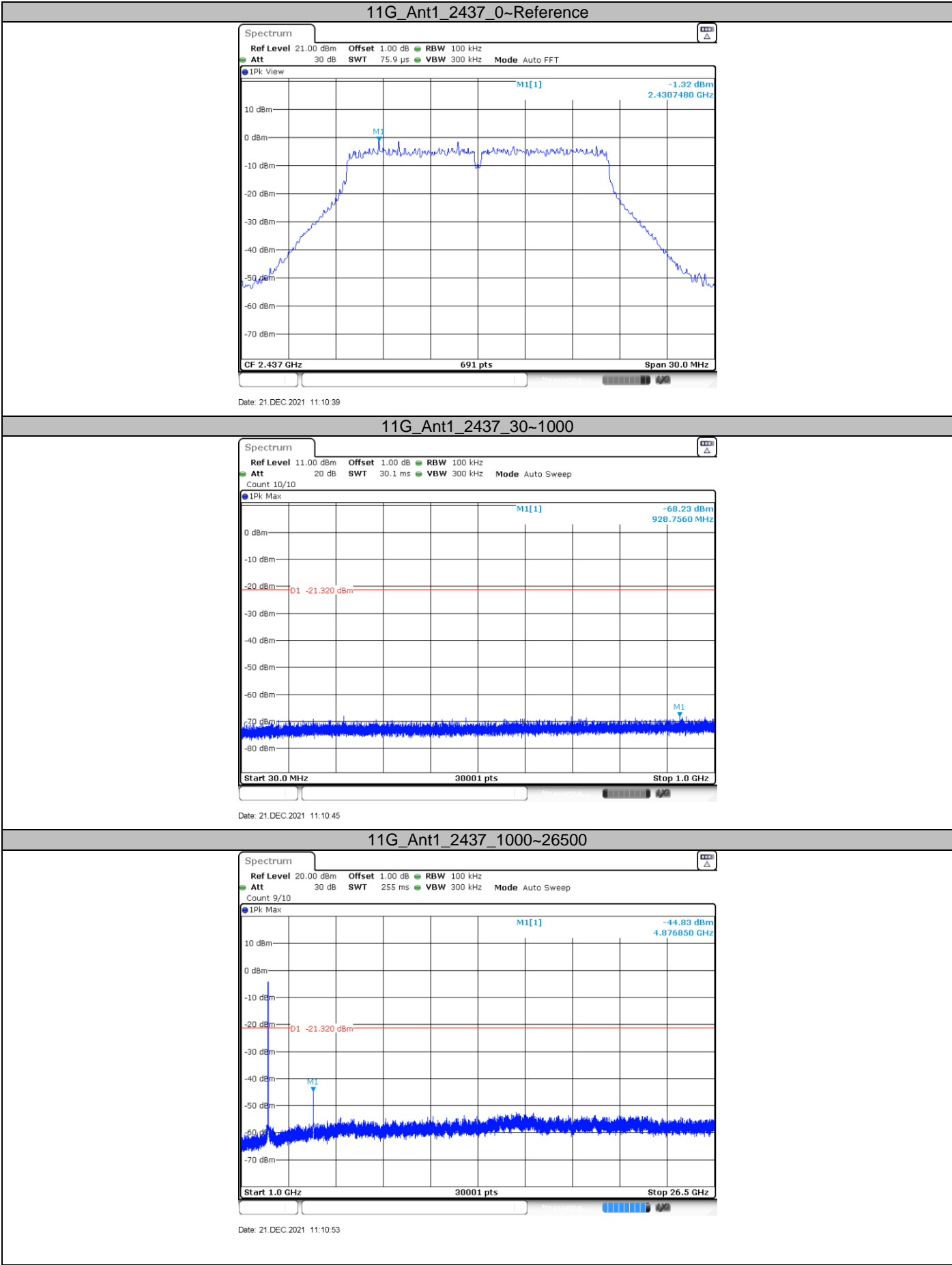

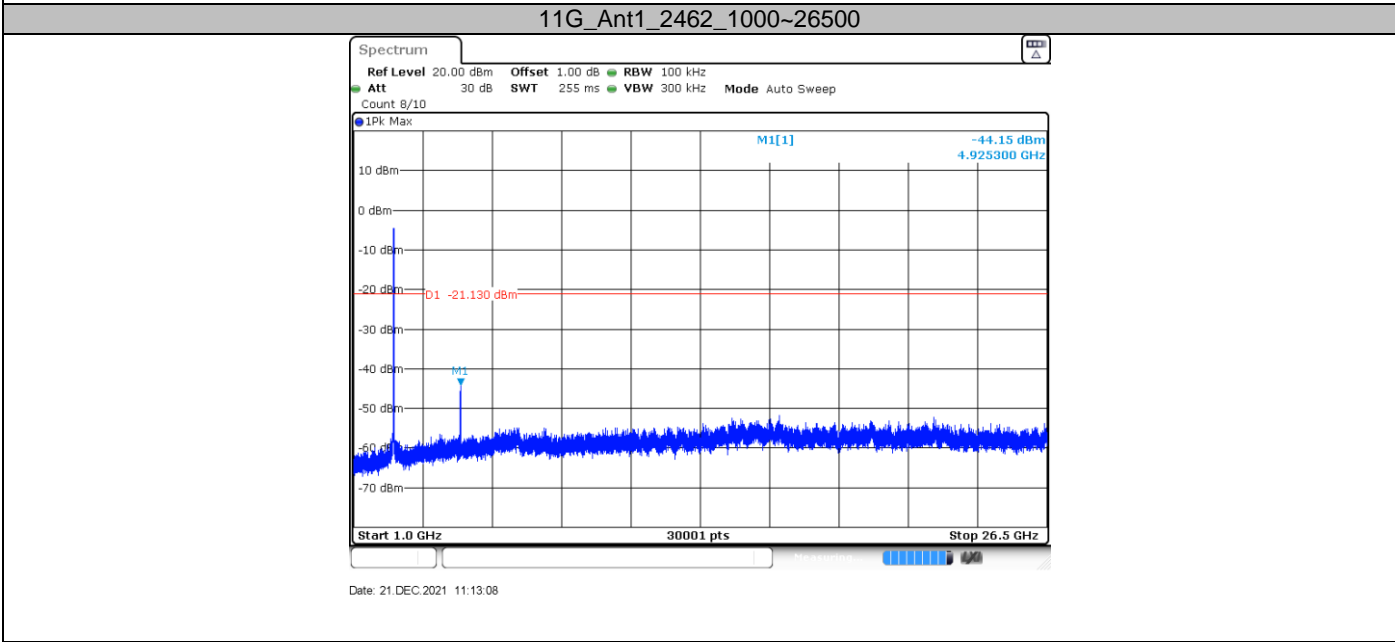
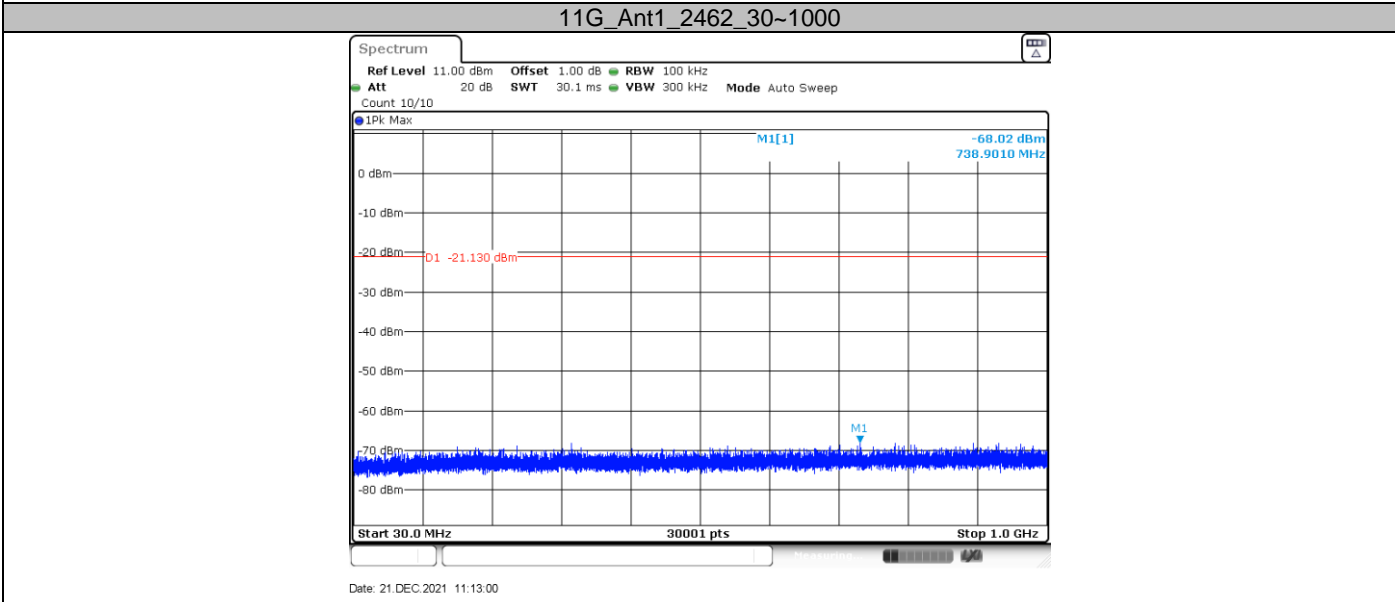
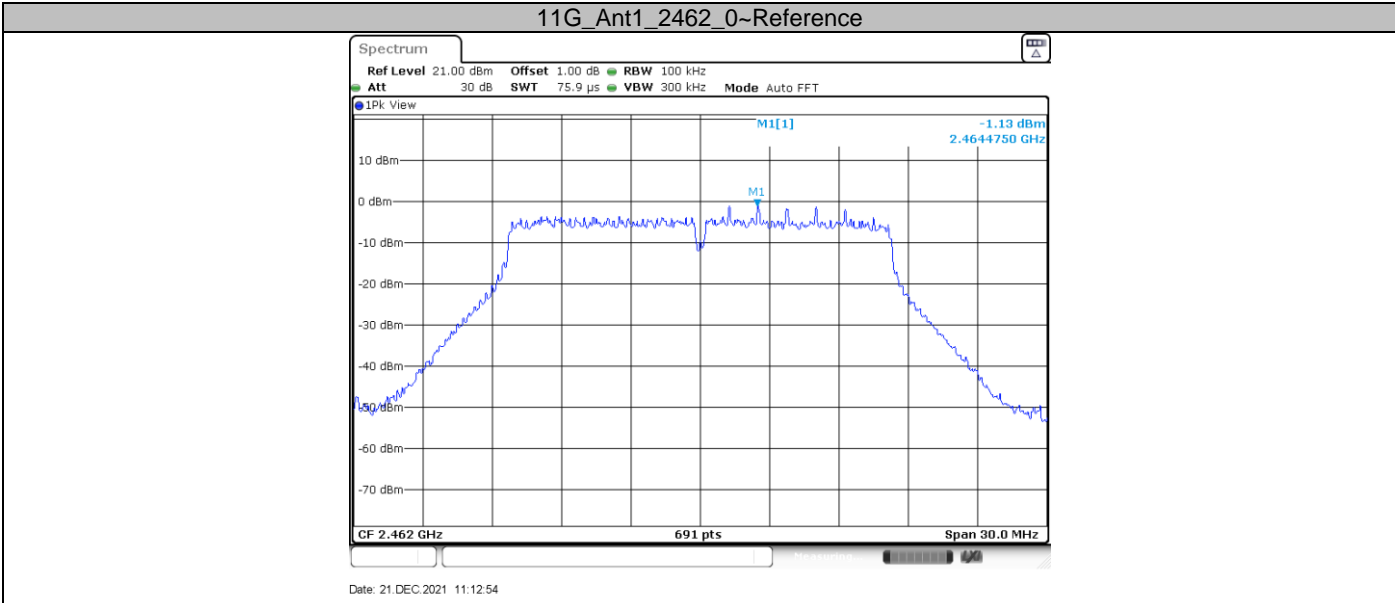

11N20SISO_Ant1_2412_0~Reference

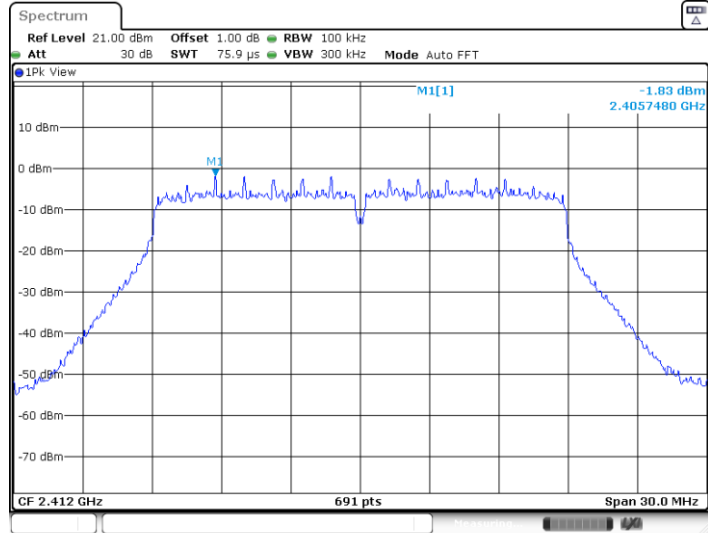

Date: 21.DEC.2021 11:24:00

11N20SISO_Ant1_2412_30~1000

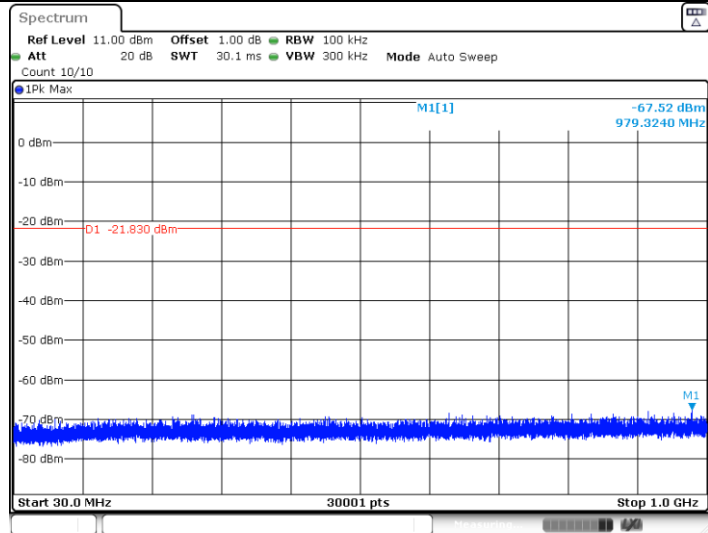

Date: 21.DEC.2021 11:24:06

11N20SISO_Ant1_2412_1000~26500

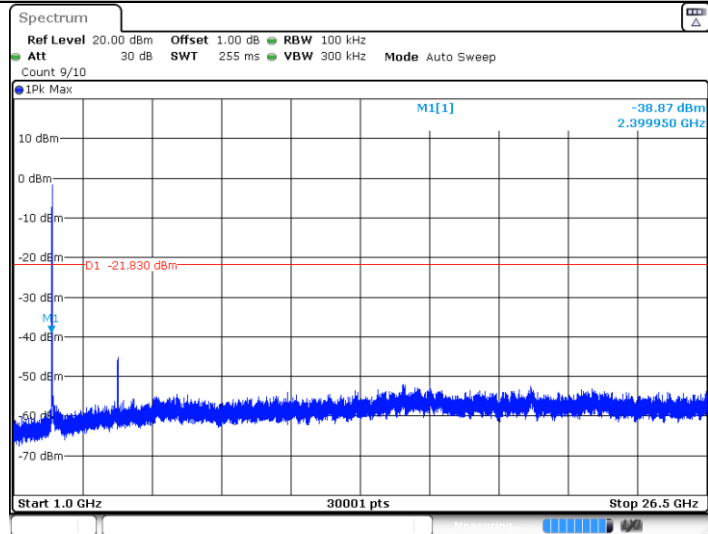

Date: 21.DEC.2021 11:24:13

11N20SISO_Ant1_2437_0~Reference

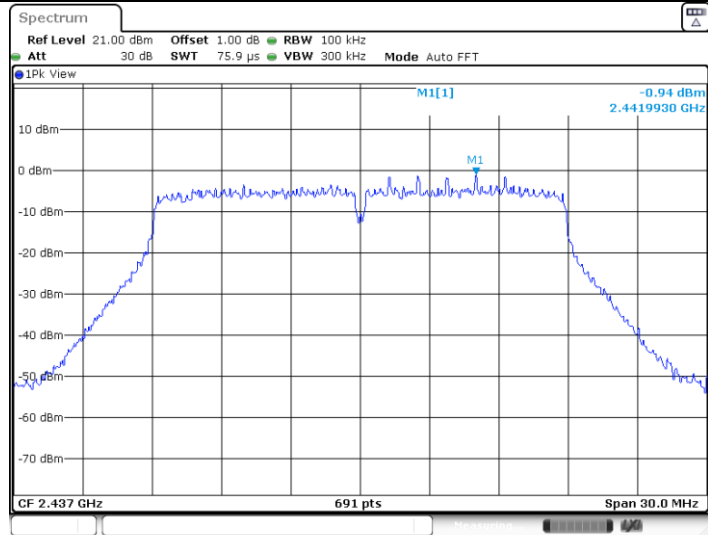

Date: 21.DEC.2021 11:26:20

11N20SISO_Ant1_2437_30~1000

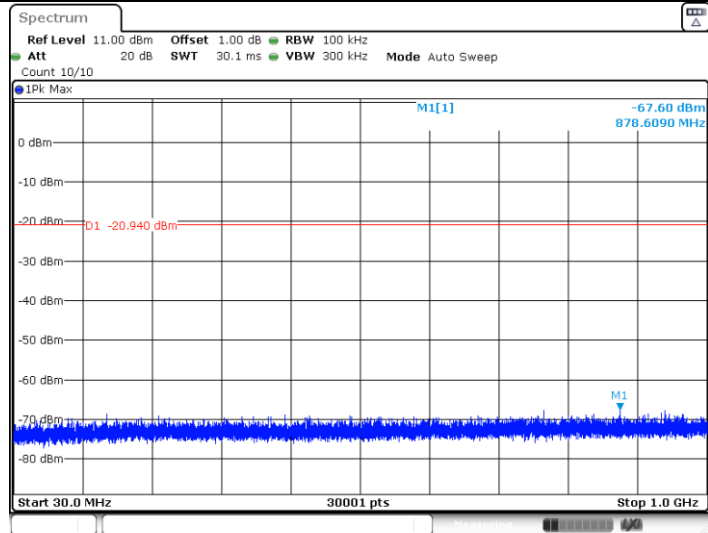

Date: 21.DEC.2021 11:26:26

11N20SISO_Ant1_2437_1000~26500

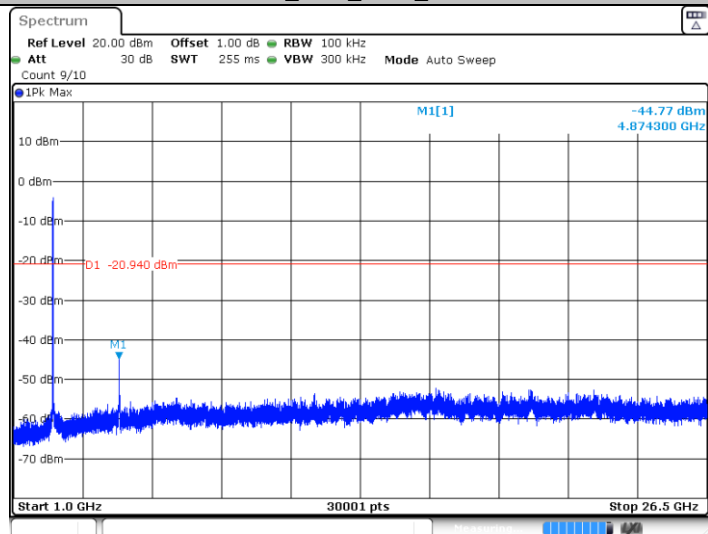

Date: 21.DEC.2021 11:26:34

11N20SISO_Ant1_2462_0~Reference

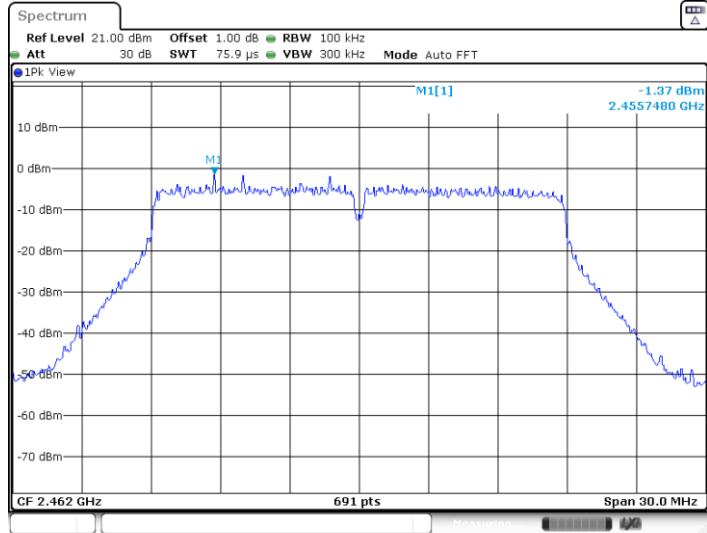

Date: 21.DEC.2021 11:28:32

11N20SISO_Ant1_2462_30~1000

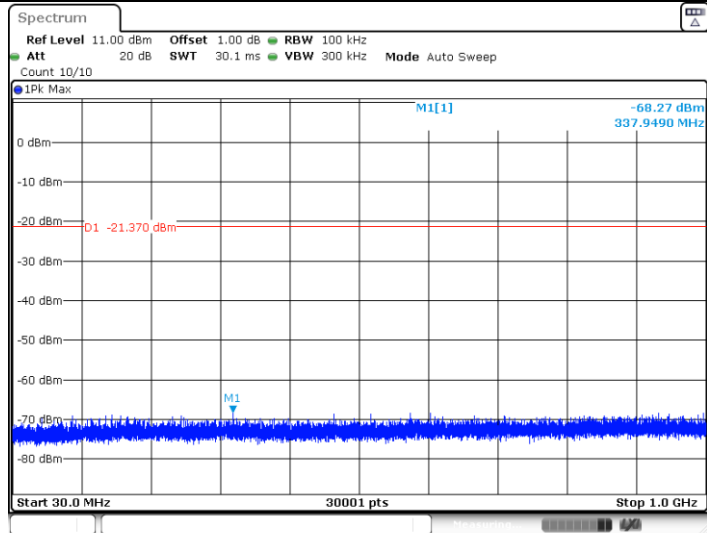

Date: 21.DEC.2021 11:28:38

11N20SISO_Ant1_2462_1000~26500

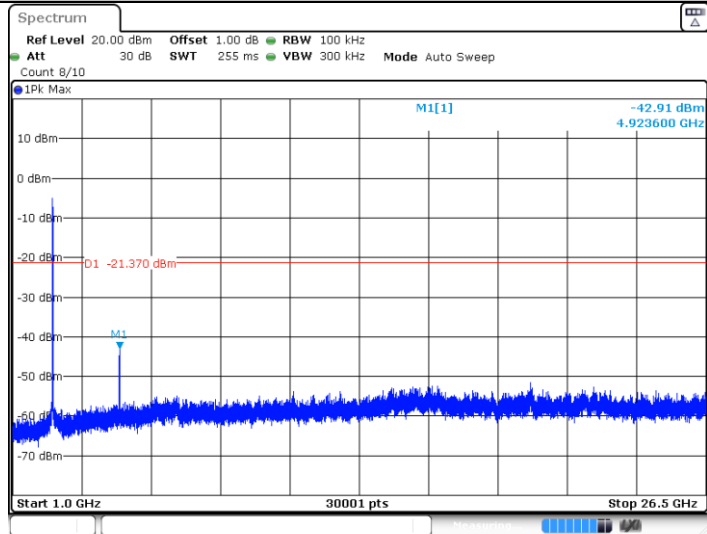

Date: 21.DEC.2021 11:28:46

9.5 Band edge testing

Test Method

1. The RF output of EUT was connected to the spectrum analyzer by RF cable. The path loss was compensated to the results for each measurement.
2. Use the following spectrum analyzer settings:
Span = wide enough to capture the peak level of the in-band emission and all spurious
RBW = 100 kHz, VBW ≥ RBW, Sweep = auto, Detector function = peak, Trace = max hold
3. Allow the trace to stabilize, use the peak and delta measurement to record the result.
4. The level displayed must comply with the limit specified in this Section.
5. Repeat the test at the hopping off and hopping on mode, submit all the plots.

Limit:

According to §15.247(d), in any 100 kHz bandwidth outside the frequency bands in which the spread spectrum intentional radiator is operating, the radio frequency power that is produced by the intentional radiator shall be at least 20 dB below that in the 100 kHz bandwidth within the band that contains the highest level of the desired power, based on either an RF conducted or a radiated measurement, provided the transmitter demonstrates compliance with the peak conducted power limits. In addition, radiated emissions which fall in the restricted bands, as defined in §15.205(a), must also comply with the radiated emission limits specified in 15.209(a) (see Section 15.205(c)).

Frequency Range MHz	Limit (dBc)
30-25000	-20

Band edge testing

TestMode	Antenna	ChName	Channel (MHz)	RefLevel (dBm)	Result (dBm)	Limit (dBm)	Verdict
11B	Ant0	Low	2412	6.16	-48.05	<=-13.84	PASS
	Ant0	High	2462	7.28	-51.11	<=-12.72	PASS
11G	Ant0	Low	2412	-4.71	-43.49	<=-24.71	PASS
	Ant0	High	2462	-0.44	-55.02	<=-20.44	PASS
11N20	Ant0	Low	2412	-2.26	-42.8	<=-22.26	PASS
	Ant0	Low	2462	-0.38	-54.93	<=-20.38	PASS

11B_Ant1_Low_2412

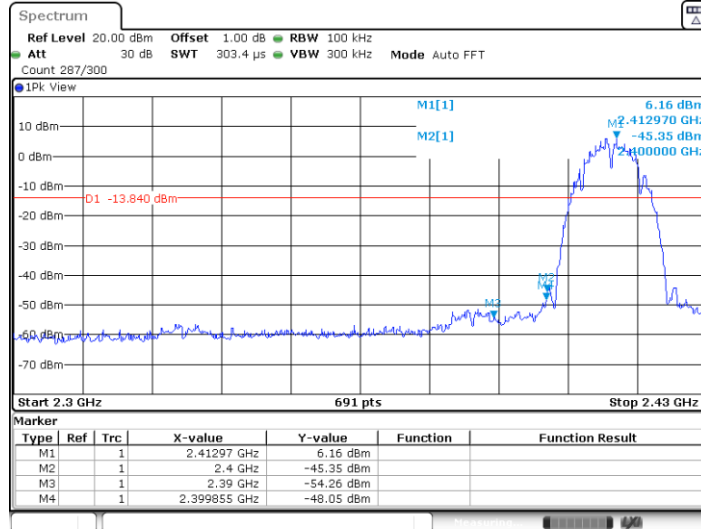

Date: 21.DEC.2021 10:59:12

11B_Ant1_High_2462

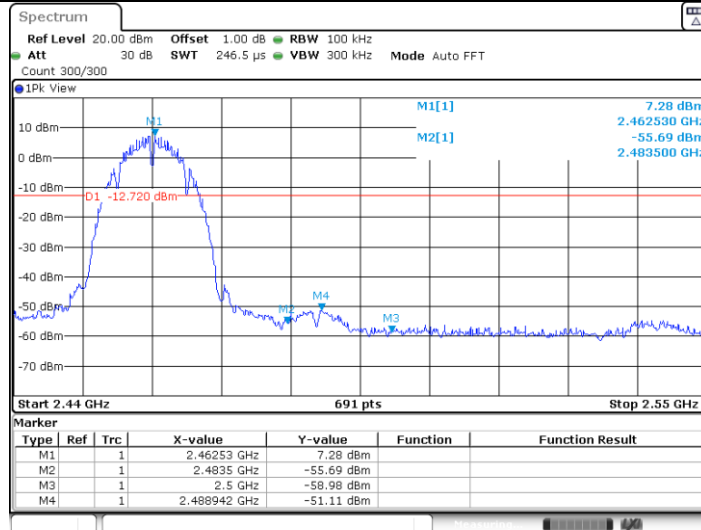

Date: 21.DEC.2021 11:03:47

11G_Ant1_Low_2412

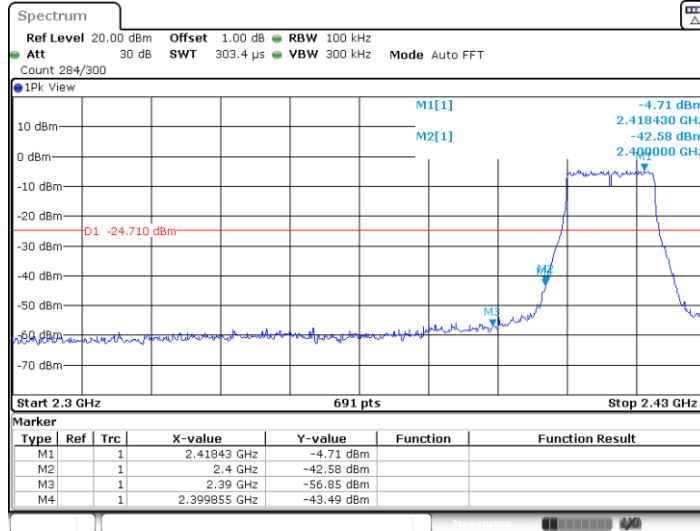

Date: 21.DEC.2021 11:08:39

11G_Ant1_High_2462

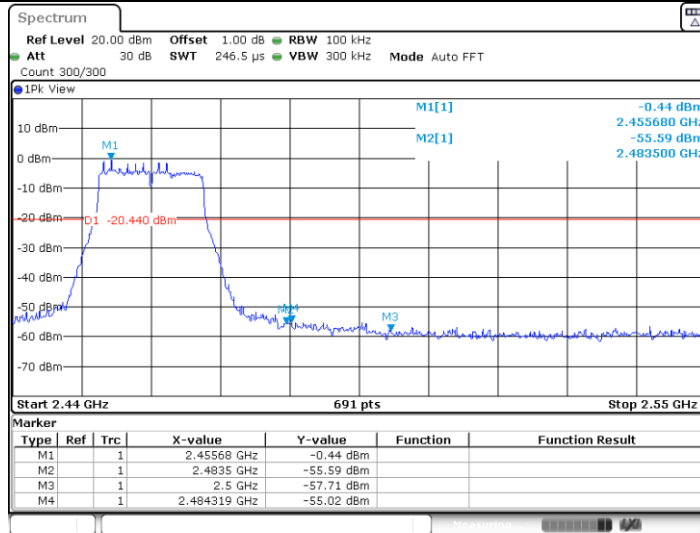

Date: 21.DEC.2021 11:12:48

11N20SISO_Ant1_Low_2412

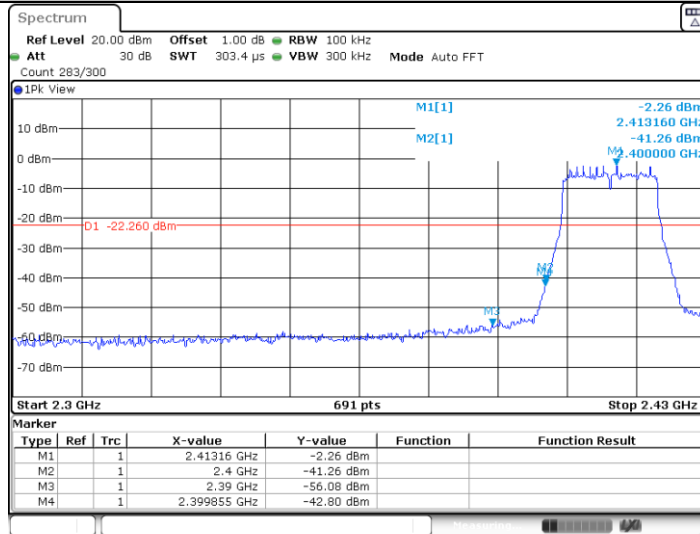

Date: 21.DEC.2021 11:23:54

11N20SISO_Ant1_High_2462

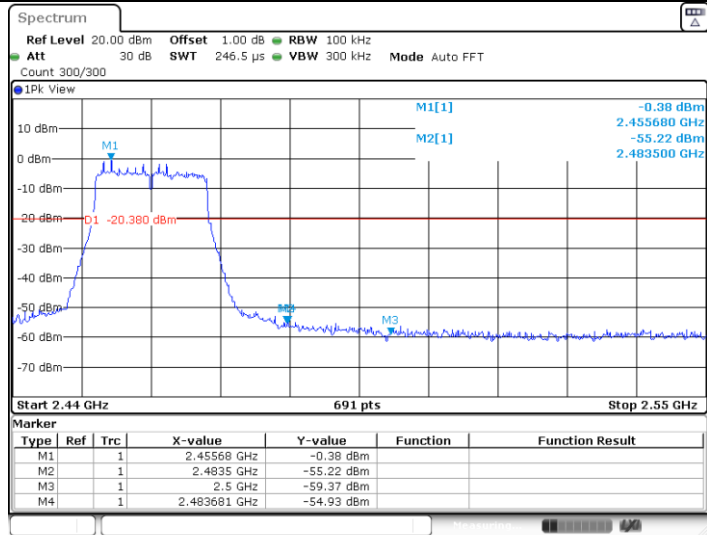

9.6 Spurious radiated emissions for transmitter

Test Method

1. The EUT was placed on a turn table which is 1.5m above ground plane for above 1GHz and 0.8m above ground for below 1GHz at 3 meters chamber room for test. The table was rotated 360 degrees to determine the position of the highest radiation.
2. Set to the maximum power setting and enable the EUT transmit continuously
3. The EUT was set 3 meters away from the interference – receiving antenna, which was mounted on the top of a variable – height antenna tower.
4. The height of antenna is varied from one meter to four meters above the ground to determine the maximum value of the field strength. Both horizontal and vertical polarizations of the antenna are set to make the measurement.
5. For each suspected emission, the EUT was arranged to its worst case and then the antenna was tuned to heights from 1 meter to 4 meters and the rotatable table was turned from 0 degrees to 360 degrees to find the maximum reading.
6. Use the following spectrum analyzer settings According to C63.10:
For Below 1GHz
Use the following spectrum analyzer settings:
Span = wide enough to capture the peak level of the in-band emission and all spurious
RBW = 100 KHz to 120KHz, VBW \geq RBW for peak measurement, Sweep = auto, Detector function = peak, Trace = max hold.

For Peak unwanted emissions Above 1GHz:

Span = wide enough to capture the peak level of the in-band emission and all spurious
RBW = 1MHz, VBW \geq RBW for peak measurement, Sweep = auto, Detector function = peak, Trace = max hold.

Procedures for average unwanted emissions measurements above 1000 MHz

a) RBW = 1MHz.

b) VBW \ [3 \times RBW].

c) Detector = RMS (power averaging), if [span / (# of points in sweep)] \ RBW / 2.

Satisfying this condition can require increasing the number of points in the sweep or reducing the span. If the condition is not satisfied, then the detector mode shall be set to peak.

d) Averaging type = power (i.e., rms) (As an alternative, the detector and averaging type may be set for linear voltage averaging. Some instruments require linear display mode to use linear voltage averaging. Log or dB averaging shall not be used.)

e) Sweep time = auto.

f) Perform a trace average of at least 100 traces if the transmission is continuous. If the transmission is not continuous, then the number of traces shall be increased by a factor of 1 / D, where D is the duty cycle. For example, with 50% duty cycle, at least 200 traces shall be averaged. (If a specific emission is demonstrated to be continuous—i.e., 100% duty cycle—then rather than turning ON and OFF with the transmit cycle, at least 100 traces shall be averaged.)

g) If tests are performed with the EUT transmitting at a duty cycle less than 98%, then a correction factor shall be added to the measurement results prior to comparing with the emission limit, to compute the emission level that would have been measured had the test been performed at 100% duty cycle. The correction factor is computed as follows:

- 1) If power averaging (rms) mode was used in the preceding step e), then the correction factor is $[10 \log (1 / D)]$, where D is the duty cycle. For example, if the transmit duty cycle was 50%, then 3 dB shall be added to the measured emission levels.
- 2) If linear voltage averaging mode was used in the preceding step e), then the correction factor is $[20 \log (1 / D)]$, where D is the duty cycle. For example, if the transmit duty cycle was 50%, then 6 dB shall be added to the measured emission levels.
- 3) If a specific emission is demonstrated to be continuous (100% duty cycle) rather than turning ON and OFF with the transmit cycle, then no duty cycle correction is required for that emission.

Limit

The radio emission outside the operating frequency band shall be at least 20 dB below that in the 100 kHz bandwidth within the band that contains the highest level of the desired power. Radiated emissions which fall in the restricted bands, as defined in section 15.205, must comply with the radiated emission limits specified in section 15.209.

Frequency MHz	Field Strength $\mu\text{V/m}$	Field Strength $\text{dB}\mu\text{V/m}$	Detector
30-88	100	40	QP
88-216	150	43.5	QP
216-960	200	46	QP
960-1000	500	54	QP
Above 1000	500	54	AV
Above 1000	5000	74	PK

Spurious radiated emissions for transmitter

According to C63.10, if the peak (or quasi-peak) measured value complies with the average limit, it is unnecessary to perform an average measurement, so AV emission value did not show in below table if the peak value complies with average limit.

Transmitting spurious emission test result as below:

30MHz to 1000MHz:

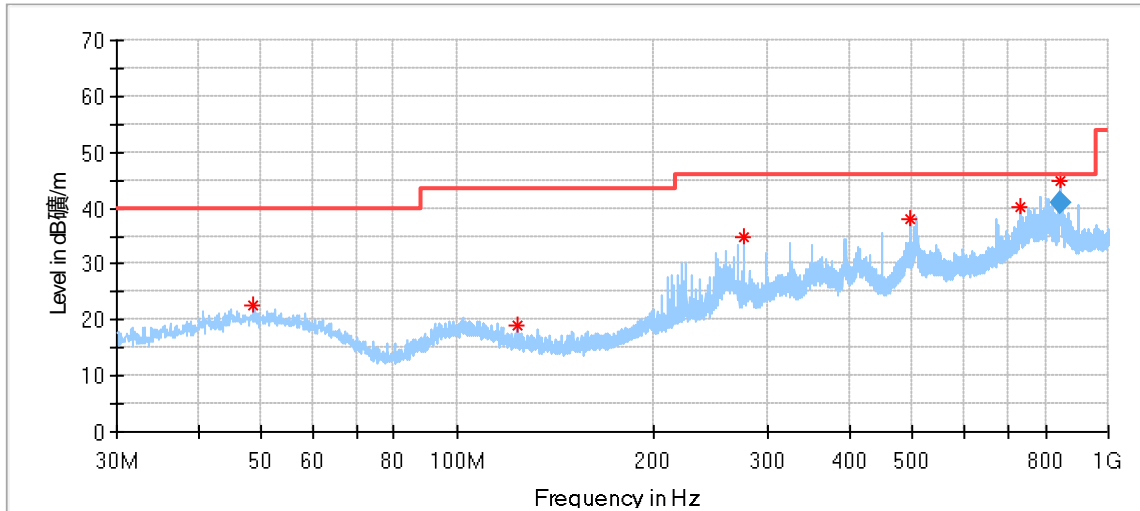

Frequency (MHz)	MaxPeak (dBµV/m)	Limit (dBµV/m)	Margin (dB)	Height (cm)	Pol	Azimuth (deg)	Corr. (dB/m)
48.699444	22.44	40.00	17.56	200.0	H	166.0	20.92
123.874444	18.94	43.50	24.56	200.0	H	294.0	16.25
274.978889	34.86	46.00	11.14	100.0	H	4.0	20.18
495.007222	38.06	46.00	7.94	200.0	H	0.0	25.48
731.741111	40.30	46.00	5.70	100.0	H	175.0	29.45
844.309755	44.82	46.00	1.18	100.0	H	202.0	31.09
Frequency (MHz)	QuasiPeak (dBµV/m)	Limit (dBµV/m)	Margin (dB)	Height (cm)	Pol	Azimuth (deg)	Corr. (dB/m)
844.309755	40.80	46.00	5.20	100.0	H	202.0	31.10

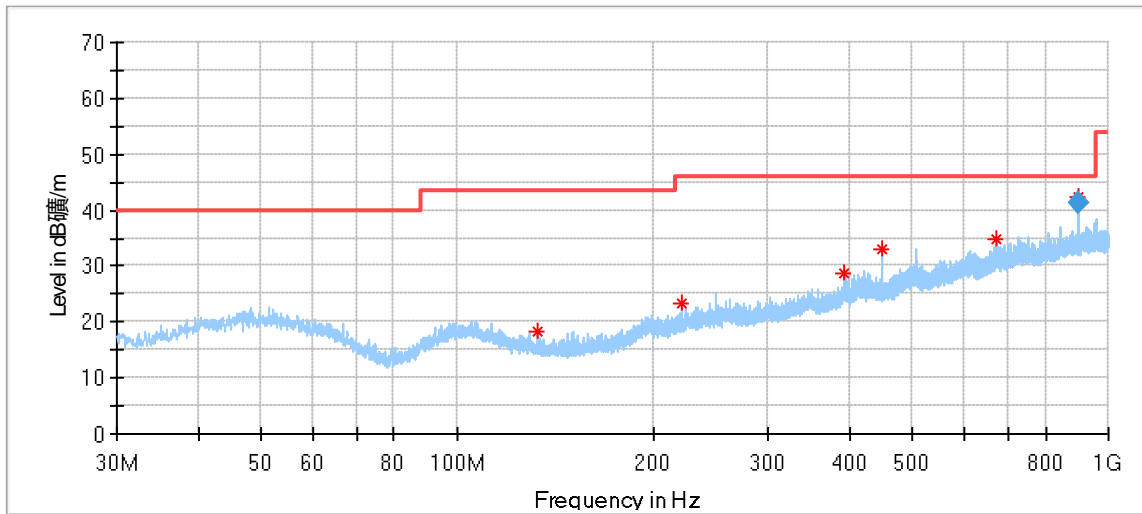

Frequency (MHz)	MaxPeak (dBµV/m)	Limit (dBµV/m)	Margin (dB)	Height (cm)	Pol	Azimuth (deg)	Corr. (dB/m)
132.388889	18.46	43.50	25.04	100.0	V	210.0	15.45
221.251667	23.19	46.00	22.81	100.0	V	40.0	18.64
393.318889	28.64	46.00	17.36	200.0	V	331.0	23.42
450.010000	32.90	46.00	13.10	200.0	V	0.0	24.24
674.457222	34.88	46.00	11.12	100.0	V	134.0	28.59
900.000978	42.51	46.00	3.49	104.0	V	209.0	31.52
Frequency (MHz)	QuasiPeak (dBµV/m)	Limit (dBµV/m)	Margin (dB)	Height (cm)	Pol	Azimuth (deg)	Corr. (dB/m)
900.000978	41.18	46.00	4.82	104.0	V	209.0	31.52

1GHz -18GHz:

11B-Ant0_2412MHz

Horizontal:

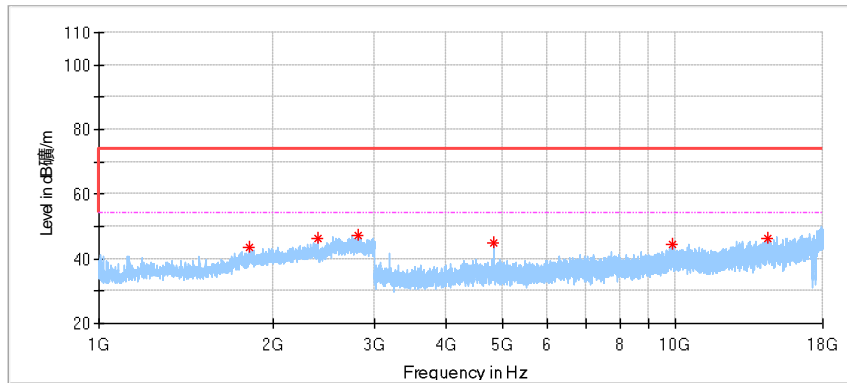

Frequency (MHz)	MaxPeak (dBµV/m)	Limit (dBµV/m)	Margin (dB)	Height (cm)	Pol	Azimuth (deg)	Corr. (dB/m)
1818.571429	43.52	74.00	30.48	150.0	H	19.0	-5.05
2392.380952	46.47	74.00	27.53	150.0	H	224.0	-2.22
2810.952381	47.20	74.00	26.80	150.0	H	356.0	-1.08
4824.000000	44.95	74.00	29.05	150.0	H	271.0	3.55
9877.500000	44.63	74.00	29.37	150.0	H	33.0	11.54
14436.000000	46.34	74.00	27.66	150.0	H	124.0	13.71

Vertical

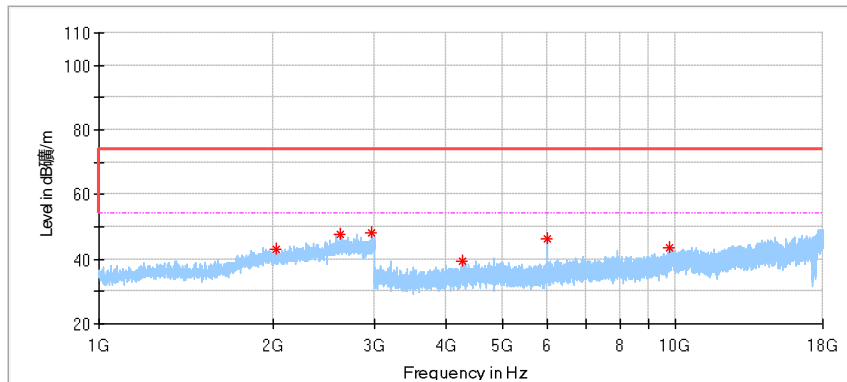

Frequency (MHz)	MaxPeak (dBµV/m)	Limit (dBµV/m)	Margin (dB)	Height (cm)	Pol	Azimuth (deg)	Corr. (dB/m)
2034.761905	43.21	74.00	30.79	150.0	V	276.0	-3.73
2625.238095	47.68	74.00	26.32	150.0	V	356.0	-1.43
2968.571429	48.07	74.00	25.93	150.0	V	291.0	-0.41
4273.500000	39.61	74.00	34.39	150.0	V	245.0	2.12
6000.000000	46.51	74.00	27.49	150.0	V	32.0	6.17
9731.500000	43.74	74.00	30.26	150.0	V	127.0	9.96

11B-Ant0_2437MHz
Horizontal:

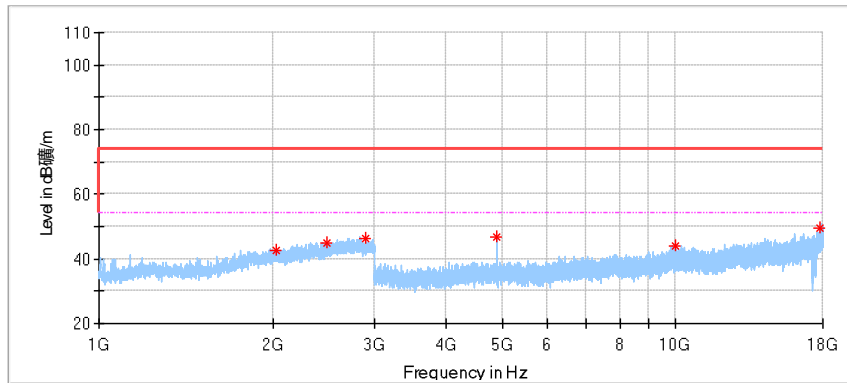

Frequency (MHz)	MaxPeak (dBµV/m)	Limit (dBµV/m)	Margin (dB)	Height (cm)	Pol	Azimuth (deg)	Corr. (dB/m)
2028.571429	42.44	74.00	31.56	150.0	H	224.0	-3.75
2488.095238	44.81	74.00	29.19	150.0	H	0.0	-1.83
2905.714286	46.45	74.00	27.55	150.0	H	7.0	-0.86
4884.000000	46.99	74.00	27.01	150.0	H	270.0	3.66
9967.000000	43.97	74.00	30.03	150.0	H	350.0	10.09
17753.500000	49.74	74.00	24.26	150.0	H	270.0	20.20

Vertical

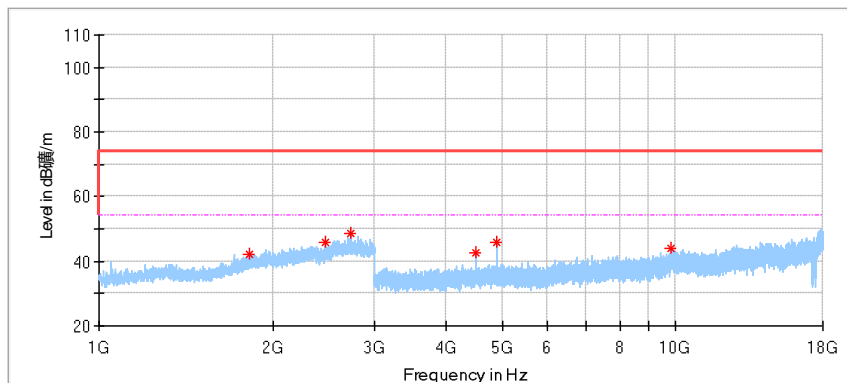

Frequency (MHz)	MaxPeak (dBµV/m)	Limit (dBµV/m)	Margin (dB)	Height (cm)	Pol	Azimuth (deg)	Corr. (dB/m)
1828.571429	42.21	74.00	31.79	150.0	V	3.0	-4.89
2473.809524	46.00	74.00	28.00	150.0	V	320.0	-1.84
2727.142857	48.78	74.00	25.22	150.0	V	144.0	-1.28
4500.000000	42.67	74.00	31.33	150.0	V	359.0	2.74
4884.000000	45.86	74.00	28.14	150.0	V	321.0	3.66
9840.500000	44.12	74.00	29.88	150.0	V	63.0	11.47

11B-Ant0_2462MHz
Horizontal:

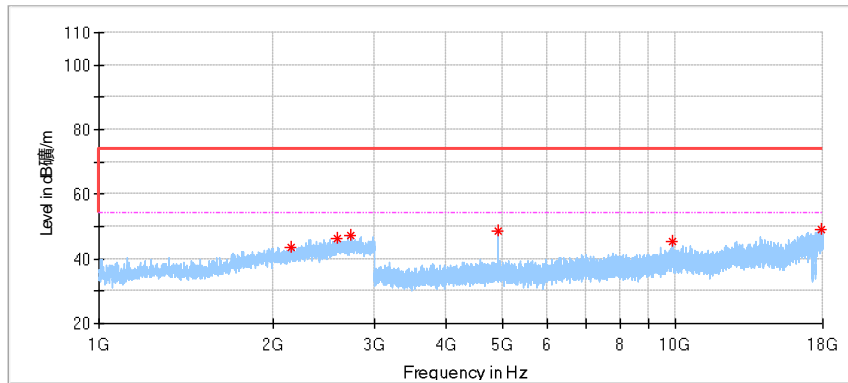

Frequency (MHz)	MaxPeak (dBµV/m)	Limit (dBµV/m)	Margin (dB)	Height (cm)	Pol	Azimuth (deg)	Corr. (dB/m)
2154.285714	43.67	74.00	30.33	150.0	H	0.0	-3.36
2589.523810	46.34	74.00	27.66	150.0	H	173.0	-1.52
2735.714286	47.40	74.00	26.60	150.0	H	100.0	-1.25
4924.000000	48.58	74.00	25.42	150.0	H	294.0	3.58
9853.000000	45.45	74.00	28.55	150.0	H	63.0	11.69
17851.000000	49.15	74.00	24.85	150.0	H	211.0	20.33

Vertical

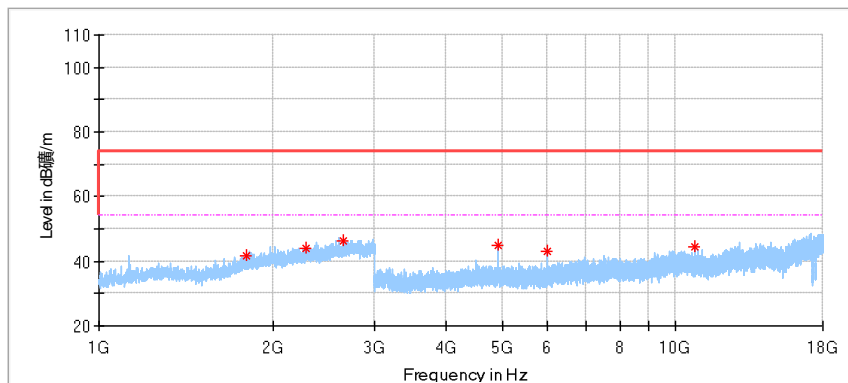

Frequency (MHz)	MaxPeak (dBµV/m)	Limit (dBµV/m)	Margin (dB)	Height (cm)	Pol	Azimuth (deg)	Corr. (dB/m)
1800.000000	41.50	74.00	32.50	150.0	V	41.0	-5.29
2282.857143	43.78	74.00	30.22	150.0	V	210.0	-2.58
2647.142857	46.44	74.00	27.56	150.0	V	232.0	-1.37
4924.000000	44.99	74.00	29.01	150.0	V	349.0	3.58
6000.500000	43.29	74.00	30.71	150.0	V	296.0	6.17
10812.500000	44.32	74.00	29.68	150.0	V	4.0	10.68

11G-Ant0_2412MHz
Horizontal:

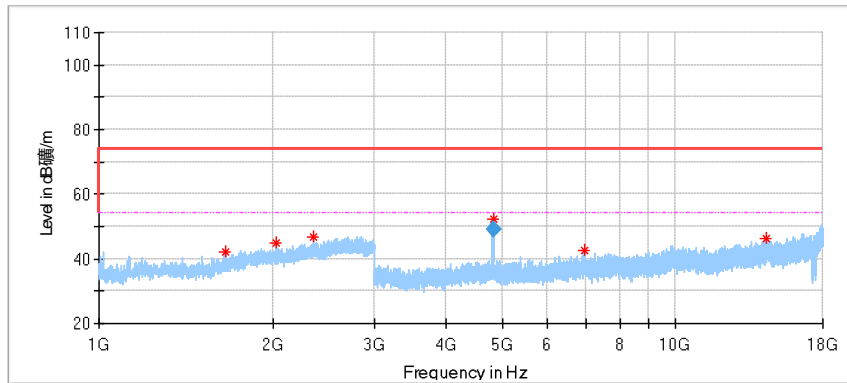

Frequency (MHz)	MaxPeak (dBµV/m)	Limit (dBµV/m)	Margin (dB)	Height (cm)	Pol	Azimuth (deg)	Corr. (dB/m)
1653.809524	42.17	74.00	31.83	150.0	H	128.0	-7.25
2026.666667	44.92	74.00	29.08	150.0	H	352.0	-3.76
2352.857143	46.74	74.00	27.26	150.0	H	341.0	-2.38
4823.500000	52.38	74.00	21.62	150.0	H	268.0	3.54
6935.500000	42.64	74.00	31.36	150.0	H	268.0	7.14
14397.500000	46.15	74.00	27.85	150.0	H	238.0	13.61
Frequency (MHz)	Average (dBµV/m)	Limit (dBµV/m)	Margin (dB)	Height (cm)	Pol	Azimuth (deg)	Corr. (dB/m)
4823.500000	49.00	54.00	5.00	150.0	H	268.0	3.54

Vertical

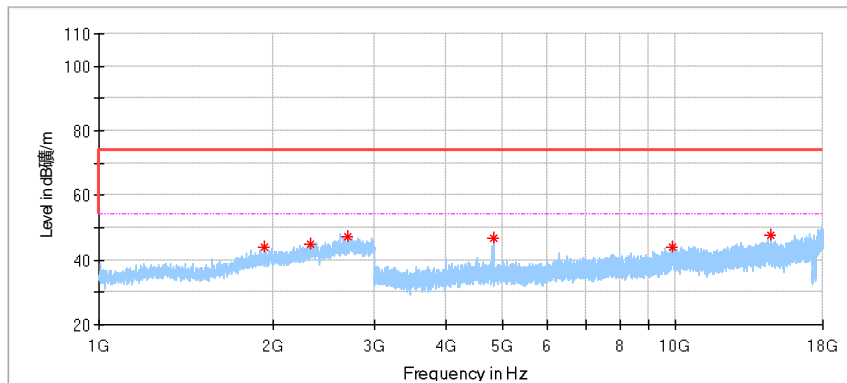

Frequency (MHz)	MaxPeak (dBµV/m)	Limit (dBµV/m)	Margin (dB)	Height (cm)	Pol	Azimuth (deg)	Corr. (dB/m)
1931.904762	44.16	74.00	29.84	150.0	V	161.0	-3.88
2325.714286	44.79	74.00	29.21	150.0	V	84.0	-2.30
2700.476191	47.44	74.00	26.56	150.0	V	55.0	-1.34
4824.000000	46.97	74.00	27.03	150.0	V	297.0	3.55
9899.500000	44.00	74.00	30.00	150.0	V	39.0	11.15
14610.500000	47.66	74.00	26.34	150.0	V	13.0	13.87

11G-Ant0_2437MHz
Horizontal:

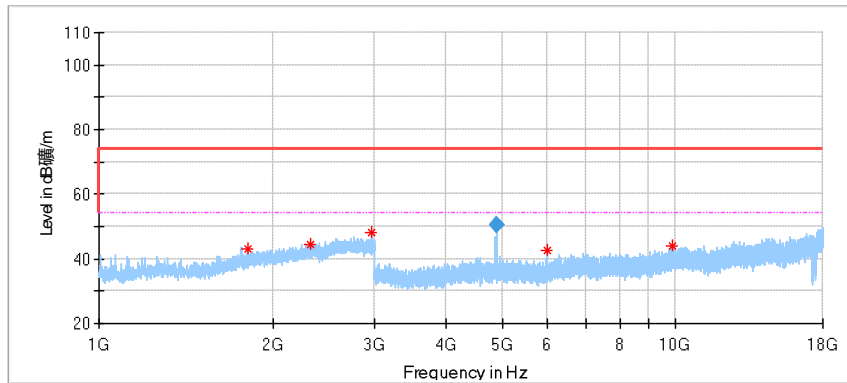

Frequency (MHz)	MaxPeak (dBµV/m)	Limit (dBµV/m)	Margin (dB)	Height (cm)	Pol	Azimuth (deg)	Corr. (dB/m)
1812.857143	43.30	74.00	30.70	150.0	H	202.0	-5.13
2329.047619	44.51	74.00	29.49	150.0	H	353.0	-2.27
2971.428571	47.93	74.00	26.07	150.0	H	356.0	-0.41
4884.000000	50.75	74.00	23.25	150.0	H	268.0	3.66
6000.000000	42.62	74.00	31.38	150.0	H	39.0	6.17
9887.000000	44.08	74.00	29.92	150.0	H	13.0	11.38
Frequency (MHz)	Average (dBµV/m)	Limit (dBµV/m)	Margin (dB)	Height (cm)	Pol	Azimuth (deg)	Corr. (dB/m)
4884.000000	50.53	54.00	3.47	150.0	H	268.0	3.66

Vertical

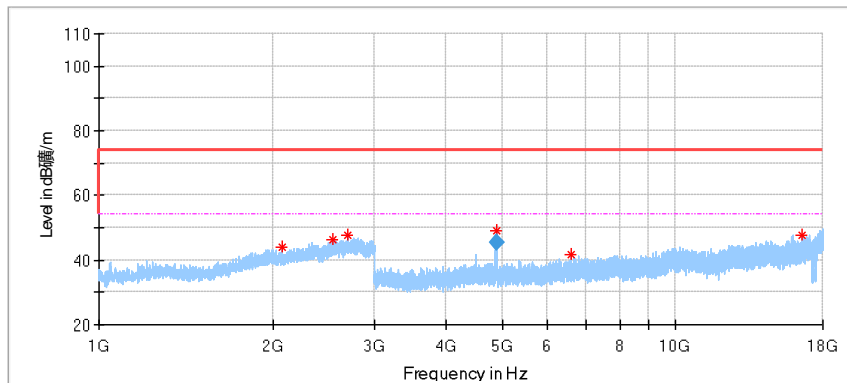

Frequency (MHz)	MaxPeak (dBµV/m)	Limit (dBµV/m)	Margin (dB)	Height (cm)	Pol	Azimuth (deg)	Corr. (dB/m)
2074.761905	44.18	74.00	29.82	150.0	V	202.0	-3.65
2544.285714	46.33	74.00	27.67	150.0	V	0.0	-1.59
2700.476191	47.66	74.00	26.34	150.0	V	18.0	-1.34
4884.000000	49.24	74.00	24.76	150.0	V	328.0	3.66
6570.000000	41.48	74.00	32.52	150.0	V	328.0	6.81
16548.000000	47.74	74.00	26.26	150.0	V	123.0	19.12
Frequency (MHz)	Average (dBµV/m)	Limit (dBµV/m)	Margin (dB)	Height (cm)	Pol	Azimuth (deg)	Corr. (dB/m)
4884.000000	45.44	54.00	8.56	150.0	V	328.0	3.66

11G-Ant0_2462MHz
Horizontal:

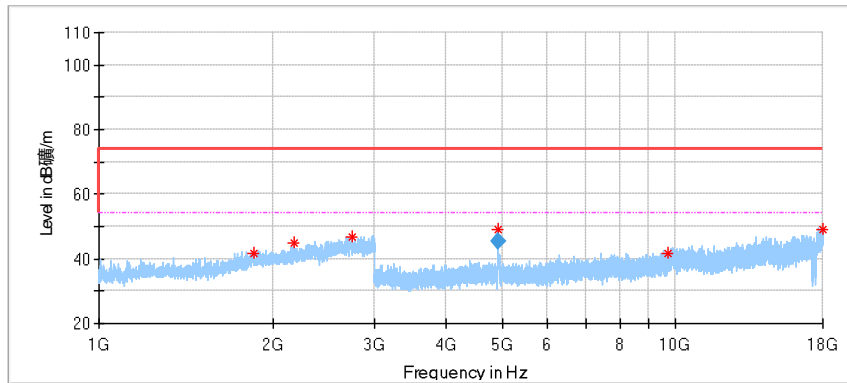

Frequency (MHz)	MaxPeak (dBµV/m)	Limit (dBµV/m)	Margin (dB)	Height (cm)	Pol	Azimuth (deg)	Corr. (dB/m)
1860.476191	41.75	74.00	32.25	150.0	H	113.0	-4.61
2181.904762	44.71	74.00	29.29	150.0	H	313.0	-3.14
2747.142857	46.90	74.00	27.10	150.0	H	98.0	-1.21
4929.000000	48.94	74.00	25.06	150.0	H	237.0	3.61
9715.500000	41.87	74.00	32.13	150.0	H	152.0	9.91
17982.500000	49.03	74.00	24.97	150.0	H	152.0	20.51
Frequency (MHz)	Average (dBµV/m)	Limit (dBµV/m)	Margin (dB)	Height (cm)	Pol	Azimuth (deg)	Corr. (dB/m)
4929.000000	45.20	54.00	8.80	150.0	H	237.0	3.61

Vertical

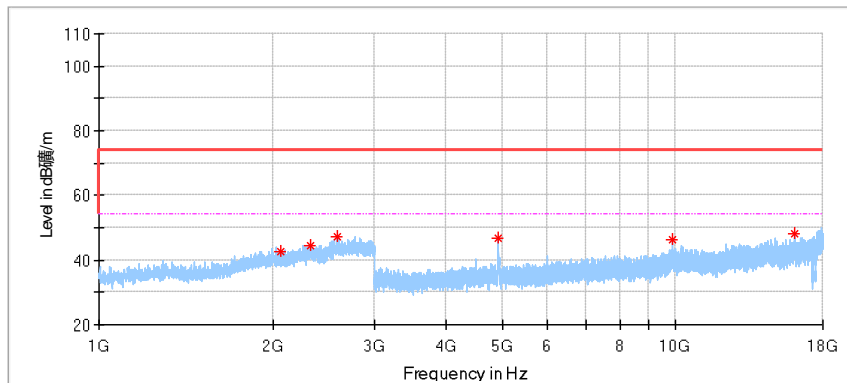

Frequency (MHz)	MaxPeak (dBµV/m)	Limit (dBµV/m)	Margin (dB)	Height (cm)	Pol	Azimuth (deg)	Corr. (dB/m)
2066.190476	42.42	74.00	31.58	150.0	V	210.0	-3.64
2332.380952	44.59	74.00	29.41	150.0	V	291.0	-2.28
2585.714286	47.41	74.00	26.59	150.0	V	320.0	-1.53
4928.500000	46.85	74.00	27.15	150.0	V	32.0	3.61
9848.000000	46.40	74.00	27.60	150.0	V	351.0	11.60
16063.500000	47.97	74.00	26.03	150.0	V	276.0	17.90

11N-HT20-Ant 0_2412MHz
Horizontal:

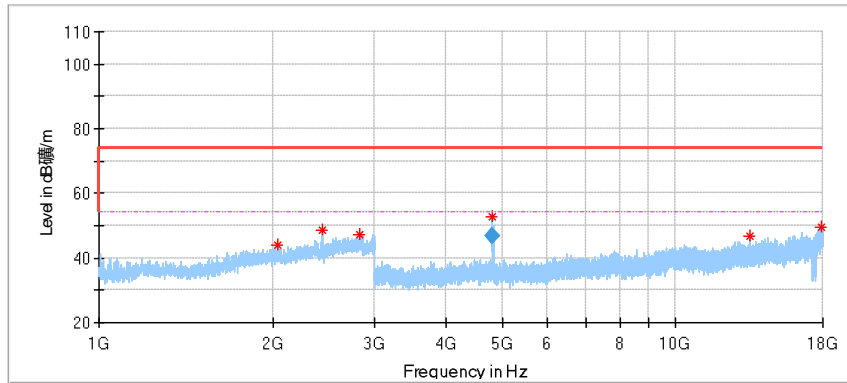

Frequency (MHz)	MaxPeak (dBµV/m)	Limit (dBµV/m)	Margin (dB)	Height (cm)	Pol	Azimuth (deg)	Corr. (dB/m)
2043.333333	44.06	74.00	29.94	150.0	H	341.0	-3.69
2440.476191	48.62	74.00	25.38	150.0	H	99.0	-2.02
2828.571429	47.21	74.00	26.79	150.0	H	18.0	-1.05
4820.500000	52.55	74.00	21.45	150.0	H	264.0	3.52
13431.500000	46.59	74.00	27.41	150.0	H	264.0	12.93
17843.000000	49.64	74.00	24.36	150.0	H	10.0	20.32
Frequency (MHz)	Average (dBµV/m)	Limit (dBµV/m)	Margin (dB)	Height (cm)	Pol	Azimuth (deg)	Corr. (dB/m)
4820.500000	47.00	54.00	7.00	150.0	H	264.0	3.52

Vertical

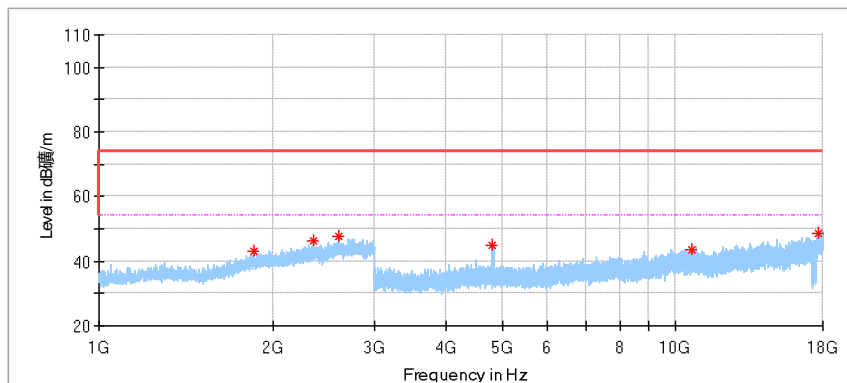

Frequency (MHz)	MaxPeak (dBµV/m)	Limit (dBµV/m)	Margin (dB)	Height (cm)	Pol	Azimuth (deg)	Corr. (dB/m)
1860.952381	43.05	74.00	30.95	150.0	V	16.0	-4.61
2356.190476	46.16	74.00	27.84	150.0	V	0.0	-2.37
2608.095238	47.73	74.00	26.27	150.0	V	342.0	-1.48
4816.500000	44.70	74.00	29.30	150.0	V	321.0	3.50
10667.500000	43.59	74.00	30.41	150.0	V	92.0	10.58
17723.000000	48.45	74.00	25.55	150.0	V	237.0	20.10

11N-HT20-Ant 0_2437MHz
Horizontal:

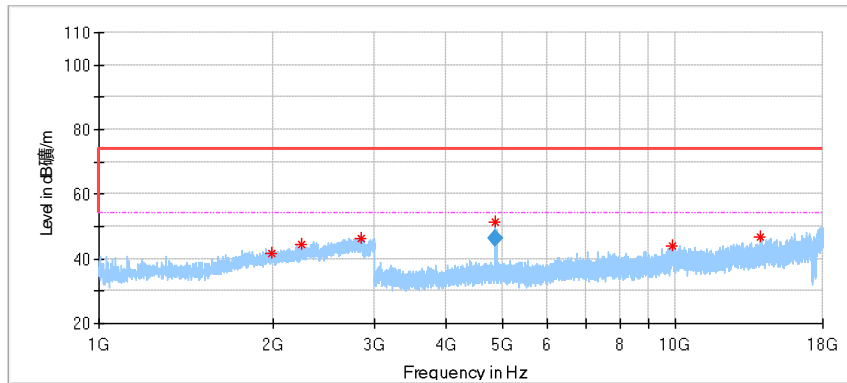

Frequency (MHz)	MaxPeak (dBµV/m)	Limit (dBµV/m)	Margin (dB)	Height (cm)	Pol	Azimuth (deg)	Corr. (dB/m)
1996.666667	41.86	74.00	32.14	150.0	H	69.0	-3.74
2242.380952	44.36	74.00	29.64	150.0	H	77.0	-2.77
2841.904762	46.41	74.00	27.59	150.0	H	290.0	-1.06
4877.500000	51.41	74.00	22.59	150.0	H	268.0	3.70
9873.500000	43.95	74.00	30.05	150.0	H	297.0	11.62
14040.500000	46.88	74.00	27.12	150.0	H	122.0	12.40
Frequency (MHz)	Average (dBµV/m)	Limit (dBµV/m)	Margin (dB)	Height (cm)	Pol	Azimuth (deg)	Corr. (dB/m)
4877.500000	46.50	54.00	7.50	150.0	H	268.0	3.70

Vertical

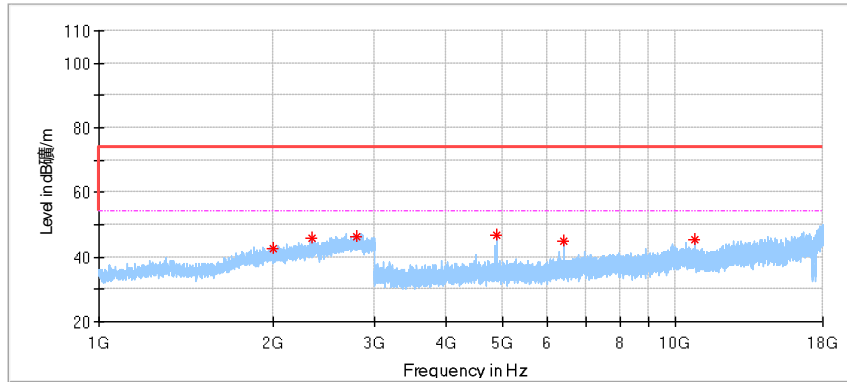

Frequency (MHz)	MaxPeak (dBµV/m)	Limit (dBµV/m)	Margin (dB)	Height (cm)	Pol	Azimuth (deg)	Corr. (dB/m)
2007.142857	42.66	74.00	31.34	150.0	V	282.0	-3.90
2337.142857	46.05	74.00	27.95	150.0	V	326.0	-2.30
2793.809524	46.35	74.00	27.65	150.0	V	114.0	-1.20
4880.500000	46.95	74.00	27.05	150.0	V	325.0	3.68
6377.000000	44.98	74.00	29.02	150.0	V	0.0	6.62
10773.500000	45.23	74.00	28.77	150.0	V	235.0	10.64

11N-HT20-Ant 0_2462MHz
Horizontal:

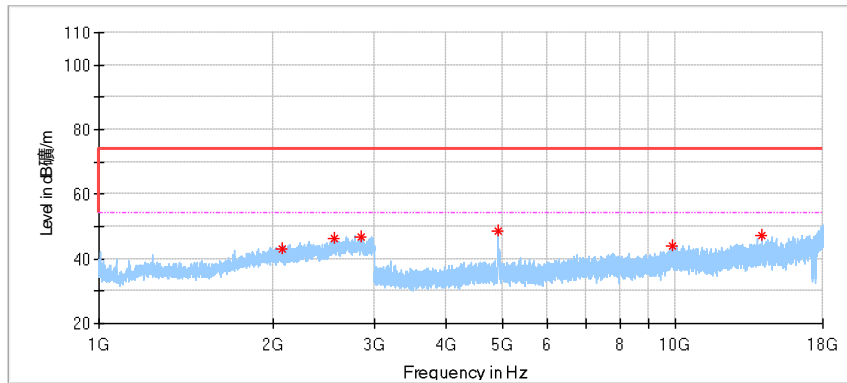

Frequency (MHz)	MaxPeak (dBµV/m)	Limit (dBµV/m)	Margin (dB)	Height (cm)	Pol	Azimuth (deg)	Corr. (dB/m)
2077.619048	43.26	74.00	30.74	150.0	H	342.0	-3.65
2565.238095	46.36	74.00	27.64	150.0	H	63.0	-1.55
2840.476191	46.56	74.00	27.44	150.0	H	13.0	-1.06
4925.000000	48.45	74.00	25.55	150.0	H	238.0	3.58
9849.000000	44.18	74.00	29.82	150.0	H	32.0	11.62
14124.500000	47.33	74.00	26.67	150.0	H	348.0	12.59

Vertical

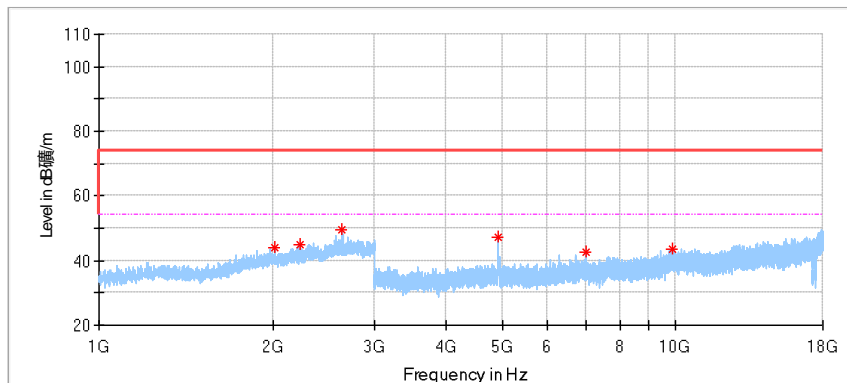

Frequency (MHz)	MaxPeak (dBµV/m)	Limit (dBµV/m)	Margin (dB)	Height (cm)	Pol	Azimuth (deg)	Corr. (dB/m)
2017.142857	43.95	74.00	30.05	150.0	V	104.0	-3.83
2233.333333	45.13	74.00	28.87	150.0	V	246.0	-2.80
2635.714286	49.37	74.00	24.64	150.0	V	347.0	-1.40
4924.500000	47.02	74.00	26.98	150.0	V	322.0	3.58
6999.500000	42.43	74.00	31.57	150.0	V	122.0	7.25
9853.500000	43.57	74.00	30.43	150.0	V	152.0	11.70

Above 18GHz:
11B_2412MHz
Horizontal:

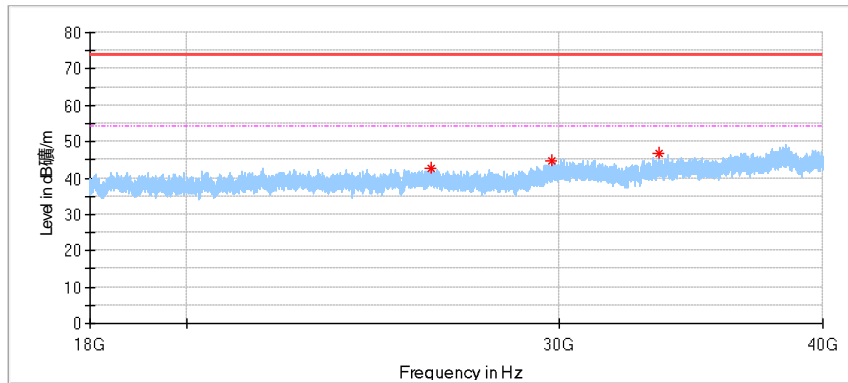

Frequency (MHz)	MaxPeak (dBµV/m)	Limit (dBµV/m)	Margin (dB)	Height (cm)	Pol	Azimuth (deg)	Corr. (dB/m)
26093.250000	42.62	74.00	31.38	150.0	H	216.0	1.55
29787.875000	44.71	74.00	29.29	150.0	H	48.0	1.99
33481.125000	46.72	74.00	27.28	150.0	H	155.0	2.75

Vertical

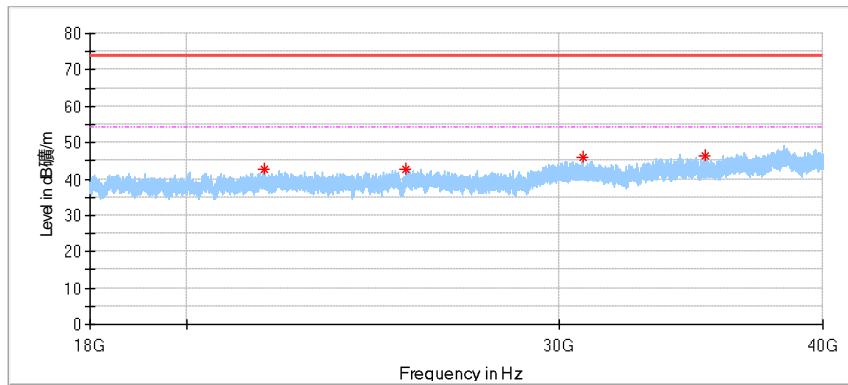

Frequency (MHz)	MaxPeak (dBµV/m)	Limit (dBµV/m)	Margin (dB)	Height (cm)	Pol	Azimuth (deg)	Corr. (dB/m)
21769.562500	42.74	74.00	31.26	150.0	V	158.0	-0.20
25397.500000	42.55	74.00	31.45	150.0	V	0.0	1.34
30788.875000	45.83	74.00	28.17	150.0	V	299.0	1.80
35206.750000	46.22	74.00	27.78	150.0	V	65.0	3.76

11B_2437MHz
Horizontal:

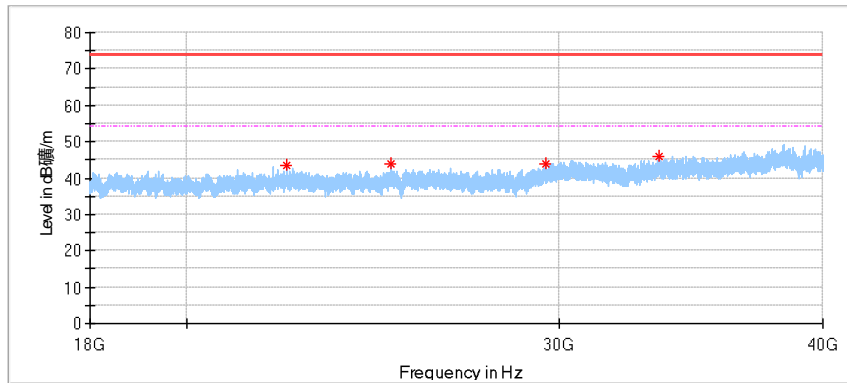

Frequency (MHz)	MaxPeak (dBµV/m)	Limit (dBµV/m)	Margin (dB)	Height (cm)	Pol	Azimuth (deg)	Corr. (dB/m)
22283.812500	43.35	74.00	30.65	150.0	V	31.0	0.31
24976.750000	43.75	74.00	30.25	150.0	V	80.0	1.21
29590.562500	44.04	74.00	29.96	150.0	V	4.0	1.88
33458.437500	46.13	74.00	27.87	150.0	V	267.0	2.71

Vertical

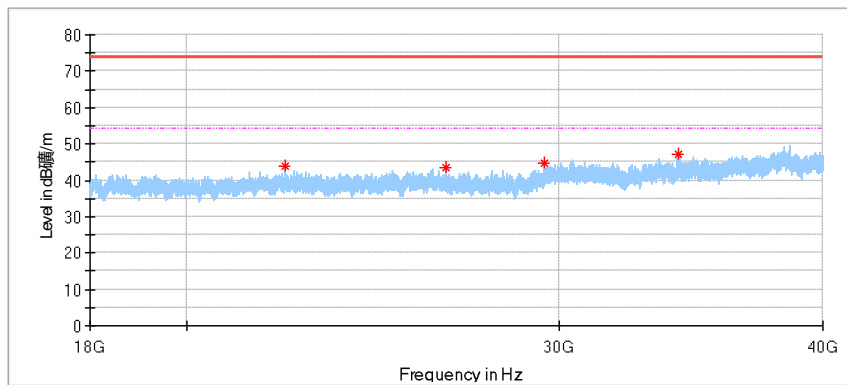

Frequency (MHz)	MaxPeak (dBµV/m)	Limit (dBµV/m)	Margin (dB)	Height (cm)	Pol	Azimuth (deg)	Corr. (dB/m)
22260.437500	43.79	74.00	30.21	150.0	H	231.0	0.29
26544.937500	43.48	74.00	30.52	150.0	H	292.0	1.45
29537.625000	44.57	74.00	29.43	150.0	H	32.0	1.70
34168.625000	47.08	74.00	26.92	150.0	H	1.0	3.34

11B_2462MHz
Horizontal:

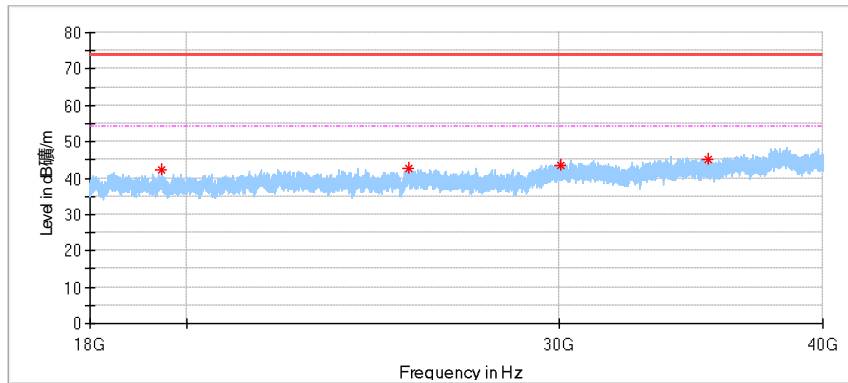

Frequency (MHz)	MaxPeak (dBµV/m)	Limit (dBµV/m)	Margin (dB)	Height (cm)	Pol	Azimuth (deg)	Corr. (dB/m)
19447.875000	42.18	74.00	31.82	150.0	H	356.0	-2.43
25470.375000	42.73	74.00	31.27	150.0	H	248.0	1.45
30057.375000	43.45	74.00	30.55	150.0	H	345.0	2.04
35305.750000	45.00	74.00	29.00	150.0	H	232.0	3.72

Vertical

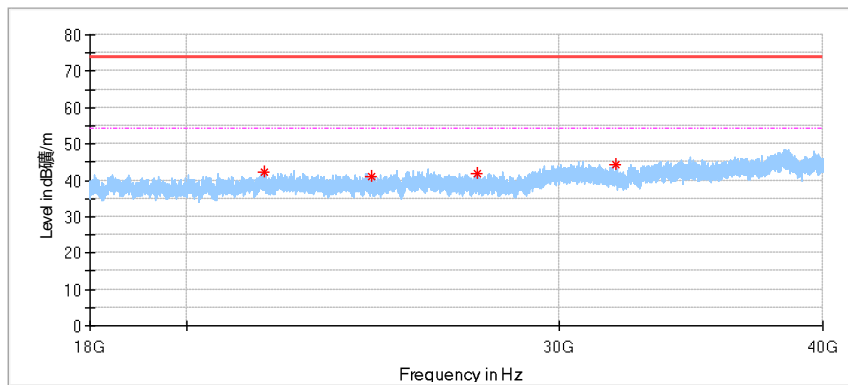

Frequency (MHz)	MaxPeak (dBµV/m)	Limit (dBµV/m)	Margin (dB)	Height (cm)	Pol	Azimuth (deg)	Corr. (dB/m)
21746.875000	42.10	74.00	31.90	150.0	V	128.0	-0.19
24469.375000	40.84	74.00	33.16	150.0	V	82.0	0.70
27460.000000	41.99	74.00	32.01	150.0	V	219.0	1.64
31923.250000	44.42	74.00	29.58	150.0	V	82.0	1.67

10 Test Equipment List

Radiated Emission Test

DESCRIPTION	MANUFACTURER	MODEL NO.	EQUIPMENT ID	SERIAL NO.	CAL INTERVAL (YEAR)	CAL. DUE DATE
EMI Test Receiver	Rohde & Schwarz	ESR 26	68-4-74-14-002	101269	1	2022-6-4
Trilog Super Broadband Test Antenna	Schwarzbeck	VULB 9162	68-4-80-19-003	284	1	2023-1-17
Wave Guide Antenna	ETS	3117	68-4-80-19-001	00218954	1	2022-5-24
Pre-amplifier	Rohde & Schwarz	SCU 18F	68-4-29-19-001	100745	1	2022-10-10
Pre-amplifier	Rohde & Schwarz	SCU 18F	68-4-29-19-002	100746	1	2022-10-10
Sideband Horn Antenna	Q-PAR	QWH-SL-18-40-K-SG	68-4-80-14-008	12827	1	2022-7-21
Pre-amplifier	Rohde & Schwarz	SCU 40A	68-4-29-14-002	100432	1	2022-7-27
Attenuator	Mini-circuits	UNAT-6+	68-4-81-21-002	15542	2	2022-8-23
3m Semi-anechoic chamber	TDK	SAC-3 #2	68-4-90-19-006	----	N/A	2023-5-28

Conducted RF Test System

DESCRIPTION	MANUFACTURER	MODEL NO.	EQUIPMENT ID	SERIAL NO.	CAL INTERVAL (YEAR)	CAL. DUE DATE
Signal Analyzer	Rohde & Schwarz	FSV40	68-4-74-14-004	101030	1	2022-6-3
RF Switch Module	Rohde & Schwarz	OSP120/OS P-B157	68-4-93-14-003	101226/100851	1	2022-6-3
Power Splitter	Weinschel	1580	68-4-85-14-001	SC319	1	2022-6-3
10dB Attenuator	Weinschel	4M-10	68-4-81-14-003	43152	1	2022-6-3
10dB Attenuator	R&S	DNF	68-4-81-14-004	DNF-001	1	2022-6-3
10dB Attenuator	R&S	DNF	68-4-81-14-005	DNF-002	1	2022-6-3
10dB Attenuator	R&S	DNF	68-4-81-14-006	DNF-003	1	2022-6-3
10dB Attenuator	R&S	DNF	68-4-81-14-007	DNF-004	1	2022-6-3
Test software	Tonscend	System for BT/WIFI	68-4-74-14-006-A13	Version 2.6.77.0518	N/A	N/A
Shielding Room	TDK	TS8997	68-4-90-19-003	----	1	2022-11-07

11 System Measurement Uncertainty

For a 95% confidence level, the measurement expanded uncertainties for defined systems, in accordance with the recommendations of ISO 17025 were:

System Measurement Uncertainty	
Test Items	Extended Uncertainty
Uncertainty for Radiated Spurious Emission 25MHz-3000MHz	Horizontal: 4.70dB; Vertical: 4.67dB;
Uncertainty for Radiated Spurious Emission 3000MHz-18000MHz	Horizontal: 4.65dB; Vertical: 4.63dB;
Uncertainty for Radiated Spurious Emission 18000MHz-40000MHz	Horizontal: 5.05dB; Vertical: 5.04dB;
Uncertainty for Conducted RF test with TS 8997	RF Power Conducted: 1.16dB Frequency test involved: 0.6×10^{-7} or 1%
Uncertainty Evaluation for Humidity	0.936%
Uncertainty Evaluation for Temperature	0.195 °C