

Cabin Series Operating Manual

V1.0

InfiRay Technologies Co., Ltd.

Specifications

| Model | CAD25 |
|----------------------------------------------------------|--------------------------------------------|
| Detector Specifications | |
| Type | CMOS |
| Resolution | 1440×1080 |
| Pixel size, μm | 4 |
| Frame Rate, Hz | 50 |
| Optical Specifications | |
| Objective Lens, mm | 22/25 |
| FOV | 13.1 °×9.9 ° |
| Visual Magnification, × | 2-8 |
| Digital Zoom, × | 1-4 |
| Eye Relief, mm | 30 |
| Focusing range of eyepiece, D | -5 ~ +5 |
| Detection Range, m (Target size: 1.7m×0.5m, P(n)=99%) | 200 |
| Display Specifications | |
| Type | LCOS |
| Resolution | 1280×960 |
| Battery Power Supply | |
| Battery type/Capacity/Output voltage | Lithium-ion battery pack IBP-2/3.1Ah /3.6V |
| Operating time (22 °C), h* | 8+ |
| External Power Supply | 5V (Type C) |
| Physical Specifications | |
| Ingress Protection Rating | IP66 |
| Memory Capacity, GB | 16 |
| APP | Supported |
| Operating Temperature, °C | -20~+50 |
| Weight (exclusive of battery pack), g | <380 |
| Dimension, mm | 165×50×85 |

*Actual operation time depends on the density of Wi-Fi use and video recording functions;

Improvements may be made to the design and software of this product to enhance its features without prior notice;

You can download this Manual at our official website: www.infrayoutdoor.com.

I. Package Contents

- Cabin series digital night vision device
- Wrist strap
- Strap
- Portable bag
- IBC-2 power adapter
- Adapter clamp
- IBP-2 battery pack
- Type-C USB cable
- Power adapter
- Lens cleaning cloth

II. Description:

The Cabin series digital night vision device is a multi-function night vision device for outdoor use. It is both a handhold device for independent usage and a night vision rear attachment. The Cabin series is lightweight, compact and easy to carry, and can be operated with one hand. The battery can be quickly removed. Its well-designed features bring you good user experience. With a built-in fill-in light, it can be widely applied to hunting, searching, and locating under extremely low illuminations.

III. Product Features

- Starlight low illuminance CMOS;
- High image quality;
- Lightweight and compact;
- Large HD display
- Quickly removable battery pack;
- Zooming fill-in light;
- Stadiametric rangefinding;
- Long detection distance;
- Built-in memory card, supporting photo taking and video recording
- Built-in Wi-Fi module, supporting app connection
- Built-in digital magnetic compass and motion sensor;

- PIP (picture-in-picture) function;

- Convenient operation interface

IV. Device Composition

1. Lens cap
2. Laser pointer
3. Fill-in Light
4. Type-C interface
5. Power button
6. Up button (zoom button)
7. M button (menu button)
8. Down button (camera button)
9. Eye cup
10. Eyepiece focusing ring
11. Power indicator
12. Objective lens focus knob
13. Battery pack

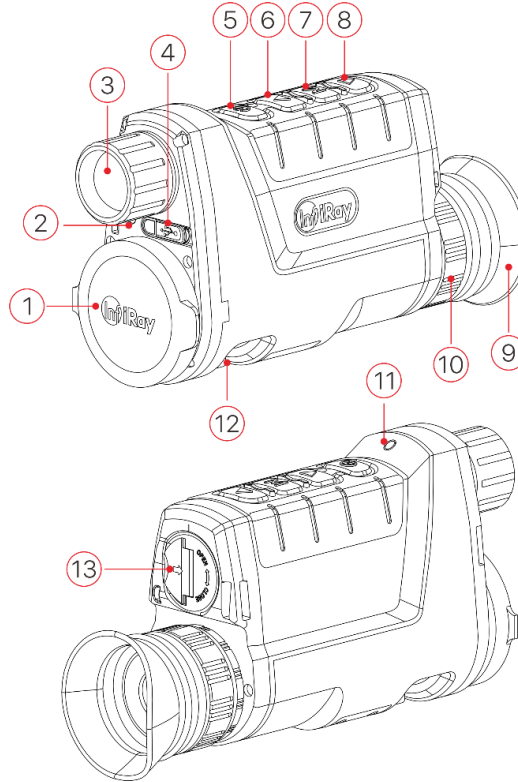

V. Button Operations

| Button | Device Status/Current Operation Mode | Press | Press and Hold |
|--------------|---------------------------------------------|---------------------------------------------|----------------------|
| Power button | Powered off | — | Power on the device |
| | Home screen | Standby | Shut down the device |
| | Standby | Wake up the device | — |
| | Main menu interface/Shortcut menu interface | Exit the main menu/Return to the upper menu | — |

| | | | |
|----------------------------------------|------------------------------------|---------------------------------------------------------------|------------------------------------------|
| M button (Menu button) | Home screen | Open the shortcut menu | Open/Exit the main menu |
| | Shortcut Menu | Adjust specific parameters of a function | Exit the shortcut menu |
| | Main menu interface | Adjust specific parameters of a function/Go to the next level | Save and go back to the home screen |
| | Reticle position adjustment screen | Enable/disable the cursor movement function | Save and exit |
| Up button (Zoom button) | Home screen | Visual amplification adjustment: 2×-8× | Turn PIP on/off |
| | Shortcut menu/main menu | Navigate upwards with the menu | — |
| | Laser cursor calibration | Move cursor left | Quickly move cursor left |
| Down button (Camera button) | Home screen | Photographing | Start/Stop video recording |
| | Video Recording | Photographing | Stop recording and save the video |
| | Shortcut menu/main menu | Navigate downwards with the menu | — |
| | Reticle position adjustment screen | Move cursor right | Quickly move cursor right |
| Up button + M button | Home screen | Turn the laser on/off | Turn on/off the stadiametric rangefinder |
| Down button + M button | Home screen | Turn on/off or adjust the infrared lamp | — |

VI. Battery Charging

The Cabin series is supplied with a quickly removable 18650 Li-ion battery pack, which enables the device to be used for up to 8 hours. The battery should be fully charged before first use.

Method 1: Type C Charging

- Align the orange vertical line on the battery pack with that next to the battery holder of the Cabin night vision device, and install the battery pack into the battery holder. For details see **Battery Pack**

Installation;

- Connect the Type-C interface (18) of the cable to the Type-C interface (4) of the device;
- Connect the other interface to the power adapter (19) of the device, or a USB power socket with a rated voltage of 5V or lower;
- Insert the adapter to a 100-240V power socket (20) for charging.

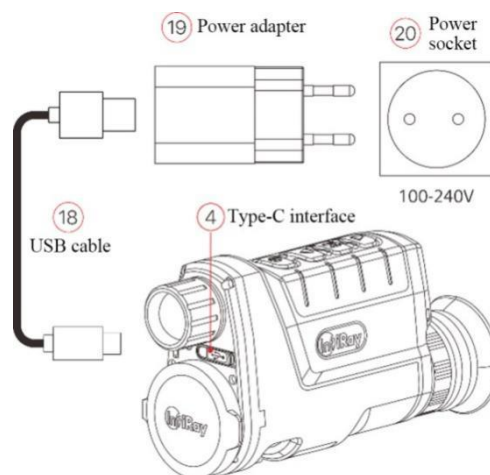

Method 2: Charging with the Battery Holder

- Align the position block (A) of the battery pack with the groove (B) of the battery charging holder, and insert the battery pack (13) into the battery holder (15);
- Connect the Type-C interface of the cable (18) to the Type-C interface (16) of the device;
- Connect the other end of the data cable to the power adapter (19), and insert the adapter into a 100-240V power socket (20) to charge the battery pack;
- After the above steps are finished, the LED indicator (17) on the battery holder will light up or blink:
 - ● Battery charging capacity 1%-25%

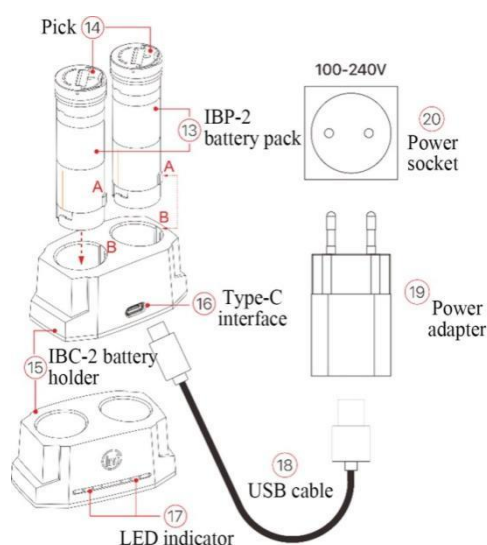

- ●○ Battery charging capacity 25%-50%
- ●●○ Battery charging capacity 50%-75%
- ●●●○ Battery charging capacity 75%-99%
- ●●●● Fully charged
- After the battery is fully charged, remove the battery pack from the battery holder.

Note: This battery holder can charge two IBP-2 battery packs at the same time.

Battery Pack Installation

- Turn up the pick (14) on the battery pack, align the orange line (D) on the battery pack with the orange line (C) above the battery holder, and push the battery pack (13) into the battery holder (21);
- When the battery pack is fully inserted into the battery holder, rotate the pick (14) clockwise to lock the battery pack;
- Close the pick (14) to complete the battery pack installation;
- The Cabin series can only be powered by this battery pack. If other batteries are used, it may cause irreparable loss, damage the device, and even may cause fire.

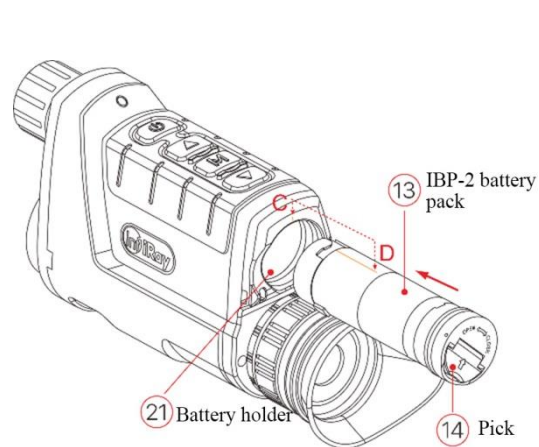

Safety Measures

- Use this battery holder to charge the battery pack only. Otherwise it will cause irreparable damage to the battery pack or holder and even may cause fire.
- After a long storage time, the battery pack should be partially charged, not fully charged or discharged;
- Do not charge the device immediately after it is moved to a warm environment from a cold environment. Wait for 30 to 40 minutes for preheating.
- If the charger is modified or damaged, do not use it;

- The device should be charged at a temperature of 0 °C to +45 °C. Otherwise, the battery life will be significantly reduced.
- When charging, please do not leave the battery unattended;
- Do not expose the battery to high temperature or open flame;
- Do not immerse the battery in water;
- The battery pack is equipped with a short circuit protection function, but situations that may lead to short circuits should be avoided;
- Do not connect the battery to the power supply for more than 24 hours after it is already fully charged;
- It is not recommended to connect third-party devices that consume more energy than the allowed value.
- Please do not disassemble or modify the battery pack without professional instructions; Do not knock or drop the battery pack;
- The recommended operating temperature for the device is -20 °C to +50 °C. Do not use the device beyond this temperature range, or else, it may shorten the battery life.
- When the device is used under sub-zero temperature, the battery capacity drops. This is normal and does not indicate a defect.
- Please keep the battery pack out of the reach of children.

VII. External Power Supply

The Cabin series supports external power supplies, such as the portable power source (5V).

- Connect the external power supply to the Type-C interface (4) of the device;
- The device will automatically switch to the external power supply and charge the internal battery pack at the same time;
- Then, the battery icon on the display will change to the charging icon , and the power indicator turns red. When the battery pack is fully charged, the indicator turns green;
- If the device is connected to an external power source and no battery pack is installed, the

battery icon will be changed to the USB icon , and the power indicator is green;

- When the external power supply is disconnected, the Cabin series device will automatically switch to the battery pack and will not shut down.

VIII. Installation and Usage

Operation

WARNING! The lens must not be pointed at any sources of intense radiation energy, such as laser-emitting devices or the sun. This may damage the electronic components in the device. Damage caused by failure to comply with the operating guidelines is not covered under warranty.

- Remove the **lens cap (1)**. Press and hold the **power button (5)** for 2s to power on the device. Then, the home screen appears after 3s.
- Rotate the eyepiece **focusing ring (10)** of the objective lens until the image becomes clear in the eyepiece. After the adjustment, it no longer needs to be adjusted for the same user;
- Rotate the **objective lens focus knob (12)** to adjust the focal length, to focus on the object to be observed;
- Setting the image mode: Press the **M button (7)** to enter the shortcut menu and set the image palette mode. The options are the day mode and night mode. The icon on the lower-left status bar is updated in real-time;
- Configure the digital zoom, image mode, display brightness, image contrast, image sharpness, and so on (for details, see **Shortcut Menu Functions** in this manual);
- After using the device, press and hold the **Power button (5)**. Then, the shutdown countdown screen appears. When the countdown counts from 3 to 0, the device shuts down. Then, you can release the Power button. The current status will be automatically saved after shutdown. **When the device is powering off and saving data, do not**

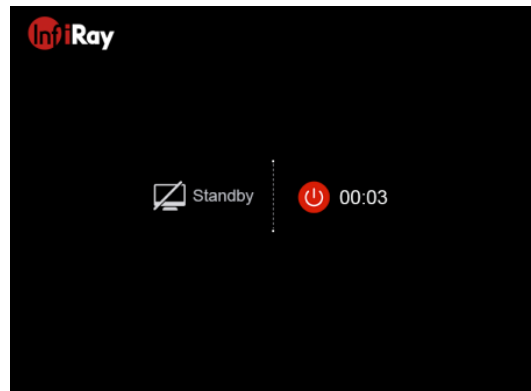

disconnect it from the power source. Otherwise, the data cannot be saved.

- Before the countdown ends, you can release the button to return to the home screen.

IX. Digital Zoom

The Cabin series supports 1-4 times magnification of images to increase visual magnification.

- On the home screen, press the **Up button (6)** in a circular manner to circularly zoom the image;
- The corresponding visual magnification is displayed on the status bar on the top;
- The visual amplification corresponding to 1-4 times magnification of the CAD22 (CAD25) series is 2×, 4×, 6×, and 8×;

XI. Photo Taking and Video Recording

The Cabin series is equipped with a built-in 16 GB memory card, which allows photo taking and video recording. The image and video files recorded will be named after time and stored in the memory, so it is recommended to set the system date and time in the main menu ("**Main Menu - Settings - Date**"), or synchronize the system date and time in the settings page of the app before photo taking and video recording. For specific steps, see the operating instructions for the app that can be downloaded from our official website.

Photographing

- On the home screen, press the **Down button (8)** to take a photo. The image freezes for 0.5s and a photographing icon flashes on the upper left corner. After the image is taken, the icon disappears;
- The images taken are saved in the built-in memory space.

Video Recording

- On the home screen, press and hold the **Down button (8)** to start the video recording;
- A recording icon and a prompt box showing the recording time will appear in the upper

right corner of the display, with the time format as 00:00:00 (hours: minutes: seconds);

- During recording, you can also take a photo by pressing the **Down button (8)**;
- Stop the recording and save the video by pressing and holding the **Down button (8)**;
- The videos and images taken are saved in the built-in memory space.

Note:

- The menu can still be operated during video recording;
- The images taken and the videos recorded are stored in the built-in memory card in the format of IMG_HHMMSS_XXX.jpg (image) and VID_HHMMSS_XXX.mp4 (video), with HHMMSS indicating hours/minutes/seconds and XXX indicating the serial number of the three-digit multimedia file;
- The serial number of the multimedia files cannot be reset.

Note:

- The maximum duration of a video recording file is 10 minutes. When the duration is more than 10 minutes, the video will be automatically recorded onto a new file;
- You can operate the menu during video recording;
- Due to the limitation of the storage space, it is recommended that you clean the memory regularly or move the images and videos to other storage medium to release memory space of the device.
- The interface icon information is not displayed on the captured video or image.

Memory Access

When the device is powered on and connected to a computer, it will be recognized by the computer as a flash memory card. Then, you can access the memory of the device and copy images and videos.

- Connect the device to a computer through the data cable;
- Start-up the device;





- Double-click "My Computer" , double-click to open the device named

"Infiray" , and then double-click to open the device name "Internal Storage" to access the memory;

- Open the memory file, and there are different folders named after time in the format of xxxx (year) xx (month) xx (day) in it;
- The folders store the videos/images captured on the corresponding days. To copy or delete files or folders, select accordingly.

XII. Status Bar

The status bar is located at the top of the image interface and displays the information related to the current operating status of the device. From left to right, there are:

1. Current image mode (☀: Day mode; 🌙: Night mode)
2. Visual magnification (such as 2.0×)
3. Fill-in light status (disabled by default)
4. Compass (not displayed when the compass is turned off)
5. Automatic standby (displayed when the function is enabled)
6. Wi-Fi status (🚫: Wi-Fi is off; 📶: Wi-Fi is on)
7. Clock (set in the main menu or synchronize the time in the InfiRay Outdoor App)
8. Power status of the battery pack (When the inside of the icon is in green , it means that the power is higher than 20%; When it is in red , it means that the battery power is low, please charge it in time; When a lightning sign  appears in the middle of the icon, it indicates that the external power supply is powering the device and this icon will be displayed as a USB icon.)

XIII. Shortcut Menu



The shortcut menu can be used for a quick setup of the basic settings of some common functions, including image mode, screen brightness, image sharpness, and image contrast.

- On the home screen, press the **Menu button (7)** to go to the shortcut menu interface;
- Press the **Up button (6)** and **Down button (8)** to switch between the following functions;

- **Image mode:** After selecting this option, press the **Menu button (7)** to circularly switch among image modes in a sequence of day mode and night mode;
- **Screen brightness:** After selecting this option, press the **Menu button (7)** to adjust the screen brightness among 1-5 levels;
- **Image sharpness:** After selecting this option, press the **Menu button (7)** to adjust the image sharpness among 1-5 levels;
- **Image contrast:** After selecting this option, press the **Menu button (7)** to adjust the image contrast among 1-5 levels;
- Press and hold the **Menu button (7)** to save the changes and return to the home screen.



Note: In the shortcut menu, if there is no operation within 5s, the device will automatically save the changes and return to the home screen.



XIV. Main Menu



- On the home screen, press and hold the **M button (7)** to go to the main menu;
- Press the **Up button (6)** or **Down button (8)** to switch between menu options;
- The function options of the main menu are cyclical: When the cursor  reaches the last menu option on the first page, it will start from the first menu option on the second page; When the cursor  stays at the first option on the first page, you can press the **Up button (6)** to jump directly to the last menu option on the second page;
- Press the **M button (7)** to modify the parameters of the current option or go to the next level of the menu;
- The position of the cursor  indicates the selected option, the icon of which will change from white to blue;
- The operation of secondary and tertiary menus is the same as above;
- In any menu screen, press and hold the **M button (7)** to save the changes and return to the home screen. Press the **Power button (5)** to return to the upper menu without saving the change;
- In any menu screen, the device will automatically return to the home screen when there is no operation within 15s.

- During the continuous operation of the thermal imager, when exiting from the main menu, the cursor  remains at the position before exiting. When you restart the thermal imager and go to the main menu for the first time, the cursor stays at the first menu option.

Composition and Description of Main Menu

| | |
|-----------------------------------------------------------------------------------------------------------------------|------------------------------------------------------------------------------------------------------------------------------------------------------------------------------------------------------------------------------------------------------------------------------------------------------------------------------------------------------------------------------------------------------------------------------------------------------------------------------------------------------------------------------------------------------------------------------------------------------------------------|
| <p>Wi-Fi</p>  | <p>Enabling/Disabling Wi-Fi</p> <ul style="list-style-type: none"> ● Press and hold the M button (7) to open the main menu; ● Press the Up button (6) or Down button (8) to select the "Wi-Fi" function option; ● Press the M button (7) to enable/disable Wi-Fi; ● The icon in the status bar changes accordingly after this mode is turned on or off. |
| <p>Digital Compass</p>  | <p>Enabling/Disabling the digital compass</p> <ul style="list-style-type: none"> ● Press and hold the M button (7) to open the main menu; ● Press the Up button (6) or Down button (8) to select the "Digital Compass" function option; ● Press the M button (7) to enable or disable the digital compass; ● After the digital compass is enabled, its icon will be displayed in the middle of the status bar on the top. |
| <p>Motion Sensor</p>  | <p>Enabling/Disabling the motion sensor</p> <ul style="list-style-type: none"> ● Press and hold the M button (7) to open the main menu; ● Press the Up button (6) or Down button (8) to select the "Motion Sensor" function option; ● Press the M button (7) to enable or disable the motion sensor; ● After the motion sensor is enabled, its functions will be displayed on both sides of the screen; ● The curved ruler on the left represents the tilt angle and the vertical ruler on the right represents the pitch angle. |
| <p>Exposure</p> | <ul style="list-style-type: none"> ● Press and hold the M button (7) to open the main menu; |

| | |
|-------------------------------------------------------------------------------------------------------------------------------|-------------------------------------------------------------------------------------------------------------------------------------------------------------------------------------------------------------------------------------------------------------------------------------------------------------------------------------------------------------------------------------------------------------------------------------------------------------------------------------------------------------------------------------------------------------------------------------------------------------------------------------------------------------------------------------------------------------------------------------------------------------------------------------------------------------------------------------------------------------------------------------------------------------------------------------------------------------------------------------------------------------------------------------------------------------------------------------------------------------------------------------------------------------------------------------------------------------------------------------------------------------------------------------------------------------------------------------------------------------------------------------------------------------------------------------------------------------------------------------------------------------------------------------------------------------------------------------------------------------------------------------------------------------|
| <p>Compensation</p>  | <ul style="list-style-type: none"> ● Press the Up button (6) or Down button (8) to select the "Exposure Compensation" function option; ● Press M button (7) to go to the "Exposure Compensation" function option screen; ● Press the Up button (6) or Down button (8) to adjust the exposure compensation value as required; ● After finishing moving the cursor, press the M button (7) to save the setting and exit. The icon stops blinking. |
| <p>Reticle Position Adjustment</p>  | <p>When the position of the cross center of the day scope is inconsistent with the position of the infrared cross cursor shown on the device (that is, the digital zoom center position), you can use this function to adjust the position of the infrared cursor so that the center position of the cross reticle for day scope becomes the digital zoom center of the screen.</p> <ul style="list-style-type: none"> ● Press and hold the M button (7) to open the main menu; ● Press the Up button (6) or Down button (8) to select the "Reticle Position Adjustment" function option; ● Press M button (7) to go to the "Reticle Position Adjustment" function option screen; ● The red cross cursor appears in the middle of the screen and the prompts shown in the following figure are displayed in the upper left corner: <ul style="list-style-type: none"> - X indicates the X-axis in the horizontal direction; - Y indicates the Y-axis in the vertical direction; - Center allows the cursor to return to the center of the screen; ● Press the Up button (6) or Down button (8) to switch over between options. Press the M button (7) to confirm the selection; ● When selecting the X or Y axis, the icon of the selected option will keep blinking. Press the Up button (6) or Down button (8) to move the red cursor. If you press the Up button (6), the red cursor will move leftward or upward. If you press the Down button (8), the red cursor will move |

| | |
|-------------------------------------------------------------------------------------------------------------------------------------------------------|------------------------------------------------------------------------------------------------------------------------------------------------------------------------------------------------------------------------------------------------------------------------------------------------------------------------------------------------------------------------------------------------------------------------------------------------------------------------------------------------------------------------------------------------------------------------------------------------------------------------------------------------------------------------------------------------------------------------------------|
| | <p>rightward or downward. One press moves a pixel and pressing and holding for one time moves the red cursor by 10 pixels each time;</p> <ul style="list-style-type: none"> ● After finishing moving the cursor, press the M button (7) to save the setting and exit. The icon X ↔ or Y ↑ stops blinking; ● When Center is selected, press the M button (7) to return the red cursor to the original default position; ● After moving the red cursor to overlap with the day scope cross center, press and hold the M button (7) to save the change, the screen will display the words “Successfully saved”, and return to the main menu screen. |
| <p style="text-align: center;">Compass Calibration</p>  | <p>Calibrating the digital compass</p> <ul style="list-style-type: none"> ● Press and hold the M button (7) to open the main menu; ● Press the Up button (6) or Down button (8) to select the "Compass Calibration" function option; ● Press the M button (7) to go to the Compass Calibration screen. The calibration icon will be displayed; ● Rotate the device along the three axes indicated by the icon, with each axis rotating at least 360 °; ● The calibration ends after 15s by default and the screen closes automatically. |
| <p style="text-align: center;">Standby</p>  | <p>Setting the standby state and duration</p> <ul style="list-style-type: none"> ● Press and hold the M button (7) to open the main menu; ● Press the Up button (6) or Down button (8) to select "Standby"; ● Press the M button (7) to enable/disable the standby function (after enabling, if there is no operation within 15 minutes, the device will switch to standby mode automatically); ● The icon in the status bar changes accordingly after this mode is turned on or off. |
| <p style="text-align: center;">Settings</p> | <p>This function is used to set the date, time, language, status auto-hiding, factory reset, and device information query.</p> |



- Press and hold the **M button (7)** to open the main menu;
- Press the **Up button (6)** or **Down button (8)** to select "Settings".

Date



Setting the system date



- Press the **M button (7)** to open the secondary menu of "Settings";
- Press the **Up button (6)** or **Down button (8)** to select "Date";
- Press the **M button (7)** to activate the date reset function, with the date in the format of YY/MM/DD;
- Press or press and hold the **Up button (6)** or **Down button (8)** to set the correct year, month and date;
- Press the **M button (7)** to switch between year, month and date;
- After the setting is completed, press and hold the **M button (7)** to save changes and exit.

Time



Setting the system time

- Press the **M button (7)** to open the secondary menu of "Settings";
- Press the **Up button (6)** or **Down button (8)** to select "Time". The 24-hour system is used with the hour and minute displayed.
- Press the **M button (7)** to activate the time reset function;
- Press the **Up button (6)** or **Down button (8)** to set the correct hour and minute;
- Press the **M button (7)** to switch between the hour and minute;
- After the setting is completed, press and hold the **M button (7)** to save changes and exit;
- After setting time, the time in the status bar changes

| | | |
|--|------------------------------------------------------------------------------------------------------------------|-----------------------------------------------------------------------------------------------------------------------------------------------------------------------------------------------------------------------------------------------------------------------------------------------------------------------------------------------------------------------------------------------------------------------------------------------------------------------------------------------------------------------------------------------------------------------------------------|
| | | accordingly. |
| | Language  | Selecting the language <ul style="list-style-type: none"> ● Press the M button (7) to open the secondary menu of "Settings"; ● Press the Up button (6) or Down button (8) to select "Language"; ● Press the M button (7) to open the secondary menu for language selection; ● Press the Up button (6) or Down button (8) to switch between English and simplified Chinese; ● Press the M button (7) to confirm and save the selection, and return to the menu screen. |
| | Status Auto Hiding  | Enabling/Disabling status auto hiding <ul style="list-style-type: none"> ● Press the M button (7) to open the secondary menu of "Settings"; ● Press the Up button (6) or Down button (8) to select "Status Auto Hiding"; ● Press the M button (7) to open the secondary menu for status auto hiding; ● Press the Up button (6) or Down button (8) to select On or Off; ● Press the M button (7) to confirm the selection, and return to the main menu screen. |
| | Factory Reset  | Restoring factory default settings <ul style="list-style-type: none"> ● Press the M button (7) to open the secondary menu of "Settings"; ● Press the Up button (6) or Down button (8) to select "Factory Reset"; ● Press the M button (7) to open the secondary menu for |

| | | |
|--|--------------------------------------------------------------------------------------------------------|--------------------------------------------------------------------------------------------------------------------------------------------------------------------------------------------------------------------------------------------------------------------------------------------------------------------------------------------------------------------------------------------------------------------------------------------------------------------------------------------------------------------------------------------------------------------------------------------------------------------------------------------------------------------------------------------------------------------------------------------------------------------------------------------------------------------------------------------------------------------------------------------------------------------------------------------------------------------------------------------------------------------------------|
| | | <p>factory reset;</p> <ul style="list-style-type: none"> ● Press the Up button (6) or Down button (8) to select "Yes" for restoring factory settings or "No" for canceling the operation; ● Press the M button (7) to confirm the selection; ● If "Yes" is selected, the device will shut down automatically; ● If "No" is selected, the operation is canceled and returns to the upper menu. <p>After the Factory Reset is selected, the following functions will be restored to default settings:</p> <ul style="list-style-type: none"> - Image Mode: Day - Optical Magnification: 2.0 × - Brightness: 3 - Contrast: 1 - Sharpness: 1 - Infrared fill-in light: Off - Compass: Off - Standby: Off - Wi-Fi: Off - Motion Sensor: Off - Language: English - Status Auto Hiding: Off - Date: January 1, 2020 - Time: 00:00. |
| | <p>Info</p>  | <p>Querying device information</p> <ul style="list-style-type: none"> ● Press the M button (7) to open the secondary menu of "Settings"; ● Press the Up button (6) or Down button (8) to select |

| | | |
|--|--|-----------------------------------------------------------------------------------------------------------------------------------------------------------------------------------------------------------------------------------------------------------------------------------|
| | | <p>"Info";</p> <ul style="list-style-type: none"> ● Press the M button (7) to query the relevant information about the current device; ● Press the M button (7) or the Power button (5) to exit and return to the upper menu. |
|--|--|-----------------------------------------------------------------------------------------------------------------------------------------------------------------------------------------------------------------------------------------------------------------------------------|

XV. PIP Function

Picture-in-Picture (PIP) provides a floating window independent of the full screen. This window shows part of the image which is enlarged to 2× in a certain area centered on the reticle of the main image.

- On the home screen, press and hold the **Up button (6)** to enable or disable PIP.
- After enlarging the image on the home screen by pressing the **Up button (6)**, the image shown in the PIP window is also enlarged to 2×. For example, if the image on the home screen is enlarged by 2.0×, 4.0×, 6.0×, or 8.0×, the image shown in the PIP window will be enlarged by 4.0×, 8.0×, 12.0×, or 16.0×, respectively.

XVII. Stadiametric Rangefinding

The Cabin series provides stadiametric rangefinding, which allows you to calculate the approximate distance from a target with a known size. This function cannot be used when a day scope is connected.

- On the home screen, press and hold **the Up button (6) + M button (7)** to enable or disable this function;
- After this function is enabled, two lines used for measuring appear in the middle part of the image, and three icons of pre-configured objects and the values of measurement distance are displayed on the right side.
- Three pre-defined target values are provided as follows:



- Deer: 1.7m high
- Wild boar: 0.9m high
- Hare: 0.2m high



- Adjust the device to move the target in the center of the display area. Press or press and hold the **Up button (6)** to enlarge or **Down button (8)** to reduce the width between the measurement lines, so that the target is completely between the measurement lines. While adjusting the width between the measurement lines, the rangefinding data on the left changes accordingly;
- If you want to change the units of measure, press the **M button (7)**;
- Press and hold the **Up button (6) + M button (7)** to exit this function.

XVIII. Infrared Light ON/OFF

The Cabin series products are equipped with fill-in lights, which can be quickly turned on, adjusted levels of brightness, and turned off.

- LED lights are off by default. Press the **Down button (8) + M button (7)** to turn on the LED lights. At this point, the brightness is in the second level, and the LED icon in the status bar is displayed as .
- Press the **Down button (8) + M button (7)** again, the brightness level changes to level one, and the icon in the status bar is displayed as .
- Press the **Down button (8) + M button (7)** again to turn off the LED lights, and the icon in the status bar is displayed as .

XXI. Wi-Fi

The Cabin series has a built-in Wi-Fi module. The device can connect wirelessly to a mobile apparatus (laptops or smartphones) via Wi-Fi.

- In the main menu, enable Wi-Fi. For detailed operations, refer to "**Main Menu-Wi-Fi**".

- After the Wi-Fi of the device is enabled, search for the Wi-Fi signal with the name "CAD22 (CAD25) _XXXXXX" on the mobile device, among which XXXXXX is a 6-bit serial number composed of digits and letters.
- Select the Wi-Fi, enter the password and connect. The initial password is 12345678;
- After Wi-Fi access, you can control the device via the mobile app.

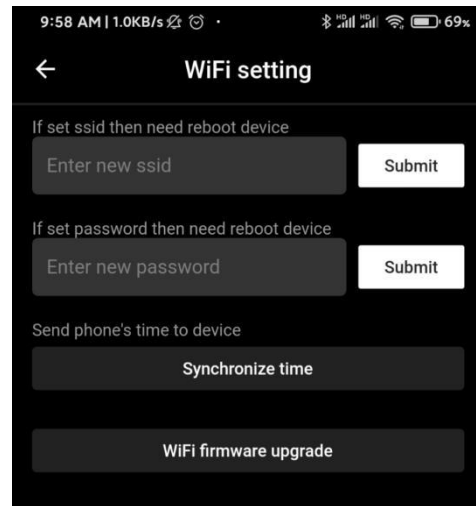

Setting Wi-Fi name and password

The Cabin series allows you to change the name and password of the device Wi-Fi in the app.

- After the device is connected to the mobile device, locate the "Settings" icon  in the **InfiRay Outdoor** image screen and tap it to open the "Settings" screen;
- In the text box, enter and submit the new Wi-Fi name (SSID) and password;
- After submitting the change, reset the device to activate the setting.

Caution! After the device is restored to the factory setting, the name and password of the Wi-Fi will also be restored to the default factory setting.

XXII. Product Update and Description to APP

The Cabin series thermal imager supports control with an app. You can transmit images in real time, operate the device, and update the program by connecting a smartphone or laptop via Wi-Fi.

You can download the user manual of InfiRay Outdoor at our official website (www.infirayoutdoor.com).

You can also test and update the firmware program of the product via the InfiRay Outdoor app or download it on our official website.

About InfiRay Outdoor

- You can download and install the InfiRay Outdoor app on the official website (www.infirayoutdoor.com) or an app store. Alternatively, you can scan the QR code below to download it for free.



- After installing the app, open it.
- If your device has been connected to a mobile device, enable mobile data on it. After the device accesses the Internet, an update prompt will be displayed automatically. Click Now to download the latest version immediately or click Later.
- InfiRay Outdoor saves the last connected device automatically. Therefore, once you open InfiRay Outdoor, it automatically detects an update in the background even when the Cabin device is not connected to a phone or laptop. If an update is available and the mobile device accesses the internet, you can download the update first. After the download is completed, the Cabin device will be connected to the mobile device, the version will be updated automatically.
- After the update is installed, the device will restart and enter the operation mode.

XXIII. Technical Inspection

Perform a technical inspection to check the following items each time before you use the device:

- Exterior of the device (no crack on the enclosure).
- Lens and eyepiece (no crack, oil, stain, or other sediments)

- Status of the rechargeable battery (fully charged in advance) and electrical contact (no salinization or oxidation).

XXIV. Product Maintenance

The device must be maintained in the following ways at least twice each year:

- Wipe the surface of metal and plastic parts to clear off dust and dirt by using a cotton cloth. Apply silicone grease if required.
- Use non-greasy organic solvent to wash the electric contact and slot of the battery.
- Check the glass surface of the eyepiece and lens. If necessary, clear off the dust and sand on the lens (preferably using a non-contact method). Use a specialized wiping tool and solvent to clean the optical surfaces.

XXV. Troubleshooting

The following table lists all problems that are likely to occur during device operation. Check and address problems by referring to this table. If faults not included in this table occur or you cannot fix the fault, return the device to the vendor or supplier for troubleshooting.

| Fault | Possible Causes | Solutions |
|-------------------------------------------------------------------------------|-------------------------------------------|-----------------------------------------------|
| The night vision device can not be started | The battery is out of charge | Charge the battery |
| The device cannot be powered by using an external power supply | The USB cable is damaged | Replace the USB cable |
| | The external power supply is insufficient | If necessary, check the external power supply |
| Images are unclear, vertical lines are present, or the background is not even | Calibration is required | Calibrate the images as per the user manual |

| | | |
|-----------------------------------------------------------|-------------------------------------------------------------------------------------------------------------------------|------------------------------------------------------------------------------------------------------------------------------------------------------------|
| Images are too dark | The display is not bright enough | Adjust the display brightness |
| Icons are clear but images are blurry | The lens is not focused | Rotate the lens focus knob to adjust the focus. |
| | The inner or outer optical surface of the lens is dusted or iced | Wipe the outer optical surface by using a soft cotton cloth or leave the device to dry in a warm and dry environment for more than 4 hours |
| The device cannot connect to a smartphone or computer | The Wi-Fi password is incorrect | Enter the correct password |
| | There are too many Wi-Fi networks in the range of the device, which may cause interference | To enable stable network access, you are advised to move the device to an area with a limited number of Wi-Fi networks, or an area without Wi-Fi coverage. |
| Wi-Fi signals are lost or interrupted | The device is beyond Wi-Fi coverage. There is blocking (such as concrete walls) between the device and the receiver. | Move the device to a place where you can receive Wi-Fi signals. |
| The observed target disappears | You are observing the target through the glass | Observe the target directly without the presence of glass |
| The image quality is poor or the detection range shortens | These problems are likely to occur when you use the device in harsh weather (such as snow, rain, and fog). | |

FCC Caution.

§ 15.19 Labeling requirements.

This device complies with part 15 of the FCC Rules. Operation is subject to the following two conditions: (1) This device may not cause harmful interference, and (2) this device must accept any interference received, including interference that may cause undesired operation.

§ 15.21 Information to user.

Any Changes or modifications not expressly approved by the party responsible for compliance could void the user's authority to operate the equipment.

§ 15.105 Information to the user.

Note: This equipment has been tested and found to comply with the limits for a Class B digital device, pursuant to part 15 of the FCC Rules. These limits are designed to provide reasonable protection against harmful interference in a residential installation. This equipment generates uses and can radiate radio frequency energy and, if not installed and used in accordance with the instructions, may cause harmful interference to radio communications. However, there is no guarantee that interference will not occur in a particular installation. If this equipment does cause harmful interference to radio or television reception, which can be determined by turning the equipment off and on, the user is encouraged to try to correct the interference by one or more of the following measures:

- Reorient or relocate the receiving antenna.
- Increase the separation between the equipment and receiver.
- Connect the equipment into an outlet on a circuit different from that to which the receiver is connected.
- Consult the dealer or an experienced radio/TV technician for help.

Body-Support Operation

This device was tested for typical body-support operations. To comply with RF exposure requirements, a minimum separation distance of **0cm** must be maintained between the user's body and the handset, including the antenna. Third-party belt-clips, holsters, and similar accessories used by this device should not contain any metallic components. Body-worn accessories that do not meet these requirements may not comply with RF exposure requirements and should be avoided. Use only the supplied or an approved antenna.