

TUBE NV

Digital Night Vision Scope

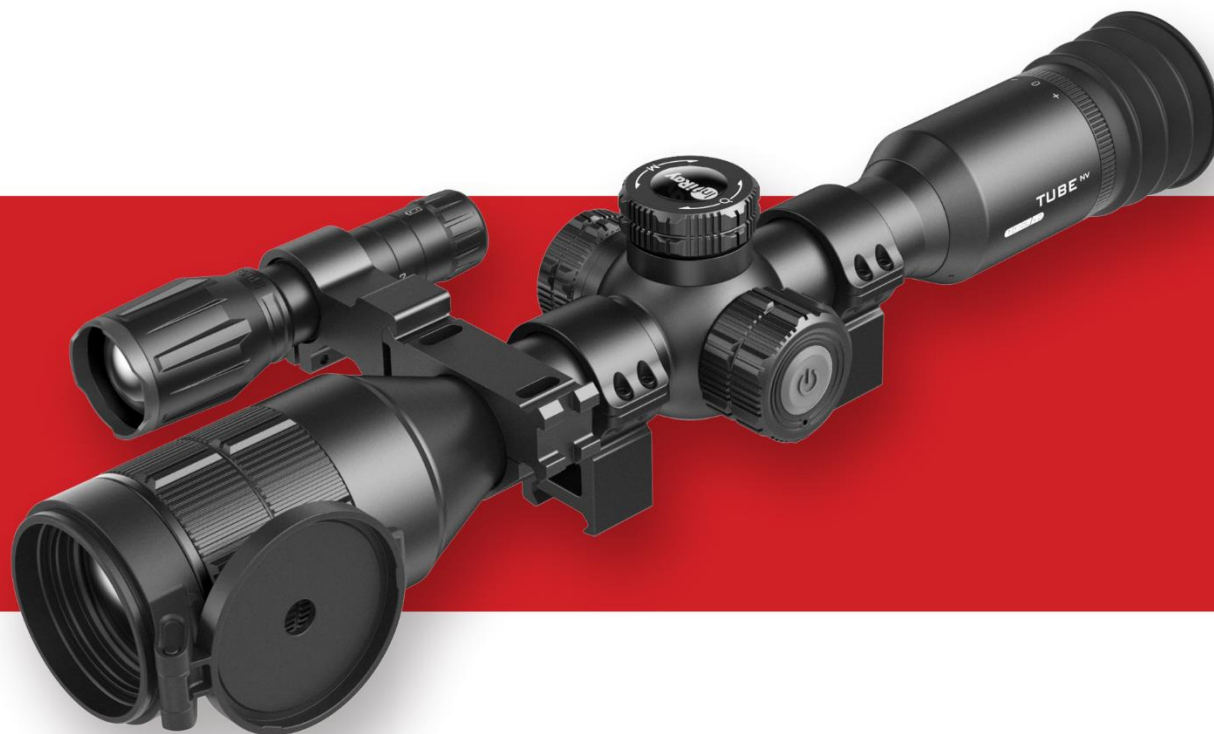

User Manual

TD70L V2

V1.0

IMPORTANT SAFETY INFORMATION

Environmental influences

WARNING! Never point the lens of the device directly at intense heat sources such as the sun or laser equipment. The objective lens and eyepiece can function as a burning glass and damage the interior components. The warranty does not cover damage caused by improper operation.

Risk of swallowing

Caution: Do not place this device in the hands of small children. Incorrect handling can cause small parts to come loose which may be swallowed.

Safety instructions for use

- Handle the device with care: rough handling may damage the internal battery.
- Do not expose the device to fire or high temperatures.
- Do not disassemble the device to access the battery. The battery is not meant to be replaced by the end user.

- The battery capacity decreases when operated in a cold ambient temperature. This is not a fault and occurs for technical reasons.
- The recommended temperature for using this product is -20° to +50°. Otherwise, it will affect the service life of the product.
- Always store the device in a dry, well-ventilated space.
- Do not store your device for long periods at temperatures lower than -20°C and higher than + 50°C, or this will permanently reduce the capacity of the battery.
- The product shall only be connected to a USB Type C interface.
- If the device has been damaged or the battery is defective, send the device to our after-sales service for repair.

Safety instructions for the power supply unit

- Check the power supply unit, cable and adapter for visible damage before use.
- Do not use any defective parts. Defective components must be replaced.
- Do not use the power supply unit in wet or humid environments.
- Only charge the device at temperatures ranging between 0°C and 40°C.

- Do not make any technical modifications.

Disposal of batteries



Directive 2006/66/EC (battery directive): This product contains a battery that cannot be disposed of as unsorted municipal waste in the European Union. For battery details, refer to the documentation of the specific product. The battery is marked with this symbol, which may include Cd (indicating cadmium), Pb (indicating lead), or Hg (indicating mercury). For proper recycling, please return the battery to your supplier or send it to a designated collection point. For more information, visit www.recyclethis.info.

User information on the disposal of electrical and electronic devices (private households)



2012/19/EU (WEEE directive): Products marked with this symbol cannot be disposed of as unsorted municipal waste in the European Union. For proper recycling, return this product to your local supplier upon the purchase of equivalent new equipment, or

dispose of it at designated collection points. For more information see: www.recyclethis.info.

For business customers within the European Union

Please contact your dealer or supplier regarding the disposal of electrical and electronic devices. He will provide you with further information.

Information on disposal in other countries outside of the European Union

This symbol is only applicable in the European Union. Please contact your local authority or dealer if you wish to dispose of this product and ask for a disposal option.

Intended use

The device is intended for displaying heat signatures during nature observation, remote hunting observations and for civil use. This device is not a toy for children.

Use the device only as described in this instruction manual. The manufacturer and the dealer accept no liability for damages which arise

due to non-intended or incorrect use.

Function test

- Before use, please ensure that your device has no visible damage.
- Test to see if the device displays a clear, undisturbed image.
- Check that the settings for the thermal imaging riflescope are correct.

See the notes in the section Operation.

Installing/removing the battery

The Tube NV series thermal imaging riflescope is equipped with a built-in battery pack which cannot be removed.

Observation with and without glasses

Thanks to the flexible eyeshade, the Tube NV series can be used with or without glasses. It offers a full field of view in both cases.

1 Specifications

Model	TD70L V2
Detector Specifications	
Sensor Resolution, pixels	1920 × 1080
Pixel Size, μm	4
Frame Rate, Hz	50 / Auto
Optical Specifications	
Objective Lens, mm	70 / F1.8
Field of View, °	4.7 × 3.5
Linear Field of View (H×V), m@100m	8.2 × 6.2
Optical Magnification, ×	5.5 ~ 22.0
Digital Zoom, ×	1 ~ 4
Eye Relief, mm	45
Diopter Adjustment, D	-4 ~ +4
Detection Range, m	300
Display Specifications	
Type	OLED
Resolution, pixels	1440 × 1080
Battery Power Supply	
Battery Type	Built-in 6600mAh battery pack
Max. Operating Time *, h	9 (t=22°C)
External Power Supply	5V (Type C)

Physical Specifications	
Wi-Fi / APP	Support (InfiRay outdoor)
Photo / Video Recorder	Support
Memory Capacity, GB	32
IP Rating	IP67
Operating Temperature, °C	-20 ~ +50
Weight, g	945
Dimension, mm	383 × 86 × 75
Body Material	Aluminum
Connections and Compatibilities	
Max. Recoil Power on Rifled Weapon (Eo), Joules	6000
Aim Point, MOA/CLICK	0.2 (5.6mm@100m)
Mount	Standard 30mm rings
Function	
IR Illuminator**, nm	850 / 940 (Optional)
IR Power, w	3

* Actual operation time depends on the density of Wi-Fi use and video recording functions.

** The product package does not contain the IR illuminator. Please select 850nm / 940nm IR illuminator according to your own needs.

➤ Improvements may be made to the design and software of this product to enhance its features without prior notice to the customer.

2 Package Contents

- Tube NV Digital Night Vision Scope
- Eyeshade
- Mounting for picatinny rail × 2
- IR Illuminator
- USB-C cable
- Lens cleaning cloth
- Certificate of qualification

3 Description

Tube NV series digital night vision scope is a daytime and night dual-use scope designed for outdoor hunting. It is equipped with a starlight-level low illuminance chip, which can restore true colors and details in both day and night. The Tube NV series has a powerful battery with

long operating hours, and can be widely used for hunting, observation and positioning in low visibility conditions. It adopts a 30mm standard pipe diameter to meet the requirements of the general clamp interface.

4 Product Features



- 1440×1080 OLED Display
- High Precision, 1 CLICK = 0.2 MOA with 70mm lens
- High magnification, 5.5× with 70mm lens
- 4um Starlight low illuminance sensor
- Powerful battery with long operating hours
- Standard 30mm pipe diameter
- Built-in memory card, supporting photo taking and video recording
- Built-in Wi-Fi module, supporting app connection
- Support PIP function
- Convenient operation interface

5 Components and Controls

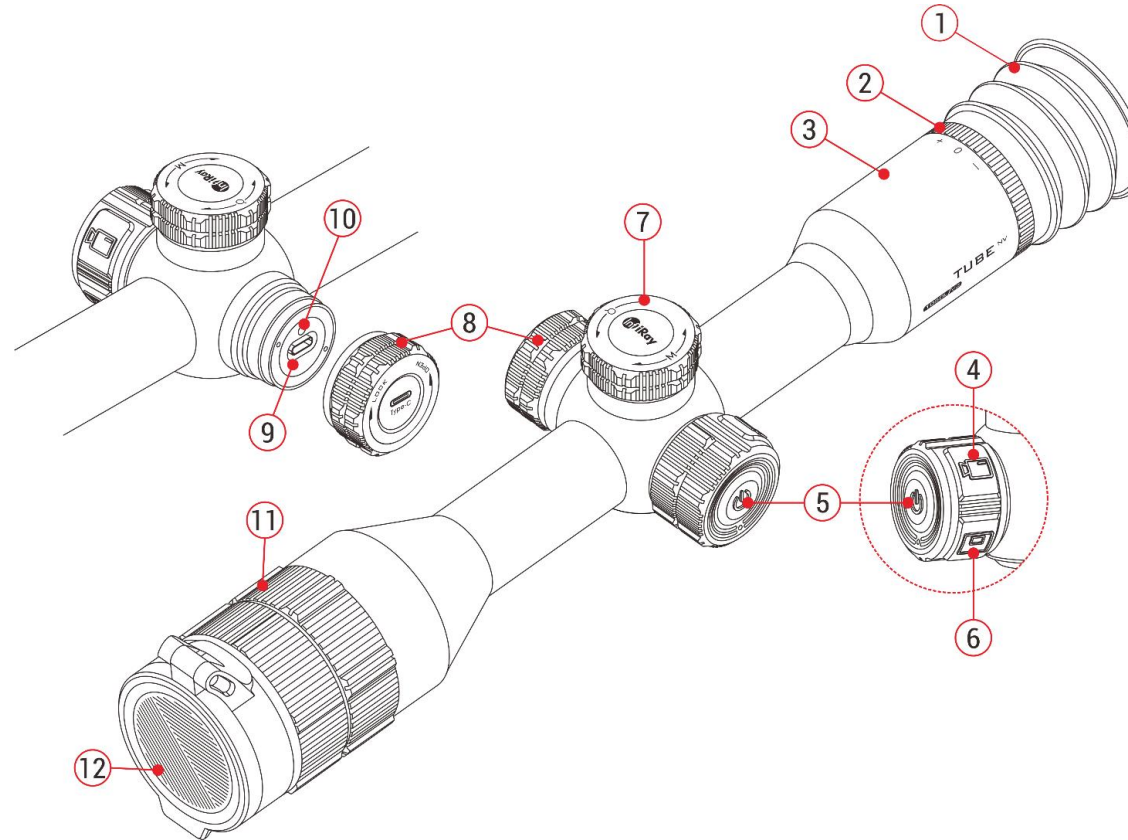
- 1. Eyeshade
- 2. Eyepiece adjusting ring
- 3. Eyepiece
- 4. Video button
- 5. Power button
- 6. PIP button
- 7. Controller
- 8. USB cover
- 9. Type-C port
- 10. LED indicator
- 11. Lens focus ring
- 12. Lens cover

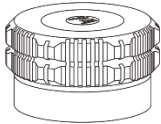

6 Button Description

Button	Current Status	Short Press	Long Press	Rotate
Power button 	Powered off	—	Power on the device	—
	Home screen	Standby the device	Shut down the device	—
	Standby	Wake up the device		—
	Main menu interface	Return to the upper menu without saving	—	—
Video button 	Home screen	Start / Stop a video recording	Take a photo	—
PIP button 	Home screen	Turn on / off the PIP function	Turn on / off the laser rangefinder function when paired with LRF	—
Controller 	Home screen	Enter the shortcut menu interface	Enter the main menu interface	Adjust the magnification
	Shortcut menu interface	Adjust the parameters	Save and return to the home screen	Switch the menu option
	Main menu interface	Adjust the parameters / Enter the submenu	Save and return to the upper interface	Switch the menu option
	Zeroing interface	Confirm or cancel selection		Switch zeroing options / Move the reticle position:

Clockwise: move to the left / down

Anticlockwise: move to the right / up

7 Power Supply

The Tube NV series adopts a powerful battery system (built-in 6600mAh chargeable Lithium-ion battery pack). The normal working time of the dual power supply system can be up to 9 hours. Tube NV series can support the USB power supply.

Please notice that the battery should be fully charged before first use.

Charging

During use, if the battery icon turns into , it indicates that the battery level is low. Please charge the battery in time to avoid reducing the service life of the device due to over discharge of the battery.

- Rotate the USB cover (8) counterclockwise and remove it.
- Connect the Type-C end of the attached data cable (13) to the Type-C port (9) on the Tube NV series.

- Connect the other end of the data cable (13) to the USB port on the power adapter (14). Plug the adapter (14) into a 100-240V power socket (15) for charging.

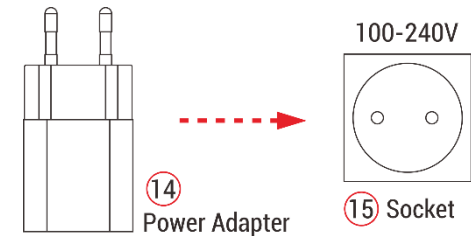

- During charging, a charging icon appears on the battery icon , and the LED indicator (10) on the device is red. When the indicator (10) turns green, it indicates that charging is complete.

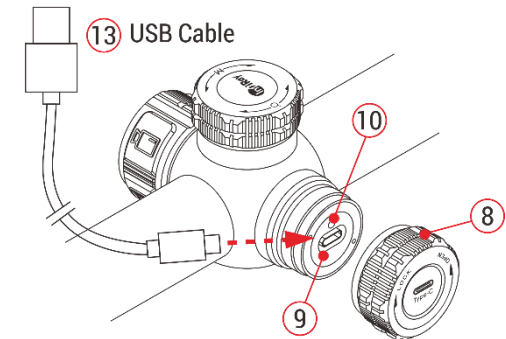

Safety Measures

- When charging, always use the 5V2A power adapter compatible with the device. Using any other type of adapter may cause irreversible damage to the battery or the adapter itself.

- If the device is not in use for a long time, the battery should be partially charged, not fully charged or discharged.
- Do not charge the device immediately after it is moved to a warm environment from a cold environment. Wait for 30 to 40 minutes for preheating.
- If the charger is modified or damaged, do not use it.
- The device should be charged at a temperature of 0°C to +40°C. Otherwise, the battery life will be significantly reduced.
- When charging, please do not leave the battery unattended.
- Do not connect the battery to the power supply for more than 24 hours after it is already fully charged.
- The device is equipped with a short circuit protection system, but conditions that may lead to a short circuit should be avoided.

8 Installation of Rifle Mount

To ensure accurate results, please first mount the Tube NV at a proper position on the weapon.

The Tube NV series adopts a tubular body design with a diameter of

30mm, which is compatible with standard mounts with a diameter of 30mm, such as the ring mounts included in the package.

Follow the ring manufacturer's installation instructions to install the Tube NV on a rifle.

Proper tools such as a torque wrench may be required to control the torque, so as to avoid damaging the scope body due to being over-tightened, and the recommended torque shall not exceed 2.5nm.

Notes

- When mounting the Tube NV on a rifle, adjust its position so that proper eye relief as specified in the **Specifications** is achieved. Failure to comply with this recommendation may result in injury to the shooter by the eyepiece when shooting.
- It is recommended to install the scope as low as possible, but keep it away from the barrel or other devices.
- After mounting but before hunting with the Tube NV, please zero the device first. Refer to the instructions **Zeroing** in this manual.
- It is recommended to use an eyeshade while using the scope in the dark in order to avoid detection of camouflage. Mounting the eyeshade on the eyepiece is carried out through the thread.

9 Operation

- Open the lens cover (12).
- Press and hold the **Power button (5)** for 3s to power on the device. Then, the home screen appears after 3s.
- Rotate the eyepiece adjusting ring (2) to adjust the resolution of the icon on the display.
- Rotate the lens focus ring (11) to focus on the object being observed.
- Rotate the controller (7) on the home screen to set the digital zoom.
- Press the **Controller (7)** briefly on the home screen to enter the shortcut menu to set the display brightness, image contrast, image mode, frame rate and zeroing distance (refer to the section **Shortcut Menu** for details).

- **Standby:** On the home screen, press the **Power button (5)** briefly to standby the device. And press the **Power button (5)** again to

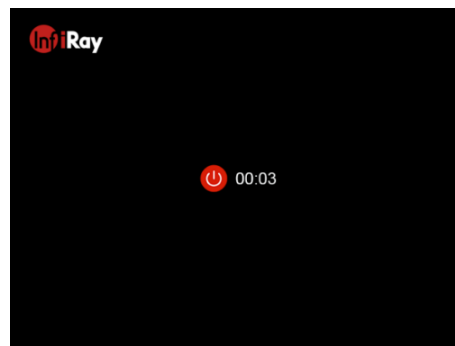

wake up the device.



- **Power off:** After use, power off the device with a long press of the **Power button (5)** until the countdown icon turns to 0, then the display turns black and the device is off.

10 Zeroing

The Tube NV series adopts the “freezing” zeroing method. It is recommended to perform zeroing in environments within the operating temperature range of the scope.

- Fix the riflescope with the mount clamp on your weapon. For details, refer to the section **Installation**.
- Select a target at a certain distance, such as 100m, 200m, etc.
- Point the weapon at the center of the target and shoot.
- Observe the position of the actual point of impact, and if the impact point does not match with the aiming point (the center of the riflescope reticle), keep the aiming position still, and meanwhile, press and hold the **Controller (7)** to enter the main menu interface.
- Select a zeroing profile in the main menu (refer to **Main Menu -**

Zeroing Profile ).

- Rotate the **Controller (7)** select the **Zeroing** option , and briefly press the **Controller (7)** to enter the **Zeroing** submenu (refer to **Main Menu - Zeroing**).
- Select the zeroing distance according to the selected target distance. If there is no matching distance, select  and short press the **Controller (7)** to create one (refer to **Main Menu - Zeroing - Add New Zeroing Distance**).
- After the zeroing distance is set up, press the **Controller (7)** to enter the submenu. Rotate the **Controller (7)** to



select the **Zeroing** function , and press the **Controller (7)** to enter the zeroing interface (refer to **Main Menu - Zeroing - Zeroing Distance - Zeroing**). The coordinate positions of the reticle (X axis and Y axis) are displayed in the upper left corner of the display.

- Rotate the **Controller (7)** to select the **Freezing** function , then press the **Controller (7)** to freeze the picture.
- Rotate the **Controller (7)** to select the movement direction **X** or **Y**, and press the **Controller (7)** to confirm selection, and the selected icon option starts blinking continuously.
- Then, move the reticle by rotating the **Controller (7)**. Rotate clockwise to move the reticle leftward or upward, and rotate anticlockwise to move the reticle rightward or downward.
- Press the **Controller (7)** again to cancel the blinking and exit the current option. Then, repeat the above two steps to select another direction option and move the reticle until the reticle center

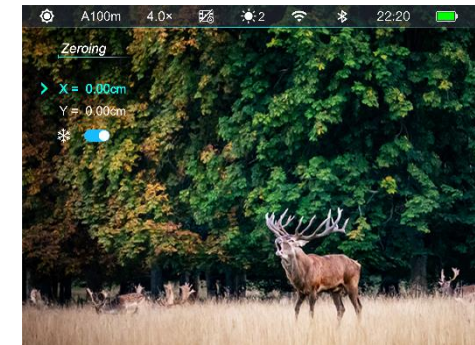

coincides with the point of impact.

- After moving the reticle, a little white dot appears on the display, indicating the position of the reticle before moving.
- When the reticle matches the actual point of impact, press and hold the **Controller (7)** to save and return to the main menu interface.
- Take another shoot – the point of impact should now match the aiming point. If not, repeat the above operations until the point of impact is consistent with that of the aiming point.

Note

- After the zeroing position is set up, you can switch the options of **Zeroing Distance** in the shortcut menu.

11 Status Bar



The status bar, at the top of the image interface, shows information about the device's current operations. From left to right, they are:

1. Current image mode (☀️: day mode; 🌙: moon mode)

2. Current zeroing profile and zeroing distance (e.g., A100m)
3. Current optical magnification (e.g., 4.0x)
4. Recoil activated video (📺: RAV is on, 📺/A: RAV is off)
5. Current display brightness (level 3 is default)
6. Wi-Fi (📶: Wi-Fi is on, 📶/A: Wi-Fi is off)
7. Bluetooth (📶: Bluetooth is on, 📶/A: Bluetooth is off; 📶/A: Bluetooth is disconnected)
8. Time (Can be set up in the main menu or synchronize the time in the InfiRay Outdoor App)
9. The power status of the built-in battery pack

Note: The levels of it show the remaining battery life.

Icon	Color / Status	Battery Status
	Green	More than 40%
	Yellow	20% - 40%
	Red	Less than 20%, need to charge instantly
	Lightning icon	External power supply meanwhile charging the built-in battery pack

12 Digital Zoom

The Tube NV Scope supports allows you to quickly increase the basic magnification from 4.0×/5.5× to 16.0×/22.0×, and the image can be correspondingly magnified from 1× to 4×.

- On the home screen, rotate the **Controller (7)** clockwise to zoom in the magnification and counterclockwise to zoom out the magnification.
- The magnifications are 5.5×, 6.0×, 7.0×, 8.0×, 9.5×, 11.0×, 12.5×, 14.5×, 16.5×, 19.0×, 22.0× in turn.
- The magnification is displayed on the top status bar in real-time.

13 Photographing and Video Recording

The Tube NV is equipped with a built-in 32GB memory space, which supports to take photos and record video for an observed target. The image and video files will be named after time, so it is recommended to set the system date and time in the main menu (**Main Menu - Settings**

- **Date/Time**), or synchronize the system date and time on the **Settings** function of the InfiRay Outdoor App before photographing and video recording.

Video Recording

- On the home screen, briefly press the **Video button (4)** to start the video recording.

- A recording icon and a prompt box showing the recording time will appear in the upper right corner of the display, with the time format





as 00:00:00 (hours: minutes: seconds).

- During recording, you can also take a photo by long pressing the **Video button (4)**.
- Stop the recording and save the video with a short press of the **Video button (4)**.
- All videos and photos are saved in the built-in memory space.

Photographing

- On the home screen, press and hold the **Video button (4)** to take a photo.



- When taking a photo, a camera icon  will flash below the status bar in the upper left corner of the screen. The photo is taken successfully when the icon disappears.
- Photos are saved in the built-in memory space.
- When the exclamation mark icon  appears on the right side of the camera icon, it prompts that the memory space is insufficient. Check and transfer videos and images to other media to free up the space.



Note

- The menu can still be operated during video recording.
- The images and the videos are stored in the built-in memory card in the format of IMG_YYMMDD.jpg (for images) and VID_HHMMSS.mp4 (for videos). YYMMDD – hours / minutes / seconds.

- If a file is deleted from the list, its number is not taken by the other file.
- The number of files is limited by the capacity of the built-in memory space of the device. It is suggested to check the available space of the memory card regularly and transfer your videos and images to other media to free up the space on the memory card.

Memory Access

When the device is powered on and connected to a computer, it will be recognized by the computer as a flash memory card. Then, you can access the memory of the device and copy images and videos.

- Connect the device to a computer through the data cable.
- Power on the device.
- Double click "My Computer" on the desktop of your computer - double click to open the device named "Infiray"  - double click to open the device name "Internal Storage"  to access the built-in memory. 
- There are different folders named by time in the format of xxxx (year) xx (month) xx (day).
- Recorded photos and videos in that day are saved in the folders

- Select desired files or folders to copy or delete.

14 Shortcut Menu

The shortcut menu can be used for a quick setup of the basic settings of some common functions, including display brightness, image contrast, image mode, image frame rate and zeroing distance.

- On the home screen, press the **Controller (7)** briefly to enter the shortcut menu interface.
- Then rotate the **Controller (7)** briefly to switch the following function options, and the icon background of the selected option will be highlighted:

- **Display brightness (☀️)**: Rotate the **Controller (7)** to select the display brightness option, and press the **Controller (7)** to adjust the display brightness from level1 to level 5.



- **Image Contrast (🎨)**:

Rotate the **Controller (7)** to select the image contrast option, and press the **Controller (7)** to adjust the image contrast from level1 to level 5.

- **Image Mode (🌙)**: Rotate the **Controller (7)** to select the image mode option, and press the **Controller (7)** to switch the image mode between Day mode and Moon mode.
- **Frames Per Second (FPS)**: Rotate the **Controller (7)** to select the FPS option, and press the **Controller (7)** to switch among Auto and 50fps. In Auto mode, the frame per second is 50Hz, but when the lighting conditions (visible and near infrared) are weak, it will switch to 25Hz automatically.
- **Zeroing Distance (🎯)**: Rotate the **Controller (7)** to select the option, and press the **Controller (7)** to switch between the distance values saved for the current zeroing type (e.g., For firearm type A, when you select the option, only the distance values saved for type A will be available).



- Press and hold the **Controller (7)** to save the changes and return to the home screen.





15 Main Menu



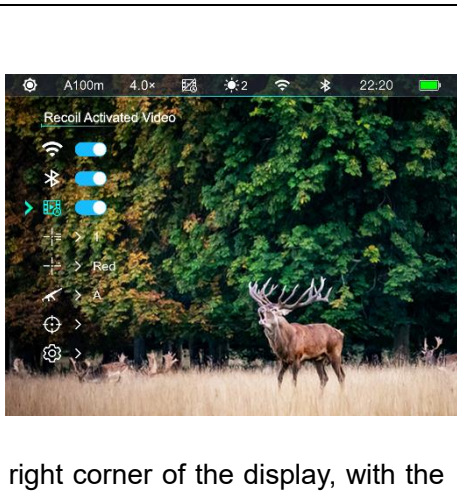

- On the home screen, press and hold the **Controller (7)** for 2s to enter the main menu interface.
- Rotate the **Controller (7)** to switch between the function options in the main menu, rotate clockwise to move down and anticlockwise to move up.
- The function options in the main menu are cyclical: when the cursor > reaches the last option, continue rotating the **Controller (7)** clockwise and the cursor > will move to the first option.
- Press the **Controller (7)** to modify the parameters of the current option or enter the submenu.
- The position of the cursor indicates the selected option, and the selected icon will change from white to blue.
- The operation of secondary and tertiary menus is the same as above.
- In any menu interface, press and hold the **Controller (7)** to save the changes and return to the upper menu interface. And, briefly press the **Power button (5)** to return to the upper menu without saving.
- In the main menu interface, the device will automatically return to the home screen without any saving if there is no operation within 1min.
- During the continuous operation of the scope, when exiting from the main menu, the cursor > remains at the position before exiting. When you restart the scope and enter the main menu for the first time, the selected option stays at the first menu option.







Main Menu Features and Descriptions

 <p>Wi-Fi</p>	<p>Turn the Wi-Fi function on/off</p> <ul style="list-style-type: none"> ● Press and hold the Controller (7) to enter the main menu. ● Rotate the Controller (7) to select the Wi-Fi function option. ● Press the Controller (7) to turn Wi-Fi function on/off.
--	---

	<ul style="list-style-type: none"> ● When Wi-Fi is on, the default password is prompted for 3s behind Wi-Fi function. ● The password is only displayed for the first three times. When the password is changed, it will not be displayed. ● The icon in the status bar changes accordingly when Wi-Fi is turned on or off. 	
<p>Bluetooth</p> 	<p>Turn the Bluetooth function on/off</p> <ul style="list-style-type: none"> ● Press and hold the Controller (7) to enter the main menu. ● Rotate the Controller (7) to select the Bluetooth function option. ● Press the Controller (7) to turn Bluetooth function on/off. ● When the Bluetooth is on, the device will automatically search and connect to the Bluetooth LRF devices. ● The Bluetooth status will be displayed on the status bar. 	
<p>Recoil Activated Video (RAV)</p> 	<p>Turn the RAV function on/off</p> <ul style="list-style-type: none"> ● Press and hold the Controller (7) to enter the main menu. ● Rotate the Controller (7) to select the Recoil Activated Video option. ● Press the Controller (7) to turn the RAV function on/off. ● The icon in the status bar changes accordingly when RAV is turned on or off. ● When the RAV function is on, when shooting, the device will automatically record videos from 3 seconds before shooting to 2 minutes 57 seconds after shooting. ● The recording icon and prompt box showing the recording time appear in the upper right corner of the display, with the 	





	<p>time format as 00:00:00 (hour: minute: second).</p> <ul style="list-style-type: none"> ● The video will be saved in the built-in storage. If there is a continuous shooting within 3 minutes, only one video will be saved.
<p>Reticle Type</p> 	<p>Select the type of the reticle</p> <ul style="list-style-type: none"> ● Press and hold the Controller (7) to enter the main menu. ● Rotate the Controller (7) to select the Reticle Type function option. ● Press the Controller (7) briefly to enter the submenu of the Reticle Type function. ● There are seven types for selection. ● Rotate the Controller (7) to select the type you want and short press the Controller (7) to confirm your selection and return to the main menu interface. ● The reticle type will change when you switch the type selection. 
<p>Reticle Color</p> 	<p>Select the color of the reticle</p> <ul style="list-style-type: none"> ● Press and hold the Controller (7) to enter the main menu. ● Rotate the Controller (7) to select the Reticle Color function option. ● Press the Controller (7) briefly to enter the submenu of the Reticle Color function. ● There are four colors for selection – Black, White, Red and Green. ● Rotate the Controller (7) to select the color you want and short press the Controller (7) to confirm your selection and return to the main menu interface. ● The color of the reticle will change when you switch the color selection. 





<p style="text-align: center;">Zeroing Profile</p> 	<p>Select Zeroing Profile</p> <ul style="list-style-type: none"> ● Press and hold the Controller (7) to enter the main menu. ● Rotate the Controller (7) to select the Zeroing Profile option. ● Press the Controller (7) to enter the submenu of the zeroing profile. ● Rotate the Controller (7) to select one from the five zeroing profiles (A, B, C, D, E). ● Press the Controller (7) to confirm the selection, and return to the main menu. ● The name of the selected profile will change in the status bar. 	
<p style="text-align: center;">Zeroing</p> 	<p>Please set up the zeroing profile and zeroing distance before carrying out any zeroing operation.</p> <p>The Tube NV series supports any zeroing distance between 1 and 999 meters.</p> <ul style="list-style-type: none"> ● Press and hold the Controller (7) to enter the main menu. ● Rotate the Controller (7) to select the Zeroing option. ● Press the Controller (7) to enter the submenu for Zeroing distance selection or addition. The distance by factory default is 100m. ● Rotate the Controller (7) to select the distance or select the Add icon ⊕ to add a new distance. ● Press the Controller (7) briefly to confirm the selection. 	
	<p>Add New Zeroing Distance</p> 	<p>If a new zeroing distance need to be created, you can operate as follows.</p> <ul style="list-style-type: none"> ● Select the Add option, and briefly press the Controller (7) to add a new distance. ● Two small triangle symbols are displayed above and below the number 0.





		<ul style="list-style-type: none"> ● Rotate the Controller (7) to set the number value of the current position from 0 to 9. ● Press the Controller (7) to switch among the positions of hundred, ten and one digits. ● After setting, press and hold the Controller (7) to save settings and exit. ● The Tube NV supports up to 10 types of zeroing distance for each zeroing profile. 	
	<p style="text-align: center;">Zeroing</p> 	<p>If the zeroing distance is consistent with the preset target distance, zero your device directly as follows.</p> <ul style="list-style-type: none"> ● Select the distance and briefly press the Controller (7) to enter the submenu. ● Select the Zeroing  option and briefly press the Controller (7) to enter the Zeroing interface. ● The X axis and Y axis coordinates of the reticle and image freeze function  are displayed at the top left corner of the screen. ● Keep the aiming position still, rotate the Controller (7) to choose the freeze icon, and then press Controller (7) to freeze the picture. 	 



	<ul style="list-style-type: none"> ● Move the reticle position by rotating or pressing the Controller (7) until the reticle center matches with the point of impact. For details, refer to the section Zeroing. ● When the reticle matches the actual point of impact, press and hold the Controller (7) to save the current reticle position and return to the main menu interface.
<p style="text-align: center;">Reset Zeroing</p> <p style="text-align: center;">Distance</p> <p style="text-align: center;">▼</p> <p style="text-align: center;">000</p> <p style="text-align: center;">▲</p>	<p>Modify the zeroing distance</p> <ul style="list-style-type: none"> ● Select a distance and enter the submenu with a brief press of the Controller (7). ● Rotate the Controller (7) to select the Zeroing Distance Setting option. ● Press the Controller (7) briefly to activate the zeroing distance reset function, and then two small triangle symbols are displayed above and below the number. ● Rotate the Controller (7) to set the number value of the current position from 0 to 9. ● Press the Controller (7) to switch among the positions of hundred, ten and one digits. ● After setting, press and hold the Controller (7) to save settings and exit. The cursor returns to the zeroing option, and the zeroing distance changes accordingly. ● Besides, the status bar updates to the new zeroing distance synchronously.
<p style="text-align: center;">Delete Zeroing</p> <p style="text-align: center;">Distance</p>	<p>If a zeroing distance need to be deleted, you can operate as follows.</p> <ul style="list-style-type: none"> ● Select a distance and enter the submenu with a brief press of the Controller (7).







		<ul style="list-style-type: none"> ● Rotate the Controller (7) to select the Delete Zeroing Distance option. ● Briefly press the Controller (7) to delete the current distance and return to the upper menu interface.
	<p>This function is used to set the date, time, language, measurement unit, factory reset, firmware update and device information query.</p> <ul style="list-style-type: none"> ● Press and hold the Controller (7) to enter the main menu. ● Rotate the Controller (7) to select the Settings option. ● Press the Controller (7) to enter the submenu of the settings. This menu item allows you to configure the following settings. 	
<p>Settings</p> 	<p>Date</p> 	<p>Setting the system date</p> <ul style="list-style-type: none"> ● In the Settings submenu, rotate the Controller (7) to select the Date option. ● Press the Controller (7) briefly to activate the date reset function accompanied by two triangle icons appearing above and below the value. ● Date format is displayed as YY.MM.DD format. ● Rotate the Controller (7) to set the correct year, month and date. ● Press the Controller (7) to switch among year, month and date. ● After setting, press and hold the Controller (7) to save changes and exit the date setting function. 

<p style="text-align: center;">Time</p> 	<p>Setting the system time</p> <ul style="list-style-type: none"> ● In the Settings submenu, rotate the Controller (7) to select the Date option. ● Time format is displayed as HH:MM in 24-hours format (14:48). ● Press the Controller (7) briefly to activate the date reset function accompanied by two triangle icons appearing above and below the value. ● Rotate the Controller (7) to set the correct hour and minute. ● Press the Controller (7) to switch between the hour and minute. ● After setting, press and hold the Controller (7) to save changes and exit the time reset function. ● After setting time, the time in the status bar changes accordingly. 
<p style="text-align: center;">Language</p> 	<p>Selecting language</p> <ul style="list-style-type: none"> ● In the Settings submenu, rotate the Controller (7) to select the Language option. ● Press the Controller (7) to enter the submenu for language selection. ● Rotate the Controller (7) to switch among English and Russian. ● Press the Controller (7) to confirm the selection and return to the upper menu. 

<p style="text-align: center;">Units of Measure</p> 	<p>Selecting the units of measure</p> <ul style="list-style-type: none"> ● In the Settings submenu, rotate the Controller (7) to select the Units of Measure option. ● Press the Controller (7) to enter the submenu for unit setup. ● Rotate the Controller (7) to switch between meter and yard. ● Press the Controller (7) to confirm the selection and exit to the upper menu interface. 	
<p style="text-align: center;">Factory Reset</p> 	<p>Reset to factory settings</p> <ul style="list-style-type: none"> ● In the Settings submenu, rotate the Controller (7) to select the Factory Reset option. ● Press the Controller (7) to enter the submenu. ● Rotate the Controller (7) to select "Yes" for restoring factory settings or "No" for canceling the operation. ● Press the Controller (7) to confirm the selection. ● If "Yes" is selected, the scope will reboot automatically. ● If "No" is selected, the operation is canceled and return to the upper menu. <p>After the Factory Reset is selected, the following functions will be restored to default settings:</p> <ul style="list-style-type: none"> - Image Mode: Day mode - Wi-Fi: Off - Display Brightness: Level 3 - Bluetooth: Off 	

		<ul style="list-style-type: none"> - Image Contrast: Level 3 - FPS: Auto - Zeroing Distance: A100m - Optical Magnification: 4.0× / 5.5× - RAV: Off - Language: English - Unit of Measure: Meter - Memory: Formatted
	<p>Firmware Update</p> 	<p>Firmware update</p> <ul style="list-style-type: none"> ● In the Settings submenu, rotate the Controller (7) to select the Firmware Update option. ● Press briefly the Controller (3) to enter the submenu of the firmware update function. ● Rotate the Controller (7) to select Yes or No and press the Controller (7) to confirm the selection. ● When select Yes, it will automatically search for the update file in the folder named update in the memory space and update it. ● For details about how to update, please refer to the Section Firmware Update. <p>Note: Please ensure that the power of the device is sufficient before the update.</p> 
	<p>Info</p> 	<p>Show device information</p> <ul style="list-style-type: none"> ● In the Settings submenu, rotate the Controller (7) to select the Info option. ● The relevant information of riflescope will be shown by a short press of the Controller (7). ● This item allows the user to view the following information about the riflescope: the product model,

		<p>GUI version, SYS Info, Boot version, FPGA, PN and SN number of the riflescope, Hardware version and FCC ID.</p> <ul style="list-style-type: none"> ● Press and hold the Controller (7) to return to the upper menu interface. 	
<p>Laser Calibration</p> 	<p>This function is displayed and activated only when the laser rangefinder (ILR-1200-1) module is connected.</p> <p>When the target position pointed by the laser indicator is not aligned with the center of the rangefinder cursor on the screen, it needs to calibrate the position of laser rangefinder cursor by this function.</p> <ul style="list-style-type: none"> ● Confirm that the laser rangefinder is connected with the Tube NV firstly. ● Press and hold the Controller (7) to enter the main menu interface. ● Rotate the Controller (7) to select Laser Calibration option. ● Press the Controller (7) to enter the Laser Calibration interface, the laser indicator and rangefinder cursor will be both turned on automatically. ● The reticle appears on the screen, and the prompt information as below shown in the upper left corner: <ul style="list-style-type: none"> - X is the X-axis (horizontal) - Y is the Y-axis (vertical) ● Assume that the red "x" in the figure represents the target position aimed by the laser indicator (it is actually displayed as a red dot). 	 	

- Press the Controller **(7)** briefly to switch the option between X and Y.
- Rotate the Controller **(7)** to move the laser cursor until the center of the laser cursor is aligned with the target position aimed by the laser indicator. Rotate clockwise to move leftward / downward, and rotate counterclockwise to move rightward / upward.
- After calibration, press and hold the Controller **(7)** to save and exit to the home screen and press the **Power button (5)** to abandon this calibration and exit.

16 PIP Function

Picture-in-Picture (PIP) provides a floating window independent of the main image. This window shows the image which is enlarged to 2× in a certain area centered on the reticle of the main image.

- On the home screen, press the **PIP button (6)** to switch the PIP function on/off.
- When the PIP is on, a separate 'window' is appeared on the top of the display simultaneously with the main image.



- When the main image is enlarged by rotating the **Controller (7)**, the image shown in the PIP window is also enlarged accordingly.
- For example, when the magnification of the main image is 4×, the corresponding magnification of the PIP image is 8×.

Note

- Due to some factors, this function is not available for some regions.

17 Laser Rangefinder (ILR-1200-1, purchased separately)

The Tube NV series support external laser rangefinder module (ILR-

1200-1) brought separately.

For detailed description of the Installation and Usage of the laser rangefinder module, please refer to the manual of the laser rangefinder in its package.

- Turn on the Bluetooth function of the Tube NV.
- Press and hold the **Power button** on the laser rangefinder module to power on the laser rangefinder module. The LED light on the laser rangefinder module will flash.
- Then, the laser rangefinder module will automatically connect with Tube NV.
- When successfully connected, the LED light on the laser rangefinder module is off, and the battery icon appears on the right side of the Bluetooth icon  in the status bar, it means that the Tube NV is successfully connected with the laser rangefinder module.
- Then, press and hold the **PIP button (4)** to turn on/off the laser rangefinder function.
- The ILR-1200-1 supports the



continuous ranging mode, in which, the ranging is in real time and automatic without any operation.

- The ranging value are displayed in the upper right corner of the screen.
- When the ranging value shows MAX, it means that the target distance has exceeded the maximum distance (999m) of the laser rangefinder.
- Switch the measurement unit according to **Main Menu - Settings - Units of Measure**.
- During ranging, other functions such as menu and other shortcut functions are not affected.

18 Wi-Fi

The Tube NV series has a built-in Wi-Fi module. The device can connect wirelessly to a mobile device (laptop or smartphone) via Wi-Fi.

- To enable the wireless module, enter the main menu by long pressing the **Controller (7)**.
- Rotate the **Controller (7)** to select the **Wi-Fi** option.

- Press the **Controller (7)** briefly to turn on/off Wi-Fi module.
- After the Wi-Fi of the scope is on, search for the Wi-Fi signal with the name InfiRay_XXXXXX on the mobile device, of which, XXXXXX is a 6-bit serial number composed of digits and letters.
- Select the Wi-Fi, enter the password and connect. The initial password is 12345678.
- When Wi-Fi is successfully connected, you can control the scope via the mobile app.

Setting Wi-Fi name and password

The Wi-Fi name and password of Tube NV series can be reset in the

InfiRay Outdoor application.

- After connected with the mobile device, find and click the "Setting" icon  in the **InfiRay Outdoor** to enter the setting interface.
- In the text box, enter and submit the new name (SSID) and

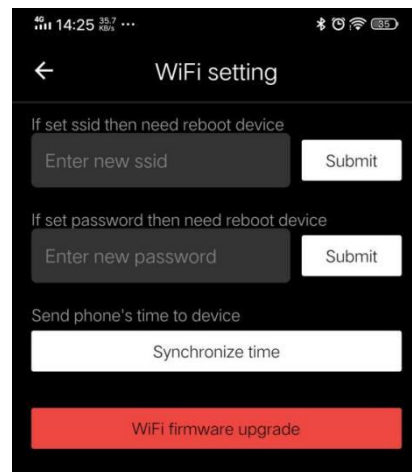

password of the Wi-Fi.

- It needs to reboot the device to take the new name and password effect.

Note

- After the device is restored to the factory settings, the name and password of the Wi-Fi will also be restored to the default factory default settings.

19 Update and InfiRay Outdoor

The Tube NV series thermal imaging riflescopes supports **InfiRay Outdoor** technology, which allows you to transmit the image from the thermal imager to the smartphone or tablet via Wi-Fi in real time mode.

You can find detailed instructions on **InfiRay Outdoor** at the official website www.infirayoutdoor.com.

The design of the riflescope provides the software update option. Updating is possible via the **InfiRay Outdoor** application. Also, it is feasible to download and update software from the official website.

About InfiRay Outdoor

- Download the **InfiRay Outdoor** App in the official website or app store, or by scanning the QR code.
- Turn on the Wi-Fi function of the scope in the main menu.
- Open **InfiRay Outdoor** application on the mobile device.
- Search and connect the Wi-Fi signal with the name InfiRay_XXXXXX on the mobile device.
- After successful connection, an update prompt will be displayed automatically. Click **Now** to download the latest version immediately or click **Later** to update later.
- **InfiRay Outdoor** will automatically store the last connected device. So, if the scope has not connected with your mobile device, but linked to **InfiRay Outdoor** before, the update prompt will appear if there is an update when opening **InfiRay Outdoor**. You can download the update first via mobile Wi-Fi and then connect the scope with mobile device to finish the update.



- After finishing the update, the device will root.

20 Technical Inspection

It is recommended to carry out a technical inspection each time before using the riflescope. Check the following:

- The scope appearance (there should be no cracks on the body).
- The condition of the object lens and eyepiece (there should be no cracks, greasy spots, dirt or other deposits).
- The status of the rechargeable battery (it should be fully charged in advance) and electrical contact (no salinization or oxidation).
- The electrical controls/buttons should be in working order.

21 Maintenance

The maintenance should be carried out at least twice a year and includes the following steps:

- Wipe the external surface of metal and plastic parts off dust with a cotton cloth. Silicone grease may be used for cleaning process.

- Clean the electric contacts and battery slots on the riflescope using a non-greasy organic solvent.
- Check the optics of the lens and the eyepiece. If necessary, remove the dirt and sand from the optics (it is perfect to use a non-contact method). Cleaning of the exterior of the optics should be done with cleaners designed especially for this purpose.

22 Troubleshooting

The following table lists all the problems that may occur when operating the scope. Carry out the recommended checks and troubleshooting steps in the order shown in the table. If there are defects that are not listed in the table or it is impossible to repair the defect yourself, return the scope to the vendor or supplier for repair service.

Faults	Possible Causes	Solutions
The scope cannot be started	The battery is out of charge	Charge the battery
The device cannot be powered by an external power supply	The USB cable is damaged	Replace the USB cable
	The external power supply is insufficient	If necessary, check the external power supply
The Image is too dark.	The display brightness level is too low.	Adjust the display brightness
The GUI icons are clear but images are blurry	The lens is not focused	Rotate the lens focus ring to adjust the focus
	There is dust or condensate on the interior or exterior optical surfaces of the lens.	Wipe off the outer optical surface by using a soft cotton cloth. Let the riflescope dry by leaving it in a warm environment for 4 hours.
The position of the reticle moves after shooting	The scope or the mount clamp is not fixed firmly.	Check that the scope has been securely mounted. Make sure that the bullet type and caliber you use are as

		<p>consistent with that used for zeroing.</p> <p>If your scope was zeroed in summer but used in winter (vice versa), the zeroing point may move slightly.</p>
The scope cannot focus	Configuration error	<p>Set the scope according to the section Operation.</p> <p>Check the outer surface of the objective lens and eyepiece, and if necessary, wipe off any dust and frost on it.</p> <p>In cold weather, a special antifogging coating can be applied (such as those used on eyeglasses or car rearview mirrors).</p>
The device cannot connect with the smartphone or tablet PC.	The Wi-Fi password is incorrect	Input the correct password
	There are too many Wi-Fi signals around the device, which may cause interference.	Move the device to an area with no or fewer Wi-Fi signals.
Wi-Fi signals are lost or interrupted	Smartphone or tablet is out of range of a strong Wi-Fi signal. Or there are obstacles between device and the smartphone or tablet (such as concrete wall).	Move the device to a place where you can receive Wi-Fi signals.
The observed target disappears	Observe the target through the glass.	Remove the glass from the field of vision.
The image quality is poor or the detection range is reduced.	These problems may occur due to the weather condition, such as snow, rain, fog etc.	
When the device is used at a low	At temperatures above 0°C, the temperature rise varies with the observed objects (environment and background)	

<p>temperature, the imaging quality is poorer than that at normal temperature.</p>	<p>due to different heat conductivity coefficients. As a result, high-temperature contrast occurs and the image quality is better.</p> <p>At low temperatures, the observed targets (background) usually cool down to a similar temperature because of reduced temperature contrast. Therefore, the image quality (details in particular) is poor, which is a characteristic of thermal imaging devices.</p>
--	--

23 Legal and Regulatory Information

Wireless transmitter module frequency range:

WLAN: 2.412-2.472GHz

Wireless transmitter module power < 20dBm



We, IRay Technology Co., Ltd. hereby declares that the radio equipment Tube NV series is in compliance with

Directive 2014/53/EU and 2011/65/EU.

FCC Statement

FCC-ID: 2AYGT-2Q-00

Labeling requirements

This device complies with part 15 of the FCC Rules. Operation is subject to the following two conditions: (1) This device may not cause harmful interference, and (2) this device must accept any interference received, including interference that may cause undesired operation.

Information to the user

Any Changes or modifications not expressly approved by the party responsible for compliance could void the user's authority to operate the equipment.

EMC Class A

Note: This equipment has been tested and found to comply with the limits for a Class A digital device, pursuant to part 15 of the FCC Rules. These limits are designed to provide reasonable protection against harmful interference when the equipment is operated in a commercial environment. This equipment generates, uses, and can radiate radio frequency energy and, if not installed and used in accordance with the instruction manual, may cause harmful interference to radio communications. Operation of this equipment in a residential area is likely to cause harmful interference in which case the user will be required to correct the interference at his own expense.

To comply with RF exposure requirements, a minimum separation distance of 3.00 mm must be maintained between the user's body and the handset, including the antenna.



IRay Technology Co., Ltd.

 **Tel :** 0086-400-999-3800

 **E-mail :** infirayoutdoor@infiray.com

 **Website :** www.infirayoutdoor.com

 **Address :** 11th Guiyang Street, YEDA, Yantai, P.R. China