



IRay Technology Co., Ltd.

Add.: 11th Guiyang Street, YEDA, Yantai, P.R. China

Tel: 0086-400-998-3088

Email: infiRayoutdoor@infiRay.com

Web: www.infiRayoutdoor.com

Operating Manual

V1.0

Mate Series | **Thermal Imaging Attachment**

MAH50/MAL38/MAL25

IMPORTANT SAFETY INFORMATION

Environmental influences

Note: Never point the lens of the device directly at intense heat sources such as the sun or laser equipment. The objective lens and eyepiece can function as a burning glass and damage the interior components.

Risk of swallowing

Caution: Do not place this device in the hands of small children. Incorrect handling can cause small parts to come loose which may be swallowed.

Safety instructions for use

- Do not expose the device to fire or high temperatures.
- The battery capacity decreases when operated in a cold ambient temperature. This is not a fault and occurs for technical reasons.
- Always store the device in its carrying bag in a dry, well-ventilated space. For prolonged storage, remove the batteries.
- Do not expose your device to extreme temperatures lower than - 20°C and higher than + 50°C.
- The product shall only be connected to a USB Type C interface.
- If the device has been damaged or the battery is defective, send the device to our after-sales service for repair.

User information on the disposal of electrical and electronic devices (private households)



The WEEE symbol on products and/or accompanying documents indicates that used electrical and electronic products must not be mixed with ordinary household waste. For proper treatment, recovery and recycling, take these products to the appropriate collection points where they will be accepted without charge. In some countries, it may also be possible to return these products to your local retailer when you purchase a corresponding new product. The proper disposal of this product serves to protect the environment and prevents possible harmful effects on human beings and their surroundings, which may arise as a result of incorrect handling of waste.

More detailed information on your nearest collection point is available from your local authority. In accordance with state legislation, penalties may be imposed for the improper disposal of this type of waste.

For business customers within the European Union

Please contact your dealer or supplier regarding the disposal of electrical and electronic devices. He will provide you with further information.

Information on disposal in other countries outside of the European

Union

This symbol is only applicable in the European Union. Please contact your local authority or dealer if you wish to dispose of this product and ask for a disposal option.

Intended use

The device is intended for displaying heat signatures during nature observation, remote hunting observations and for civil use. This device is not a toy for children.

Use the device only as described in this instruction manual. The manufacturer and the dealer accept no liability for damages which arise due to non-intended or incorrect use.

Function test

- Before use, please ensure that your device has no visible damage.
- Test to see if the device displays a clear, undisturbed image.
- Check that the settings for the thermal imaging camera are correct.

See the notes in the section Operation.

1 Specifications

Model	MAH50	MAL38	MAL25
Detector Parameters			
Resolution, pixels	640×512	384×288	
Pixel size, um	12		
NETD, mk	≤40		
Frame rate, Hz	50		
Optics Parameters			
Objective lens, mm	50	38	25
Field of view (H x V), degrees / m @ 100 m	8.8×7.0 / 15.4×12.3	7.0×5.3 / 12.3×9.2	10.6×7.9 / 18.4×13.8
Recommended magnification of the day scope, x	G1/G2: 1 - 5 G3/G4: 6 - 10	G1/G2: 1 - 5 G3/G4: 6 - 8	G1/G2/G3/G 4:1 - 5
E-zoom	Attachment mode: ×1 Monocular mode: ×1/×2/×4		
Detection range, m (Target size: 1.7m×0.5m, P(n)=99%)	2597	1948	1298
Display Parameters			

Type	OLED		
Resolution, pixels	1024×768		
Electrical Parameters			
Battery	Built-in battery + InfiRay battery Pack		
Max. battery life, h	4 + 7	4.5 + 7.5	
USB Interface	Type-C		
Physic Parameters			
Body material	Magnesium Alloy		
IP Rating	IP67		
Remote control	Support		
Built-in memory, GB	32		
Aim point, MOA	1	1.5	
Weight, g	515	505	460
Dimension, mm	146×62×73	138×62×71	132×62×68
Adapter Ring	M52×0.75		

* The actual operating time depends on the intensity of using Wi-Fi, video recorder, laser rangefinder.

➤ Improvements may be made to the design and software of this product to enhance its useful features. Technical parameters of the device may be improved without prior notice of the customer.

2 Description

MATE series are all-new generation front attachment designed as the infrared expansion device of the day light optics.

Different from the night vision device based on image enhancement, MATE doesn't need external light source and isn't influenced by strong light exposure. It can be used in the night or bad weather conditions such as fog, rain, smog and can detect the objects through obstacles such as branch, tall grass, dense bushes and so on. MATE has a wide range application including night hunting, observation and terrain orientation, search and rescue operations.

Using the MATE Series Front Attachment includes several benefits over night hunting with traditional optics or even the night vision devices. Attaching the MATE Series to a traditional scope delivers the same creature comforts of shooting with day optics you are accustomed to, including your existing reticle and eye relief. The MATE Series Front Attachment even allows you to continue utilizing your riflescope's variable magnification

3 Features









- Quick “monocular-attachment” conversion
- Quick mounting and removal of attachment
- 12μm thermal imaging detector
- 1024×768 high resolution AMOLED display
- No re-zeroing required and quick attached
- Magnesium alloy housing
- Familiar precision
- Capture/Video recording
- Support APP connecting via Wi-Fi
- Wireless remote control
- Four image modes – White hot, Black hot, Red hot, Color
- Three scene modes – Forest, Flatland, City
- Monocular's digital zoom: ×1, ×2, ×4
- Degree of protection IP67













4 Components and Controls

1. Eyepiece
2. Eyepiece bayonet-type ring
3. Down button
4. Menu (M) button
5. Camera button
6. Up button
7. Lens focus knob
8. Lens cover
9. Objective lens
10. Power button
11. Microphone
12. Type-C port
13. Bottom picatinny rail
14. Clip-on universal adapter



5 Menu / Status Bar Icons

W	Image mode White hot
B	Image mode Black hot
R	Image mode Red hot
C	Image mode Color
	Scene mode Forest
	Scene mode Flatland
	Scene mode City
	E-zoom (only for Monocular: x1, x2, x3, x4)
	Take a photo
	Display brightness
	Remote control
	Scene mode
	Image sharpness

	Ultraclear
	Wi-Fi
	Video output
	Auto shutter calibration
	Reticle type: G1/G2/G3/G4
	Image calibration
	Range notification setting
	Pixels defect correction
	Date setting
	Time setting
	Language setting
	Factory reset
	System information





	Battery power
-------------------------------------------------------------------------------------	---------------



6 Guidelines For Operation

The Mate series has been designed for long-term use. To ensure sustainable performance, please adhere to the following:

- Before use make sure that you have mounted and adjusted the device according to the instructions of the section “**Operation**”.
- Store with the lens cap on in the carrying case.
- Switch off the device after use.
- **Attempts to disassemble or repair the device will void the warranty!**
- The device is designed for use in various operating temperatures. However, if it has been brought indoors from cold temperatures, do not turn it on for 2 to 3 hours. This will prevent external optical surfaces from condensation.
- To ensure reliable performance, it is recommended to carry out regular technical inspections of the unit.

7 Description of Controls

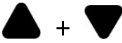
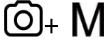
Button	Current Status	Short Press	Long Press
Power button 	Power off	---	Power on the device
	Home screen	Standby the device	Power off the device
	Standby	Wake up the device	
	Menu interface	Save and return to the upper interface	
Up button 	Home screen	Switch image mode	Turn the range notification function on /off
	Main menu / Shortcut menu interface	Scroll up options	---
	Zeroing / Pixels defect correction interface	Move one pixel to the Up every time	Move 10 pixels to the Up every time
Down button 	Home screen	Shutter correction	Background correction
	Main menu / Shortcut menu interface	Scroll down options	---
	Zeroing / Pixels defect correction interface	Move one pixel to the Down every time	Move 10 pixels to the Down every time
	Range notification interface	Loop toggles animal types	Background correction
Camera button 	Home screen	Take a picture	Video recording
	Zeroing / Pixels defect correction interface	Move one pixel to the Left every time	Move 10 pixels to the Left every time
Menu (4) button	Home screen	Enter shortcut menu interface	Enter Main Menu interface

M	Main menu / Shortcut menu interface	Adjust parameter	Save and exit to the home screen
	Zeroing / Pixel defect correction	Move one pixel to the Right every time	Move 10 pixels to the Right every time
Up + Down buttons 	Zeroing interface	---	Save the zeroing position and set the coordinate as (0,0)
	Pixels defect correction interface	---	Add / Delete defect pixels
Camera + Menu (4) buttons 	Zeroing interface	---	Save and exit to the home screen
	Pixels defect correction interface	---	
Up + Menu (4) buttons 	Home screen	---	Switch between Attachment mode and Monocular mode

8 Installation

MATE series can be used as a monocular or front attachment for day light scope. Original design allows the monocular to be quickly converted into attachment and vice versa.

As a monocular

- Remove the Clip-on universal adapter **(14)** from MATE, then it can be used as a monocular.
- When used as a monocular, it needs to switch to the monocular mode with a long press of the **Down (3) + Menu (4)** buttons for 3s, in which the status bar at the top of the screen shows x1/ x2/ x4.

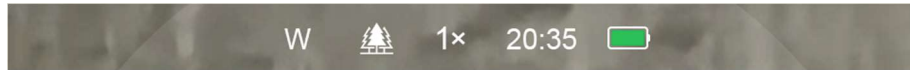

- For a better observation experience, the InfiRay Monocular (15) is suggested to use (bought separately from the InfiRay website).
- Install the InfiRay Monocular (15) on the eyepiece of the Mate by thread locking.
- In monocular mode, the Mate supports up to 4x electronic zoom, and with the 4x24 InfiRay Monocular (15), you will be able to obtain up to 16x amplification.



As a front attachment

MATE as an attachment is designed to use a day light scope both in the nighttime and daytime in inclement weather (fog, smog, rain etc.).

When use as a front attachment, please ensure MATE is in attachment mode, in which the status bar at the top of the screen shows G1/G2/G3/G4.

Press and hold down the **Down (3) + Menu (4)** buttons for 3s to switch between attachment mode and monocular mode.



To mount it on a day device, please follow instructions as follows:

- Please make sure that the day device is zeroed before installation.
- Measure the outer diameter of the lens of your day scope (17).
- Select an appropriate adapter with the internal thread M52*0.75 and an insert of the required diameter depending on the outer diameter of your day scope's objective lens.
- In the package, the complimentary universal adapter (14) with four inserts is suitable for the outer diameter from 56mm to 65 mm. If your day scope is out of this range, you need to buy it separately.

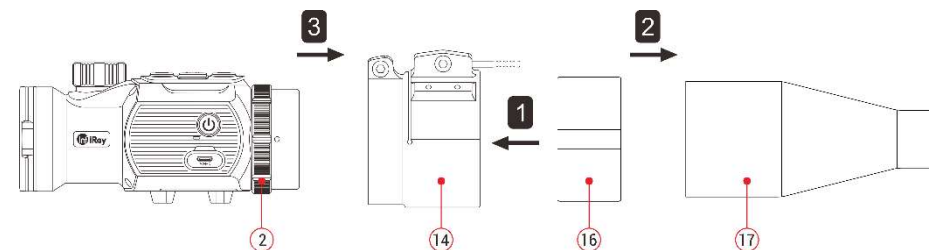

- Install the insert (16) into the adapter (14) all the way in.
- Install firmly the adapter with the insert onto the objective lens of your day

scope (17).

- Snap the lever (20) from the original OPEN position to the CLOSE position. Check that the adapter firmly fits the objective lens.
- If you see there is a clearance, please:
 - Loosen the locking screw (19) with the hex-nut wrench (S=2mm).
 - Tighten the screw (18) with hex-nut wrench (S=4mm) with a clamping force necessary to ensure that the adapter fits tightly the objective lens.
 - Tighten the locking screw (19).
- Mount the Mate onto the adapter (14), and tighten the eyepiece bayonet-type ring (2) counterclockwise to lock Mate.
- After installation, if the center of Mate's display is not aligned with the center of your day scope:
 - Loosen the locking screw (21) with the hex-nut wrench (S=4mm).
 - Adjust the angle of the Mate to the appropriate position to align with the center of your day scope.
 - Tighten the locking screw (21).

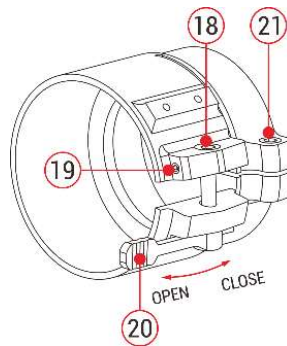

9 Operation

- Open the lens cover (8).
- Press and hold down the **Power (10)** button for 3s to power the device on. Wait for 5s until thermal image appears on the display.
- **Lens Focus Adjustment:** rotate the lens focus ring (7) to focus on the object being observed.
- **Calibration:**
 - **Shutter correction:** calibration the image with a short press of the **Down (3)** button for shutter correction
 - **Background correction:** long press the **Down (3)** button, the display will appear the prompt for “Cover lens during calibration” icon, then close the lens cover (8) to complete background correction.
- **Image mode Settings:** short press **Up (6)** button to change the image mode from White hot / Black hot / Red hot / Color one by one.
- **Other image settings:** short press the **Menu (4)** button to enter the Shortcut Menu interface, to set electronic zoom (only for Monocular

mode) / Brightness / Scene mode / Sharpness level.

- **Power Off:** long press **Power (10)** button for 3s to power off the Mate.
- **Standby Mode:** Press the **Power (10)** button briefly to standby the device for power saving. And press the **Power (10)** button again to wake it up.

10 Zeroing (only for Attachment mode)

When Mate is installed on the day scope as an infrared extension component, if the reticle of the day scope is not in the center of the infrared image, the image zeroing function can be used to shift the infrared image to ensure the position consistency between the day scope image and the infrared image.

- Please finish the calibration of the day scope before mounting MATE.
- Install Mate on the day scope and repeat the calibration steps above. Then aiming at the target at 100 meters and shoot. Measure the horizontal distance and vertical distance between the bullet hitting point and the aiming point afterwards.

- In the home screen, press and hold down **Menu (4)** button to enter the Main Menu interface.

- Press the **Up (6) / Down (3)** button to select the Zeroing Profile option () and select a zeroing profile with a short press of the **Menu (4)** button.

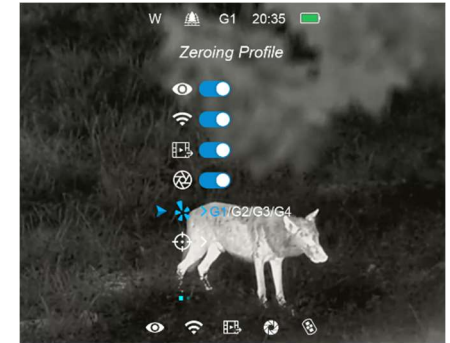

- Then select the Zeroing option () and short press the **Menu (4)** button to enter the Zeroing interface.

- In the zeroing interface, short press the **Up / Down / Camera / Menu** button briefly to move the position of

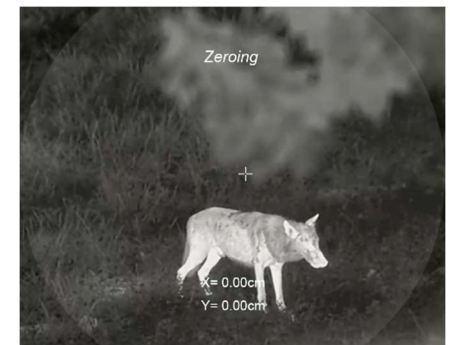

- infrared image and long press to achieve quick shift until the target on the infrared image is consistency with the reticle center of the day scope.
- When the zeroing is done, long press **Menu (4) + Camera (5)** buttons to save and exit the zeroing interface, or hold down **Up (6) + Down (3)** buttons for 3s, Save the zeroing position and set the coordinate as (0,0) and exit to the home screen.

11 Shortcut Menu

➤ In the home screen, press the **Menu (4)** button briefly to enter the shortcut menu interface. The functions are as followings:

- **Electronic zoom** (only for Monocular mode): short press the **Menu (4)** button to E-zoom the image from x1 to x4.
 - **Screen brightness**: short press the **Menu (4)** button to switch the screen brightness from level 1 to level 4.
 - **Scene mode**: short press the **Menu (4)** button to switch the scene mode among Forest, Flatland and City.
 - **Image sharpness**: short press the **Menu (4)** button to switch the image sharpness from level 1 to level 4.
- Press the **Up (6) / Down (3)** button briefly to switch the function options.
- Press and hold the **Menu (4)** button to exit to the home screen or exit automatically if no operation within 5s.





12 Main Menu

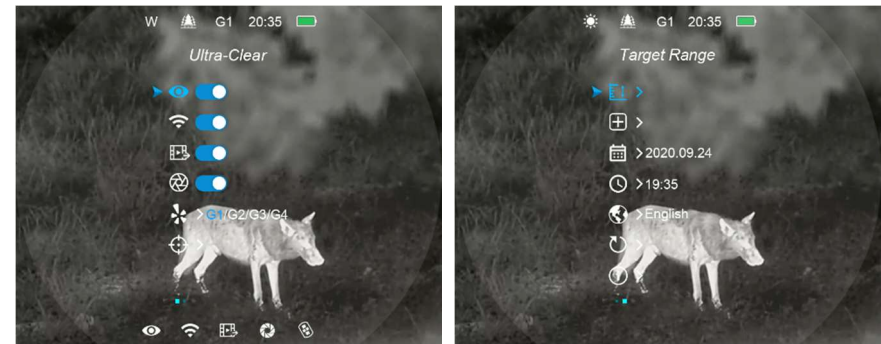

➤ In the home screen, press and hold down the **Menu (4)** button for 3 seconds to enter the main Menu interface.





- In the main Menu, press the **Up (6) / Down (3)** button briefly to switch the menu option.
- Press the **Menu (4)** button briefly to adjust the parameters of present option or enter to the submenu.
- Press and hold down **Menu (4)** button for 3 seconds to exit to the home screen.
- Press the **Power (10)** button briefly to save and exit to the upper interface.



Main Menu function description

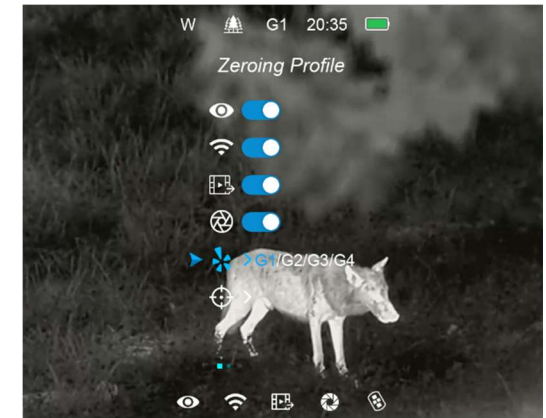

<p>Ultraclear</p> 	<p>Turn Ultraclear mode on/off</p> <ul style="list-style-type: none"> ➤ Press and hold down the Menu (4) button to enter the Main Menu. ➤ Select the Ultraclear option with the Up (6) / Down (3) button. ➤ Turn the Ultraclear mode on /off with a short press of Menu (4) button, along with the sound of shutter calibration. ➤ The icon will be displayed on the bottom status bar when the Ultraclear mode is on. ➤ Ultraclear Mode will show more image details under the cloudy, rainy, foggy and other harsh weather conditions.
<p>Wi-Fi</p> 	<p>Turn Wi-Fi function on/off</p> <ul style="list-style-type: none"> ➤ Press and hold down the Menu (4) button to enter the Main Menu. ➤ Select the Wi-Fi option with the Up (6) / Down (3) button. ➤ Turn the Wi-Fi function on /off with a short press of Menu (4) button. ➤ The icon will be displayed on the bottom status bar when the Wi-Fi is on. ➤ When Wi-Fi is on, it can be connected with the mobile phone APP.
<p>Video Output</p> 	<p>Turn video output on/off</p> <ul style="list-style-type: none"> ➤ Press and hold down the Menu (4) button to enter the Main Menu. ➤ Select the Video Output option with the Up (6) / Down (3) button. ➤ Briefly press of the Menu (4) button to turn video output on/off. ➤ The icon will be displayed on the bottom status bar when the video output function is on.



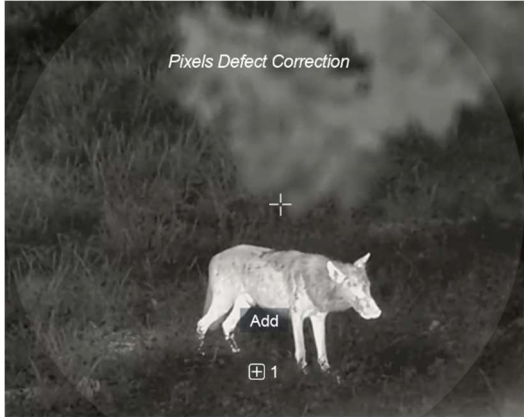

	<ul style="list-style-type: none"> ➤ Video output function enable connectivity with an external display or recording device.
<p style="text-align: center;">Auto shutter calibration</p> 	<p>Turn the Auto shutter calibration on/off</p> <ul style="list-style-type: none"> ➤ Press and hold down the Menu (4) button to enter the Main Menu. ➤ Select the Auto shutter calibration option with the Up (6) / Down (3) button. ➤ Briefly press of the Menu (4) button to set the Auto shutter calibration mode on / off. ➤ The icon will be displayed on the bottom status bar when the Auto shutter calibration is on. ➤ When the Auto shutter calibration is on, the shutter will automatically when the Image quality deteriorates.
<p style="text-align: center;">Zeroing Profile</p> 	<p>Select the Zeroing Profile (only for Attachment mode)</p> <ul style="list-style-type: none"> ➤ Press and hold down the Menu (4) button to enter the Main Menu. ➤ Select the Zeroing Profile option with the Up (6) / Down (3) button. ➤ There are four types for selection: G1/G2/G3/G4. <p>For MAH50:</p> <ul style="list-style-type: none"> - G1/G2: Recommended magnification of the day light optics for 1x-5x; - G3/G4: Recommended magnification of the day light optics for 6x-10x; <p>For MAL38:</p> <ul style="list-style-type: none"> - G1/G2: Recommended magnification of the day light optics for 1x-5x; - G3/G4: Recommended magnification of the day light optics for 6x-8x; <p>For MAL25:</p>



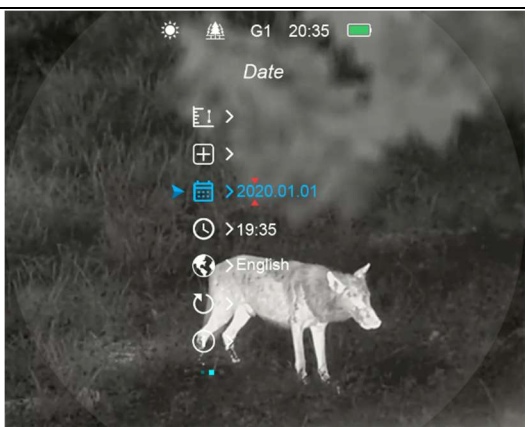

	<ul style="list-style-type: none"> - G1/G2/G3/G4: Recommended magnification of the day light optics for 1x-5x; ➤ Briefly press of the Menu (4) button to Switch and select one zeroing type. 																		
<p style="text-align: center;">Zeroing</p> 	<p>Zeroing (only for Attachment mode)</p> <ul style="list-style-type: none"> ➤ Press and hold down the Menu (4) button to enter the Main Menu. ➤ Select the Zeroing option with the Up (6) / Down (3) button. ➤ Briefly press of the Menu (4) button to enter the Zeroing interface. ➤ In the zeroing interface, short press the Up / Down / Camera / Menu button briefly to move the position of infrared image. ➤ For the details, please refer to Section 10 Zeroing. 																		
<p style="text-align: center;">Range Notification</p> 	<p>Range notification settings</p> <ul style="list-style-type: none"> ➤ Press and hold down the Menu (4) button to enter the Main Menu. ➤ Select the Range Notification option with the Up (6) / Down (3) button. ➤ Briefly press of the Menu (4) button to enter the Range Notification setting interface. ➤ There are five prey type for selection, including hare (🐰), coyote (🐺), wild boar (🐷), deer (🦌), and custom (🐾). Each prey type corresponds to a default height with a default effective distance of 100m. ➤ Switch the type option with the Up (6) / Down (3) button, and short press the Menu (4) button to active option. ➤ The first four animal types can only set the distance parameter with the Up (6) / Down (3) button. When setting is <div data-bbox="1563 815 2085 1233" style="float: right; border: 1px solid black; padding: 5px;"> <p style="text-align: center;">Target Range</p> <table border="1" style="width: 100%; border-collapse: collapse;"> <thead> <tr> <th>Target</th> <th>Height</th> <th>Distance</th> </tr> </thead> <tbody> <tr> <td>🐰</td> <td>0.2m</td> <td>100m</td> </tr> <tr> <td>🐺</td> <td>0.4m</td> <td>100m</td> </tr> <tr> <td>🐷</td> <td>0.9m</td> <td>100m</td> </tr> <tr> <td>🦌</td> <td>1.7m</td> <td>100m</td> </tr> <tr> <td>🐾</td> <td>1.0m</td> <td>100m</td> </tr> </tbody> </table> </div>	Target	Height	Distance	🐰	0.2m	100m	🐺	0.4m	100m	🐷	0.9m	100m	🦌	1.7m	100m	🐾	1.0m	100m
Target	Height	Distance																	
🐰	0.2m	100m																	
🐺	0.4m	100m																	
🐷	0.9m	100m																	
🦌	1.7m	100m																	
🐾	1.0m	100m																	

	<p>complete, press the Menu (4) button briefly to return to the range notification interface.</p> <ul style="list-style-type: none"> ➤ The last one is custom, which can set the height and distance parameters. Press the Menu (4) button briefly to switch among the selection of the height, distance and returning to the range notification interface. ➤ Press and hold down the Menu (4) button to exit to the home screen.
<p>Pixels Defect Correction</p> 	<p>Pixels Defect Correction</p> <ul style="list-style-type: none"> ➤ Press and hold down the Menu (4) button to enter the Main Menu. ➤ Select the Pixels Defect Correction option with the Up (6) / Down (3) button. ➤ Briefly press of the Menu (4) button to enter the Pixels Defect Correction Interface. ➤ A reticle will appear in the center of the screen and the number of corrected defect pixels will display at the bottom of the screen. ➤ And then, moving the reticle to select the Defect Pixels by pressing the Up / Down / Camera / Menu button. ➤ After selecting the Defect Pixels, press and hold the Up (6) + Down (3) buttons at the same time to correct the blind pixels. When the Add message appears on the bottom of the screen for a short time, the correction is successful. ➤ At the same position, press and hold the Up (6) + Down (3) buttons again to cancel the correction with the Del message appearing for a short time. <div style="display: flex; justify-content: space-around; margin-top: 20px;">   </div>

	<ul style="list-style-type: none"> ➤ The number of the defect pixels changes each time adding or deleting pixels correction. ➤ Repeat the above operations to continue selecting defect pixels. ➤ When the correction is done, press and hold the Camera (5) + Menu (4) buttons until display shows “Do you want to save these settings?” and “Yes” and “No” options. Select ‘Yes’ to save and exit, or select ‘No’ to cancel saving and exit. ➤ Switch the selection with the Up (6) / Down (3) button, and confirm your selection with the Menu (4) button.
<p style="text-align: center;">Date setting</p> 	<p>Date setting</p> <ul style="list-style-type: none"> ➤ Press and hold down the Menu (4) button to enter the Main Menu. ➤ Select the Date option with the Up (6) / Down (3) button. The date is displayed in yy/mm/dd format. ➤ Briefly press of the Menu (4) button to switch among Year, Month and Day option, then press Up (6) / Down (3) button to set the date. ➤ When the Date setting is done, press and hold Menu (4) button to exit the Date setting interface. 
<p style="text-align: center;">Time setting</p> 	<p>Time setting</p> <ul style="list-style-type: none"> ➤ Press and hold down the Menu (4) button to enter the Main Menu. ➤ Select the Time option with the Up (6) / Down (3) button. The time is displayed in 24-hours format.

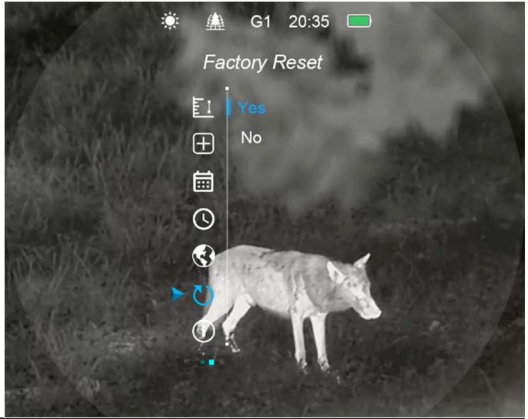
	<ul style="list-style-type: none"> ➤ Briefly press of the Menu (4) button to switch between hour and minute option, then press the Up (6) / Down (3) button to set the time. ➤ When the Time setting is done, press and hold Menu (4) button to exit the Time setting interface. 	
<p style="text-align: center;">Language</p> 	<p>Language setting</p> <ul style="list-style-type: none"> ➤ Press and hold down the Menu (4) button to enter the Main Menu. ➤ Select the Language option with the Up (6) / Down (3) button. ➤ Enter the Language submenu with a short press of the Menu (4) button. ➤ Press the Up (6) / Down (3) button to switch between English and German. ➤ Confirm your selection with a short press of the Menu (4) button. ➤ Return to main menu interface will happen automatically when the language is selected. 	
<p style="text-align: center;">Factory Reset</p> 	<p>Reset to the factory settings</p> <ul style="list-style-type: none"> ➤ Press and hold down the Menu (4) button to enter the Main Menu. 	

	<ul style="list-style-type: none"> ➤ Select the Factory Reset option with the Up (6) / Down (3) button. ➤ Press the Menu (4) button to enter the Factory Rest interface. ➤ Press Up (6) / Down (3) button to select “Yes” or “No”. ➤ When “Yes” is selected, MATE will restore the factory settings and restart. When “No” is selected, it will return to the main menu interface. 	
<p style="text-align: center;">Info</p> 	<p>System Information</p> <ul style="list-style-type: none"> ➤ Press and hold down the Menu (4) button to enter the Main Menu. ➤ Select the Info option with the Up (6) / Down (3) button. ➤ Press the Menu (4) button to show the relevant information. ➤ This item allows the user to view the following information: the device model, GUI version, PN and SN number, Wi-Fi version, and FPGA version. ➤ Press and hold Menu (4) button to exit the Info interface 	

13 Photography and Video recording

MATE has built-in 32GB storage space for photography and video recording. The files of images and videos will be named by time, so it is recommended to set the time in the Main Menu or synchronize the time in the Settings of the InfiRay Outdoor APP before using the photography and video recording function.

Photography

- Press the **Camera (5)** button in the home screen to take a photo. The screen freezes for 0.5s, and a photo icon appears on the screen.
- Photographs are saved in a built-in storage space.



Video recording

- In the home screen, press and hold down the **Camera (5)** button to start a video recording.

- A recording timer displays on the top of the screen. the time format is MM: SS (minute: second).
- During recording, it is still possible to take a photo with a short press of the **Camera (5)** button.
- Also, you can enter and navigate the menu function during video recording
- Press and hold down the **Camera (5)** button to stop and save the recording.
- The video and photo are saved in the built-in storage space.



Tips:

- Recorded photos and videos are saved in built-in memory card of the device in the format IMG_HHMMSS_XXX.jpg (for photos) and VID_HHMMSS_XXX.mp4 (for videos). HHMMSS - Hour/Minute/Second; XXX - three-digit counter (for videos and photos).
- The counter used for the names of multimedia files can't be reset.
- If a file is deleted from the list, its number is not taken by the other file.

Caution:

- The maximum duration of a recorded video file is 5 minutes. After this time expires, the video is recorded to a new file automatically.
- The number of the recorded files is limited by the capacity of the internal memory.
- Check the available space of the built-in storage card regularly and move the footage to other storage media to free up the memory card space.

Graphic data (status bar, icons and menu) in the recorded video and photo files are not displayed.

Memory Access

When the device is turned on and connected to a computer, it is recognized by the computer as a flash memory card, which is used to access the device's memory and make copies of pictures and videos.

- Turn on the riflescope and connect it with the computer via Type-C cable.
- Double click “my computer” on the desktop - double click to open the device named “InfiRay” - double click and open the device named

‘Internal Storage’ to access built-in memory.

- There are different folders named by time in the storage.
 - Recorded photos and videos in that day are saved in the folders
- Select desired files or folders to copy or delete.

14 Range Notification Function

Range notification function is used to determine if the animal is within your range.

- In the home screen, press and hold down the **Up (6)** button for 3s to enter the range notification interface.
- You will see the following on the display: Two measurement bars, Distance, Animal type, Animal height.
- There are five pre-set reference objects:
 - **Hare** - distance 100m, height 0.2m
 - **Wolf** - distance 100m, height 0.4m
 - **Wild boar** - distance 100m, height 0.9m
 - **Deer** - distance 100m, height 1.7m

- **Custom** - distance 100m, height 1.0m
- Aiming at the target, if the target animal is within the measurement bars, it indicates the animal is within the range you set.
- At shooting range notification interface, press **Down (3)** button to change the target type.
- You can change the default setting (including the animal distance or animal height) in the main menu.
- Exit the range notification interface with a long press of the **Up (6)** button.



15 WIFI function

Mate series has a built-in Wi-Fi module, which enables the device to connect wirelessly to external devices such as smart phones.

- Press and hold down the **Menu (4)** button to enter the Main Menu.

- Turn Wi-Fi function on /off with a short press of **Menu (4)** button.
- Retrieve the Wi-Fi signal named "**XXXXX_XXXXXXX**" with an external device such as smart phone, which **XXXXX** represents the model and **XXXXXXX** represents the SN code of the device.
- Select the Wi-Fi, and enter the password on the mobile device to set up the connection. The initial password is 12345678.
- When Wi-Fi is successfully connected, you can control the device via InfiRay Outdoor APP.

Set the Wi-Fi name and password

The Mate series allows users to change the name and password of device

Wi-Fi in the **InfiRay Outdoor APP**

- After connected with the mobile device, find and click the "Setting" icon  in the **InfiRay Outdoor** to enter the setting interface.
- In the text box, enter and submit the new name (SSID) and password of the Wi-Fi.

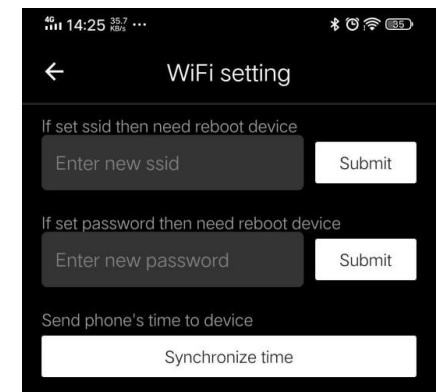

- It needs to reboot the device to take the new name and password effect.
- Otherwise, clicking the synchronize time option in the setting interface can synchronize the time on the Mate with the mobile device.

Note:

- When restored factory settings, the Wi-Fi name, password, and system time are restored to the factory default settings.

16 Battery Pack Installation

Mate series is equipped with a professional power bank - IBP-4 InfiRay battery pack (22) in the package, which is impact-resistant, waterproof and lightweight, making it perfect for outdoor use.

- Secure the IBP-4 InfiRay battery pack (22) to the smaller ring of the adapter fixture (24) in the package, and tighten the screws (26) with the hex-nut wrench (S=2mm).
- Install the adapter fixture (24) with IBP-4 InfiRay battery pack (22) on your day scope (17). Close the lever (25) on the adapter fixture to lock the fixture.

- The fixture is suitable for the most day scope with barrel diameter of 30mm.
- After installation, insert the data cable (24) to Type-C port (12) of Mate and the battery pack.
- Once connected, the battery pack will automatically charge the Mate.
- Press the Power button (23) of the battery pack to check the remaining power of the battery pack. For details, please refer to the manual of the IBP-4 InfiRay battery pack.

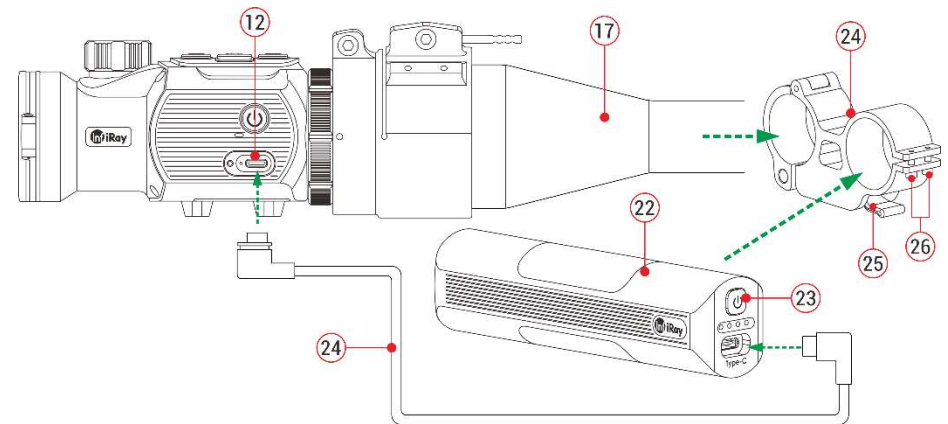

Safety Regulation

- Please use standard charger to prevent the battery pack from damage.
- It is prohibited to expose the battery pack in the high temperature

environment more than 60° C.

- It is prohibited to put the battery pack into fire and burns.
- The battery capacity decreases when operated in a cold ambient temperature. This is not a fault and occurs for technical reasons.

17 Remote Control

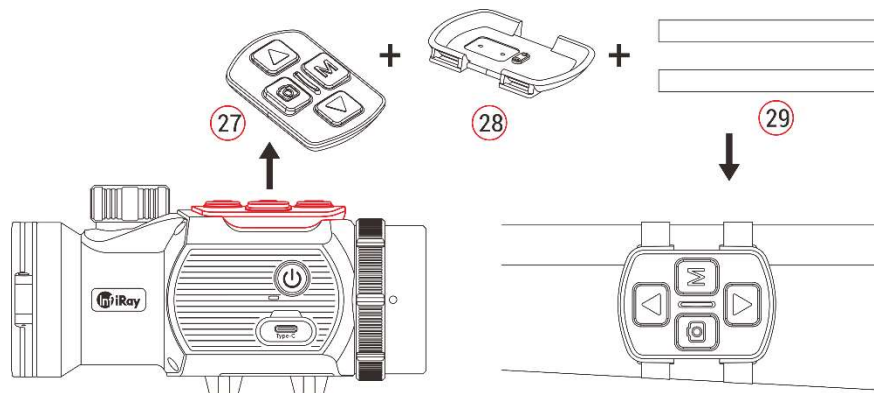

MATE button module can be removed from the Mate and installed at any position of the gun with its own accessory as a remote control.

- Remove the button module (27) from Mate unite.
- Install the button module (27) on the base (28) provided with the package.

- Thread the two magic straps (29) into the base (28) and attach the module onto the suitable position of your gun.
- Then you can control the Mate remotely.
- The remote control has a built-in battery that can be used continuously for more than 30 days.
- If the battery runs out, reattach the button module (27) to the Mate and charge it automatically via the pogo pin.

18 Technical Inspection

A technical inspection of the device is recommended before use.

- Check the external appearance of the device (there should be no cracks in the casing).
- Check the condition of the lens and eyepiece (there should be no cracks, greasy spots, dirt or other deposits)
- Check the condition of the rechargeable battery (this should be charged) and the electrical contracts (there should be no presence of salts or oxidation).

19 Maintenance

Maintenance should be carried out at least twice a year and consist of the following actions.

- Wipe the external surfaces of metal and plastic parts free of dust and dirt with a cotton cloth. Silicone grease maybe used for this.
- Clean the electrical contacts of the battery and battery slot on the unit using a non-greasy organic solvent.
- Check the glass surfaces of the eyepiece and the lens. If necessary, remove dust and sand from the lenses (preferably using a non-contact method). Cleaning of the external surfaces of the optics should be done

with substances designed especially for this purpose.

20 General Trouble Shooting

The table lists all the problems that may occur when operating the device. Carry out the recommended checks and troubleshooting steps in the order shown in the table. If there are defects that are not listed in the table or it is impossible to repair yourself, please contact with us as soon as possible. Private demolition is strictly prohibited.

Trouble description	Probable reason	Trouble shooting
Fail to start up	Battery is low power	Charge your MATE or use the InfiRay Battery Pack
Fail to work with the remote control	Remote battery is low power	Attach the remote to the MATE's body and charge it via the pogo pin
Image is fuzzy, not clear, with vertical stripes and uneven background	No calibration for a long time	Perform the shutter calibration or background calibration
Image is too dark	Low screen brightness	Adjust the screen brightness

Blurred image with clear GUI	The objective lens is not focused	Adjust the focus ring of the objective lens until the image becomes clear
	There is dust or condensate on the interior or exterior optical surfaces of the lens	Wipe off the outside optical surfaces with a soft cotton cloth. Let it dry by leaving it in a warm environment for 4 hours
No analog video output	The video output function is not turned on	Turn the video output function in the Main Menu
	Data cable doesn't support data transmission	Replace a new data cable
Point of impact does not match the aiming point	Zeroing needs to be done	Do zeroing according to the section 12
	Zeroing profile is incorrect	Check the zeroing profile setting

21 Update and InfiRay Outdoor

Mate series thermal imaging attachment support **InfiRay Outdoor** technology, which allows you to transmit the image from the thermal imager to the smartphone or tablet via Wi-Fi in real time mode.

You can find detailed instructions on **InfiRay Outdoor** in the separate brochure at the site www.infirayouordoor.com.

The design of the riflescope provides the software update option. Updating is possible via the **InfiRay Outdoor** application. Also, it is feasible to download and update software from the official website.

About InfiRay Outdoor

- You can get **InfiRay Outdoor** application in the official website, or search **InfiRay Outdoor** in App store, or scan the QR code to download **InfiRay Outdoor APP**.

- When installation completed, open InfiRay Outdoor APP.
- If your device is already connected with mobile device, please switch on the mobile data in mobile device. After connection, the update detection is performed automatically with a prompt in the application. Click 'Now' to download the updates or click 'Later' to update later.
- **InfiRay Outdoor** will automatically store the last connected device. So, if your device is not connected with your mobile device, but linked to **InfiRay Outdoor** before, the update prompt will appear if there is an update when turning on **InfiRay Outdoor**. You can download the update first via mobile Wi-Fi and then connect Mate with mobile device to finish the update.
- After finishing the update, the device will root.
- Instructions for using InfiRay Outdoor can also be downloaded from the official website.



22

Legal and Regulatory Information

Wireless transmitter module frequency range:

WIFI 2.4G: 2412-2472MHz (For EU)

Wireless transmitter module power < 20dBm (only for EU)



IRay Technology Co., Ltd. thus declares that the Mate series complies with the directives 2014/53/EU and 2011/65/EU. The full text of the EU declaration of conformity as well as additional information are available at: www.infirayouordoor.com.

This device may be operated in all member states of the EU.

FCC Statement

FCC ID: 2AYGT-2N-00

Labeling requirements

This device complies with part 15 of the FCC Rules. Operation is subject to the following two conditions: (1) This device may not cause harmful

interference, and (2) this device must accept any interference received, including interference that may cause undesired operation.

Information to the user

Any Changes or modifications not expressly approved by the party responsible for compliance could void the user's authority to operate the equipment.

Note: The manufacturer is not responsible for any radio or TV interference caused by unauthorized modifications to this equipment.

Such modifications could void the user's authority to operate the equipment.

Note: This equipment has been tested and found to comply with the limits for a Class A digital device, pursuant to part 15 of the FCC Rules. These limits are designed to provide reasonable protection against harmful interference when the equipment is operated in a commercial environment. This equipment generates, uses, and can radiate radio frequency energy and, if not installed and used in accordance with the instruction manual, may cause harmful interference to radio

communications. Operation of this equipment in a residential area is likely to cause harmful interference in which case the user will be required to correct the interference at his own expense.

The device has been evaluated to meet general RF exposure requirement.

The device can be used in portable exposure condition without restriction.

Body-worn Operation

This device was tested for typical body-support operations. To comply with RF exposure requirements, a minimum separation distance of 0mm must be maintained between the user's body and the handset, including the antenna. Third-party belt-clips, holsters, and similar accessories used by this device should not contain any metallic components. Body accessories that do not meet these requirements may not comply with RF exposure requirements and should be avoided. Use only the supplied or an approved. The maximum results of Specific Absorption Rate (SAR) found during testing for MAH50 are 0.524W/kg