

FCC - TEST REPORT

Report Number	: 68.950.21.0823.01	Date of Issue:	2022-04-12
Model	: SCH50, SUPER YOTER-R, MS-50R		
Product Type	: Saim Thermal Imaging Monocular		
Applicant	: IRay Technology Co., Ltd.		
Address	: 11GUIYANG STREET, YANTAI ECONOMY AND TECHNOLOGY DEVELOPMENT DISTRICT, YANTAI SHANDONG P. R. CHINA		
Manufacturer	: IRay Technology Co., Ltd.		
Address	: 11GUIYANG STREET, YANTAI ECONOMY AND TECHNOLOGY DEVELOPMENT DISTRICT, YANTAI SHANDONG P. R. CHINA		
Test Result	: <input checked="" type="checkbox"/> Positive <input type="checkbox"/> Negative		
Total pages including Appendices	: 60		

Any use for advertising purposes must be granted in writing. This technical report may only be quoted in full. This report is the result of a single examination of the object in question and is not generally applicable evaluation of the quality of other products in regular production. For further details, please see testing and certification regulation, chapter A-3.4.



1 Table of Contents

1	Table of Contents	2
2	Details about the Test Laboratory.....	3
3	Description of the Equipment Under Test.....	4
4	Summary of Test Standards.....	5
5	Summary of Test Results.....	6
6	General Remarks	7
7	Test Setups	8
8	Systems test configuration.....	9
9	Technical Requirement	10
9.1	Conducted Emission	10
9.2	Conducted peak output power.....	13
9.3	6dB bandwidth and 99% Occupied Bandwidth	15
9.4	Power spectral density.....	24
9.5	Spurious RF conducted emissions	28
9.6	Band edge testing	39
9.7	Spurious radiated emissions for transmitter	43
10	Test Equipment List.....	59
11	System Measurement Uncertainty	60

2 Details about the Test Laboratory

Details about the Test Laboratory

Test Site 1

Company name: TÜV SÜD Certification and Testing (China) Co., Ltd. Shenzhen Branch
Building 12 & 13, Zhiheng Wisdomland Business Park, Nantou Checkpoint
Road 2, Nanshan District
Shenzhen 518052
P.R. China

Telephone: 86 755 8828 6998

Fax: 86 755 8828 5299

FCC Registration No.: 514049

FCC Designation Number: CA5009

3 Description of the Equipment Under Test

Product:	Saim Thermal Imaging Monocular
Model no.:	SCH50, SUPER YOTER-R, MS-50R
FCC ID:	2AYGT-256
Rating:	5VDC Or 3.7VDC by Rechargeable Lithium-ion battery
Options and accessories:	USB Cable
RF Transmission Frequency:	2412MHz-2462MHz
No. of Operated Channel:	11
Modulation:	DSSS, OFDM
Antenna Type:	Integrated antenna
Antenna Gain:	3.0dbi
Description of the EUT:	The Equipment Under Test (EUT) is a Saim Thermal Imaging Monocular which support Wi-Fi. The TX and RX range is 2412MHz – 2462MHz for 2.4GHz Wi-Fi

4 Summary of Test Standards

Test Standards	
FCC Part 15 Subpart C 10-1-2020 Edition	PART 15 - RADIO FREQUENCY DEVICES Subpart C - Intentional Radiators

All the test methods were according to
KDB 558074 D01 15.247 Meas Guidance v05r02,
ANSI C63.10 (2013).

5 Summary of Test Results

Technical Requirements						
FCC Part 15 Subpart C						
Test Condition		Pages	Test Site	Test Result		
				Pass	Fail	N/A
§15.207	Conducted emission AC power port	10	Site 1	<input checked="" type="checkbox"/>	<input type="checkbox"/>	<input type="checkbox"/>
§15.247 (b) (1)	Conducted peak output power	13	Site 1	<input checked="" type="checkbox"/>	<input type="checkbox"/>	<input type="checkbox"/>
§15.247(a)(1)	20dB bandwidth	---	---	<input type="checkbox"/>	<input type="checkbox"/>	<input checked="" type="checkbox"/>
§15.247(a)(1)	Carrier frequency separation	---	---	<input type="checkbox"/>	<input type="checkbox"/>	<input checked="" type="checkbox"/>
§15.247(a)(1)(iii)	Number of hopping frequencies	---	---	<input type="checkbox"/>	<input type="checkbox"/>	<input checked="" type="checkbox"/>
§15.247(a)(1)(iii)	Dwell Time	---	---	<input type="checkbox"/>	<input type="checkbox"/>	<input checked="" type="checkbox"/>
§15.247(a)(2)	6dB bandwidth and 99% Occupied Bandwidth	15	Site 1	<input checked="" type="checkbox"/>	<input type="checkbox"/>	<input type="checkbox"/>
§15.247(e)	Power spectral density	24	Site 1	<input checked="" type="checkbox"/>	<input type="checkbox"/>	<input type="checkbox"/>
§15.247(d)	Spurious RF conducted emissions	28	Site 1	<input checked="" type="checkbox"/>	<input type="checkbox"/>	<input type="checkbox"/>
§15.247(d)	Band edge	39	Site 1	<input checked="" type="checkbox"/>	<input type="checkbox"/>	<input type="checkbox"/>
§15.247(d)	Spurious radiated emissions for transmitter	43	Site 1	<input checked="" type="checkbox"/>	<input type="checkbox"/>	<input type="checkbox"/>
§15.203	Antenna requirement	See note 2		<input checked="" type="checkbox"/>	<input type="checkbox"/>	<input type="checkbox"/>

Note 1: N/A=Not Applicable.

Note 2: The EUT uses an internal antenna, which gain is 3.0 dBi. In accordance to §15.203, It is considered sufficiently to comply with the provisions of this section.

Remark: The EUT power by battery

6 General Remarks

Remarks

This submittal(s) (test report) is intended for FCC ID: 2AYGT-256, complies with Section 15.207, 15.209, 15.247 of the FCC Part 15, Subpart C rules.

The EUT RF module as same as FCC ID: 2AYGT-26-00 and the antenna position different, and the RF Conducted test data refer to report no: 68.950.21.0744.01, the other data need to update.

Remark: The SUPER YOTER-R, MS-50R have the same technical construction including circuit diagram, PCB Layout, components and component layout, all electrical construction and mechanical construction, with Saim Thermal Imaging Monocular, SCH50. The difference lies only in the outlook/color of the different models.

SUMMARY:

All tests according to the regulations cited on page 5 were

■ - Performed

□ - **Not** Performed

The Equipment Under Test

■ - **Fulfills** the general approval requirements.

□ - **Does not** fulfill the general approval requirements.

Sample Received Date: 2021-11-09

Testing Start Date: 2021-11-09

Testing End Date: 2021-12-13

TÜV SÜD Certification and Testing (China) Co., Ltd. Shenzhen Branch

Reviewed by:

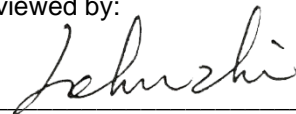

John Zhi
Project Manager

Prepared by:



Warlen Song
Project Engineer

Tested by:

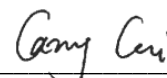

Carry Cai
Test Engineer

7 Test Setups

7.1 AC Power Line Conducted Emission test setups

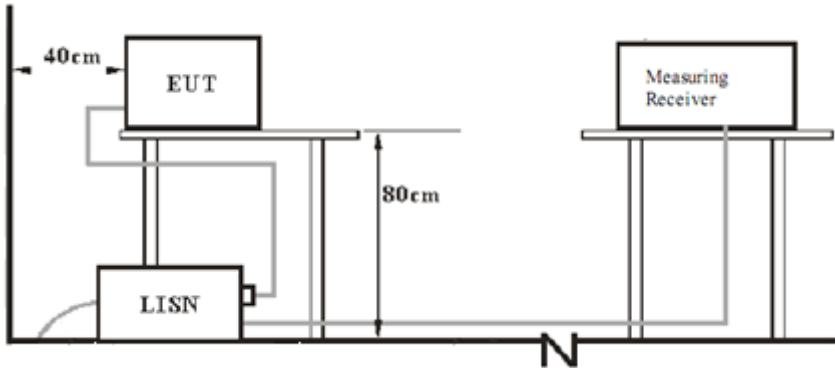

7.2 Radiated test setups Below 1GHz

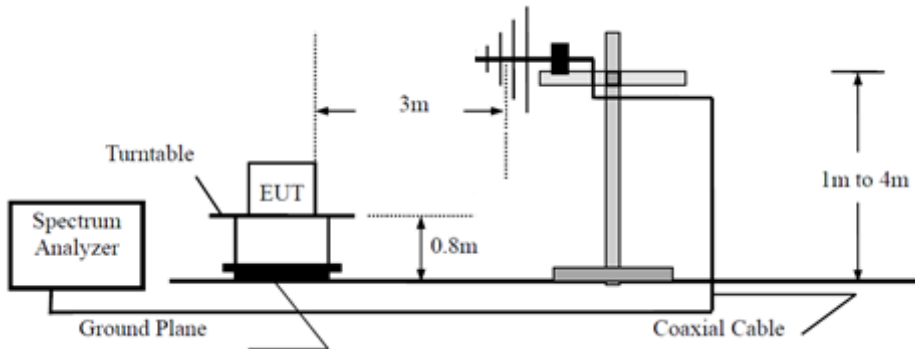

Above 1GHz

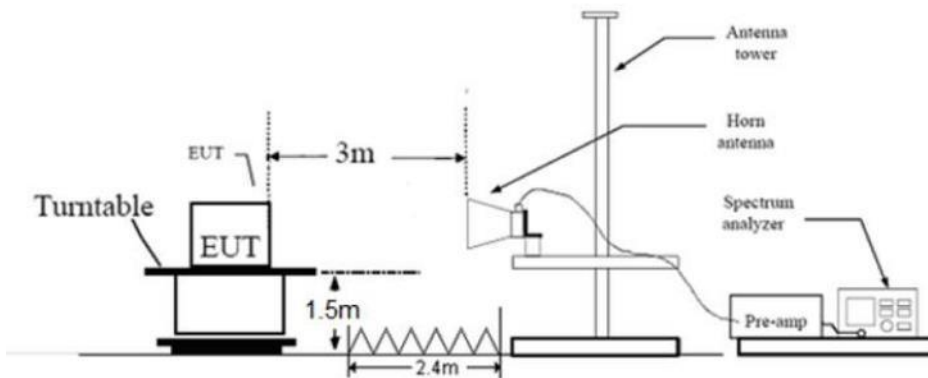

7.3 Conducted RF test setups

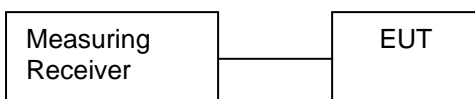

8 Systems test configuration

Auxiliary Equipment Used during Test:

DESCRIPTION	MANUFACTURER	MODEL NO.(SHIELD)	S/N(LENGTH)
PC	Lenovo	X240	---

The system was configured to non-hopping mode.

Non-hopping mode: The system was configured to operate at a signal channel transmitting. The test software allows the configuration and operation at the worst-case duty and the highest transmit power.

9 Technical Requirement

9.1 Conducted Emission

Test Method

1. The EUT was placed 0.4 meter from the conducting wall of the shielding room was kept at least 80 centimeters from any other grounded conducting surface.
2. Connect EUT to the power mains through a line impedance stabilization network (LISN).
3. All the support units are connecting to the other LISN.
4. The LISN provides 50 ohm coupling impedance for the measuring instrument.
5. Both sides of AC line were checked for maximum conducted interference.
6. The frequency range from 150 kHz to 30 MHz was searched.
7. Set the test-receiver system to Peak Detect Function and specified bandwidth (IF Bandwidth = 9kHz) with Maximum Hold Mode. Then measurement is also conducted by Average Detector and Quasi-Peak Detector Function respectively.

Limit

Frequency MHz	QP Limit dB μ V	AV Limit dB μ V
0.150-0.500	66-56*	56-46*
0.500-5	56	46
5-30	60	50

*Decreases with the logarithm of the frequency.

Conducted Emission

Product Type : Saim Thermal Imaging Monocular
 M/N : SCH50
 Operating Condition : Charging + Transmit
 Test Specification : Power Line, Live
 Comment : AC 120V/60Hz

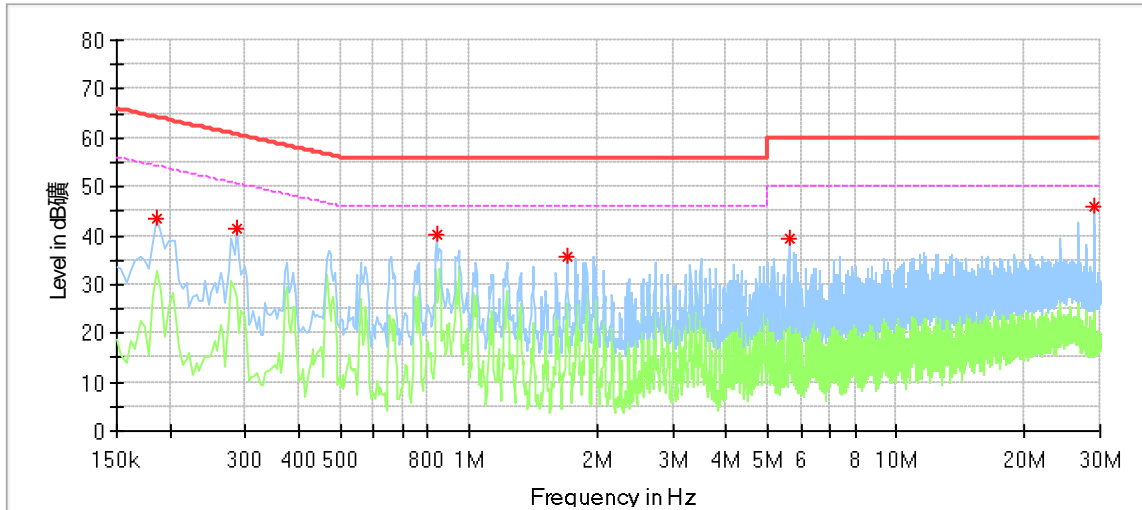

Critical Freqs

Frequency (MHz)	MaxPeak (dBµV)	Average (dBµV)	Limit (dBµV)	Margin (dB)	Line	Corr. (dB)
0.186000	43.53	---	64.21	20.68	L1	9.24
0.286000	41.56	---	60.64	19.08	L1	9.22
0.842000	40.18	---	56.00	15.82	L1	9.20
1.698000	35.61	---	56.00	20.39	L1	9.22
5.606000	39.41	---	60.00	20.59	L1	9.32
29.081500	46.03	---	60.00	13.97	L1	9.48

Final Result

Frequency (MHz)	QuasiPeak (dBµV)	Average (dBµV)	Limit (dBµV)	Margin (dB)	Line	Corr. (dB)
---	---	---	---	---	---	---

Remark :

Level=Reading Level + Correction Factor

Correction Factor=Cable Loss + LISN Factor

(The Reading Level is recorded by software which is not shown in the sheet)

Conducted Emission

Product Type : Saim Thermal Imaging Monocular
 M/N : SCH50
 Operating Condition : Charging + Transmit
 Test Specification : Power Line, Neutral
 Comment : AC 120V/60Hz (External adapter)

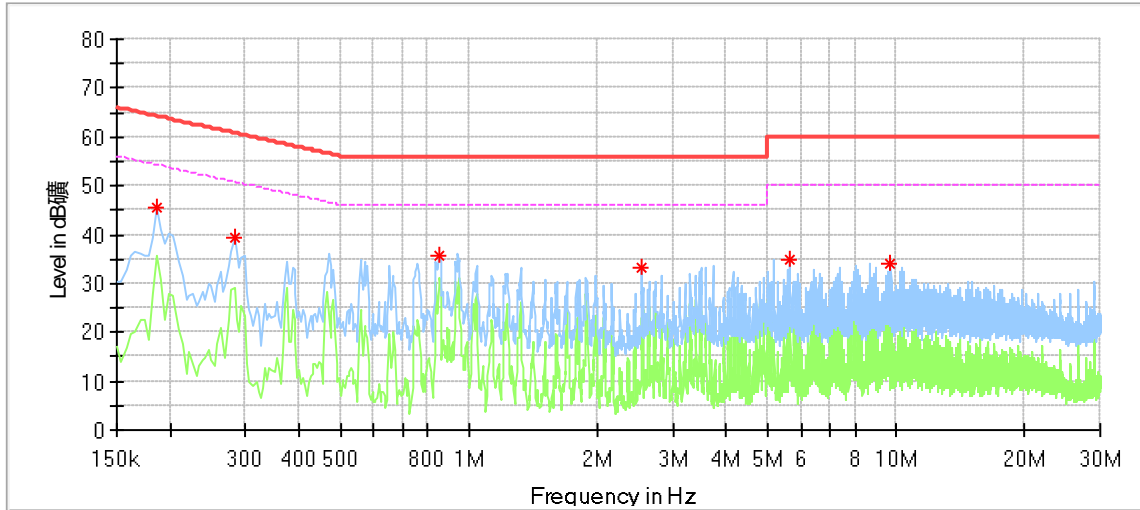

Critical_Freqs

Frequency (MHz)	MaxPeak (dBµV)	Average (dBµV)	Limit (dBµV)	Margin (dB)	Line	Corr. (dB)
0.186000	45.73	---	64.21	18.49	N	9.40
0.282000	39.27	---	60.76	21.48	N	9.39
0.850000	35.62	---	56.00	20.38	N	9.39
2.542000	33.28	---	56.00	22.72	N	9.44
5.650000	34.92	---	60.00	25.08	N	9.52
9.710000	34.12	---	60.00	25.88	N	9.61

Final_Result

Frequency (MHz)	QuasiPeak (dBµV)	Average (dBµV)	Limit (dBµV)	Margin (dB)	Line	Corr. (dB)
---	---	---	---	---		---

Remark :

Level=Reading Level + Correction Factor

Correction Factor=Cable Loss + LISN Factor

(The Reading Level is recorded by software which is not shown in the sheet)

9.2 Conducted peak output power

Test Method

1. The EUT was placed on 0.8m height table, the RF output of EUT was connected to the power meter by RF cable. The path loss was compensated to the results for each measurement.
2. Setting the highest output power level of the EUT
3. Record the power value.

Limits

According to §15.247 (b) (3), conducted peak output power limit as below:

Frequency Range MHz	Limit W	Limit dBm
2400-2483.5	≤1	≤30

Test result as below table

802.11b_ modulation Test Result

Frequency (MHz)	Conducted Peak Output Power (dBm)	Result
	Ant 0	
Low channel 2412MHz	13.9	Pass
Middle channel 2437MHz	13.8	Pass
High channel 2462MHz	13.9	Pass

802.11g_ modulation Test Result

Frequency (MHz)	Conducted Peak Output Power (dBm)	Result
	Ant 0	
Low channel 2412MHz	14.0	Pass
Middle channel 2437MHz	13.9	Pass
High channel 2462MHz	13.9	Pass

802.11n20_modulation Test Result

Frequency (MHz)	Conducted Peak Output Power (dBm)	Result
	Ant0	
Low channel 2412MHz	13.9	Pass
Middle channel 2437MHz	14.0	Pass
High channel 2462MHz	12.9	Pass

9.3 6dB bandwidth and 99% Occupied Bandwidth

Test Method for 6 dB Bandwidth

1. Use the following spectrum analyzer settings:
RBW=100K, VBW \geq 3RBW, Sweep = auto, Detector function = peak, Trace = max hold
2. Use the automatic bandwidth measurement capability of an instrument, may be employed using the X dB bandwidth mode with X set to 6 dB, care shall be taken so that the bandwidth measurement is not influenced by any intermediate power nulls in the fundamental emission that might be \geq 6 dB.
3. Allow the trace to stabilize, record the X dB Bandwidth value.

Test Method for 99 % Bandwidth

1. Use the following spectrum analyzer settings:
RBW=1% to 5% of the actual occupied, VBW \geq 3RBW, Sweep = auto, Detector function = peak, Trace = max hold
2. Use the automatic bandwidth measurement capability of an instrument, care shall be taken so that the bandwidth measurement is not influenced by any intermediate power nulls in the fundamental emission that might be \geq 6 dB.
3. Allow the trace to stabilize, record the X dB Bandwidth value.

Limit

Limit [kHz]

\geq 500

6dB Bandwidth

TestMode	Antenna	Channel [MHz]	DTS BW [MHz]	FL[MHz]	FH[MHz]	Limit [MHz]	Verdict
11B	Ant0	2412	7.600	2408.080	2415.680	0.5	PASS
	Ant0	2437	9.320	2432.240	2441.560	0.5	PASS
	Ant0	2462	7.400	2458.280	2465.680	0.5	PASS
11G	Ant0	2412	16.480	2403.760	2420.240	0.5	PASS
	Ant0	2437	16.520	2428.760	2445.280	0.5	PASS
	Ant0	2462	16.160	2453.800	2469.960	0.5	PASS
11N20	Ant0	2412	15.880	2404.080	2419.960	0.5	PASS
	Ant0	2437	15.240	2429.400	2444.640	0.5	PASS
	Ant0	2462	16.760	2453.200	2469.960	0.5	PASS

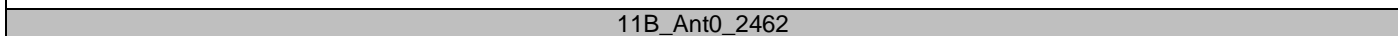
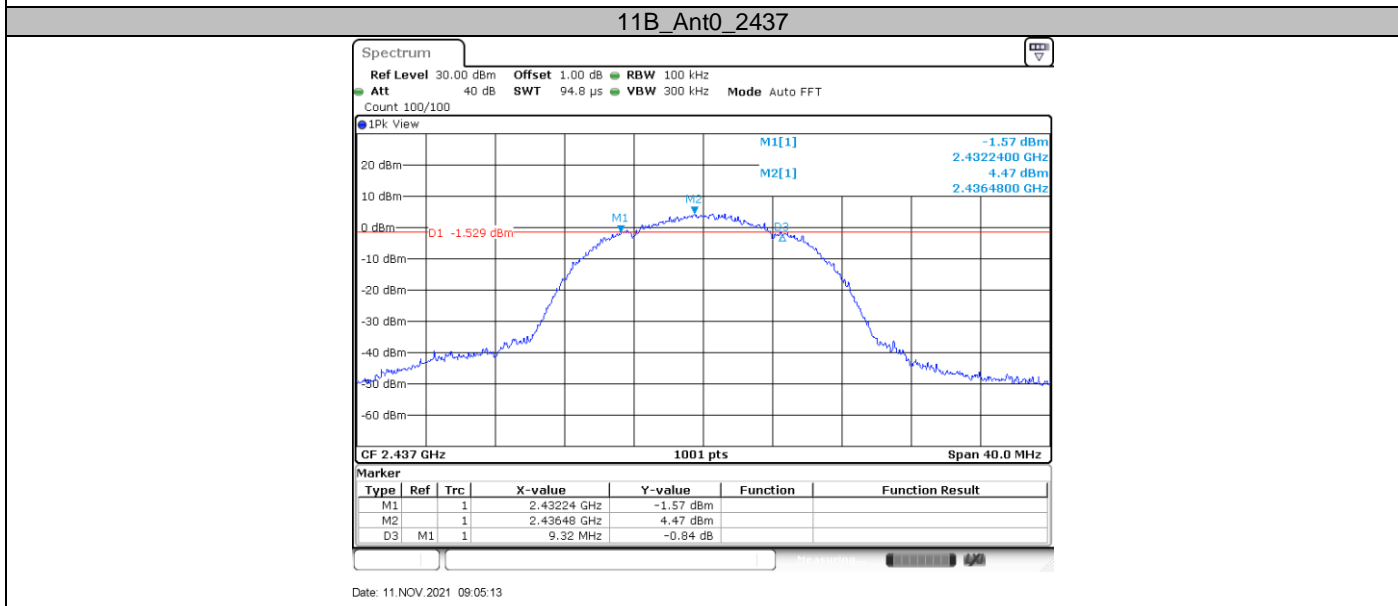
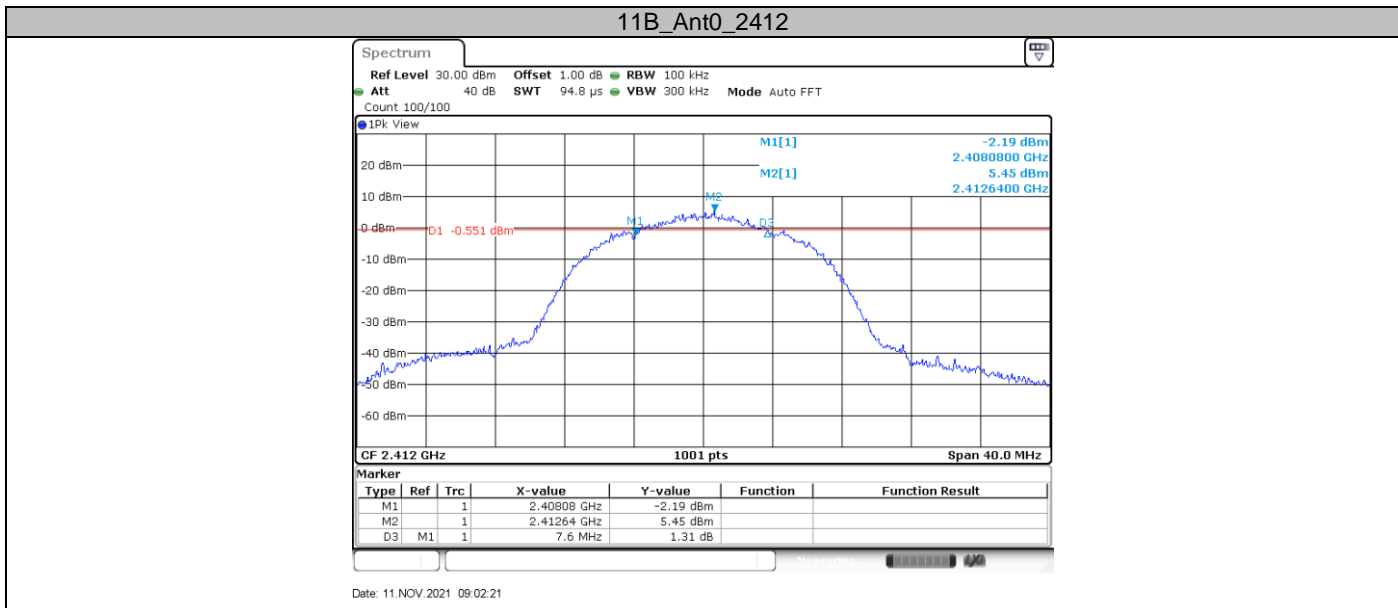

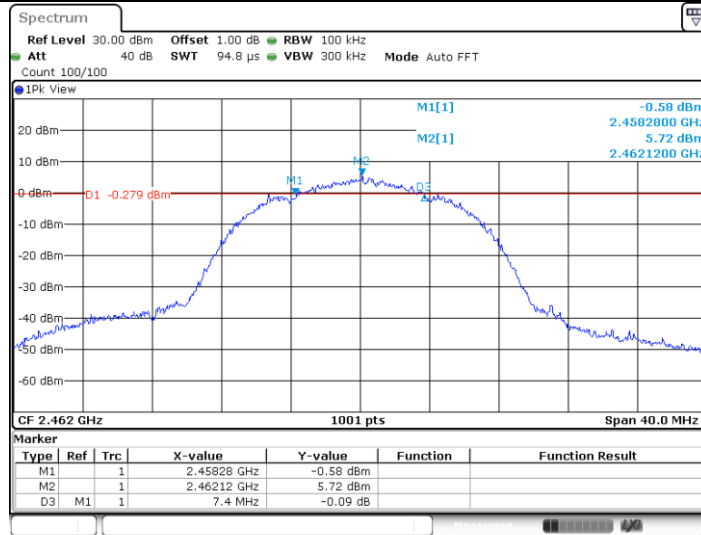

Date: 11.NOV.2021 09:07:27

11G_Ant0_2412

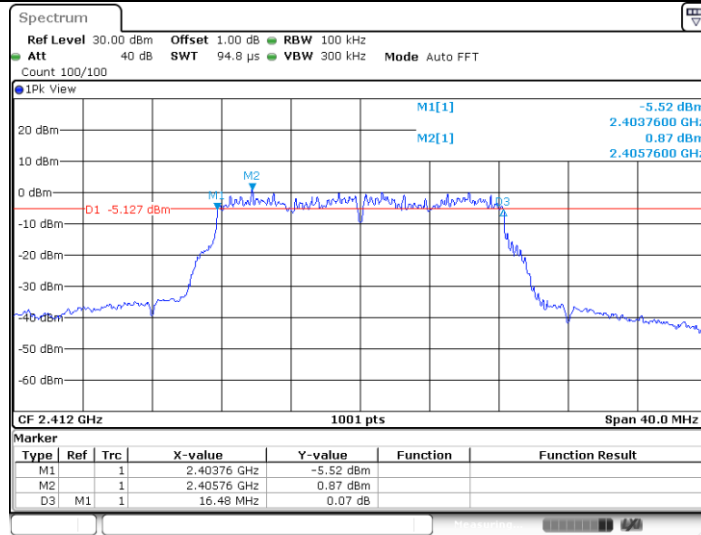

Date: 11.NOV.2021 09:09:59

11G_Ant0_2437

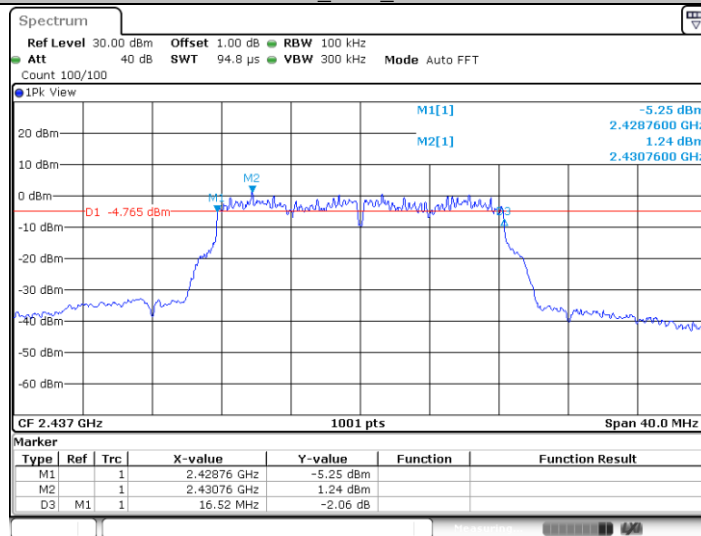

Date: 11.NOV.2021 09:15:03

11G_Ant0_2462

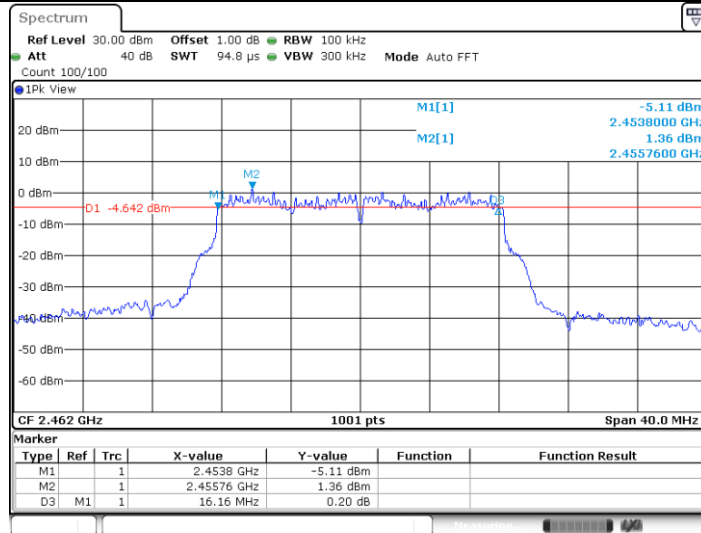

Date: 11.NOV.2021 09:17:52

11N20SISO_Ant0_2412

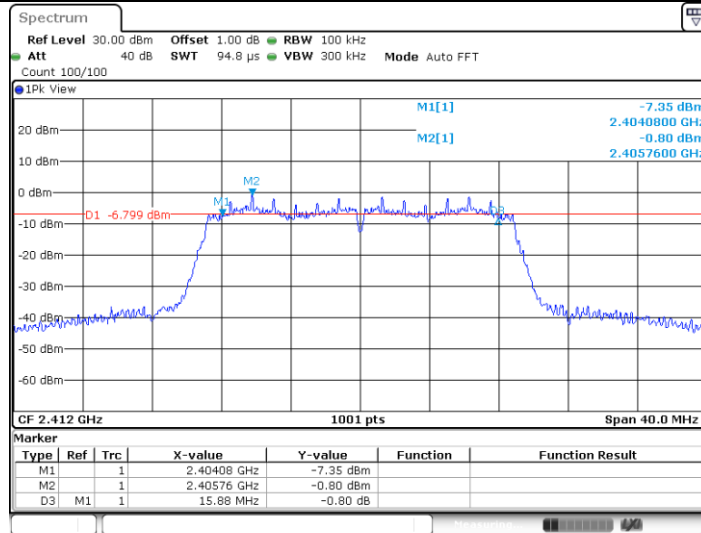

Date: 11.NOV.2021 09:21:42

11N20SISO_Ant0_2437

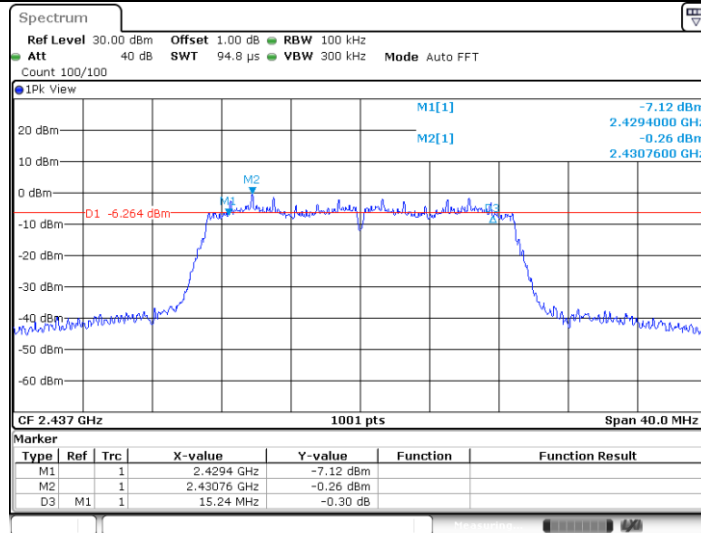

Date: 11.NOV.2021 09:25:28

11N20SISO_Ant0_2462

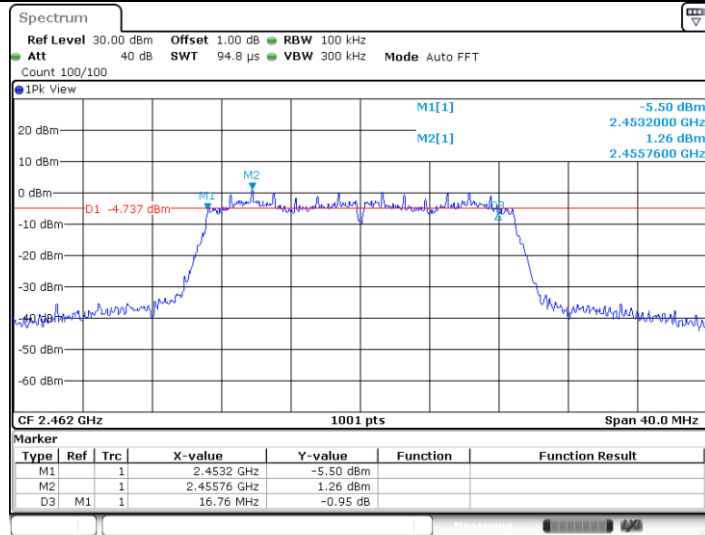

Date: 11.NOV.2021 09:28:28

99% Bandwidth

TestMode	Antenna	Channel [MHz]	OCB [MHz]	FL[MHz]	FH[MHz]	Limit[MHz]	Verdict
11B	Ant0	2412	13.866	2405.087	2418.953	---	PASS
		2437	13.866	2430.087	2443.953	---	PASS
		2462	13.826	2455.087	2468.913	---	PASS
11G	Ant0	2412	17.383	2403.289	2420.671	---	PASS
		2437	17.463	2428.249	2445.711	---	PASS
		2462	17.463	2453.289	2470.751	---	PASS
11N20SISO	Ant0	2412	18.382	2402.809	2421.191	---	PASS
		2437	18.382	2427.809	2446.191	---	PASS
		2462	18.422	2452.809	2471.231	---	PASS

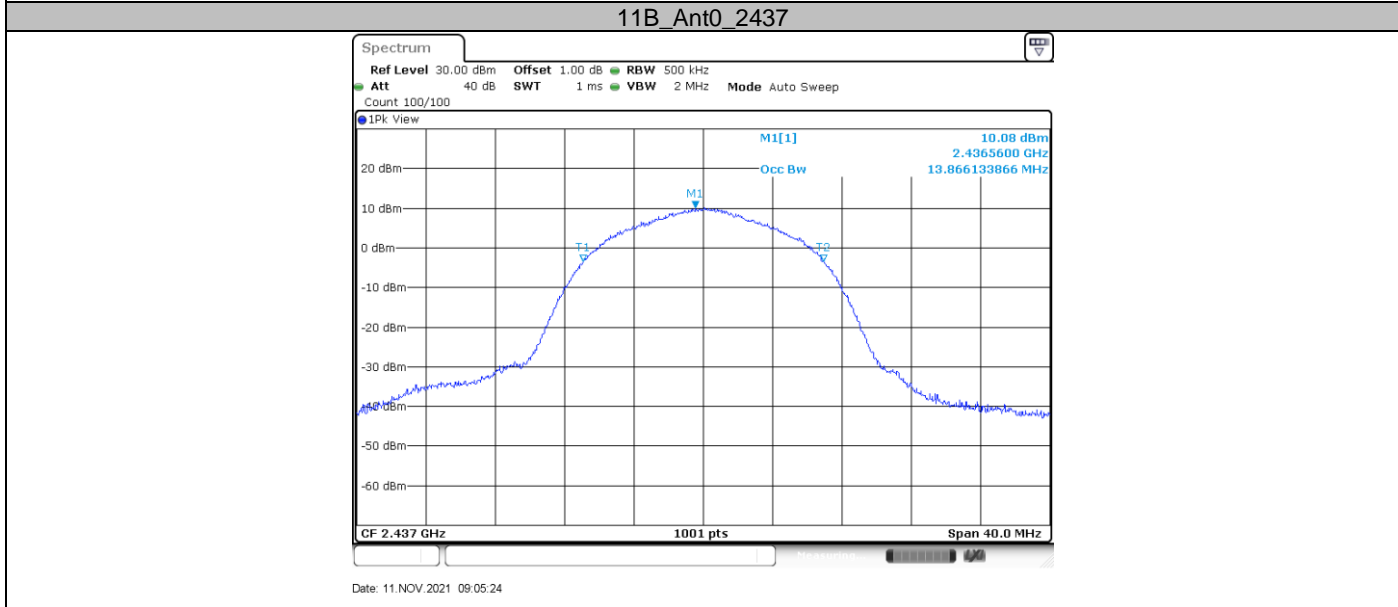
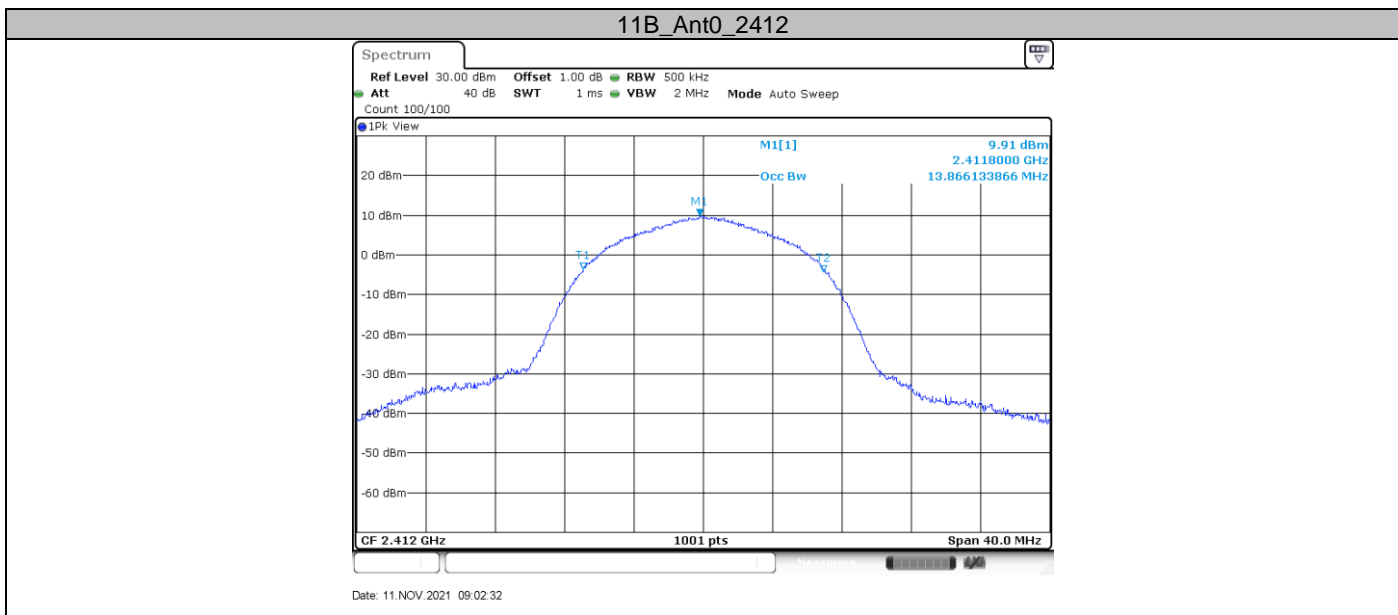

11B_Ant0_2462

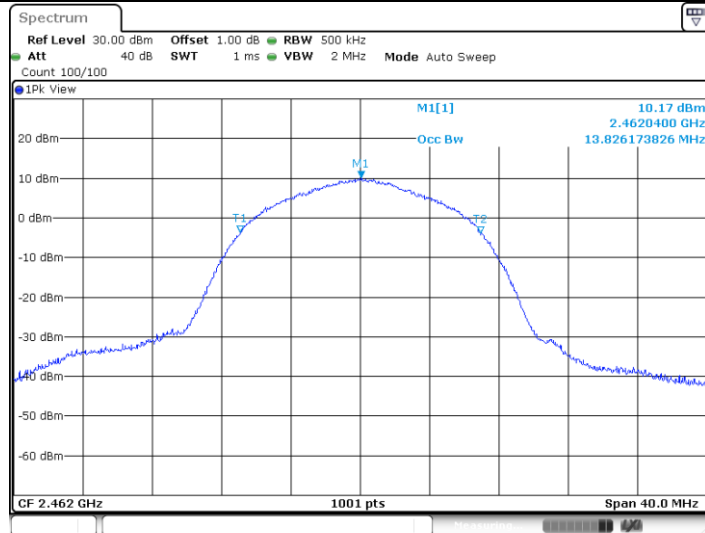

Date: 11.NOV.2021 09:07:38

11G_Ant0_2412

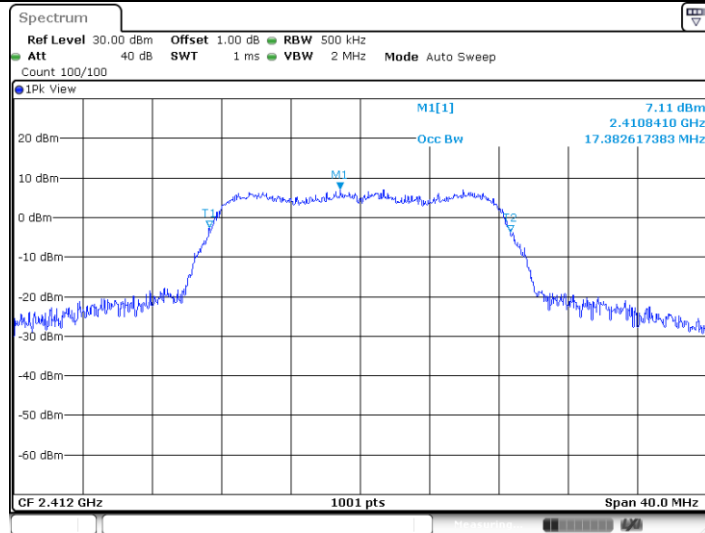

Date: 11.NOV.2021 09:10:10

11G_Ant0_2437

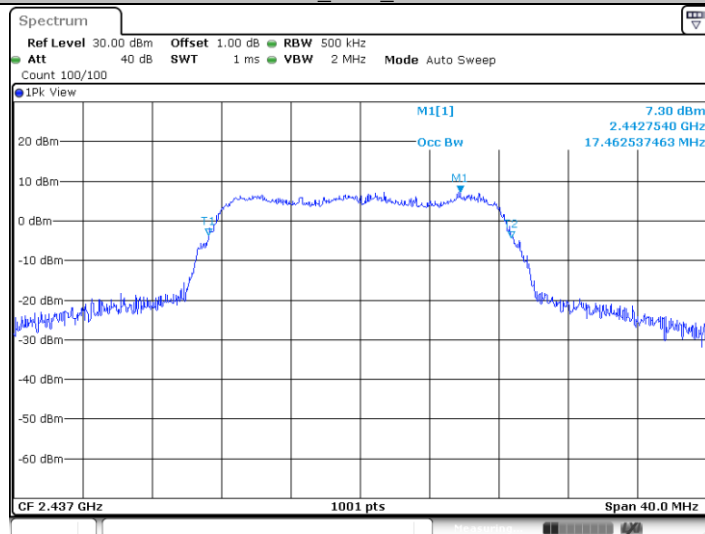

Date: 11.NOV.2021 09:15:14

11G_Ant0_2462

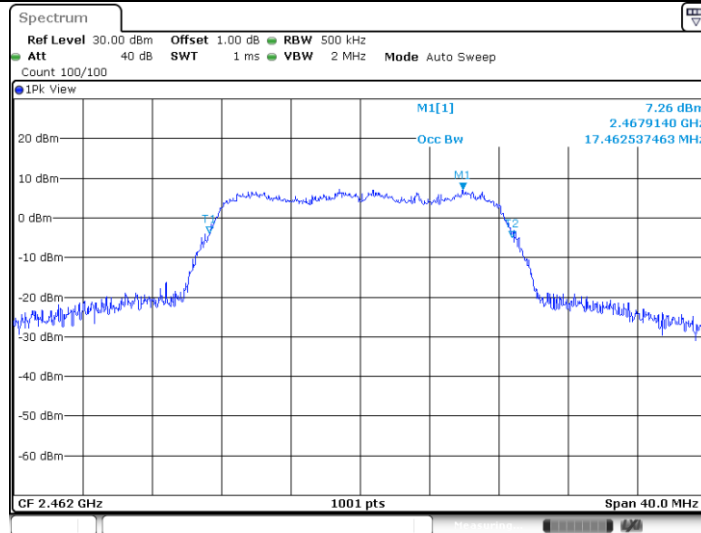

Date: 11.NOV.2021 09:18:02

11N20SISO_Ant0_2412

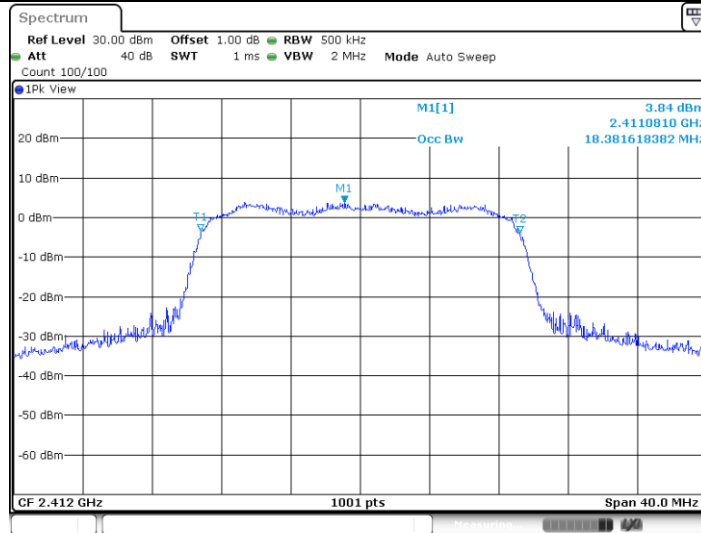

Date: 11.NOV.2021 09:21:52

11N20SISO_Ant0_2437

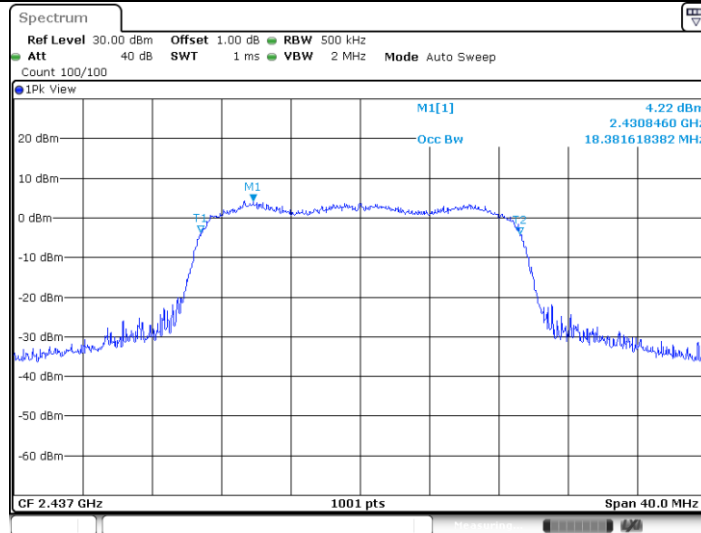

Date: 11.NOV.2021 09:25:39

11N20SISO_Ant0_2462

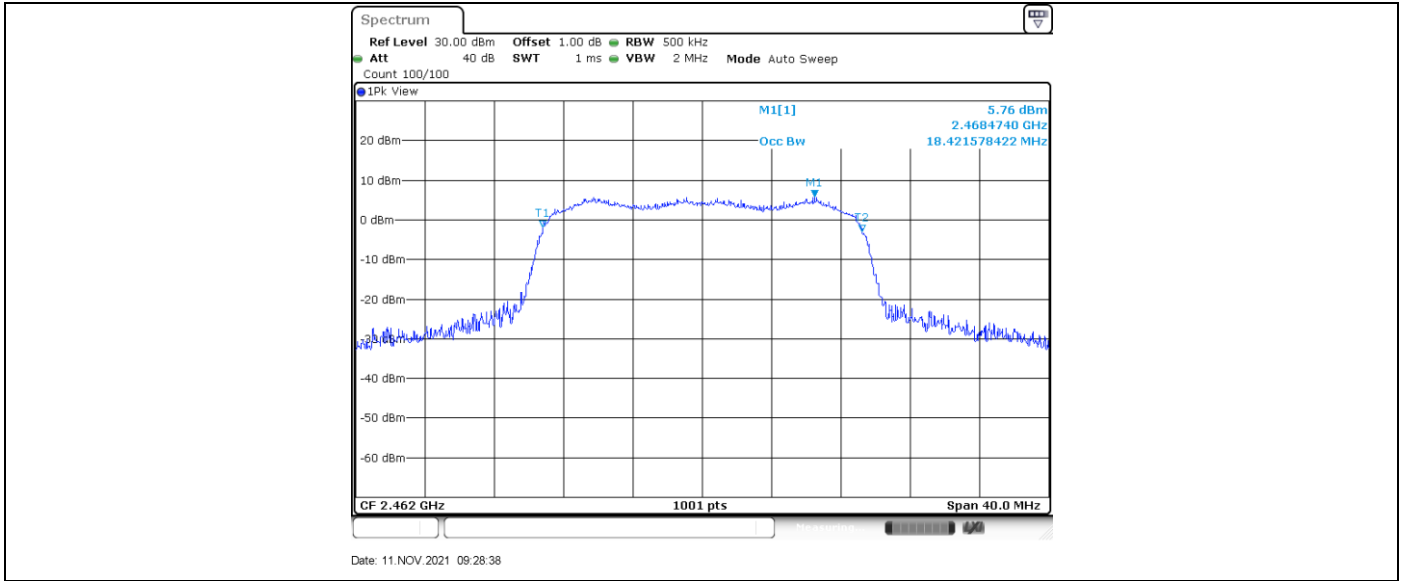

9.4 Power spectral density

Test Method

This procedure shall be used if maximum peak conducted output power was used to demonstrate compliance:

1. The RF output of EUT was connected to the test receiver by RF cable. The path loss was compensated to the results for each measurement.
2. Set analyzer center frequency to DTS channel center frequency. RBW=3kHz, VBW≥3RBW, Span=1.5 times DTS bandwidth, Detector=Peak, Sweep=auto, Trace= max hold.
3. Allow trace to fully stabilize, use the peak marker function to determine the maximum amplitude level within the RBW.
4. Repeat above procedures until other frequencies measured were completed.

Limit

Limit [dBm/3KHz]

≤8

802.11b modulation Test Result

Frequency (MHz)	Power spectral density (dBm/3KHz)	Limit (dBm/3KHz)	Result
	Ant 0		
Low channel 2412MHz	-8.56	8	Pass
Middle channel 2437MHz	-8.48	8	Pass
High channel 2462MHz	-9.46	8	Pass

802.11g modulation Test Result

Frequency (MHz)	Power spectral density (dBm/3KHz)	Limit (dBm/3KHz)	Result
	Ant 0		
Low channel 2412MHz	-13.87	8	Pass
Middle channel 2437MHz	-12.85	8	Pass
High channel 2462MHz	-13.83	8	Pass

802.11n_HT20 modulation Test Result

Frequency (MHz)	Power spectral density (dBm/3KHz)	Limit (dBm/3KHz)	Result
	Ant 0		
Low channel 2412MHz	-14.93	8	Pass
Middle channel 2437MHz	-14.48	8	Pass
High channel 2462MHz	-13.05	8	Pass

11B_Ant0_2412

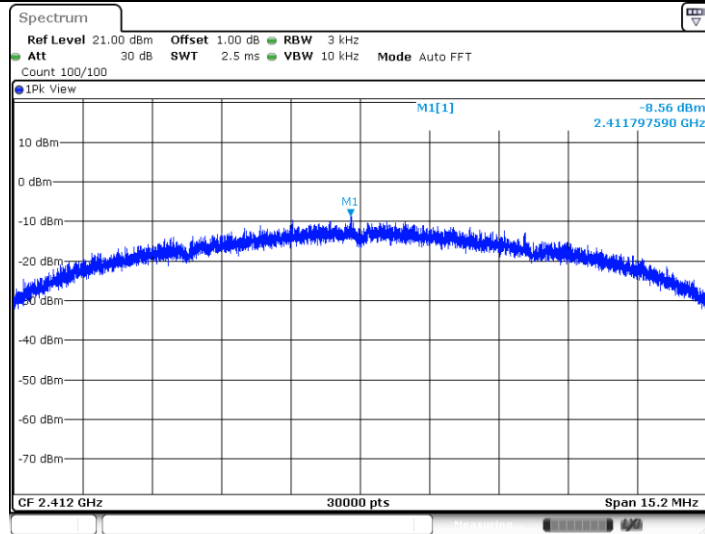

Date: 11.NOV.2021 09:02:44

11B_Ant0_2437

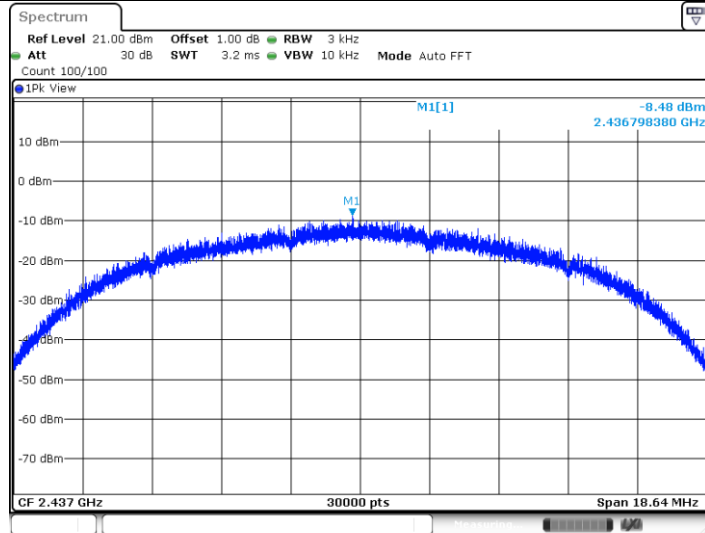

Date: 11.NOV.2021 09:05:36

11B_Ant0_2462

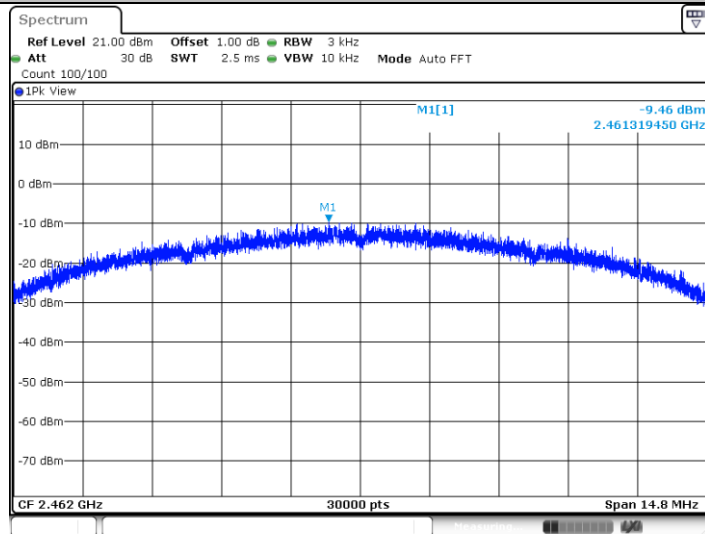

Date: 11.NOV.2021 09:07:49

11G_Ant0_2412

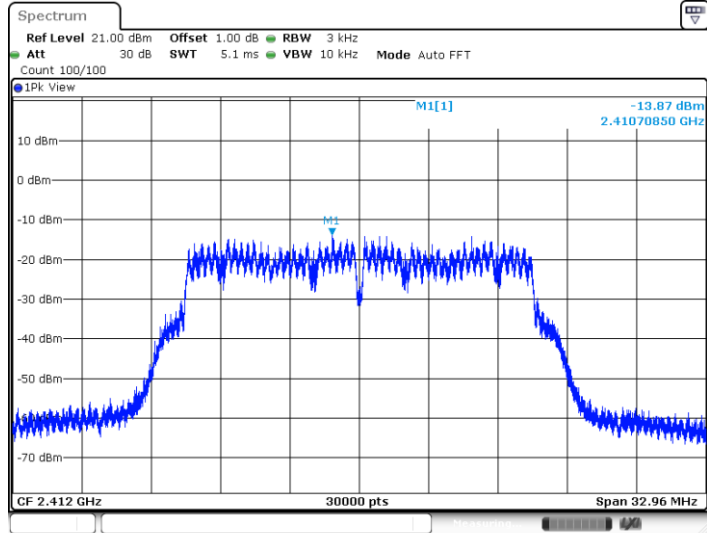

Date: 11.NOV.2021 09:10:22

11G_Ant0_2437

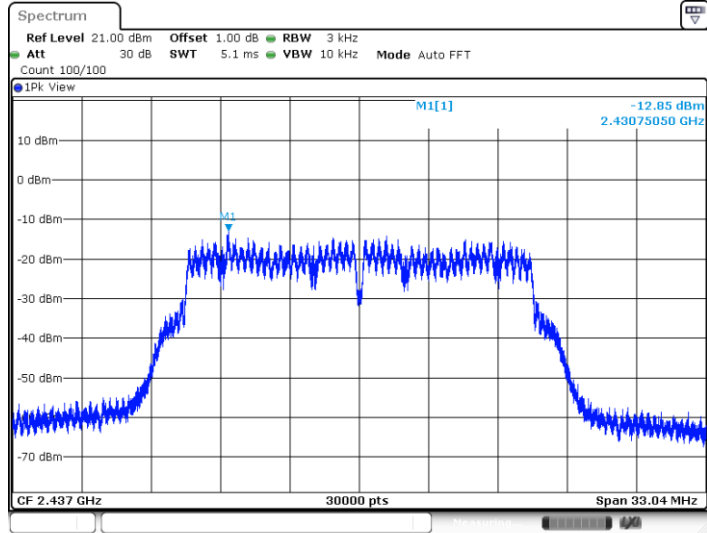

Date: 11.NOV.2021 09:15:26

11G_Ant0_2462

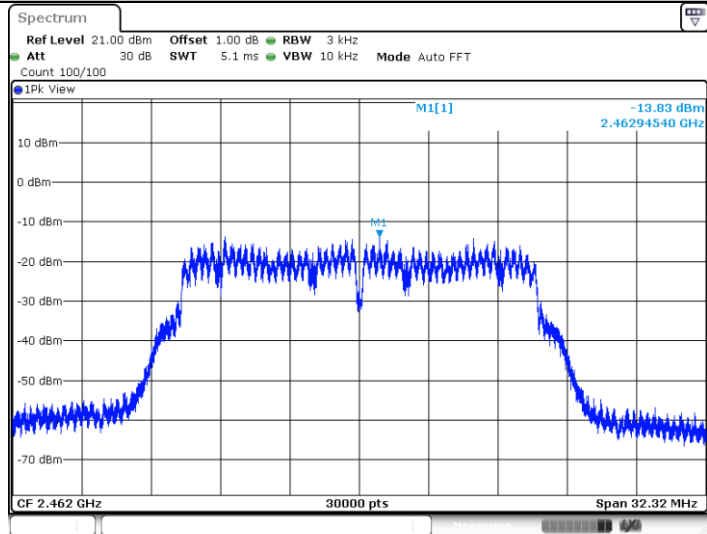

Date: 11.NOV.2021 09:18:14

11N20SISO_Ant0_2412

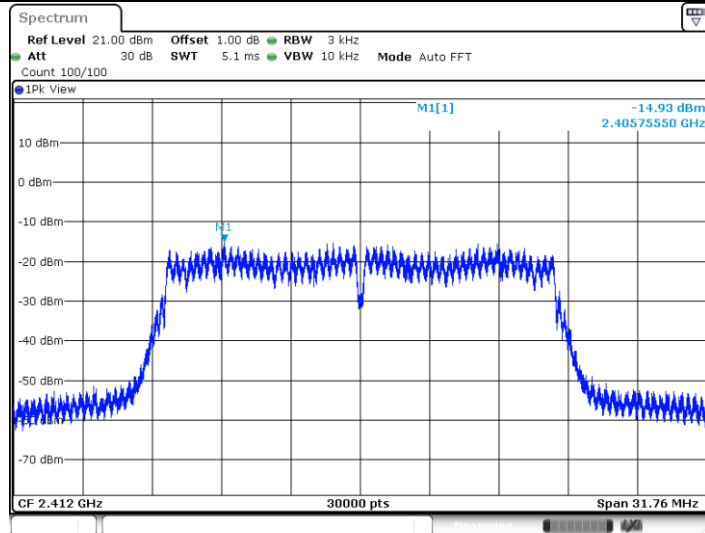

Date: 11.NOV.2021 09:22:04

11N20SISO_Ant0_2437

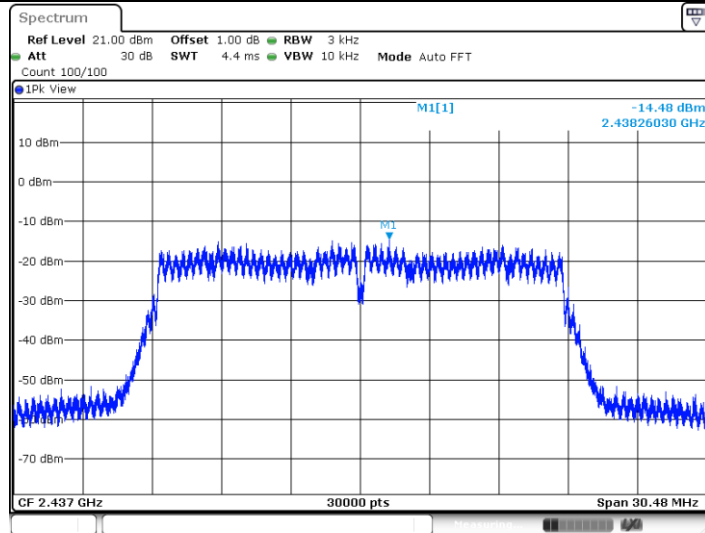

Date: 11.NOV.2021 09:25:50

11N20SISO_Ant0_2462

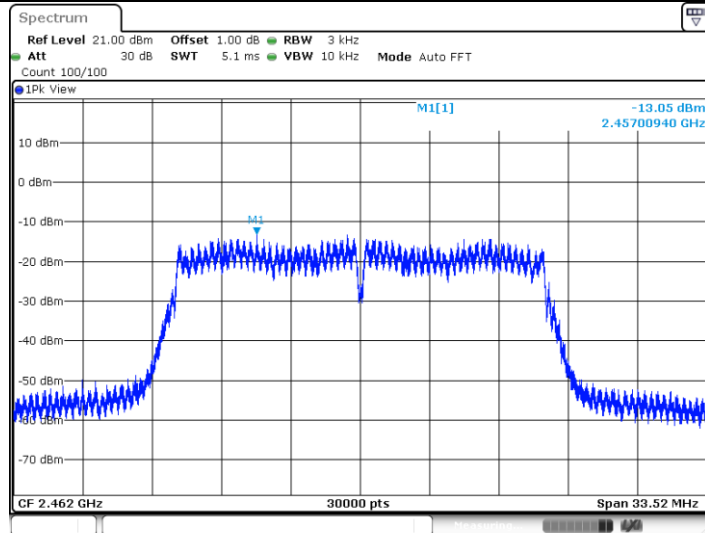

Date: 11.NOV.2021 09:28:50

9.5 Spurious RF conducted emissions

Test Method

1. The RF output of EUT was connected to the spectrum analyzer by RF cable. The path loss was compensated to the results for each measurement.
2. Use the following spectrum analyzer settings:
Span = wide enough to capture the peak level of the in-band emission and all spurious emissions (e.g., harmonics) from the lowest frequency generated in the EUT up through the 10th harmonic. Typically, several plots are required to cover this entire span.
RBW = 100 kHz, VBW \geq RBW, Sweep = auto, Detector function = peak, Trace = max hold
3. Allow the trace to stabilize. Set the marker on the peak of any spurious emission recorded.
4. The level displayed must comply with the limit specified in this Section. Submit these plots.
5. Repeat above procedures until all frequencies measured were complete.

Limit

Frequency Range MHz	Limit (dBm)
30-25000	-20

Spurious RF conducted emissions

TestMode	Antenna	Channel(MHz)	FreqRange(MHz)	RefLevel	Result(dBm)	Limit(dBm)	Verdict
11B	Ant0	2412	Reference	4.57 dBm	4.57	---	PASS
			30~1000	30~1000 MHz	-66.63	<=-16.92	PASS
			1000~26500	1000~26500 MHz	-38.6	<=-16.92	PASS
	Ant0	2437	Reference	4.15 dBm	4.15	---	PASS
			30~1000	30~1000 MHz	-67.7	<=-16.99	PASS
			1000~26500	1000~26500 MHz	-51.84	<=-16.99	PASS
	Ant0	2462	Reference	4.24 dBm	4.24	---	PASS
			30~1000	30~1000 MHz	-67.83	<=-17.1	PASS
			1000~26500	1000~26500 MHz	-51.65	<=-17.1	PASS
11G	Ant0	2412	Reference	0.83 dBm	0.83	---	PASS
			30~1000	30~1000 MHz	-67.06	<=-19.35	PASS
			1000~26500	1000~26500 MHz	-42.32	<=-19.35	PASS
	Ant0	2437	Reference	1.37 dBm	1.37	---	PASS
			30~1000	30~1000 MHz	-68.22	<=-18.79	PASS
			1000~26500	1000~26500 MHz	-50.01	<=-18.79	PASS
	Ant0	2462	Reference	1.00 dBm	1.00	---	PASS
			30~1000	30~1000 MHz	-68.27	<=-19.23	PASS
			1000~26500	1000~26500 MHz	-51.45	<=-19.23	PASS
11N20SISO	Ant0	2412	Reference	-2.31 dBm	-2.31	---	PASS
			30~1000	30~1000 MHz	-68.65	<=-19.11	PASS
			1000~26500	1000~26500 MHz	-39.35	<=-19.11	PASS
	Ant0	2437	Reference	-1.13 dBm	-1.13	---	PASS
			30~1000	30~1000 MHz	-68.36	<=-18.49	PASS
			1000~26500	1000~26500 MHz	-51.7	<=-18.49	PASS
	Ant0	2462	Reference	0.91 dBm	0.91	---	PASS
			30~1000	30~1000 MHz	-67.45	<=-19.17	PASS
			1000~26500	1000~26500 MHz	-50.2	<=-19.17	PASS

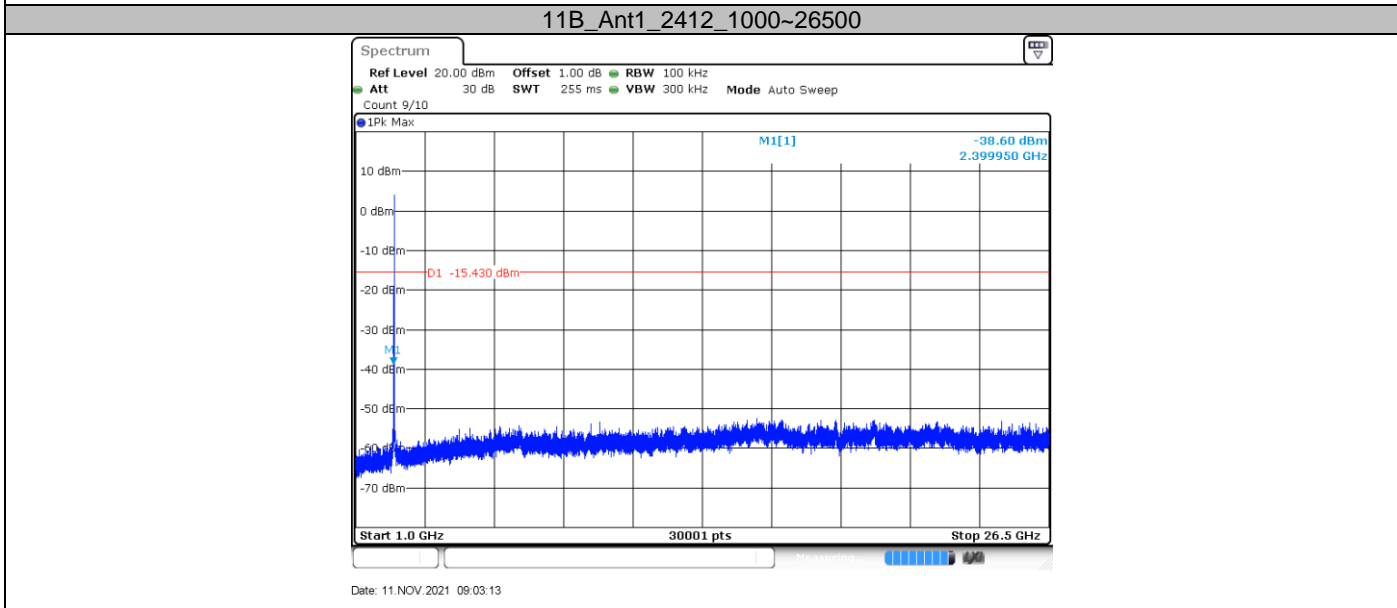
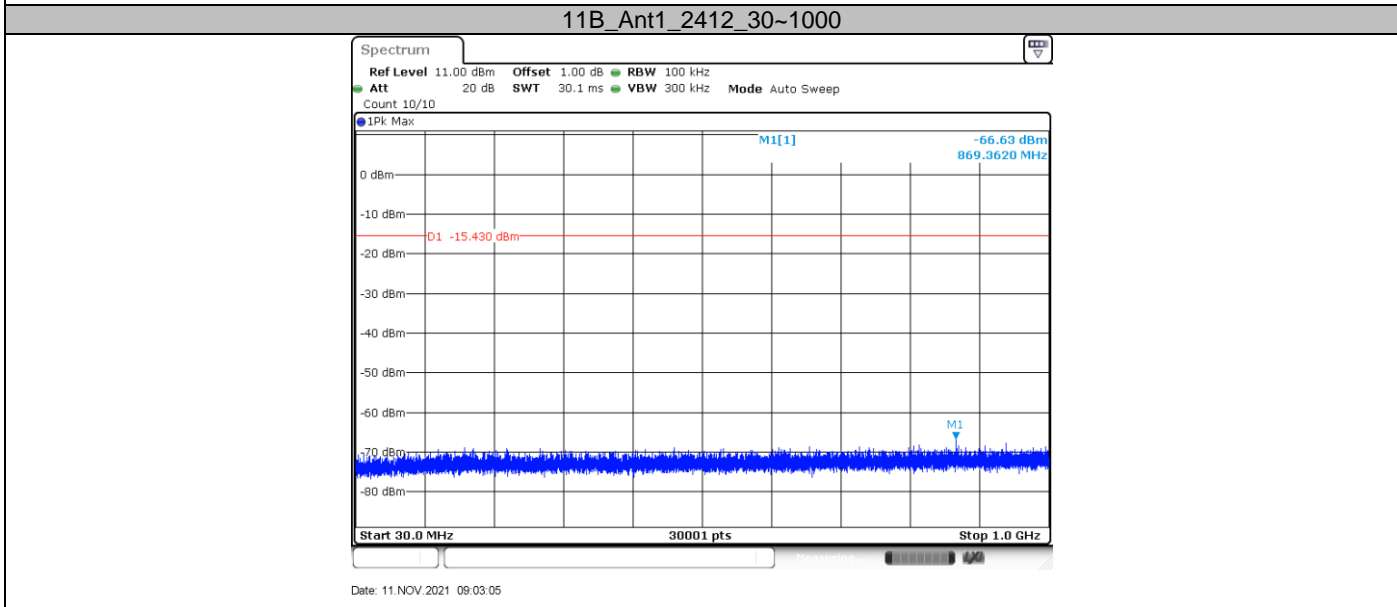
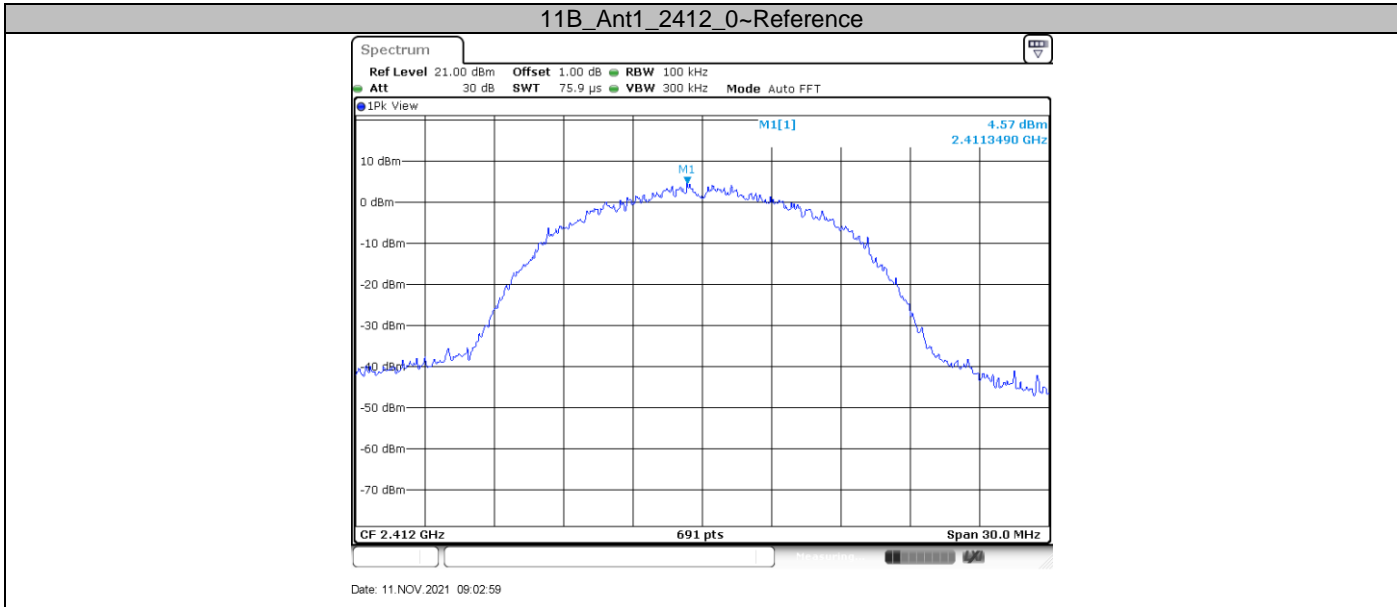

11B_Ant1_2437_0~Reference

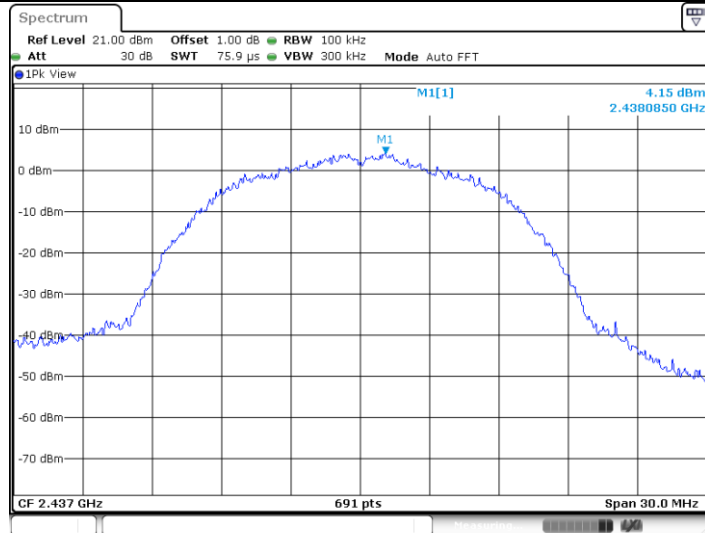

Date: 11.NOV.2021 09:05:41

11B_Ant1_2437_30~1000

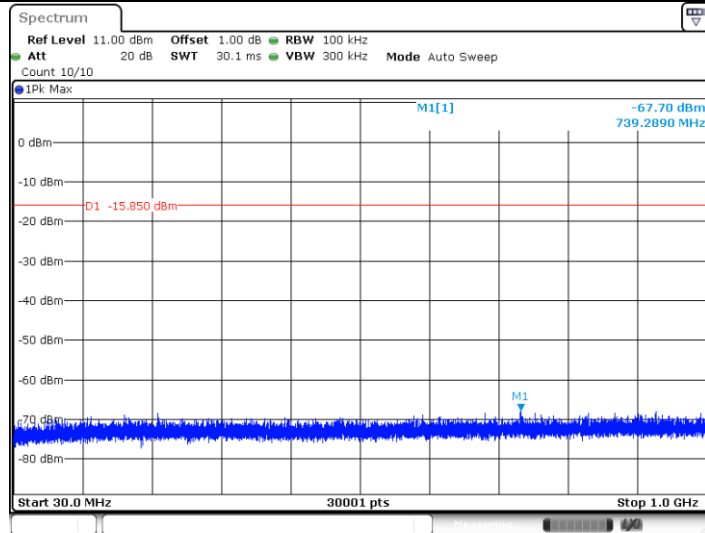

Date: 11.NOV.2021 09:05:47

11B_Ant1_2437_1000~26500

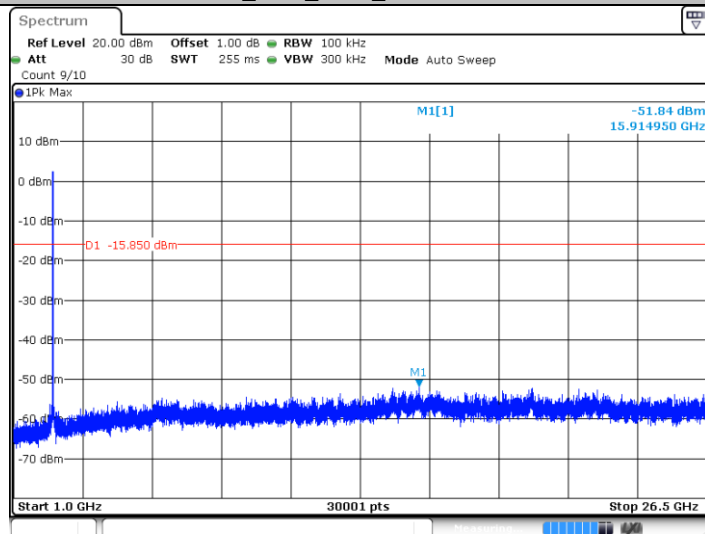

Date: 11.NOV.2021 09:05:55

11B_Ant1_2462_0~Reference

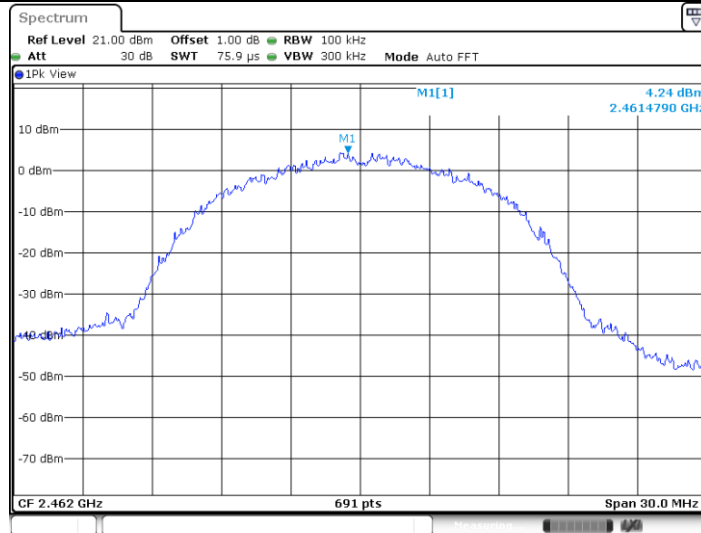

Date: 11.NOV.2021 09:08:04

11B_Ant1_2462_30~1000

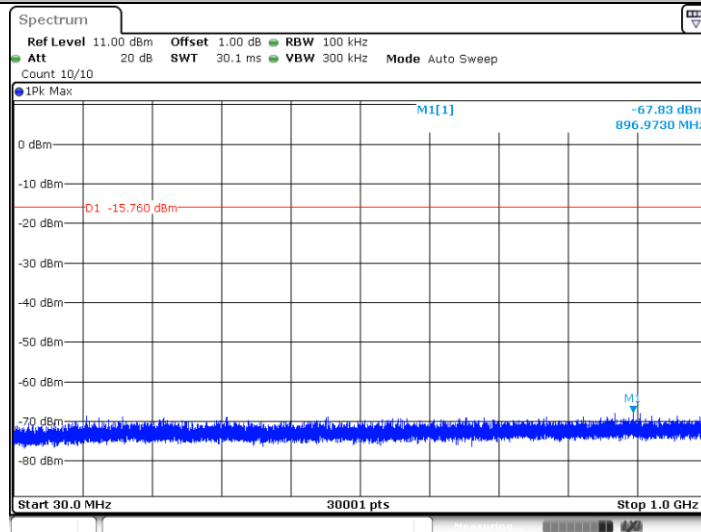

Date: 11.NOV.2021 09:08:10

11B_Ant1_2462_1000~26500

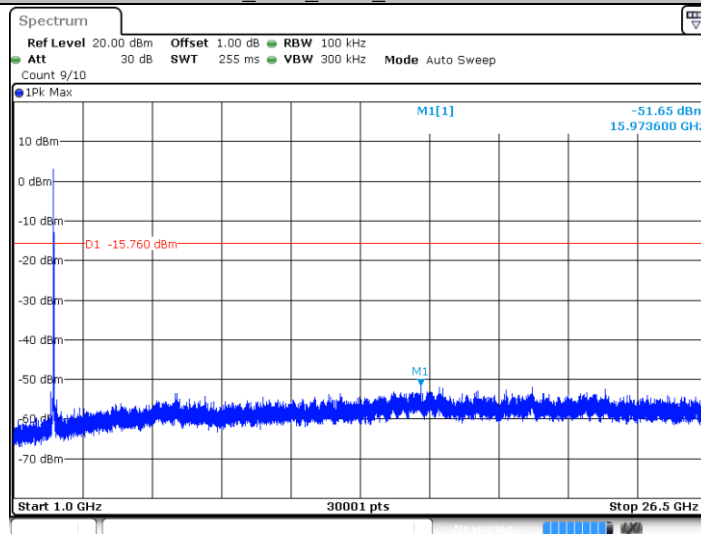

Date: 11.NOV.2021 09:08:18

11G_Ant1_2412_0~Reference

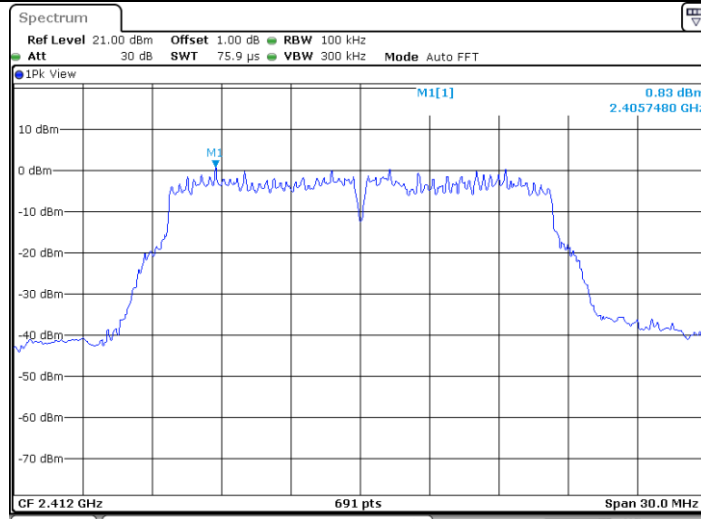

Date: 11.NOV.2021 09:10:37

11G_Ant1_2412_30~1000

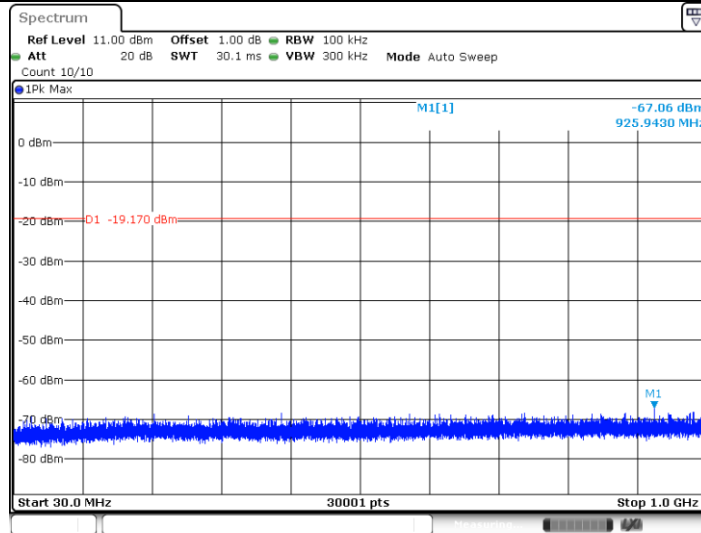

Date: 11.NOV.2021 09:10:43

11G_Ant1_2412_1000~26500

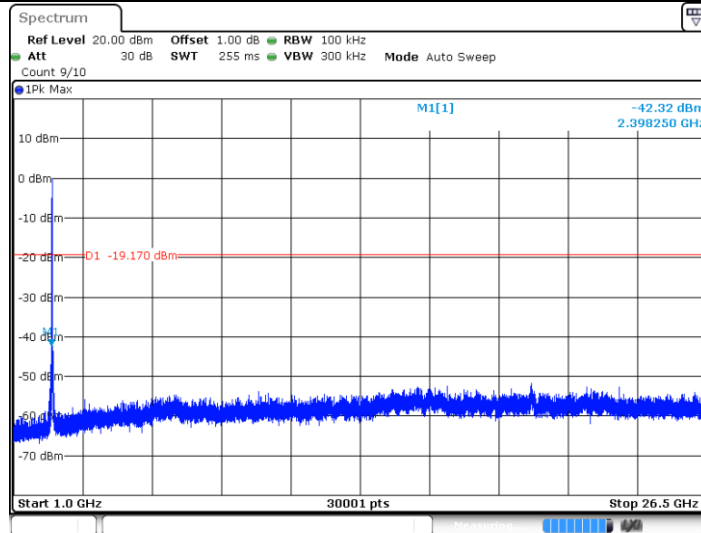

Date: 11.NOV.2021 09:10:50

11G_Ant1_2437_0~Reference

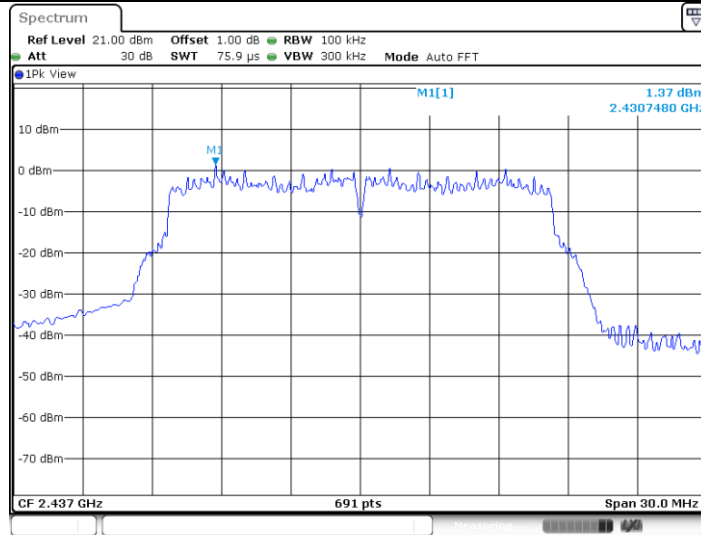

Date: 11.NOV.2021 09:15:31

11G_Ant1_2437_30~1000

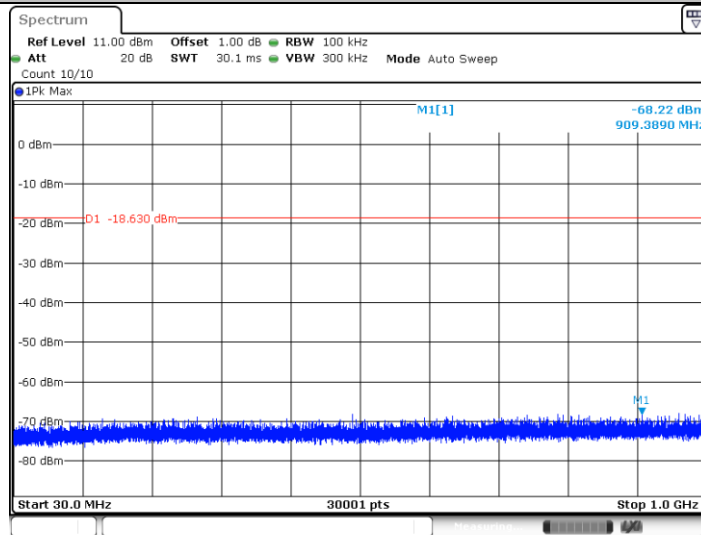

Date: 11.NOV.2021 09:15:37

11G_Ant1_2437_1000~26500

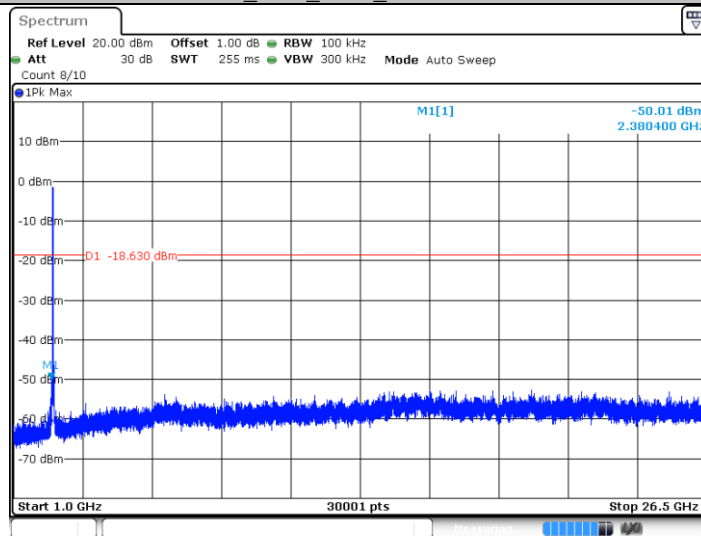

Date: 11.NOV.2021 09:15:45

11G_Ant1_2462_0~Reference

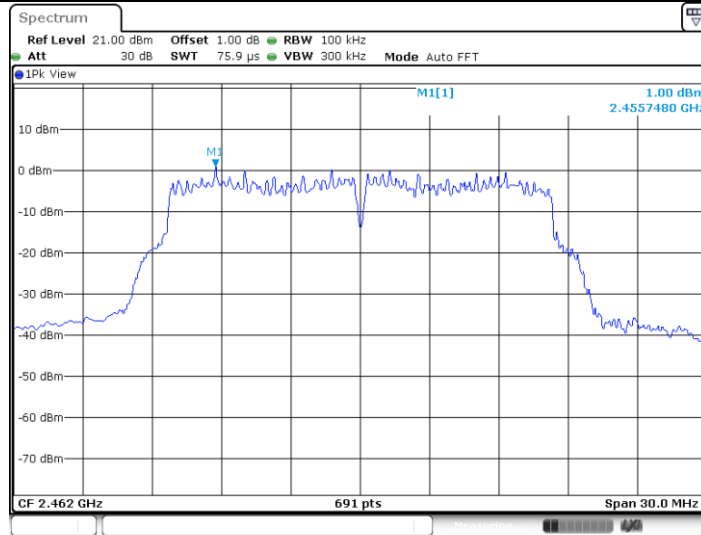

Date: 11.NOV.2021 09:18:29

11G_Ant1_2462_30~1000

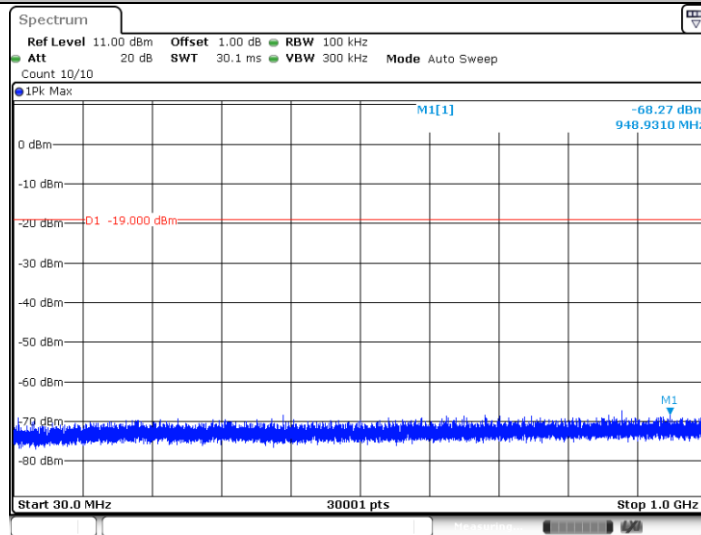

Date: 11.NOV.2021 09:18:35

11G_Ant1_2462_1000~26500

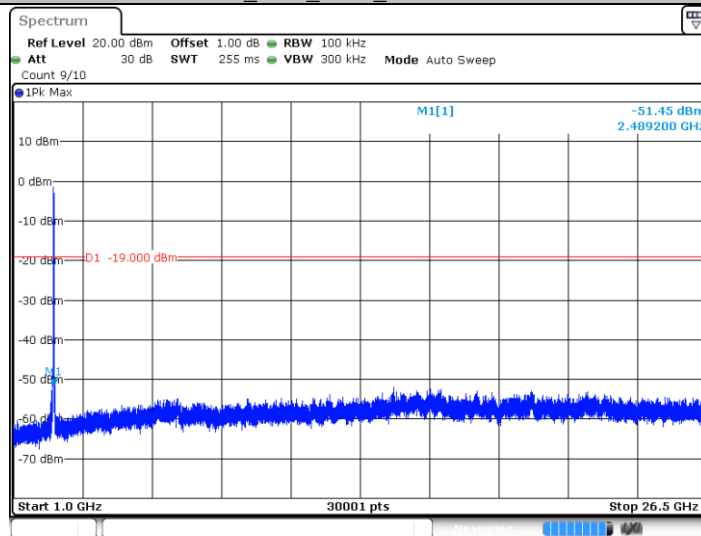

Date: 11.NOV.2021 09:18:43

11N20SISO_Ant1_2412_0~Reference

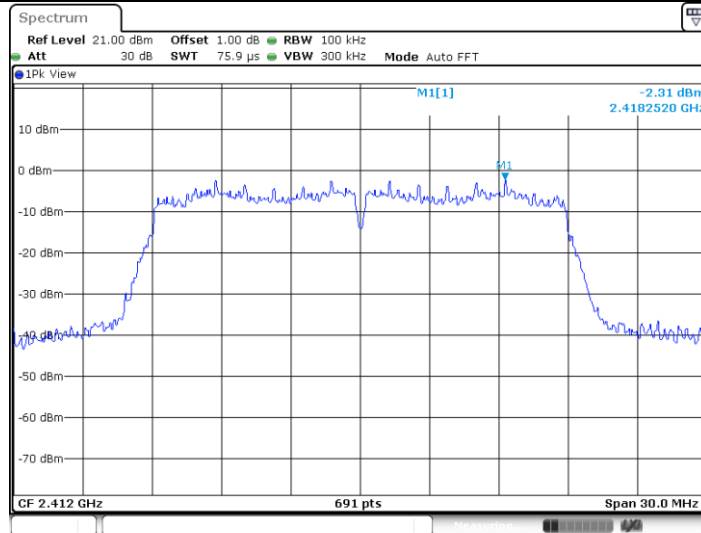

Date: 11.NOV.2021 09:22:19

11N20SISO_Ant1_2412_30~1000

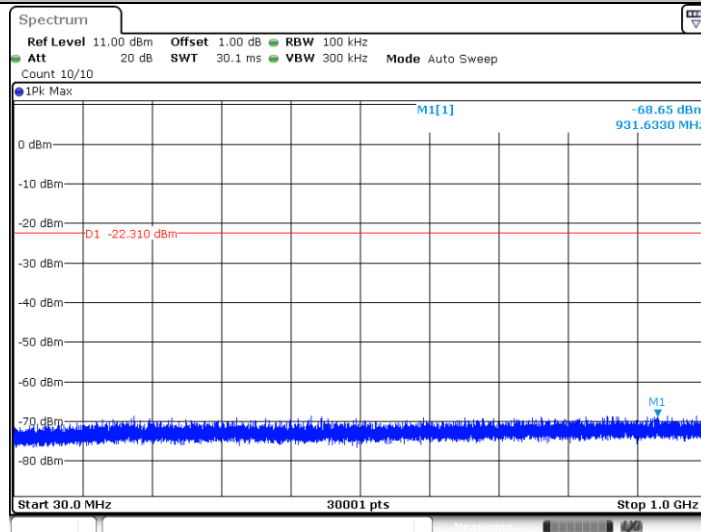

Date: 11.NOV.2021 09:22:25

11N20SISO_Ant1_2412_1000~26500

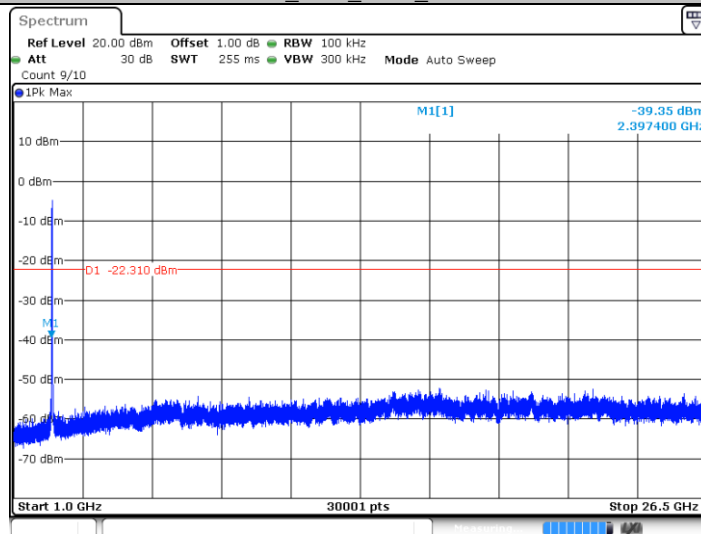

Date: 11.NOV.2021 09:22:33

11N20SISO_Ant1_2437_0~Reference

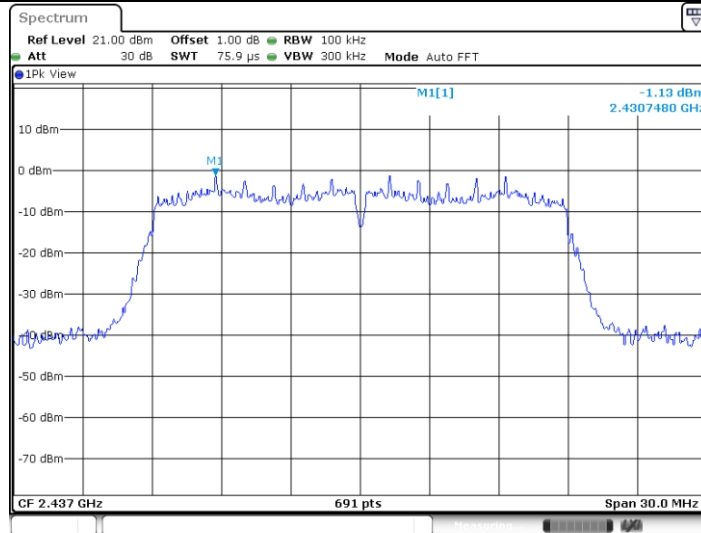

Date: 11.NOV.2021 09:25:56

11N20SISO_Ant1_2437_30~1000

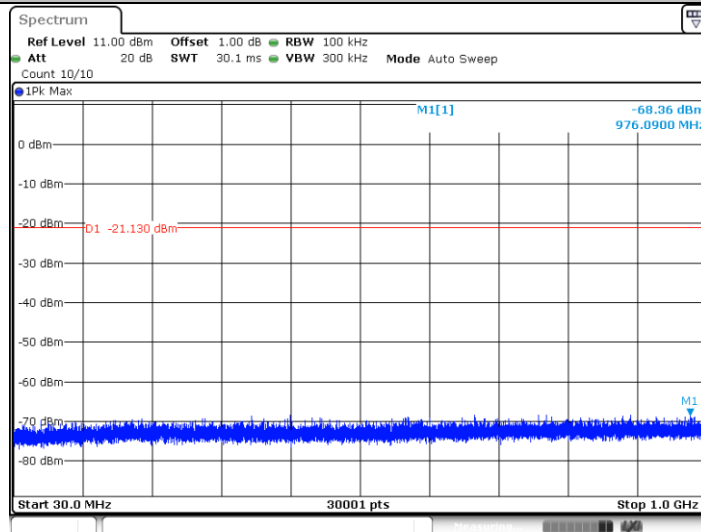

Date: 11.NOV.2021 09:26:02

11N20SISO_Ant1_2437_1000~26500

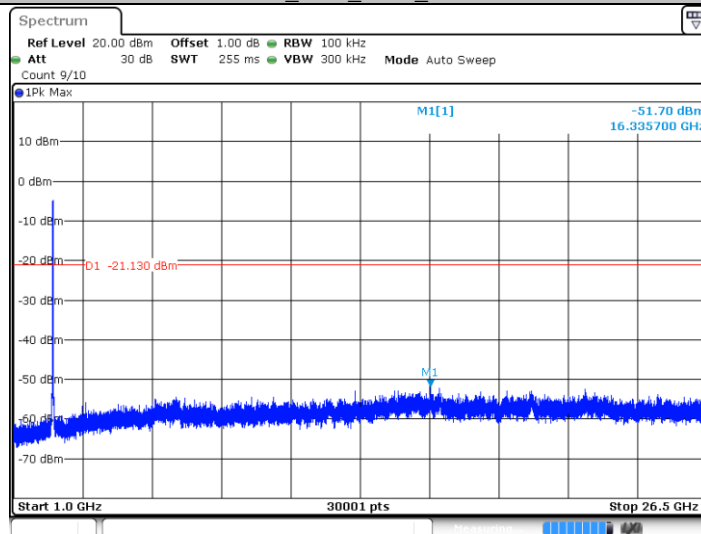

Date: 11.NOV.2021 09:26:10

11N20SISO_Ant1_2462_0~Reference

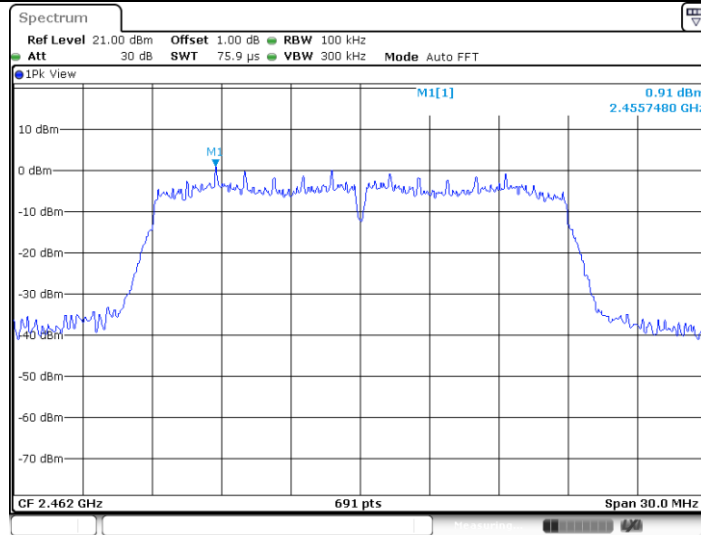

Date: 11.NOV.2021 09:29:05

11N20SISO_Ant1_2462_30~1000

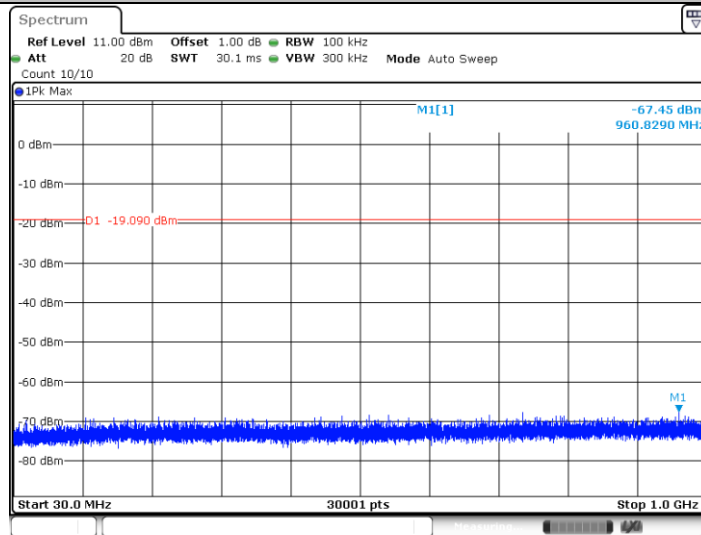

Date: 11.NOV.2021 09:29:11

11N20SISO_Ant1_2462_1000~26500

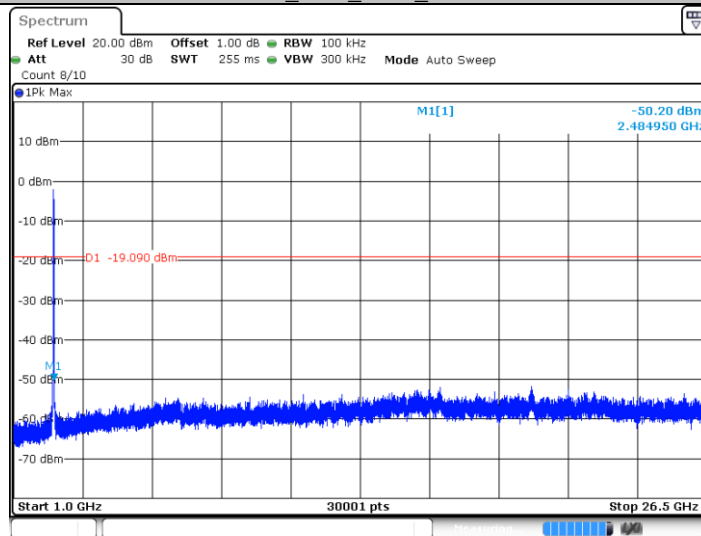

Date: 11.NOV.2021 09:29:19

9.6 Band edge testing

Test Method

1. The RF output of EUT was connected to the spectrum analyzer by RF cable. The path loss was compensated to the results for each measurement.
2. Use the following spectrum analyzer settings:
Span = wide enough to capture the peak level of the in-band emission and all spurious
RBW = 100 kHz, VBW \geq RBW, Sweep = auto, Detector function = peak, Trace = max hold
3. Allow the trace to stabilize, use the peak and delta measurement to record the result.
4. The level displayed must comply with the limit specified in this Section.
5. Repeat the test at the hopping off and hopping on mode, submit all the plots.

Limit:

According to §15.247(d), in any 100 kHz bandwidth outside the frequency bands in which the spread spectrum intentional radiator is operating, the radio frequency power that is produced by the intentional radiator shall be at least 20 dB below that in the 100 kHz bandwidth within the band that contains the highest level of the desired power, based on either an RF conducted or a radiated measurement, provided the transmitter demonstrates compliance with the peak conducted power limits. In addition, radiated emissions which fall in the restricted bands, as defined in §15.205(a), must also comply with the radiated emission limits specified in 15.209(a) (see Section 15.205(c)).

Frequency Range MHz	Limit (dBc)
30-25000	-20

Band edge testing

TestMode	Antenna	ChName	Channel (MHz)	RefLevel (dBm)	Result (dBm)	Limit (dBm)	Verdict
11B	Ant0	Low	2412	4.60	-38.1	<=-15.4	PASS
	Ant0	High	2462	4.37	-52.33	<=-15.63	PASS
11G	Ant0	Low	2412	0.19	-37.12	<=-19.81	PASS
	Ant0	High	2462	0.93	-45.6	<=-19.07	PASS
11N20	Ant0	Low	2412	-1.38	-37.6	<=-21.38	PASS
	Ant0	Low	2462	1.18	-44.04	<=-18.82	PASS

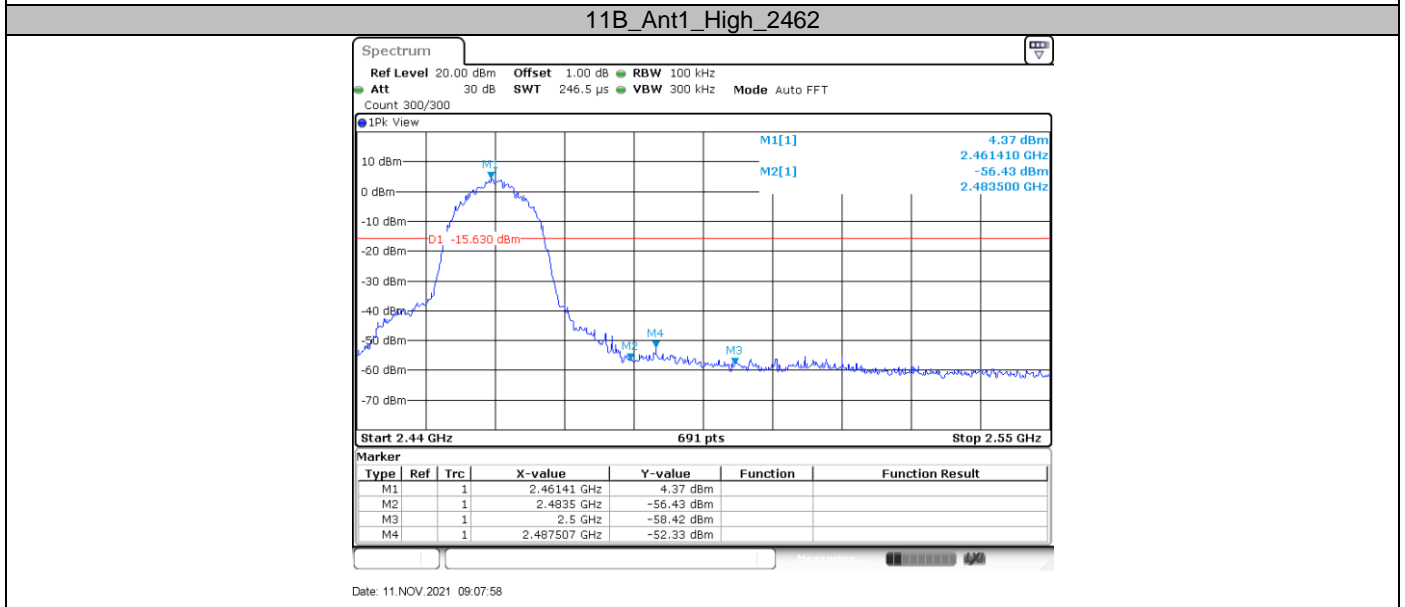
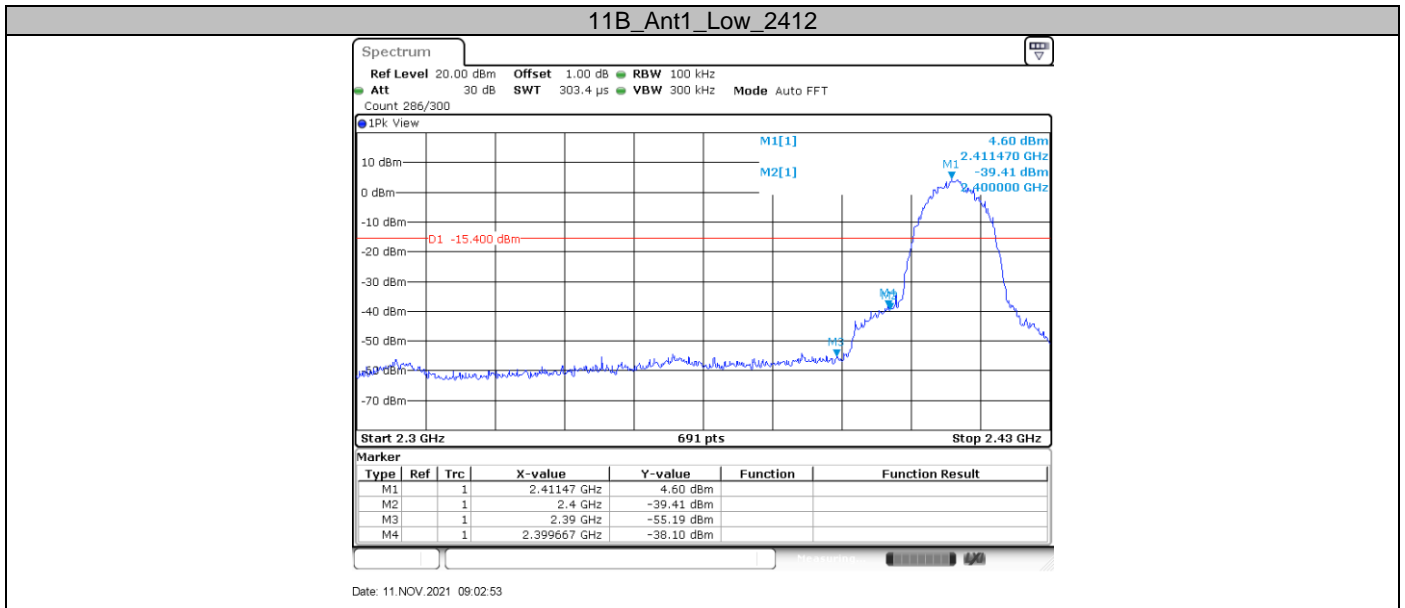

11G_Ant1_Low_2412

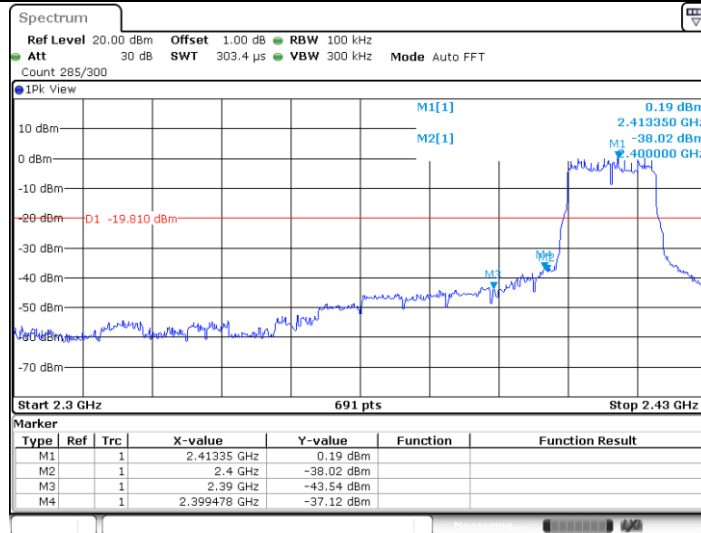

Date: 11.NOV.2021 09:10:31

11G Ant1_High_2462

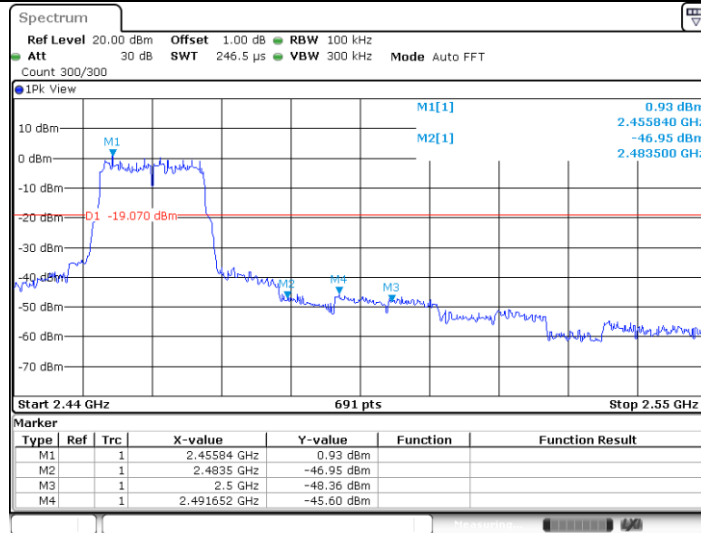

Date: 11.NOV.2021 09:18:23

11N20SISO Ant1_Low_2412

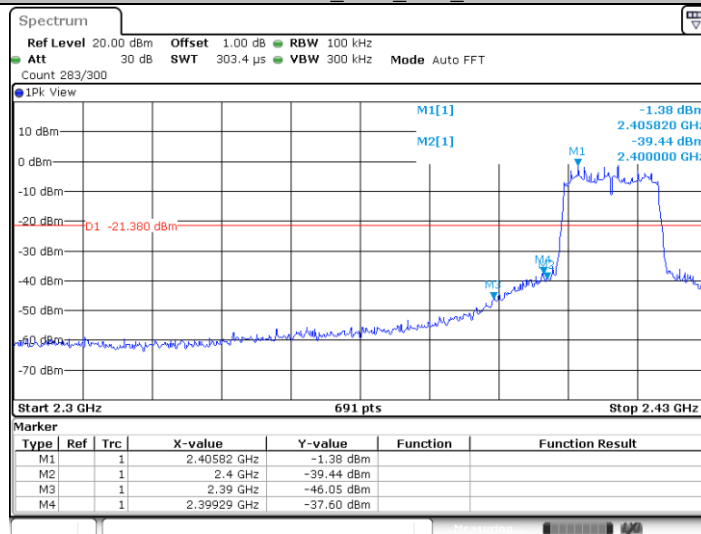

Date: 11.NOV.2021 09:22:13

11N20SISO Ant1_High_2462

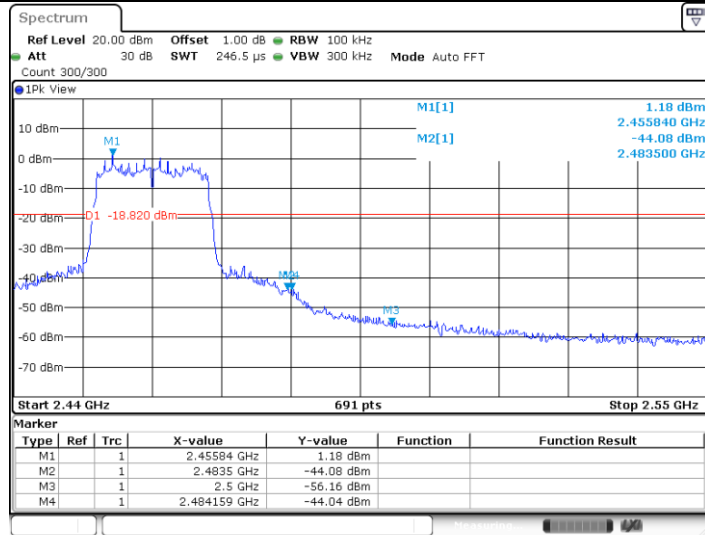

Date: 11.NOV.2021 09:28:59

9.7 Spurious radiated emissions for transmitter

Test Method

1. The EUT was placed on a turn table which is 1.5m above ground plane for above 1GHz and 0.8m above ground for below 1GHz at 3 meters chamber room for test. The table was rotated 360 degrees to determine the position of the highest radiation.
2. Set to the maximum power setting and enable the EUT transmit continuously
3. The EUT was set 3 meters away from the interference – receiving antenna, which was mounted on the top of a variable – height antenna tower.
4. The height of antenna is varied from one meter to four meters above the ground to determine the maximum value of the field strength. Both horizontal and vertical polarizations of the antenna are set to make the measurement.
5. For each suspected emission, the EUT was arranged to its worst case and then the antenna was tuned to heights from 1 meter to 4 meters and the rotatable table was turned from 0 degrees to 360 degrees to find the maximum reading.
6. Use the following spectrum analyzer settings According to C63.10:
For Below 1GHz
Use the following spectrum analyzer settings:
Span = wide enough to capture the peak level of the in-band emission and all spurious
RBW = 100 KHz to 120KHz, VBW \geq RBW for peak measurement, Sweep = auto, Detector function = peak, Trace = max hold.

For Peak unwanted emissions Above 1GHz:

Span = wide enough to capture the peak level of the in-band emission and all spurious
RBW = 1MHz, VBW \geq RBW for peak measurement, Sweep = auto, Detector function = peak, Trace = max hold.

Procedures for average unwanted emissions measurements above 1000 MHz

a) RBW = 1MHz.

b) VBW \ [3 \times RBW].

c) Detector = RMS (power averaging), if [span / (# of points in sweep)] \ RBW / 2.

Satisfying this condition can require increasing the number of points in the sweep or reducing the span. If the condition is not satisfied, then the detector mode shall be set to peak.

d) Averaging type = power (i.e., rms) (As an alternative, the detector and averaging type may be set for linear voltage averaging. Some instruments require linear display mode to use linear voltage averaging. Log or dB averaging shall not be used.)

e) Sweep time = auto.

f) Perform a trace average of at least 100 traces if the transmission is continuous. If the transmission is not continuous, then the number of traces shall be increased by a factor of 1 / D, where D is the duty cycle. For example, with 50% duty cycle, at least 200 traces shall be averaged. (If a specific emission is demonstrated to be continuous—i.e., 100% duty cycle—then rather than turning ON and OFF with the transmit cycle, at least 100 traces shall be averaged.)

g) If tests are performed with the EUT transmitting at a duty cycle less than 98%, then a correction factor shall be added to the measurement results prior to comparing with the emission limit, to compute the emission level that would have been measured had the test been performed at 100% duty cycle. The correction factor is computed as follows:

- 1) If power averaging (rms) mode was used in the preceding step e), then the correction factor is $[10 \log (1 / D)]$, where D is the duty cycle. For example, if the transmit duty cycle was 50%, then 3 dB shall be added to the measured emission levels.
- 2) If linear voltage averaging mode was used in the preceding step e), then the correction factor is $[20 \log (1 / D)]$, where D is the duty cycle. For example, if the transmit duty cycle was 50%, then 6 dB shall be added to the measured emission levels.
- 3) If a specific emission is demonstrated to be continuous (100% duty cycle) rather than turning ON and OFF with the transmit cycle, then no duty cycle correction is required for that emission.

Limit

The radio emission outside the operating frequency band shall be at least 20 dB below that in the 100 kHz bandwidth within the band that contains the highest level of the desired power. Radiated emissions which fall in the restricted bands, as defined in section 15.205, must comply with the radiated emission limits specified in section 15.209.

Frequency MHz	Field Strength μ V/m	Field Strength dB μ V/m	Detector
30-88	100	40	QP
88-216	150	43.5	QP
216-960	200	46	QP
960-1000	500	54	QP
Above 1000	500	54	AV
Above 1000	5000	74	PK

Spurious radiated emissions for transmitter

According to C63.10, if the peak (or quasi-peak) measured value complies with the average limit, it is unnecessary to perform an average measurement, so AV emission value did not show in below table if the peak value complies with average limit.

Transmitting spurious emission test result as below:

30MHz to 1000MHz:

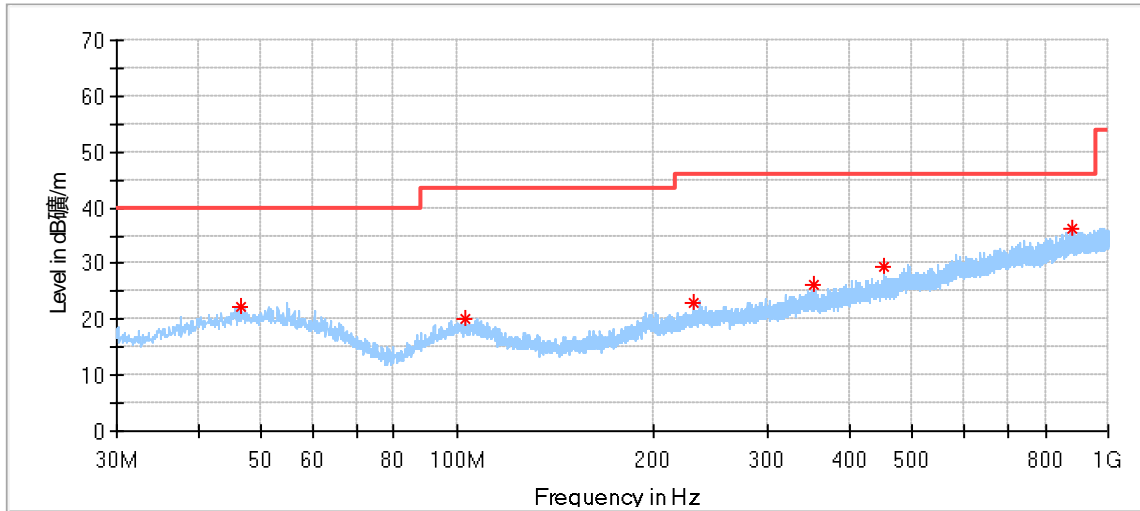

Frequency (MHz)	MaxPeak (dBµV/m)	Limit (dBµV/m)	Margin (dB)	Height (cm)	Pol	Azimuth (deg)	Corr. (dB/m)
46.436111	22.11	40.00	17.89	100.0	H	130.0	21.01
103.181111	20.14	43.50	23.36	200.0	H	260.0	18.64
230.574444	22.86	46.00	23.14	100.0	H	94.0	19.14
352.686667	26.12	46.00	19.88	200.0	H	34.0	22.26
453.081667	29.44	46.00	16.56	200.0	H	316.0	24.30
882.360556	36.42	46.00	9.58	100.0	H	294.0	31.43

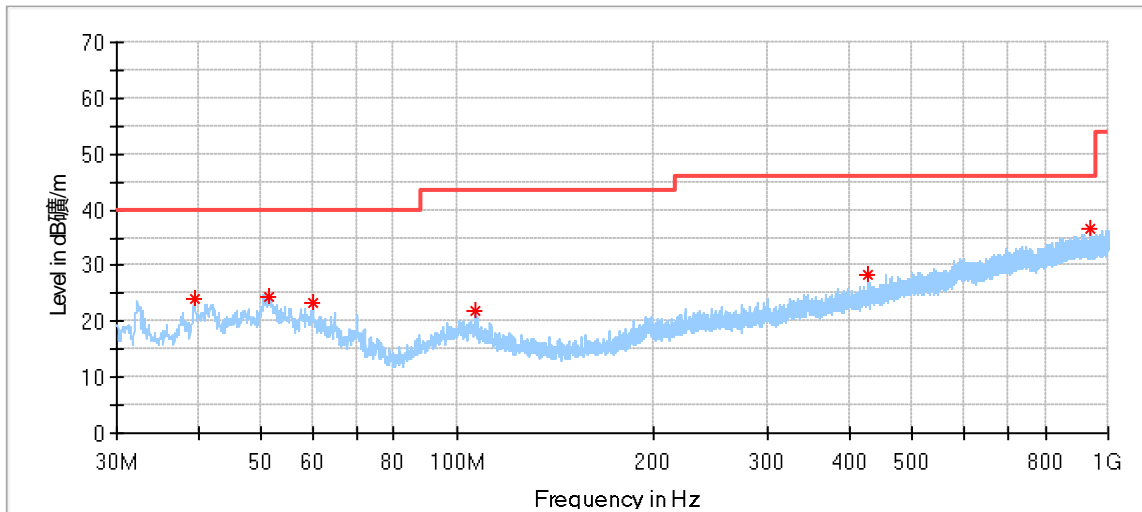

Frequency (MHz)	MaxPeak (dBµV/m)	Limit (dBµV/m)	Margin (dB)	Height (cm)	Pol	Azimuth (deg)	Corr. (dB/m)
39.484444	24.15	40.00	15.85	100.0	V	4.0	19.35
51.286111	24.29	40.00	15.71	100.0	V	213.0	20.81
59.962222	23.46	40.00	16.54	100.0	V	271.0	19.51
106.683889	21.76	43.50	21.74	100.0	V	221.0	18.43
426.730000	28.19	46.00	17.81	100.0	V	4.0	24.06
936.357222	36.53	46.00	9.47	100.0	V	36.0	31.71

1GHz -18GHz:

11B-Ant0_2412MHz

Horizontal:

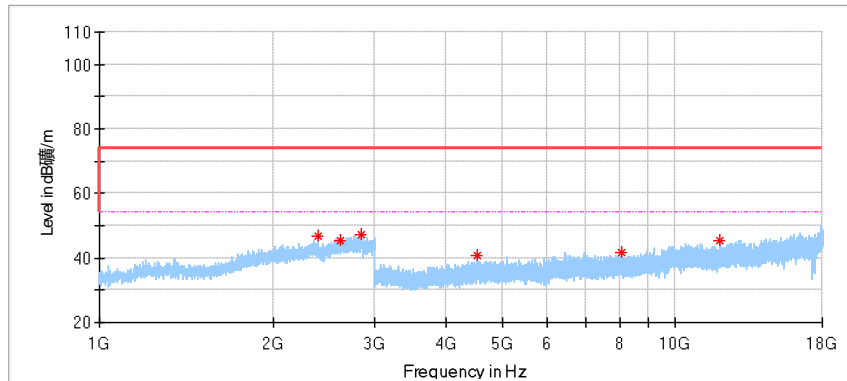

Frequency (MHz)	MaxPeak (dBµV/m)	Limit (dBµV/m)	Margin (dB)	Height (cm)	Pol	Azimuth (deg)	Corr. (dB/m)
2392.380952	46.85	74.00	27.15	150.0	H	344.0	-2.22
2621.428571	45.18	74.00	28.82	150.0	H	143.0	-1.44
2849.523810	47.44	74.00	26.56	150.0	H	0.0	-1.04
4539.000000	40.90	74.00	33.10	150.0	H	149.0	2.78
8067.000000	41.51	74.00	32.49	150.0	H	297.0	7.98
11957.500000	45.58	74.00	28.42	150.0	H	11.0	11.83

Vertical

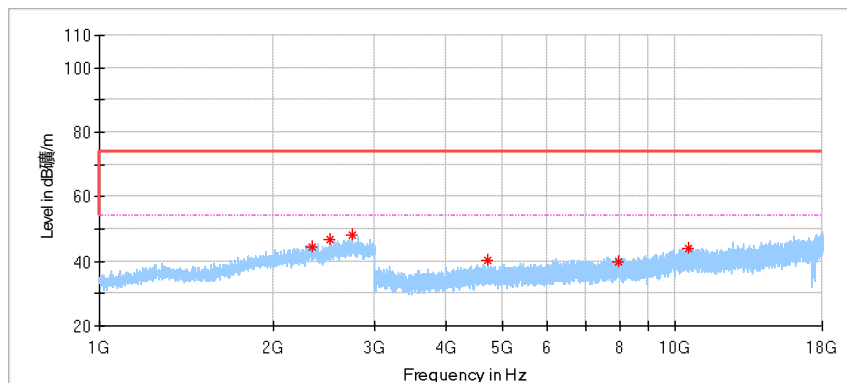

Frequency (MHz)	MaxPeak (dBµV/m)	Limit (dBµV/m)	Margin (dB)	Height (cm)	Pol	Azimuth (deg)	Corr. (dB/m)
2341.904762	44.54	74.00	29.46	150.0	V	13.0	-2.33
2513.809524	46.72	74.00	27.28	150.0	V	55.0	-1.77
2753.333333	48.11	74.00	25.89	150.0	V	202.0	-1.20
4735.500000	40.30	74.00	33.70	150.0	V	297.0	3.47
7987.500000	40.02	74.00	33.98	150.0	V	122.0	8.10
10567.500000	43.89	74.00	30.11	150.0	V	268.0	10.74

11B-Ant0_2437MHz
Horizontal:

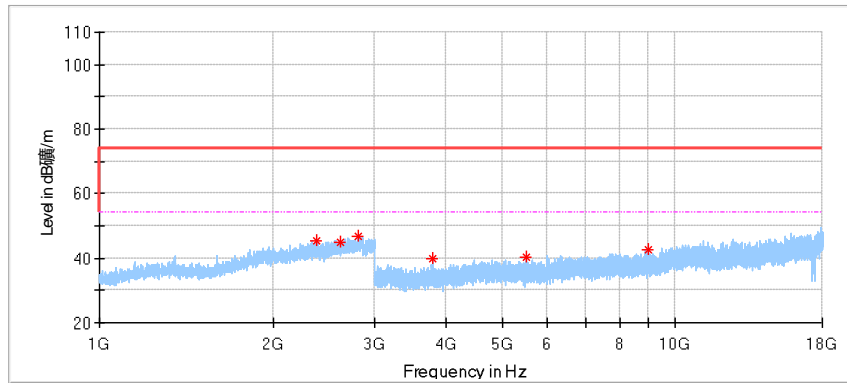

Frequency (MHz)	MaxPeak (dBµV/m)	Limit (dBµV/m)	Margin (dB)	Height (cm)	Pol	Azimuth (deg)	Corr. (dB/m)
2387.619048	45.53	74.00	28.47	150.0	H	282.0	-2.24
2618.571429	45.04	74.00	28.96	150.0	H	69.0	-1.45
2809.047619	46.64	74.00	27.36	150.0	H	99.0	-1.09
3781.500000	39.86	74.00	34.14	150.0	H	266.0	0.54
5517.500000	40.14	74.00	33.86	150.0	H	233.0	4.77
8975.000000	42.47	74.00	31.53	150.0	H	115.0	9.02

Vertical

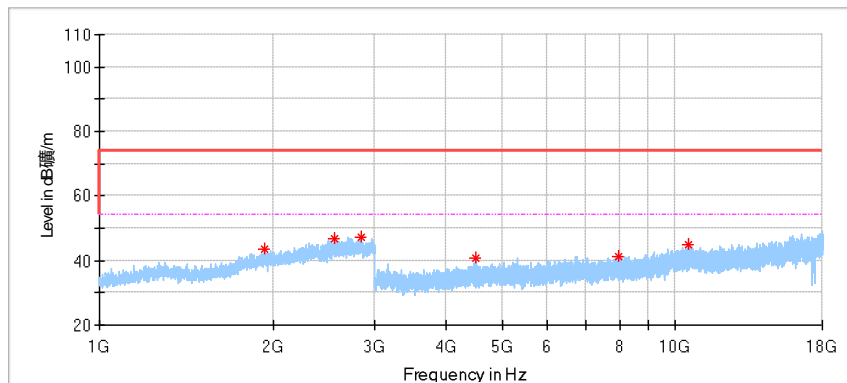

Frequency (MHz)	MaxPeak (dBµV/m)	Limit (dBµV/m)	Margin (dB)	Height (cm)	Pol	Azimuth (deg)	Corr. (dB/m)
1938.571429	43.48	74.00	30.52	150.0	V	8.0	-3.94
2564.285714	46.92	74.00	27.08	150.0	V	106.0	-1.55
2843.809524	47.18	74.00	26.82	150.0	V	114.0	-1.05
4502.000000	40.55	74.00	33.45	150.0	V	179.0	2.74
7981.000000	41.07	74.00	32.93	150.0	V	66.0	8.10
10525.500000	45.09	74.00	28.91	150.0	V	122.0	10.73

11B-Ant0_2462MHz
Horizontal:

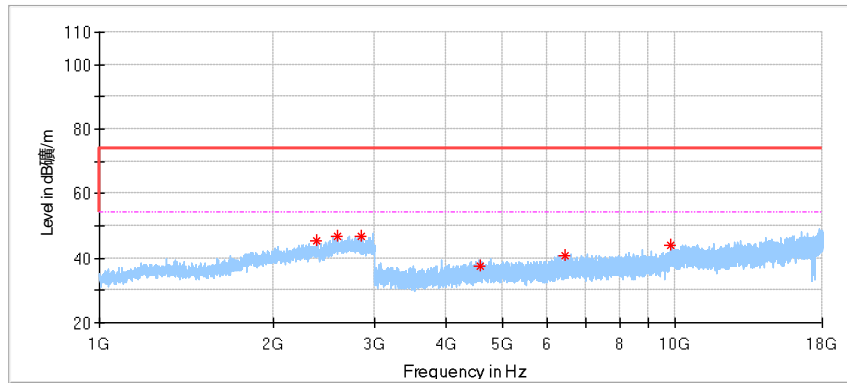

Frequency (MHz)	MaxPeak (dBµV/m)	Limit (dBµV/m)	Margin (dB)	Height (cm)	Pol	Azimuth (deg)	Corr. (dB/m)
2376.666667	45.30	74.00	28.70	150.0	H	128.0	-2.29
2590.476191	46.68	74.00	27.32	150.0	H	0.0	-1.52
2841.428571	46.64	74.00	27.36	150.0	H	128.0	-1.06
4586.500000	37.65	74.00	36.35	150.0	H	208.0	2.90
6433.000000	40.99	74.00	33.01	150.0	H	297.0	6.71
9823.000000	43.87	74.00	30.13	150.0	H	208.0	11.18

Vertical

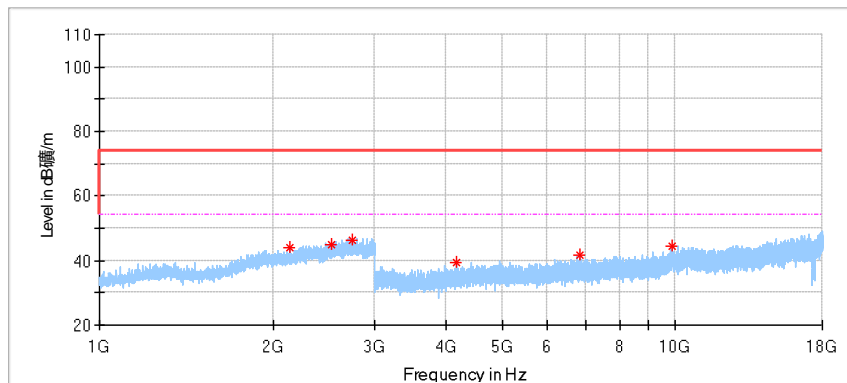

Frequency (MHz)	MaxPeak (dBµV/m)	Limit (dBµV/m)	Margin (dB)	Height (cm)	Pol	Azimuth (deg)	Corr. (dB/m)
2138.095238	44.21	74.00	29.79	150.0	V	180.0	-3.45
2526.190476	44.90	74.00	29.10	150.0	V	261.0	-1.72
2745.714286	46.44	74.00	27.56	150.0	V	144.0	-1.22
4158.000000	39.48	74.00	34.52	150.0	V	0.0	1.61
6828.000000	41.72	74.00	32.28	150.0	V	212.0	7.14
9881.000000	44.29	74.00	29.71	150.0	V	296.0	11.48

11G-Ant0_2412MHz
Horizontal:

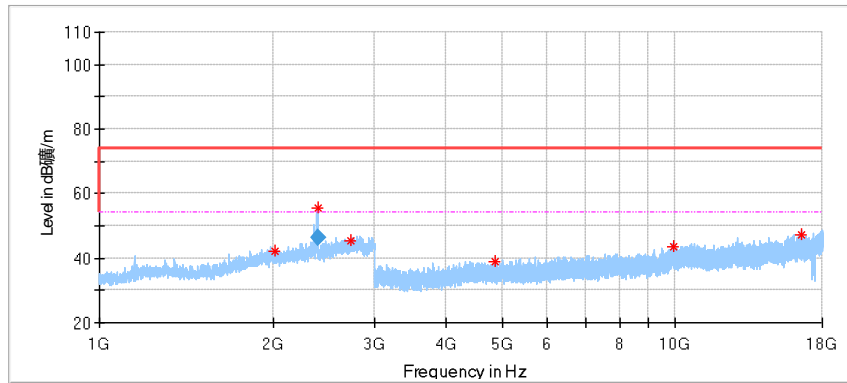

Frequency (MHz)	MaxPeak (dBµV/m)	Limit (dBµV/m)	Margin (dB)	Height (cm)	Pol	Azimuth (deg)	Corr. (dB/m)
2011.904762	42.32	74.00	31.68	150.0	H	92.0	-3.86
2391.904762	55.64	74.00	18.36	150.0	H	41.0	-2.22
2730.000000	45.38	74.00	28.62	150.0	H	114.0	-1.27
4851.000000	39.12	74.00	34.88	150.0	H	66.0	3.72
9914.000000	43.54	74.00	30.46	150.0	H	296.0	10.90
16562.000000	47.09	74.00	26.91	150.0	H	240.0	19.12
Frequency (MHz)	Average (dBµV/m)	Limit (dBµV/m)	Margin (dB)	Height (cm)	Pol	Azimuth (deg)	Corr. (dB/m)
2391.904762	46.35	54.00	7.65	150.0	H	41.0	-2.22

Vertical

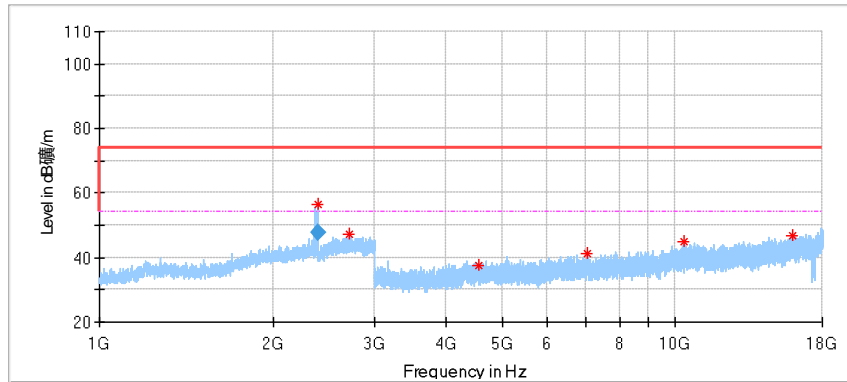

Frequency (MHz)	MaxPeak (dBµV/m)	Limit (dBµV/m)	Margin (dB)	Height (cm)	Pol	Azimuth (deg)	Corr. (dB/m)
2392.857143	56.29	74.00	17.71	150.0	V	151.0	-2.21
2720.476191	47.40	74.00	26.60	150.0	V	92.0	-1.29
4548.000000	37.61	74.00	36.39	150.0	V	4.0	2.80
7047.000000	41.05	74.00	32.95	150.0	V	353.0	7.40
10378.500000	44.82	74.00	29.18	150.0	V	254.0	10.81
15993.000000	46.57	74.00	27.43	150.0	V	158.0	17.51
Frequency (MHz)	Average (dBµV/m)	Limit (dBµV/m)	Margin (dB)	Height (cm)	Pol	Azimuth (deg)	Corr. (dB/m)
2392.857143	47.58	54.00	6.42	150.0	V	151.0	-2.21

11G-Ant0_2437MHz
Horizontal:

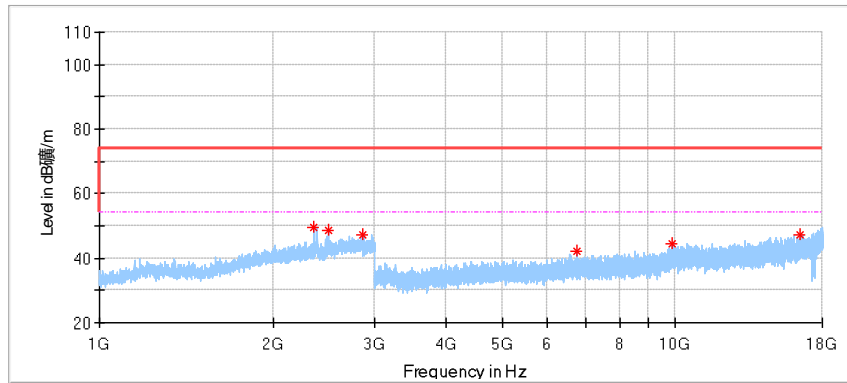

Frequency (MHz)	MaxPeak (dBµV/m)	Limit (dBµV/m)	Margin (dB)	Height (cm)	Pol	Azimuth (deg)	Corr. (dB/m)
2350.000000	49.63	74.00	24.37	150.0	H	0.0	-2.37
2493.809524	48.66	74.00	25.34	150.0	H	188.0	-1.82
2860.476191	47.05	74.00	26.95	150.0	H	356.0	-1.00
6760.500000	42.24	74.00	31.76	150.0	H	181.0	6.87
9858.500000	44.64	74.00	29.36	150.0	H	63.0	11.79
16498.000000	47.37	74.00	26.63	150.0	H	237.0	18.81

Vertical

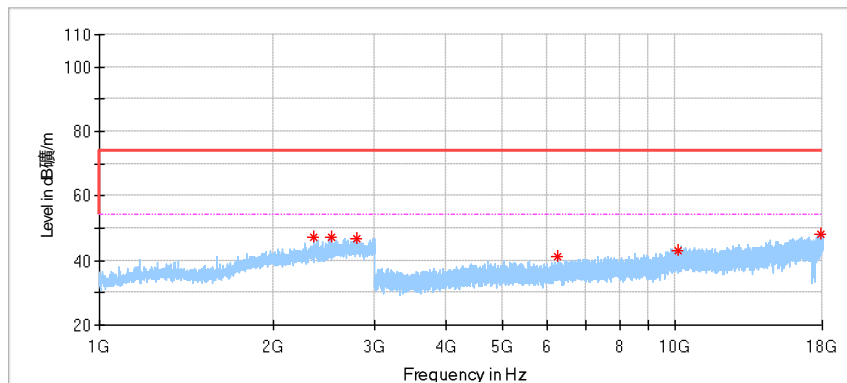

Frequency (MHz)	MaxPeak (dBµV/m)	Limit (dBµV/m)	Margin (dB)	Height (cm)	Pol	Azimuth (deg)	Corr. (dB/m)
2357.619048	47.13	74.00	26.87	150.0	V	5.0	-2.37
2527.619048	47.00	74.00	27.00	150.0	V	34.0	-1.71
2791.904762	46.67	74.00	27.33	150.0	V	298.0	-1.20
6241.500000	41.31	74.00	32.69	150.0	V	293.0	7.01
10121.500000	42.95	74.00	31.05	150.0	V	209.0	10.26
17880.500000	48.11	74.00	25.89	150.0	V	32.0	20.36

11G-Ant0_2462MHz
Horizontal:

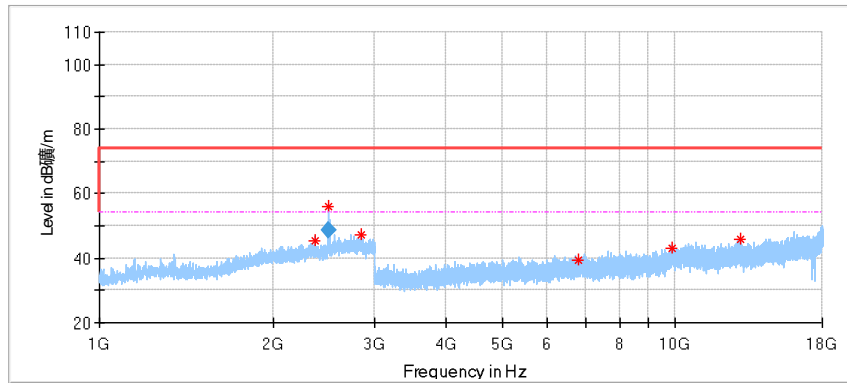

Frequency (MHz)	MaxPeak (dBµV/m)	Limit (dBµV/m)	Margin (dB)	Height (cm)	Pol	Azimuth (deg)	Corr. (dB/m)
2374.285714	45.61	74.00	28.39	150.0	H	82.0	-2.30
2494.285714	56.14	74.00	17.86	150.0	H	30.0	-1.82
2852.857143	47.37	74.00	26.63	150.0	H	313.0	-1.03
6804.000000	39.51	74.00	34.49	150.0	H	4.0	7.08
9856.500000	43.23	74.00	30.77	150.0	H	238.0	11.76
12945.000000	45.79	74.00	28.21	150.0	H	181.0	12.82
Frequency (MHz)	Average (dBµV/m)	Limit (dBµV/m)	Margin (dB)	Height (cm)	Pol	Azimuth (deg)	Corr. (dB/m)
2494.285714	48.79	54.00	5.21	150.0	H	30.0	-1.82

Vertical

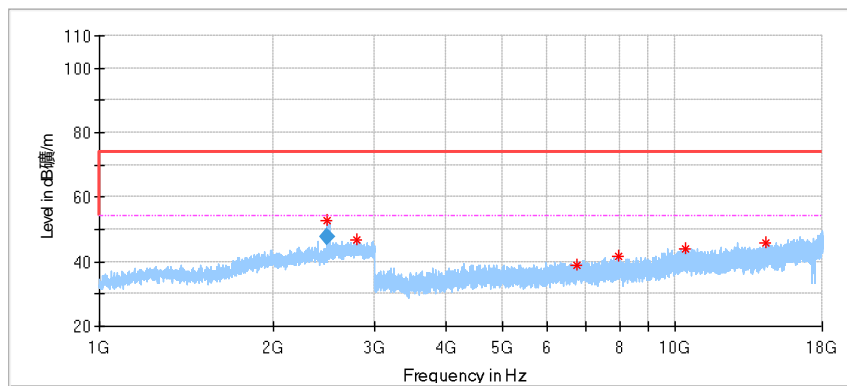

Frequency (MHz)	MaxPeak (dBµV/m)	Limit (dBµV/m)	Margin (dB)	Height (cm)	Pol	Azimuth (deg)	Corr. (dB/m)
2490.952381	53.00	74.00	21.00	150.0	V	166.0	-1.82
2794.285714	46.98	74.00	27.02	150.0	V	298.0	-1.19
6734.500000	38.78	74.00	35.22	150.0	V	214.0	6.86
7977.000000	41.55	74.00	32.45	150.0	V	155.0	8.10
10420.000000	44.18	74.00	29.82	150.0	V	350.0	10.80
14377.000000	46.03	74.00	27.97	150.0	V	297.0	13.53
Frequency (MHz)	Average (dBµV/m)	Limit (dBµV/m)	Margin (dB)	Height (cm)	Pol	Azimuth (deg)	Corr. (dB/m)
2490.952381	47.61	54.00	6.39	150.0	V	166.0	-1.82

11N-HT20-Ant 0_2412MHz
Horizontal:

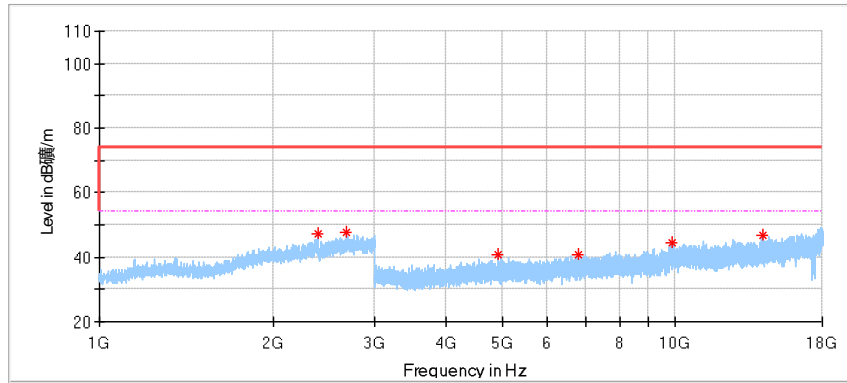

Frequency (MHz)	MaxPeak (dBµV/m)	Limit (dBµV/m)	Margin (dB)	Height (cm)	Pol	Azimuth (deg)	Corr. (dB/m)
2391.428571	47.10	74.00	26.90	150.0	H	180.0	-2.22
2687.142857	47.72	74.00	26.28	150.0	H	238.0	-1.35
4934.000000	40.57	74.00	33.43	150.0	H	356.0	3.65
6768.500000	40.71	74.00	33.29	150.0	H	145.0	6.91
9891.000000	44.53	74.00	29.47	150.0	H	266.0	11.30
14182.500000	46.94	74.00	27.06	150.0	H	0.0	12.74

Vertical

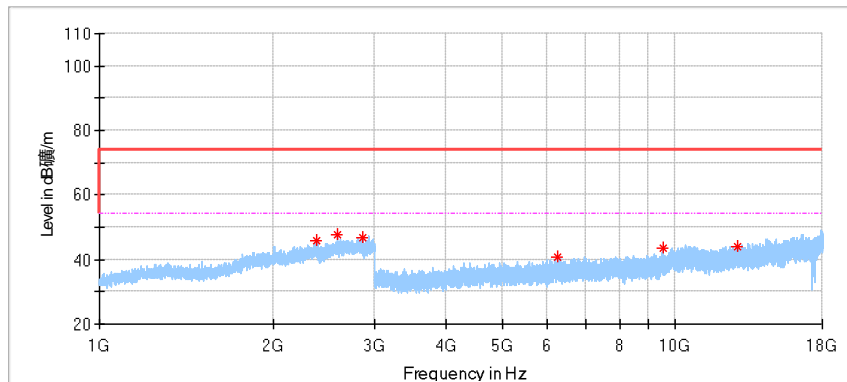

Frequency (MHz)	MaxPeak (dBµV/m)	Limit (dBµV/m)	Margin (dB)	Height (cm)	Pol	Azimuth (deg)	Corr. (dB/m)
2383.809524	45.86	74.00	28.14	150.0	V	128.0	-2.25
2583.333333	47.84	74.00	26.16	150.0	V	33.0	-1.53
2862.380952	46.64	74.00	27.36	150.0	V	40.0	-1.00
6241.500000	40.99	74.00	33.02	150.0	V	122.0	7.01
9532.000000	43.48	74.00	30.52	150.0	V	295.0	9.93
12855.000000	44.20	74.00	29.80	150.0	V	327.0	12.83

11N-HT20-Ant 0_2437MHz
Horizontal:

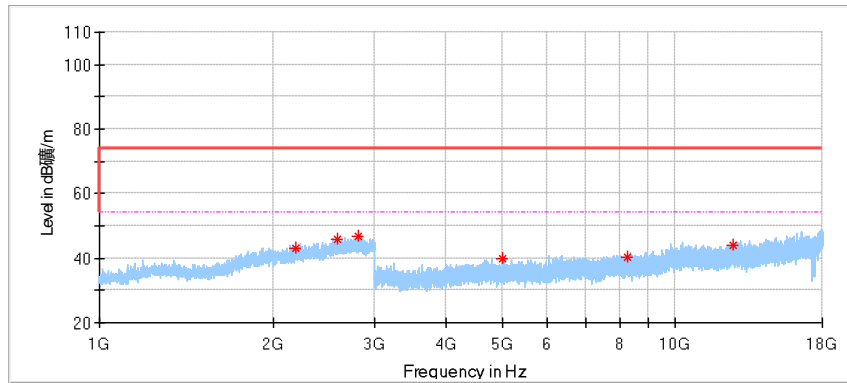

Frequency (MHz)	MaxPeak (dBµV/m)	Limit (dBµV/m)	Margin (dB)	Height (cm)	Pol	Azimuth (deg)	Corr. (dB/m)
2193.333333	42.96	74.00	31.04	150.0	H	241.0	-3.03
2584.285714	45.83	74.00	28.17	150.0	H	106.0	-1.53
2818.571429	46.89	74.00	27.11	150.0	H	33.0	-1.05
5025.000000	39.87	74.00	34.13	150.0	H	179.0	3.85
8237.500000	40.10	74.00	33.90	150.0	H	123.0	8.37
12619.500000	44.07	74.00	29.93	150.0	H	238.0	12.59

Vertical

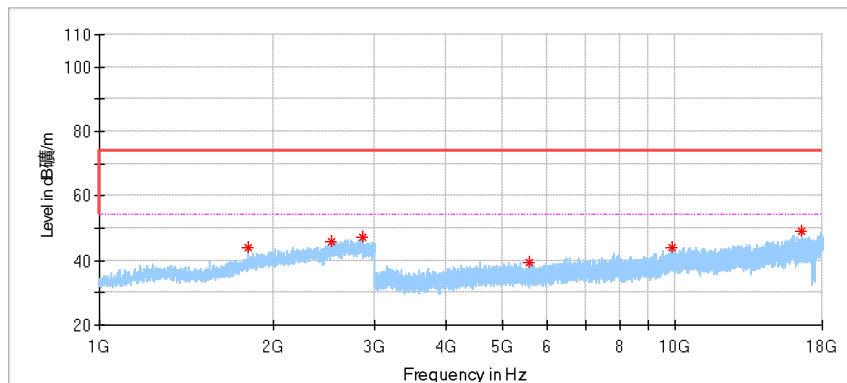

Frequency (MHz)	MaxPeak (dBµV/m)	Limit (dBµV/m)	Margin (dB)	Height (cm)	Pol	Azimuth (deg)	Corr. (dB/m)
1814.761905	43.89	74.00	30.11	150.0	V	25.0	-5.11
2529.523810	45.70	74.00	28.30	150.0	V	55.0	-1.70
2857.619048	47.15	74.00	26.85	150.0	V	358.0	-1.01
5581.000000	39.61	74.00	34.39	150.0	V	95.0	4.76
9873.500000	43.83	74.00	30.17	150.0	V	238.0	11.62
16548.500000	49.15	74.00	24.85	150.0	V	179.0	19.12

11N-HT20-Ant 0_2462MHz
Horizontal:

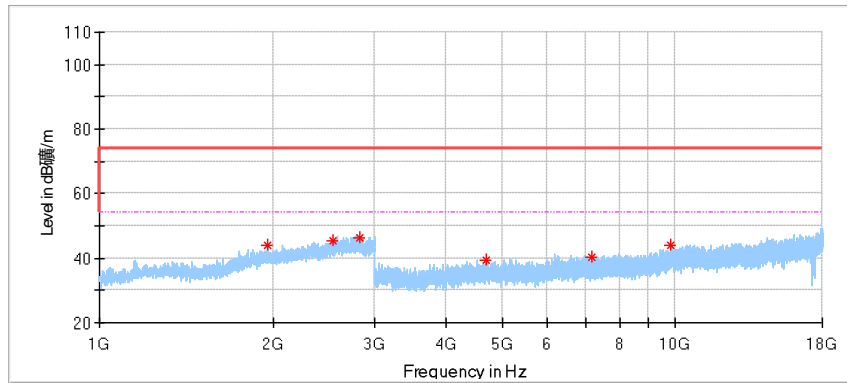

Frequency (MHz)	MaxPeak (dBµV/m)	Limit (dBµV/m)	Margin (dB)	Height (cm)	Pol	Azimuth (deg)	Corr. (dB/m)
1960.952381	44.01	74.00	30.00	150.0	H	353.0	-3.95
2542.857143	45.41	74.00	28.59	150.0	H	335.0	-1.60
2825.238095	46.09	74.00	27.91	150.0	H	188.0	-1.05
4704.500000	39.41	74.00	34.59	150.0	H	268.0	3.39
7176.000000	40.25	74.00	33.75	150.0	H	297.0	7.24
9824.000000	43.77	74.00	30.23	150.0	H	12.0	11.20

Vertical

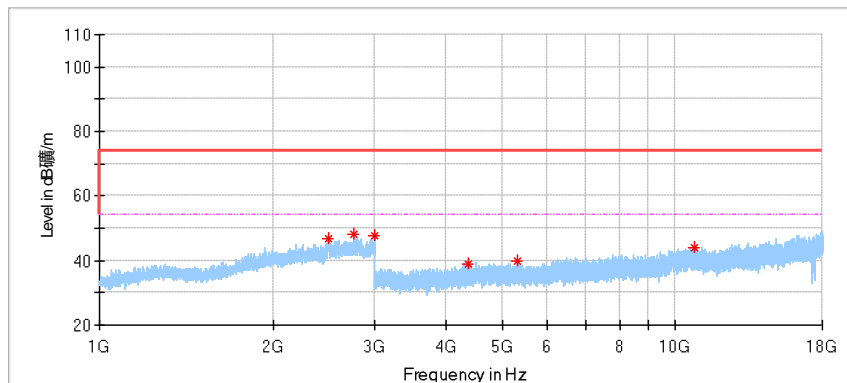

Frequency (MHz)	MaxPeak (dBµV/m)	Limit (dBµV/m)	Margin (dB)	Height (cm)	Pol	Azimuth (deg)	Corr. (dB/m)
2502.857143	46.60	74.00	27.40	150.0	V	349.0	-1.81
2768.571429	48.03	74.00	25.97	150.0	V	263.0	-1.21
2999.523810	47.52	74.00	26.48	150.0	V	256.0	-0.24
4367.500000	38.98	74.00	35.02	150.0	V	95.0	2.41
5309.000000	40.03	74.00	33.97	150.0	V	95.0	4.61
10767.000000	43.94	74.00	30.06	150.0	V	123.0	10.63

Above 18GHz:

11B_2412MHz
Horizontal:

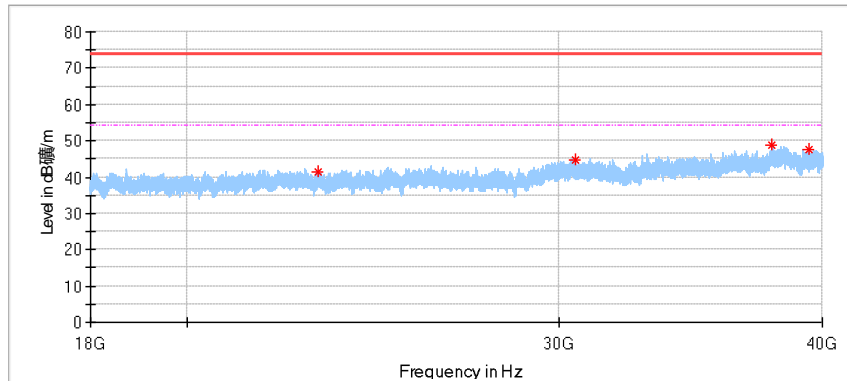

Frequency (MHz)	MaxPeak (dBµV/m)	Limit (dBµV/m)	Margin (dB)	Height (cm)	Pol	Azimuth (deg)	Corr. (dB/m)
23059.312500	41.61	74.00	32.39	150.0	H	278.0	0.53
30529.000000	44.74	74.00	29.26	150.0	H	0.0	1.98
37860.500000	48.91	74.00	25.09	150.0	H	153.0	4.81
39429.375000	47.51	74.00	26.49	150.0	H	92.0	6.58

Vertical

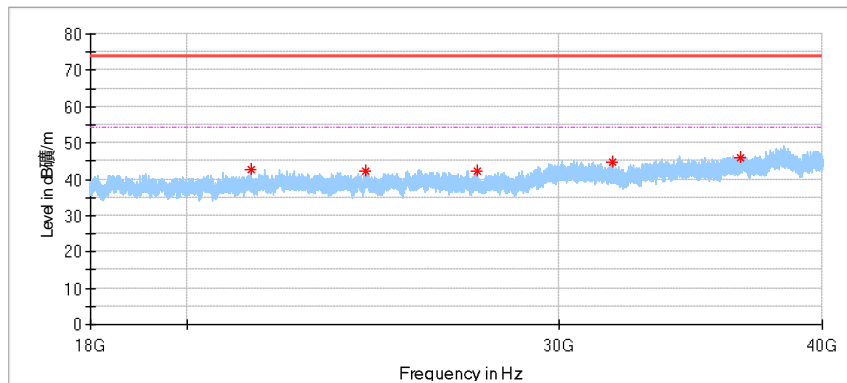

Frequency (MHz)	MaxPeak (dBµV/m)	Limit (dBµV/m)	Margin (dB)	Height (cm)	Pol	Azimuth (deg)	Corr. (dB/m)
21453.312500	42.60	74.00	31.40	150.0	V	4.0	-0.47
24320.187500	42.30	74.00	31.70	150.0	V	82.0	0.54
27448.312500	42.34	74.00	31.66	150.0	V	238.0	1.66
31797.437500	44.63	74.00	29.37	150.0	V	128.0	1.70
36556.312500	45.83	74.00	28.17	150.0	V	299.0	4.37

11B_2437MHz
Horizontal:

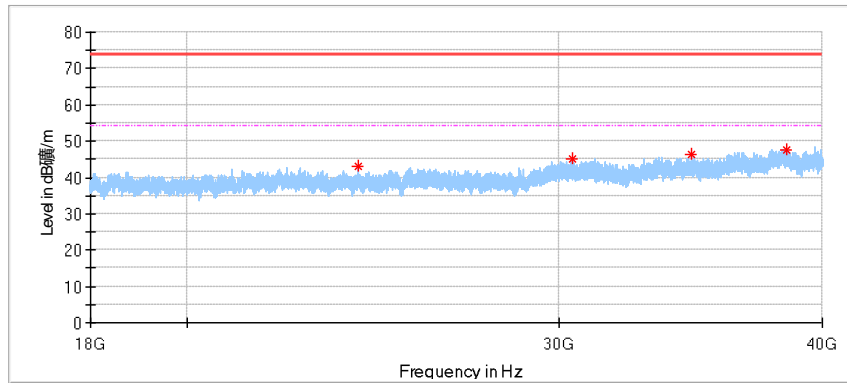

Frequency (MHz)	MaxPeak (dBµV/m)	Limit (dBµV/m)	Margin (dB)	Height (cm)	Pol	Azimuth (deg)	Corr. (dB/m)
24105.687500	43.13	74.00	30.87	150.0	H	65.0	0.56
30434.125000	45.08	74.00	28.92	150.0	H	0.0	2.04
34650.562500	46.28	74.00	27.72	150.0	H	31.0	3.68
38481.312500	47.66	74.00	26.34	150.0	H	295.0	6.57

Vertical

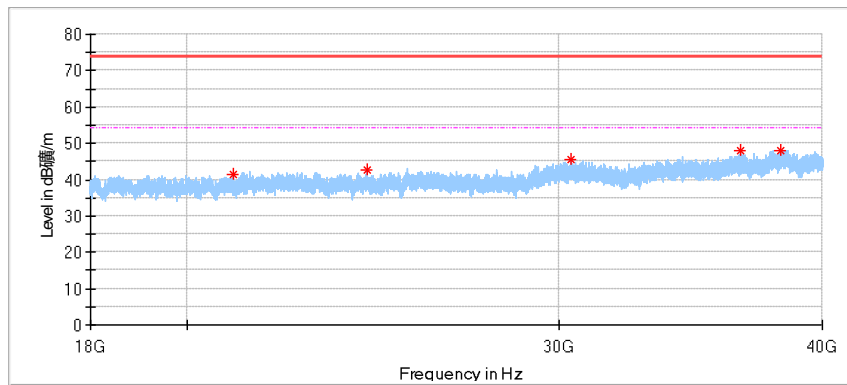

Frequency (MHz)	MaxPeak (dBµV/m)	Limit (dBµV/m)	Margin (dB)	Height (cm)	Pol	Azimuth (deg)	Corr. (dB/m)
21038.062500	41.52	74.00	32.48	150.0	V	202.0	-0.62
24323.625000	42.58	74.00	31.42	150.0	V	2.0	0.54
30421.062500	45.64	74.00	28.36	150.0	V	141.0	2.05
36570.062500	47.89	74.00	26.11	150.0	V	110.0	4.36
38248.937500	48.13	74.00	25.88	150.0	V	65.0	6.21

11B_2462MHz
Horizontal:

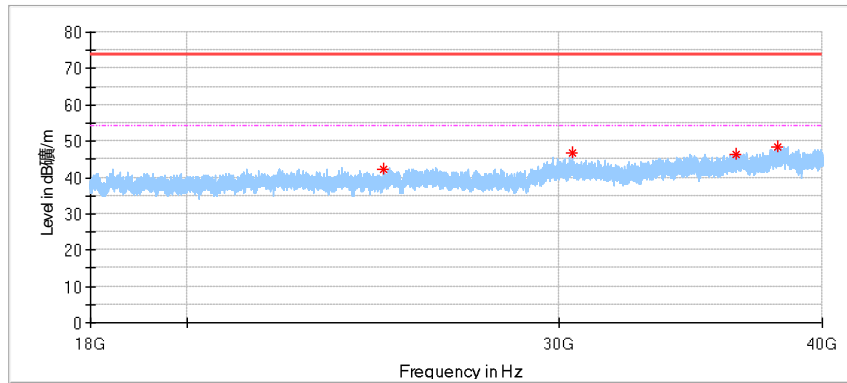

Frequency (MHz)	MaxPeak (dBµV/m)	Limit (dBµV/m)	Margin (dB)	Height (cm)	Pol	Azimuth (deg)	Corr. (dB/m)
24793.187500	42.10	74.00	31.90	150.0	H	0.0	0.78
30432.062500	46.63	74.00	27.37	150.0	H	138.0	2.04
36421.562500	46.38	74.00	27.62	150.0	H	345.0	4.23
38120.375000	48.33	74.00	25.67	150.0	H	312.0	5.60

Vertical

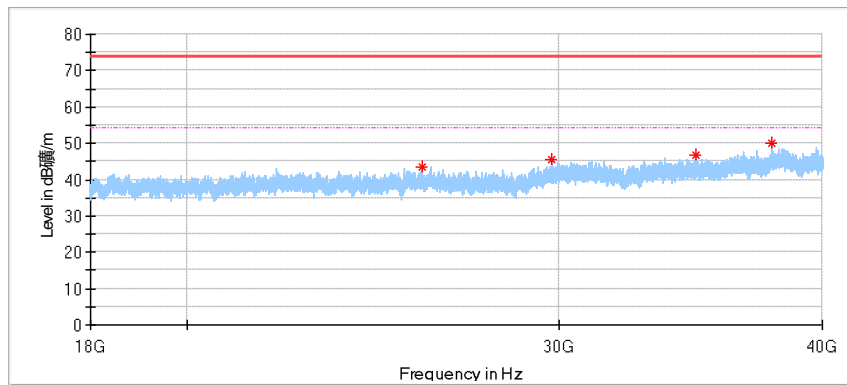

Frequency (MHz)	MaxPeak (dBµV/m)	Limit (dBµV/m)	Margin (dB)	Height (cm)	Pol	Azimuth (deg)	Corr. (dB/m)
25837.500000	43.33	74.00	30.67	150.0	V	46.0	1.66
29788.562500	45.61	74.00	28.39	150.0	V	141.0	1.99
34843.750000	46.66	74.00	27.34	150.0	V	0.0	3.77
37841.250000	50.11	74.00	23.89	150.0	V	6.0	4.76

10 Test Equipment List

Radiated Emission Test

DESCRIPTION	MANUFACTURER	MODEL NO.	EQUIPMENT ID	SERIAL NO.	CAL INTERVAL (YEAR)	CAL. DUE DATE
EMI Test Receiver	Rohde & Schwarz	ESR 26	68-4-74-14-002	101269	1	2022-6-4
Trilog Super Broadband Test Antenna	Schwarzbeck	VULB 9162	68-4-80-19-003	284	1	2023-1-17
Wave Guide Antenna	ETS	3117	68-4-80-19-001	00218954	1	2022-5-24
Pre-amplifier	Rohde & Schwarz	SCU 18F	68-4-29-19-001	100745	1	2022-10-24
Pre-amplifier	Rohde & Schwarz	SCU 08F2	68-4-29-19-004	08400018	1	2022-10-24
Sideband Horn Antenna	Q-PAR	QWH-SL-18-40-K-SG	68-4-80-14-008	12827	1	2022-7-21
Pre-amplifier	Rohde & Schwarz	SCU 40A	68-4-29-14-002	100432	1	2022-7-27
3m Semi-anechoic chamber	TDK	SAC-3 #2	68-4-90-19-006	----	2	2023-5-28
Test software	Rohde & Schwarz	EMC32	68-4-90-19-006-A01	Version10.3 5.02	N/A	N/A

Conducted Emission Test

DESCRIPTION	MANUFACTURER	MODEL NO.	EQUIPMENT ID	SERIAL NO.	CAL INTERVAL (YEAR)	CAL. DUE DATE
EMI Test Receiver	Rohde & Schwarz	ESR 3	68-4-74-19-002	102590	1	2022-6-4
LISN	Rohde & Schwarz	ENV216	68-4-87-19-001	102472	1	2022-6-5
ISN	Rohde & Schwarz	ENY81	68-4-87-14-003	100177	1	2022-6-5
ISN	Rohde & Schwarz	ENY81-CA6	68-4-87-14-004	101664	1	2022-6-5
High Voltage Probe	Schwarzbeck	TK9420(VT 9420)	68-4-27-14-001	9420-584	1	2022-6-5
RF Current Probe	Rohde & Schwarz	EZ-17	68-4-27-14-002	100816	1	2022-6-5
Attenuator	Shanghai Huaxiang	TS2-26-3	68-4-81-16-003	080928189	1	2022-6-3
Test software	Rohde & Schwarz	EMC32	68-4-90-19-005-A01	Version10.3 5.02	N/A	N/A
Shielding Room	TDK	CSR #2	68-4-90-19-005	----	1	2022-11-07

Conducted RF Test System

DESCRIPTION	MANUFACTURER	MODEL NO.	EQUIPMENT ID	SERIAL NO.	CAL INTERVAL (YEAR)	CAL. DUE DATE
Signal Analyzer	Rohde & Schwarz	FSV40	68-4-74-14-004	101030	1	2022-6-3
RF Switch Module	Rohde & Schwarz	OSP120/OS P-B157	68-4-93-14-003	101226/100851	1	2022-6-3
Power Splitter	Weinschel	1580	68-4-85-14-001	SC319	1	2022-6-3
10dB Attenuator	Weinschel	4M-10	68-4-81-14-003	43152	1	2022-6-3
10dB Attenuator	R&S	DNF	68-4-81-14-004	DNF-001	1	2022-6-3
10dB Attenuator	R&S	DNF	68-4-81-14-005	DNF-002	1	2022-6-3
10dB Attenuator	R&S	DNF	68-4-81-14-006	DNF-003	1	2022-6-3
10dB Attenuator	R&S	DNF	68-4-81-14-007	DNF-004	1	2022-6-3
Test software	Tonscend	System for BT/WIFI	68-4-74-14-006-A13	Version 2.6.77.0518	N/A	N/A
Shielding Room	TDK	TS8997	68-4-90-19-003	----	1	2022-11-07

11 System Measurement Uncertainty

For a 95% confidence level, the measurement expanded uncertainties for defined systems, in accordance with the recommendations of ISO 17025 were:

System Measurement Uncertainty	
Test Items	Extended Uncertainty
Uncertainty for Conducted Emission 150kHz-30MHz (for test using AMN ENV432 or ENV4200)	3.62dB
Uncertainty for Radiated Spurious Emission 25MHz-3000MHz	Horizontal: 4.70dB; Vertical: 4.67dB;
Uncertainty for Radiated Spurious Emission 3000MHz-18000MHz	Horizontal: 4.65dB; Vertical: 4.63dB;
Uncertainty for Radiated Spurious Emission 18000MHz-40000MHz	Horizontal: 5.05dB; Vertical: 5.04dB;
Uncertainty for Conducted RF test with TS 8997	RF Power Conducted: 1.16dB Frequency test involved: 0.6×10^{-7} or 1%
Uncertainty Evaluation for Humidity	0.936%
Uncertainty Evaluation for Temperature	0.195 °C