



# SAR TEST REPORT

**Report No.:** SET2022-04850

**Product Name:** Saim Thermal Imaging Monocular

**FCC ID:** 2AYGT-254-1

**Model Name:** SCD35,SCD50

**Applicant:** IRay Technology Co.,Ltd

**Address:** 11GUIYANG STREET, YANTAI ECONOMY AND TECHNOLOGY DEVELOPMENT DISTRICT, YANTAI SHANDONG P.R.CHINA.

**Test Date:** 2021.11.25-2021.11.25

**Issued by:** CCIC Southern Testing Co., Ltd.

**Lab Location:** Electronic Testing Building, No. 43 Shahe Road, Xili Street, Nanshan District, Shenzhen, Guangdong, China

**Tel:** 86 755 26627338      **Fax:** 86 755 26627238

**Mail:** manager@ccic-set.com      **Website:** <http://www.ccic-set.com>

This test report consists of 48 pages in total. It may be duplicated completely for legal use with the approval of the applicant. It should not be reproduced except in full, without the written approval of our laboratory. The client should not use it to claim product endorsement by CCIC-SET. The test results in the report only apply to the tested sample. The CCIC-SET does not assume responsibility for any conclusions and generalizations drawn from the test results with regard to other specimens or samples of the type of the equipment represented by the test item. The test report shall be invalid without all the signatures of testing engineers, reviewer and approver. Any objections must be raised to CCIC-SET within 15 days since the date when the report is received. It will not be taken into consideration beyond this limit.



# Test Report

**Applicant:** IRay Technology Co.,Ltd

**Brand Name:** InfiRay

**Trade Name:** InfiRay

**Applicant Address:** 11GUIYANG STREET, YANTAI ECONOMY AND TECHNOLOGY DEVELOPMENT DISTRICT, YANTAI SHANDONG P.R.CHINA.

**Manufacturer:** IRay Technology Co.,Ltd

**Manufacturer Address:** 11GUIYANG STREET, YANTAI ECONOMY AND TECHNOLOGY DEVELOPMENT DISTRICT, YANTAI SHANDONG P.R.CHINA.

**Test Standards:** **47CFR §2.1093-** Radiofrequency Radiation Exposure Evaluation: Portable Devices;  
**ANSI C95.1-1992:** Safety Levels with Respect to Human Exposure to Radio Frequency Electromagnetic Fields, 3 kHz – 300 GHz.( IEEE Std C95.1-1991)  
**RSS-102:** Radio Frequency Exposure Compliance of Radio communication Apparatus (All Frequency Bands)(Issue 5 of March 2015)  
**IEEE 1528-2013:** IEEE Recommended Practice for Determining the Peak Spatial-Average Specific Absorption Rate (SAR) in the Human Head from Wireless Communications Devices: Measurement Techniques

**Test Result:** Pass

**Tested by:** Xinyuan Fang 2022-04-28  
Xinyuan Fang, Test Engineer

**Reviewed by:** Chris You 2022-04-28  
Chris You, Senior Engineer

**Approved by:** Shuangwen Zhang 2022-04-28  
Shuangwen Zhang , Manager



## Contents

<b>1. Administration Data</b> .....	4
1.1 Testing Laboratory .....	4
1.2 List of test Equipment .....	4
<b>2. Equipment Under Test (EUT)</b> .....	5
<b>3. Specific Absorption Rate (SAR)</b> .....	6
3.1 SAR Introduction .....	6
3.2 Probe Specification .....	8
<b>4. Tissue check and recommend Dielectric Parameters</b> .....	9
4.1 Recommended Tissue Dielectric Parameters .....	9
4.2.liquid check results.....	10
<b>5. System check procedure</b> .....	11
<b>6. SAR measurement procedure</b> .....	13
<b>7. RF Conducted Power</b> .....	15
<b>8. Measurement Uncertainty</b> .....	17
<b>ANNEX A: SAR Test Setup</b> .....	21
<b>ANNEX B: System Check Plots</b> .....	23
<b>ANNEX C: SAR Test Plots</b> .....	25
<b>ANNEX D: Calibration Certificate</b> .....	27



## 1. Administration Data

### 1.1 Testing Laboratory

<b>Test Site:</b>	CCIC Southern Testing Co., Ltd.
<b>Address:</b>	Electronic Testing Building, No. 43 Shahe Road, Xili Street, Nanshan District, Shenzhen, Guangdong, China
<b>A2LA Accreditation:</b>	CCIC-SET is a third party testing organization accredited by A2LA according to ISO/IEC 17025:2017. The accreditation certificate number is 5721.01
<b>FCC-Designation No.: CN1283</b>	CCIC Southern Testing Co., Ltd EMC Laboratory has been registered and fully described in a report filed with the FCC (Federal Communications Commission). The acceptance letter from the FCC is maintained in our files. Designation Number: CN1283, valid time is until April 19th, 2023
<b>ISED Registration: 11185A-1</b>	CAB identifier: CN0064 CCIC Southern Testing Co., Ltd. EMC Laboratory has been registered by Certification and Engineering Bureau of Industry Canada for the performance of radiated measurements with Registration No. 11185A-1 on Aug. 04, 2016, valid time is until Jun. 30th, 2023.

### 1.2 List of test Equipment

This table is a complete overview of the SAR measurement equipment. Devices used during the test described are marked .

	EQUIPMENT	Model	Serial number	Calibration Date	Due Date
<input checked="" type="checkbox"/>	SAR Probe	SSE2	SN27/15 EPGO348	2020/12/14	2021/12/13
<input checked="" type="checkbox"/>	Dipole	SID2450	SN_09/13_DIP2G450-220	2020/06/25	2023/06/24
<input checked="" type="checkbox"/>	Multimeter	Keithley-2000	4014020	2021/04/02	2022/04/01
<input checked="" type="checkbox"/>	Vector Network Analyzer(R&S)	ZVB8	A0802530	2021/04/26	2022/04/25
<input checked="" type="checkbox"/>	PC 3.5 Fixed Match Calibration Kit	ZV-Z32	100571	2021/04/26	2022/04/25
<input checked="" type="checkbox"/>	Dielectric Probe Kit	SCLMP	SN 09/13 OCPG51	2021/04/26	2022/04/25
<input checked="" type="checkbox"/>	Signal Generator	SMU200A	A140801888	2021/03/12	2022/03/11
<input checked="" type="checkbox"/>	Amplifier	Nucletudes	143060	2021/03/12	2022/03/11
<input checked="" type="checkbox"/>	Directional Coupler	DC6180A	305827	2021/03/12	2022/03/11
<input checked="" type="checkbox"/>	Power Meter	NRP2	A140401673	2021/03/12	2022/03/11
<input checked="" type="checkbox"/>	Power Sensor	NPR-Z11	1138.3004.02-114072-nq	2021/03/12	2022/03/11
<input checked="" type="checkbox"/>	Power Meter	NRVS	A0802531	2021/03/12	2022/03/11
<input checked="" type="checkbox"/>	Power Sensor	NRV-Z4	100069	2021/03/12	2022/03/11



## 2. Equipment Under Test (EUT)

### Identification of the Equipment under Test

Device type :	portable device	
DUT Name:	Saim Thermal Imaging Monocular	
exposure category:	uncontrolled environment / general population	
operating mode(s)	2.4G WI-FI	
modulation:	WI-FI(DSSS,OFDM)	
Tested frequency range(s)	transmitter frequency range	receiver frequency range
Wi-Fi:	2412-2462 MHz	
Hotspot	Not support	
Hardware version :	V50C	
Software version :	0150.1	
Antenna type :	Integrated antenna	
MAX. SAR Value:	Body-Support: 0.080W/Kg(1g-0mm, Limit:1.6W/Kg)	

*Note 1:* The EUT is a Cabin Thermal Imaging monocular; It could support the following operating mode and frequency band: 2.4GWIFI.

*Note 2:* For a more detailed description, please refer to Specification or User's Manual supplied by the applicant and/or manufacturer.

*Note 3:* This report is based on the SET2021-16513 report. EUT removed the electronic compass, replaced the movement, and changed the model. The change has no effect on the SAR test results, so no SAR test is required.

### 3. Specific Absorption Rate (SAR)

#### 3.1 SAR Introduction

SAR is related to the rate at which energy is absorbed per unit mass in an object exposed to a radio field. The SAR distribution in a biological body is complicated and is usually carried out by experimental techniques or numerical modeling. The standard recommends limits for two tiers of groups, occupational/controlled and general population/uncontrolled, based on a person's awareness and ability to exercise control over his or her exposure. In general, occupational/controlled exposure limits are higher than the limits for general population/uncontrolled.

The SAR definition is the time derivative (rate) of the incremental energy (dW) absorbed by (dissipated in) an incremental mass (dm) contained in a volume element (dv) of a given density ( $\rho$ ). The equation description is as below:

$$\text{SAR} = \frac{d}{dt} \left( \frac{dW}{dm} \right) = \frac{d}{dt} \left( \frac{dW}{\rho dv} \right)$$

SAR is expressed in units of Watts per kilogram (W/kg)

SAR measurement can be either related to the temperature elevation in tissue by

$$\text{SAR} = C \frac{\delta T}{\delta t}$$

where C is the specific heat capacity,  $\delta T$  is the temperature rise and  $\delta t$  the exposure duration, or related to the electrical field in the tissue by

$$\text{SAR} = \frac{\sigma |E|^2}{\rho}$$

where  $\sigma$  is the conductivity of the tissue,  $\rho$  is the mass density of the tissue and E is the rms electrical field strength.

However for evaluating SAR of low power transmitter, electrical field measurement is typically applied.

## Phantoms

The phantom used for all tests i.e. for both system checks and device testing, was the twin-headed "SAM Phantom", manufactured by SATIMO. The SAM twin phantom is a fiberglass shell phantom with 2mm shell thickness (except the ear region, where shell thickness increases to 6mm).

System checking was performed using the flat section, whilst Head SAR tests used the left and right head profile sections. Body SAR testing also used the flat section between the head profiles.



SAM Twin Phantom

## Device Holder

The device was placed in the device holder (illustrated below) that is supplied by SATIMO as an integral part of the COMOSAR test system.

The device holder is designed to cope with the different positions given in the standard. It has two scales for device rotation (with respect to the body axis) and device inclination (with respect to the line between the ear reference points). The rotation centers for both scales is the ear reference point (ERP). Thus the device needs no repositioning when changing the angles.

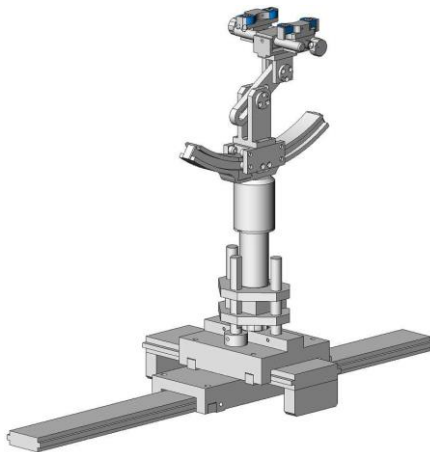

Device holder

### 3.2 Probe Specification



Construction	Symmetrical design with triangular core Interleaved sensors Built-in shielding against static charges PEEK enclosure material (resistant to organic solvents, e.g., DGBE)
Calibration	ISO/IEC 17025 calibration service available.
Frequency	700 MHz to 3 GHz; Linearity: $\pm 0.5$ dB (700 MHz to 3 GHz)
Directivity	$\pm 0.25$ dB in HSL (rotation around probe axis) $\pm 0.5$ dB in tissue material (rotation normal to probe axis)
Dynamic Range	1.5 $\mu$ W/g to 100 mW/g; Linearity: $\pm 0.5$ dB
Dimensions	Overall length: 330 mm (Tip: 20 mm) Tip diameter: 5 mm Distance from probe tip to dipole centers: <2.7 mm
Application	General dosimetry up to 3 GHz Dosimetry in strong gradient fields Compliance tests of mobile phones
Frequency	700 MHz to 6 GHz; Linearity: $\pm 0.5$ dB (700 MHz to 6 GHz)
Dimensions	Overall length: 330 mm Tip diameter: 2.5 mm (Body: 8 mm) Distance from probe tip to dipole centers: 1 mm
Compatibility	COMOSAR

#### Isotropic E-Field Probe

The isotropic E-Field probe has been fully calibrated and assessed for isotropicity, and boundary effect within a controlled environment. Depending on the frequency for which the probe is calibrated the method utilized for calibration will change.

The E-Field probe utilizes a triangular sensor arrangement as detailed in the diagram below:

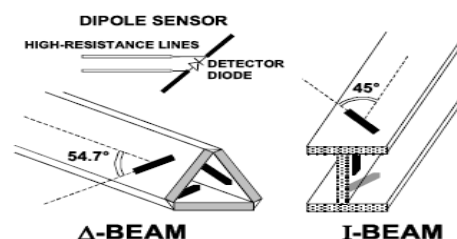



## 4. Tissue check and recommend Dielectric Parameters

### 4.1 Recommended Tissue Dielectric Parameters

Frequency (MHz)	Tissue	
	Real part of the complex relative permittivity, $\epsilon_r$	Conductivity, $\sigma$ (S/m)
30	55	0.75
150	52.3	0.76
300	45.3	0.87
450	43.5	0.87
750	41.9	0.89
835	41.5	0.9
900	41.5	0.97
1450	40.5	1.2
1800	40	1.4
1900	40	1.4
1950	40	1.4
2000	40	1.4
2100	39.8	1.49
2450	39.2	1.8
2600	39	1.96
3000	38.5	2.4
3500	37.9	2.91
4000	37.4	3.43
4500	36.8	3.94
5000	36.2	4.45
5200	36	4.66
5400	35.8	4.86
5600	35.5	5.07
5800	35.3	5.27
6000	35.1	5.48



### 4.2.liquid check results

Simulate liquid that are used for testing at each frequency, which are made mainly of sugar, salt and water solutions may be left in the phantoms. Dielectric Performance of Tissue Simulating Liquid

#### Dielectric Performance of Tissue Simulating Liquid

Temperature: 22.1 °C; Humidity: 56%;				
/	Frequency	Permittivity $\epsilon$	Conductivity $\sigma$ (S/m)	Test Date
Target value	2450MHz	39.2±5% (37.24~41.16)	1.80±5% (1.71~1.89)	2021/11/25
Validation value		38.17	1.82	

## 5. System check procedure

Prior to the assessment, the system validation kit was used to test whether the system was operating within its specifications of  $\pm 10\%$ . The validation results are tabulated below. And also the corresponding SAR plot is attached as well in the SAR plots files.

The following procedure, recommended for performing validation tests using box phantoms is based on the procedures described in the IEEE standard P1528. Setup according to the setup diagram below :

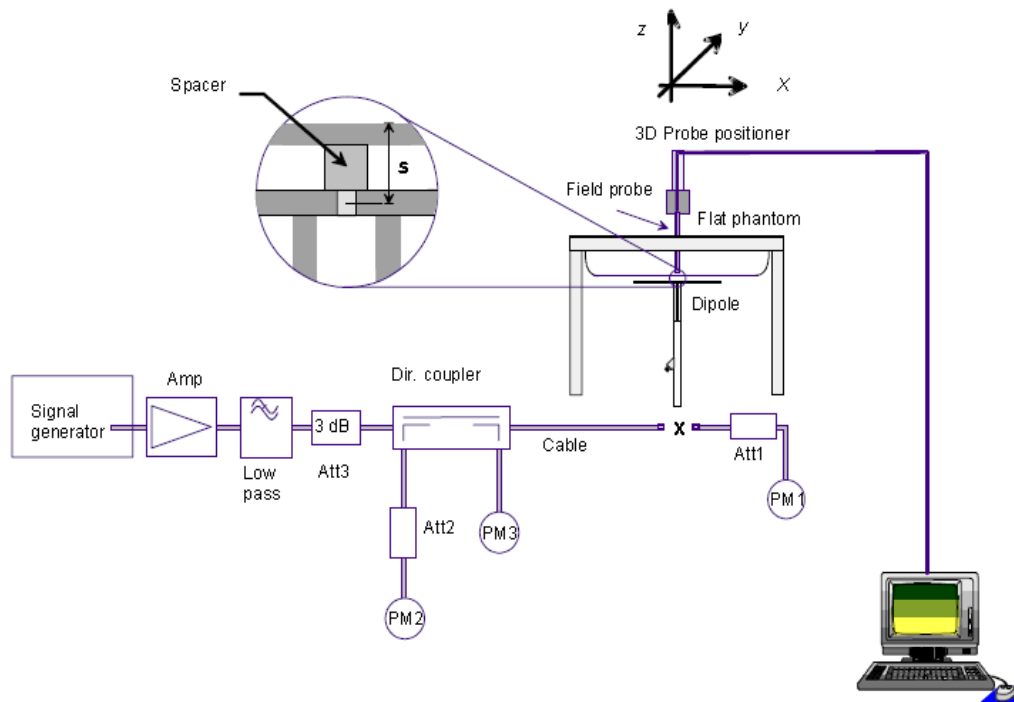

With the SG and Amp and with directional coupler in place, set up the source signal at the relevant frequency and use a power meter to measure the power at the end of the SMA cable that you intend to connect to the balanced dipole. Adjust the SG to make this, say, 0.01W (10 dBm). If this level is too high to read directly with the power meter sensor, insert a calibrated attenuator (e.g. 10 or 20 dB) and make a suitable correction to the power meter reading.

Note 1: In this method, the directional coupler is used for monitoring rather than setting the exact feed power level.

If, however, the directional coupler is used for power measurement, you should check the frequency range and power rating of the coupler and measure the coupling factor (referred to output) at the test frequency using a VNA.

Note 2: Remember that the use of a 3dB attenuator (as shown in Figure 8.1 of P1528) means that you need an RF amplifier of 2 times greater power for the same feed power. The other issue is the cable length. You might get up to 1dB of loss per meter of cable, so the cable length after the coupler needs to be quite short.

Note 3: For the validation testing done using CW signals, most power meters are suitable. However, if you are measuring the output of a modulated signal from either a signal generator or a handset, you must ensure that the power meter correctly reads the modulated signals.



## System Check Results

Frequency	Duty cycle	Target value (1-g) (W/Kg)	Test value (1-g) (W/Kg)	Test SAR Normalized to 1W(w/Kg)	Test Date
2450MHz	1:1	53.71W/kg±10% (48.34~59.08)	0.5341	53.41	2021/11/25

\*Note: All SAR values are normalized to 1W forward power.

## 6. SAR measurement procedure

The SAR test against the head phantom was carried out as follow:

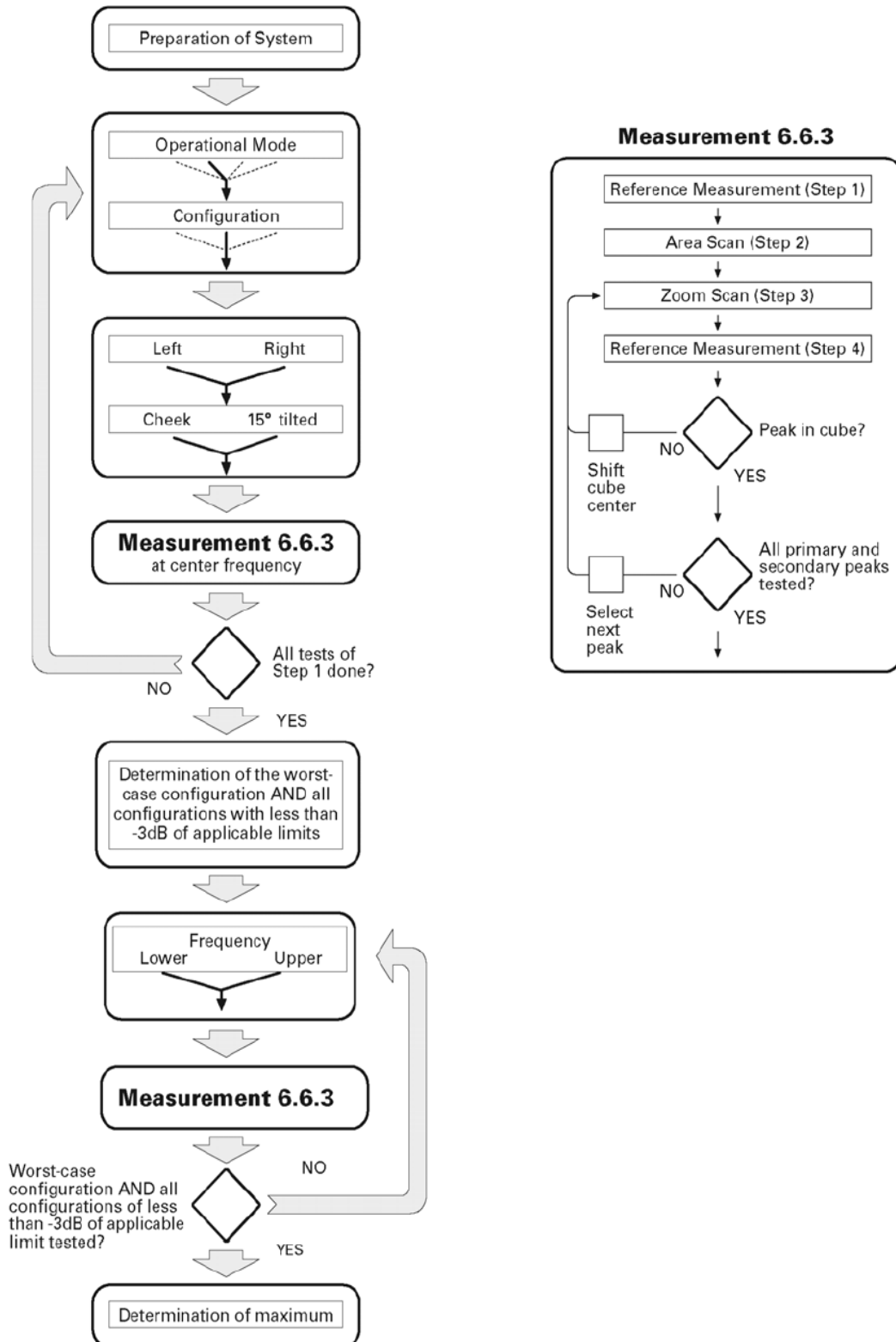



The same procedure should be also executed for the operation mode of the testing Frequency.

The SAR test against the body-worn was carried out as follow:

After an area scan has been done at a fixed distance of 2mm from the surface of the phantom on the source side, a 3D scan is set up around the location of the maximum spot SAR. First, a point within the scan area is visited by the probe and a SAR reading taken at the start of testing. At the end of testing, the probe is returned to the same point and a second reading is taken. Comparison between these start and end readings enables the power drift during measurement to be assessed.

Above is the scanning procedure flow chart and table from the IEEE p1528 standard. This is the procedure for which all compliant testing should be carried out to ensure that all variations of the device position and transmission behavior are tested.

## 7. RF Conducted Power

### Wi-Fi Maximum Output power

Mode	Lowest Channel	Middle Channel	Highest Channel
802.11b	16.23	16.50	16.01
802.11g	14.87	15.37	14.07
802.11n20	12.95	13.35	12.27

Operation Mode	Channel /Frequency	Output Power(dBm)	Tune up Power in tolerance (dBm)	Max. Tune up(dBm)	Scaling Factor
WIFI 2.4G 802.11b	1/2412	16.23	15.5±1	16.5	1.064
	6/2437	16.50	16.0±1	17.0	1.122
	11/2462	16.01	15.5±1	16.5	1.119

## Test Results

### Results overview of WI-FI 802.11b

Body-Support (0mm)	Channel /Frequency	Mode	SAR Value (W/kg)1-g	Scaled Factor	Scaled SAR (W/Kg)1-g	Power drift(%)	Limit (W/kg)	SAR Plot.
Edge A	1/2412	DSSS	0.059	1.064	0.063	-1.08	1.6	/
Edge A	6/2437	DSSS	<b>0.071</b>	1.122	<b>0.080</b>	-2.16	1.6	Yes
Edge A	11/2462	DSSS	0.065	1.119	0.073	-1.43	1.6	/
Edge B	6/2437	DSSS	0.057	1.122	0.064	-3.29	1.6	/

Note: 1) The EUT ANT side directly touch the Phantom.

2)The SAR test shall be performed at the high, middle and low frequency channels of each operating mode. If the SAR measured at mid-band channel for each test configuration is at least 3.0 dB lower than the SAR limit ( $< 1$  W/kg), testing at the high and low channels is optional, apart from the worst case configuration.



## 8. Measurement Uncertainty

No.	Uncertainty Component	Type	Uncertainty Value (%)	Probability Distribution	k	ci	Standard Uncertainty (%) $u_i(\%)$	Degree of freedom $\nu_{eff}$ or $\nu_i$
<b>Measurement System</b>								
1	– Probe Calibration	B	5.8	N	1	1	5.8	$\infty$
2	– Axial isotropy	B	3.5	R	$\sqrt{3}$	0.5	1.43	$\infty$
3	- Hemispherical Isotropy	B	5.9	R	$\sqrt{3}$	0.5	2.41	$\infty$
4	– Boundary Effect	B	1	R	$\sqrt{3}$	1	0.58	$\infty$
5	– Linearity	B	4.7	R	$\sqrt{3}$	1	2.71	$\infty$
6	– System Detection Limits	B	1.0	R	$\sqrt{3}$	1	0.58	$\infty$
7	Modulation response	B	3	N	1	1	3.00	
8	– Readout Electronics	B	0.5	N	1	1	0.50	$\infty$
9	– Response Time	B	1.4	R	$\sqrt{3}$	1	0.81	$\infty$
10	– Integration Time	B	3.0	R	$\sqrt{3}$	1	1.73	$\infty$
11	– RF Ambient Conditions	B	3.0	R	$\sqrt{3}$	1	1.73	$\infty$
12	– Probe Position Mechanical tolerance	B	1.4	R	$\sqrt{3}$	1	0.81	$\infty$
13	– Probe Position with respect to Phantom Shell	B	1.4	R	$\sqrt{3}$	1	0.81	$\infty$
14	– Extrapolation, Interpolation and Integration Algorithms for Max. SAR evaluation	B	2.3	R	$\sqrt{3}$	1	1.33	$\infty$
<b>Uncertainties of the DUT</b>								
15	– Position of the DUT	A	2.6	N	$\sqrt{3}$	1	2.6	5
16	– Holder of the DUT	A	3	N	$\sqrt{3}$	1	3.0	5
17	– Output Power Variation –SAR drift measurement	B	5.0	R	$\sqrt{3}$	1	2.89	$\infty$



Phantom and Tissue Parameters								
18	- Phantom Uncertainty(shape and thickness tolerances)	B	4	R	$\sqrt{3}$	1	2.31	$\infty$
19	Uncertainty in SAR correction for deviation(in permittivity and conductivity)	B	2	N	1	1	2.00	
20	- Liquid Conductivity Target -tolerance	B	2.5	R	$\sqrt{3}$	0.6	1.95	$\infty$
21	- Liquid Conductivity -measurement Uncertainty)	B	4	N	$\sqrt{3}$	1	0.92	9
22	- Liquid Permittivity Target tolerance	B	2.5	R	$\sqrt{3}$	0.6	1.95	$\infty$
23	- Liquid Permittivity -measurement uncertainty	B	5	N	$\sqrt{3}$	1	1.15	$\infty$
<b>Combined Standard Uncertainty</b>				RSS			10.63	
<b>Expanded uncertainty</b> (Confidence interval of 95 %)				K=2			21.26	

### System Check Uncertainty

No.	Uncertainty Component	Type	Uncertainty Value (%)	Probability Distribution	k	ci	Standard Uncertainty (%) $u_i(\%)$	Degree of freedom $v_{eff}$ or $v_i$
<b>Measurement System</b>								
1	– Probe Calibration	B	5.8	N	1	1	5.8	$\infty$
2	– Axial isotropy	B	3.5	R	$\sqrt{3}$	0.5	1.43	$\infty$
3	- Hemispherical Isotropy	B	5.9	R	$\sqrt{3}$	0.5	2.41	$\infty$
4	– Boundary Effect	B	1	R	$\sqrt{3}$	1	0.58	$\infty$
5	– Linearity	B	4.7	R	$\sqrt{3}$	1	2.71	$\infty$
6	– System Detection Limits	B	1	R	$\sqrt{3}$	1	0.58	$\infty$
7	Modulation response	B	0	N	1	1	0.00	
8	– Readout Electronics	B	0.5	N	1	1	0.50	$\infty$
9	– Response Time	B	0.00	R	$\sqrt{3}$	1	0.00	$\infty$
10	– Integration Time	B	1.4	R	$\sqrt{3}$	1	0.81	$\infty$
11	– RF Ambient Conditions	B	3.0	R	$\sqrt{3}$	1	1.73	$\infty$
12	– Probe Position Mechanical tolerance	B	1.4	R	$\sqrt{3}$	1	0.81	$\infty$
13	– Probe Position with respect to Phantom Shell	B	1.4	R	$\sqrt{3}$	1	0.81	$\infty$
14	– Extrapolation, Interpolation and Integration Algorithms for Max. SAR evaluation	B	2.3	R	$\sqrt{3}$	1	1.33	$\infty$
<b>Uncertainties of the DUT</b>								
15	Deviation of experimental source from numerical source	A	4	N	1	1	4.00	5
16	Input Power and SAR drift measurement	A	5	R	$\sqrt{3}$	1	2.89	5
17	Dipole Axis to Liquid Distance	B	2	R	$\sqrt{3}$	1	1.2	$\infty$



Phantom and Tissue Parameters								
18	– Phantom Uncertainty(shape and thickness tolerances)	B	4	R	$\sqrt{3}$	1	2.31	$\infty$
19	Uncertainty in SAR correction for deviation(in permittivity and conductivity)	B	2	N	1	1	2.00	
20	– Liquid Conductivity Target –tolerance	B	2.5	R	$\sqrt{3}$	0.6	1.95	$\infty$
21	– Liquid Conductivity –measurement Uncertainty)	B	4	N	$\sqrt{3}$	1	0.92	9
22	– Liquid Permittivity Target tolerance	B	2.5	R	$\sqrt{3}$	0.6	1.95	$\infty$
23	– Liquid Permittivity –measurement uncertainty	B	5	N	$\sqrt{3}$	1	1.15	$\infty$
<b>Combined Standard Uncertainty</b>				RSS			10.15	
<b>Expanded uncertainty</b> (Confidence interval of 95 %)				K=2			20.29	

## ANNEX A: SAR Test Setup

Photo 1: Measurement System SATIMO

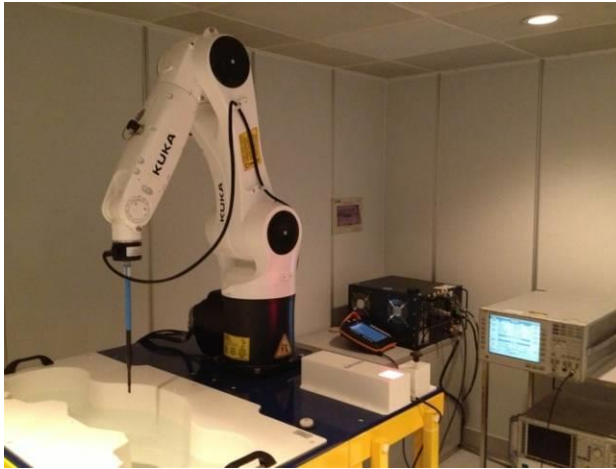

Photo 2: Liquid deep(15cm)



Photo 3: side A 0mm



Photo 4: side B 0mm



EUT ANT



EUT Face View



EUT Back View



## ANNEX B: System Check Plots

### System Performance Check (2450MHz)

Type: Phone measurement

Area scan resolution: dx=8mm,dy=8mm

Zoom scan resolution: dx=5mm, dy=5mm, dz=4mm

Date of measurement: 11/25/2021

Measurement duration: 22 minutes 08 seconds

**A. Experimental conditions.**

<b>Phantom File</b>	dx=8mm dy=8mm
<b>Phantom</b>	7x7x8,dx=5mm dy=5mm dz=4mm
<b>Device Position</b>	Dipole
<b>Band</b>	2450MHz
<b>Channels</b>	
<b>Signal</b>	CW

**B. SAR Measurement Results**

Band SAR

<b>E-Field Probe</b>	SATIMO SN36/20 EPGO348
<b>Frequency (MHz)</b>	2450
<b>Relative permittivity (real part)</b>	38.17
<b>Relative permittivity</b>	13.28
<b>Conductivity (S/m)</b>	1.82
<b>Power Drift (%)</b>	-1.63
<b>Ambient Temperature:</b>	21.9 °C
<b>Liquid Temperature:</b>	22.1 °C
<b>ConvF:</b>	2.40
<b>Duty factor:</b>	1:1

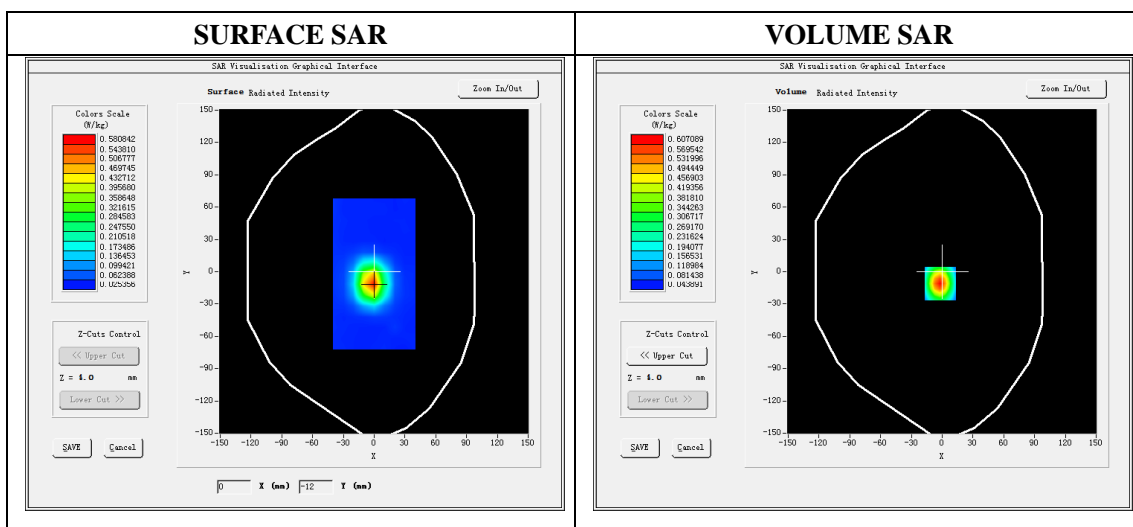

**Maximum location: X=-2.00, Y=-11.00**

**SAR Peak: 1.02 W/kg**

<b>SAR 10g (W/Kg)</b>	0.247509
<b>SAR 1g (W/Kg)</b>	0.534127

<b>Z (mm)</b>	<b>0.00</b>	<b>4.00</b>	<b>8.00</b>	<b>12.00</b>	<b>16.00</b>
<b>SAR (W/Kg)</b>	<b>1.0194</b>	<b>0.6071</b>	<b>0.3548</b>	<b>0.2109</b>	<b>0.1319</b>

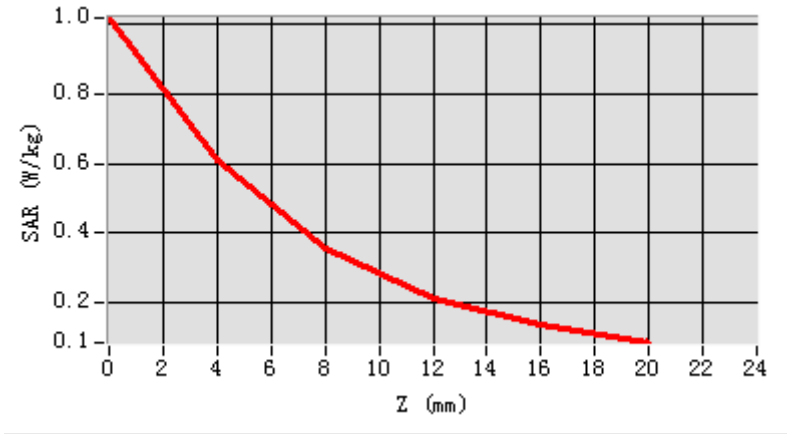

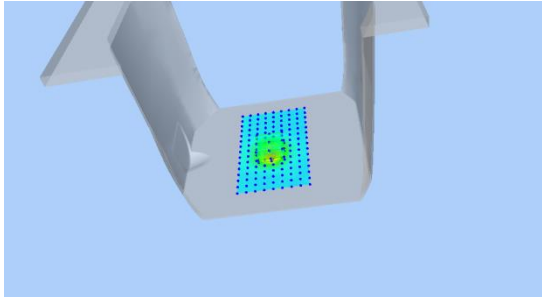
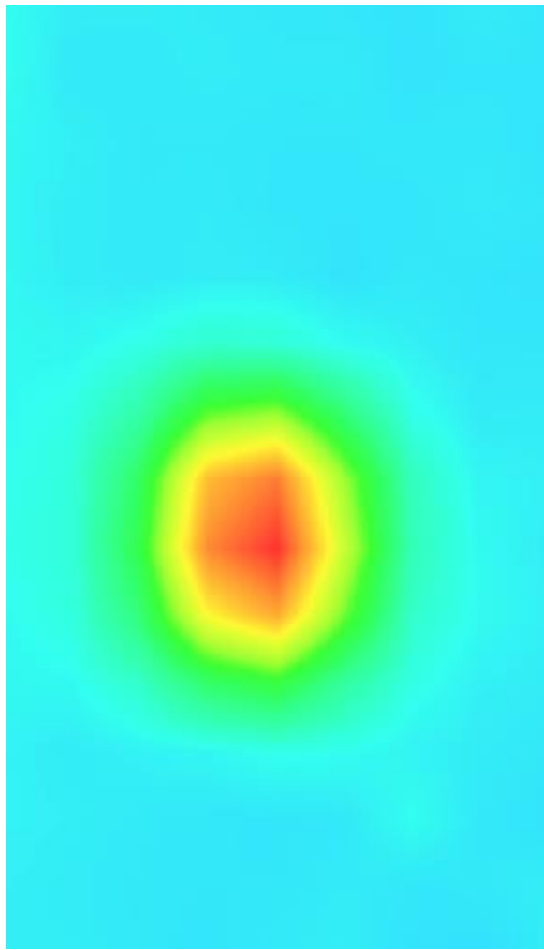
<b>3D screen shot</b>	<b>Hot spot position</b>
	



## ANNEX C: SAR Test Plots

### Testing result (WI-FI 802.11b, Edge A, Middle,0mm)

Type: Phone measurement

Date of measurement: 11/25/2021

Measurement duration: 22 minutes 09 seconds

Mobile Phone IMEI number: --

#### A. Experimental conditions.

<b>Area Scan</b>	dx=8mm dy=8mm
<b>ZoomScan</b>	5x5x7,dx=8mm dy=8mm dz=5mm
<b>Phantom</b>	Validation plane
<b>Device Position</b>	Body
<b>Band</b>	WI-FI 802.11b
<b>Channels</b>	mid
<b>Signal</b>	DSSS (Duty cycle: 1:1)

#### B. SAR Measurement Results

<b>Frequency (MHz)</b>	2437
<b>Relative permittivity (real part)</b>	38.56
<b>Relative permittivity (imaginary part)</b>	13.41
<b>Conductivity (S/m)</b>	1.79
<b>Variation (%)</b>	-2.16

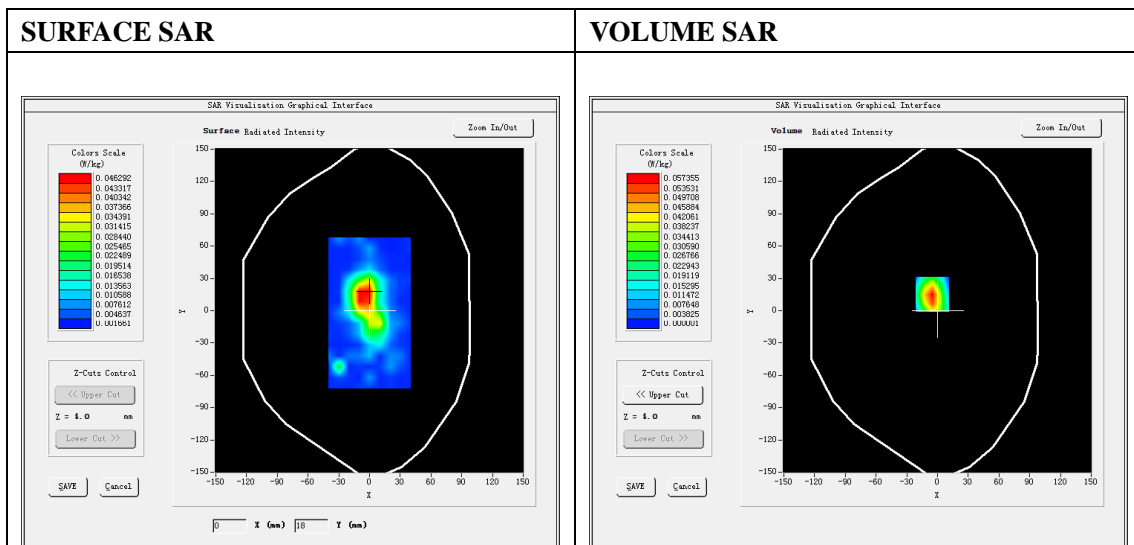

**Maximum location: X=-3.00,Y=20.00**

**SAR Peak: 0.19W/kg**

<b>SAR 10g (W/Kg)</b>	0.027624
<b>SAR 1g (W/Kg)</b>	0.071358

Z (mm)	0.00	4.00	9.00	14.00	19.00
SAR (W/Kg)	0.1958	0.0551	0.0021	0.0001	0.0023

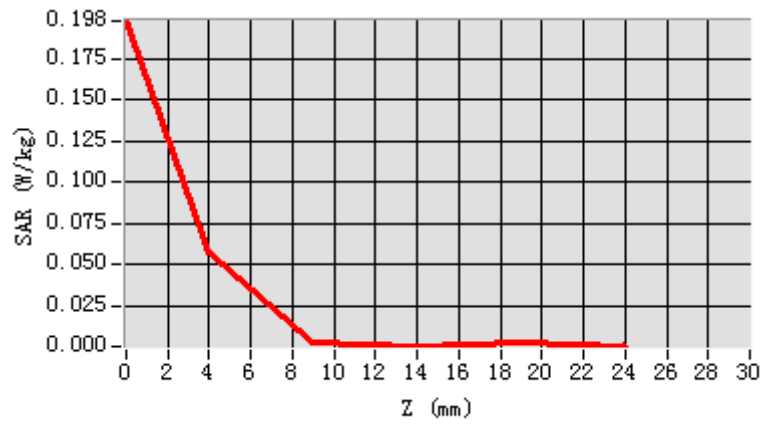

3D screen shot

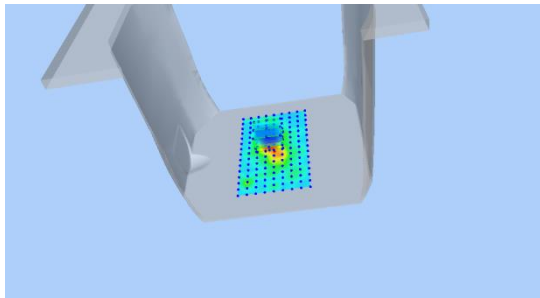

Hot spot position

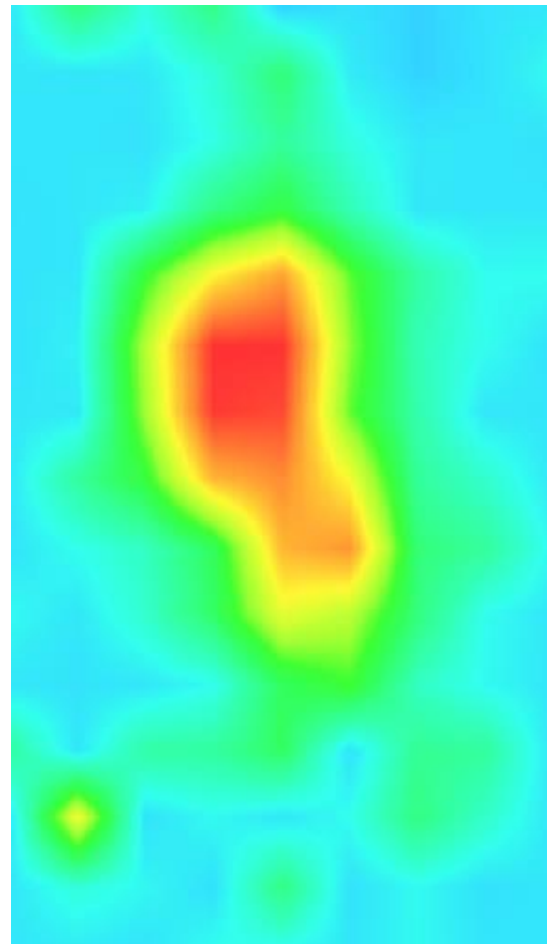

## ANNEX D: Calibration Certificate

EPGO348 Probe Calibration Report



### COMOSAR E-Field Probe Calibration Report

Ref : ACR.349.1.20.MVGB.A

**CCIC SOUTHERN TESTING CO., LTD**  
**ELECTRONIC TESTING BUILDING, NO. 43 SHAHE ROAD,**  
**XILI STREET, NANSHAN DISTRICT**  
**SHENZHEN, GUANGDONG, CHINA**  
**MVG COMOSAR DOSIMETRIC E-FIELD PROBE**  
**SERIAL NO.: SN 36/20 EPGO348**

**Calibrated at MVG**  
**Z.I. de la pointe du diable**  
**Technopôle Brest Iroise – 295 avenue Alexis de Rochon**  
**29280 PLOUZANE - FRANCE**

**Calibration date: 12/14/2020**



Accreditations #2-6789 and #2-6814  
Scope available on [www.cofrac.fr](http://www.cofrac.fr)

**Summary:**

This document presents the method and results from an accredited COMOSAR E-Field Probe calibration performed at MVG, using the CALIPROBE test bench, for use with a MVG COMOSAR system only. The test results covered by accreditation are traceable to the International System of Units (SI).



COMOSAR E-FIELD PROBE CALIBRATION REPORT

Ref: ACR.349.1.20.MVGB.A

	<i>Name</i>	<i>Function</i>	<i>Date</i>	<i>Signature</i>
<i>Prepared by :</i>	Jérôme LUC	Technical Manager	12/14/2020	<i>JS</i>
<i>Checked by :</i>	Jérôme LUC	Technical Manager	12/14/2020	<i>JS</i>
<i>Approved by :</i>	Yann Toutain	Laboratory Director	12/15/2020	<i>Yann Toutain</i>

2020.12.1  
5 12:26:45  
+01'00'

	<i>Customer Name</i>
<i>Distribution :</i>	CCIC SOUTHERN TESTING CO., LTD

<i>Issue</i>	<i>Name</i>	<i>Date</i>	<i>Modifications</i>
A	Jérôme LUC	12/14/2020	Initial release

Template\_ACR.DDD.N.YY.MVGB.ISSUE\_COMOSAR Probe vH

This document shall not be reproduced, except in full or in part, without the written approval of MVG. The information contained herein is to be used only for the purpose for which it is submitted and is not to be released in whole or part without written approval of MVG.



TABLE OF CONTENTS

1 Device Under Test ..... 4

2 Product Description ..... 4

    2.1 General Information ..... 4

3 Measurement Method ..... 4

    3.1 Linearity ..... 4

    3.2 Sensitivity ..... 5

    3.3 Lower Detection Limit ..... 5

    3.4 Isotropy ..... 5

    3.1 Boundary Effect ..... 5

4 Measurement Uncertainty ..... 6

5 Calibration Measurement Results ..... 6

    5.1 Sensitivity in air ..... 6

    5.2 Linearity ..... 7

    5.3 Sensitivity in liquid ..... 8

    5.4 Isotropy ..... 9

6 List of Equipment ..... 10



## 1 DEVICE UNDER TEST

Device Under Test	
Device Type	COMOSAR DOSIMETRIC E FIELD PROBE
Manufacturer	MVG
Model	SSE2
Serial Number	SN 36/20 EPGO348
Product Condition (new / used)	New
Frequency Range of Probe	0.15 GHz-6GHz
Resistance of Three Dipoles at Connector	Dipole 1: R1=0.214 MΩ Dipole 2: R2=0.208 MΩ Dipole 3: R3=0.238 MΩ

## 2 PRODUCT DESCRIPTION

### 2.1 GENERAL INFORMATION

MVG's COMOSAR E field Probes are built in accordance to the IEEE 1528, FCC KDB865664 D01, CENELEC EN62209 and CEI/IEC 62209 standards.



Figure 1 – MVG COMOSAR Dosimetric E field Dipole

Probe Length	330 mm
Length of Individual Dipoles	2 mm
Maximum external diameter	8 mm
Probe Tip External Diameter	2.5 mm
Distance between dipoles / probe extremity	1 mm

## 3 MEASUREMENT METHOD

The IEEE 1528, FCC KDB865664 D01, CENELEC EN62209 and CEI/IEC 62209 standards provide recommended practices for the probe calibrations, including the performance characteristics of interest and methods by which to assess their affect. All calibrations / measurements performed meet the fore mentioned standards.

### 3.1 LINEARITY

The evaluation of the linearity was done in free space using the waveguide, performing a power sweep to cover the SAR range 0.01W/kg to 100W/kg.

Page: 4/10

*Template\_ACR.DDD.N.YY.MVGB.ISSUE\_COMOSAR Probe vH*

*This document shall not be reproduced, except in full or in part, without the written approval of MVG. The information contained herein is to be used only for the purpose for which it is submitted and is not to be released in whole or part without written approval of MVG.*



### 3.2 SENSITIVITY

The sensitivity factors of the three dipoles were determined using a two step calibration method (air and tissue simulating liquid) using waveguides as outlined in the standards.

### 3.3 LOWER DETECTION LIMIT

The lower detection limit was assessed using the same measurement set up as used for the linearity measurement. The required lower detection limit is 10 mW/kg.

### 3.4 ISOTROPY

The axial isotropy was evaluated by exposing the probe to a reference wave from a standard dipole with the dipole mounted under the flat phantom in the test configuration suggested for system validations and checks. The probe was rotated along its main axis from 0 to 360 degrees in 15-degree steps. The hemispherical isotropy is determined by inserting the probe in a thin plastic box filled with tissue-equivalent liquid, with the plastic box illuminated with the fields from a half wave dipole. The dipole is rotated about its axis (0°–180°) in 15° increments. At each step the probe is rotated about its axis (0°–360°).

### 3.1 BOUNDARY EFFECT

The boundary effect is defined as the deviation between the SAR measured data and the expected exponential decay in the liquid when the probe is oriented normal to the interface. To evaluate this effect, the liquid filled flat phantom is exposed to fields from either a reference dipole or waveguide. With the probe normal to the phantom surface, the peak spatial average SAR is measured and compared to the analytical value at the surface.

The boundary effect uncertainty can be estimated according to the following uncertainty approximation formula based on linear and exponential extrapolations between the surface and  $d_{be} + d_{step}$  along lines that are approximately normal to the surface:

$$SAR_{uncertainty} [\%] = \Delta SAR_{be} \frac{(d_{be} + d_{step})^2}{2d_{step}} \frac{(e^{-\alpha(d_{be} + d_{step})})}{\delta/2} \text{ for } (d_{be} + d_{step}) < 10 \text{ mm}$$

where

$SAR_{uncertainty}$  is the uncertainty in percent of the probe boundary effect

$d_{be}$  is the distance between the surface and the closest *zoom-scan* measurement point, in millimetre

$\Delta_{step}$  is the separation distance between the first and second measurement points that are closest to the phantom surface, in millimetre, assuming the boundary effect at the second location is negligible

$\delta$  is the minimum penetration depth in millimetres of the head tissue-equivalent liquids defined in this standard, i.e.,  $\delta \approx 14$  mm at 3 GHz;

$\Delta SAR_{be}$  in percent of SAR is the deviation between the measured SAR value, at the distance  $d_{be}$  from the boundary, and the analytical SAR value.

Page: 5/10

*Template\_ACR.DDD.N.YY.MVGB.ISSUE\_COMOSAR Probe vH*

*This document shall not be reproduced, except in full or in part, without the written approval of MVG. The information contained herein is to be used only for the purpose for which it is submitted and is not to be released in whole or part without written approval of MVG.*



The measured worst case boundary effect SARuncertainty[%] for scanning distances larger than 4mm is 1.0% Limit ,2%).

#### 4 MEASUREMENT UNCERTAINTY

The guidelines outlined in the IEEE 1528, OET 65 Bulletin C, CENELEC EN50361 and CEI/IEC 62209 standards were followed to generate the measurement uncertainty associated with an E-field probe calibration using the waveguide technique. All uncertainties listed below represent an expanded uncertainty expressed at approximately the 95% confidence level using a coverage factor of k=2, traceable to the Internationally Accepted Guides to Measurement Uncertainty.

Uncertainty analysis of the probe calibration in waveguide					
ERROR SOURCES	Uncertainty value (%)	Probability Distribution	Divisor	ci	Standard Uncertainty (%)
Expanded uncertainty 95 % confidence level k = 2					14 %

#### 5 CALIBRATION MEASUREMENT RESULTS

Calibration Parameters	
Liquid Temperature	20 +/- 1 °C
Lab Temperature	20 +/- 1 °C
Lab Humidity	30-80 %

##### 5.1 SENSITIVITY IN AIR

Normx dipole 1 (µV/(V/m) <sup>2</sup> )	Normy dipole 2 (µV/(V/m) <sup>2</sup> )	Normz dipole 3 (µV/(V/m) <sup>2</sup> )
0.45	0.66	0.91

DCP dipole 1 (mV)	DCP dipole 2 (mV)	DCP dipole 3 (mV)
104	105	108

Calibration curves  $e_i=f(V)$  ( $i=1,2,3$ ) allow to obtain E-field value using the formula:

$$E = \sqrt{E_1^2 + E_2^2 + E_3^2}$$

Page: 6/10

*Template\_ACR.DDD.N.YY.MVGB.ISSUE\_COMOSAR Probe vH*

*This document shall not be reproduced, except in full or in part, without the written approval of MVG. The information contained herein is to be used only for the purpose for which it is submitted and is not to be released in whole or part without written approval of MVG.*





**Calibration curves**

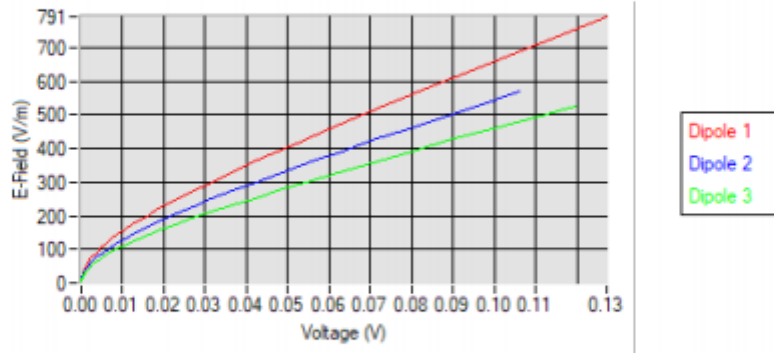

5.2 LINEARITY

**Linearity**

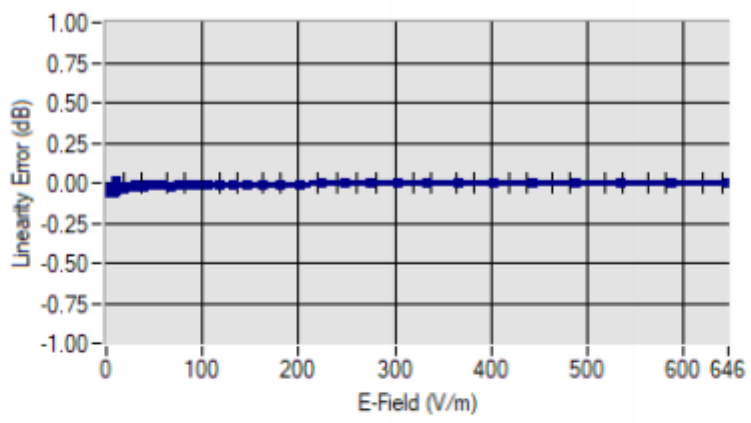

**Linearity: +/- 1.46% (+/- 0.06dB)**



### 5.3 SENSITIVITY IN LIQUID

Liquid	Frequency (MHz +/- 100MHz)	ConvF
HL600	600	1.81
HL750	750	1.85
HL835	835	1.93
HL900	900	1.96
HL1500	1500	2.21
HL1750	1750	2.22
HL1800	1800	2.17
HL1900	1900	2.40
HL2000	2000	2.43
HL2300	2300	2.36
HL2450	2450	2.40
HL2600	2600	2.29
HL3300	3300	2.28
HL3500	3500	2.16
HL3700	3700	2.19
HL3900	3900	2.54
HL4200	4200	2.86
HL4600	4600	2.77
HL4900	4900	2.63
HL5200	5200	2.01
HL5400	5400	2.04
HL5600	5600	2.18
HL5800	5800	2.07

LOWER DETECTION LIMIT: 9mW/kg

Page: 8/10

*Template\_ACR.DDD.N.YY.MVGB.ISSUE\_COMOSAR Probe vH*

*This document shall not be reproduced, except in full or in part, without the written approval of MVG. The information contained herein is to be used only for the purpose for which it is submitted and is not to be released in whole or part without written approval of MVG.*



#### 5.4 ISOTROPY

##### HL1800 MHz

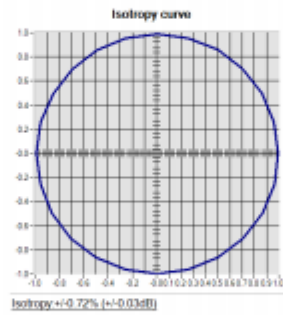

Page: 9/10

*Template\_ACR.DDD.N.YY.MVGB.ISSUE\_COMOSAR Probe vH*

*This document shall not be reproduced, except in full or in part, without the written approval of MVG. The information contained herein is to be used only for the purpose for which it is submitted and is not to be released in whole or part without written approval of MVG.*

**6 LIST OF EQUIPMENT**

Equipment Summary Sheet				
Equipment Description	Manufacturer / Model	Identification No.	Current Calibration Date	Next Calibration Date
Flat Phantom	MVG	SN-20/09-SAM71	Validated. No cal required.	Validated. No cal required.
COMOSAR Test Bench	Version 3	NA	Validated. No cal required.	Validated. No cal required.
Network Analyzer	Rohde & Schwarz ZVM	100203	05/2019	05/2022
Network Analyzer – Calibration kit	Rohde & Schwarz ZV-Z235	101223	05/2019	05/2022
Multimeter	Keithley 2000	1160271	02/2020	02/2023
Signal Generator	Rohde & Schwarz SMB	106589	04/2019	04/2022
Amplifier	Aethercomm	SN 046	Characterized prior to test. No cal required.	Characterized prior to test. No cal required.
Power Meter	NI-USB 5680	170100013	05/2019	05/2022
Directional Coupler	Narda 4216-20	01386	Characterized prior to test. No cal required.	Characterized prior to test. No cal required.
Waveguide	Mega Industries	069Y7-158-13-712	Validated. No cal required.	Validated. No cal required.
Waveguide Transition	Mega Industries	069Y7-158-13-701	Validated. No cal required.	Validated. No cal required.
Waveguide Termination	Mega Industries	069Y7-158-13-701	Validated. No cal required.	Validated. No cal required.
Temperature / Humidity Sensor	Testo 184 H1	44220687	05/2020	05/2023

Page: 10/10

**Template\_ACR.DDD.N.YY.MVGB.ISSUE\_COMOSAR Probe vH**

*This document shall not be reproduced, except in full or in part, without the written approval of MVG. The information contained herein is to be used only for the purpose for which it is submitted and is not to be released in whole or part without written approval of MVG.*

## SID2450 Dipole Calibration Report

**SAR Reference Dipole Calibration Report**

Ref: ACR.178.8.20.MVGB.A

**CCIC SOUTHERN TESTING CO., LTD**  
**ELECTRONIC TESTING BUILDING, NO. 43 SHAHE ROAD,**  
**XILI STREET, NANSHAN DISTRICT**  
**SHENZHEN, GUANGDONG, CHINA**  
**MVG COMOSAR REFERENCE DIPOLE**  
**FREQUENCY: 2450 MHZ**  
**SERIAL NO.: SN 09/13 DIP2G450-220**

**Calibrated at MVG MVG**  
**Z.I. de la pointe du diable**  
**Technopôle Brest Iroise – 295 avenue Alexis de Rochon**  
**29280 PLOUZANE - FRANCE**

**Calibration date: 06/25/2020**

Accreditations #2-6789 and #2-6814  
Scope available on [www.cofrac.fr](http://www.cofrac.fr)

**Summary:**

This document presents the method and results from an accredited SAR reference dipole calibration performed in MVG using the COMOSAR test bench. All calibration results are traceable to national metrology institutions.

Page: 1/11



SAR REFERENCE DIPOLE CALIBRATION REPORT

Ref: ACR.178.8.20.MVGB.A

	<i>Name</i>	<i>Function</i>	<i>Date</i>	<i>Signature</i>
<i>Prepared by :</i>	Jérôme LUC	Technical Manager	6/26/2020	
<i>Checked by :</i>	Jérôme LUC	Technical Manager	6/26/2020	
<i>Approved by :</i>	Yann Toutain	Laboratory Director	6/26/2020	

	<i>Customer Name</i>
<i>Distribution :</i>	CCIC SOUTHERN TESTING CO., LTD

<i>Issue</i>	<i>Name</i>	<i>Date</i>	<i>Modifications</i>
A	Jérôme LUC	6/26/2020	Initial release

*Template\_ACR.DDD.N.YY.MVGB.ISSUE\_SAR Reference Dipole vG*  
 This document shall not be reproduced, except in full or in part, without the written approval of MVG. The information contained herein is to be used only for the purpose for which it is submitted and is not to be released in whole or part without written approval of MVG.



## TABLE OF CONTENTS

1	Introduction.....	4
2	Device Under Test .....	4
3	Product Description .....	4
3.1	General Information .....	4
4	Measurement Method .....	5
4.1	Return Loss Requirements .....	5
4.2	Mechanical Requirements .....	5
5	Measurement Uncertainty .....	5
5.1	Return Loss .....	5
5.2	Dimension Measurement .....	5
5.3	Validation Measurement .....	5
6	Calibration Measurement Results.....	6
6.1	Return Loss and Impedance In Head Liquid .....	6
6.2	Return Loss and Impedance In Body Liquid .....	6
6.3	Mechanical Dimensions .....	6
7	Validation measurement .....	7
7.1	Head Liquid Measurement .....	7
7.2	SAR Measurement Result With Head Liquid .....	8
7.3	Body Liquid Measurement .....	9
7.4	SAR Measurement Result With Body Liquid .....	10
8	List of Equipment .....	11

Page: 3/11

*Template: ACR.DDD.N.YY.MVGB.ISSUE\_SAR Reference Dipole vG*

*This document shall not be reproduced, except in full or in part, without the written approval of MVG. The information contained herein is to be used only for the purpose for which it is submitted and is not to be released in whole or part without written approval of MVG.*



## 1 INTRODUCTION

This document contains a summary of the requirements set forth by the IEEE 1528, FCC KDBs and CEI/IEC 62209 standards for reference dipoles used for SAR measurement system validations and the measurements that were performed to verify that the product complies with the fore mentioned standards.

## 2 DEVICE UNDER TEST

Device Under Test	
Device Type	COMOSAR 2450 MHz REFERENCE DIPOLE
Manufacturer	MVG
Model	SID2450
Serial Number	SN 09/13 DIP2G450-220
Product Condition (new / used)	Used

## 3 PRODUCT DESCRIPTION

### 3.1 GENERAL INFORMATION

MVG's COMOSAR Validation Dipoles are built in accordance to the IEEE 1528, FCC KDBs and CEI/IEC 62209 standards. The product is designed for use with the COMOSAR test bench only.



**Figure 1 – MVG COMOSAR Validation Dipole**

Page: 4/11

*Template: ACR.DDD.N.YY.MVGB.ISSUE\_SAR Reference Dipole vG*

*This document shall not be reproduced, except in full or in part, without the written approval of MVG. The information contained herein is to be used only for the purpose for which it is submitted and is not to be released in whole or part without written approval of MVG.*





#### 4 MEASUREMENT METHOD

The IEEE 1528, FCC KDBs and CEI/IEC 62209 standards provide requirements for reference dipoles used for system validation measurements. The following measurements were performed to verify that the product complies with the fore mentioned standards.

##### 4.1 RETURN LOSS REQUIREMENTS

The dipole used for SAR system validation measurements and checks must have a return loss of -20 dB or better. The return loss measurement shall be performed against a liquid filled flat phantom, with the phantom constructed as outlined in the fore mentioned standards. A direct method is used with a network analyser and its calibration kit, both with a valid ISO17025 calibration.

##### 4.2 MECHANICAL REQUIREMENTS

The IEEE Std. 1528 and CEI/IEC 62209 standards specify the mechanical components and dimensions of the validation dipoles, with the dimension's frequency and phantom shell thickness dependent. The COMOSAR test bench employs a 2 mm phantom shell thickness therefore the dipoles sold for use with the COMOSAR test bench comply with the requirements set forth for a 2 mm phantom shell thickness. A direct method is used with a ISO17025 calibrated caliper.

#### 5 MEASUREMENT UNCERTAINTY

All uncertainties listed below represent an expanded uncertainty expressed at approximately the 95% confidence level using a coverage factor of  $k=2$ , traceable to the Internationally Accepted Guides to Measurement Uncertainty.

##### 5.1 RETURN LOSS

The following uncertainties apply to the return loss measurement:

Frequency band	Expanded Uncertainty on Return Loss
400-6000MHz	0.08 LIN

##### 5.2 DIMENSION MEASUREMENT

The following uncertainties apply to the dimension measurements:

Length (mm)	Expanded Uncertainty on Length
0 - 300	0.20 mm
300 - 450	0.44 mm

##### 5.3 VALIDATION MEASUREMENT

The guidelines outlined in the IEEE 1528, FCC KDBs, CENELEC EN50361 and CEI/IEC 62209 standards were followed to generate the measurement uncertainty for validation measurements.

Scan Volume	Expanded Uncertainty

Page: 5/11

*Template\_ACR.DDD.N.YY.MVGB.ISSUE\_SAR Reference Dipole vG*

*This document shall not be reproduced, except in full or in part, without the written approval of MVG. The information contained herein is to be used only for the purpose for which it is submitted and is not to be released in whole or part without written approval of MVG.*



## SAR REFERENCE DIPOLE CALIBRATION REPORT

Ref: ACR.178.8.20.MVGB.A

1 g	19 % (SAR)
10 g	19 % (SAR)

## 6 CALIBRATION MEASUREMENT RESULTS

### 6.1 RETURN LOSS AND IMPEDANCE IN HEAD LIQUID

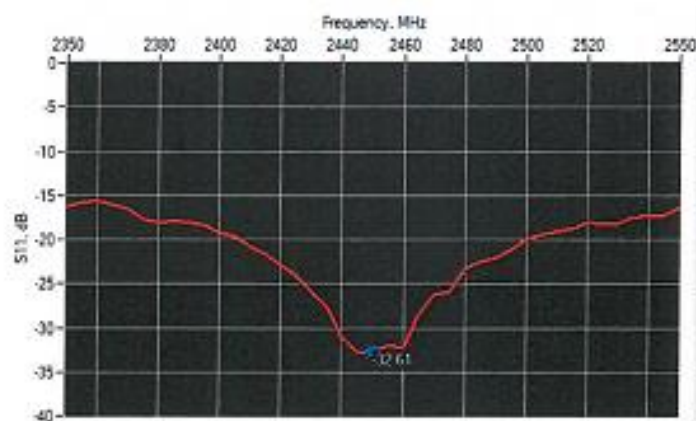

Frequency (MHz)	Return Loss (dB)	Requirement (dB)	Impedance
2450	-32.61	-20	$52.3 \Omega + 0.3 j\Omega$

### 6.2 RETURN LOSS AND IMPEDANCE IN BODY LIQUID

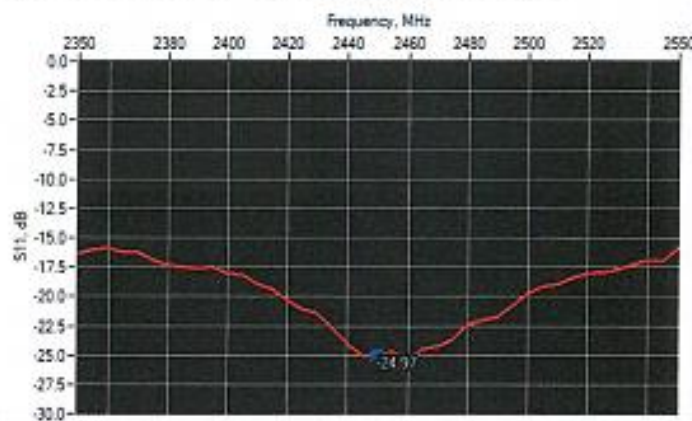

Frequency (MHz)	Return Loss (dB)	Requirement (dB)	Impedance
2450	-24.97	-20	$55.6 \Omega - 0.4 j\Omega$

### 6.3 MECHANICAL DIMENSIONS

Frequency MHz	L mm		h mm		d mm	
	required	measured	required	measured	required	measured

Page: 6/11

*Template\_ACR.DDD.N.YY.MVGB.ISSUE\_SAR Reference Dipole vG*

This document shall not be reproduced, except in full or in part, without the written approval of MVG. The information correlated herein is to be used only for the purpose for which it is submitted and is not to be released in whole or part without written approval of MVG.



## SAR REFERENCE DIPOLE CALIBRATION REPORT

Ref: ACR178.8.20.MVGB.A

300	420.0 ±1 %		250.0 ±1 %		6.35 ±1 %	
450	290.0 ±1 %		166.7 ±1 %		6.35 ±1 %	
750	176.0 ±1 %		100.0 ±1 %		6.35 ±1 %	
835	161.0 ±1 %		89.8 ±1 %		3.6 ±1 %	
900	149.0 ±1 %		83.3 ±1 %		3.6 ±1 %	
1450	89.1 ±1 %		51.7 ±1 %		3.6 ±1 %	
1500	80.5 ±1 %		50.0 ±1 %		3.6 ±1 %	
1640	79.0 ±1 %		45.7 ±1 %		3.6 ±1 %	
1750	75.2 ±1 %		42.9 ±1 %		3.6 ±1 %	
1800	72.0 ±1 %		41.7 ±1 %		3.6 ±1 %	
1900	68.0 ±1 %		39.5 ±1 %		3.6 ±1 %	
1950	66.3 ±1 %		38.5 ±1 %		3.6 ±1 %	
2000	64.5 ±1 %		37.5 ±1 %		3.6 ±1 %	
2100	61.0 ±1 %		35.7 ±1 %		3.6 ±1 %	
2300	55.5 ±1 %		32.6 ±1 %		3.6 ±1 %	
2450	51.5 ±1 %	-	30.4 ±1 %	-	3.6 ±1 %	-
2600	48.5 ±1 %		28.8 ±1 %		3.6 ±1 %	
3000	41.5 ±1 %		25.0 ±1 %		3.6 ±1 %	
3500	37.0 ±1 %		26.4 ±1 %		3.6 ±1 %	
3700	34.7 ±1 %		26.4 ±1 %		3.6 ±1 %	

## 7 VALIDATION MEASUREMENT

The IEEE Std. 1528, FCC KDBs and CEI/IEC 62209 standards state that the system validation measurements must be performed using a reference dipole meeting the fore mentioned return loss and mechanical dimension requirements. The validation measurement must be performed against a liquid filled flat phantom, with the phantom constructed as outlined in the fore mentioned standards. Per the standards, the dipole shall be positioned below the bottom of the phantom, with the dipole length centered and parallel to the longest dimension of the flat phantom, with the top surface of the dipole at the described distance from the bottom surface of the phantom.

### 7.1 HEAD LIQUID MEASUREMENT

Frequency MHz	Relative permittivity ( $\epsilon_r$ )		Conductivity ( $\sigma$ ) S/m	
	required	measured	required	measured
300	45.3 ±10 %		0.87 ±10 %	
450	43.5 ±10 %		0.87 ±10 %	
750	41.9 ±10 %		0.89 ±10 %	
835	41.5 ±10 %		0.90 ±10 %	
900	41.5 ±10 %		0.97 ±10 %	
1450	40.5 ±10 %		1.20 ±10 %	
1500	40.4 ±10 %		1.23 ±10 %	
1640	40.2 ±10 %		1.31 ±10 %	

Page: 7/11

*Template\_ACR.DDD.N.YY.MVGB.ISSUE\_SAR Reference Dipole vG*

*This document shall not be reproduced, except in full or in part, without the written approval of MVG. The information contained herein is to be used only for the purpose for which it is submitted and is not to be released in whole or part without written approval of MVG.*



## SAR REFERENCE DIPOLE CALIBRATION REPORT

Ref: ACR.178.8.20.MVGB.A

1750	40.1 ±10 %		1.37 ±10 %	
1800	40.0 ±10 %		1.40 ±10 %	
1900	40.0 ±10 %		1.40 ±10 %	
1950	40.0 ±10 %		1.40 ±10 %	
2000	40.0 ±10 %		1.40 ±10 %	
2100	39.8 ±10 %		1.49 ±10 %	
2300	39.5 ±10 %		1.67 ±10 %	
2450	39.2 ±10 %	41.9	1.80 ±10 %	1.88
2600	39.0 ±10 %		1.96 ±10 %	
3000	38.5 ±10 %		2.40 ±10 %	
3500	37.9 ±10 %		2.91 ±10 %	

## 7.2 SAR MEASUREMENT RESULT WITH HEAD LIQUID

The IEEE Std. 1528 and CEI/IEC 62209 standards state that the system validation measurements should produce the SAR values shown below (for phantom thickness of 2 mm), within the uncertainty for the system validation. All SAR values are normalized to 1 W forward power. In bracket, the measured SAR is given with the used input power.

Software	OPENSAR V5
Phantom	SN 13/09 SAM68
Probe	SN 41/18 EPGO333
Liquid	Head Liquid Values: $\epsilon_{ps}^*$ : 41.9 sigma : 1.88
Distance between dipole center and liquid	10.0 mm
Area scan resolution	$dx=8mm/dy=8mm$
Zoon Scan Resolution	$dx=5mm/dy=5mm/dz=5mm$
Frequency	2450 MHz
Input power	20 dBm
Liquid Temperature	20 +/- 1 °C
Lab Temperature	20 +/- 1 °C
Lab Humidity	30-70 %

Frequency MHz	1 g SAR (W/kg/W)		10 g SAR (W/kg/W)	
	required	measured	required	measured
300	2.85		1.94	
450	4.58		3.06	
750	8.49		5.55	
835	9.56		6.22	
900	10.9		6.99	
1450	29		16	
1500	30.5		16.8	
1640	34.2		18.4	
1750	36.4		19.3	

Page: 8/11

Template: ACR.DDD.N.VV.MVGB.ISSUE\_SAR Reference Dipole vG

This document shall not be reproduced, except in full or in part, without the written approval of MVG. The information contained herein is to be used only for the purpose for which it is submitted and is not to be released in whole or part without written approval of MVG.



## SAR REFERENCE DIPOLE CALIBRATION REPORT

Ref: ACR.178.8.20.MVGB.A

1800	38.4		20.1	
1900	39.7		20.5	
1950	40.5		20.9	
2000	41.1		21.1	
2100	43.6		21.9	
2300	48.7		23.3	
2450	52.4	53.71 (5.37)	24	24.17 (2.42)
2600	55.3		24.6	
3000	63.8		25.7	
3500	67.1		25	
3700	67.4		24.2	

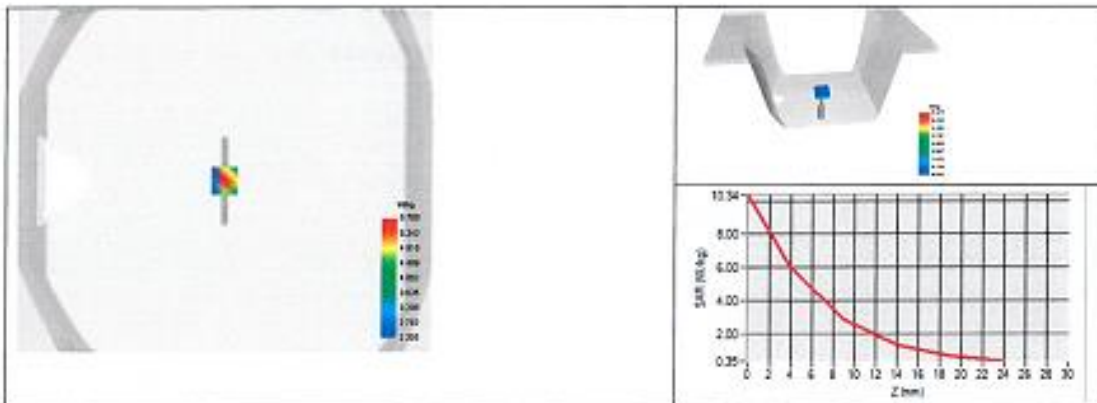

## 7.3 BODY LIQUID MEASUREMENT

Frequency MHz	Relative permittivity ( $\epsilon_r'$ )		Conductivity ( $\sigma$ ) S/m	
	required	measured	required	measured
150	61.9 ±10 %		0.80 ±10 %	
300	58.2 ±10 %		0.92 ±10 %	
450	56.7 ±10 %		0.94 ±10 %	
750	55.5 ±10 %		0.96 ±10 %	
835	55.2 ±10 %		0.97 ±10 %	
900	55.0 ±10 %		1.05 ±10 %	
915	55.0 ±10 %		1.06 ±10 %	
1450	54.0 ±10 %		1.30 ±10 %	
1610	53.8 ±10 %		1.40 ±10 %	
1800	53.3 ±10 %		1.52 ±10 %	
1900	53.3 ±10 %		1.52 ±10 %	
2000	53.3 ±10 %		1.52 ±10 %	
2100	53.2 ±10 %		1.62 ±10 %	

Page: 9/11

*Template\_ACR.DDD.N.YY.MVGB.ISSUE\_SAR Reference Dipole vG*

*This document shall not be reproduced, except in full or in part, without the written approval of MVG. The information contained herein is to be used only for the purpose for which it is submitted and is not to be released in whole or part without written approval of MVG.*



## SAR REFERENCE DIPOLE CALIBRATION REPORT

Ref: ACR.178.8.20.MVGB.A

2300	52.9 ±10 %		1.81 ±10 %	
2450	52.7 ±10 %	53.4	1.95 ±10 %	2.14
2600	52.5 ±10 %		2.16 ±10 %	
3000	52.0 ±10 %		2.73 ±10 %	
3500	51.3 ±10 %		3.31 ±10 %	
3700	51.0 ±10 %		3.55 ±10 %	
5200	49.0 ±10 %		5.30 ±10 %	
5300	48.9 ±10 %		5.42 ±10 %	
5400	48.7 ±10 %		5.53 ±10 %	
5500	48.6 ±10 %		5.65 ±10 %	
5600	48.5 ±10 %		5.77 ±10 %	
5800	48.2 ±10 %		6.00 ±10 %	

## 7.4 SAR MEASUREMENT RESULT WITH BODY LIQUID

Software	OPENSAR V5
Phantom	SN 13/09 SAM68
Probe	SN 41/18 EPG0333
Liquid	Body Liquid Values: $\epsilon_{ps}^*$ : 53.4 $\sigma$ : 2.14
Distance between dipole center and liquid	10.0 mm
Area scan resolution	$dx=8mm/dy=8mm$
Zoon Scan Resolution	$dx=5mm/dy=5mm/dz=5mm$
Frequency	2450 MHz
Input power	20 dBm
Liquid Temperature	20 +/- 1 °C
Lab Temperature	20 +/- 1 °C
Lab Humidity	30-70 %

Frequency MHz	1 g SAR (W/kg/W)	10 g SAR (W/kg/W)
	measured	measured
2450	54.83 (5.48)	23.59 (2.36)

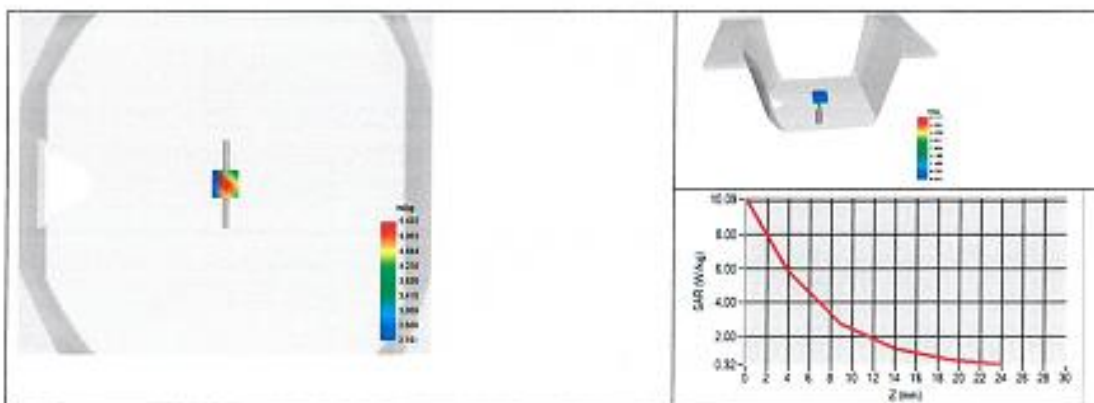

Page: 10/11

Template: ACR.DDD.N.YY.MVGB.ISSUE\_SAR Reference Dipole vG

This document shall not be reproduced, except in full or in part, without the written approval of MVG. The information contained herein is to be used only for the purpose for which it is submitted and is not to be released in whole or part without written approval of MVG.



## 8 LIST OF EQUIPMENT

Equipment Summary Sheet				
Equipment Description	Manufacturer / Model	Identification No.	Current Calibration Date	Next Calibration Date
SAM Phantom	MVG	SN-13/09-SAM68	Validated. No cal required.	Validated. No cal required.
COMOSAR Test Bench	Version 3	NA	Validated. No cal required.	Validated. No cal required.
Network Analyzer	Rohde & Schwarz ZVM	100203	05/2019	05/2022
Network Analyzer – Calibration kit	Rohde & Schwarz ZV-Z235	101223	05/2019	05/2022
Calipers	Mitutoyo	SN 0009732	10/2019	10/2022
Reference Probe	MVG	EPGO333 SN 41/18	05/2020	05/2021
Multimeter	Keithley 2000	1160271	02/2020	02/2023
Signal Generator	Rohde & Schwarz SMB	106589	04/2019	04/2022
Amplifier	Aethercomm	SN 046	Characterized prior to test. No cal required.	Characterized prior to test. No cal required.
Power Meter	NI-USB 5680	170100013	05/2019	05/2022
Directional Coupler	Narda 4216-20	01386	Characterized prior to test. No cal required.	Characterized prior to test. No cal required.
Temperature / Humidity Sensor	Control Company	150798832	11/2017	11/2020

Page: 11/11

Template: ACR.DDD.N.YY.MVGB.ISSUE\_SAR Reference Dipole v6

This document shall not be reproduced, except in full or in part, without the written approval of MVG. The information contained herein is to be used only for the purpose for which it is submitted and is not to be released in whole or part without written approval of MVG.

### Verification data

Head 2450MHz				
Date of Measurement	Return Loss (dB)	Delta (%)	Impedance	Delta(ohm)
2020.06.25	-32.61	-	52.3	-
2021.06.23	-32.25	8.64	51.966	-0.334

The return loss is <-20dB, within 20% of prior calibration; the impedance is within 5 ohm of prior calibration. Therefore the verification result should support extended calibration.

### <Dipole Verification Data>

#### Head 2450MHz

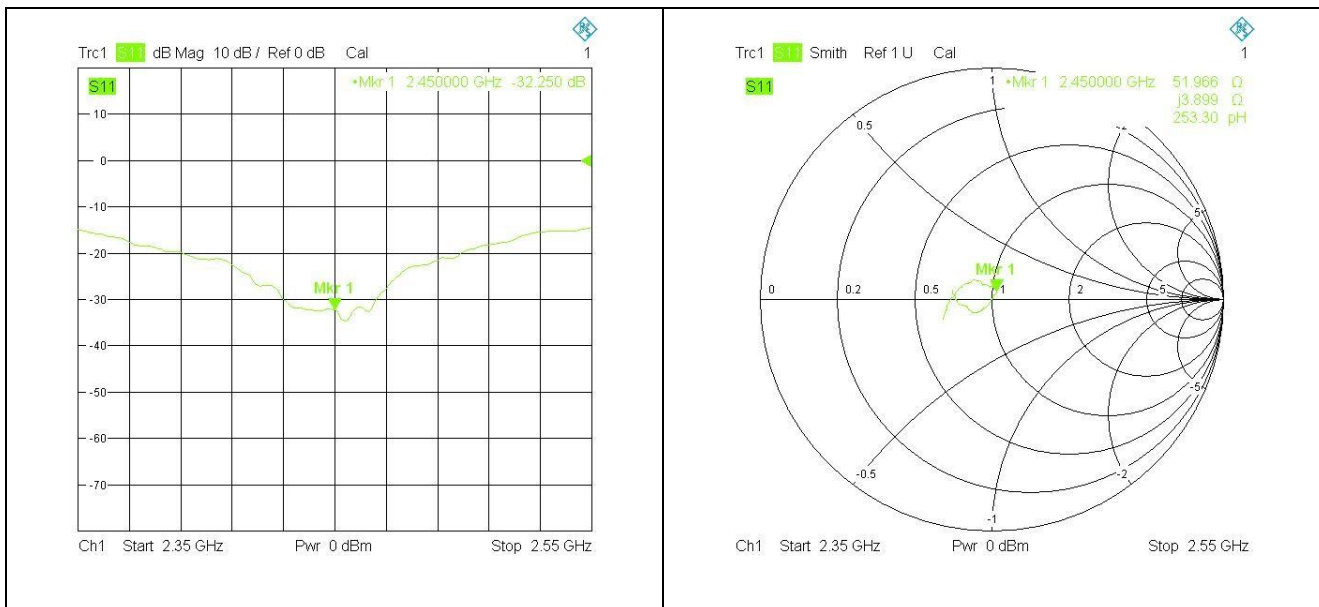

—End of the Report—