



NFC TEST REPORT

No.I22Z60667-IOT01

for

HONOR Device Co., Ltd.

Smart Phone

Model Name: VNE-N41

FCC ID: 2AYGCVNE-N41

with

Hardware Version: HN2VNEM

Software Version: 4.2.0.55(C900E55R1P1)

Issued Date: 2022-05-31

Note:

The test results in this test report relate only to the devices specified in this report. This report shall not be reproduced except in full without the written approval of CTTL.

The report must not be used by the client to claim product certification, approval, or endorsement by NVLAP, NIST, or any agency of the U.S.Government.

Test Laboratory:

CTTL-Telecommunication Technology Labs, CAICT

No. 52, Huayuan North Road, Haidian District, Beijing, P. R. China 100191.

Tel:+86(0)10-62304633-2512, Fax:+86(0)10-62304633-2504

Email: ctl_terminals@caict.ac.cn, website: www.caict.ac.cn



REPORT HISTORY

Report Number	Revision	Description	Issue Date
I22Z60667-IOT01	Rev.0	1 st edition	2022-05-31

Note: the latest revision of the test report supersedes all previous version.



CONTENTS

1. TEST LABORATORY	4
1.1. INTRODUCTION & ACCREDITATION.....	4
1.2. TESTING LOCATION	4
1.3. TESTING ENVIRONMENT	5
1.4. PROJECT DATA	5
1.5. SIGNATURE.....	5
2. CLIENT INFORMATION.....	6
2.1. APPLICANT INFORMATION.....	6
2.2. MANUFACTURER INFORMATION.....	6
3. EQUIPMENT UNDER TEST (EUT) AND ANCILLARY EQUIPMENT (AE)	7
3.1. ABOUT EUT	7
3.2. INTERNAL IDENTIFICATION OF EUT	7
3.3. INTERNAL IDENTIFICATION OF AE	7
3.4. EUT SET-UPS.....	8
4. REFERENCE DOCUMENTS	9
4.1. DOCUMENTS SUPPLIED BY APPLICANT	9
4.2. REFERENCE DOCUMENTS FOR TESTING.....	9
5. TEST RESULTS	10
5.1. SUMMARY OF TEST RESULTS	10
5.2. STATEMENTS.....	11
6. TEST FACILITIES UTILIZED	12
7. MEASUREMENT UNCERTAINTY	13
ANNEX A: EUT PARAMETERS.....	14
ANNEX B: DETAILED TEST RESULTS.....	15
ANNEX C: PERSONS INVOLVED IN THIS TESTING	27
ANNEX D: ACCREDITATION CERTIFICATE	28



No. I22Z60667-IOT01

1. Test Laboratory

1.1. Introduction & Accreditation

Telecommunication Technology Labs, CAICT is an ISO/IEC 17025:2017 accredited test laboratory under NATIONAL VOLUNTARY LABORATORY ACCREDITATION PROGRAM (NVLAP) with lab code 600118-0, and is also an FCC accredited test laboratory (CN5017), and ISED accredited test laboratory (ISED#: 24849). The detail accreditation scope can be found on NVLAP website.

1.2. Testing Location

Location 1: CTTL(huayuan North Road)

Address: No. 52, Huayuan North Road, Haidian District, Beijing,
P. R. China 100191

1.3. Testing Environment

Normal Temperature: 15-35°C
Extreme Temperature: -20/+50°C
Normal Relative Humidity: 20-75%
Normal Air Pressure 86Kpa-106Kpa

1.4. Project data

Testing Start Date: 2022-04-20
Testing End Date: 2022-05-23

1.5. Signature



Zhou Bin

(Prepared this test report)



Zhang Qiang

(Reviewed this test report)



Zhu Liang

(Approved this test report)



2. Client Information

2.1. Applicant Information

Company Name: HONOR Device Co., Ltd
Suite 3401,Unit A,Building 6,Shum Yip Sky Park,No.8089,Hongli
Address: West Road,Xiangmihu Street,Futian District,Shenzhen,Guangdong
518040,People's Republic of China
Contact: /
Telephone: /
Email: /

2.2. Manufacturer Information

Company Name: HONOR Device Co., Ltd
Suite 3401,Unit A,Building 6,Shum Yip Sky Park,No.8089,Hongli
Address: West Road,Xiangmihu Street,Futian District,Shenzhen,Guangdong
518040,People's Republic of China
Contact: /
Telephone: /
Email: /

3. Equipment Under Test (EUT) and Ancillary Equipment (AE)

3.1. About EUT

Description	Smart Phone
Model Name	VNE-N41
FCC ID	2AYGCVNE-N41
GSM Frequency Bands	B2/B3/B5/B8
WCDMA Frequency Bands	B1/B2/B5/B8
LTE Frequency Bands	FDD B1/B3/B5/B7/B8/B20/B28A/B32 TDD B38/B40/B41
5G NR Frequency Bands	n1/n3/n7/n8/n20/n28A/n38/n40/n41/n77(3.3GHz-3.8GHz)/n78
Operating temperature	0/+35°C
Extreme low voltage	3.6 V
Normal voltage	3.87 V
Extreme high voltage	4.45 V

3.2. Internal Identification of EUT

EUT ID*	SN or IMEI	HW Version	SW Version
UT22a	864258060052700/864258060067179	HN2VNEM	4.2.0.55(C900E55R1P1)
UT25a	864258060053740/864258060068219	HN2VNEM	4.2.0.55(C900E55R1P1)
UT27a	864258060054268/864258060068730	HN2VNEM	4.2.0.55(C900E55R1P1)
UT29a	864258060052007/864258060066478	HN2VNEM	4.2.0.55(C900E55R1P1)
UT36a	864258060052593/864258060067062	HN2VNEM	4.2.0.55(C900E55R1P1)

*EUT ID: is used to identify the test sample in the lab internally.

3.3. Internal Identification of AE

AE ID*	Description	Note
AE1-1	Adapter	HN-100225U00 (Salcon)
AE1-2	Adapter	HN-100225E00 (Salcon)
AE1-3	Adapter	HW-100225U00 (Huntkey)
AE1-4	Adapter	HW-100225E00 (Huntkey)
AE1-5	Adapter	HW-100225B00 (Huntkey)
AE2-1	USB Cable	CUDU01B-HC451 -EH (FF)
AE2-2	USB Cable	AU2-CRO013 HF (LJ)
AE2-3	USB Cable	L125UC007-CS-H (LX)
AE2-4	USB Cable	2120-00001-0 (MG)
AE2-5	USB Cable	RY0002 (NB)
AE3-1	Headset	1293-3283-3.5mm-339
AE3-2	Headset	EPAB542-2WH05-DH

AE3-3	Headset	MEND1532B528A11
AE4-1	Battery	HB496590EFW (SCUD)
AE4-2	Battery	HB496590EFW-F (SCUD-F)
AE4-3	Battery	HB496590EFW (NVT)
AE4-4	Battery	HB496590EFW-F (NVT-F)

*AE ID: is used to identify the ancillary equipment in the lab internally.

3.4. EUT Set-ups

EUT set-up No.	Combination of EUT and AE	Remarks
Set.NFC1-1	UT22a + AE1-2 + AE2-1+AE3-1	EUT1+CHANGING+Heaset1
Set.NFC1-2	UT25a + AE1-2 + AE2-2+AE3-2	EUT2+CHANGING+Heaset2
Set.NFC1-3	UT27a + AE1-3 + AE2-3+AE3-3	EUT3+CHANGING+Heaset3
Set.NFC1-4	UT29a + AE1-4 + AE2-4/2-5+AE3-1	EUT4+CHANGING+Heaset1
Set.NFC2-1	UT22a	NFC
Set.NFC2-2	UT25a	NFC
Set.NFC2-3	UT27a	NFC
Set.NFC2-4	UT29a	NFC
Set.NFC4	UT36a	charger

The Transmit State of NFC: the NFC function is on. The EUT will transmit the NFC data and command continuously during the test.

The Transmit state without modulation: The EUT will transmit the CW signal at the operating frequency.

4. Reference Documents

4.1. Documents supplied by applicant

EUT parameters, referring to Annex A for detailed information, are supplied by the client or manufacturer, which are the bases of testing.

4.2. Reference Documents for testing

The following documents listed in this section are referred for testing.

Reference	Title	Version
CFR 47 Part 2	Part 2 — Frequency Allocations and Radio Treaty Matters; General Rules and Regulations.	2019
CFR 47 Part 15	Part 15 — Radio Frequency Devices. Subpart C — Intentional Radiators. § 15.35 Measurement detector functions and bandwidths. § 15.207 Conducted limits. § 15.209 Radiated emission limits, general requirements. § 15.215 Additional provisions to the general radiated emission limitations. § 15.225 Operation within the band 13.110–14.010 MHz.	2019
ANSI C63.10	American National Standard of Procedures for Compliance Testing of Unlicensed Wireless Devices	2013

5. Test Results

5.1. Summary of Test Results

No	Test Cases	Clause in Regulation	Section in This Report	Verdict
1	Electric Field Strength of Fundamental Emissions	CFR 47 § 15.225(a)	B.1	P (Set. NFC2-1 Set. NFC2-2, Set. NFC2-3, Set. NFC2-4)
2	Electric Field Strength of Outside the Allocated Bands	CFR 47 § 15.225(b) CFR 47 § 15.225(c)		P (Set. NFC2-1 Set. NFC2-2, Set. NFC2-3, Set. NFC2-4)
3	Electric Field Radiated Emissions	CFR 47 § 15.209 CFR 47 § 15.225(d)	B.2	P (Set. NFC2-1, Set. NFC2-2, Set. NFC2-3, Set. NFC2-4)
			B.3	P (Set. NFC1-1, Set. NFC1-2, Set. NFC1-3, Set. NFC1-4)
4	Frequency Tolerance	CFR 47 § 15.225(e)	B.4	P(Set. NFC4)
5	20dB Bandwidth	CFR 47 § 15.215(c)	B.5	P(Set. NFC4)
6	Conducted Emissions	CFR 47 § 15.207	B.6	P (Set. NFC1-1, Set. NFC1-2, Set. NFC1-3, Set. NFC1-4)
The measurement is carried out according to ANSI C63.10. See ANNEX B for details.				

Test Conditions:

For this report, all the test cases listed above were tested under normal Temperature, Voltage, humidity and Air Pressure except the Frequency Tolerance test case. The specific conditions of Frequency Tolerance test case are listed in section B.4.3

See Table 3 for terms for result verdict:

Table 1 Terms for result verdict

P	Pass, The EUT complies with the essential requirements in the standard.
NP	Not Perform, The test was not performed by CTTL
NA	Not Applicable, The test was not applicable
F	Fail, The EUT does not comply with the essential requirements in the standard

5.2. Statements

The test cases listed in Section 5.1 of this report for the EUT specified in Section 3 were performed by CTTL according to the reference documents in Section 4.

The EUT meets all applicable requirements of the regulations and standards in Section 4.2.

6. Test Facilities Utilized

NO.	NAME	TYPE	SERIES NUMBER	PRODUCER	CAL. DUE DATE	CAL. INTERVAL
1.	Spectrum Analyzer	RSA3408A	B010277	Tektronix	2022-10-28	1 Year
2.	Climatic chamber	SH242	93008658	ESPEC	2023-02-21	2 Year
3.	Test Receiver	ESW44	103015	R&S	2022-09-03	1 Year
4.	H-field Antenna	HFH2-Z2	829324/007	R&S	2022-12-23	1 Year
5.	Test Receiver	ESW44	103023	R&S	2022-06-26	1 Year
6.	EMI Antenna	VULB 9163	302	SCHWARZBEC K	2022-12-28	1 Year
7.	Test Receiver	ESCI	100344	R&S	2023-02-21	1 Year
8.	LISN	ENV216	101200	R&S	2022-05-30	1 Year

7. Measurement Uncertainty

Item	Uncertainty
Frequency Tolerance	$U = 77 \text{ Hz}, k=2$
20dB Bandwidth	$U = 77 \text{ Hz}, k=2$
Radiated Emissions(9kHz- 30MHz)	$U = 5.16 \text{ dB}, k=2$
Radiated Emissions (30MHz-1GHz)	$U = 5.74 \text{ dB}, k=2$
Radiated Emissions(>1GHz)	$U = 5.28 \text{ dB}, k=2$
Conducted emission	$U = 3.08 \text{ dB}, k=2$



ANNEX A: EUT parameters

/

ANNEX B: Detailed Test Results

B.1. Electric Field Strength of Fundamental and Outside the Allocated bands

B.1.1. Reference

See Clause 4, Clause 5 of ANSI C63.10-2013 generally.

B.1.2. Measurement Methods

The transmitter carrier output levels (E-Field) from the EUT are measured in a semi-anechoic chamber. The EUT is placed on a non-conductive stand of 80cm high, and at a measurement distance of 3m from the receiving antenna. The center of the receiving loop antenna is 1.0 meter above the ground. The E-field is measured with a shielded loop antenna connected to a measurement receiver. Detected E-field was maximized by rotating the EUT through 360° and adjusting the receiving antenna polarizations. The maximization processes were repeated with the EUT positioned respectively in its three orthogonal axes. The measurements were performed with the peak detector and if required, the quasi-peak detector.

The measurement bandwidth is:

Table B-1: Measurement bandwidth

Frequency of Emission (MHz)	RBW/VBW
12.56-14.56	10/30 kHz

The E-field measured at 3m is calculated as:

$$\text{E-field (dB}\mu\text{V/m)} = \text{Rx (dB}\mu\text{V)} + \text{Cable Loss (dB)} + \text{AF@3m (dB/m)}$$

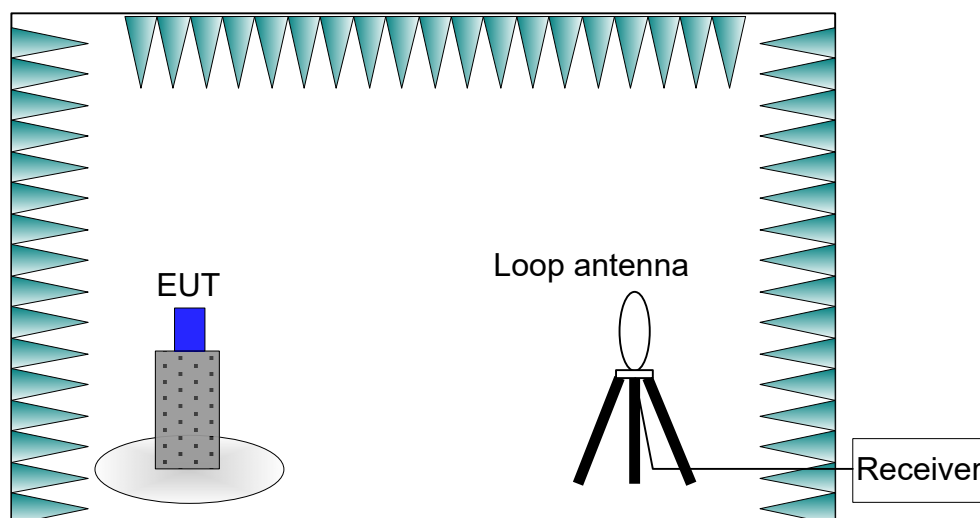

Figure B-1: Measurement Setup

B.1.3. EUT Operating Mode and Test Conditions

The measurement of EUT is carried out under the transmit state of NFC(See 3.4).

The EUT is powered by a travel adapter.

During the measurements, the ambient temperature of the electromagnetic anechoic chamber is in the range of 15 ~ 25 °C.

B.1.4. Limits

Table B-2: Limits

Frequency Range (MHz)	E-field Strength Limit @ 30 m (μV/m)	E-field Strength Limit @ 3 m (dBμV/m)
13.560 ± 0.007	+15,848	124
13.410 to 13.553 13.567 to 13.710	+334	90
13.110 to 13.410 13.710 to 14.010	+106	81

Note: Where the limits have been defined at one distance, and a signal level measured at another, the limits have been extrapolated using the following formula:

$$\text{Extrapolation(dB)} = 40\log_{10}(\text{Measurement Distance}/\text{Specification Distance})$$

B.1.5. Measurement Results

Measurement results of normal conditions see Figure B-2 for different set-ups of EUT. The results displayed take into account applicable antenna factors and cable losses.

We tested configurations of Set.2-1, Set.2-2, Set.2-3 and Set.2-4, only the worst cases were shown in test report.

Conclusions: Set.NFC2-1, **PASS**.

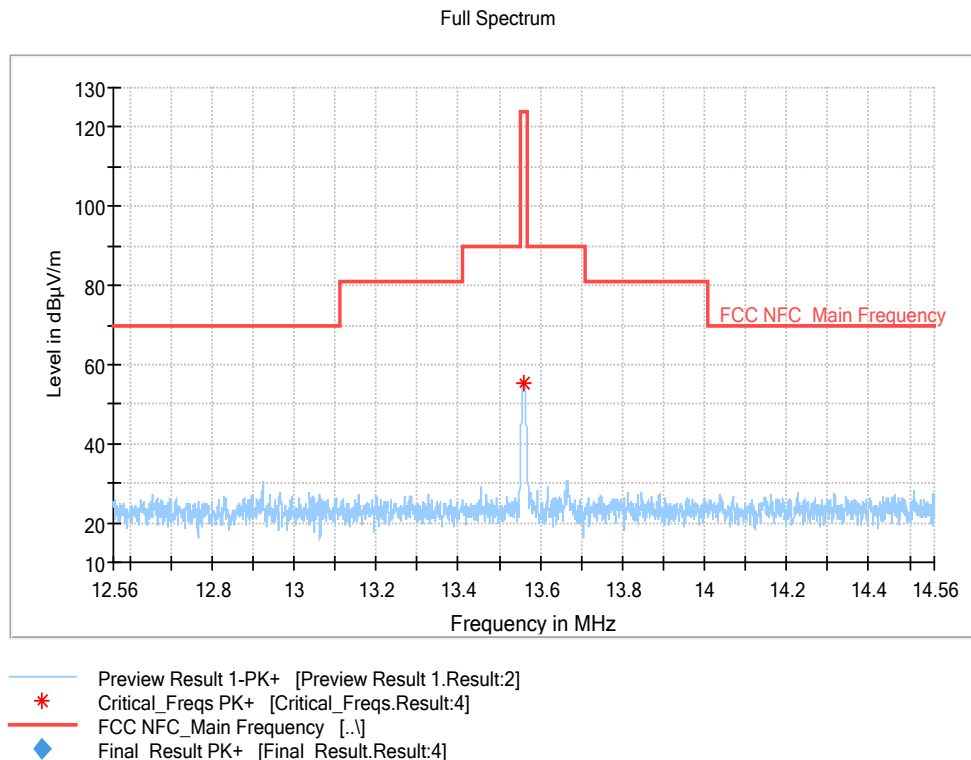

Figure B-2: Measurement results for Electric Field Strength of Fundamental and Outside the Allocated bands

Final_Result

Frequency(MHz)	MaxPeak(dBμV/m)	Limit(dBμV/m)	Margin(dB)	Pol	Azimuth(deg)	Corr.(dB/m)
13.559000	55.43	124.00	68.57	V	0.0	17.9

B.2. Electric Field Radiated Emissions (< 30MHz)

B.2.1. Reference

See Clause 6.4 of ANSI C63.10-2013 specifically.

See Clause 4 and Clause 5 of ANSI C63.10-2013 generally.

B.2.2. Measurement Methods

The transmitter carrier output levels (E-Field) from the EUT are measured in a semi-anechoic chamber. The EUT is placed on a non-conductive stand of 80cm high, and at a measurement distance of 3m from the receiving antenna. The center of the receiving loop antenna is 1.0 meter above the ground. The E-field is measured with a shielded loop antenna connected to a measurement receiver. Detected E-field was maximized by rotating the EUT through 360° and adjusting the receiving antenna polarizations. The maximization processes were repeated with the EUT positioned respectively in its three orthogonal axes. The measurements were performed with the peak detector and if required, the quasi-peak detector.

The measurement bandwidth is:

Frequency of Emission (MHz)	RBW/VBW
0.009-0.15	100/300 Hz
0.15-30	10/30 kHz

The E-field measured at 3m is calculated as:

$$\text{E-field (dB}\mu\text{V/m)} = \text{Rx (dB}\mu\text{V)} + \text{Cable Loss (dB)} + \text{AF@3m (dB/m)}$$

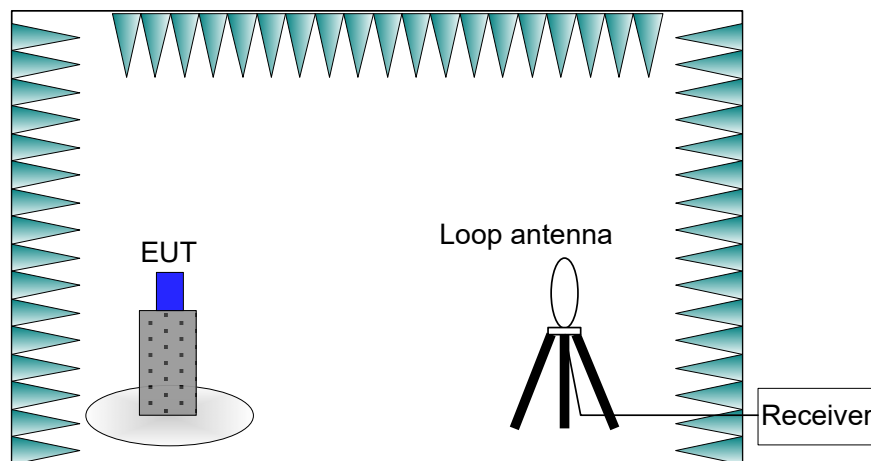

Figure B-3: Measurement Setup

B.2.3. EUT Operating Mode and Test Conditions

The measurement of EUT is carried out under the transmit state of NFC(See 3.4).

The EUT is powered by a travel adapter.

During the measurements, the ambient temperature of the electromagnetic anechoic chamber is in the range of 15 ~ 25 °C.

B.2.4. Limits

Frequency Range (MHz)	E-field Strength Limit @ 30m (mV/m)	E-field Strength Limit @ 3m (dBμV/m)
0.009-0.490	2400/F(kHz)	129-94
0.490-1.705	24000/F(kHz)	74-63
1.705-30	30	70

Note: Where the limits have been defined at one distance, and a signal level measured at another, the limits have been extrapolated using the following formula:

$$\text{Extrapolation(dB)} = 40\log_{10}(\text{Measurement Distance}/\text{Specification Distance})$$

B.2.5. Measurement Results

Measurement results of normal conditions see Figure B-4 for different set-ups of EUT. The results displayed take into account applicable antenna factors and cable losses.

We tested configurations of Set.2-1,Set.2-2,Set.2-3 and Set.2-4, only the worst cases were shown in test report.

Conclusions: Set.NFC1-4, **PASS**.

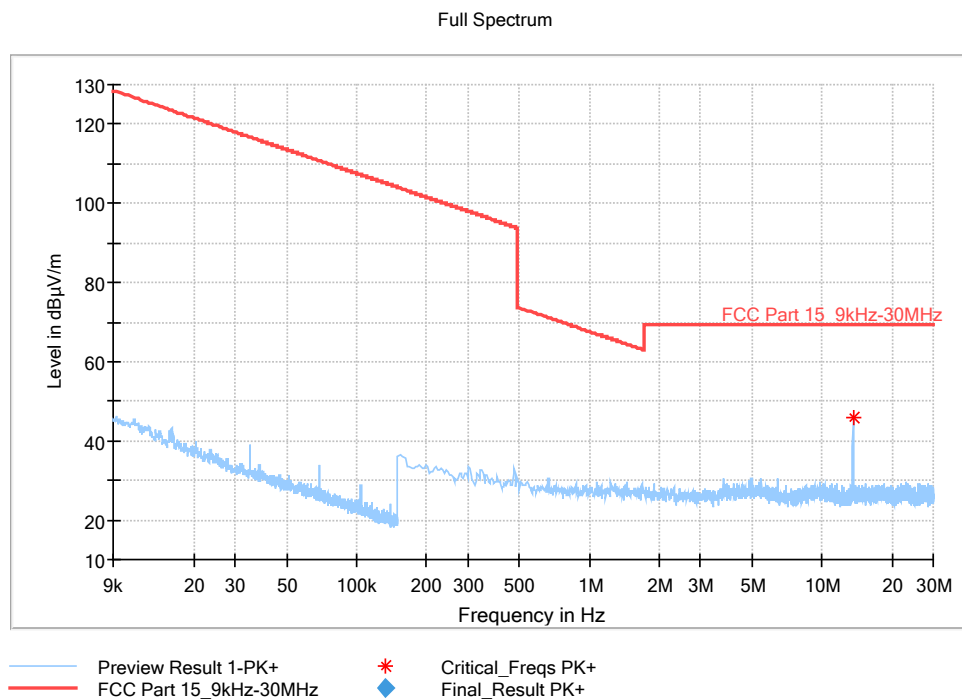

Figure B-4: Measurement results for Electric Field Radiated Emissions (< 30MHz)

Final_Result

Frequency (MHz)	MaxPeak (dB μ V/m)	Limit (dB μ V/m)	Margin (dB)	Pol	Azimuth (deg)	Corr. (dB/m)
13.560113	45.93	69.50	23.57	V	250.00	17.9

B.3. Electric Field Radiated Emissions (≥ 30 MHz)
B.3.1. Reference

See Clause 6.5 of ANSI C63.10-2013 specifically.

See Clause 4 and Clause 5 of ANSI C63.10-2013 generally.

B.3.2. Measurement Methods

The electric field radiated emissions from the EUT are measured in a semi-anechoic chamber. The EUT is placed on a non-conductive stand of 80cm high, and at a measurement distance of 10m from the receiving antenna. The receiving antennas connected to a measurement receiver. In order to search for maximum field strength emitted from the EUT, the receiving antenna can be moved between the height of 1.0 m to 4.0 m. Detected E-field was maximized at each frequency by rotating the EUT through 360° and adjusting the receiving antenna positions for both vertical and horizontal antenna polarizations. The maximization processes were repeated with the EUT positioned respectively in its three orthogonal axes. The measurements were performed with the peak detector and if required, the quasi-peak detector.

The measurement bandwidth is:

Frequency of Emission (MHz)	RBW/VBW
30-1000	120kHz

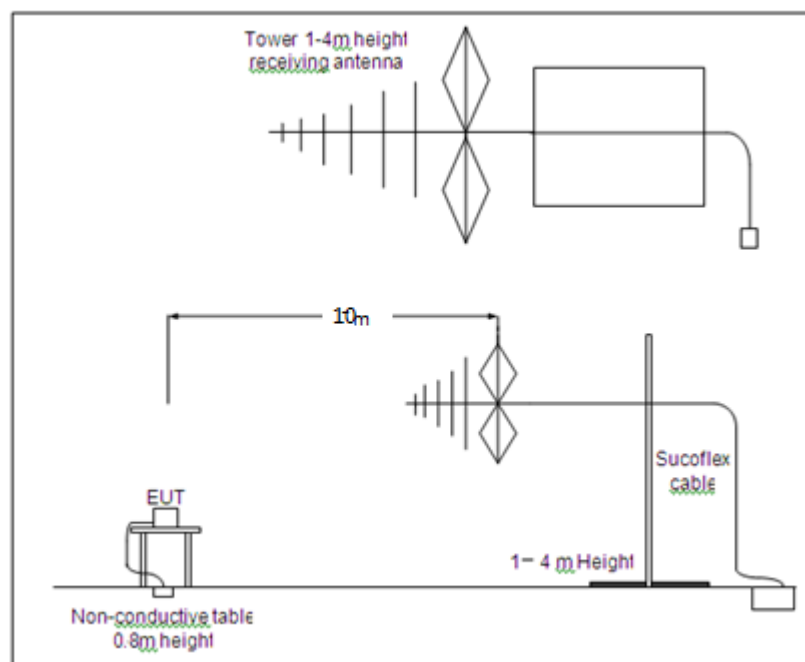

Figure B-5: Measurement Setup

B.3.3. EUT Operating Mode and Test Conditions

The measurement of EUT is carried out under the transmit state of NFC(See 3.4).

The EUT had been connected to a travel adapter.

During the measurements, the ambient temperature of the electromagnetic anechoic chamber is in the range of 15 ~ 25 °C.

B.3.4. Limits

Frequency Range (MHz)	E-field Strength Limit @ 3m (mV/m)	E-field Strength Limit @ 3m (dBµV/m)	E-field Strength Limit @ 10m (dBµV/m)
30-88	100	40	30
88-216	150	43.5	33.5
216-960	200	46	36
960-1000	500	54	44

B.3.5. Measurement Results

Measurement results of normal conditions see Figure B-6 for different set-ups of EUT. The results displayed take into account applicable antenna factors and cable losses.

We tested configurations of Set.1-1,Set.1-2,Set.1-3 and Set.1-4, only the worst cases were shown in test report.

Conclusions: Set.NFC1-3, **PASS**.

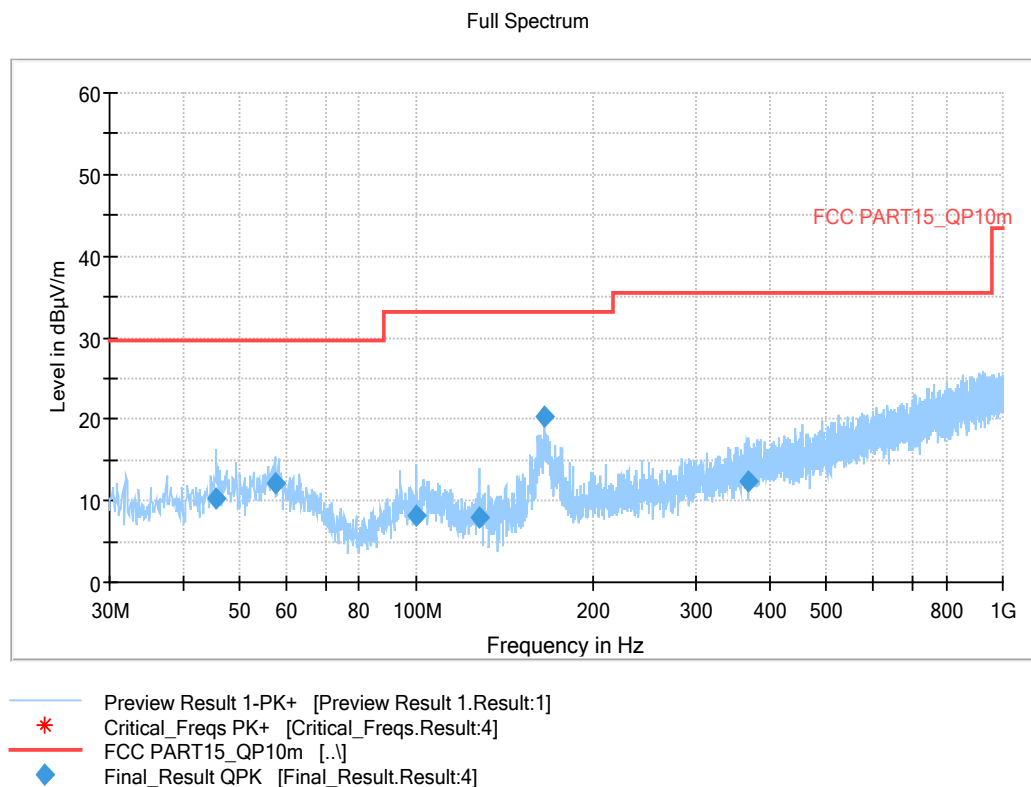

Figure B-6: Measurement results for Electric Field Radiated Emissions (≥30MHz)

Final_Result

Frequency (MHz)	QuasiPeak (dB μ V/m)	Limit (dB μ V/m)	Margin (dB)	Meas. Time (ms)	Bandwidth (kHz)	Height (cm)	Pol	Azimuth (deg)
45.617000	10.27	29.54	19.27	2000.0	120.000	325.0	V	256.0
57.451000	12.05	29.54	17.49	2000.0	120.000	186.0	V	71.0
99.937000	8.27	33.06	24.79	2000.0	120.000	325.0	V	71.0
128.164000	7.95	33.06	25.11	2000.0	120.000	225.0	V	72.0
165.800000	20.25	33.06	12.81	2000.0	120.000	325.0	V	201.0
369.597000	12.31	35.56	23.25	2000.0	120.000	125.0	H	136.0

B.4. Frequency Tolerance

B.4.1. Reference

See Clause 6.8 of ANSI C63.10-2013 specifically.

See Clause 4 and Clause 5 of ANSI C63.10-2013 generally.

B.4.2. Measurement Methods

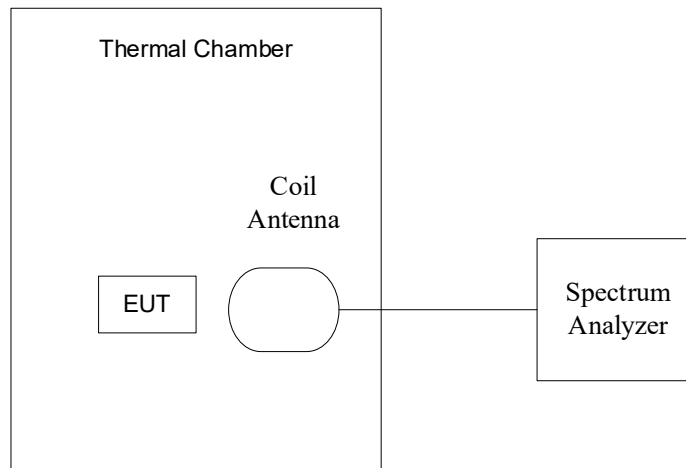

Figure B-7: Measurement Setup

The transmitter output signal was picked up by coil antenna connected to the spectrum analyzer. The center frequency was measured with 30Hz RBW and 1kHz span.

During the test, the EUT was placed in a thermal chamber until thermal balance and lasting appropriate time.

B.4.3. EUT Operating Mode and Test Conditions

The measurement of EUT was carried out under the transmit state of without modulation(See 3.4). EUT had not been connected to a travel adapter. The frequency stability was measured with the different voltage and temperature combinations:

- The nominal voltage 3.87V(See 3.1)was used and the temperature was varied from -20°C to +50°C in 10°C increments using an environmental chamber.
- The 20 °C was used and the voltages were 3.6V, 3.87V and 4.45V (The extreme low voltage ,the nominal voltage and the extreme high voltage defined in section 3.1).

The details were as following:

Table B-3: Combinations of Voltage and Temperature

Test items	Voltage	Temperature
Frequency stability with respect to ambient temperature	3.87V	-20°C
		-10°C
		0°C
		10°C
		20°C
		30°C
		40°C
		50°C
Frequency stability when varying supply voltage	3.6V	20°C
	3.87V	
	4.45V	

B.4.4. Test Layouts

See B.4.2.

B.4.5. Limits

The frequency tolerance of the carrier signal shall be maintained within +/- 0.01% of the operating frequency.

B.4.6. Measurement Results

Measurement results see Table B-4 for different test conditions.

Conclusions: Set.NFC4, **PASS.**

Table B-4: Measurement results for Frequency Tolerance

Temperature	Voltage	Frequency (MHz)			
		Startup	2 Min Later	5 Min Later	10 Min Later
-20°C	3.87V	13.560137500	13.560317500	13.560137500	13.560137500
-10°C	3.87V	13.560131250	13.560134375	13.560134375	13.560137500
0°C	3.87V	13.560093750	13.560103125	13.560109375	13.560112500
10°C	3.87V	13.560059375	13.560065625	13.560071875	13.560071875
20°C	3.87V	13.560046875	13.560040625	13.560034375	13.560031250
30°C	3.87V	13.560012500	13.559996875	13.559990625	13.559984375
40°C	3.87V	13.559968750	13.559956250	13.559946875	13.559943750
50°C	3.87V	13.559928125	13.559921875	13.559918750	13.559915625
20°C	3.6V	13.559987500	13.560006250	13.560015625	13.560025000
20°C	4.45V	13.560015625	13.560021875	13.560021875	13.560021875

Temperature	Voltage	Frequency Error (%)			
		Startup	2 Min Later	5 Min Later	10 Min Later
-20°C	3.87V	0.001	0.002	0.001	0.001

-10℃	3.87V	0.001	0.001	0.001	0.001
0℃	3.87V	0.001	0.001	0.001	0.001
10℃	3.87V	0.000	0.000	0.001	0.001
20℃	3.87V	0.000	0.000	0.000	0.000
30℃	3.87V	0.000	0.000	0.000	0.000
40℃	3.87V	0.000	0.000	0.000	0.000
50℃	3.87V	-0.001	-0.001	-0.001	-0.001
20℃	3.6V	0.000	0.000	0.000	0.000
20℃	4.45V	0.000	0.000	0.000	0.000

B.4.7. Measurement Uncertainty

Measurement uncertainty: $U = 77 \text{ Hz}$, $k=2$

B.5. 20dB Bandwidth

B.5.1. Reference

See Clause 6.9 of ANSI C63.10-2013 specifically.

See Clause 4 and Clause 5 of ANSI C63.10-2013 generally.

B.5.2. Measurement Methods

The transmitter output signal was picked up by coil antenna connected to the spectrum analyzer. The bandwidth of the center frequency was measured with 140Hz RBW, 420Hz VBW and 14kHz span.

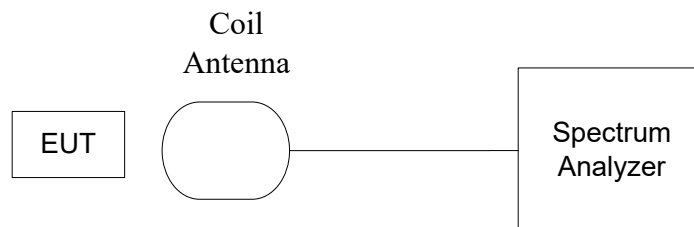

Figure B-8: Measurement Setup

B.5.3. EUT Operating Mode and Test Conditions

The measurement of EUT was carried out under the transmit state of NFC (See 3.4).

EUT had not been connected to a travel adapter.

During the measurements, the ambient temperature was in the range of 15 ~ 25 °C.

B.5.4. Test Layouts

See B.5.2.

B.5.5. Limits

The 20dB bandwidth shall be less than 80% of the permitted frequency band. For 13.56 MHz NFC, the permitted frequency band is 14kHz, so the limit is 11.2 kHz.

B.5.6. Measurement Results

Measurement results see Figure B-9.

Conclusions: Set.NFC4, **PASS.**

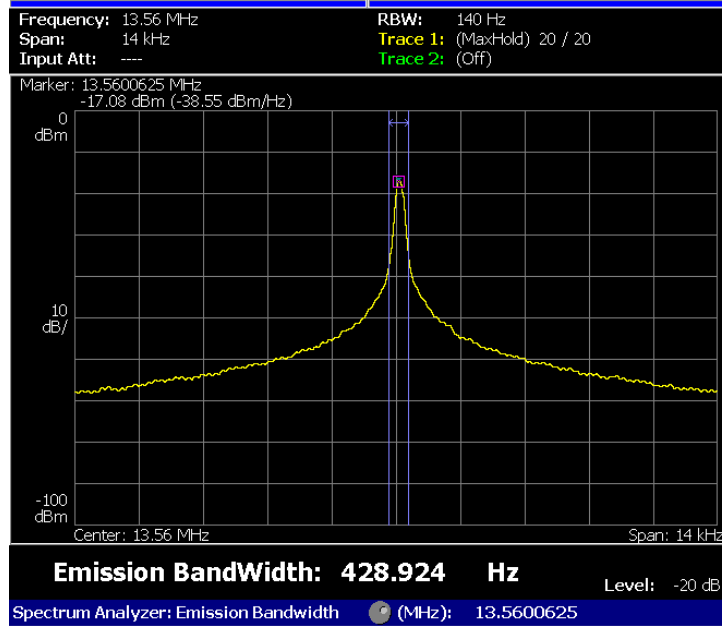

Figure B-9: Measurement results for 20dB Bandwidth

B.5.7. Measurement Uncertainty

Measurement uncertainty: $U = 77 \text{ Hz}$, $k=2$

B.6. Conducted emission

B.6.1. Reference

See Clause 6.2 of ANSI C63.10-2013 specifically.

See Clause 4 and Clause 5 of ANSI C63.10-2013 generally.

B.6.2. Measurement Methods

The conducted emissions from the AC port of the EUT are measured in a shielding room. The EUT is connected to a Line Impedance Stabilization Network (LISN). An overview sweep with peak detection was performed. The measurements were performed with a quasi-peak detector and if required, an average detector.

The conducted emission measurements were made with the following detector of the test receiver: Quasi-Peak / Average Detector.

The measurement bandwidth is:

Table B-5: Measurement Bandwidth

Frequency of Emission (MHz)	RBW/VBW
0.15-30	9kHz

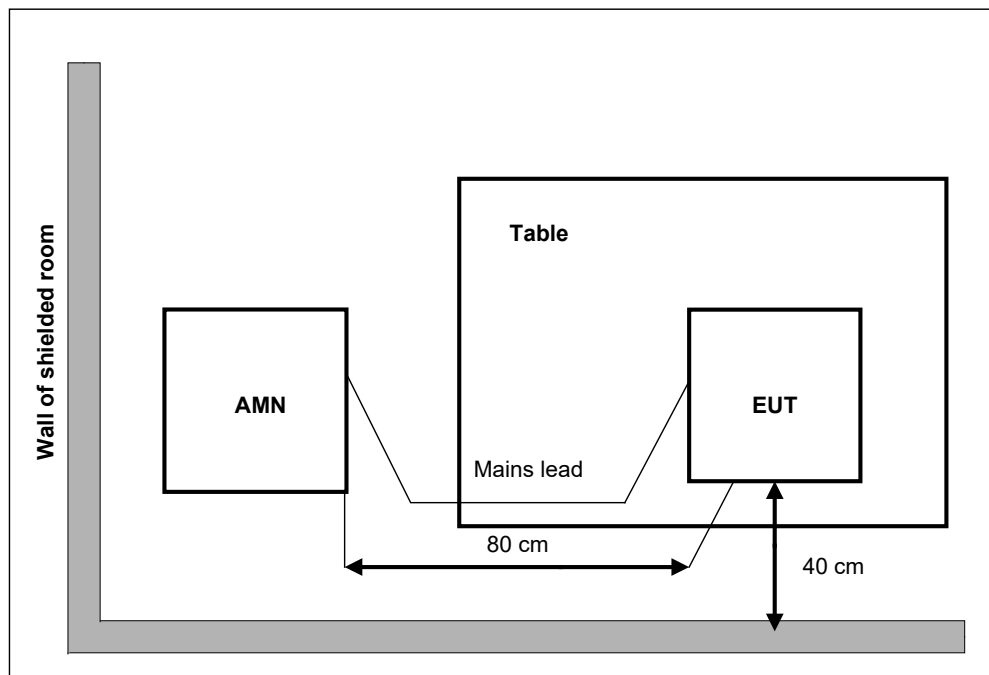

Figure B-10: Measurement Setup

B.6.3. EUT Operating Mode and Test Conditions

The measurement of EUT is carried out under the transmit state of NFC(See 3.4).

The EUT is powered by a travel adapter.

During the measurements, the ambient temperature is in the range of 15 ~ 25 °C.

B.6.4. Limits

Frequency range (MHz)	Quasi-peak Limit (dB μ V)	Average Limit (dB μ V)
0.15 to 0.5	66 to 56	56 to 46
0.5 to 5	56	46
5 to 30	60	50

B.6.5. Measurement Results

Measurement results see Figure B-11.

Conclusions: Set.NFC1-1, PASS.

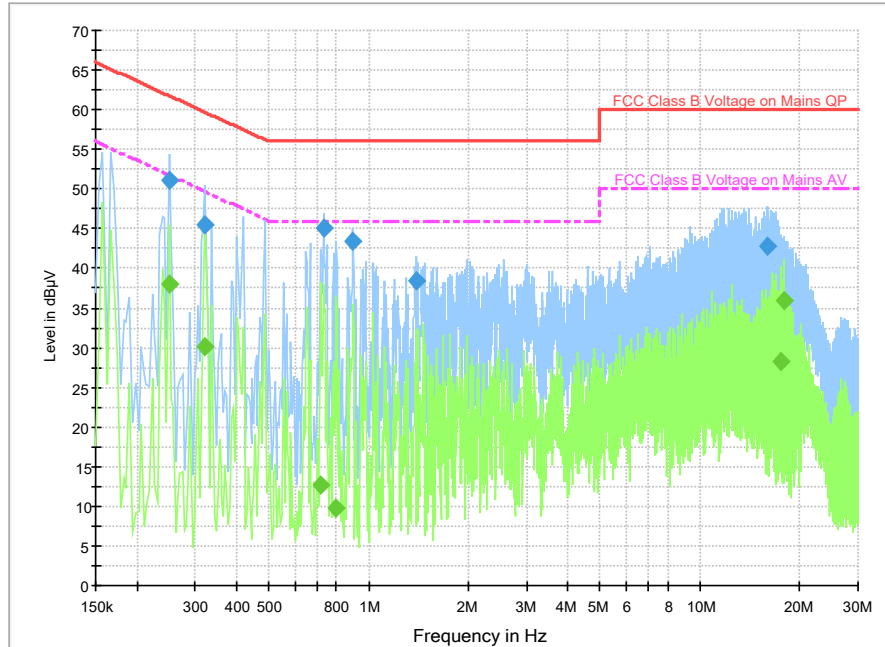

Figure B-11: Measurement results for Conducted Emission

Final Result 1

Frequency (MHz)	QuasiPeak (dBµV)	Meas. Time (ms)	Bandwidth (kHz)	Filter	Line	Corr. (dB)	Margin (dB)	Limit (dBµV)
0.250000	51.1	5000.0	9.000	On	N	19.7	10.7	61.8
0.322000	45.6	5000.0	9.000	On	L1	19.8	14.1	59.7
0.730000	45.0	5000.0	9.000	On	N	19.6	11.0	56.0
0.894000	43.4	5000.0	9.000	On	N	19.6	12.6	56.0
1.394000	38.5	5000.0	9.000	On	N	19.6	17.5	56.0
15.990000	42.8	5000.0	9.000	On	N	19.8	17.2	60.0



Final Result 2

Frequency (MHz)	CAverage (dBµV)	Meas. Time (ms)	Bandwidth (kHz)	Filter	Line	Corr. (dB)	Margin (dB)	Limit (dBµV)
0.250000	37.9	5000.0	9.000	On	N	19.7	13.8	51.8
0.322000	30.1	5000.0	9.000	On	L1	19.8	19.5	49.7
0.718000	12.6	5000.0	9.000	On	L1	19.6	33.4	46.0
0.798000	9.8	5000.0	9.000	On	L1	19.7	36.2	46.0
17.622000	28.3	5000.0	9.000	On	N	19.9	21.7	50.0
17.946000	36.0	5000.0	9.000	On	L1	19.7	14.0	50.0

ANNEX C: Persons involved in this testing

Test Item	Tester
20dB Bandwidth	Zhou Bin
Frequency Tolerance	Zhou Bin
Electric Field Strength of Fundamental and Outside the Allocated bands	Zhang Tianli
Electric Field Radiated Emissions (< 30MHz)	Zhang Tianli
Electric Field Radiated Emissions (≥ 30 MHz)	Zhang Tianli
Conducted Emissions	Pang Hai

ANNEX D: Accreditation Certificate

United States Department of Commerce National Institute of Standards and Technology	
 	
<hr/> Certificate of Accreditation to ISO/IEC 17025:2017 <hr/>	
NVLAP LAB CODE: 600118-0	
Telecommunication Technology Labs, CAICT Beijing China	
<i>is accredited by the National Voluntary Laboratory Accreditation Program for specific services, listed on the Scope of Accreditation, for:</i>	
Electromagnetic Compatibility & Telecommunications	
<i>This laboratory is accredited in accordance with the recognized International Standard ISO/IEC 17025:2017. This accreditation demonstrates technical competence for a defined scope and the operation of a laboratory quality management system (refer to joint ISO-ILAC-IAF Communique dated January 2009).</i>	
<hr/> 2021-09-29 through 2022-09-30 <i>Effective Dates</i>	 <hr/> <i>[Signature]</i> <i>For the National Voluntary Laboratory Accreditation Program</i>

*****END OF REPORT*****