



# RF TEST REPORT

**Applicant** Honor Device Co., Ltd.  
**FCC ID** 2AYGCTFY-LX2  
**Product** Smart Phone  
**Model** TFY-LX2  
**Report No.** R2201A0038-R3  
**Issue Date** February 11, 2022

TA Technology (Shanghai) Co., Ltd. tested the above equipment in accordance with the requirements in **FCC CFR47 Part 2 (2020)/ FCC CFR47 Part 27 (2020)**. The test results show that the equipment tested is capable of demonstrating compliance with the requirements as documented in this report.

Prepared by: Peng Tao

Approved by: Kai Xu

---

**TA Technology (Shanghai) Co., Ltd.**

No.145, Jintang Rd, Tangzhen Industry Park, Pudong Shanghai, China

TEL: +86-021-50791141/2/3

FAX: +86-021-50791141/2/3-8000



## TABLE OF CONTENT

<b>1</b>	<b>Test Laboratory</b>	4
1.1	Notes of the Test Report	4
<b>1.2.</b>	<b>Test facility</b>	4
1.3	Testing Location	4
<b>2</b>	<b>General Description of Equipment under Test</b>	5
2.1	Applicant and Manufacturer Information	5
2.2	General information	5
<b>3</b>	<b>Applied Standards</b>	7
<b>4</b>	<b>Test Configuration</b>	8
<b>5</b>	<b>Test Case Results</b>	9
5.1	RF Power Output and Effective Isotropic Radiated Power	9
5.2	Occupied Bandwidth	14
5.3	Band Edge Compliance	34
5.4	Peak-to-Average Power Ratio (PAPR)	47
5.5	Frequency Stability	50
5.6	Spurious Emissions at Antenna Terminals	54
5.7	Radiates Spurious Emission	60
<b>6</b>	<b>Main Test Instruments</b>	67
<b>ANNEX A: The EUT Appearance</b>		68
<b>ANNEX B: Test Setup Photos</b>		69
<b>ANNEX C: Product Change Description</b>		70



## Summary of Measurement Results

Number	Test Case	Clause in FCC rules	Verdict
1	RF Power Output and Effective Isotropic Radiated Power	2.1046 /27.50(h)(2)	PASS
2	Occupied Bandwidth	2.1049	PASS
3	Band Edge Compliance	/27.53(m)	PASS
4	Peak-to-Average Power Ratio	27.50(d)/KDB971168 D01(5.7)	PASS
5	Frequency Stability	2.1055 / 27.54	PASS
6	Spurious Emissions at Antenna Terminals	/27.53(m)	PASS
7	Radiates Spurious Emission	/27.53(m)	PASS

Date of Testing: January 13, 2022 ~ January 27, 2022

Date of Sample Received: January 10, 2022

Note: PASS: The EUT complies with the essential requirements in the standard.

FAIL: The EUT does not comply with the essential requirements in the standard.

All indications of Pass/Fail in this report are opinions expressed by TA Technology (Shanghai) Co., Ltd. based on interpretations and/or observations of test results. Measurement Uncertainties were not taken into account and are published for informational purposes only.

**TFY-LX2 (Report No.: R2201A0038-R3) is a variant model of TFY-LX3 (Report No.: R2201A0036-R3V1). Test values duplicated from Original for variant. There is only tested Radiates Spurious Emission(LTE Band 7), and did not worsen, so they were not recorded in the report.**

**The difference between model TFY-LX3 and model TFY-LX2 is show in the below table:**

	Model	TFY-LX3	TFY-LX2
Licensed Frequency	LTE BAND	B2/B4/B5/B7/B13/B26/B38/B66	B5/B7/B38/B41
	UMTS BAND	B2/B4/B5	B2/B5
	Antenna	The antenna matching and routing are the same. The frequency is different.	The antenna matching and routing are the same. The frequency is different.
RF	RF circuit	The RF circuit of the same frequency is the same.	The RF circuit of the same frequency is the same. the different frequency changed by hardware and some RF parameters. Changes are followed: delete B4/B13/B66 SAWS、Diplexer、switch and RF matching components.
Others		the same	the same

**The detailed product change description please refers to the *Difference Declaration Letter*.**



# 1 Test Laboratory

## 1.1 Notes of the Test Report

This report shall not be reproduced in full or partial, without the written approval of **TA technology (shanghai) co., Ltd.** The results documented in this report apply only to the tested sample, under the conditions and modes of operation as described herein .Measurement Uncertainties were not taken into account and are published for informational purposes only. This report is written to support regulatory compliance of the applicable standards stated above.

## 1.2. Test facility

### **FCC (Designation number: CN1179, Test Firm Registration Number: 446626)**

TA Technology (Shanghai) Co., Ltd. has been listed on the US Federal Communications Commission list of test facilities recognized to perform measurements.

### **A2LA (Certificate Number: 3857.01)**

TA Technology (Shanghai) Co., Ltd. has been listed by American Association for Laboratory Accreditation to perform measurement.

## 1.3 Testing Location

Company: TA Technology (Shanghai) Co., Ltd.  
Address: No.145, Jintang Rd, Tangzhen Industry Park, Pudong Shanghai, China  
City: Shanghai  
Post code: 201201  
Country: P. R. China  
Contact: Xu Kai  
Telephone: +86-021-50791141/2/3  
Fax: +86-021-50791141/2/3-8000  
Website: <http://www.ta-shanghai.com>  
E-mail: [xukai@ta-shanghai.com](mailto:xukai@ta-shanghai.com)

## 2 General Description of Equipment under Test

### 2.1 Applicant and Manufacturer Information

Applicant	Honor Device Co., Ltd.
Applicant address	Shum Yip Sky Park, No. 8089, Hongli West Road, Shenzhen, China
Manufacturer	Honor Device Co., Ltd.
Manufacturer address	Shum Yip Sky Park, No. 8089, Hongli West Road, Shenzhen, China

### 2.2 General information

EUT Description			
Model	TFY-LX2		
SN	A7NX011C22000163		
Hardware Version	HL6TFYM		
Software Version	4.2.0.35(C900E14R1P1)		
Power Supply	Battery / AC adapter		
Antenna Type	Internal Antenna		
Antenna Gain	Band	Main Antenna(dBi)	Second Antenna(dBi)
	LTE Band 7	0.18	0.52
	LTE Band 38	-0.56	0.21
Test Mode(s)	LTE Band 7/38;		
Test Modulation	(LTE)QPSK, 16QAM;		
LTE Category	4		
Maximum E.I.R.P./ E.R.P.	LTE Band 7:	22.87 dBm	
	LTE Band 38:	23.54 dBm	
Rated Power Supply Voltage	3.87V		
Operating Voltage	Minimum: 3.60V Maximum: 4.45V		
Operating Temperature	Lowest: 0°C Highest: 35°C		
Testing Temperature	Lowest: 0°C Highest: 35°C		
Operating Frequency Range(s)	Mode	Tx (MHz)	Rx (MHz)
	LTE Band 7	2500 ~ 2570	2620 ~ 2690
	LTE Band 38	2570 ~ 2620	2570 ~ 2620
EUT Accessory			
Accessory	Model	Manufacture	No.
Adapter	HW-100225E00	Honor Device Co., Ltd. (Manufacturer:Huntkey)	1
	HW-100225U00	Honor Device Co., Ltd. (Manufacturer:Huntkey)	2
	HW-100225B00	Honor Device Co., Ltd. (Manufacturer:Huntkey)	3
	HN-100225E00	Honor Device Co., Ltd. (Manufacturer: Salcomp)	4



	HN-100225U00	Honor Device Co., Ltd. (Manufacturer: Salcomp)	5
Battery	HB416492EFW	Honor Device Co., Ltd. (Manufacturer: Sunwoda Electronic Co.,LTD)	1
	HB416492EFW	Honor Device Co., Ltd. (Manufacturer:NVT)	2
Earphone	MEND1532B528A11	Jiangxi Lianchuang Hongsheng Electronic Co., LTD.	1
	1293-3283-3.5mm-339	BOLUO COUNTY QUANCHENG ELECTRONIC CO.,LTD.	2
	EPAB542-2WH05-DH	FOXCONN INTERCONNECT TECHNOLOGY LIMITED	3
USB Cable	RY0002	NingBo Broad Telecommunication Co., Ltd.	1
	AU2-CRO013HF	Freeport Resources Enterprises Corp.	2
	2120-00001-0	MING JI ELECTRONICS CO., LTD.	3
	L125UC007-CS-H	LUXSHARE PRECISION INDUSTRY CO., LTD.	4
	CUDU01B-HC451-EH	FOXCONN INTERCONNECT TECHNOLOGY LIMITED	5

Note: 1. The EUT is sent from the applicant to TA and the information of the EUT is declared by the applicant.

2. There are more than one Adapter, Battery, Earphone and USB Cable, each one should be applied throughout the compliance test respectively, however, only the worst case (Adapter 1, Battery 2, Earphone 1 and USB Cable 3) will be recorded in this report.



### 3 Applied Standards

According to the specifications of the manufacturer, it must comply with the requirements of the following standards:

**Test standards:**

**FCC CFR47 Part 27 (2020)**

**FCC CFR47 Part 2 (2020)**

**Reference standard:**

**ANSI C63.26 (2015)**

**KDB 971168 D01 Power Meas License Digital Systems v03r01**



### 4 Test Configuration

Radiated measurements are performed by rotating the EUT in three different orthogonal test planes. EUT stand-up position (Z axis), lie-down position (X, Y axis). Receiver antenna polarization (horizontal and vertical), the worst emission was found in position Z axis, horizontal polarization for LTE Band (Main Antenna); Z axis, vertical polarization for LTE Band (Second Antenna) and the worst case was recorded.

All mode and data rates and positions and RB size and modulations were investigated.

Subsequently, only the worst case emissions are reported.

The following testing in LTE is set based on the maximum RF Output Power.

The following testing in different Bandwidth is set to detail in the following table:

Test modes are chosen to be reported as the worst case configuration below:

Test modes are chosen to be reported as the worst case configuration below for LTE Band 7/38:

Test items	Modes	Bandwidth (MHz)						Modulation		RB			Test Channel		
		1.4	3	5	10	15	20	QPSK	16QAM	1	50%	100%	L	M	H
RF Power Output and Effective Isotropic Radiated Power	LTE 7	-	-	O	O	O	O	O	O	O	O	O	O	O	O
	LTE 38	-	-	O	O	O	O	O	O	O	O	O	O	O	O
Occupied Bandwidth	LTE 7	-	-	O	O	O	O	O	O	-	-	O	O	O	O
	LTE 38	-	-	O	O	O	O	O	O	-	-	O	O	O	O
Band Edge Compliance	LTE 7	-	-	O	O	O	O	O	O	O	-	O	O	-	O
	LTE 38	-	-	O	O	O	O	O	O	O	-	O	O	-	O
Peak-to-Average Power Ratio	LTE 7	-	-	O	O	O	O	O	O	-	-	O	O	O	O
	LTE 38	-	-	O	O	O	O	O	O	-	-	O	O	O	O
Frequency Stability	LTE 7	-	-	O	O	O	O	O	O	O	-	-	-	O	-
	LTE 38	-	-	O	O	O	O	O	O	O	-	-	-	O	-
Spurious Emissions at Antenna Terminals	LTE 7	-	-	O	O	O	O	O	-	O	-	-	O	O	O
	LTE 38	-	-	O	O	O	O	O	-	O	-	-	O	O	O
Radiates Spurious Emission	LTE 7	-	-	O	-	-	O	O	-	O	-	-	-	O	-
	LTE 38	-	-	O	-	-	O	O	-	O	-	-	-	O	-
Note	1. The mark "O" means that this configuration is chosen for testing. 2. The mark "-" means that this configuration is not testing.														



## 5 Test Case Results

### 5.1 RF Power Output and Effective Isotropic Radiated Power

#### Ambient condition

Temperature	Relative humidity	Pressure
23°C ~25°C	45%~50%	101.5kPa

#### Methods of Measurement

During the process of the testing, The EUT was connected to the Base Station Simulator with a known loss. The EUT is controlled by the Base Station Simulator test set to ensure max power transmission with proper modulation.

ERP can then be calculated as follows:

$$\text{EIRP (dBm)} = \text{Output Power (dBm)} - \text{Losses (dB)} + \text{Antenna Gain (dBi)}$$

where:dBd refers to gain relative to an ideal dipole.

$$\text{EIRP (dBm)} = \text{ERP (dBm)} + 2.15 \text{ (dB.)}$$

#### Test Setup

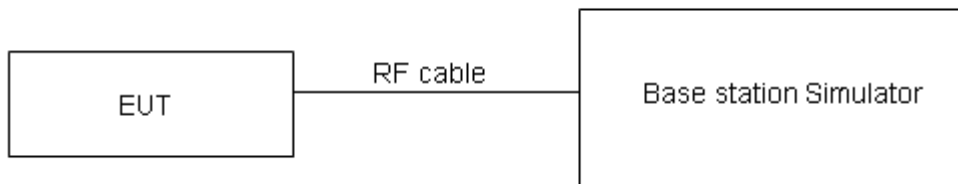

#### Limits

No specific RF power output requirements in part 2.1046.

Rule Part 27.50(h) (2) specifies that “Mobile and other user stations. Mobile stations are limited to 2.0 watts EIRP. All user stations are limited to 2.0 watts transmitter output power.”

Part 27.50(h)(2) Limit	$\leq 2 \text{ W (33 dBm)}$
------------------------	-----------------------------

#### Measurement Uncertainty

The assessed measurement uncertainty to ensure 95% confidence level for the normal distribution is with the coverage factor  $k = 2$ ,  $U=0.4 \text{ dB}$  for RF power output,  $k = 2$ ,  $U= 1.19 \text{ dB}$  for ERP/EIRP.



## Test Results

LTE Band 7				Maximum Output Power(dBm)			Main Antenna EIRP (dBm)			Second Antenna EIRP (dBm)		
BW	Modulation	RB size	RB offset	Channel/Frequency(MHz)								
				20775/ 2502.5	21100/ 2535	21425/ 2567.5	20775/ 2502.5	21100/ 2535	21425/ 2567.5	20775/ 2502.5	21100/ 2535	21425/ 2567.5
5MHz	QPSK	1	0	22.17	22.12	21.95	22.35	22.30	22.13	22.69	22.64	22.47
		1	13	22.32	22.15	22.09	22.50	22.33	22.27	22.84	22.67	22.61
		1	24	22.17	21.96	22.01	22.35	22.14	22.19	22.69	22.48	22.53
		12	0	21.36	21.40	21.53	21.54	21.58	21.71	21.88	21.92	22.05
		12	6	21.75	21.59	21.53	21.93	21.77	21.71	22.27	22.11	22.05
		12	13	21.99	21.54	21.49	22.17	21.72	21.67	22.51	22.06	22.01
		25	0	21.71	21.90	21.55	21.89	22.08	21.73	22.23	22.42	22.07
	16QAM	1	0	22.03	21.77	21.61	22.21	21.95	21.79	22.55	22.29	22.13
		1	13	22.01	22.04	21.76	22.19	22.22	21.94	22.53	22.56	22.28
		1	24	21.75	22.03	21.40	21.93	22.21	21.58	22.27	22.55	21.92
		12	0	20.84	20.89	20.86	21.02	21.07	21.04	21.36	21.41	21.38
		12	6	20.56	20.73	20.57	20.74	20.91	20.75	21.08	21.25	21.09
		12	13	20.79	20.99	20.70	20.97	21.17	20.88	21.31	21.51	21.22
		25	0	20.66	20.70	20.70	20.84	20.88	20.88	21.18	21.22	21.22
BW	Modulation	RB size	RB offset	Channel/Frequency(MHz)								
				20800/ 2505	21100/ 2535	21400/ 2565	20800/ 2505	21100/ 2535	21400/ 2565	20800/ 2505	21100/ 2535	21400/ 2565
10MHz	QPSK	1	0	22.19	22.13	21.98	22.37	22.31	22.16	22.71	22.65	22.50
		1	25	22.35	22.20	22.13	22.53	22.38	22.31	22.87	22.72	22.65
		1	49	22.19	22.00	22.04	22.37	22.18	22.22	22.71	22.52	22.56
		25	0	21.39	21.45	21.57	21.57	21.63	21.75	21.91	21.97	22.09
		25	13	21.78	21.64	21.57	21.96	21.82	21.75	22.30	22.16	22.09
		25	25	22.01	21.58	21.54	22.19	21.76	21.72	22.53	22.10	22.06
		50	0	21.75	21.92	21.59	21.93	22.10	21.77	22.27	22.44	22.11
	16QAM	1	0	22.05	21.80	21.63	22.23	21.98	21.81	22.57	22.32	22.15
		1	25	22.04	22.08	21.79	22.22	22.26	21.97	22.56	22.60	22.31
		1	49	21.78	22.05	21.43	21.96	22.23	21.61	22.30	22.57	21.95
		25	0	20.87	20.94	20.90	21.05	21.12	21.08	21.39	21.46	21.42
		25	13	20.58	20.77	20.60	20.76	20.95	20.78	21.10	21.29	21.12
		25	25	20.82	21.04	20.74	21.00	21.22	20.92	21.34	21.56	21.26
		50	0	20.69	20.75	20.74	20.87	20.93	20.92	21.21	21.27	21.26



BW	Modulation	RB size	RB offset	Channel/Frequency(MHz)								
				20825/ 2507.5	21100/ 2535	21375/ 2562.5	20825/ 2507.5	21100/ 2535	21375/ 2562.5	20825/ 2507.5	21100/ 2535	21375/ 2562.5
15MHz	QPSK	1	0	22.19	22.09	21.96	22.37	22.27	22.14	22.71	22.61	22.48
		1	38	22.33	22.19	22.10	22.51	22.37	22.28	22.85	22.71	22.62
		1	74	22.16	21.95	22.00	22.34	22.13	22.18	22.68	22.47	22.52
		36	0	21.37	21.41	21.54	21.55	21.59	21.72	21.89	21.93	22.06
		36	18	21.75	21.59	21.53	21.93	21.77	21.71	22.27	22.11	22.05
		36	39	21.98	21.55	21.50	22.16	21.73	21.68	22.50	22.07	22.02
		75	0	21.73	21.88	21.54	21.91	22.06	21.72	22.25	22.40	22.06
	16QAM	1	0	22.00	21.78	21.61	22.18	21.96	21.79	22.52	22.30	22.13
		1	38	22.02	22.05	21.77	22.20	22.23	21.95	22.54	22.57	22.29
		1	74	21.75	22.01	21.40	21.93	22.19	21.58	22.27	22.53	21.92
		36	0	20.84	20.92	20.87	21.02	21.10	21.05	21.36	21.44	21.39
		36	18	20.55	20.72	20.56	20.73	20.90	20.74	21.07	21.24	21.08
		36	39	20.80	21.00	20.71	20.98	21.18	20.89	21.32	21.52	21.23
		75	0	20.66	20.70	20.70	20.84	20.88	20.88	21.18	21.22	21.22
BW	Modulation	RB size	RB offset	Channel/Frequency(MHz)								
				20850/ 2510	21100/ 2535	21350/ 2560	20850/ 2510	21100/ 2535	21350/ 2560	20850/ 2510	21100/ 2535	21350/ 2560
20MHz	QPSK	1	0	22.15	22.05	21.93	22.33	22.23	22.11	22.67	22.57	22.45
		1	50	22.32	22.15	22.08	22.50	22.33	22.26	22.84	22.67	22.60
		1	99	22.14	21.94	21.97	22.32	22.12	22.15	22.66	22.46	22.49
		50	0	21.34	21.36	21.50	21.52	21.54	21.68	21.86	21.88	22.02
		50	25	21.73	21.55	21.50	21.91	21.73	21.68	22.25	22.07	22.02
		50	50	21.95	21.50	21.46	22.13	21.68	21.64	22.47	22.02	21.98
		100	0	21.70	21.83	21.50	21.88	22.01	21.68	22.22	22.35	22.02
	16QAM	1	0	21.91	21.74	21.56	22.09	21.92	21.74	22.43	22.26	22.08
		1	50	21.98	22.03	21.73	22.16	22.21	21.91	22.50	22.55	22.25
		1	99	21.73	21.98	21.38	21.91	22.16	21.56	22.25	22.50	21.90
		50	0	20.81	20.88	20.84	20.99	21.06	21.02	21.33	21.40	21.36
		50	25	20.52	20.70	20.53	20.70	20.88	20.71	21.04	21.22	21.05
		50	50	20.77	20.95	20.67	20.95	21.13	20.85	21.29	21.47	21.19
		100	0	20.64	20.66	20.67	20.82	20.84	20.85	21.16	21.18	21.19



LTE Band 38				Maximum Output Power(dBm)			Main Antenna EIRP (dBm)			Second Antenna EIRP (dBm)		
BW	Modulation	RB size	RB offset	Channel/Frequency(MHz)								
				37775/2572.5	38000/2595	38225/2617.5	37775/2572.5	38000/2595	38225/2617.5	37775/2572.5	38000/2595	38225/2617.5
5MHz	QPSK	1	0	23.21	23.08	23.08	22.65	22.52	22.52	23.42	23.29	23.29
		1	13	23.30	23.01	23.28	22.74	22.45	22.72	23.51	23.22	23.49
		1	24	23.05	22.98	23.08	22.49	22.42	22.52	23.26	23.19	23.29
		12	0	22.35	22.13	22.17	21.79	21.57	21.61	22.56	22.34	22.38
		12	6	22.29	22.15	22.24	21.73	21.59	21.68	22.50	22.36	22.45
		12	13	22.27	22.10	22.12	21.71	21.54	21.56	22.48	22.31	22.33
		25	0	22.25	22.15	22.13	21.69	21.59	21.57	22.46	22.36	22.34
	16QAM	1	0	22.50	22.35	22.28	21.94	21.79	21.72	22.71	22.56	22.49
		1	13	22.48	22.38	22.41	21.92	21.82	21.85	22.69	22.59	22.62
		1	24	22.29	22.07	22.20	21.73	21.51	21.64	22.50	22.28	22.41
		12	0	21.37	21.19	21.20	20.81	20.63	20.64	21.58	21.40	21.41
		12	6	21.41	21.21	21.28	20.85	20.65	20.72	21.62	21.42	21.49
		12	13	21.26	21.16	21.18	20.70	20.60	20.62	21.47	21.37	21.39
		25	0	21.33	21.18	21.15	20.77	20.62	20.59	21.54	21.39	21.36
10MHz	QPSK	1	0	23.23	23.09	23.11	22.67	22.53	22.55	23.44	23.30	23.32
		1	25	23.33	23.06	23.32	22.77	22.50	22.76	23.54	23.27	23.53
		1	49	23.07	23.02	23.11	22.51	22.46	22.55	23.28	23.23	23.32
		25	0	22.38	22.18	22.21	21.82	21.62	21.65	22.59	22.39	22.42
		25	13	22.32	22.20	22.28	21.76	21.64	21.72	22.53	22.41	22.49
		25	25	22.29	22.14	22.17	21.73	21.58	21.61	22.50	22.35	22.38
		50	0	22.29	22.17	22.17	21.73	21.61	21.61	22.50	22.38	22.38
	16QAM	1	0	22.52	22.38	22.30	21.96	21.82	21.74	22.73	22.59	22.51
		1	25	22.51	22.42	22.44	21.95	21.86	21.88	22.72	22.63	22.65
		1	49	22.32	22.09	22.23	21.76	21.53	21.67	22.53	22.30	22.44
		25	0	21.40	21.24	21.24	20.84	20.68	20.68	21.61	21.45	21.45
		25	13	21.43	21.25	21.31	20.87	20.69	20.75	21.64	21.46	21.52
		25	25	21.29	21.21	21.22	20.73	20.65	20.66	21.50	21.42	21.43
		50	0	21.36	21.23	21.19	20.80	20.67	20.63	21.57	21.44	21.40



BW	Modulation	RB size	RB offset	Channel/Frequency(MHz)								
				37825/ 2577.5	38000/ 2595	38175/ 2612.5	37825/ 2577.5	38000/ 2595	38175/ 2612.5	37825/ 2577.5	38000/ 2595	38175/ 2612.5
15MHz	QPSK	1	0	23.22	23.05	23.09	22.66	22.49	22.53	23.43	23.26	23.30
		1	38	23.31	23.05	23.29	22.75	22.49	22.73	23.52	23.26	23.50
		1	74	23.04	22.97	23.07	22.48	22.41	22.51	23.25	23.18	23.28
		36	0	22.36	22.14	22.18	21.80	21.58	21.62	22.57	22.35	22.39
		36	18	22.29	22.15	22.24	21.73	21.59	21.68	22.50	22.36	22.45
		36	39	22.26	22.11	22.13	21.70	21.55	21.57	22.47	22.32	22.34
		75	0	22.27	22.13	22.12	21.71	21.57	21.56	22.48	22.34	22.33
	16QAM	1	0	22.47	22.36	22.28	21.91	21.80	21.72	22.68	22.57	22.49
		1	38	22.49	22.39	22.42	21.93	21.83	21.86	22.70	22.60	22.63
		1	74	22.29	22.05	22.20	21.73	21.49	21.64	22.50	22.26	22.41
		36	0	21.37	21.22	21.21	20.81	20.66	20.65	21.58	21.43	21.42
		36	18	21.40	21.20	21.27	20.84	20.64	20.71	21.61	21.41	21.48
		36	39	21.27	21.17	21.19	20.71	20.61	20.63	21.48	21.38	21.40
		75	0	21.33	21.18	21.15	20.77	20.62	20.59	21.54	21.39	21.36
BW	Modulation	RB size	RB offset	Channel/Frequency(MHz)								
				37850/ 2580	38000/ 2595	38150/ 2610	37850/ 2580	38000/ 2595	38150/ 2610	37850/ 2580	38000/ 2595	38150/ 2610
20MHz	QPSK	1	0	23.19	23.01	23.06	22.63	22.45	22.50	23.40	23.22	23.27
		1	50	23.30	23.01	23.27	22.74	22.45	22.71	23.51	23.22	23.48
		1	99	23.02	22.96	23.04	22.46	22.40	22.48	23.23	23.17	23.25
		50	0	22.33	22.09	22.14	21.77	21.53	21.58	22.54	22.30	22.35
		50	25	22.27	22.11	22.21	21.71	21.55	21.65	22.48	22.32	22.42
		50	50	22.23	22.06	22.09	21.67	21.50	21.53	22.44	22.27	22.30
		100	0	22.24	22.08	22.08	21.68	21.52	21.52	22.45	22.29	22.29
	16QAM	1	0	22.41	22.32	22.23	21.85	21.76	21.67	22.62	22.53	22.44
		1	50	22.45	22.37	22.38	21.89	21.81	21.82	22.66	22.58	22.59
		1	99	22.27	22.02	22.18	21.71	21.46	21.62	22.48	22.23	22.39
		50	0	21.34	21.18	21.18	20.78	20.62	20.62	21.55	21.39	21.39
		50	25	21.37	21.18	21.24	20.81	20.62	20.68	21.58	21.39	21.45
		50	50	21.24	21.12	21.15	20.68	20.56	20.59	21.45	21.33	21.36
		100	0	21.31	21.14	21.12	20.75	20.58	20.56	21.52	21.35	21.33

## 5.2 Occupied Bandwidth

### Ambient condition

Temperature	Relative humidity	Pressure
23°C ~25°C	45%~50%	101.5kPa

### Method of Measurement

The EUT was connected to Spectrum Analyzer and Base Station Simulator via power Splitter. The occupied bandwidth is measured using spectrum analyzer.

RBW is set to  $\geq 1\%EBW$ , VBW is set to 3x RBW.

99% power and -26dBc occupied bandwidths are recorded. Spectrum analyzer plots are included on the following pages.

### Test Setup

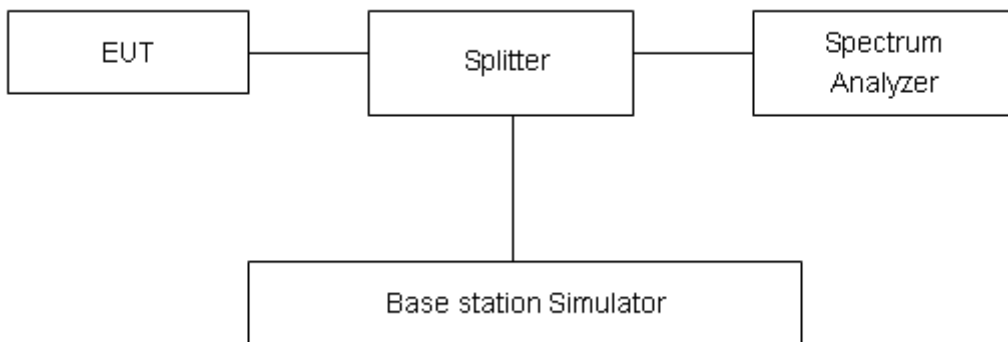

### Limits

No specific occupied bandwidth requirements in part 2.1049.

### Measurement Uncertainty

The assessed measurement uncertainty to ensure 95% confidence level for the normal distribution is with the coverage factor  $k = 2$ ,  $U=624\text{Hz}$ .



## Test Result

LTE Band 7						
RB	Modulation	Bandwidth (MHz)	Channel	Frequency (MHz)	99% Power Bandwidth(MHz)	-26dBc Bandwidth(MHz)
1	QPSK	5	20775	2502.5	0.485	0.715
			21100	2535	0.477	0.668
			21425	2567.5	0.482	0.669
		10	20800	2505	0.730	0.953
			21100	2535	0.697	0.990
			21400	2565	0.705	1.021
		15	20825	2507.5	1.073	1.427
			21100	2535	1.083	1.474
			21375	2562.5	1.011	1.478
		20	20850	2510	1.410	1.897
			21100	2535	1.346	1.812
			21350	2560	1.358	1.730
	16QAM	5	20775	2502.5	0.462	0.678
			21100	2535	0.446	0.640
			21425	2567.5	0.478	0.648
		10	20800	2505	0.688	0.938
			21100	2535	0.729	0.975
			21400	2565	0.648	0.970
		15	20825	2507.5	1.048	1.402
			21100	2535	1.045	1.401
			21375	2562.5	0.999	1.404
		20	20850	2510	1.413	1.897
			21100	2535	1.351	1.799
			21350	2560	1.324	1.960
100%	QPSK	5	20775	2502.5	4.517	4.927
			21100	2535	4.523	4.971
			21425	2567.5	4.528	4.962
		10	20800	2505	8.994	9.857
			21100	2535	8.992	9.946
			21400	2565	8.992	9.775
		15	20825	2507.5	13.527	14.749
			21100	2535	13.448	14.662
			21375	2562.5	13.477	14.581
		20	20850	2510	17.957	19.452
			21100	2535	18.013	19.399



16QAM	5	21350	2560	17.894	19.371
		20775	2502.5	4.531	4.990
		21100	2535	4.501	4.988
	10	21425	2567.5	4.521	4.953
		20800	2505	9.001	9.724
		21100	2535	8.975	9.740
	15	21400	2565	8.957	9.814
		20825	2507.5	13.505	14.667
		21100	2535	13.489	14.613
	20	21375	2562.5	13.477	14.477
		20850	2510	17.945	19.251
		21100	2535	18.007	19.426
			21350	2560	17.926

LTE Band 38						
RB	Modulation	Bandwidth (MHz)	Channel	Frequency (MHz)	99% Power Bandwidth(MHz)	-26dBc Bandwidth(MHz)
1	QPSK	5	37775	2572.5	0.484	0.695
			38000	2595	0.501	0.772
			38225	2617.5	0.478	0.805
		10	37800	2575	0.669	1.007
			38000	2595	0.627	0.958
			38200	2615	0.702	1.006
		15	37825	2577.5	1.059	1.462
			38000	2595	1.031	1.361
			38175	2612.5	0.985	1.437
	20	37850	2580	1.399	2.384	
		38000	2595	1.361	2.011	
		38150	2610	1.319	2.012	
	16QAM	5	37775	2572.5	0.452	0.664
			38000	2595	0.504	0.744
			38225	2617.5	0.454	0.650
		10	37800	2575	0.594	0.822
			38000	2595	0.612	0.969
			38200	2615	0.670	0.964
15		37825	2577.5	0.991	1.797	
		38000	2595	0.988	1.310	
		38175	2612.5	0.946	1.542	
20	37850	2580	1.350	3.088		
	38000	2595	1.209	2.071		





100%	QPSK	5	38150	2610	1.235	1.816		
			37775	2572.5	4.512	5.232		
			38000	2595	4.513	4.941		
					38225	2617.5	4.503	4.946
		10	37800	2575	8.993	9.719		
			38000	2595	9.004	9.769		
			38200	2615	8.983	9.655		
		15	37825	2577.5	13.467	14.435		
			38000	2595	13.445	14.485		
			38175	2612.5	13.438	14.401		
		20	37850	2580	17.930	19.194		
			38000	2595	18.015	19.094		
	38150		2610	17.925	19.322			
	16QAM	5	37775	2572.5	4.499	4.892		
			38000	2595	4.498	4.979		
			38225	2617.5	4.506	4.959		
		10	37800	2575	9.017	9.736		
			38000	2595	8.961	9.786		
			38200	2615	8.993	9.618		
		15	37825	2577.5	13.433	14.664		
			38000	2595	13.464	14.502		
			38175	2612.5	13.477	14.501		
		20	37850	2580	17.925	19.293		
			38000	2595	17.970	19.500		
38150			2610	18.013	19.205			



1 RB

LTE Band 7 QPSK 5MHz CH-Low



LTE Band 7 QPSK 10MHz CH-Low

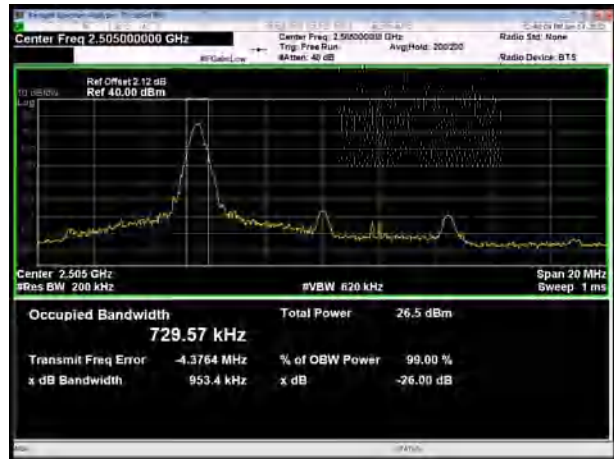

LTE Band 7 QPSK 5MHz CH-Middle

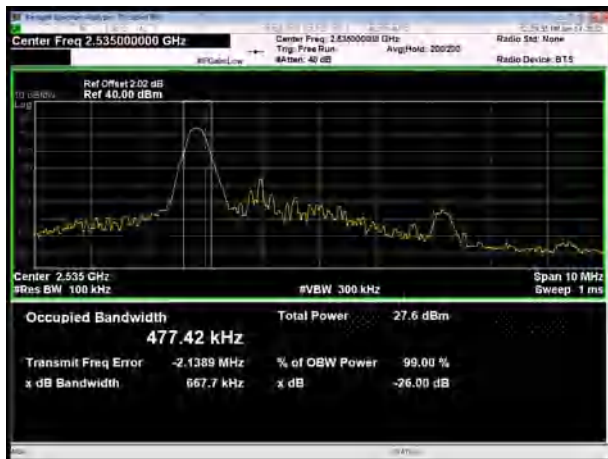

LTE Band 7 QPSK 10MHz CH-Middle

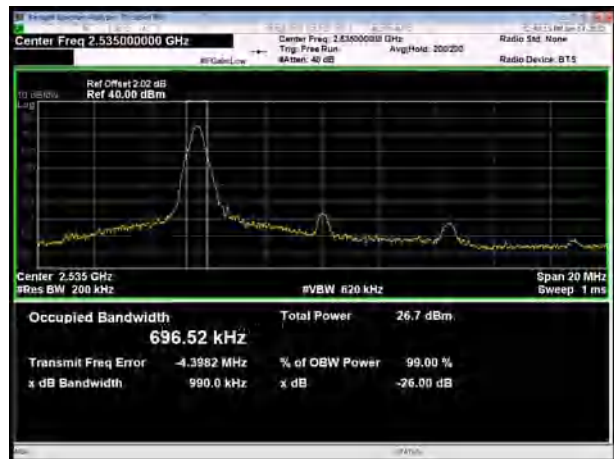

LTE Band 7 QPSK 5MHz CH-High

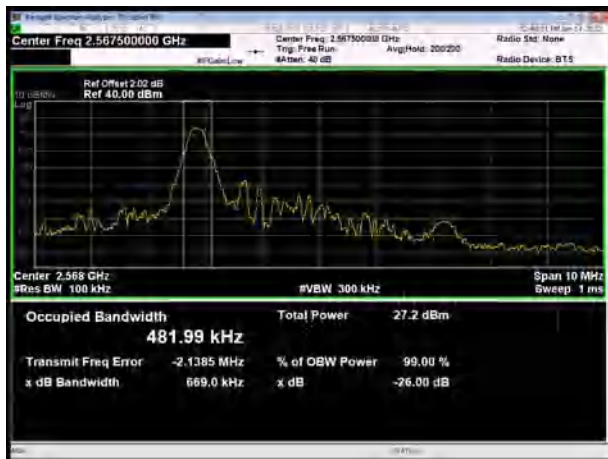

LTE Band 7 QPSK 10MHz CH-High

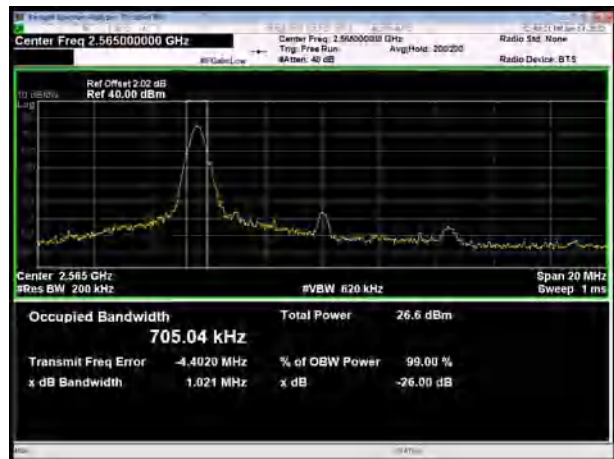

LTE Band 7 QPSK 15MHz CH-Low

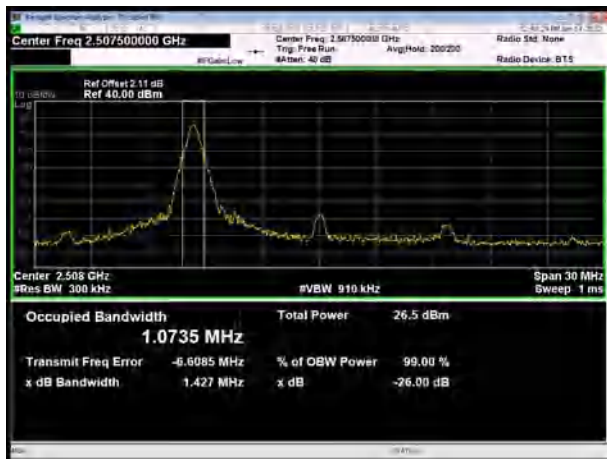

LTE Band 7 QPSK 20MHz CH-Low

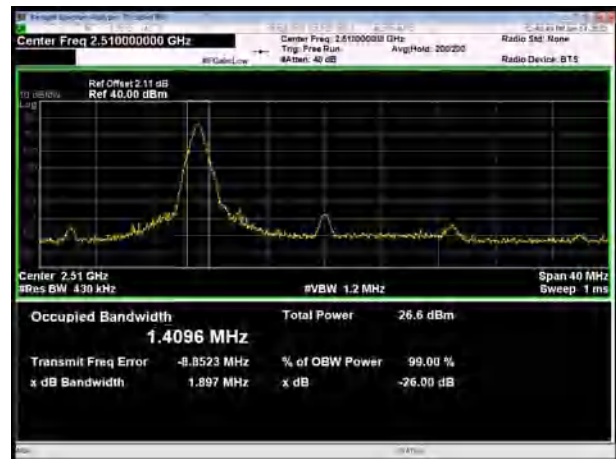

LTE Band 7 QPSK 15MHz CH-Middle

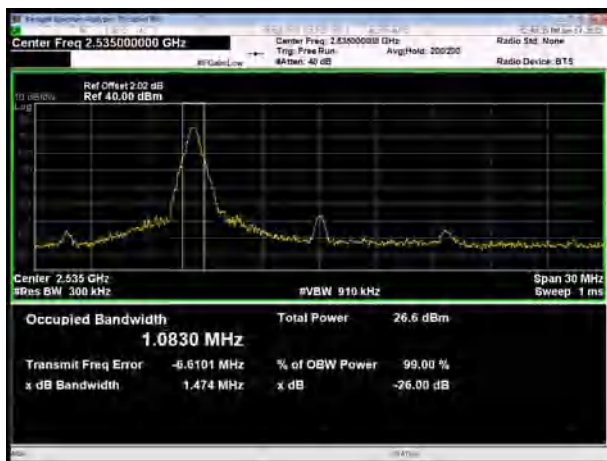

LTE Band 7 QPSK 20MHz CH-Middle

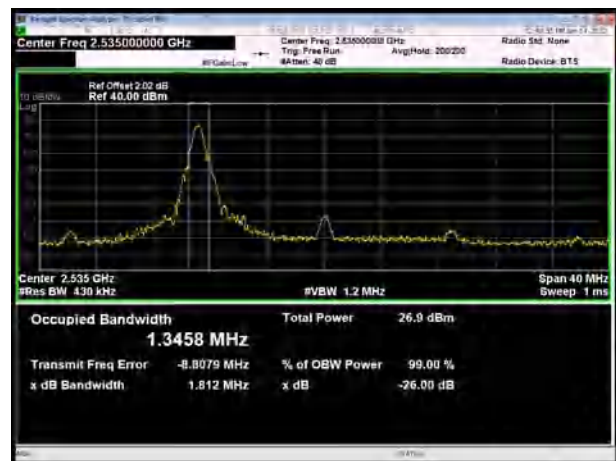

LTE Band 7 QPSK 15MHz CH-High

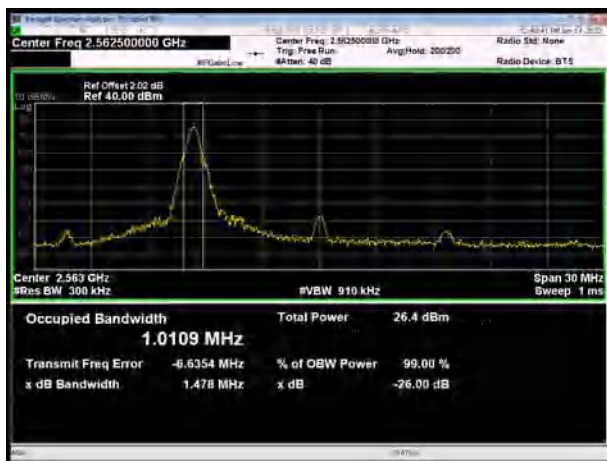

LTE Band 7 QPSK 20MHz CH-High

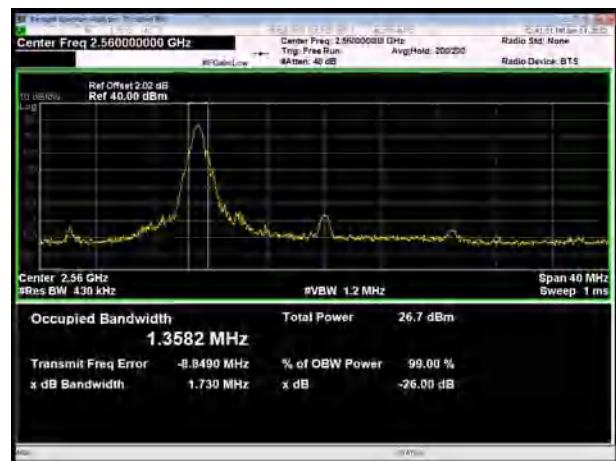

LTE Band 7 16QAM 5MHz CH-Low

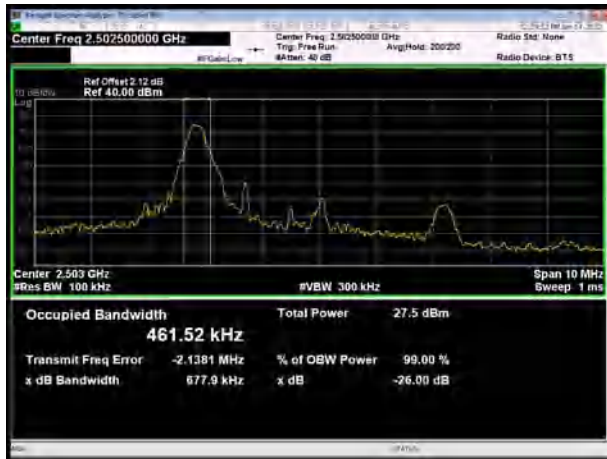

LTE Band 7 16QAM 10MHz CH-Low

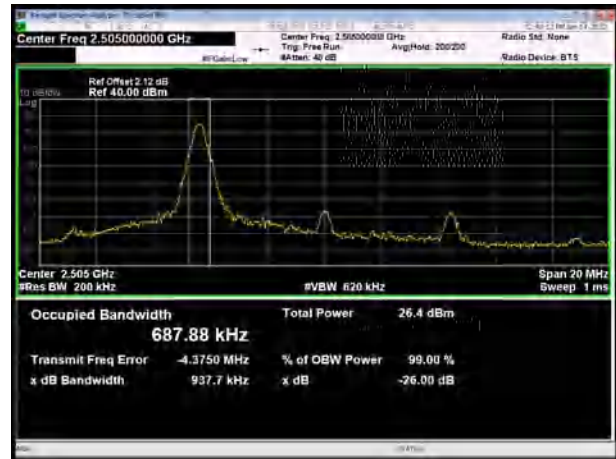

LTE Band 7 16QAM 5MHz CH-Middle



LTE Band 7 16QAM 10MHz CH-Middle

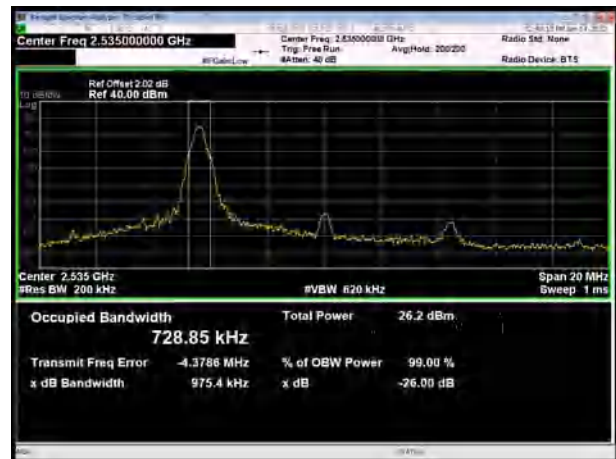

LTE Band 7 16QAM 5MHz CH-High

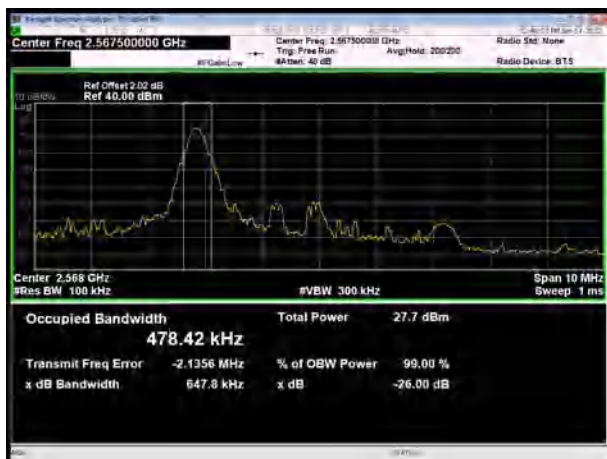

LTE Band 7 16QAM 10MHz CH-High



LTE Band 7 16QAM 15MHz CH-Low

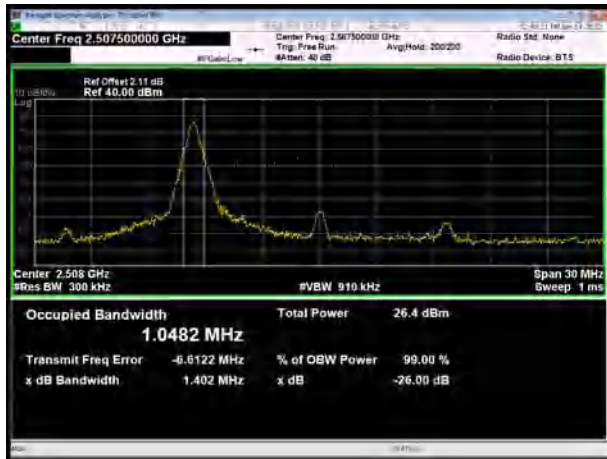

LTE Band 7 16QAM 20MHz CH-Low

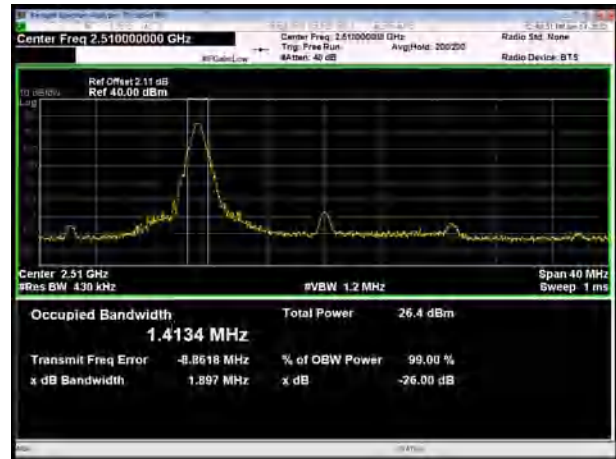

LTE Band 7 16QAM 15MHz CH-Middle

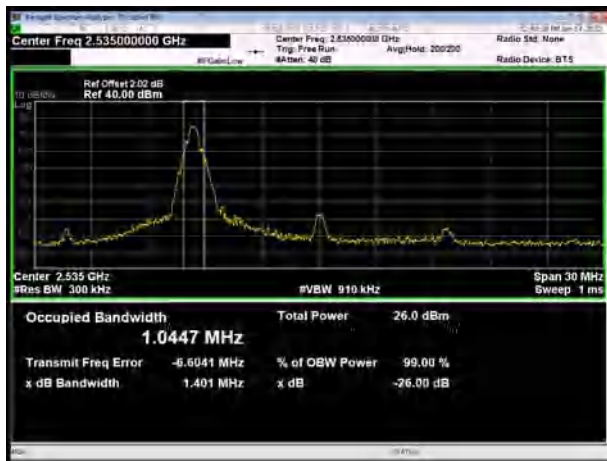

LTE Band 7 16QAM 20MHz CH-Middle

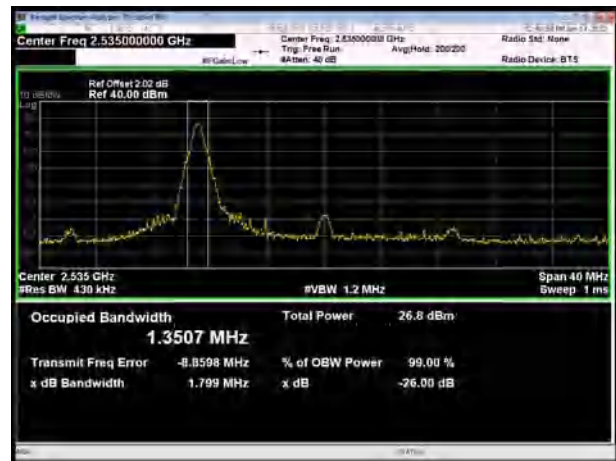

LTE Band 7 16QAM 15MHz CH-High

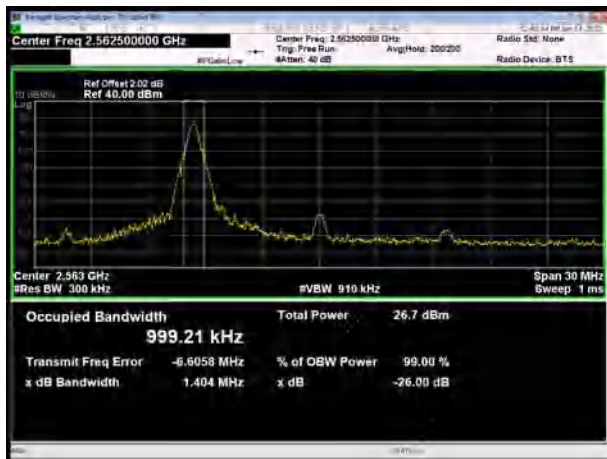

LTE Band 7 16QAM 20MHz CH-High

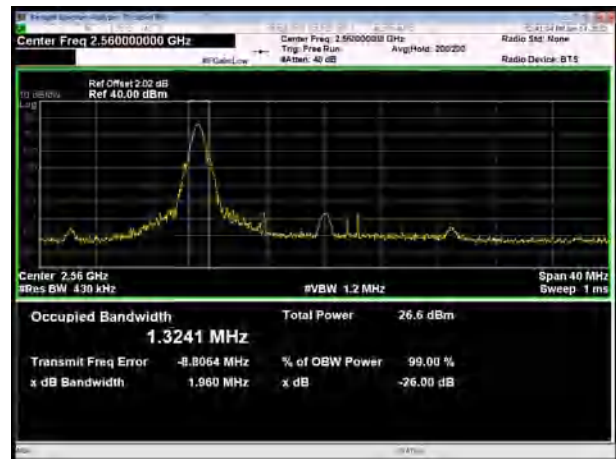



100% RB

LTE Band 7 QPSK 5MHz CH-Low

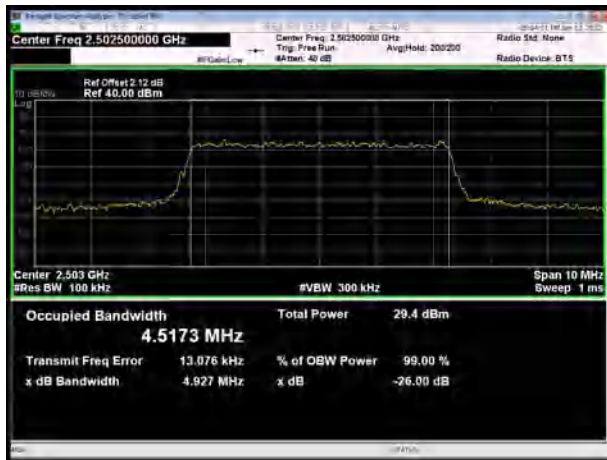

LTE Band 7 QPSK 10MHz CH-Low

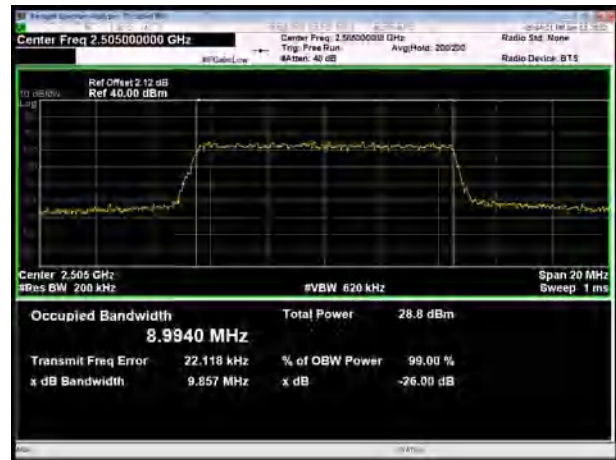

LTE Band 7 QPSK 5MHz CH-Middle

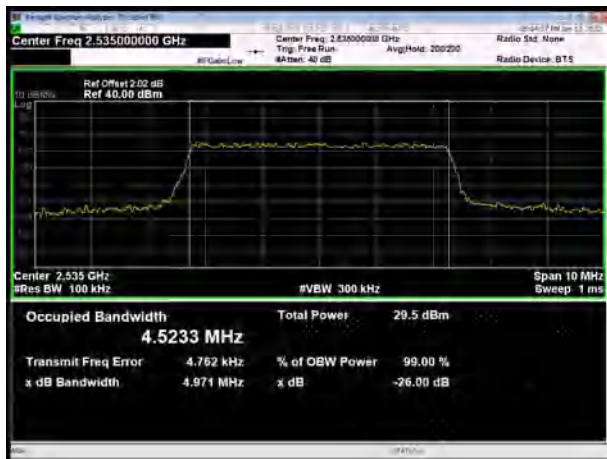

LTE Band 7 QPSK 10MHz CH-Middle

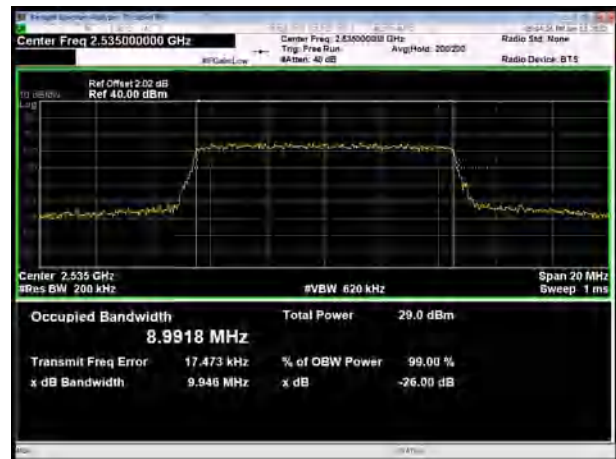

LTE Band 7 QPSK 5MHz CH-High



LTE Band 7 QPSK 10MHz CH-High



LTE Band 7 QPSK 15MHz CH-Low



LTE Band 7 QPSK 20MHz CH-Low

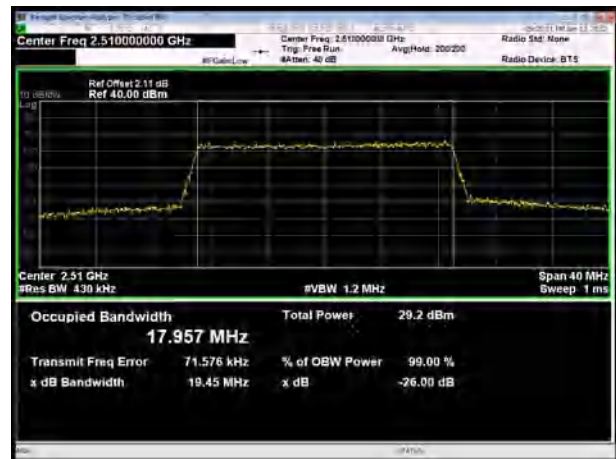

LTE Band 7 QPSK 15MHz CH-Middle

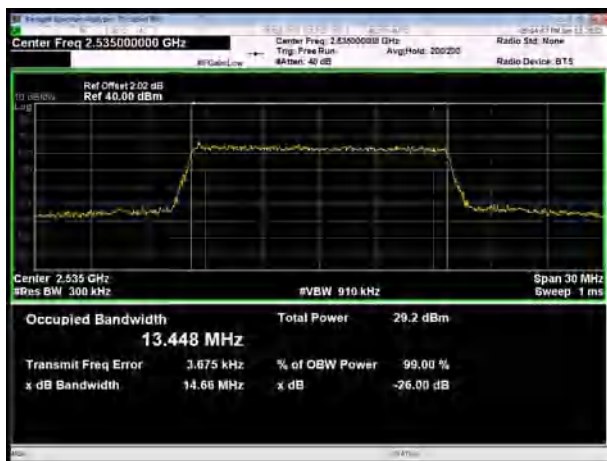

LTE Band 7 QPSK 20MHz CH-Middle

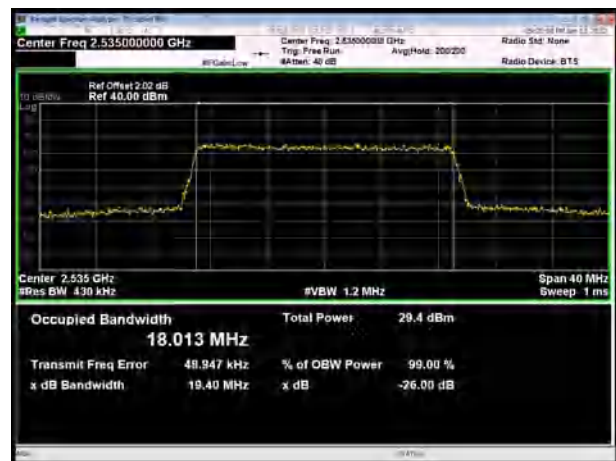

LTE Band 7 QPSK 15MHz CH-High

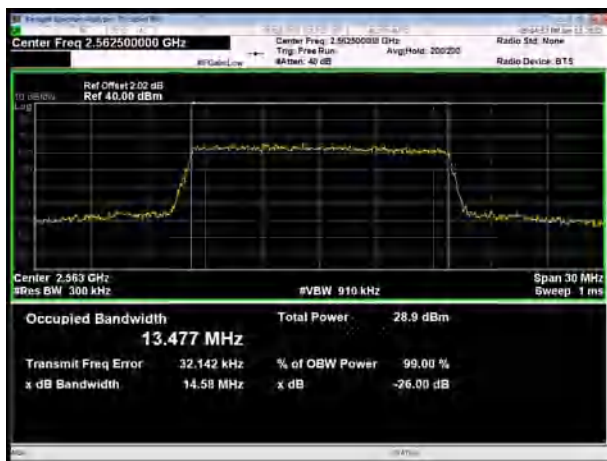

LTE Band 7 QPSK 20MHz CH-High

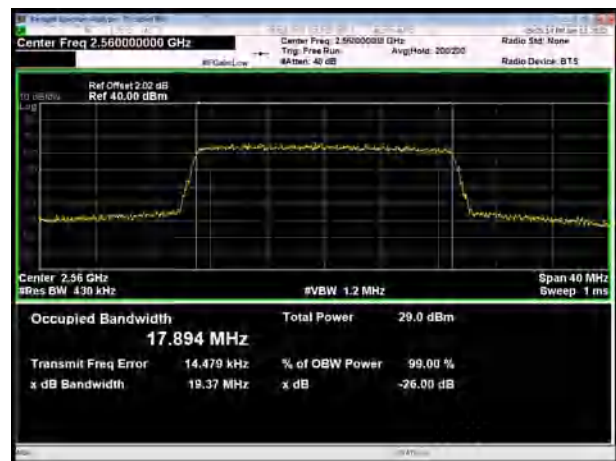

LTE Band 7 16QAM 5MHz CH-Low

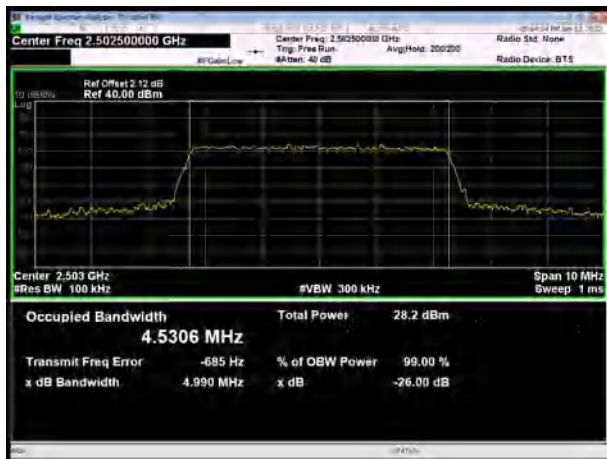

LTE Band 7 16QAM 10MHz CH-Low

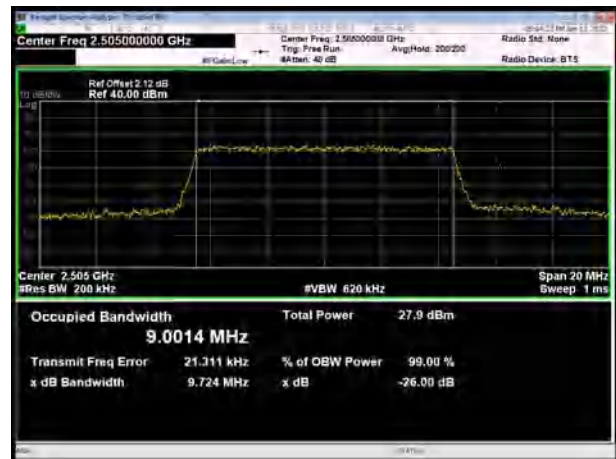

LTE Band 7 16QAM 5MHz CH-Middle

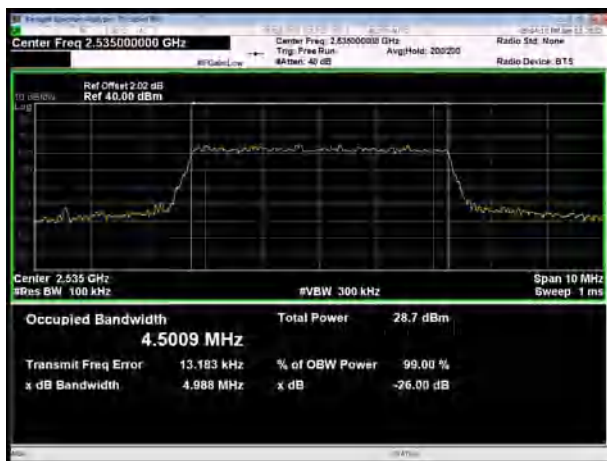

LTE Band 7 16QAM 10MHz CH-Middle

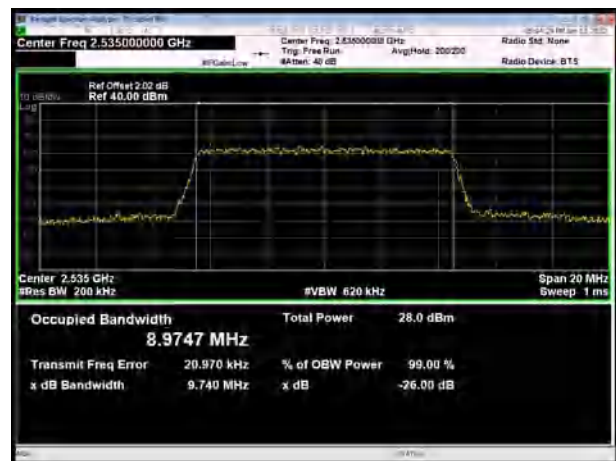

LTE Band 7 16QAM 5MHz CH-High



LTE Band 7 16QAM 10MHz CH-High

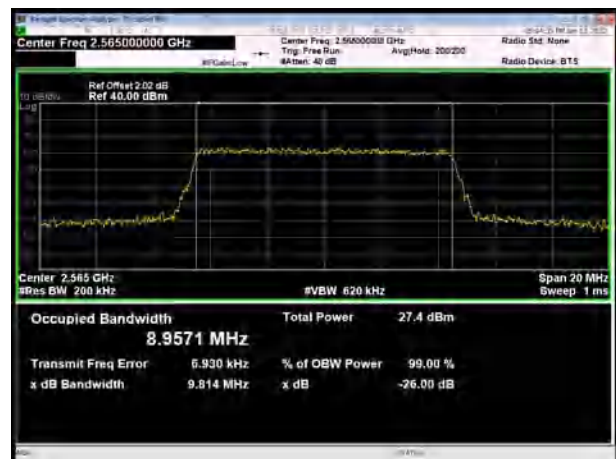





LTE Band 7 16QAM 15MHz CH-Low

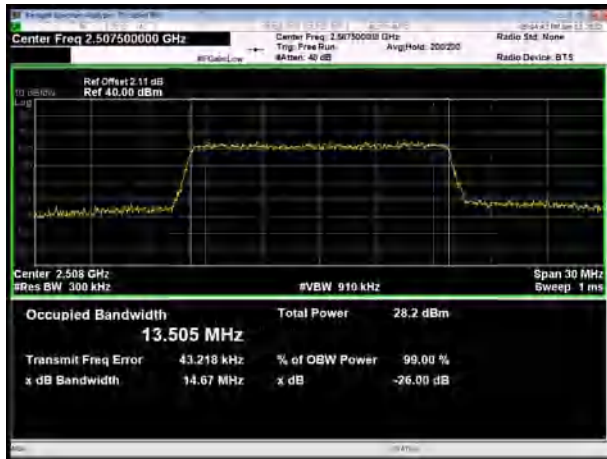

LTE Band 7 16QAM 20MHz CH-Low

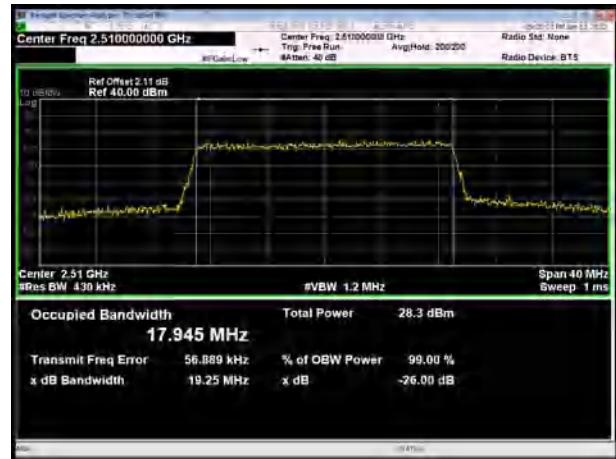

LTE Band 7 16QAM 15MHz CH-Middle



LTE Band 7 16QAM 20MHz CH-Middle

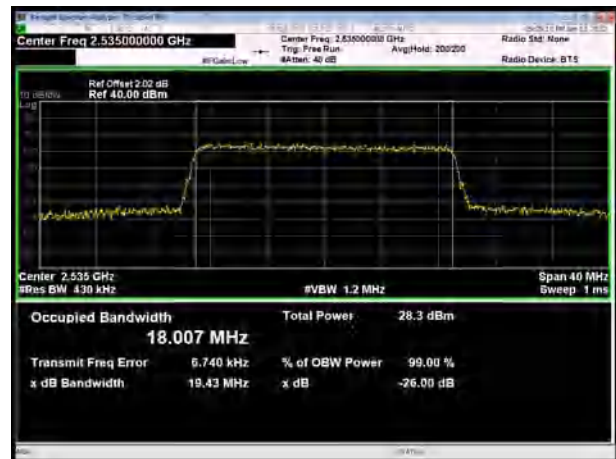

LTE Band 7 16QAM 15MHz CH-High



LTE Band 7 16QAM 20MHz CH-High

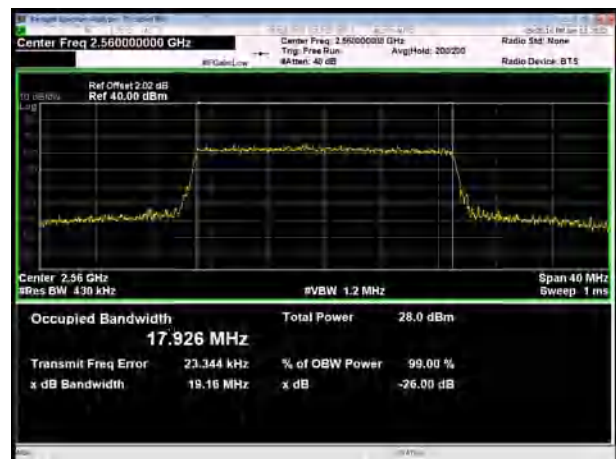

1 RB

LTE Band 38 QPSK 5MHz CH-Low

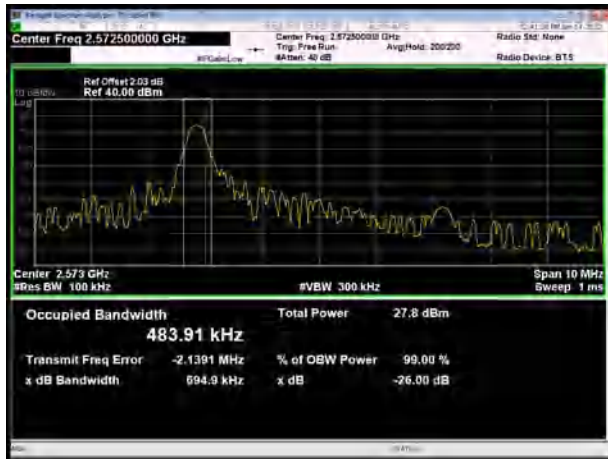

LTE Band 38 QPSK 10MHz CH-Low



LTE Band 38 QPSK 5MHz CH-Middle

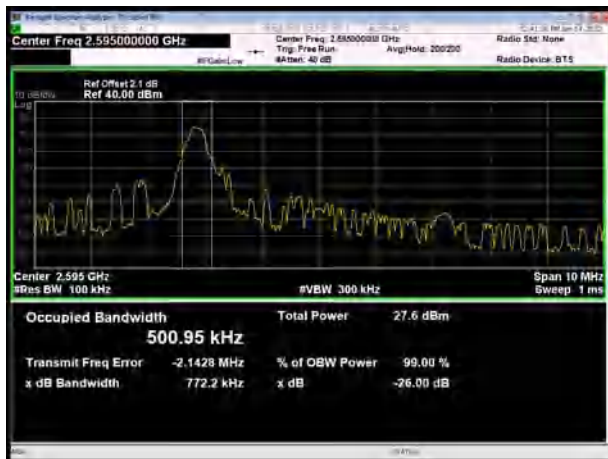

LTE Band 38 QPSK 10MHz CH-Middle

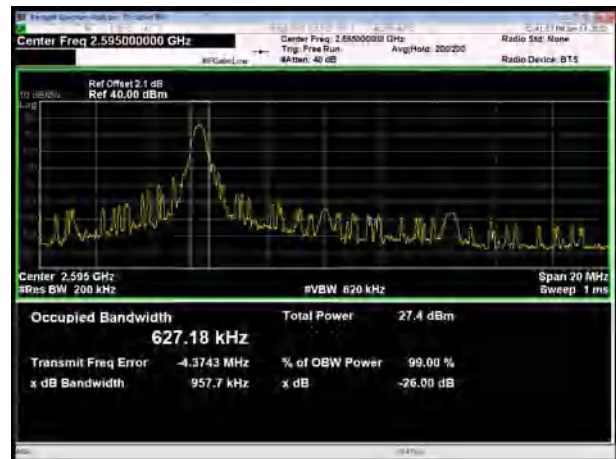

LTE Band 38 QPSK 5MHz CH-High

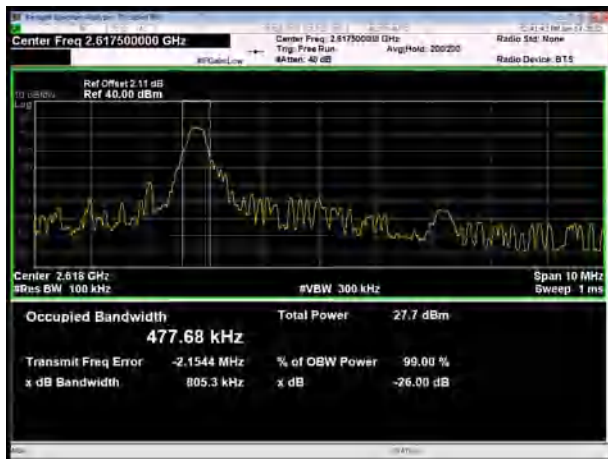

LTE Band 38 QPSK 10MHz CH-High

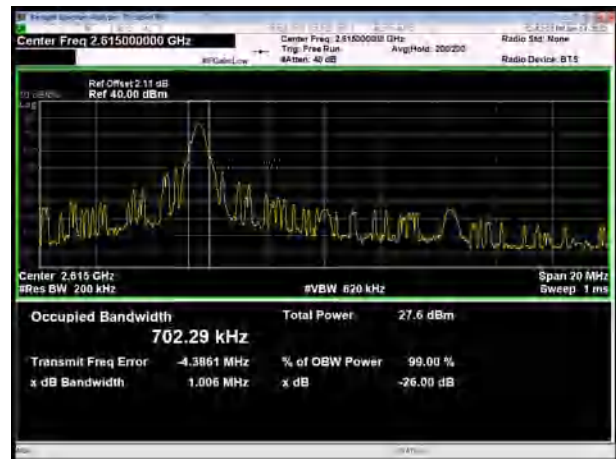



LTE Band 38 QPSK 15MHz CH-Low

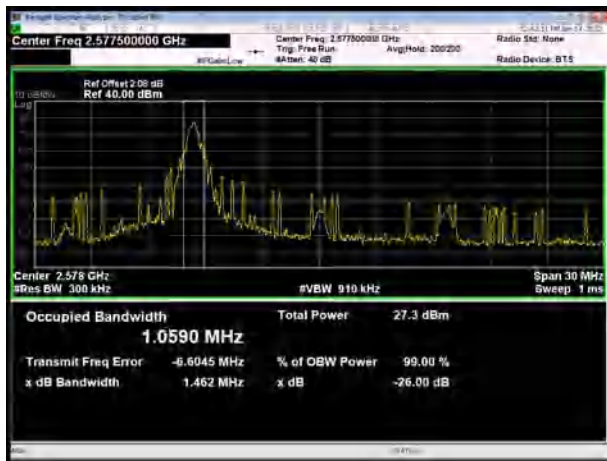

LTE Band 38 QPSK 20MHz CH-Low

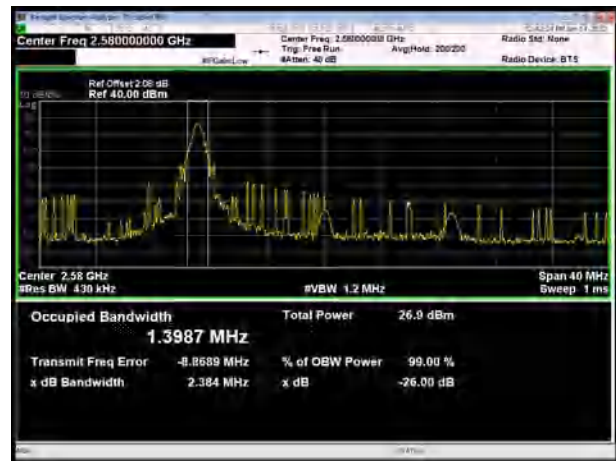

LTE Band 38 QPSK 15MHz CH-Middle

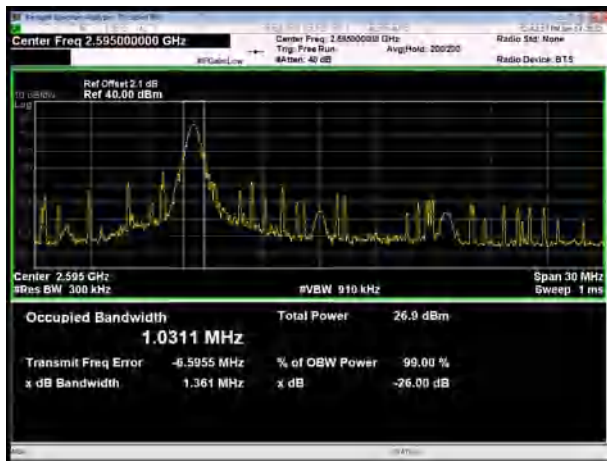

LTE Band 38 QPSK 20MHz CH-Middle

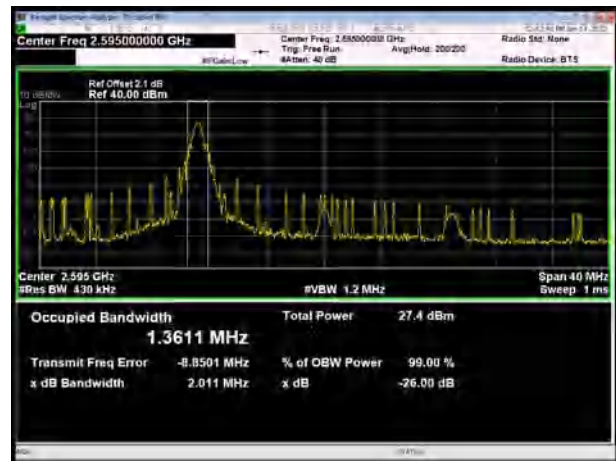

LTE Band 38 QPSK 15MHz CH-High

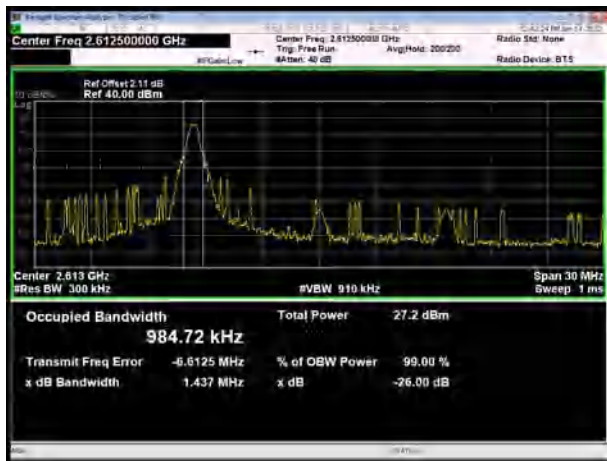

LTE Band 38 QPSK 20MHz CH-High

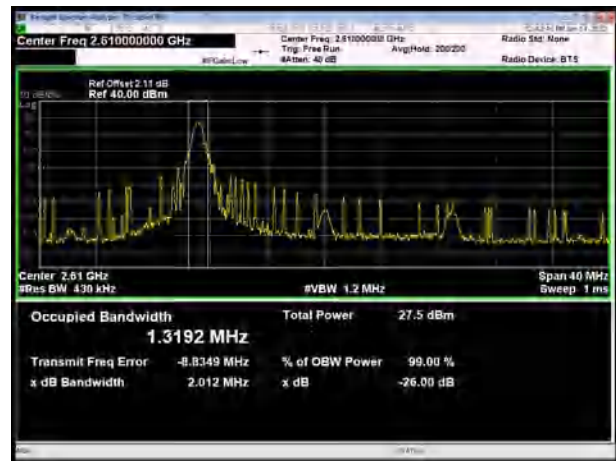



LTE Band 38 16QAM 5MHz CH-Low

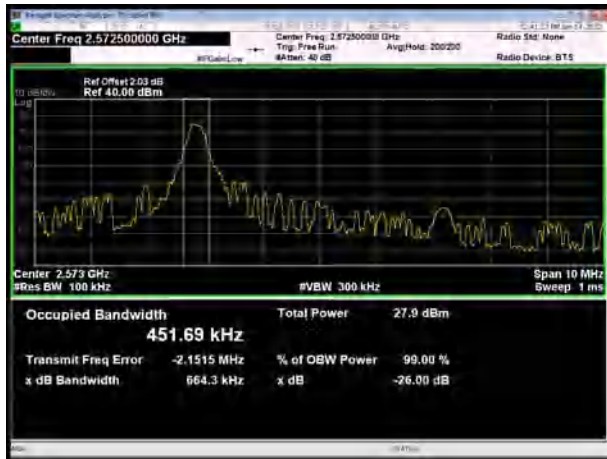

LTE Band 38 16QAM 10MHz CH-Low

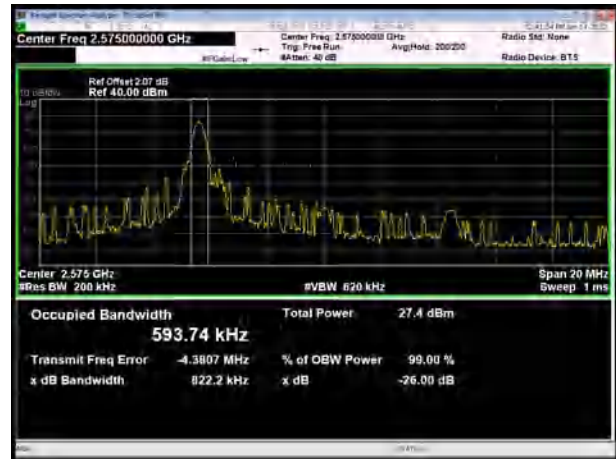

LTE Band 38 16QAM 5MHz CH-Middle



LTE Band 38 16QAM 10MHz CH-Middle

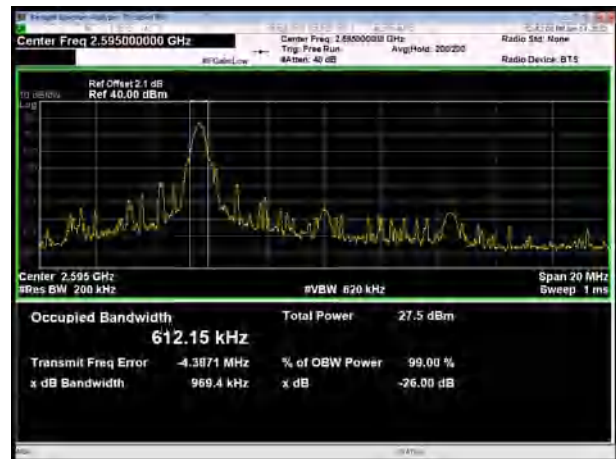

LTE Band 38 16QAM 5MHz CH-High



LTE Band 38 16QAM 10MHz CH-High

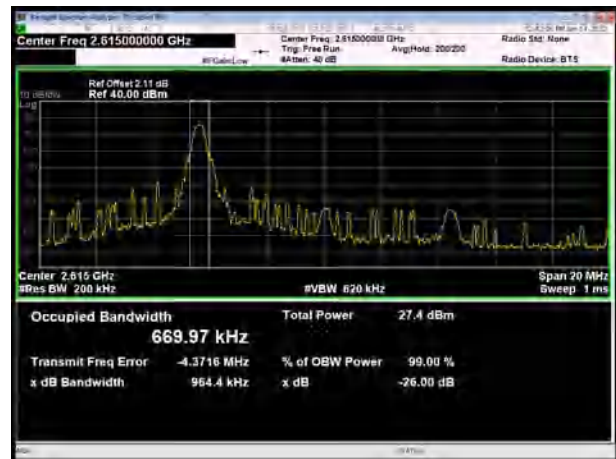

LTE Band 38 16QAM 15MHz CH-Low

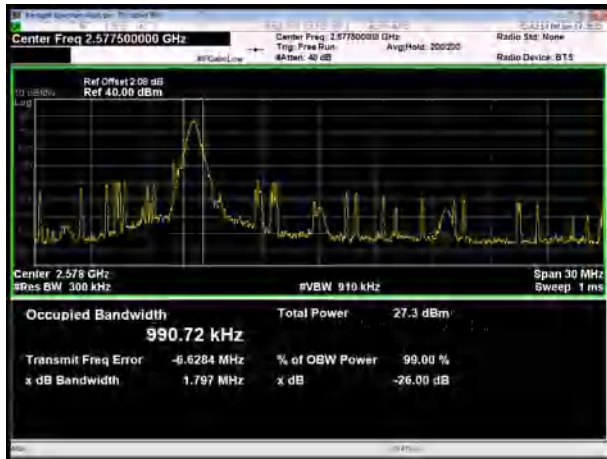

LTE Band 38 16QAM 20MHz CH-Low

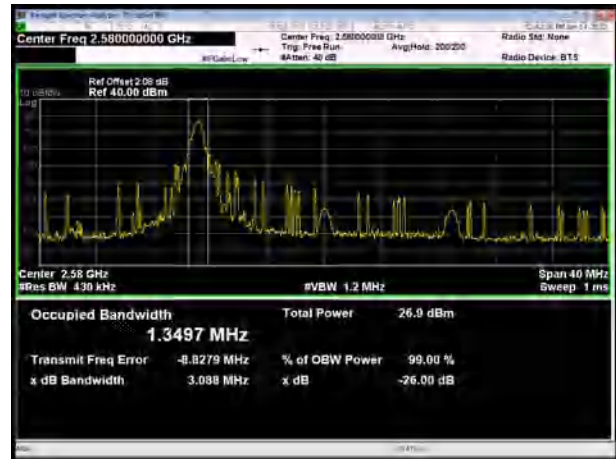

LTE Band 38 16QAM 15MHz CH-Middle

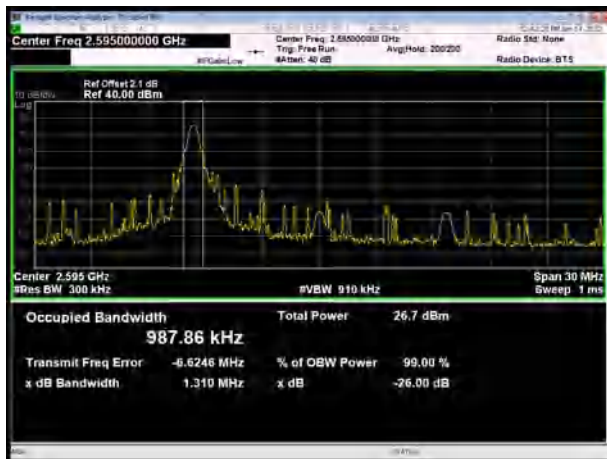

LTE Band 38 16QAM 20MHz CH-Middle

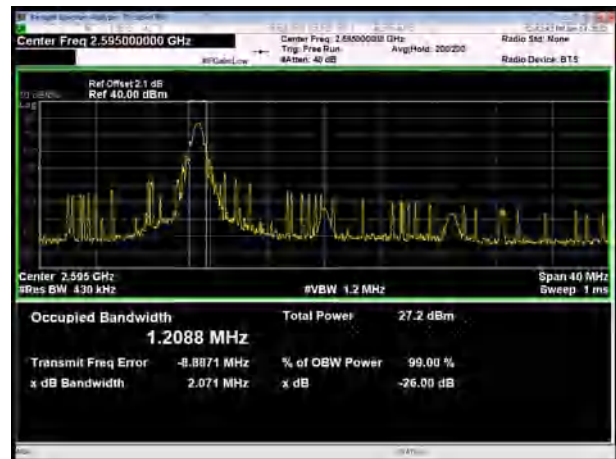

LTE Band 38 16QAM 15MHz CH-High

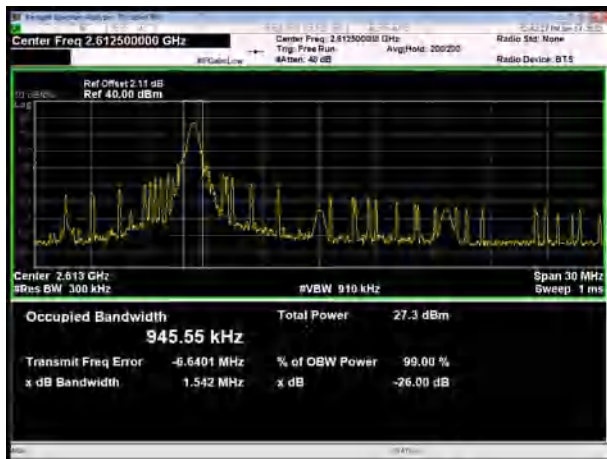

LTE Band 38 16QAM 20MHz CH-High

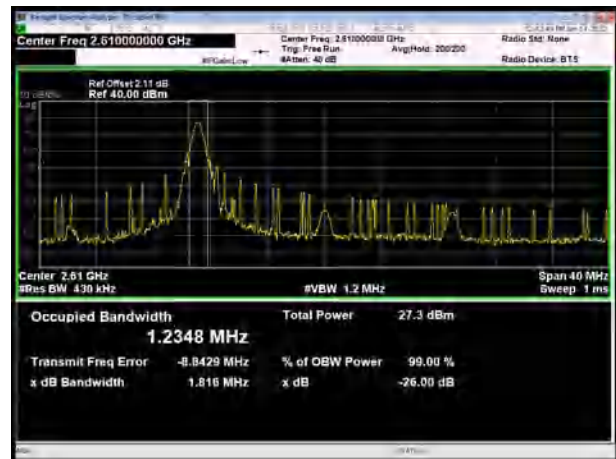



100% RB

LTE Band 38 QPSK 5MHz CH-Low



LTE Band 38 QPSK 10MHz CH-Low

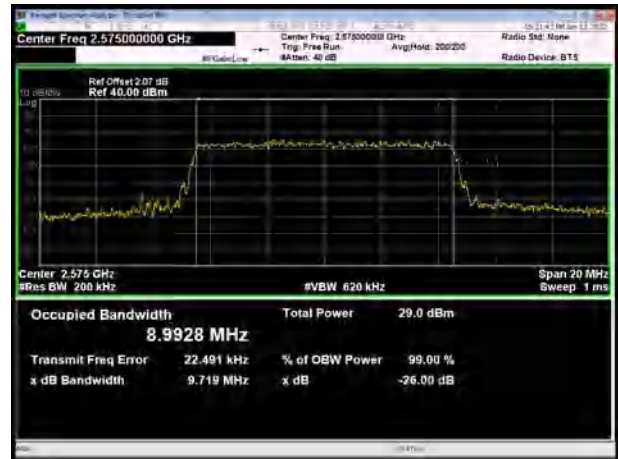

LTE Band 38 QPSK 5MHz CH-Middle

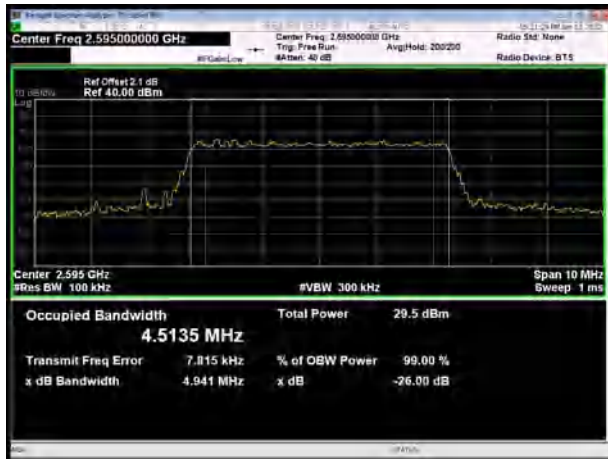

LTE Band 38 QPSK 10MHz CH-Middle

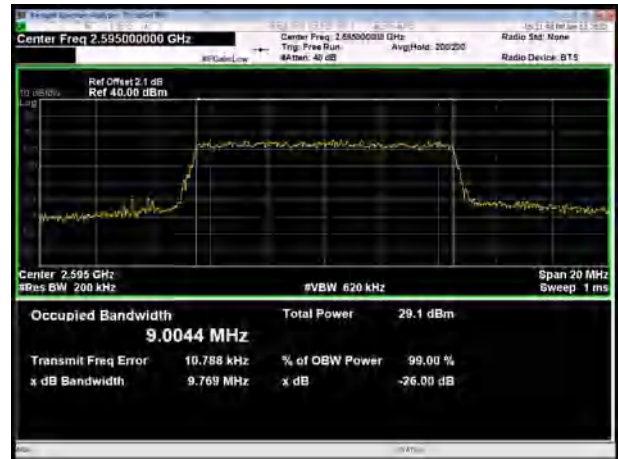

LTE Band 38 QPSK 5MHz CH-High

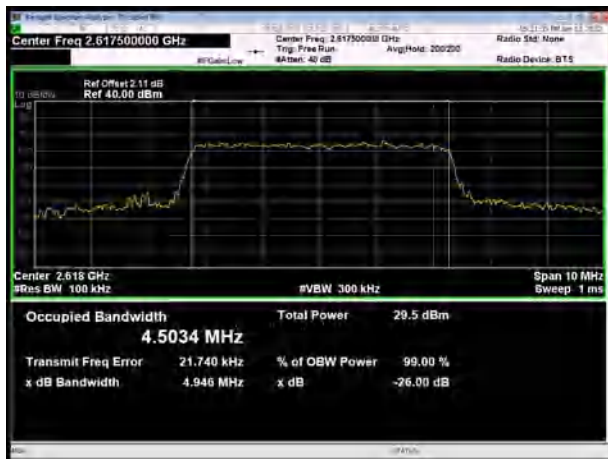

LTE Band 38 QPSK 10MHz CH-High



LTE Band 38 QPSK 15MHz CH-Low

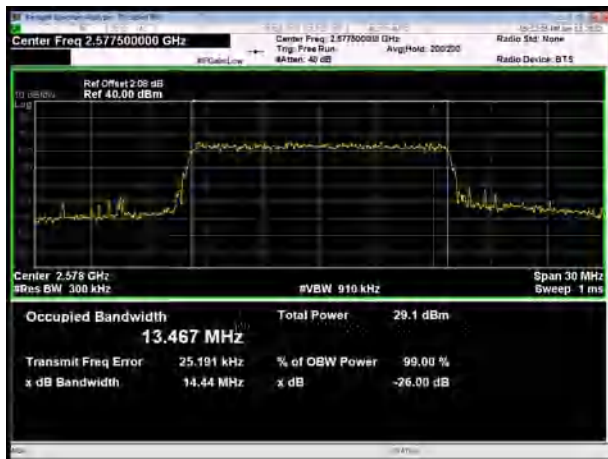

LTE Band 38 QPSK 20MHz CH-Low

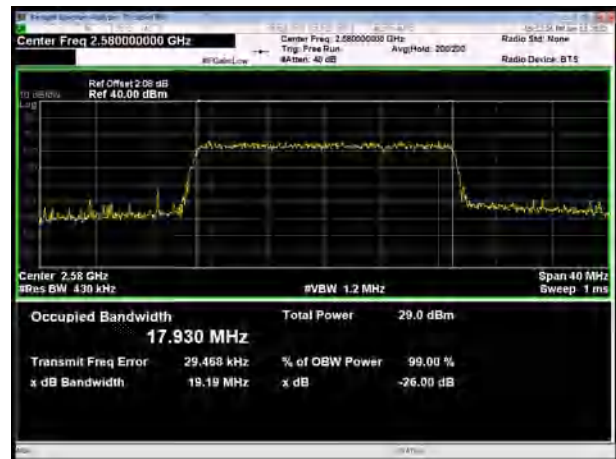

LTE Band 38 QPSK 15MHz CH-Middle

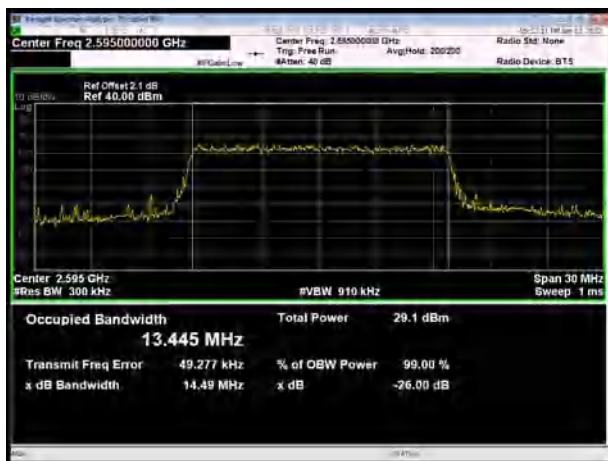

LTE Band 38 QPSK 20MHz CH-Middle

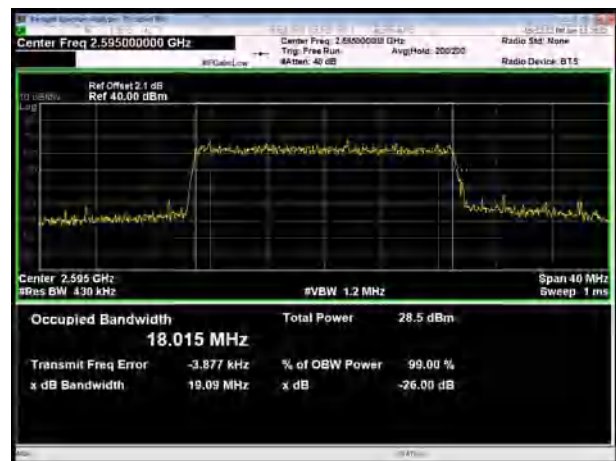

LTE Band 38 QPSK 15MHz CH-High

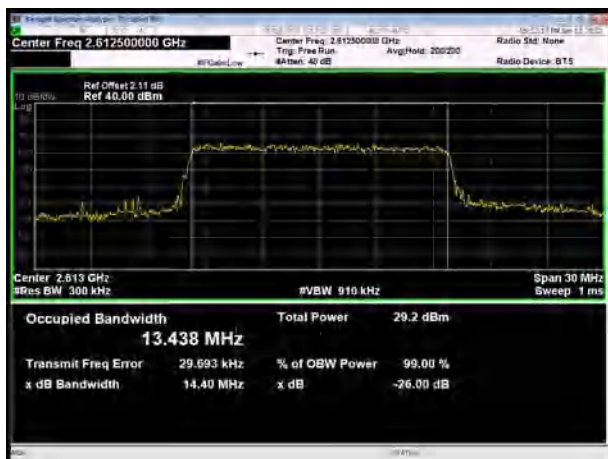

LTE Band 38 QPSK 20MHz CH-High

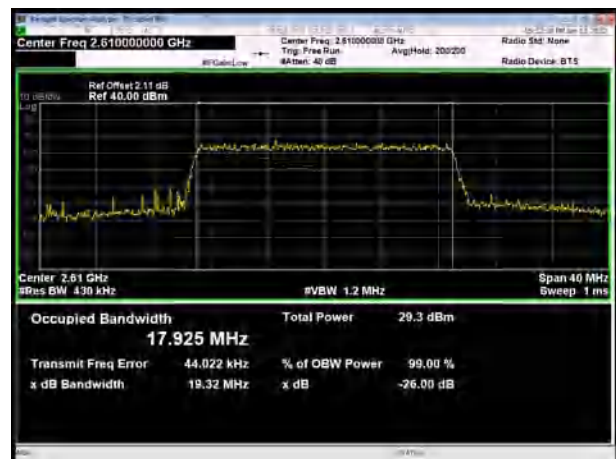

LTE Band 38 16QAM 5MHz CH-Low



LTE Band 38 16QAM 10MHz CH-Low



LTE Band 38 16QAM 5MHz CH-Middle



LTE Band 38 16QAM 10MHz CH-Middle



LTE Band 38 16QAM 5MHz CH-High

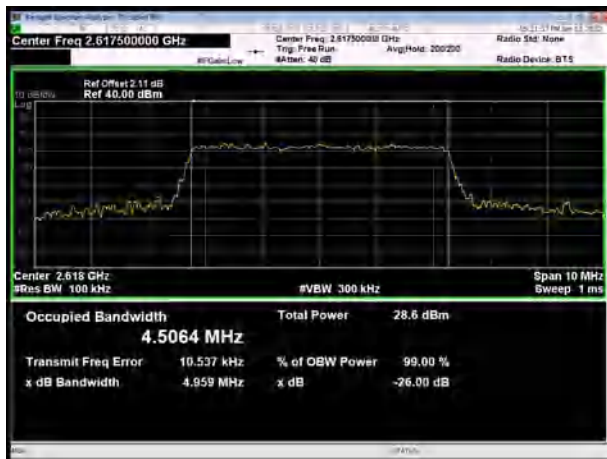

LTE Band 38 16QAM 10MHz CH-High

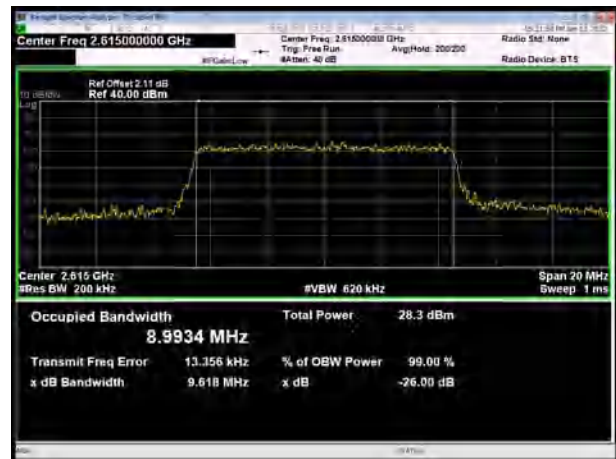





LTE Band 38 16QAM 15MHz CH-Low

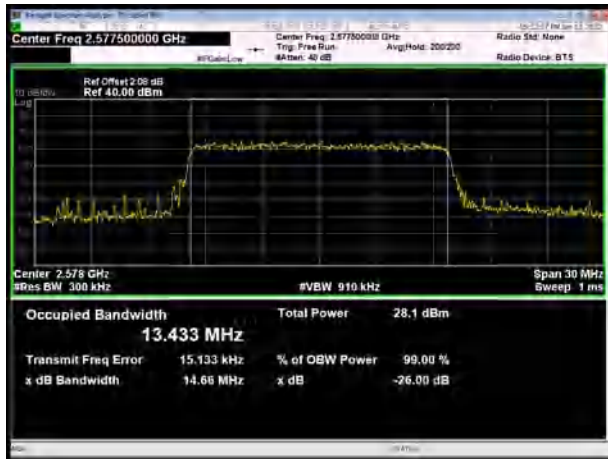

LTE Band 38 16QAM 20MHz CH-Low

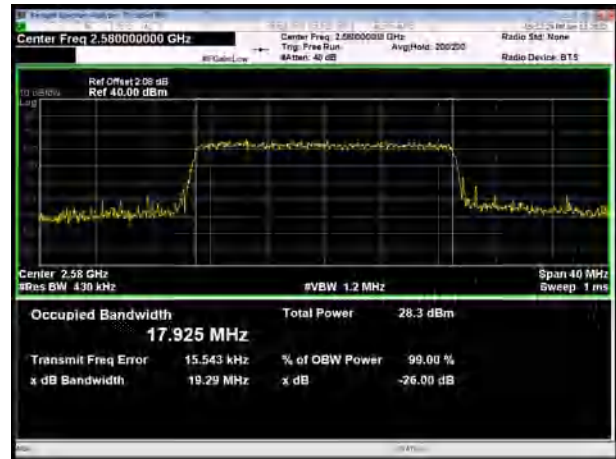

LTE Band 38 16QAM 15MHz CH-Middle

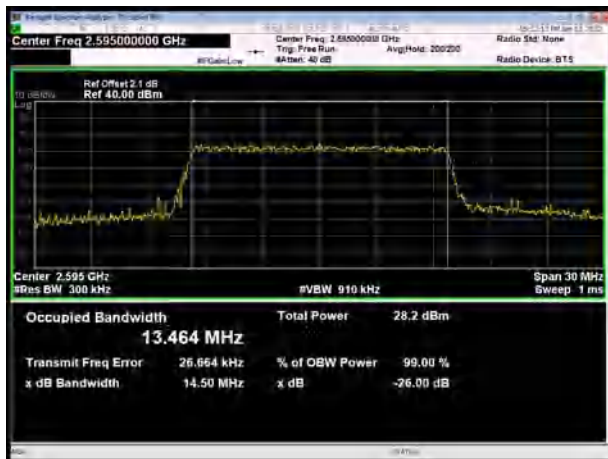

LTE Band 38 16QAM 20MHz CH-Middle

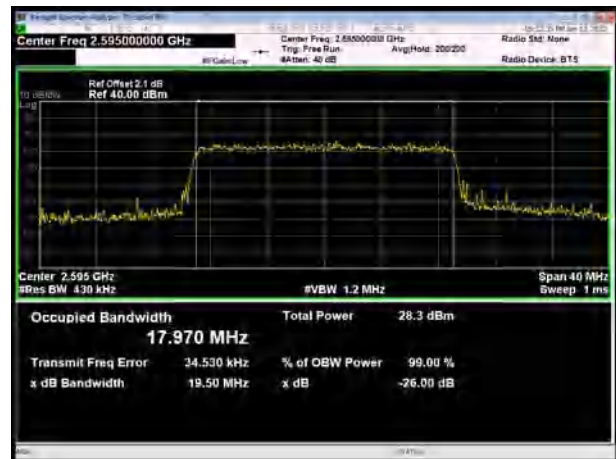

LTE Band 38 16QAM 15MHz CH-High

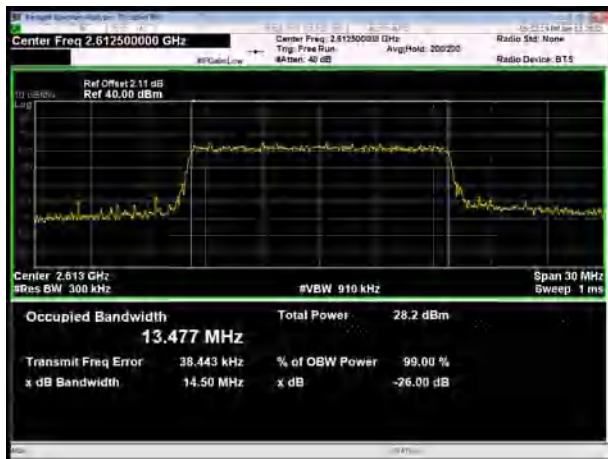

LTE Band 38 16QAM 20MHz CH-High

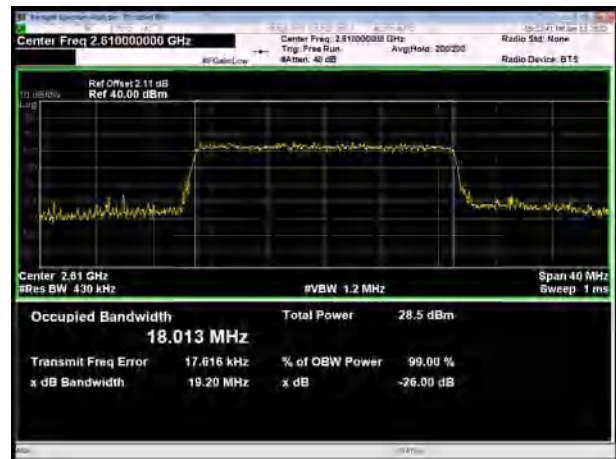

### 5.3 Band Edge Compliance

#### Ambient condition

Temperature	Relative humidity	Pressure
23°C ~25°C	45%~50%	101.5kPa

#### Method of Measurement

The EUT was connected to Spectrum Analyzer and Base Station Simulator via power Splitter. The band edge of the lowest and highest channels were measured.

The testing follows KDB 971168 D01 v03r01 Section 6.0

The EUT was connected to spectrum analyzer and system simulator via a power divider.

The band edges of low and high channels for the highest RF powers were measured.

For LTE Band 7/38 set RBW  $\geq$  1% EBW in the 1MHz band immediately outside and adjacent to the band edge. Beyond the 1 MHz band from the band edge, RBW=1MHz was used.

on spectrum analyzer.

Set spectrum analyzer with RMS detector.

The RF fundamental frequency should be excluded against the limit line in the operating frequency band.

Checked that all the results comply with the emission limit line.

#### Test Setup

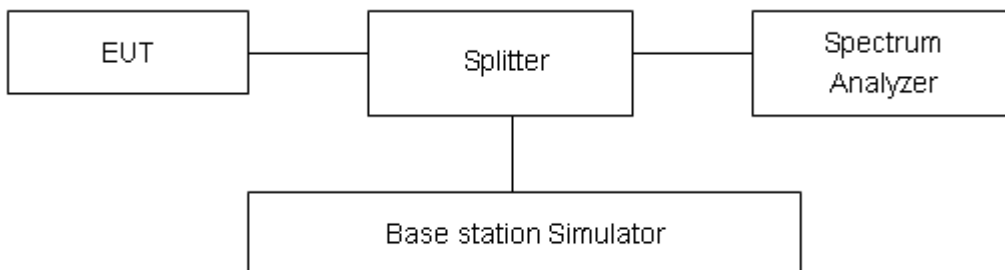

#### Limits

Rule Part 27.53(m) (4) specifies that “for BRS and EBS stations. For mobile digital stations, the attenuation factor shall be not less than  $40 + 10 \log (P)$  dB on all frequencies between the channel edge and 5 megahertz from the channel edge,  $43 + 10 \log (P)$  dB on all frequencies between 5 megahertz and X megahertz from the channel edge, and  $55 + 10 \log (P)$  dB on all frequencies more than X megahertz from the channel edge, where X is the greater of 6 megahertz or the actual emission bandwidth as defined in paragraph (m)(4) of this section. In addition, the attenuation factor shall not be less that  $43 + 10 \log (P)$  dB on all frequencies between 2490.5 MHz and 2496 MHz and  $55 + 10 \log (P)$  dB at or below 2490.5 MHz. Mobile Satellite Service licensees operating on frequencies below 2495 MHz may also submit a documented interference complaint against BRS licensees operating on channel BRS Channel 1 on the same terms and conditions as adjacent channel BRS or EBS licensees.



Example:

The limit line is derived from  $43 + 10\log(P)$  dB below the transmitter power  $P$ (Watts)  
=  $P(W) - [43 + 10\log(P)]$  (dB)  
=  $[30 + 10\log(P)]$  (dBm) -  $[43 + 10\log(P)]$  (dB) = -13dBm.

Rule Part 27.53(f) For operations in the 746-758 MHz, 775-788 MHz, and 805-806 MHz bands, emissions in the band 1559-1610 MHz shall be limited to  $-70$  dBW/MHz equivalent isotropically radiated power (EIRP) for wideband signals, and  $-80$  dBW EIRP for discrete emissions of less than 700 Hz bandwidth. For the purpose of equipment authorization, a transmitter shall be tested with an antenna that is representative of the type that will be used with the equipment in normal operation.

Rule Part 27.53 (c) For operations in the 746-758 MHz band and the 776-788 MHz band, the power of any emission outside the licensee's frequency band(s) of operation shall be attenuated below the transmitter power ( $P$ ) within the licensed band(s) of operation, measured in watts, in accordance with the following:

- (1) On any frequency outside the 746-758 MHz band, the power of any emission shall be attenuated outside the band below the transmitter power ( $P$ ) by at least  $43 + 10 \log(P)$  dB;
- (2) On any frequency outside the 776-788 MHz band, the power of any emission shall be attenuated outside the band below the transmitter power ( $P$ ) by at least  $43 + 10 \log(P)$  dB;
- (3) On all frequencies between 763-775 MHz and 793-805 MHz, by a factor not less than  $76 + 10 \log(P)$  dB in a 6.25 kHz band segment, for base and fixed stations;
- (4) On all frequencies between 763-775 MHz and 793-805 MHz, by a factor not less than  $65 + 10 \log(P)$  dB in a 6.25 kHz band segment, for mobile and portable stations;
- (5) Compliance with the provisions of paragraphs (c)(1) and (c)(2) of this section is based on the use of measurement instrumentation employing a resolution bandwidth of 100 kHz or greater. However, in the 100 kHz bands immediately outside and adjacent to the frequency block, a resolution bandwidth of at least 30 kHz may be employed;

### Measurement Uncertainty

The assessed measurement uncertainty to ensure 95% confidence level for the normal distribution is with the coverage factor  $k = 1.96$ ,  $U=0.684$ dB.



### Test Result

All the test traces in the plots shows the test results clearly.

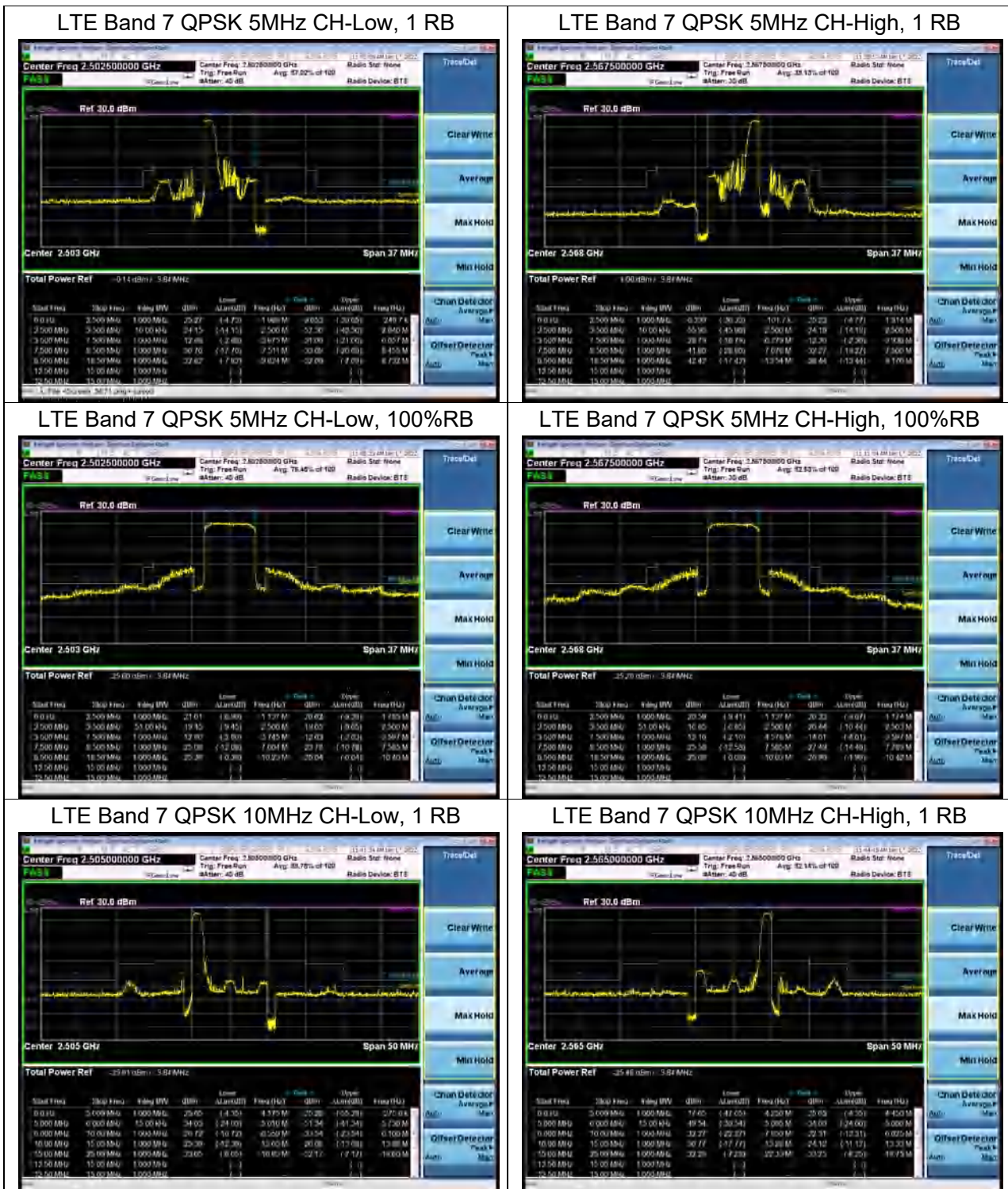



LTE Band 7 QPSK 10MHz CH-Low, 100%RB



LTE Band 7 QPSK 10MHz CH-High, 100%RB



LTE Band 7 QPSK 15MHz CH-Low, 1 RB



LTE Band 7 QPSK 15MHz CH-High, 1 RB



LTE Band 7 QPSK 15MHz CH-Low, 100%RB



LTE Band 7 QPSK 15MHz CH-High, 100%RB





LTE Band 7 QPSK 20MHz CH-Low, 1 RB



LTE Band 7 QPSK 20MHz CH-High, 1 RB



LTE Band 7 QPSK 20MHz CH-Low, 100%RB



LTE Band 7 QPSK 20MHz CH-High, 100%RB



LTE Band 7 16QAM 5MHz CH-Low, 1 RB



LTE Band 7 16QAM 5MHz CH-High, 1 RB





LTE Band 7 16QAM 5MHz CH-Low, 100%RB



LTE Band 7 16QAM 5MHz CH-High, 100%RB



LTE Band 7 16QAM 10MHz CH-Low, 1 RB



LTE Band 7 16QAM 10MHz CH-High, 1 RB



LTE Band 7 16QAM 10MHz CH-Low, 100%RB



LTE Band 7 16QAM 10MHz CH-High, 100%RB



LTE Band 7 16QAM 15MHz CH-Low, 1 RB



LTE Band 7 16QAM 15MHz CH-High, 1 RB



LTE Band 7 16QAM 15MHz CH-Low, 100%RB



LTE Band 7 16QAM 15MHz CH-High, 100%RB



LTE Band 7 16QAM 20MHz CH-Low, 1 RB



LTE Band 7 16QAM 20MHz CH-High, 1 RB







LTE Band 7 16QAM 20MHz CH-Low, 100%RB



LTE Band 7 16QAM 20MHz CH-High, 100%RB



LTE Band 38 QPSK 5MHz CH-Low, 1 RB



LTE Band 38 QPSK 5MHz CH-High, 1 RB



LTE Band 38 QPSK 5MHz CH-Low, 100%RB

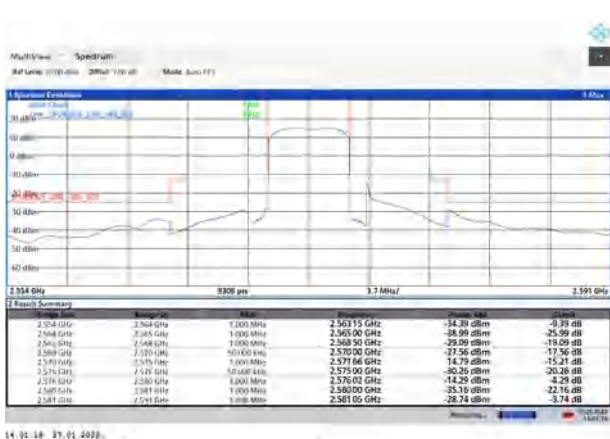

LTE Band 38 QPSK 5MHz CH-High, 100%RB

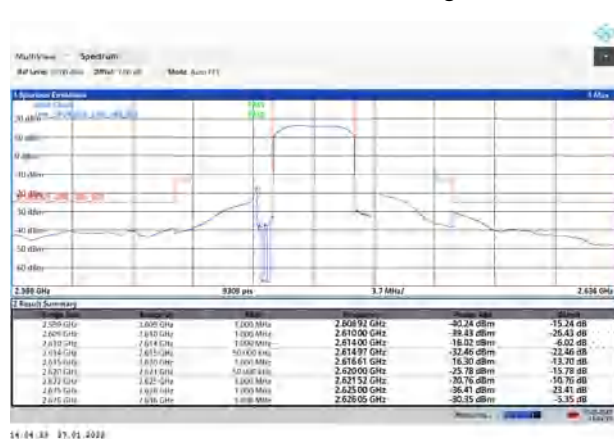



LTE Band 38 QPSK 10MHz CH-Low, 1 RB

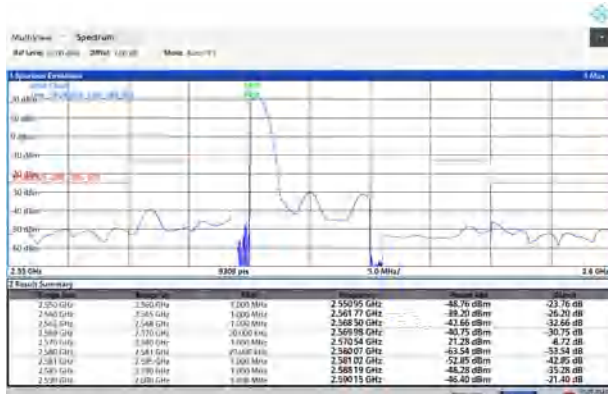

14 17:30 17, 01, 2022

LTE Band 38 QPSK 10MHz CH-High, 1 RB

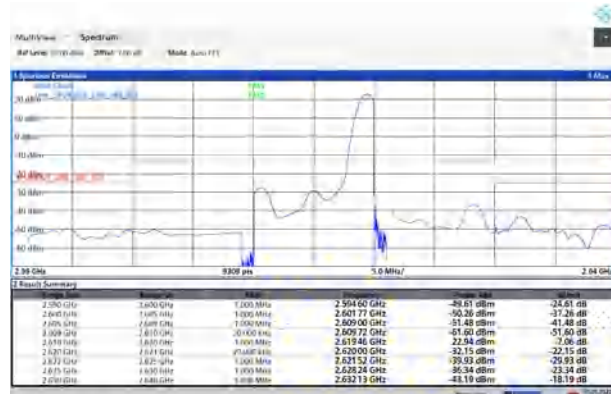

14 14:04 17, 01, 2022

LTE Band 38 QPSK 10MHz CH-Low, 100%RB

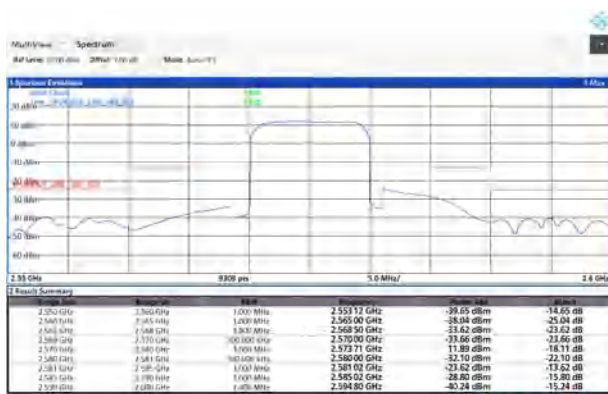

14 14:11 17, 01, 2022

LTE Band 38 QPSK 10MHz CH-High, 100%RB

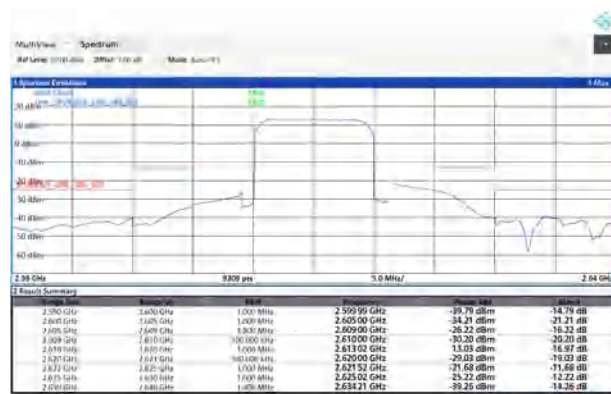

14 13:14 17, 01, 2022

LTE Band 38 QPSK 15MHz CH-Low, 1 RB

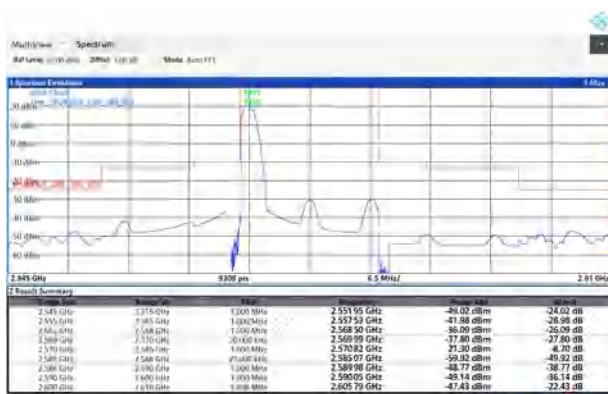

14 14:09 17, 01, 2022

LTE Band 38 QPSK 15MHz CH-High, 1 RB

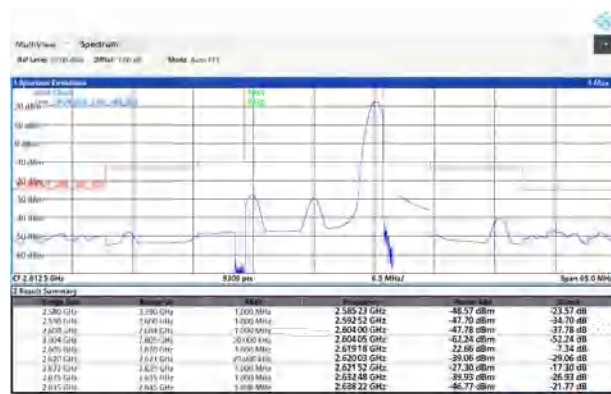

14 14:09 17, 01, 2022



LTE Band 38 QPSK 15MHz CH-Low, 100%RB

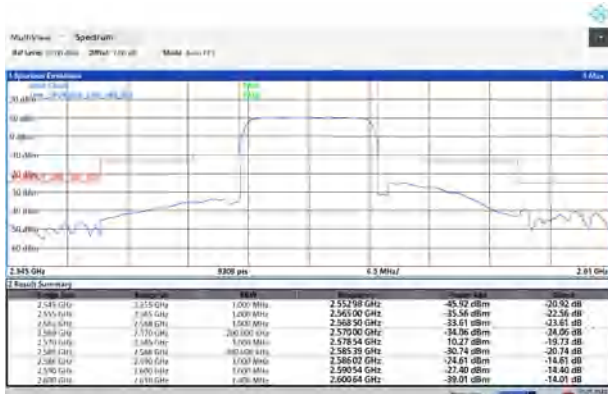

14:33:04 30.01.2022

LTE Band 38 QPSK 15MHz CH-High, 100%RB

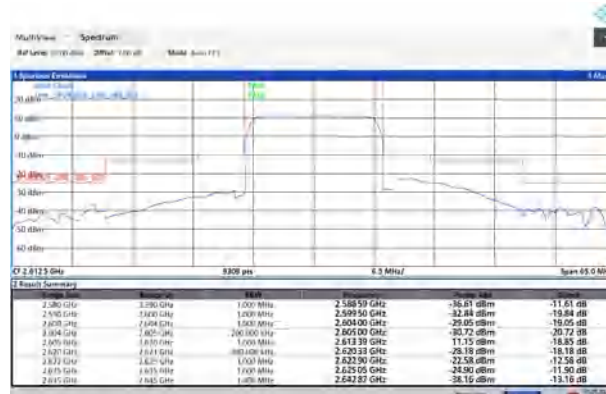

14:43:40 30.01.2022

LTE Band 38 QPSK 20MHz CH-Low, 1 RB

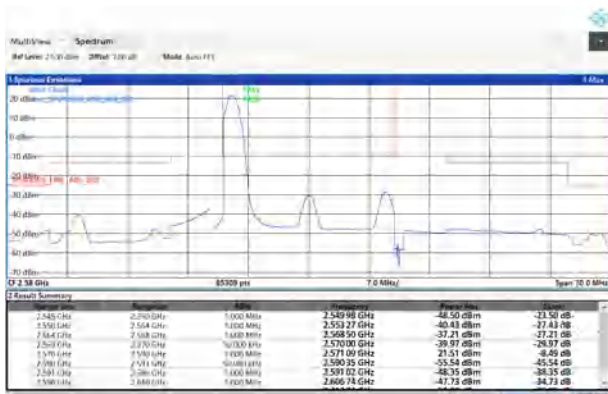

11:29:28 30.01.2022

LTE Band 38 QPSK 20MHz CH-High, 1 RB

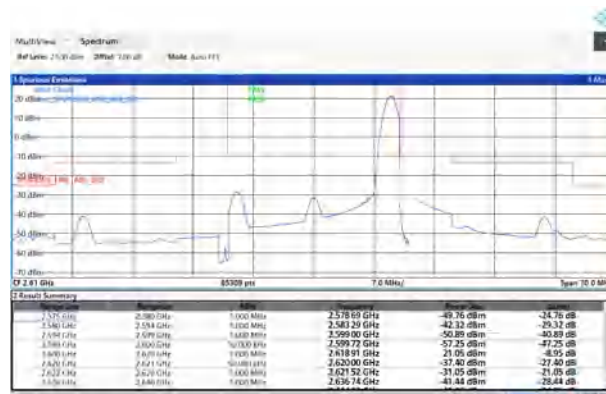

11:39:08 30.01.2022

LTE Band 38 QPSK 20MHz CH-Low, 100%RB

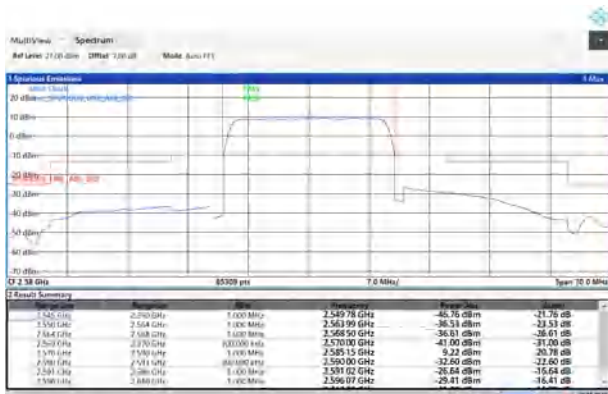

11:39:08 30.01.2022

LTE Band 38 QPSK 20MHz CH-High, 100%RB

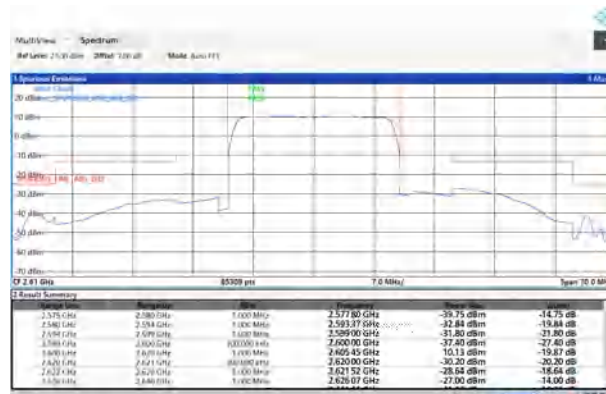

11:39:08 30.01.2022



LTE Band 38 16QAM 5MHz CH-Low, 1 RB



13.19.04 17.01.2022

LTE Band 38 16QAM 5MHz CH-High, 1 RB

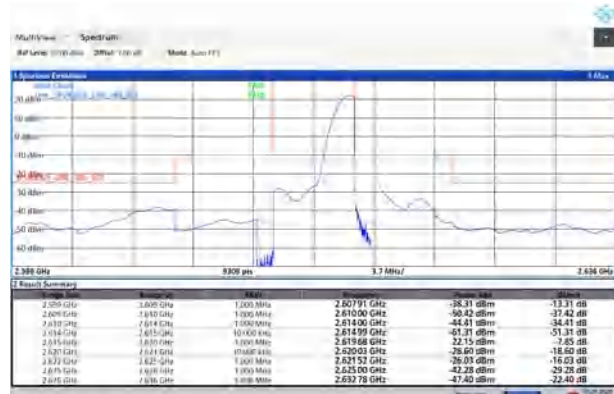

14.04.04 17.01.2022

LTE Band 38 16QAM 5MHz CH-Low, 100%RB

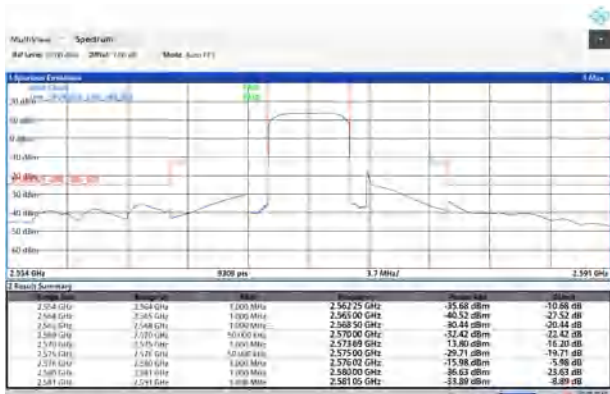

14.05.04 17.01.2022

LTE Band 38 16QAM 5MHz CH-High, 100%RB



14.04.07 17.01.2022

LTE Band 38 16QAM 10MHz CH-Low, 1 RB

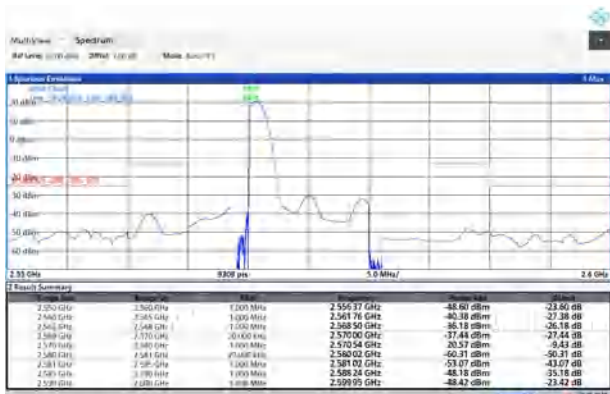

14.07.07 17.01.2022

LTE Band 38 16QAM 10MHz CH-High, 1 RB

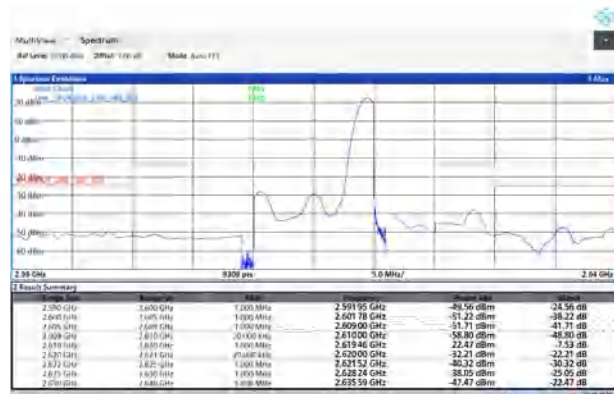

14.03.07 17.01.2022



LTE Band 38 16QAM 10MHz CH-Low, 100%RB

LTE Band 38 16QAM 10MHz CH-High, 100%RB

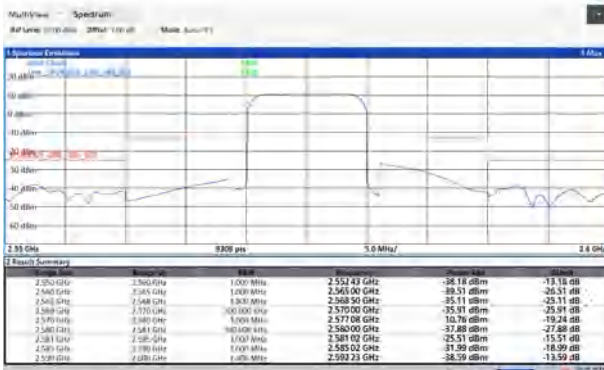

14:28:43 27.01.2022

14:33:37 27.01.2022

LTE Band 38 16QAM 15MHz CH-Low, 1 RB

LTE Band 38 16QAM 15MHz CH-High, 1 RB



14:38:34 27.01.2022

14:41:42 27.01.2022

LTE Band 38 16QAM 15MHz CH-Low, 100%RB

LTE Band 38 16QAM 15MHz CH-High, 100%RB

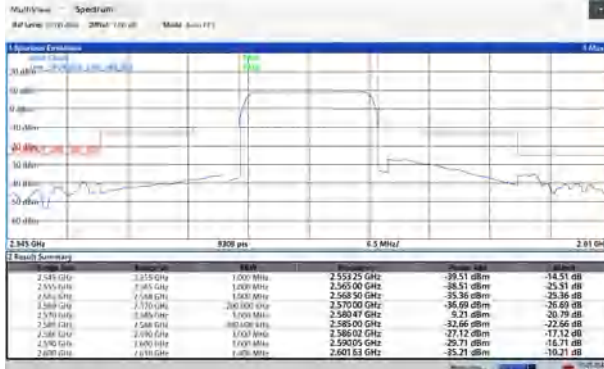

14:34:32 27.01.2022

14:41:18 27.01.2022



### LTE Band 38 16QAM 20MHz CH-Low, 1 RB



11:29:01 30.01.2022

### LTE Band 38 16QAM 20MHz CH-High, 1 RB

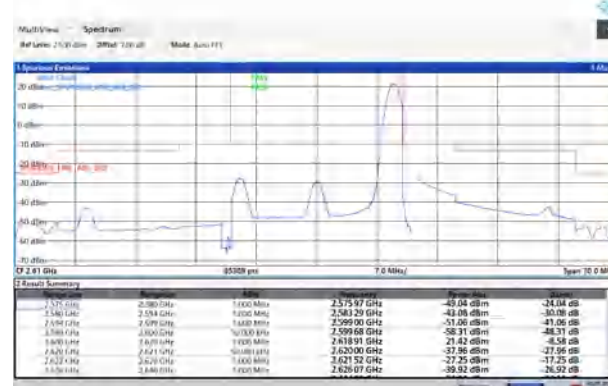

11:37:00 30.01.2022

### LTE Band 38 16QAM 20MHz CH-Low, 100% RB



11:31:18 30.01.2022

### LTE Band 38 16QAM 20MHz CH-High, 100% RB



11:41:03 30.01.2022

### 5.4 Peak-to-Average Power Ratio (PAPR)

#### Ambient condition

Temperature	Relative humidity	Pressure
23°C ~25°C	45%~50%	101.5kPa

#### Methods of Measurement

Measure the total peak power and record as PPk. And measure the total average power and record as PAvg. Both the peak and average power levels must be expressed in the same logarithmic units (e.g., dBm). Determine the PAPR from:

$$PAPR (dB) = PPk (dBm) - PAvg (dBm).$$

#### Test Setup

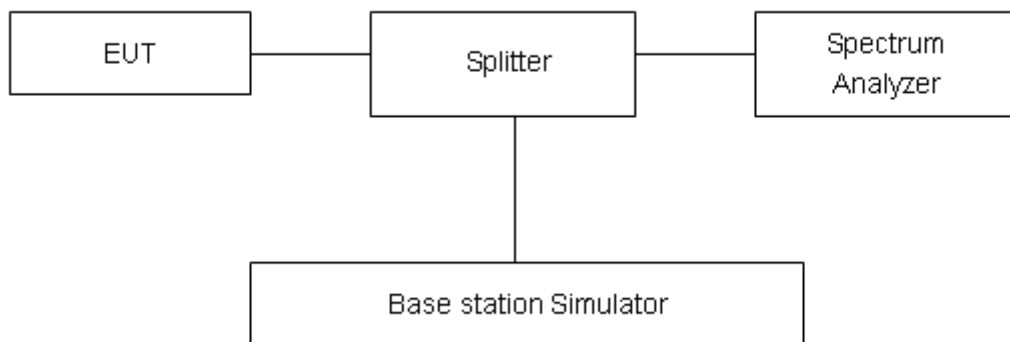

#### Limits

Rule Part 27.50(d)(5) Equipment employed must be authorized in accordance with the provisions of 24.51. Power measurements for transmissions by stations authorized under this section may be made either in accordance with a Commission-approved average power technique or in compliance with paragraph (d)(6) of this section. In measuring transmissions in this band using an average power technique, the peak-to-average ratio (PAR) of the transmission may not exceed 13 dB.

#### Measurement Uncertainty

The assessed measurement uncertainty to ensure 95% confidence level for the normal distribution is with the coverage factor  $k = 2$ ,  $U = 0.4$  dB.



## Test Results

LTE Band 7								
Modulation	Bandwidth (MHz)	Channel	Frequency (MHz)	Peak (dBm)	Avg (dBm)	PAPR (dB)	Limit (dB)	Conclusion
QPSK	5	20775	2502.5	26.30	21.60	4.70	≤13	PASS
		21100	2535	26.58	21.59	4.99	≤13	PASS
		21425	2567.5	26.12	20.92	5.20	≤13	PASS
	10	20800	2505	25.95	20.93	5.02	≤13	PASS
		21100	2535	26.30	21.20	5.10	≤13	PASS
		21400	2565	25.77	20.50	5.27	≤13	PASS
	15	20825	2507.5	26.64	21.15	5.49	≤13	PASS
		21100	2535	26.93	21.44	5.49	≤13	PASS
		21375	2562.5	26.38	20.83	5.55	≤13	PASS
	20	20850	2510	26.55	21.21	5.34	≤13	PASS
		21100	2535	26.86	21.53	5.33	≤13	PASS
		21350	2560	26.31	21.02	5.29	≤13	PASS
16QAM	5	20775	2502.5	25.86	20.19	5.67	≤13	PASS
		21100	2535	26.35	20.55	5.80	≤13	PASS
		21425	2567.5	25.94	19.95	5.99	≤13	PASS
	10	20800	2505	25.68	19.83	5.85	≤13	PASS
		21100	2535	26.16	20.20	5.96	≤13	PASS
		21400	2565	25.64	19.54	6.10	≤13	PASS
	15	20825	2507.5	26.11	20.03	6.08	≤13	PASS
		21100	2535	26.43	20.34	6.09	≤13	PASS
		21375	2562.5	25.97	19.83	6.14	≤13	PASS
	20	20850	2510	26.35	20.25	6.10	≤13	PASS
		21100	2535	26.49	20.37	6.12	≤13	PASS
		21350	2560	26.09	20.02	6.07	≤13	PASS





LTE Band 38								
Modulation	Bandwidth (MHz)	Channel	Frequency (MHz)	Peak (dBm)	Avg (dBm)	PAPR (dB)	Limit (dB)	Conclusion
QPSK	5	37775	2572.5	26.78	17.31	9.47	≤13	PASS
		38000	2595	26.92	17.65	9.27	≤13	PASS
		38225	2617.5	26.89	18.69	8.20	≤13	PASS
	10	37800	2575	26.85	18.18	8.67	≤13	PASS
		38000	2595	26.69	16.17	10.52	≤13	PASS
		38200	2615	26.95	18.82	8.13	≤13	PASS
	15	37825	2577.5	27.12	17.81	9.31	≤13	PASS
		38000	2595	27.16	17.88	9.28	≤13	PASS
		38175	2612.5	27.08	17.29	9.79	≤13	PASS
	20	37850	2580	26.74	17.41	9.33	≤13	PASS
		38000	2595	26.92	18.03	8.89	≤13	PASS
		38150	2610	27.04	18.18	8.86	≤13	PASS
16QAM	5	37775	2572.5	26.52	17.14	9.38	≤13	PASS
		38000	2595	26.50	15.68	10.82	≤13	PASS
		38225	2617.5	26.64	17.52	9.12	≤13	PASS
	10	37800	2575	26.49	15.97	10.52	≤13	PASS
		38000	2595	26.55	17.06	9.49	≤13	PASS
		38200	2615	26.73	17.45	9.28	≤13	PASS
	15	37825	2577.5	26.77	17.70	9.07	≤13	PASS
		38000	2595	26.89	17.83	9.06	≤13	PASS
		38175	2612.5	26.77	17.16	9.61	≤13	PASS
	20	37850	2580	26.48	16.14	10.34	≤13	PASS
		38000	2595	26.56	16.59	9.97	≤13	PASS
		38150	2610	26.84	17.75	9.09	≤13	PASS

## 5.5 Frequency Stability

### Ambient condition

Temperature	Relative humidity	Pressure
23°C ~25°C	45%~50%	101.5kPa

### Method of Measurement

#### Frequency Stability (Temperature Variation)

The temperature inside the climate chamber is varied from 0°C to +35°C in 10°C step size.

(1)With all power removed, the temperature was decreased to -10°C and permitted to stabilize for three hours.

(2)Measure the carrier frequency with the test equipment in a “call mode”. These measurements should be made within 1 minute of powering up the mobile station, to prevent significant self warming.

(3) Repeat the above measurements at 10°C increments from 0°C to +35°C. Allow at least 1.5 hours at each temperature, un-powered, before making measurements.

#### Frequency Stability (Voltage Variation)

The frequency stability shall be measured with variation of primary supply voltage as follows:

**Primary Supply Voltage:** The primary supply voltage is varied from 85% to 115% of the nominal value for non hand-carried battery and AC powered equipment. For hand-carried, battery-powered equipment, primary supply voltage is reduced to the battery operating end point which shall be specified by the manufacturer.

This transceiver is specified to operate with an input voltage of between 3.60 V and 4.45 V, with a nominal voltage of 3.87V.

### Test setup

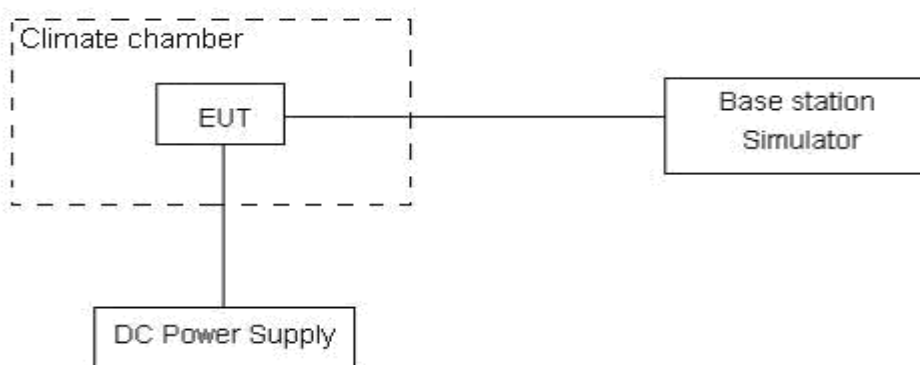

### Limits

The frequency stability shall be sufficient to ensure that the fundamental emissions stay within the authorized bands of operation.

### Measurement Uncertainty

The assessed measurement uncertainty to ensure 99.75% confidence level for the normal distribution is with the coverage factor  $k = 3, U=0.01\text{ppm}$ .



## Test Result

LTE Band 7						
Condition		Freq.Error (Hz)	Freq.Error (Hz)	Frequency Stability (ppm)	Frequency Stability (ppm)	Verdict
BANDWIDTH	5MHz					
Temperature	Voltage	16QAM	QPSK	16QAM	QPSK	
Normal (25°C)	Normal	11.56	6.59	0.00456	0.00260	PASS
Extreme (35°C)		11.10	6.41	0.00438	0.00253	PASS
Extreme (30°C)		17.92	4.45	0.00707	0.00176	PASS
Extreme (20°C)		10.87	17.26	0.00429	0.00681	PASS
Extreme (10°C)		6.02	6.69	0.00237	0.00264	PASS
Extreme (0°C)		3.59	14.20	0.00142	0.00560	PASS
25°C	LV	16.46	1.60	0.00649	0.00063	PASS
	HV	5.13	17.35	0.00202	0.00684	PASS
Condition		Freq.Error (Hz)	Freq.Error (Hz)	Frequency Stability (ppm)	Frequency Stability (ppm)	Verdict
BANDWIDTH	10MHz					
Temperature	Voltage	16QAM	QPSK	16QAM	QPSK	
Normal (25°C)	Normal	13.05	2.75	0.00515	0.00108	PASS
Extreme (35°C)		5.66	7.98	0.00223	0.00315	PASS
Extreme (30°C)		6.44	12.08	0.00254	0.00477	PASS
Extreme (20°C)		11.41	6.99	0.00450	0.00276	PASS
Extreme (10°C)		2.92	4.72	0.00115	0.00186	PASS
Extreme (0°C)		4.78	16.36	0.00189	0.00645	PASS
25°C	LV	6.69	11.27	0.00264	0.00444	PASS
	HV	4.48	8.28	0.00177	0.00327	PASS
Condition		Freq.Error (Hz)	Freq.Error (Hz)	Frequency Stability (ppm)	Frequency Stability (ppm)	Verdict
BANDWIDTH	15MHz					
Temperature	Voltage	16QAM	QPSK	16QAM	QPSK	
Normal (25°C)	Normal	12.13	16.96	0.00478	0.00669	PASS
Extreme (35°C)		15.33	1.96	0.00605	0.00077	PASS
Extreme (30°C)		15.64	8.81	0.00617	0.00348	PASS
Extreme (20°C)		10.56	12.04	0.00417	0.00475	PASS
Extreme (10°C)		9.31	3.56	0.00367	0.00141	PASS
Extreme (0°C)		6.17	17.21	0.00243	0.00679	PASS
25°C	LV	15.05	3.35	0.00594	0.00132	PASS
	HV	8.85	16.44	0.00349	0.00649	PASS
Condition		Freq.Error (Hz)	Freq.Error (Hz)	Frequency Stability (ppm)	Frequency Stability (ppm)	Verdict
BANDWIDTH	20MHz					
Temperature	Voltage	16QAM	QPSK	16QAM	QPSK	
Normal (25°C)	Normal	5.63	13.65	0.00222	0.00538	PASS



Extreme (35°C)		14.69	17.19	0.00579	0.00678	PASS
Extreme (30°C)		4.35	4.62	0.00171	0.00182	PASS
Extreme (20°C)		4.46	10.09	0.00176	0.00398	PASS
Extreme (10°C)		13.47	2.20	0.00531	0.00087	PASS
Extreme (0°C)		12.73	4.57	0.00502	0.00180	PASS
25°C	LV	13.16	3.52	0.00519	0.00139	PASS
	HV	14.35	2.68	0.00566	0.00106	PASS

LTE Band 38						
Condition		Freq.Error (Hz)	Freq.Error (Hz)	Frequency Stability (ppm)	Frequency Stability (ppm)	Verdict
BANDWIDTH	5MHz					
Temperature	Voltage	16QAM	QPSK	16QAM	QPSK	
Normal (25°C)	Normal	7.79	13.56	0.00300	0.00523	PASS
Extreme (35°C)		1.61	10.20	0.00062	0.00393	PASS
Extreme (30°C)		12.59	17.72	0.00485	0.00683	PASS
Extreme (20°C)		4.92	16.61	0.00190	0.00640	PASS
Extreme (10°C)		15.95	14.70	0.00615	0.00566	PASS
Extreme (0°C)		10.51	11.39	0.00405	0.00439	PASS
25°C	LV	14.85	11.86	0.00572	0.00457	PASS
	HV	6.52	8.79	0.00251	0.00339	PASS
Condition		Freq.Error (Hz)	Freq.Error (Hz)	Frequency Stability (ppm)	Frequency Stability (ppm)	Verdict
BANDWIDTH	10MHz					
Temperature	Voltage	16QAM	QPSK	16QAM	QPSK	
Normal (25°C)	Normal	16.64	10.61	0.00641	0.00409	PASS
Extreme (35°C)		7.07	1.78	0.00272	0.00068	PASS
Extreme (30°C)		15.42	12.34	0.00594	0.00475	PASS
Extreme (20°C)		9.42	15.09	0.00363	0.00581	PASS
Extreme (10°C)		9.63	5.58	0.00371	0.00215	PASS
Extreme (0°C)		10.03	11.72	0.00386	0.00452	PASS
25°C	LV	5.78	1.17	0.00223	0.00045	PASS
	HV	12.72	17.30	0.00490	0.00667	PASS
Condition		Freq.Error (Hz)	Freq.Error (Hz)	Frequency Stability (ppm)	Frequency Stability (ppm)	Verdict
BANDWIDTH	15MHz					
Temperature	Voltage	16QAM	QPSK	16QAM	QPSK	
Normal (25°C)	Normal	14.39	1.73	0.00554	0.00066	PASS
Extreme (35°C)		1.68	13.46	0.00065	0.00519	PASS
Extreme (30°C)		11.97	10.68	0.00461	0.00412	PASS
Extreme (20°C)		8.34	14.37	0.00321	0.00554	PASS
Extreme (10°C)		10.21	15.54	0.00393	0.00599	PASS
Extreme (0°C)		1.15	14.09	0.00044	0.00543	PASS



25°C	LV	2.76	2.67	0.00106	0.00103	PASS
	HV	14.76	2.48	0.00569	0.00096	PASS
Condition		Freq.Error (Hz)	Freq.Error (Hz)	Frequency Stability (ppm)	Frequency Stability (ppm)	Verdict
BANDWIDTH	20MHz					
Temperature	Voltage	16QAM	QPSK	16QAM	QPSK	
Normal (25°C)	Normal	1.00	2.92	0.00039	0.00113	PASS
Extreme (35°C)		15.00	17.27	0.00578	0.00666	PASS
Extreme (30°C)		16.00	6.78	0.00617	0.00261	PASS
Extreme (20°C)		2.00	14.42	0.00077	0.00556	PASS
Extreme (10°C)		1.00	11.06	0.00039	0.00426	PASS
Extreme (0°C)		6.00	12.05	0.00231	0.00465	PASS
25°C	LV	17.00	2.93	0.00655	0.00113	PASS
	HV	13.00	16.32	0.00501	0.00629	PASS

## 5.6 Spurious Emissions at Antenna Terminals

### Ambient condition

Temperature	Relative humidity	Pressure
23°C ~25°C	45%~50%	101.5kPa

### Method of Measurement

The EUT was connected to Spectrum Analyzer and Base Station Simulator via power Splitter. The measurement is carried out using a spectrum analyzer. The spectrum analyzer scans from 9kHz to the 10th harmonic of the carrier. The peak detector is used.

RBW is set to 100kHz, VBW is set to 300kHz for 30MHz~1GHz

RBW is set to 1MHz, VBW is set to 3MHz for above 1GHz, Sweep is set to ATUO.

RBW is set to 1 kHz (0.009MHz~ 0.15 MHz),

RBW is set to 10 kHz (0.15 MHz~ 30 MHz)

RBW is set to 100 kHz (30MHz~1000 MHz)

RBW is set to 1000 kHz (above 1000MHz)

Of those disturbances below (limit – 20 dB), the mark is not required for the EUT.

The modulation mode and RB allocation refer to section 5.1, using the maximum output power configuration.

### Test setup

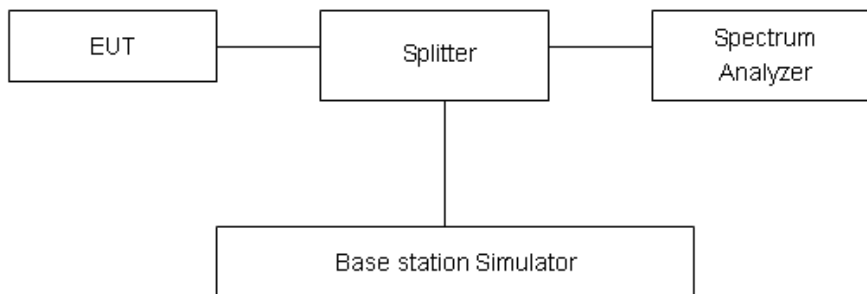

### Limits

Rule Part 27.53(m)  $55 + 10 \log (P)$  dB on all frequencies more than X megahertz from the channel edge, where X is the greater of 6 megahertz or the actual emission bandwidth as defined in paragraph (m)(4) of this section.

Part 27.53(m) Limit	-25 dBm
---------------------	---------

**Measurement Uncertainty**

The assessed measurement uncertainty to ensure 99.75% confidence level for the normal distribution is with the coverage factor  $k = 1.96$ .

Frequency	Uncertainty
9kHz-1GHz	0.684 dB
1GHz-30GHz	1.407 dB

**Test Result**

Sweep the whole frequency band through the range from 9kHz to the 10th harmonic of the carrier, the emissions more than 20 dB below the limit are not reported.

The signal beyond the limit is carrier.

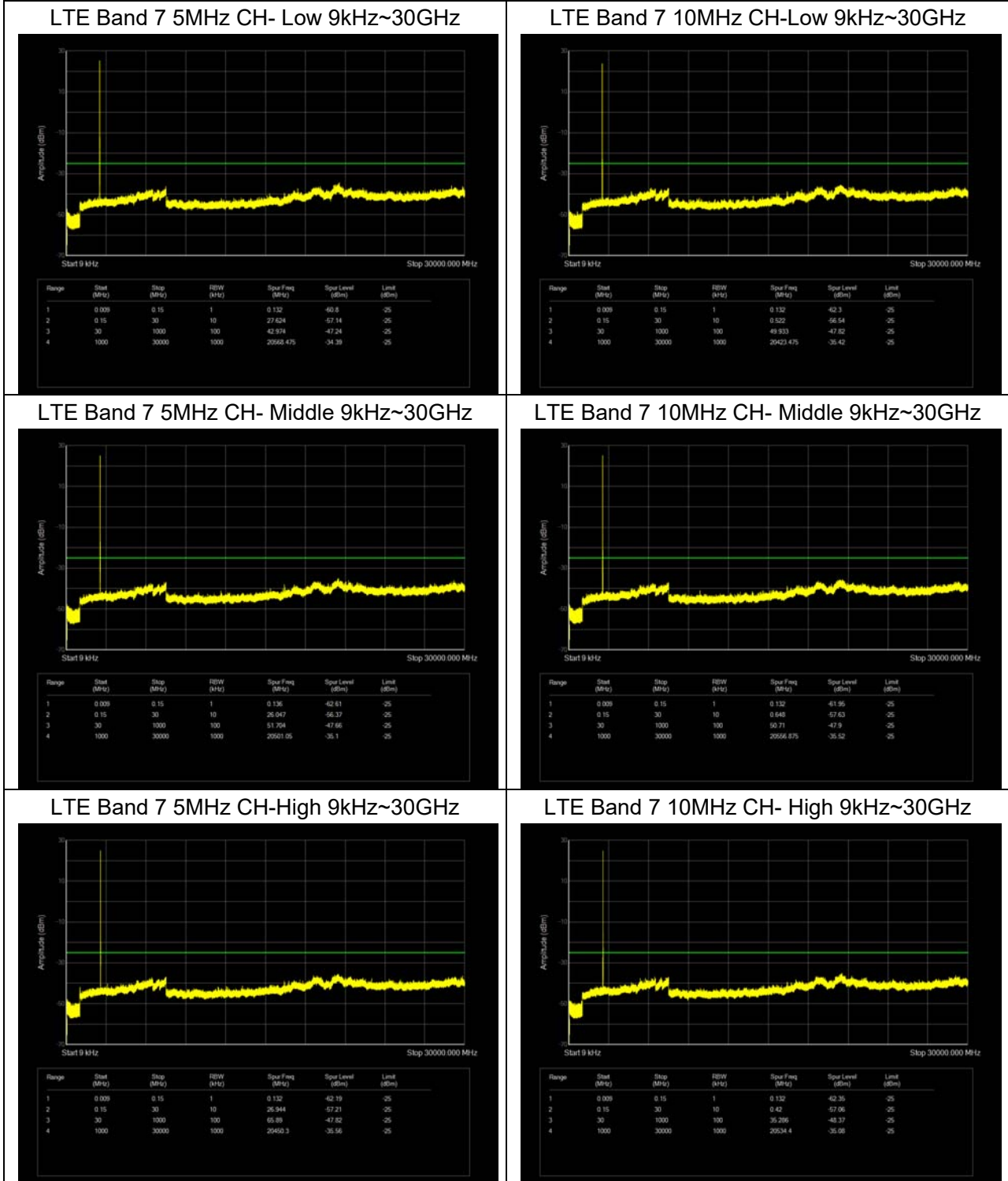





LTE Band 7 15MHz CH- Low 9kHz~30GHz

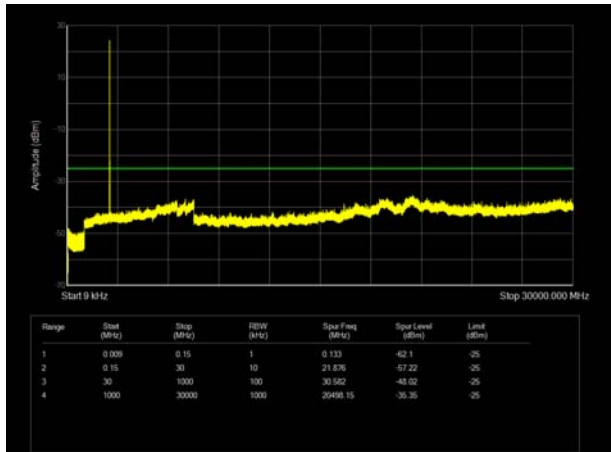

LTE Band 7 20MHz CH-Low 9kHz~30GHz

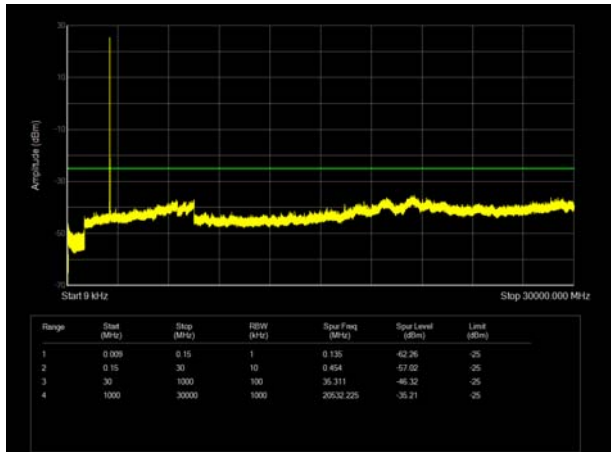

LTE Band 7 15MHz CH- Middle 9kHz~30GHz

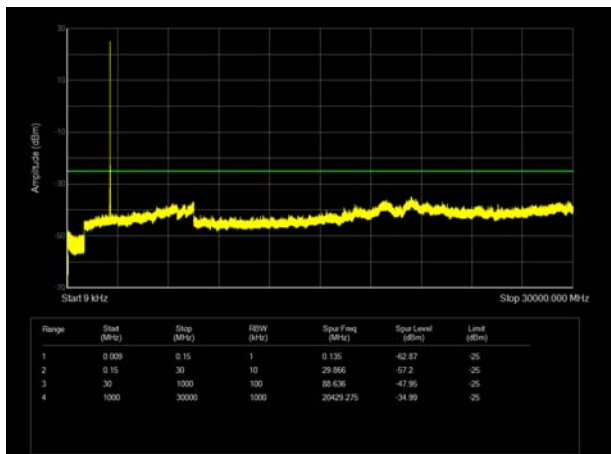

LTE Band 7 20MHz CH- Middle 9kHz~30GHz

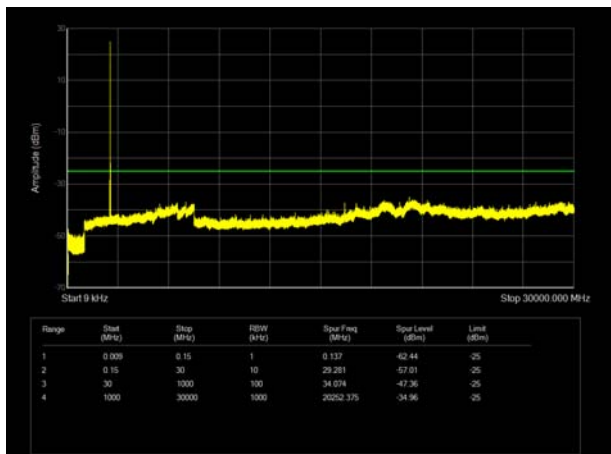

LTE Band 7 15MHz CH-High 9kHz~30GHz

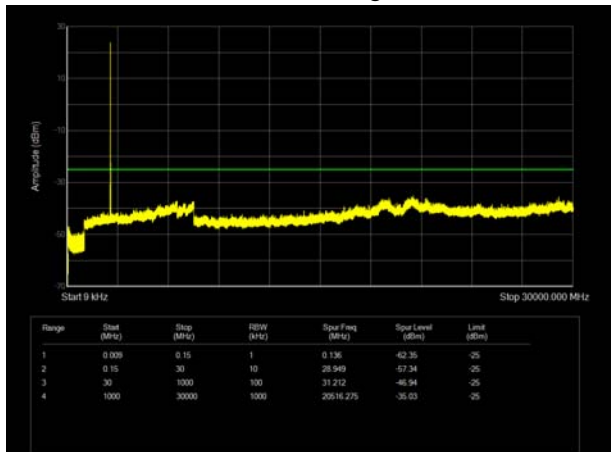

LTE Band 7 20MHz CH- High 9kHz~30GHz

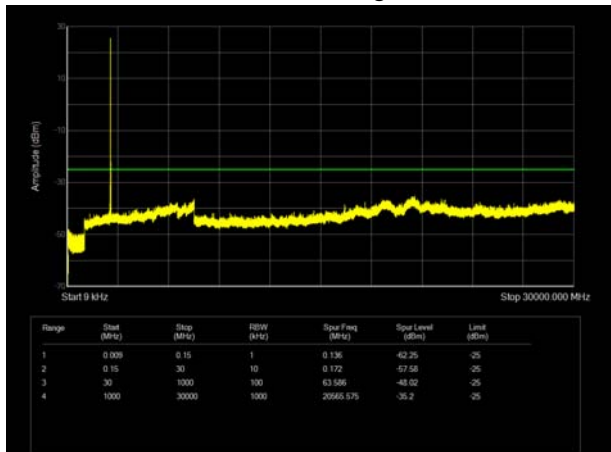



LTE Band 38 5MHz CH-Low 9kHz~30GHz

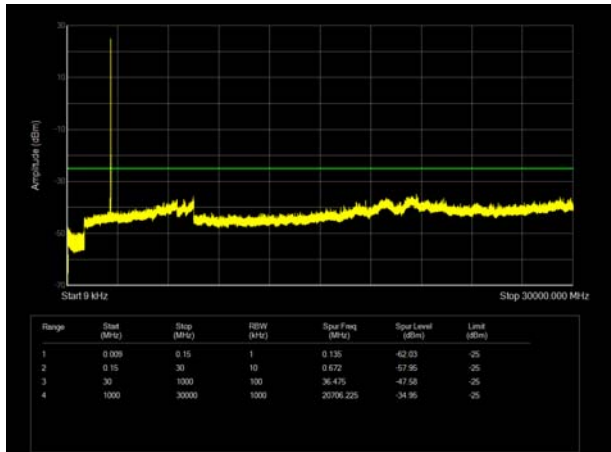

LTE Band 38 10MHz CH- Low 9kHz~30GHz

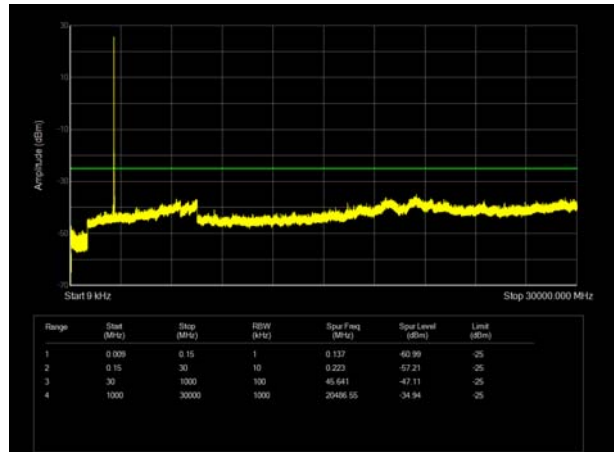

LTE Band 38 5MHz CH- Middle 9kHz~30GHz

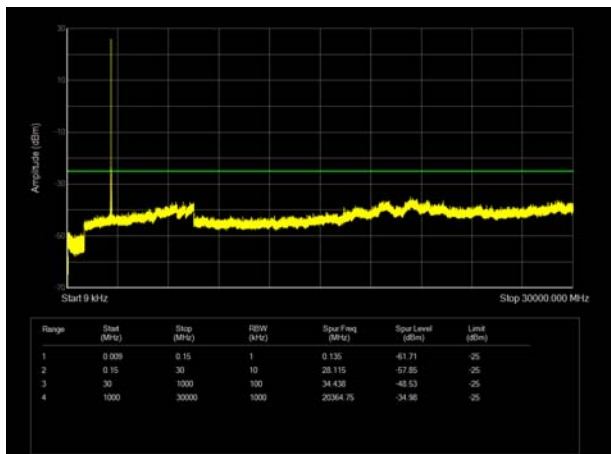

LTE Band 38 10MHz CH- Middle 9kHz~30GHz

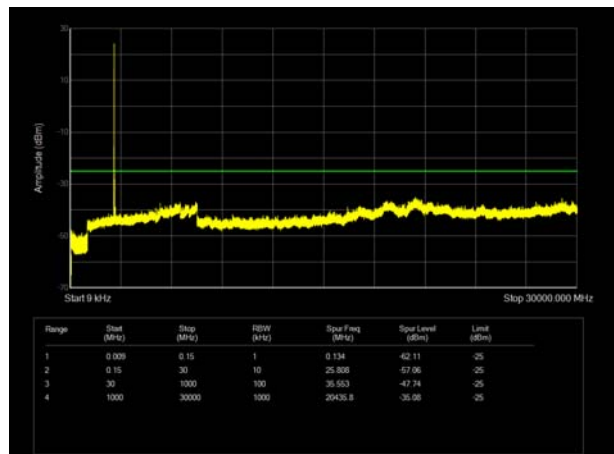

LTE Band 38 5MHz CH- High 9kHz~30GHz

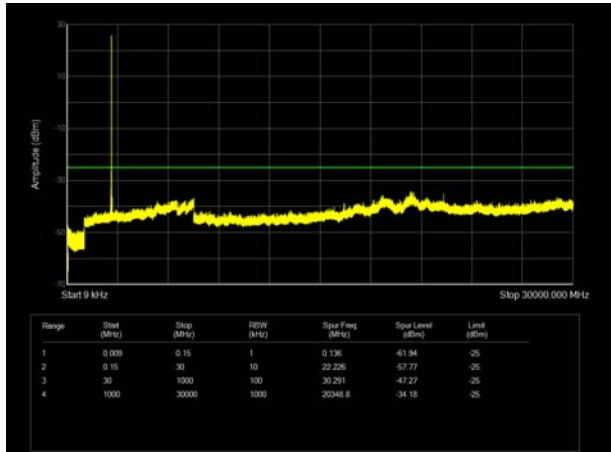

LTE Band 38 10MHz CH-High 9kHz~30GHz

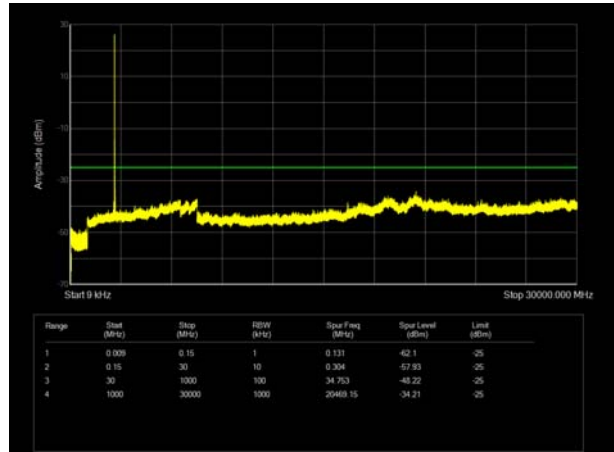



LTE Band 38 15MHz CH- Low 9kHz~30GHz

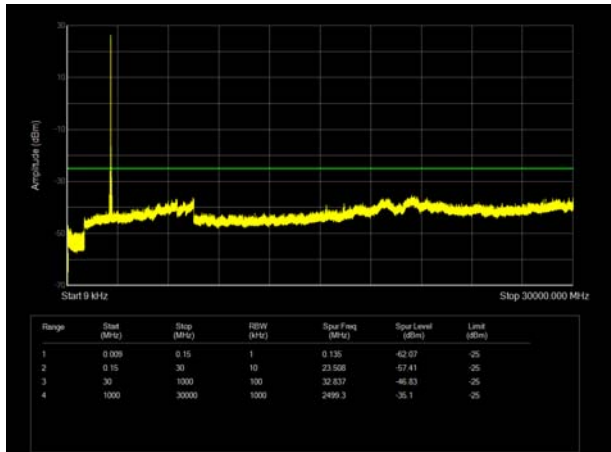

LTE Band 38 20MHz CH-Low 9kHz~30GHz

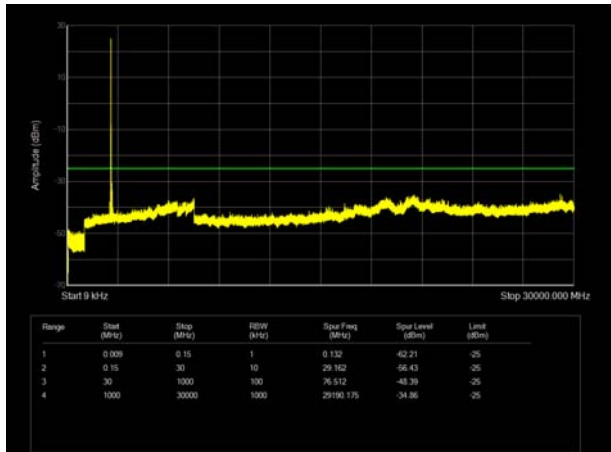

LTE Band 38 15MHz CH- Middle 9kHz~30GHz

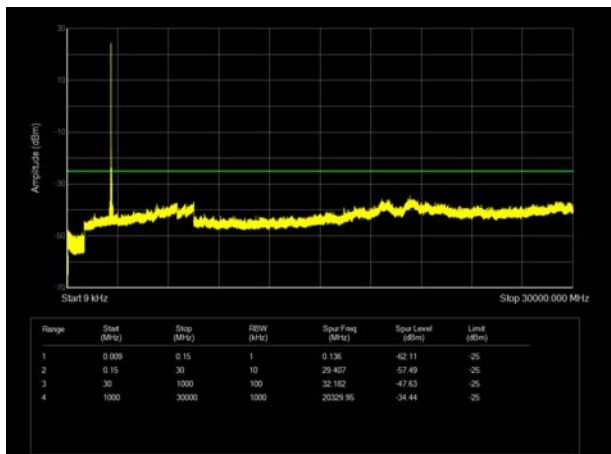

LTE Band 38 20MHz CH- Middle 9kHz~30GHz

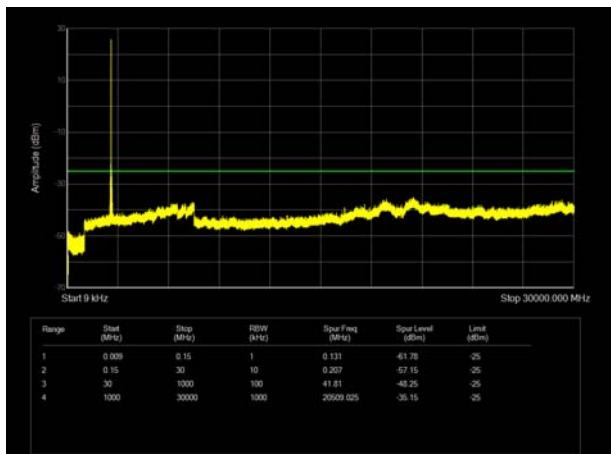

LTE Band 38 15MHz CH-High 9kHz~30GHz

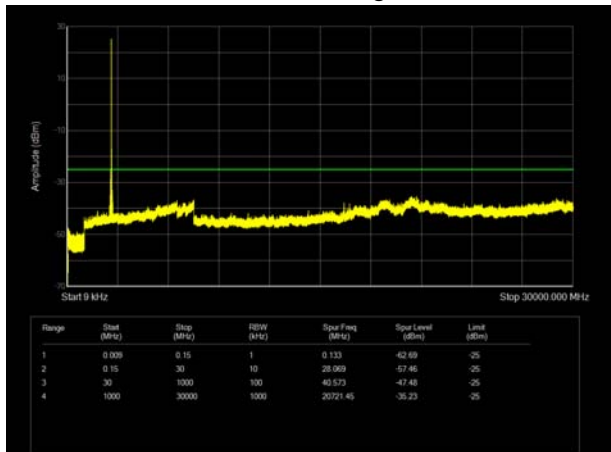

LTE Band 38 20MHz CH- High 9kHz~30GHz

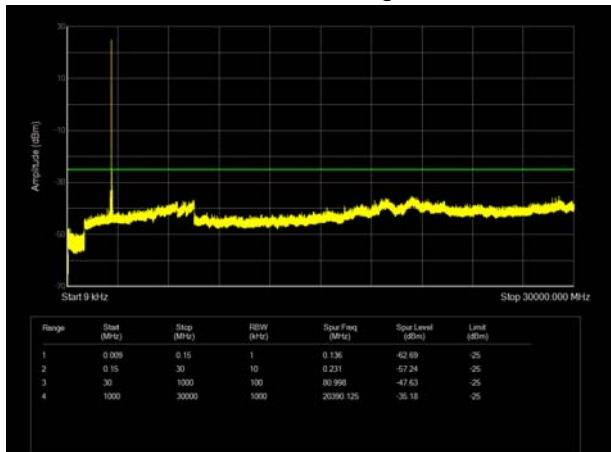

## 5.7 Radiates Spurious Emission

### Ambient condition

Temperature	Relative humidity	Pressure
23°C ~25°C	45%~50%	101.5kPa

### Method of Measurement

1. The testing follows FCC KDB 971168 D01 v03r01 Section 5.8 and ANSI C63.26 (2015).
2. Below 1GHz: The EUT is placed on a turntable 0.8 meters above the ground in the chamber, 3 meter away from the antenna. The maximal emission value is acquired by adjusting the antenna height, polarisation and turntable azimuth. Normally, the height range of antenna is 1 m to 4 m, the azimuth range of turntable is 0° to 360°, and the receive antenna has two polarizations Vertical (V) and Horizontal (H). Above 1GHz: (Note: the FCC's permission to use 1.5m as an alternative per TCBC Conf call of Dec. 2, 2014.) The EUT is placed on a turntable 1.5 meters above the ground in the chamber, 3 meter away from the antenna. The maximal emission value is acquired by adjusting the antenna height, polarisation and turntable azimuth. Normally, the height range of antenna is 1 m to 4 m, the azimuth range of turntable is 0° to 360°, and the receive antenna has two polarizations Vertical (V) and Horizontal (H).
3. A loop antenna, A log-periodic antenna or horn antenna shall be substituted in place of the EUT. The log-periodic antenna will be driven by a signal generator and the level will be adjusted till the same power value on the spectrum analyzer or receiver. The level of the spurious emissions can be calculated through the level of the signal generator, cable loss, the gain of the substitution antenna and the reading of the spectrum analyzer or receiver.
4. The EUT is then put into continuously transmitting mode at its maximum power level during the test. Set Test Receiver or Spectrum RBW=100kHz, VBW=300kHz for 30MHz to 1GHz and RBW=1MHz, VBW=3MHz for above 1GHz, and the maximum value of the receiver should be recorded as (Pr).
5. The EUT shall be replaced by a substitution antenna. In the chamber, an substitution antenna for the frequency band of interest is placed at the reference point of the chamber. An RF Signal source for the frequency band of interest is connected to the substitution antenna with a cable that has been constructed to not interfere with the radiation pattern of the antenna. A power (PMea) is applied to the input of the substitution antenna, and adjust the level of the signal generator output until the value of the receiver reach the previously recorded (Pr). The power of signal source (PMea) is recorded. The test should be performed by rotating the test item and adjusting the receiving antenna polarization.
6. A amplifier should be connected to the Signal Source output port. And the cable should be connect between the Amplifier and the Substitution Antenna. The cable loss (Pcl) ,the Substitution Antenna Gain (Ga) and the Amplifier Gain (PAg) should be recorded after test.
7. The measurement results are obtained as described below:  
Power(EIRP)=PMea- PAg - Pcl + Ga  
The measurement results are amend as described below:  
Power(EIRP)=PMea- Pcl + Ga
8. This value is EIRP since the measurement is calibrated using an antenna of known gain (2.15 dB) and known input power. ERP can be calculated from EIRP by subtracting the gain of the dipole, ERP = EIRP-2.15dB.

The modulation mode and RB allocation refer to section 5.1, using the maximum output power configuration.

**Test setup**

**9KHz ~ 30MHz**

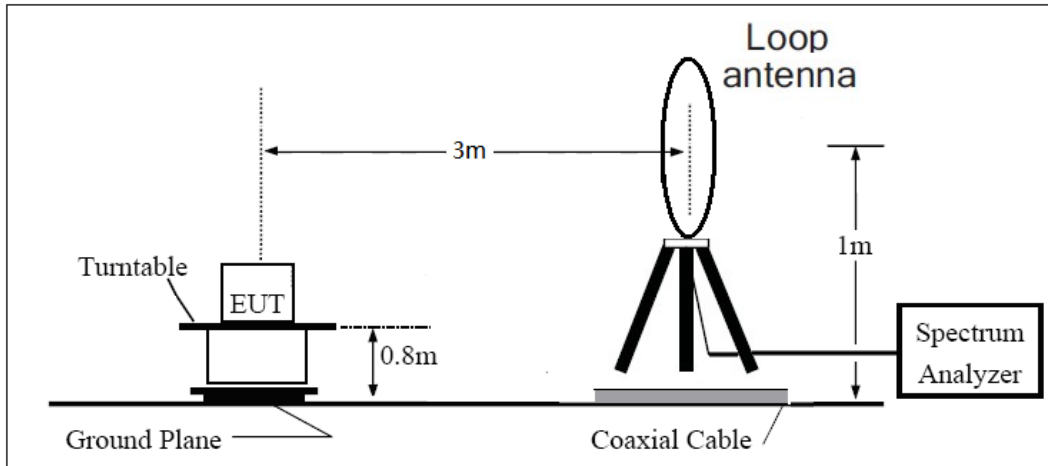

**30MHz ~ 1GHz**

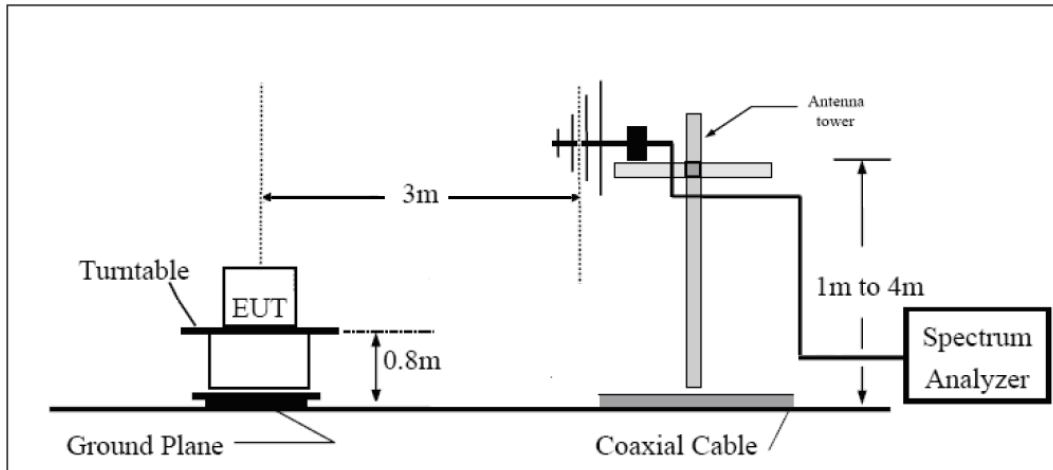

**Above 1GHz**

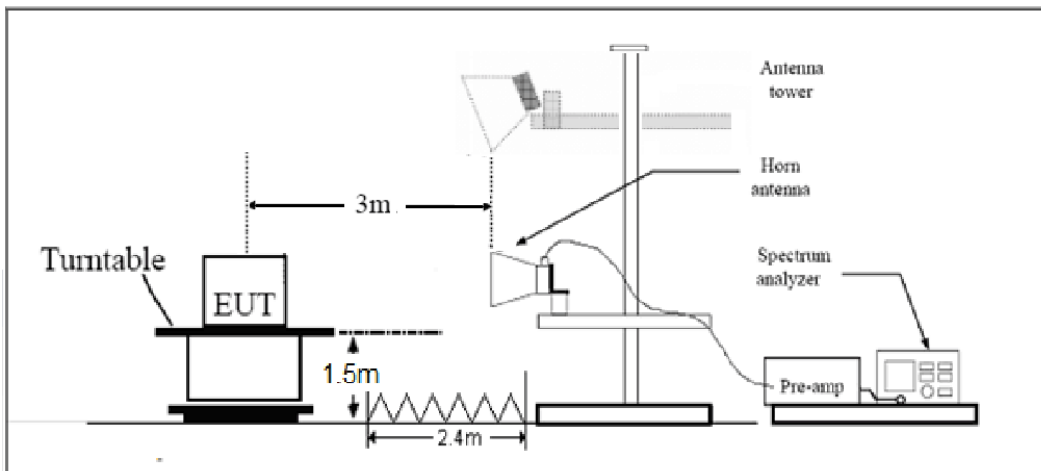

Note: Area side:2.4mX3.6m

**Limits**



Rule Part 27.53(m)  $55 + 10 \log (P)$  dB on all frequencies more than X megahertz from the channel edge, where X is the greater of 6 megahertz or the actual emission bandwidth as defined in paragraph (m)(4) of this section.

Part 27.53(m) Limit	-25 dBm
---------------------	---------

**Measurement Uncertainty**

The assessed measurement uncertainty to ensure 95% confidence level for the normal distribution is with the coverage factor  $k = \pm 1.96$ ,  $U = \pm 3.55$  dB.

**Test Result**

Sweep the whole frequency band through the range from 9kHz to the 10th harmonic of the carrier, the emissions below the noise floor will not be recorded in the report.

**Main Antenna**

LTE Band 7 QPSK 5MHz CH-Middle, RB 1

Harmonic	Frequency (MHz)	SG (dBm)	Cable Loss (dB)	Gain (dBi)	Antenna Polarization	EIRP Level (dBm)	Limit (dBm)	Margin (dB)	Azimuth (deg)
2	5065.80	-60.36	3.40	12.50	Horizontal	-51.26	-25.00	26.26	225
3	7598.60	-57.06	4.40	12.20	Horizontal	-49.26	-25.00	24.26	45
4	10130.63	-51.16	4.70	11.30	Horizontal	-44.56	-25.00	19.56	0
5	12675.00	-52.33	5.40	13.20	Horizontal	-44.53	-25.00	19.53	135
6	15210.00	-48.38	6.10	13.10	Horizontal	-41.38	-25.00	16.38	225
7	17745.00	-51.11	6.10	14.20	Horizontal	-43.01	-25.00	18.01	225
8	20280.00	--	--	--	--	--	--	--	--
9	22815.00	--	--	--	--	--	--	--	--
10	25350.00	--	--	--	--	--	--	--	--

Note: 1.The other Spurious RF Radiated emissions level is no more than noise floor.

2. The worst emission was found in the antenna is Horizontal position.

LTE Band 7 QPSK 20MHz CH-Middle, RB 1

Harmonic	Frequency (MHz)	SG (dBm)	Cable Loss (dB)	Gain (dBi)	Antenna Polarization	EIRP Level (dBm)	Limit (dBm)	Margin (dB)	Azimuth (deg)
2	5052.38	-60.59	3.40	12.50	Horizontal	-51.49	-25.00	26.49	45
3	7578.00	-57.73	4.40	12.20	Horizontal	-49.93	-25.00	24.93	0
4	10104.00	-52.66	4.70	11.30	Horizontal	-46.06	-25.00	21.06	45
5	12675.00	-51.17	5.40	13.20	Horizontal	-43.37	-25.00	18.37	180
6	15210.00	-48.23	6.10	13.10	Horizontal	-41.23	-25.00	16.23	315
7	17745.00	-50.66	6.10	14.20	Horizontal	-42.56	-25.00	17.56	45
8	20280.00	--	--	--	--	/	-25.00	/	/
9	22815.00	--	--	--	--	/	-25.00	/	/
10	25350.00	--	--	--	--	/	-25.00	/	/

Note: 1.The other Spurious RF Radiated emissions level is no more than noise floor.

2. The worst emission was found in the antenna is Horizontal position.



## LTE Band 38 QPSK 5MHz CH-Middle, RB 1

Harmonic	Frequency (MHz)	SG (dBm)	Cable Loss (dB)	Gain (dBi)	Antenna Polarization	EIRP Level (dBm)	Limit (dBm)	Margin (dB)	Azimuth (deg)
2	5185.00	-61.83	3.20	12.50	Horizontal	-52.53	-25.00	27.53	225
3	7777.50	-59.18	4.40	12.30	Horizontal	-51.28	-25.00	26.28	45
4	10370.00	-52.96	4.70	11.80	Horizontal	-45.86	-25.00	20.86	270
5	12962.50	-52.95	5.40	14.00	Horizontal	-44.35	-25.00	19.35	0
6	15555.00	-54.78	6.10	16.80	Horizontal	-44.08	-25.00	19.08	225
7	18147.50	--	--	--	--	/	-25.00	/	/
8	20740.00	--	--	--	--	/	-25.00	/	/
9	23332.50	--	--	--	--	/	-25.00	/	/
10	25925.00	--	--	--	--	/	-25.00	/	/

Note: 1.The other Spurious RF Radiated emissions level is no more than noise floor.

2. The worst emission was found in the antenna is Horizontal position.

## LTE Band 38 QPSK 20MHz CH-Middle, RB 1

Harmonic	Frequency (MHz)	SG (dBm)	Cable Loss (dB)	Gain (dBi)	Antenna Polarization	EIRP Level (dBm)	Limit (dBm)	Margin (dB)	Azimuth (deg)
2	5170.00	-61.35	3.20	12.50	Horizontal	-52.05	-25.00	27.05	315
3	7755.00	-58.12	4.40	12.30	Horizontal	-50.22	-25.00	25.22	270
4	10340.00	-51.48	4.70	11.80	Horizontal	-44.38	-25.00	19.38	45
5	12925.00	-53.46	5.40	14.00	Horizontal	-44.86	-25.00	19.86	315
6	15510.00	-54.44	6.10	16.80	Horizontal	-43.74	-25.00	18.74	315
7	18095.00	--	--	--	--	/	-25.00	/	/
8	20680.00	--	--	--	--	/	-25.00	/	/
9	23265.00	--	--	--	--	/	-25.00	/	/
10	25850.00	--	--	--	--	/	-25.00	/	/

Note: 1.The other Spurious RF Radiated emissions level is no more than noise floor.

2. The worst emission was found in the antenna is Horizontal position.





## Second Antenna

LTE Band 7 QPSK 5MHz CH-Middle, RB 1

Harmonic	Frequency (MHz)	SG (dBm)	Cable Loss (dB)	Gain (dBi)	Antenna Polarization	EIRP Level (dBm)	Limit (dBm)	Margin (dB)	Azimuth (deg)
2	5065.80	28.80	3.40	12.50	Vertical	37.90	25.00	12.90	135.00
3	7598.60	22.81	4.40	12.20	Vertical	30.61	25.00	5.61	180.00
4	10130.63	31.58	4.70	11.30	Vertical	38.18	25.00	13.18	90.00
5	12675.00	36.47	5.40	13.20	Vertical	44.27	25.00	19.27	45.00
6	15210.00	36.25	6.10	13.10	Vertical	43.25	25.00	18.25	315.00
7	17745.00	35.11	6.10	14.20	Vertical	43.21	25.00	18.21	90.00
8	20280.00	--	--	--	--	/	25.00	/	/
9	22815.00	--	--	--	--	/	25.00	/	/
10	25350.00	--	--	--	--	/	25.00	/	/

Note: 1. The other Spurious RF Radiated emissions level is no more than noise floor.

2. The worst emission was found in the antenna is Vertical position.

LTE Band 7 QPSK 20MHz CH-Middle, RB 1

Harmonic	Frequency (MHz)	SG (dBm)	Cable Loss (dB)	Gain (dBi)	Antenna Polarization	EIRP Level (dBm)	Limit (dBm)	Margin (dB)	Azimuth (deg)
2	5052.38	30.15	3.40	12.50	Vertical	39.25	25.00	14.25	0.00
3	7578.00	22.85	4.40	12.20	Vertical	30.65	25.00	5.65	45.00
4	10104.00	34.13	4.70	11.30	Vertical	40.73	25.00	15.73	180.00
5	12675.00	36.66	5.40	13.20	Vertical	44.46	25.00	19.46	45.00
6	15210.00	34.83	6.10	13.10	Vertical	41.83	25.00	16.83	315.00
7	17745.00	34.52	6.10	14.20	Vertical	42.62	25.00	17.62	180.00
8	20280.00	--	--	--	--	/	25.00	/	/
9	22815.00	--	--	--	--	/	25.00	/	/
10	25350.00	--	--	--	--	/	25.00	/	/

Note: 1. The other Spurious RF Radiated emissions level is no more than noise floor.

2. The worst emission was found in the antenna is Vertical position.



## LTE Band 38 QPSK 5MHz CH-Middle, RB 1

Harmonic	Frequency (MHz)	SG (dBm)	Cable Loss (dB)	Gain (dBi)	Antenna Polarization	EIRP Level (dBm)	Limit (dBm)	Margin (dB)	Azimuth (deg)
2	5185.00	35.61	3.20	12.50	Vertical	44.91	25.00	19.91	270.00
3	7777.50	26.16	4.40	12.30	Vertical	34.06	25.00	9.06	180.00
4	10370.00	33.91	4.70	11.80	Vertical	41.01	25.00	16.01	0.00
5	12962.50	31.73	5.40	14.00	Vertical	40.33	25.00	15.33	45.00
6	15555.00	33.55	6.10	16.80	Vertical	44.25	25.00	19.25	315.00
7	18147.50	--	--	--	--	/	25.00	/	/
8	20740.00	--	--	--	--	/	25.00	/	/
9	23332.50	--	--	--	--	/	25.00	/	/
10	25925.00	--	--	--	--	/	25.00	/	/

Note: 1.The other Spurious RF Radiated emissions level is no more than noise floor.

2. The worst emission was found in the antenna is Vertical position.

## LTE Band 38 QPSK 20MHz CH-Middle, RB 1

Harmonic	Frequency (MHz)	SG (dBm)	Cable Loss (dB)	Gain (dBi)	Antenna Polarization	EIRP Level (dBm)	Limit (dBm)	Margin (dB)	Azimuth (deg)
2	5170.00	30.87	3.20	12.50	Vertical	40.17	25.00	15.17	0.00
3	7755.00	24.22	4.40	12.30	Vertical	32.12	25.00	7.12	45.00
4	10340.00	35.34	4.70	11.80	Vertical	42.44	25.00	17.44	315.00
5	12925.00	35.35	5.40	14.00	Vertical	43.95	25.00	18.95	90.00
6	15510.00	32.24	6.10	16.80	Vertical	42.94	25.00	17.94	225.00
7	18095.00	--	--	--	--	/	25.00	/	/
8	20680.00	--	--	--	--	/	25.00	/	/
9	23265.00	--	--	--	--	/	25.00	/	/
10	25850.00	--	--	--	--	/	25.00	/	/

Note: 1.The other Spurious RF Radiated emissions level is no more than noise floor.

2. The worst emission was found in the antenna is Vertical position.



## 6 Main Test Instruments

Name	Manufacturer	Type	Serial Number	Calibration Date	Expiration Date
Signal Analyzer	R&S	FSV30	104028	2021-05-15	2022-05-14
Loop antenna	SCHWARZBECK	FMZB1519	1519-047	2020-04-02	2023-04-01
TRILOG Broadband Antenna	Schwarzbeck	VULB 9163	01111	2019-09-12	2022-09-11
Horn Antenna	Schwarzbeck	BBHA 9120D	1594	2020-12-17	2023-12-16
Horn Antenna	ETS-Lindgren	3160-09	00102643	2020-10-10	2023-10-09
Software	R&S	EMC32	10.35.10	/	/
Communication tester	Anritsu	MT8821C	6201538758	2021-05-15	2022-05-14
Climate Chamber	WEISS	VT 4002	582261194500 10	2021-05-15	2022-05-14
Climate Chamber	R&S	CMW500	150415	2021-05-15	2022-05-14
Spectrum Analyzer	Keysight	N9020A	MY52330084	2021-05-15	2022-05-14
Wireless Communication Tester	Agilent	E5515C	GB44400275	2021-05-15	2022-05-14
Spectrum Analyzer	R&S	FSV3030	101411	2021-12-12	2022-12-11

\*\*\*\*\*END OF REPORT \*\*\*\*\*



## ANNEX A: The EUT Appearance

The EUT Appearance are submitted separately.



## ANNEX B: Test Setup Photos

The Test Setup Photos are submitted separately.



## **ANNEX C: Product Change Description**

The Product Change Description are submitted separately.