



RF TEST REPORT

Applicant Honor Device Co., Ltd.
FCC ID 2AYGCTFY-LX2
Product Smart Phone
Model TFY-LX2
Report No. R2201A0038-R7
Issue Date February 16, 2022

TA Technology (Shanghai) Co., Ltd. tested the above equipment in accordance with the requirements in **FCC CFR47 Part 15E (2020)**. The test results show that the equipment tested is capable of demonstrating compliance with the requirements as documented in this report.

Prepared by: Peng Tao

Approved by: Kai Xu

TA Technology (Shanghai) Co., Ltd.

No.145, Jintang Rd, Tangzhen Industry Park, Pudong Shanghai, China

TEL: +86-021-50791141/2/3

FAX: +86-021-50791141/2/3-8000



TABLE OF CONTENT

1. Test Laboratory	4
1.1. Notes of the test report.....	4
1.2. Test facility	4
1.3. Testing Location.....	4
2. General Description of Equipment under Test.....	5
2.1. Applicant and Manufacturer Information.....	5
2.2. General information.....	5
3. Applied Standards	7
4. Test Configuration	8
5. Test Case Results	11
5.1. Occupied Bandwidth	11
5.2. Average Power Output.....	31
5.3. Frequency Stability.....	39
5.4. Power Spectral Density.....	43
5.5. Unwanted Emission	62
5.6. Conducted Emission	157
6. Main Test Instruments.....	160
ANNEX A: The EUT Appearance	161
ANNEX B: Test Setup Photos	162
ANNEX C: Product Change Description	163

Summary of measurement results

Number	Test Case	Clause in FCC rules	Verdict
1	Average output power	15.407(a)	PASS
2	Occupied bandwidth	15.407(e)	PASS
3	Frequency stability	15.407(g)	PASS
4	Power spectral density	15.407(a)	PASS
5	Unwanted Emissions	15.407(b)	PASS
6	Conducted Emissions	15.207	PASS
Date of Testing: January 17, 2022 ~ January 20, 2022 and February 15, 2022			
Date of Sample Received: January 10, 2022			
Note: PASS: The EUT complies with the essential requirements in the standard. FAIL: The EUT does not comply with the essential requirements in the standard. All indications of Pass/Fail in this report are opinions expressed by TA Technology (Shanghai) Co., Ltd. based on interpretations and/or observations of test results. Measurement Uncertainties were not taken into account and are published for informational purposes only.			

TFY-LX2 (Report No.: R2201A0038-R7) is a variant model of TFY-LX3 (Report No.: R2201A0036-R7V2). Test values partial duplicated from Original for variant.

There is only tested Unwanted Emissions, and did not worsen, so they were not recorded in the report.

The difference between model TFY-LX3 and model TFY-LX2 is show in the below table:

	Model	TFY-LX3	TFY-LX2
Licensed Frequency	LTE BAND	B2/B4/B5/B7/B13/B26/B38/B66	B5/B7/B38/B41
	UMTS BAND	B2/B4/B5	B2/B5
	Antenna	The antenna matching and routing are the same. The frequency is different.	The antenna matching and routing are the same. The frequency is different.
RF	RF circuit	The RF circuit of the same frequency is the same.	The RF circuit of the same frequency is the same. the different frequency changed by hardware and some RF parameters. Changes are followed: delete B4/B13/B66 SAWS、Diplexer、switch and RF matching components.
Others		the same	the same

The detailed product change description please refers to the *Difference Declaration Letter*.



1. Test Laboratory

1.1. Notes of the test report

This report shall not be reproduced in full or partial, without the written approval of **TA technology (shanghai) co., Ltd.** The results documented in this report apply only to the tested sample, under the conditions and modes of operation as described herein. Measurement Uncertainties were not taken into account and are published for informational purposes only. This report is written to support regulatory compliance of the applicable standards stated above.

1.2. Test facility

FCC (Designation number: CN1179, Test Firm Registration Number: 446626)

TA Technology (Shanghai) Co., Ltd. has been listed on the US Federal Communications Commission list of test facilities recognized to perform electromagnetic emissions measurements.

A2LA (Certificate Number: 3857.01)

TA Technology (Shanghai) Co., Ltd. has been listed by American Association for Laboratory Accreditation to perform electromagnetic emission measurement.

1.3. Testing Location

Company: TA Technology (Shanghai) Co., Ltd.
Address: No.145, Jintang Rd, Tangzhen Industry Park, Pudong
City: Shanghai
Post code: 201201
Country: P. R. China
Contact: Xu Kai
Telephone: +86-021-50791141/2/3
Fax: +86-021-50791141/2/3-8000
Website: <http://www.ta-shanghai.com>
E-mail: xukai@ta-shanghai.com

2. General Description of Equipment under Test

2.1. Applicant and Manufacturer Information

Applicant	Honor Device Co., Ltd.
Applicant address	Shum Yip Sky Park, No. 8089, Hongli West Road, Shenzhen, China
Manufacturer	Honor Device Co., Ltd.
Manufacturer address	Shum Yip Sky Park, No. 8089, Hongli West Road, Shenzhen, China

2.2. General information

EUT Description			
Model	TFY-LX2		
SN	A7NX011C30000083		
HW Version	HL6TFYM		
SW Version	4.2.0.35(C900E14R1P1)		
Power Supply	Battery / AC adapter		
Antenna Type	Internal Antenna		
Antenna Gain	-0.6dBi		
Directional Gain	NA		
Operating Frequency Range(s)	U-NII-1: 5150MHz-5250MHz U-NII-2A:5250MHz -5350MHz U-NII-2C:5470MHz-5725MHz U-NII-3: 5725MHz -5850MHz		
Modulation Type	802.11a/n (HT20/HT40) : OFDM 802.11ac (VHT20/VHT40/VHT80): OFDM		
Max Power	18.35 dBm		
Testing temperature range:	0 ° C to 35° C		
Operating temperature range:	0 ° C to 35° C		
Operating voltage range:	3.6 V to 4.45 V		
State DC voltage:	3.87V		
EUT Accessory			
Accessory	Model	Manufacture	No.
Adapter	HW-100225E00	Honor Device Co., Ltd. (Manufacturer:Huntkey)	1
	HW-100225U00	Honor Device Co., Ltd. (Manufacturer:Huntkey)	2
	HW-100225B00	Honor Device Co., Ltd. (Manufacturer:Huntkey)	3
	HN-100225E00	Honor Device Co., Ltd.	4



		(Manufacturer: Salcomp)	
	HN-100225U00	Honor Device Co., Ltd. (Manufacturer: Salcomp)	5
Battery	HB416492EFW	Honor Device Co., Ltd. (Manufacturer: Sunwoda Electronic Co.,LTD)	1
	HB416492EFW	Honor Device Co., Ltd. (Manufacturer:NVT)	2
Earphone	MEND1532B528A11	Jiangxi Lianchuang Hongsheng Electronic Co., LTD.	1
	1293-3283-3.5mm-339	BOLUO COUNTY QUANCHENG ELECTRONIC CO.,LTD.	2
	EPAB542-2WH05-DH	FOXCONN INTERCONNECT TECHNOLOGY LIMITED	3
USB Cable	RY0002	NingBo Broad Telecommunication Co., Ltd.	1
	AU2-CRO013HF	Freeport Resources Enterprises Corp.	2
	2120-00001-0	MING JI ELECTRONICS CO., LTD.	3
	L125UC007-CS-H	LUXSHARE PRECISION INDUSTRY CO., LTD.	4
	CUDU01B-HC451-EH	FOXCONN INTERCONNECT TECHNOLOGY LIMITED	5

Note: 1. The EUT is sent from the applicant to TA and the information of the EUT is declared by the applicant.

2. This device support automatically discontinue transmission, while the device is not transmitting any information, the device can automatically discontinue transmission and become standby mode for power saving. The device can detect the controlling signal of ACK message transmitting from remote device and verify whether it shall resend or discontinue transmission.

2. There are more than one Adapter, Battery, Earphone and USB Cable, each one should be applied throughout the compliance test respectively, however, only the worst case (Adapter 1, Battery 2, Earphone 1 and USB Cable 3) will be recorded in this report.



3. Applied Standards

According to the specifications of the manufacturer, it must comply with the requirements of the following standards:

Test standards:

FCC CFR47 Part 15E (2020) Unlicensed National Information Infrastructure Devices

ANSI C63.10 (2013)

Reference standard:

KDB 789033 D02 General UNII Test Procedures New Rules v02r01

4. Test Configuration

Test Mode

The EUT has been associated with peripherals and configuration operated in a manner tended to maximize its emission characteristics in a typical application.

The radiated emission was measured in the following position: EUT stand-up position (Z axis), lie-down position (X, Y axis). The worst emission was found in stand-up position (Z axis) and the worst case was recorded.

In order to find the worst case condition, Pre-tests are needed at the presence of different data rate. Preliminary tests have been done on all the configuration for confirming worst case. Data rate below means worst-case rate of each test item.

Worst-case data rates are shown as following table.

Mode	Data Rate
802.11a	6 Mbps
802.11n HT20	MCS0
802.11n HT40	MCS0
802.11ac VHT20	MCS0
802.11ac VHT40	MCS0
802.11ac VHT80	MCS0

Wireless Technology and Frequency Range

Wireless Technology		Bandwidth	Channel	Frequency	
Wi-Fi	U-NII-1	20 MHz	36	5180MHz	
			40	5200MHz	
			44	5220MHz	
			48	5240MHz	
		40 MHz	38	5190MHz	
			46	5230MHz	
			80 MHz	42	5210MHz
		U-NII-2A	20 MHz	52	5260MHz
				56	5280MHz
	60			5300MHz	
	64			5320MHz	
	40 MHz		54	5270MHz	
			62	5310MHz	
			80 MHz	58	5290MHz
	U-NII-2C		20 MHz	100	5500MHz
				104	5520MHz
		108		5540MHz	
		112		5560MHz	
		116		5580MHz	
		120		5600MHz	
		124		5620MHz	
		128		5640MHz	
		132		5660MHz	
		136		5680MHz	
		140		5700MHz	
		40 MHz		102	5510MHz
			110	5550MHz	
			118	5590MHz	
			126	5630MHz	
			134	5670MHz	
142			5710MHz		
80 MHz		106	5530MHz		
		122	5610MHz		
		138	5690MHz		
U-NII-3		20 MHz	149	5745MHz	
	153		5765MHz		
	157		5785MHz		



			161	5805MHz
			165	5825MHz
		40 MHz	151	5755MHz
			159	5795MHz
		80 MHz	155	5775MHz
Does this device support TPC Function? <input checked="" type="checkbox"/> Yes <input type="checkbox"/> No				
Does this device support TDWR Band? <input checked="" type="checkbox"/> Yes <input type="checkbox"/> No				

5. Test Case Results

5.1. Occupied Bandwidth

Ambient condition

Temperature	Relative humidity	Pressure
23°C ~25°C	45%~50%	101.5kPa

Method of Measurement

The EUT was connected to the spectrum analyzer through an external attenuator (20dB) and a known loss cable.

For U-NII-1/U-NII-2A/U-NII-2C, set RBW \approx 1% OCB kHz, VBW \geq 3 \times RBW, measure the maximum width of the emission that is constrained by the frequencies associated with the two outermost amplitude points (upper and lower frequencies) that are attenuated by 26 dB relative to the maximum level measured in the fundamental emission.

For U-NII-3, Set RBW = 100 kHz, VBW \geq 3 \times RBW, measure the maximum width of the emission that is constrained by the frequencies associated with the two outermost amplitude points (upper and lower frequencies) that are attenuated by 6 dB relative to the maximum level measured in the fundamental emission.

Note: The automatic bandwidth measurement capability of a spectrum analyzer or EMI receiver may be employed if it implements the functionality described above.

Use the 99 % power bandwidth function of the instrument

Test Setup

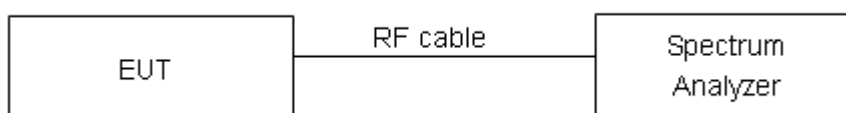

Limits

Rule FCC Part §15.407(e)

Within the 5.725-5.85 GHz band, the minimum 6 dB bandwidth of U-NII devices shall be at least 500 kHz.

Measurement Uncertainty

The assessed measurement uncertainty to ensure 95% confidence level for the normal distribution is with the coverage factor $k = 2$, $U = 936$ Hz.

**Test Results:****U-NII-1**

Mode	Carrier frequency (MHz)	99% bandwidth (MHz)	Minimum 26 dB bandwidth (MHz)	Conclusion
802.11a	5180	16.652	24.75	PASS
	5200	19.546	30.00	PASS
	5240	18.560	29.91	PASS
802.11n HT20	5180	17.805	24.31	PASS
	5200	19.871	30.00	PASS
	5240	18.828	30.00	PASS
802.11n HT40	5190	36.170	41.06	PASS
	5230	36.346	57.78	PASS
802.11ac VHT20	5180	17.812	24.48	PASS
	5200	19.692	30.00	PASS
	5240	18.821	30.00	PASS
802.11ac VHT40	5190	36.194	40.78	PASS
	5230	36.372	59.36	PASS
802.11ac VHT80	5210	75.608	83.10	PASS

U-NII-2A

Mode	Carrier frequency (MHz)	99% bandwidth (MHz)	Minimum 26 dB bandwidth (MHz)	Conclusion
802.11a	5260	18.204	29.39	PASS
	5300	19.460	30.00	PASS
	5320	16.764	26.37	PASS
802.11n HT20	5260	18.636	29.94	PASS
	5300	20.139	30.00	PASS
	5320	17.856	26.29	PASS
802.11n HT40	5270	36.376	59.72	PASS
	5310	36.169	40.78	PASS
802.11ac VHT20	5260	19.381	30.00	PASS
	5300	19.530	30.00	PASS
	5320	17.918	27.93	PASS
802.11ac VHT40	5270	36.380	59.67	PASS
	5310	36.139	40.76	PASS
802.11ac VHT80	5290	75.677	82.99	PASS



U-NII-2C

Mode	Carrier frequency (MHz)	99% bandwidth (MHz)	Minimum 26 dB bandwidth (MHz)	Conclusion
802.11a	5500	17.130	29.98	PASS
	5520	18.479	29.99	PASS
	5600	18.876	30.00	PASS
	5680	19.609	30.00	PASS
	5700	16.653	22.84	PASS
802.11n HT20	5500	18.404	29.93	PASS
	5520	18.897	29.99	PASS
	5600	19.395	30.00	PASS
	5680	20.046	30.00	PASS
	5700	17.847	25.67	PASS
802.11n HT40	5510	35.153	41.59	PASS
	5550	36.382	59.84	PASS
	5590	36.361	59.97	PASS
	5630	36.428	60.00	PASS
	5670	36.355	59.81	PASS
802.11ac VHT20	5500	18.536	29.04	PASS
	5520	19.016	30.00	PASS
	5600	19.461	30.00	PASS
	5680	19.724	30.00	PASS
	5700	17.847	25.51	PASS
802.11ac VHT40	5510	36.126	40.88	PASS
	5550	36.393	59.93	PASS
	5590	36.410	59.99	PASS
	5630	36.426	59.90	PASS
	5670	36.363	59.83	PASS
	5710	36.539	59.99	PASS
802.11ac VHT80	5530	75.698	82.78	PASS
	5610	76.095	120.00	PASS
	5690	76.110	119.90	PASS



U-NII-3

Mode	Carrier frequency (MHz)	99% bandwidth (MHz)	Minimum 6 dB bandwidth (MHz)	Limit (kHz)	Conclusion
802.11a	5745	19.230	15.06	500	PASS
	5785	19.298	15.68	500	PASS
	5825	19.157	16.27	500	PASS
802.11n HT20	5745	19.418	16.85	500	PASS
	5785	19.826	17.31	500	PASS
	5825	19.343	15.64	500	PASS
802.11n HT40	5755	36.356	35.69	500	PASS
	5795	36.402	35.50	500	PASS
802.11ac VHT20	5745	19.518	16.53	500	PASS
	5785	19.875	16.84	500	PASS
	5825	19.144	16.80	500	PASS
802.11ac VHT40	5755	36.332	35.69	500	PASS
	5795	36.401	35.42	500	PASS
802.11ac VHT80	5775	75.056	75.12	500	PASS

U-NII-1, 802.11a
Carrier frequency (MHz): 5180



U-NII-1, 802.11n HT20
Carrier frequency (MHz): 5180

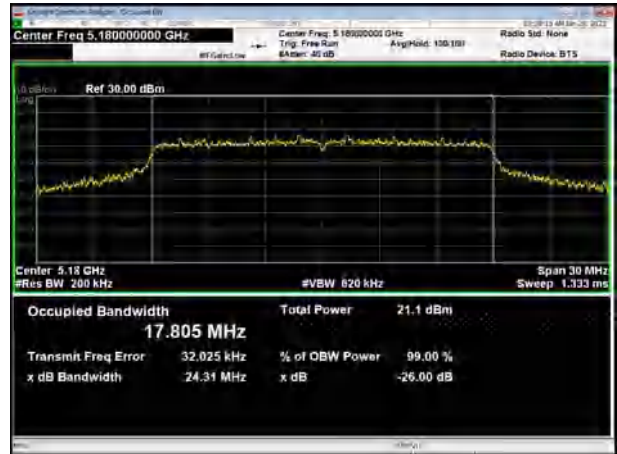

U-NII-1, 802.11a
Carrier frequency (MHz): 5200

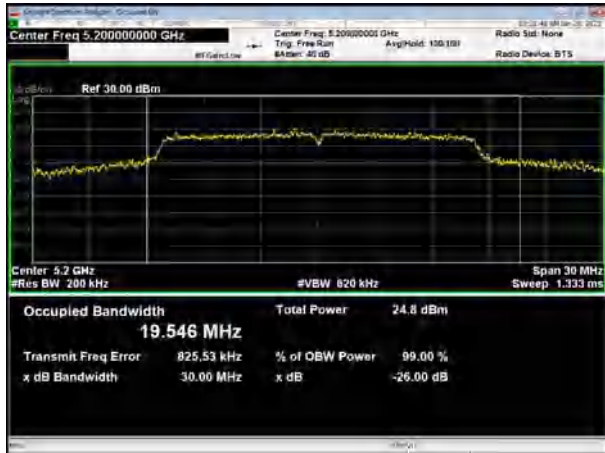

U-NII-1, 802.11n HT20
Carrier frequency (MHz): 5200

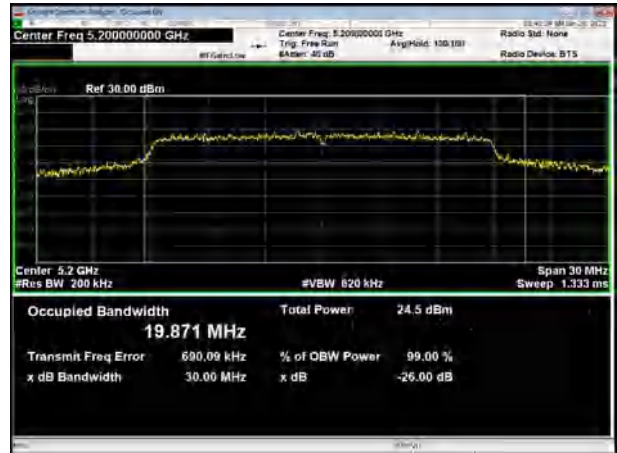

U-NII-1, 802.11a
Carrier frequency (MHz):5240



U-NII-1, 802.11n HT20
Carrier frequency (MHz):5240

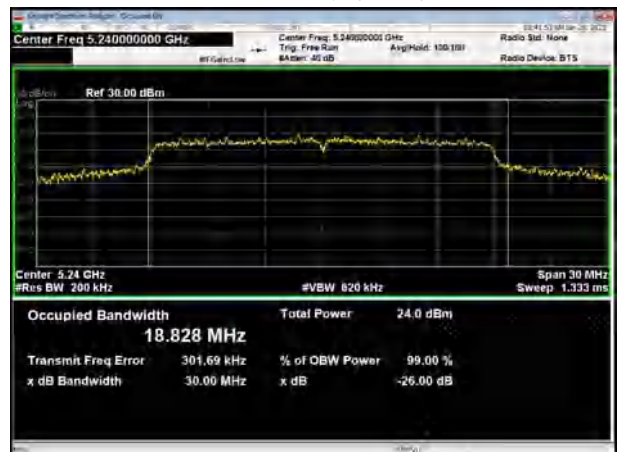

U-NII-1, 802.11n HT40
Carrier frequency (MHz): 5190

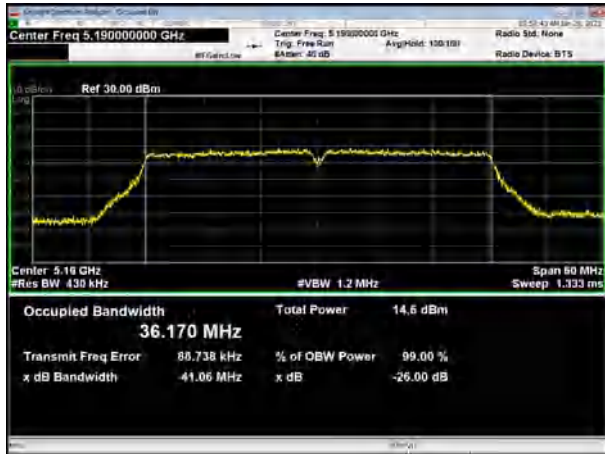

U-NII-1, 802.11ac VHT20
Carrier frequency (MHz): 5180

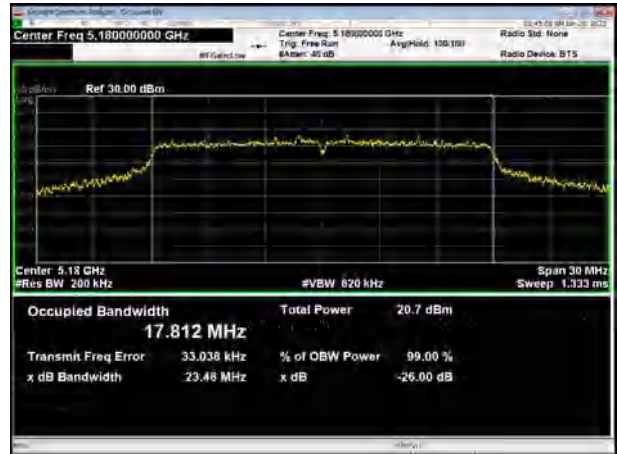

U-NII-1, 802.11n HT40
Carrier frequency (MHz): 5230

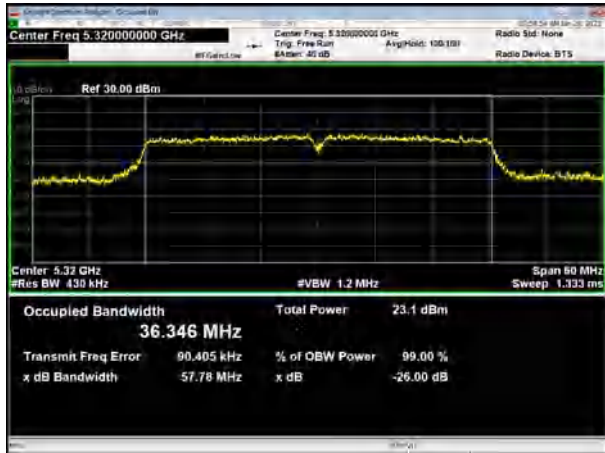

U-NII-1, 802.11ac VHT20
Carrier frequency (MHz): 5200

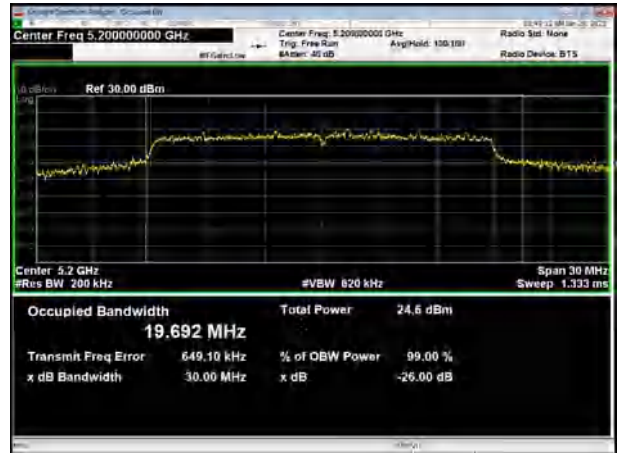

U-NII-1, 802.11ac VHT40
Carrier frequency (MHz): 5190

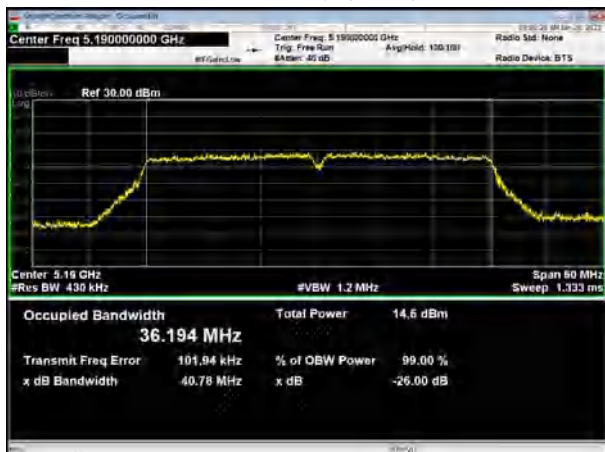

U-NII-1, 802.11ac VHT20
Carrier frequency (MHz): 5240

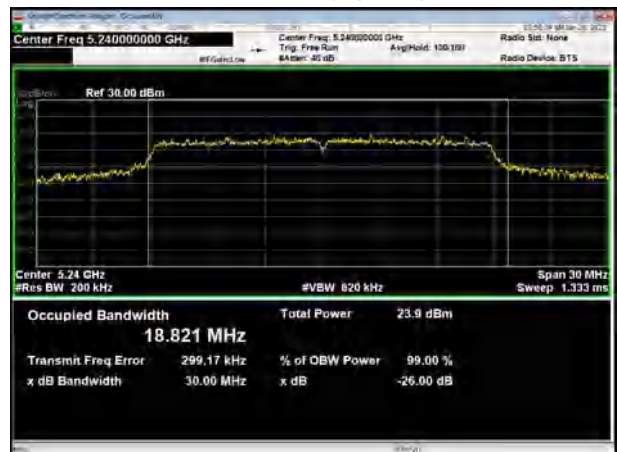

U-NII-1, 802.11ac VHT40
Carrier frequency (MHz): 5230

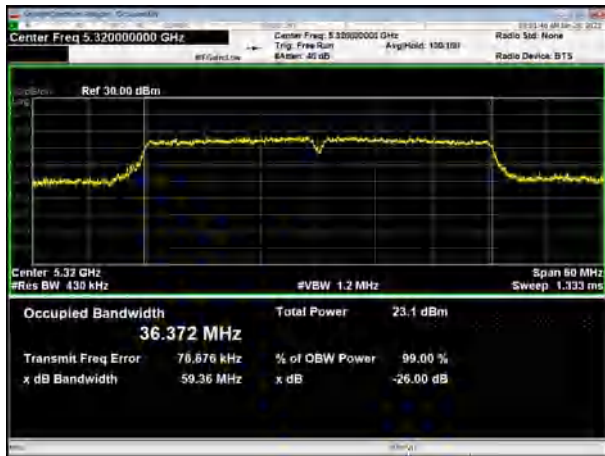

U-NII-1, 802.11ac VHT80
Carrier frequency (MHz): 5210

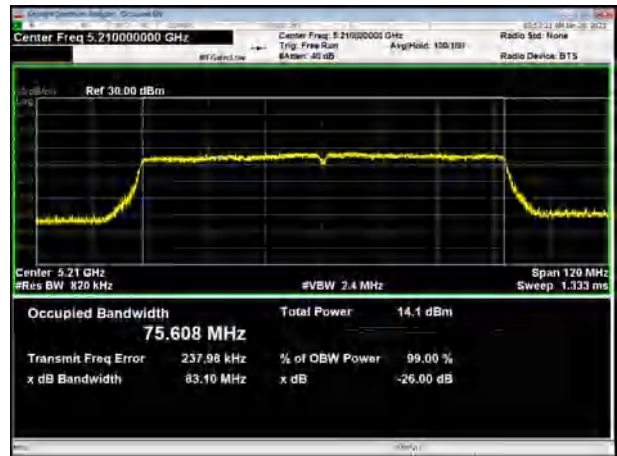

U-NII-2A, 802.11a
Carrier frequency (MHz): 5260

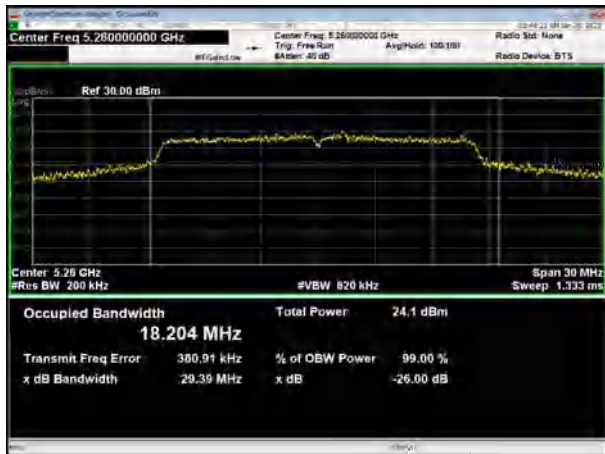

U-NII-2A, 802.11n HT20
Carrier frequency (MHz): 5260



U-NII-2A, 802.11a
Carrier frequency (MHz): 5300

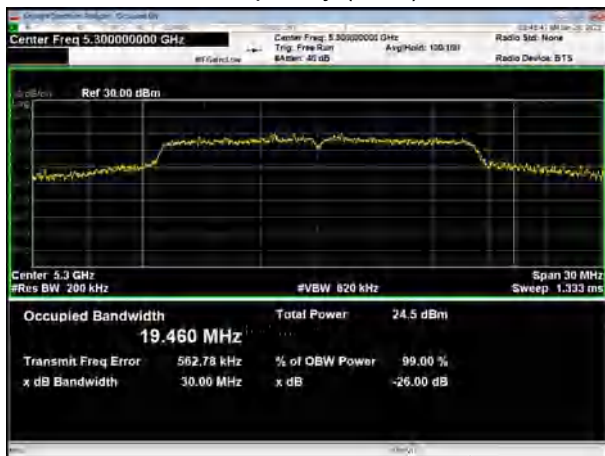

U-NII-2A, 802.11n HT20
Carrier frequency (MHz): 5300

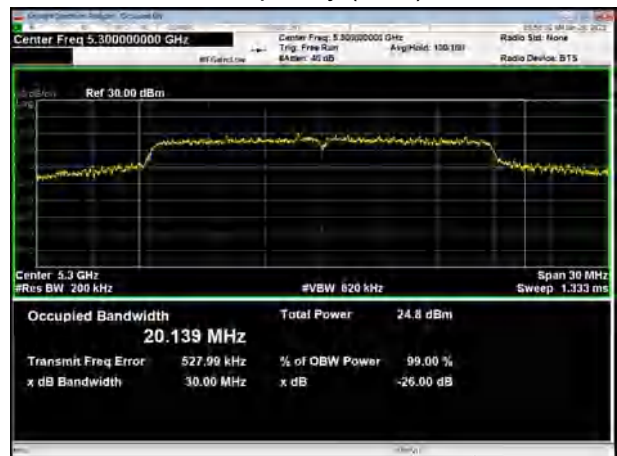

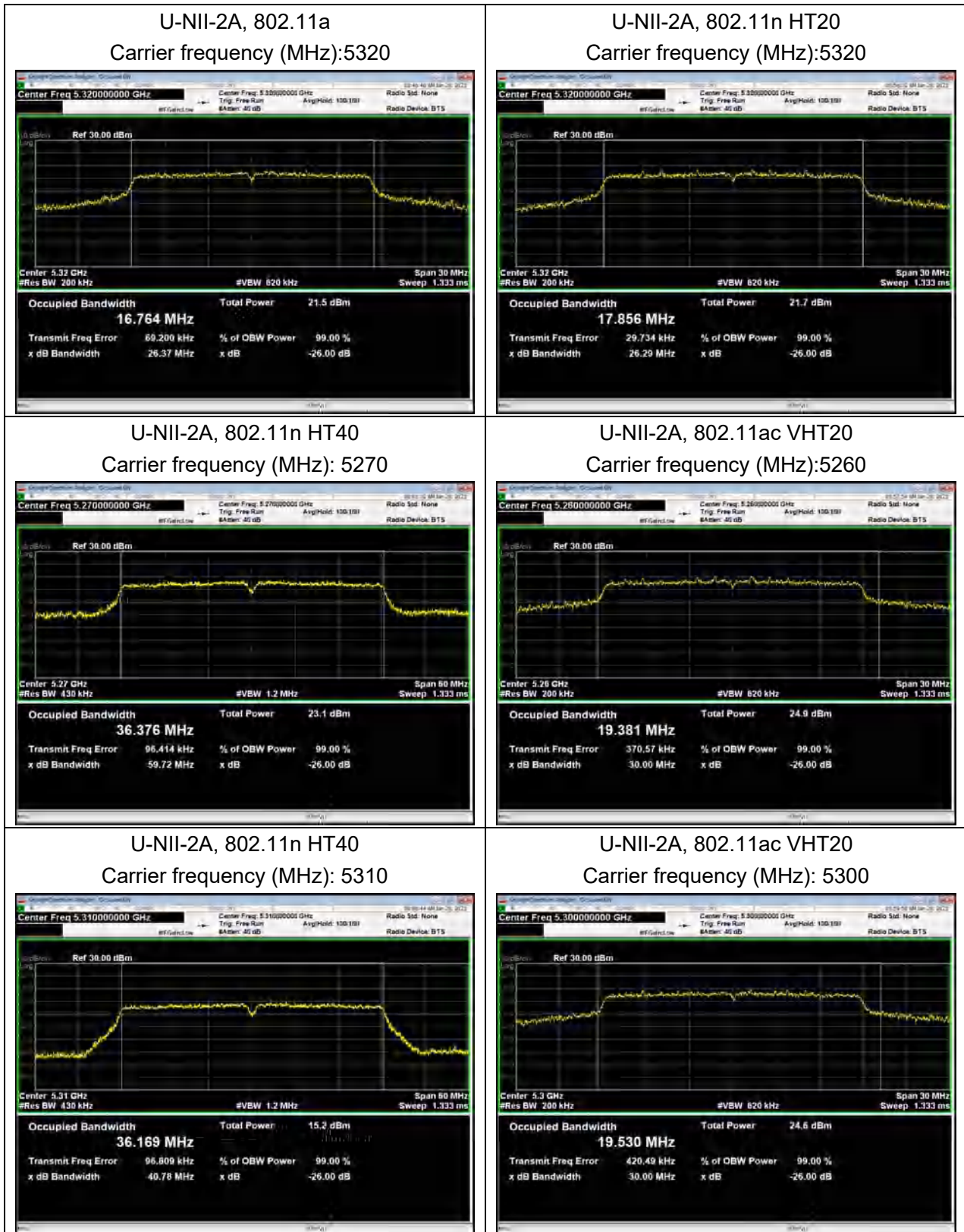

U-NII-2A, 802.11ac VHT40
Carrier frequency (MHz): 5270

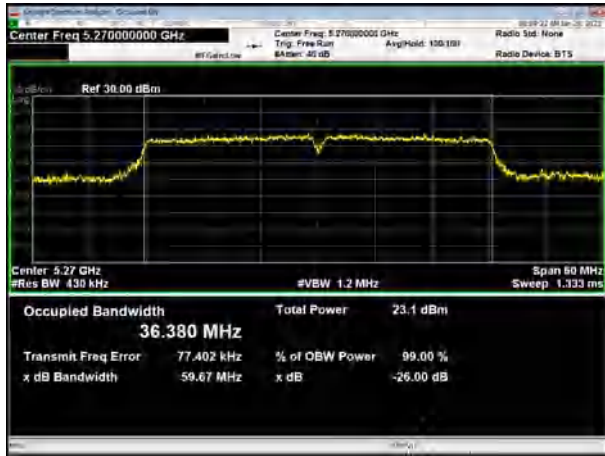

U-NII-2A, 802.11ac VHT20
Carrier frequency (MHz): 5320



U-NII-2A, 802.11ac VHT40
Carrier frequency (MHz): 5310

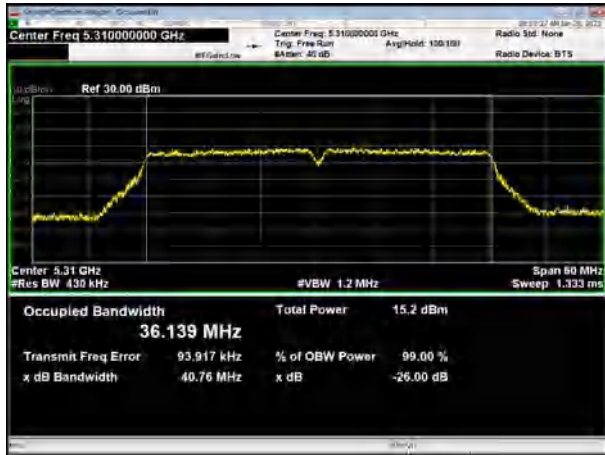

U-NII-2A, 802.11ac VHT80
Carrier frequency (MHz): 5290

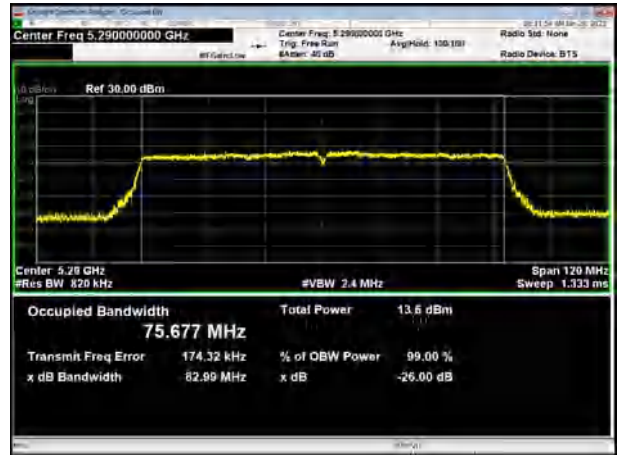

U-NII-2C, 802.11a
Carrier frequency (MHz): 5500

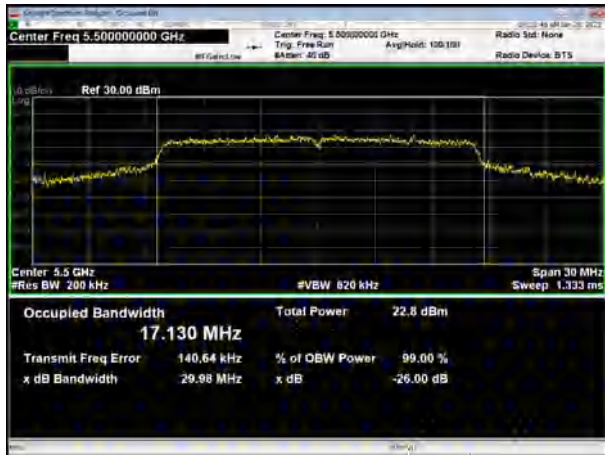

U-NII-2C, 802.11n HT20
Carrier frequency (MHz): 5500



U-NII-2C, 802.11a
Carrier frequency (MHz): 5520

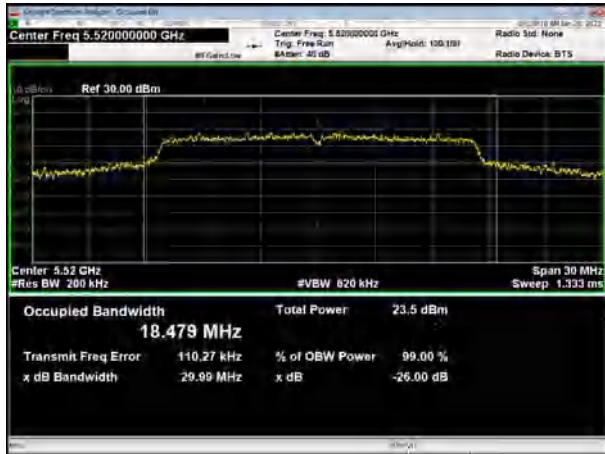

U-NII-2C, 802.11n HT20
Carrier frequency (MHz): 5520

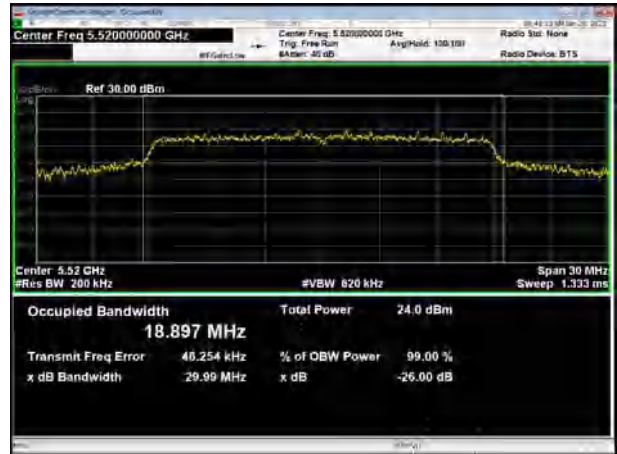

U-NII-2C, 802.11a
Carrier frequency (MHz): 5600

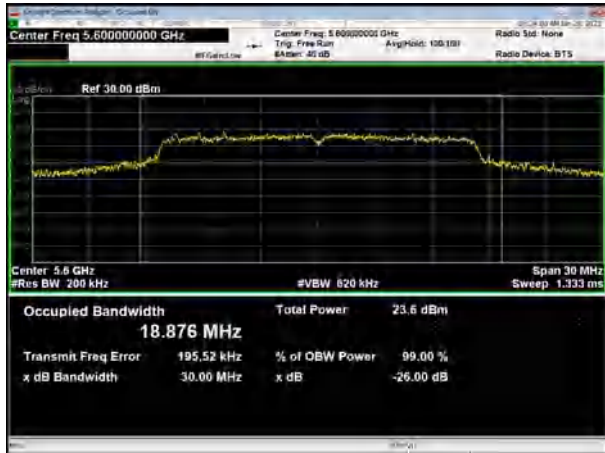

U-NII-2C, 802.11n HT20
Carrier frequency (MHz): 5600

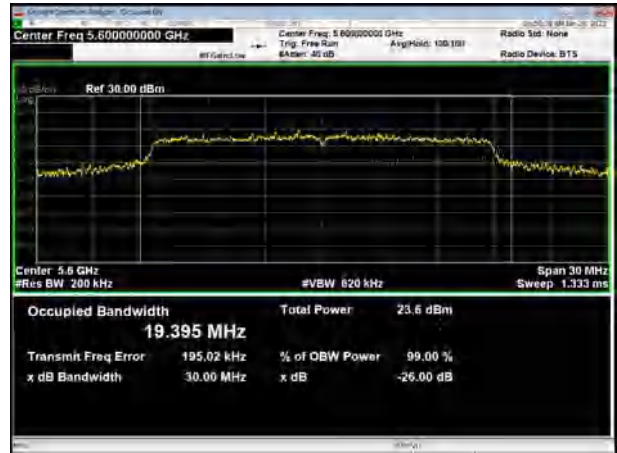

U-NII-2C, 802.11a
Carrier frequency (MHz): 5680



U-NII-2C, 802.11n HT20
Carrier frequency (MHz): 5680



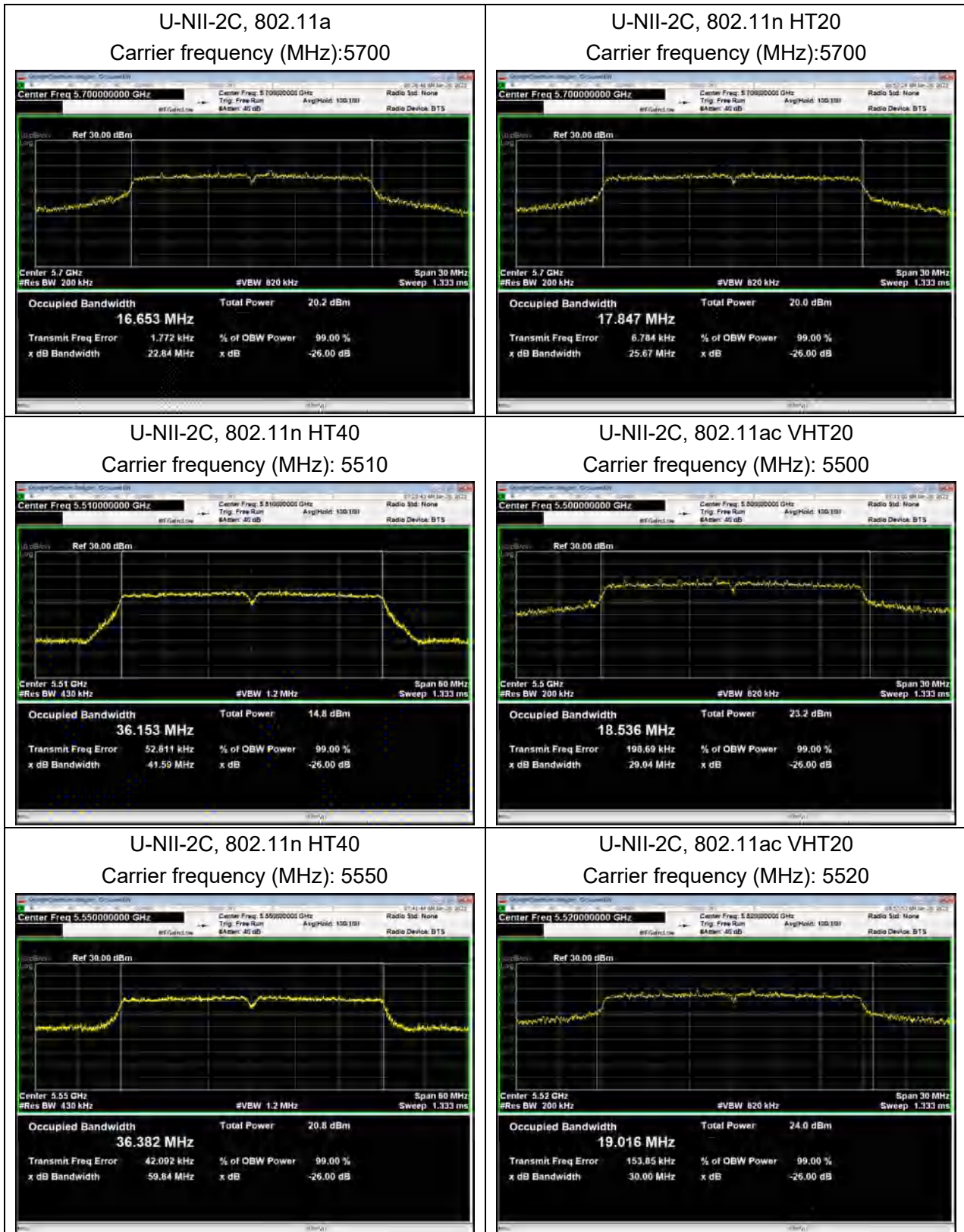

U-NII-2C, 802.11n HT40
Carrier frequency (MHz): 5590

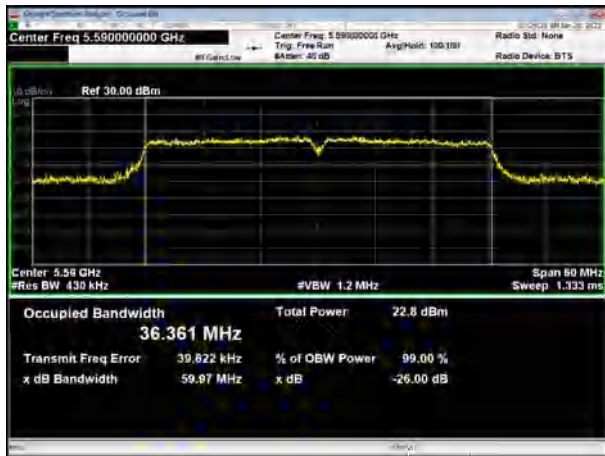

U-NII-2C, 802.11ac VHT20
Carrier frequency (MHz):5600

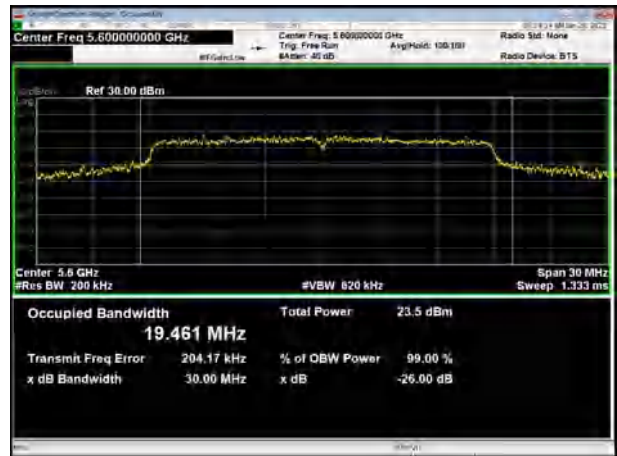

U-NII-2C, 802.11n HT40
Carrier frequency (MHz): 5630

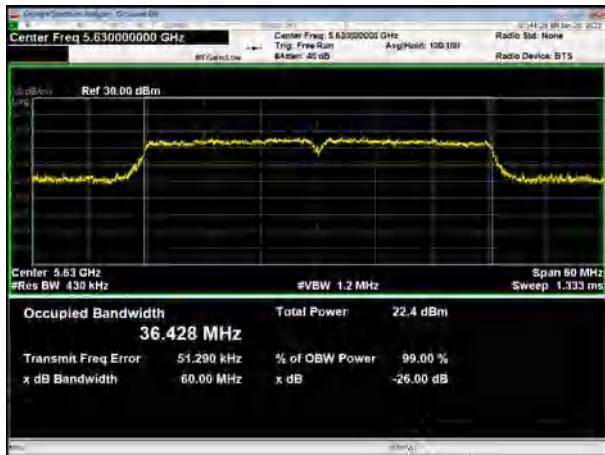

U-NII-2C, 802.11ac VHT20
Carrier frequency (MHz):5680



U-NII-2C, 802.11n HT40
Carrier frequency (MHz): 5670



U-NII-2C, 802.11ac VHT20
Carrier frequency (MHz):5700

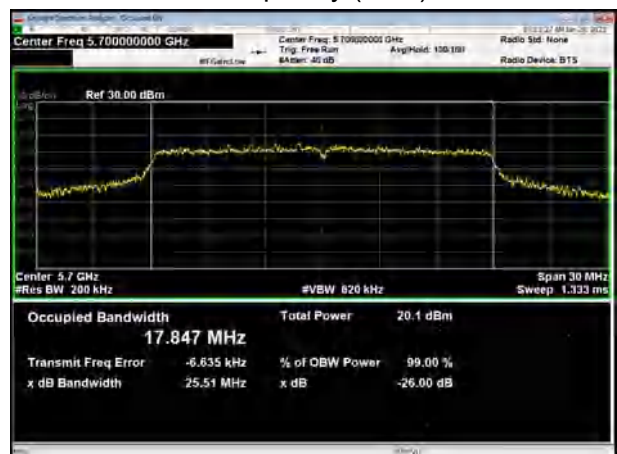

U-NII-2C, 802.11n HT40
Carrier frequency (MHz): 5710

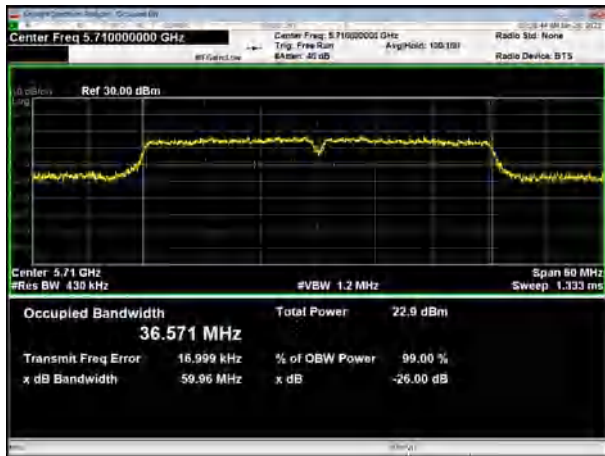

U-NII-2C, 802.11ac VHT80
Carrier frequency (MHz): 5530

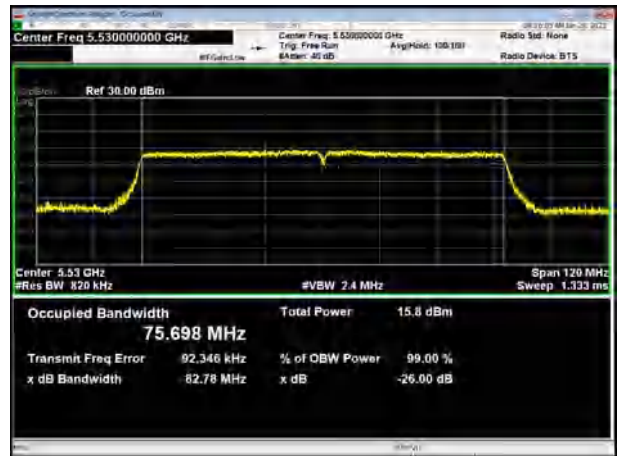

U-NII-2C, 802.11ac VHT40
Carrier frequency (MHz): 5510

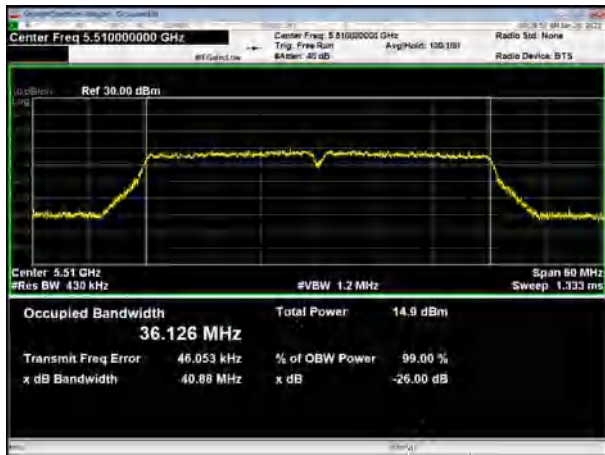

U-NII-2C, 802.11ac VHT80
Carrier frequency (MHz): 5610

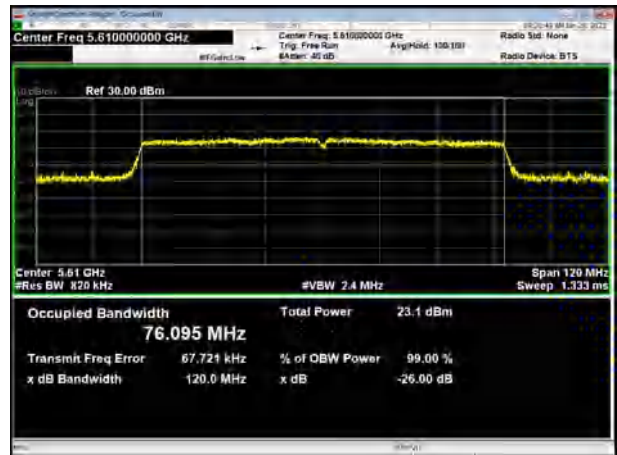

U-NII-2C, 802.11ac VHT40
Carrier frequency (MHz): 5550

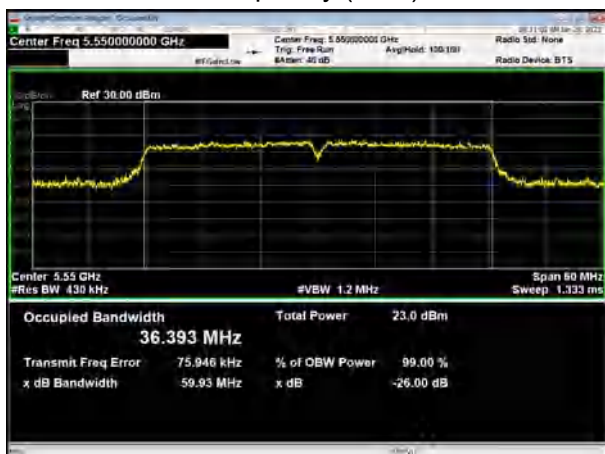

U-NII-2C, 802.11ac VHT80
Carrier frequency (MHz): 5690

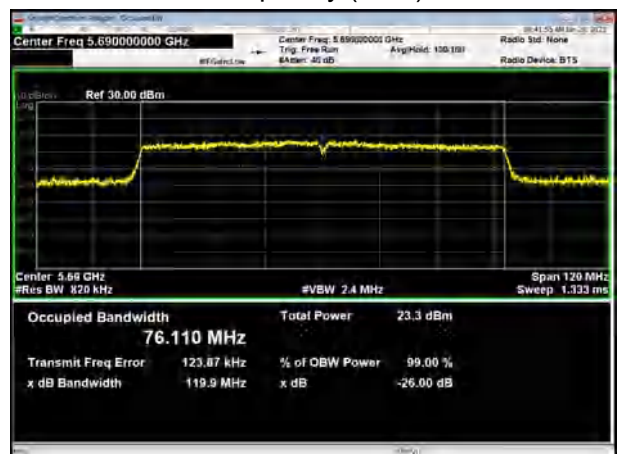

U-NII-2C, 802.11ac VHT40
Carrier frequency (MHz): 5590

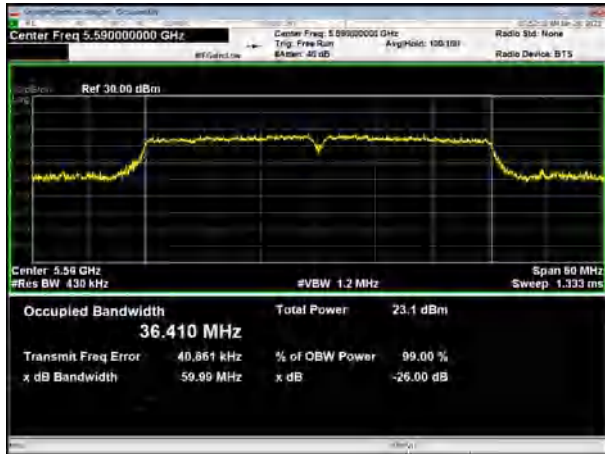

U-NII-2C, 802.11ac VHT40
Carrier frequency (MHz): 5630

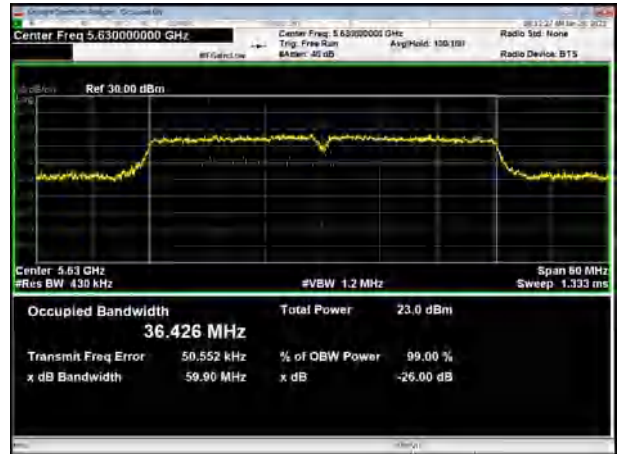

U-NII-2C, 802.11ac VHT40
Carrier frequency (MHz): 5670

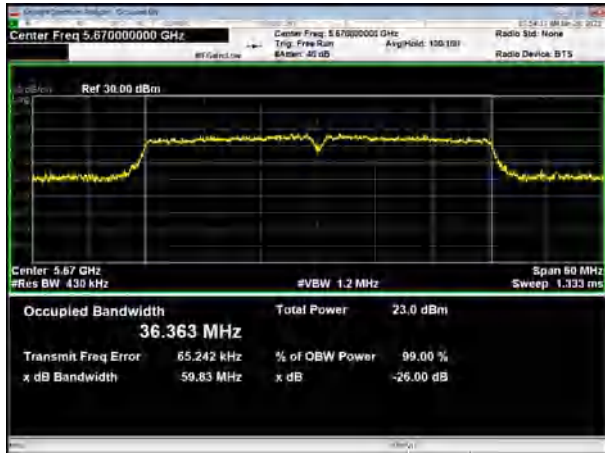

U-NII-2C, 802.11ac VHT40
Carrier frequency (MHz): 5710





99% bandwidth

U-NII-3, 802.11a
Carrier frequency (MHz): 5745

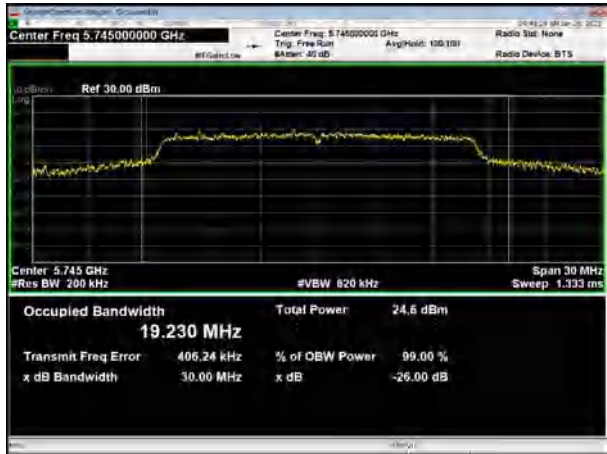

U-NII-3, 802.11n HT20
Carrier frequency (MHz): 5745

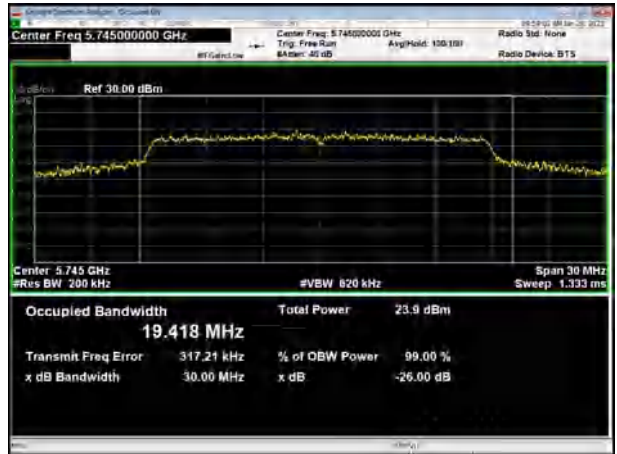

U-NII-3, 802.11a
Carrier frequency (MHz): 5785

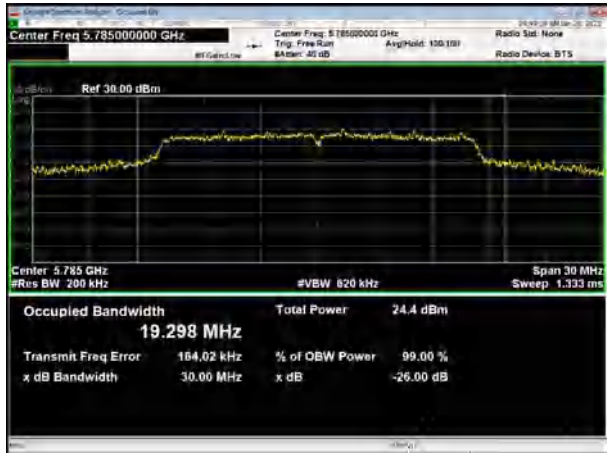

U-NII-3, 802.11n HT20
Carrier frequency (MHz): 5785

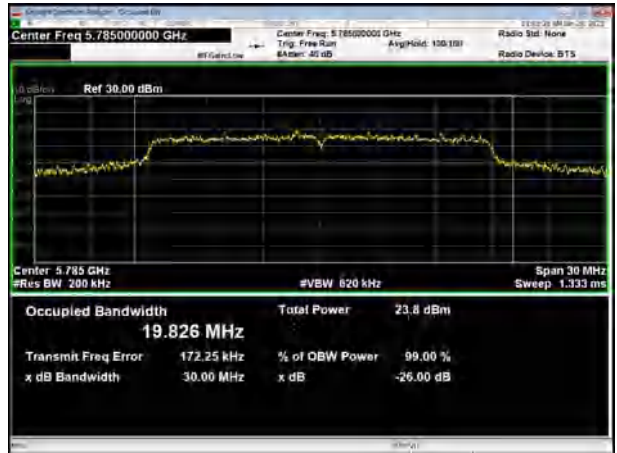

U-NII-3, 802.11a
Carrier frequency (MHz): 5825

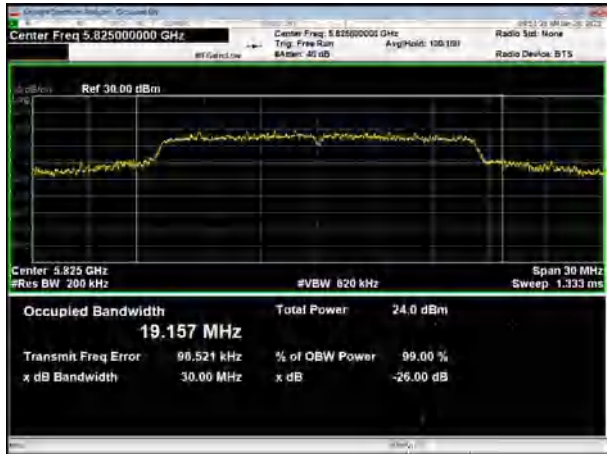

U-NII-3, 802.11n HT20
Carrier frequency (MHz): 5825

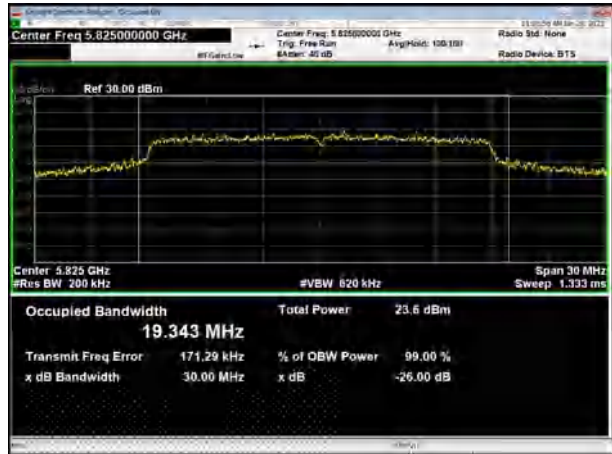

U-NII-3, 802.11n HT40
Carrier frequency (MHz): 5755

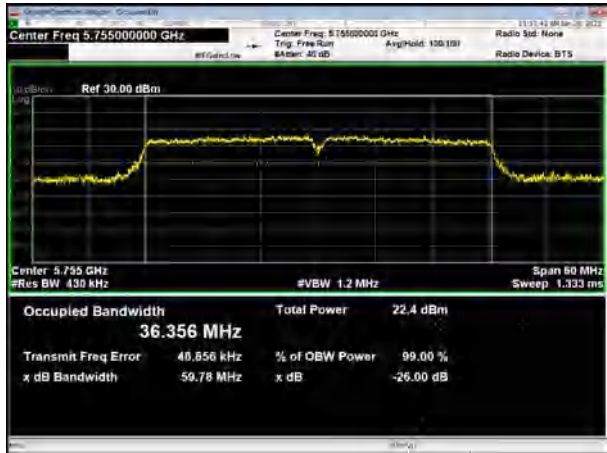

U-NII-3, 802.11ac VHT20
Carrier frequency (MHz): 5745



U-NII-3, 802.11n HT40
Carrier frequency (MHz): 5795

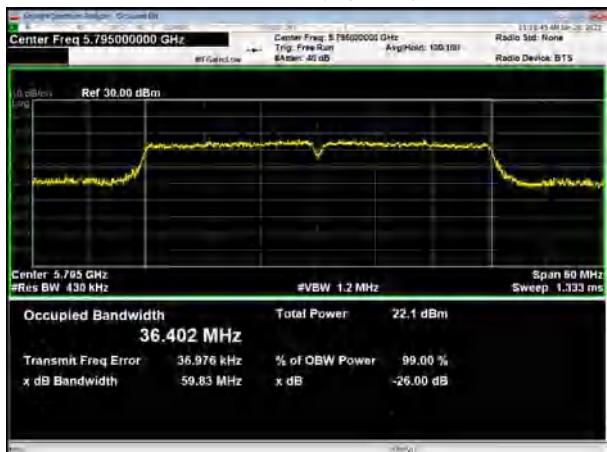

U-NII-3, 802.11ac VHT20
Carrier frequency (MHz): 5785

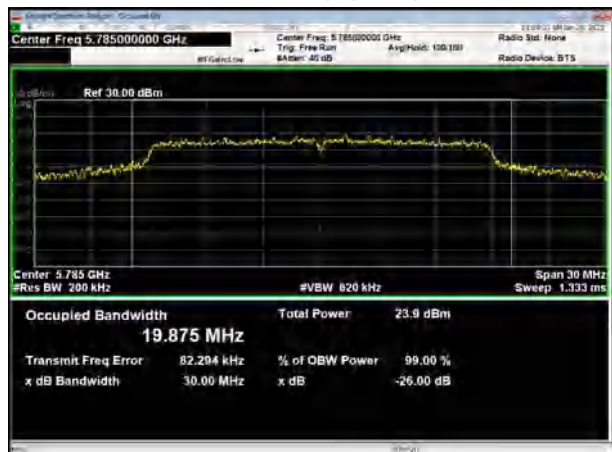

U-NII-3, 802.11ac VHT40
Carrier frequency (MHz): 5755

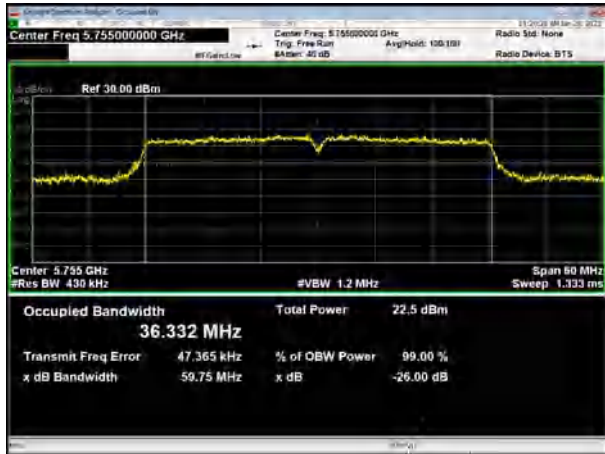

U-NII-3, 802.11ac VHT20
Carrier frequency (MHz): 5825

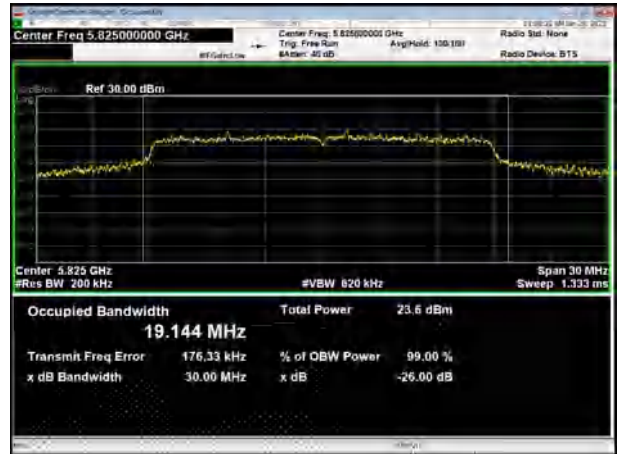

U-NII-3, 802.11ac VHT40
Carrier frequency (MHz): 5795

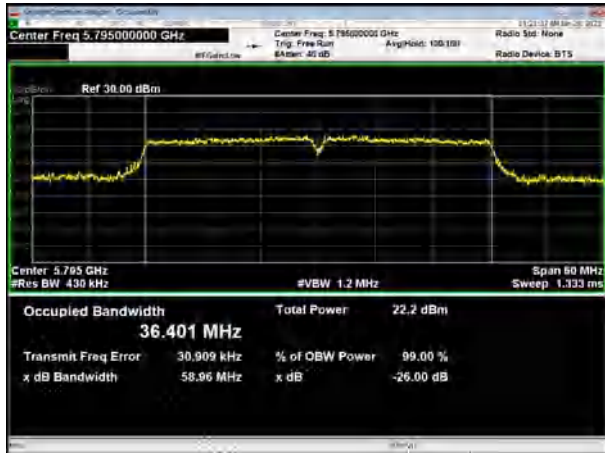

U-NII-3, 802.11ac VHT80
Carrier frequency (MHz): 5775

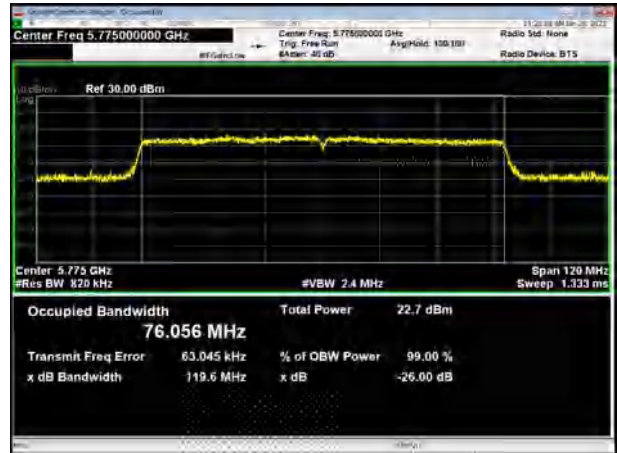

Minimum 6 dB bandwidth

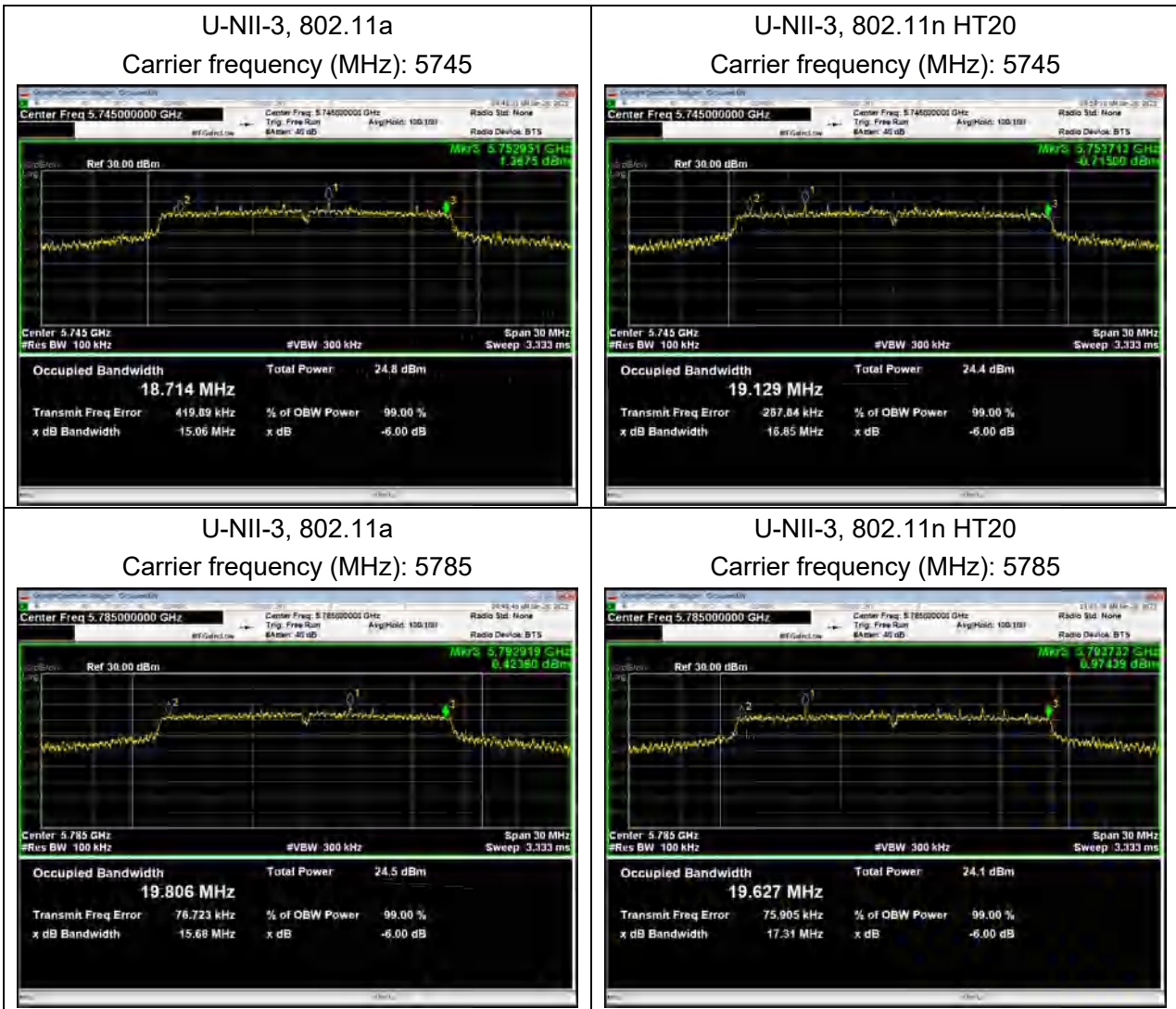

U-NII-3, 802.11a
Carrier frequency (MHz): 5825

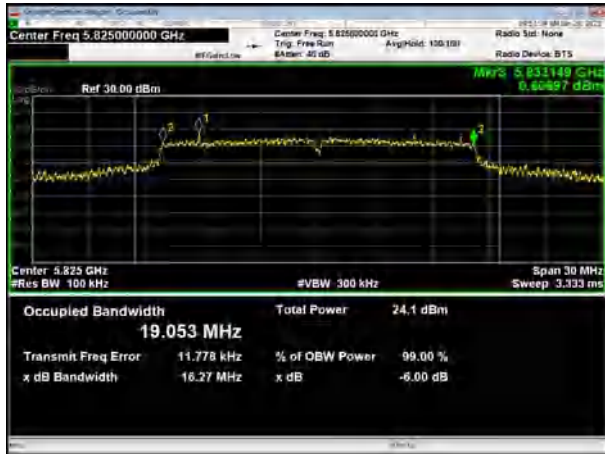

U-NII-3, 802.11n HT20
Carrier frequency (MHz): 5825

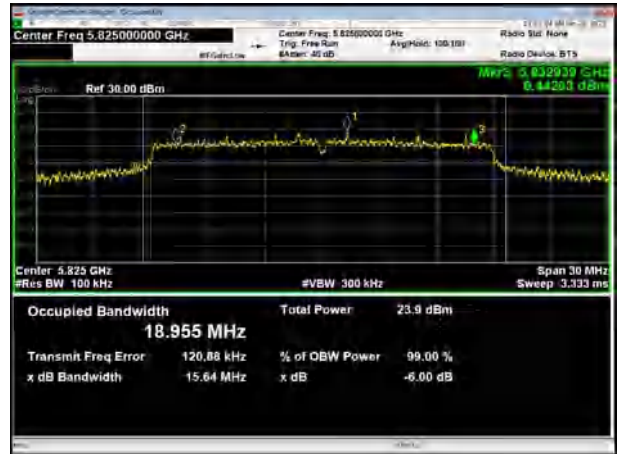

U-NII-3, 802.11n HT40
Carrier frequency (MHz): 5755

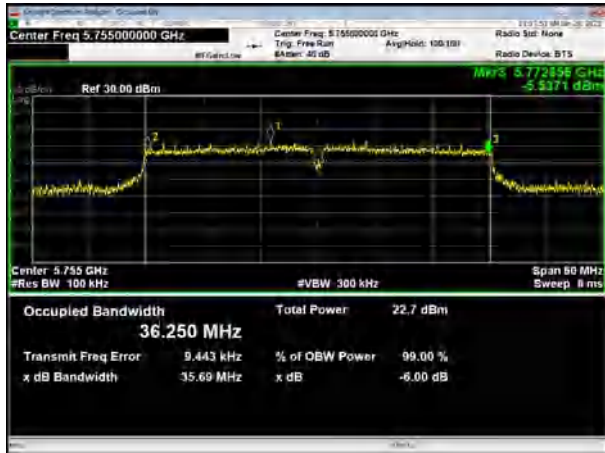

U-NII-3, 802.11ac VHT20
Carrier frequency (MHz): 5745

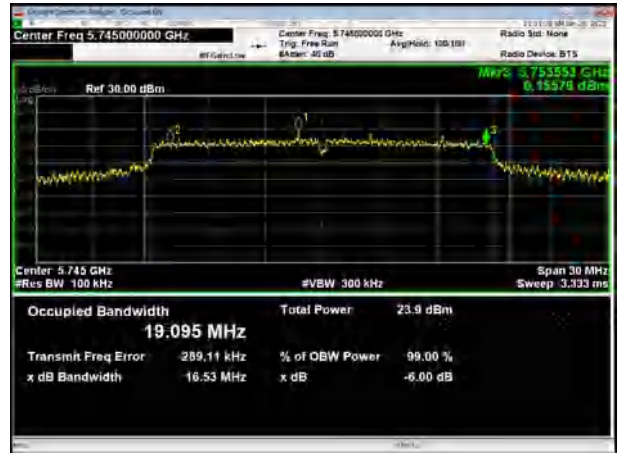

U-NII-3, 802.11n HT40
Carrier frequency (MHz): 5795



U-NII-3, 802.11ac VHT20
Carrier frequency (MHz): 5785



U-NII-3, 802.11ac VHT40
Carrier frequency (MHz): 5755



U-NII-3, 802.11ac VHT20
Carrier frequency (MHz): 5825

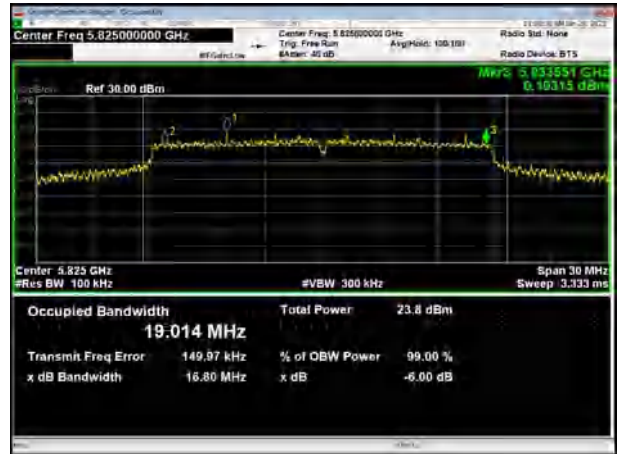

U-NII-3, 802.11ac VHT40
Carrier frequency (MHz): 5795

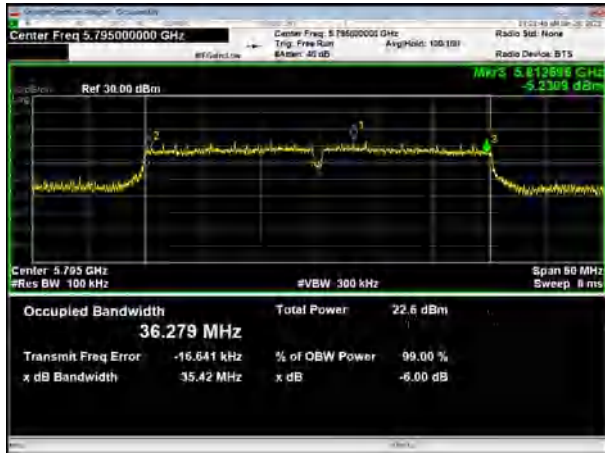

U-NII-3, 802.11ac VHT80
Carrier frequency (MHz): 5775

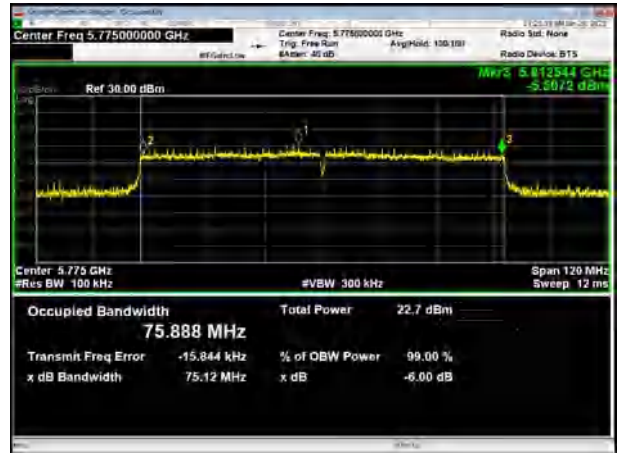

5.2. Average Power Output

Ambient condition

Temperature	Relative humidity	Pressure
23°C ~25°C	45%~50%	101.5kPa

Methods of Measurement

During the process of the testing, The EUT was connected to the average power meter through an external attenuator and a known loss cable. The EUT is max power transmission with proper modulation. We use Maximum average Conducted Output Power Level Method in KDB789033 for this test

Test Setup

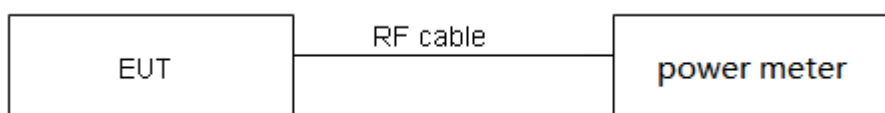

Limits

Rule FCC Part 15.407(a)(1)(2)(3)

(1) For the band 5.15-5.25 GHz.

(i) For an outdoor access point operating in the band 5.15-5.25 GHz, the maximum conducted output power over the frequency band of operation shall not exceed 1 W provided the maximum antenna gain does not exceed 6 dBi. In addition, the maximum power spectral density shall not exceed 17 dBm in any 1 megahertz band. If transmitting antennas of directional gain greater than 6 dBi are used, both the maximum conducted output power and the maximum power spectral density shall be reduced by the amount in dB that the directional gain of the antenna exceeds 6 dBi. The maximum e.i.r.p. at any elevation angle above 30 degrees as measured from the horizon must not exceed 125 mW (21 dBm).

(ii) For an indoor access point operating in the band 5.15-5.25 GHz, the maximum conducted output power over the frequency band of operation shall not exceed 1 W provided the maximum antenna gain does not exceed 6 dBi. In addition, the maximum power spectral density shall not exceed 17 dBm in any 1 megahertz band. If transmitting antennas of directional gain greater than 6 dBi are used, both the maximum conducted output power and the maximum power spectral density shall be reduced by the amount in dB that the directional gain of the antenna exceeds 6 dBi.

(iii) For fixed point-to-point access points operating in the band 5.15-5.25 GHz, the maximum conducted output power over the frequency band of operation shall not exceed 1 W. In addition, the maximum power spectral density shall not exceed 17 dBm in any 1 megahertz band. Fixed point-to-point U-NII devices may employ antennas with directional gain up to 23 dBi without any corresponding reduction in the maximum conducted output power or maximum power spectral density. For fixed point-to-point transmitters that employ a directional antenna gain greater than 23 dBi, a 1 dB reduction in maximum conducted output power and maximum power spectral density is required for each 1 dB of antenna gain in excess of 23 dBi. Fixed, point-to-point operations exclude



the use of point-to-multipoint systems, omnidirectional applications, and multiple collocated transmitters transmitting the same information. The operator of the U-NII device, or if the equipment is professionally installed, the installer, is responsible for ensuring that systems employing high gain directional antennas are used exclusively for fixed, point-to-point operations.

(iv) For client devices in the 5.15-5.25 GHz band, the maximum conducted output power over the frequency band of operation shall not exceed 250 mW provided the maximum antenna gain does not exceed 6 dBi. In addition, the maximum power spectral density shall not exceed 11 dBm in any 1 megahertz band. If transmitting antennas of directional gain greater than 6 dBi are used, both the maximum conducted output power and the maximum power spectral density shall be reduced by the amount in dB that the directional gain of the antenna exceeds 6 dBi.

(2) For the 5.25-5.35 GHz and 5.47-5.725 GHz bands, the maximum conducted output power over the frequency bands of operation shall not exceed the lesser of 250 mW or 11 dBm + 10 log B, where B is the 26 dB emission bandwidth in megahertz. In addition, the maximum power spectral density shall not exceed 11 dBm in any 1 megahertz band. If transmitting antennas of directional gain greater than 6 dBi are used, both the maximum conducted output power and the maximum power spectral density shall be reduced by the amount in dB that the directional gain of the antenna exceeds 6 dBi.

(3) For the band 5.725-5.85 GHz, the maximum conducted output power over the frequency band of operation shall not exceed 1 W. In addition, the maximum power spectral density shall not exceed 30 dBm in any 500-kHz band. If transmitting antennas of directional gain greater than 6 dBi are used, both the maximum conducted output power and the maximum power spectral density shall be reduced by the amount in dB that the directional gain of the antenna exceeds 6 dBi.

Measurement Uncertainty

The assessed measurement uncertainty to ensure 95% confidence level for the normal distribution is with the coverage factor $k = 2$, $U = 0.44$ dB.

Test Results

Mode	T _{on} (ms)	T _(on+off) (ms)	Duty cycle	Duty cycle correction Factor(dB)
802.11a	2.06	2.10	0.98	0.00
802.11n HT20	1.92	1.96	0.98	0.00
802.11n HT40	0.94	0.98	0.96	0.19
802.11ac VHT20	1.93	1.97	0.98	0.00
802.11ac VHT40	0.95	0.98	0.96	0.19
802.11ac VHT80	0.46	0.50	0.93	0.32

Note: when Duty cycle ≥ 0.98 , Duty cycle correction Factor not required.



Test Mode		Channel/Frequency (MHz)	B=26 dB bandwidth (MHz)	Limit 11 dBm + 10 log B (dBm)	Final Limit(dBm)
U-NII-2A	802.11a	52/5260	29.39	25.68>24	24.00
		60/5300	30.00	25.77>24	24.00
		64/5320	26.37	25.21>24	24.00
	802.11n HT20	52/5260	29.94	25.76>24	24.00
		60/5300	30.00	25.77>24	24.00
		64/5320	26.29	25.20>24	24.00
	802.11n HT40	54/5270	59.72	28.76>24	24.00
		62/5310	40.78	27.10>24	24.00
	802.11ac VHT20	52/5260	30.00	25.77>24	24.00
		60/5300	30.00	25.77>24	24.00
		64/5320	27.93	25.46>24	24.00
	802.11ac VHT40	54/5270	59.57	28.75>24	24.00
		62/5310	40.76	27.10>24	24.00
802.11ac VHT80	58/5290	82.99	30.19>24	24.00	
U-NII-2C	802.11a	100/5500	29.98	25.77>24	24.00
		104/5520	29.99	25.77>24	24.00
		120/5600	30.00	25.77>24	24.00
		136/5680	30.00	25.77>24	24.00
		140/5700	22.84	24.59>24	24.00
	802.11n HT20	100/5500	29.93	25.76>24	24.00
		104/5520	29.99	25.77>24	24.00
		120/5600	30.00	25.77>24	24.00
		136/5680	30.00	25.77>24	24.00
		140/5700	25.67	25.09>24	24.00
	802.11n HT40	102/5510	41.59	27.19>24	24.00
		110/5550	59.84	28.77>24	24.00
		118/5590	59.97	28.78>24	24.00
		126/5630	60.00	28.78>24	24.00
		134/5670	59.81	28.77>24	24.00
		142/5710	59.96	28.78>24	24.00
	802.11ac VHT20	100/5500	29.04	25.63>24	24.00
		104/5520	30.00	25.77>24	24.00
		120/5600	30.00	25.77>24	24.00
		136/5680	30.00	25.77>24	24.00
		140/5700	25.51	25.07>24	24.00
	802.11ac	102/5510	40.88	27.12>24	24.00



	VHT40	110/5550	59.93	28.78>24	24.00
		118/5590	59.99	28.78>24	24.00
		126/5630	59.90	28.77>24	24.00
		134/5670	59.83	28.77>24	24.00
		142/5710	59.99	28.78>24	24.00
	802.11ac VHT80	106/5530	82.78	30.18>24	24.00
		122/5610	120.00	31.79>24	24.00
		138/5690	119.90	31.79>24	24.00

Note: 250mW=24dBm



Note: Average Power with duty factor = Average Power Measured +Duty cycle correction factor

U-NII-1

Test Mode	Channel/ Frequency (MHz)	Average Power Measured (dBm)	Average Power with duty factor (dBm)	Limit (dBm)	Conclusion
802.11a	36/5180	14.71	14.71	24	PASS
	40/5200	18.35	18.35	24	PASS
	48/5240	17.88	17.88	24	PASS
802.11n HT20	36/5180	14.62	14.62	24	PASS
	40/5200	18.28	18.28	24	PASS
	48/5240	17.72	17.72	24	PASS
802.11n HT40	38/5190	8.63	8.82	24	PASS
	46/5230	17.25	17.44	24	PASS
802.11ac VHT20	36/5180	14.50	14.50	24	PASS
	40/5200	18.01	18.01	24	PASS
	48/5240	17.51	17.51	24	PASS
802.11ac VHT40	38/5190	8.64	8.83	24	PASS
	46/5230	17.21	17.40	24	PASS
802.11ac VHT80	42/5210	7.53	7.85	24	PASS

Note: Average Power with duty factor = Average Power Measured +Duty cycle correction factor



U-NII-2A

Test Mode	Channel/ Frequency (MHz)	Average Power Measured (dBm)	Average Power with duty factor (dBm)	Limit (dBm)	Conclusion
802.11a	52/5260	18.05	18.05	24.00	PASS
	60/5300	18.30	18.30	24.00	PASS
	64/5320	15.28	15.28	24.00	PASS
802.11n HT20	52/5260	18.02	18.02	24.00	PASS
	60/5300	18.32	18.32	24.00	PASS
	64/5320	15.42	15.42	24.00	PASS
802.11n HT40	54/5270	17.10	17.29	24.00	PASS
	62/5310	9.05	9.24	24.00	PASS
802.11ac VHT20	52/5260	18.35	18.35	24.00	PASS
	60/5300	18.21	18.21	24.00	PASS
	64/5320	15.51	15.51	24.00	PASS
802.11ac VHT40	54/5270	17.06	17.25	24.00	PASS
	62/5310	9.02	9.21	24.00	PASS
802.11ac VHT80	58/5290	7.08	7.40	24.00	PASS

Note: Average Power with duty factor = Average Power Measured +Duty cycle correction factor

U-NII-2C

Test Mode	Channel/ Frequency (MHz)	Average Power Measured (dBm)	Average Power with duty factor (dBm)	Limit (dBm)	Conclusion
802.11a	100/5500	15.94	15.94	24.00	PASS
	104/5520	17.63	17.63	24.00	PASS
	120/5600	17.86	17.86	24.00	PASS
	136/5680	18.08	18.08	24.00	PASS
	140/5700	13.52	13.52	24.00	PASS
802.11n HT20	100/5500	16.04	16.04	24.00	PASS
	104/5520	17.65	17.65	24.00	PASS
	120/5600	17.73	17.73	24.00	PASS
	136/5680	18.01	18.01	24.00	PASS
	140/5700	13.02	13.02	24.00	PASS
802.11n HT40	102/5510	9.24	9.43	24.00	PASS
	110/5550	16.71	16.90	24.00	PASS
	118/5590	17.02	17.21	24.00	PASS



	126/5630	16.74	16.93	24.00	PASS
	134/5670	16.21	16.40	24.00	PASS
	142/5710	17.16	17.35	24.00	PASS
802.11ac VHT20	100/5500	16.13	16.13	24.00	PASS
	104/5520	17.52	17.52	24.00	PASS
	120/5600	17.73	17.73	24.00	PASS
	136/5680	18.10	18.10	24.00	PASS
	140/5700	13.09	13.09	24.00	PASS
802.11ac VHT40	102/5510	9.23	9.42	24.00	PASS
	110/5550	16.64	16.83	24.00	PASS
	118/5590	16.96	17.15	24.00	PASS
	126/5630	16.68	16.87	24.00	PASS
	134/5670	16.80	16.99	24.00	PASS
	142/5710	17.11	17.30	24.00	PASS
802.11ac VHT80	106/5530	8.84	9.16	24.00	PASS
	122/5610	16.47	16.79	24.00	PASS
	138/5690	16.65	16.97	24.00	PASS

Note: Average Power with duty factor = Average Power Measured +Duty cycle correction factor

U-NII-3

Test Mode	Channel/ Frequency (MHz)	Average Power Measured (dBm)	Average Power with duty factor (dBm)	Limit (dBm)	Conclusion
802.11a	149/5745	18.03	18.03	30	PASS
	157/5785	17.87	17.87	30	PASS
	165/5825	17.38	17.38	30	PASS
802.11n HT20	149/5745	17.83	17.83	30	PASS
	157/5785	17.82	17.82	30	PASS
	165/5825	17.34	17.34	30	PASS
802.11n HT40	151/5755	16.84	17.03	30	PASS
	159/5795	16.59	16.78	30	PASS
802.11ac VHT20	149/5745	17.88	17.88	30	PASS
	157/5785	17.90	17.90	30	PASS
	165/5825	17.40	17.40	30	PASS
802.11ac VHT40	151/5755	16.82	17.01	30	PASS
	159/5795	16.54	16.73	30	PASS
802.11ac VHT80	155/5775	16.48	16.80	30	PASS

Note: Average Power with duty factor = Average Power Measured +Duty cycle correction factor

5.3. Frequency Stability

Ambient condition

Temperature	Relative humidity	Pressure
23°C ~25°C	45%~50%	101.5kPa

Method of Measurement

1. Frequency stability with respect to ambient temperature

a) Supply the EUT with a nominal ac voltage or install a new or fully charged battery in the EUT. If possible, a dummy load shall be connected to the EUT because an antenna near the metallic walls of an environmental test chamber could affect the output frequency of the EUT. If the EUT is equipped with a permanently attached, adjustable-length antenna, then the EUT shall be placed in the center of the chamber with the antenna adjusted to the shortest length possible. Turn ON the EUT and tune it to one of the number of frequencies shown in 5.6.

b) Couple the unlicensed wireless device output to the measuring instrument by connecting an antenna to the measuring instrument with a suitable length of coaxial cable and placing the measuring antenna near the EUT (e.g., 15 cm away), or by connecting a dummy load to the measuring instrument, through an attenuator if necessary.

c) Adjust the location of the measurement antenna and the controls on the measurement instrument to obtain a suitable signal level (i.e., a level that will not overload the measurement instrument but is strong enough to allow measurement of the operating or fundamental frequency of the EUT).

d) Turn the EUT OFF and place it inside the environmental temperature chamber. For devices that have oscillator heaters, energize only the heater circuit.

e) Set the temperature control on the chamber to the highest specified in the regulatory requirements for the type of device and allow the oscillator heater and the chamber temperature to stabilize.

f) While maintaining a constant temperature inside the environmental chamber, turn the EUT ON and record the operating frequency at startup, and at 2 minutes, 5 minutes, and 10 minutes after the EUT is energized. Four measurements in total are made.

g) Measure the frequency at each of frequencies specified in 5.6.

h) Switch OFF the EUT but do not switch OFF the oscillator heater.

i) Lower the chamber temperature by not more than 10°C, and allow the temperature inside the chamber to stabilize.

j) Repeat step f) through step i) down to the lowest specified temperature.

2. Frequency stability when varying supply voltage

Unless otherwise specified, these tests shall be made at ambient room temperature (+15°C to +25 °C). An antenna shall be connected to the antenna output terminals of the EUT if possible. If the EUT is equipped with or uses an adjustable-length antenna, then it shall be fully extended.

a) Supply the EUT with nominal voltage or install a new or fully charged battery in the EUT. Turn ON the EUT and couple its output to a frequency counter or other frequency-measuring instrument.



- b) Tune the EUT to one of the number of frequencies required in 5.6. Adjust the location of the measurement antenna and the controls on the measurement instrument to obtain a suitable signal level (i.e., a level that will not overload the measurement instrument but is strong enough to allow measurement of the operating or fundamental frequency of the EUT).
- c) Measure the frequency at each of the frequencies specified in 5.6.
- d) Repeat the above procedure at 85% and 115% of the nominal supply voltage.

Limit

Manufacturers of U-NII devices are responsible for ensuring frequency stability such that an emission is maintained within the band of operation under all conditions of normal operation as specified in the users manual.

Measurement Uncertainty

The assessed measurement uncertainty to ensure 95% confidence level for the normal distribution is with the coverage factor $k = 2$, $U = 936\text{Hz}$

**Test Results**

Voltage (V)	Temperature (°C)	U-NII-1 Test Results			
		5200MHz			
		1min	2min	5min	10min
3.87	0	5200.001293	5199.999592	5199.998082	5199.988264
3.87	5	5199.999441	5199.998968	5199.995746	5199.986861
3.87	10	5199.998321	5199.998730	5199.988620	5199.986743
3.87	15	5199.994880	5199.998384	5199.988508	5199.980515
3.87	20	5199.993385	5199.995388	5199.984059	5199.970736
3.87	25	5199.986100	5199.991732	5199.979243	5199.969853
3.87	30	5199.978349	5199.990836	5199.977773	5199.965795
3.87	35	5199.971830	5199.984946	5199.976257	5199.955962
3.6	20	5199.969548	5199.977134	5199.970890	5199.952702
4.45	20	5199.962433	5199.968492	5199.969444	5199.948462
Max. ΔMHz		-0.037567	-0.031508	-0.030556	-0.051538
PPM		-7.224481	-6.059267	-5.876246	-9.911214

Voltage (V)	Temperature (°C)	U-NII-2A Test Results			
		5300MHz			
		1min	2min	5min	10min
3.87	0	5299.993478	5299.985633	5299.984600	5299.980642
3.87	5	5299.989853	5299.985026	5299.980854	5299.972688
3.87	10	5299.981973	5299.981144	5299.979801	5299.972256
3.87	15	5299.980697	5299.973074	5299.979403	5299.967480
3.87	20	5299.973858	5299.964842	5299.969410	5299.959005
3.87	25	5299.967850	5299.963980	5299.966377	5299.956623
3.87	30	5299.960986	5299.957787	5299.959760	5299.949638
3.87	35	5299.954624	5299.951759	5299.956655	5299.947434
3.6	20	5299.950391	5299.942249	5299.949529	5299.941257
4.45	20	5299.940956	5299.933624	5299.943297	5299.939009
Max. ΔMHz		-0.059044	-0.066376	-0.056703	-0.060991
PPM		-11.140411	-12.523864	-10.698655	-11.507774



Voltage (V)	Temperature (°C)	U-NII-2C Test Results			
		5580MHz			
		1min	2min	5min	10min
3.87	0	5579.999737	5579.994462	5579.987544	5579.986518
3.87	5	5579.991837	5579.988420	5579.983437	5579.981312
3.87	10	5579.984139	5579.979004	5579.974693	5579.977057
3.87	15	5579.983913	5579.970871	5579.968292	5579.976592
3.87	20	5579.979478	5579.961703	5579.958299	5579.971057
3.87	25	5579.978666	5579.954185	5579.954550	5579.964995
3.87	30	5579.970726	5579.952995	5579.951315	5579.957024
3.87	35	5579.963634	5579.948864	5579.944561	5579.952291
3.6	20	5579.961433	5579.948678	5579.941585	5579.942348
4.45	20	5579.960923	5579.945122	5579.935922	5579.937054
Max. ΔMHz		-0.039077	-0.054878	-0.064078	-0.062946
PPM		-7.002977	-9.834679	-11.483430	-11.280647

Voltage (V)	Temperature (°C)	U-NII-3 Test Results			
		5785MHz			
		1min	2min	5min	10min
3.87	0	5784.991236	5784.983896	5784.980198	5784.976563
3.87	5	5784.985365	5784.978247	5784.971454	5784.968207
3.87	10	5784.979029	5784.971591	5784.966780	5784.963912
3.87	15	5784.978239	5784.968034	5784.961790	5784.957303
3.87	20	5784.971997	5784.961977	5784.957821	5784.954843
3.87	25	5784.964066	5784.957564	5784.953011	5784.949345
3.87	30	5784.963318	5784.955978	5784.951909	5784.949285
3.87	35	5784.953765	5784.952611	5784.948179	5784.948348
3.6	20	5784.950461	5784.948032	5784.946212	5784.938955
4.45	20	5784.946590	5784.944729	5784.937083	5784.935307
Max. ΔMHz		-0.053410	-0.055271	-0.062917	-0.064693
PPM		-9.232541	-9.554276	-10.875835	-11.182895

5.4. Power Spectral Density

Ambient condition

Temperature	Relative humidity	Pressure
23°C ~25°C	45%~50%	101.5kPa

Method of Measurement

The EUT was connected to the spectrum analyzer through an external attenuator (20dB) and a known loss cable.

Set RBW = 1MHz, VBW =3MHz for the band 5.150-5.250GHz, 5.250-5.350GHz, 5.470-5.725GHz.
 Set RBW = 470kHz, VBW =1.5MHz for the band 5.725-5.850GHz

The conducted PSD is measured at each antenna port. The measured results at the various antenna ports are then summed mathematically.

Test setup

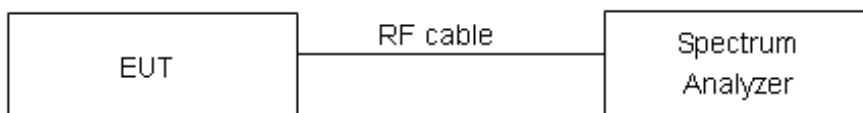

Limits

Rule FCC Part 15.407(a)(1)/ Part 15.407(a)(2) / Part 15.407(a)(3)

For an indoor access point operating in the band 5.15-5.25 GHz, the maximum power spectral density shall not exceed 17 dBm in any 1 megahertz band. If transmitting antennas of directional gain greater than 6 dBi are used, both the maximum conducted output power and the maximum power spectral density shall be reduced by the amount in dB that the directional gain of the antenna exceeds 6 dBi.

For client devices in the 5.15-5.25 GHz band, the maximum conducted output power over the frequency band of operation shall not exceed 250 mW provided the maximum antenna gain does not exceed 6 dBi. In addition, the maximum power spectral density shall not exceed 11 dBm in any 1 megahertz band. If transmitting antennas of directional gain greater than 6 dBi are used, both the maximum conducted output power and the maximum power spectral density shall be reduced by the amount in dB that the directional gain of the antenna exceeds 6 dBi.

For the 5.25-5.35 GHz and 5.47-5.725 GHz bands, the maximum power spectral density shall not exceed 11 dBm in any 1 megahertz band. If transmitting antennas of directional gain greater than 6 dBi are used, both the maximum conducted output power and the maximum power spectral density shall be reduced by the amount in dB that the directional gain of the antenna exceeds 6 dBi.

For the band 5.725-5.85 GHz, the maximum power spectral density shall not exceed 30 dBm in any 500kHz band. If transmitting antennas of directional gain greater than 6 dBi are used, both the maximum conducted output power and the maximum power spectral density shall be reduced by the



amount in dB that the directional gain of the antenna exceeds 6 dBi.

Frequency Bands/MHz	Limits
5150-5250	11dBm/MHz
5.25-5.35 GHz and 5.47-5.725 GHz	11dBm/MHz
5725-5850	30dBm/500kHz

Measurement Uncertainty

The assessed measurement uncertainty to ensure 95% confidence level for the normal distribution is with the coverage factor $k = 2$, $U = 0.75\text{dB}$.

**Test Results:**

Note: Power Spectral Density =Read Value+Duty cycle correction factor

U-NII-1

Mode	Channel Number	Read Value (dBm /MHz)	Power Spectral Density (dBm /MHz)	Limit (dBm /MHz)	Conclusion
802.11a	36	-8.86	-8.86	11	PASS
	40	9.26	9.26	11	PASS
	48	8.72	8.72	11	PASS
802.11n HT20	36	4.57	4.57	11	PASS
	40	8.24	8.24	11	PASS
	48	7.85	7.85	11	PASS
802.11n HT40	38	-4.37	-4.18	11	PASS
	46	4.00	4.19	11	PASS
802.11ac VHT20	36	4.69	4.69	11	PASS
	40	8.27	8.27	11	PASS
	48	7.62	7.62	11	PASS
802.11ac VHT40	38	-4.37	-4.18	11	PASS
	46	4.00	4.19	11	PASS
802.11ac VHT80	42	-8.78	-8.46	11	PASS

U-NII-2A

Mode	Channel Number	Read Value (dBm /MHz)	Power Spectral Density (dBm /MHz)	Limit (dBm /MHz)	Conclusion
802.11a	52	8.41	8.41	11	PASS
	60	8.57	8.57	11	PASS
	64	5.63	5.63	11	PASS
802.11n HT20	52	7.85	7.85	11	PASS
	60	8.72	8.72	11	PASS
	64	5.71	5.71	11	PASS
802.11n HT40	54	4.03	4.22	11	PASS
	62	-3.78	-3.59	11	PASS
802.11ac	52	8.48	8.48	11	PASS



VHT20	60	8.39	8.39	11	PASS
	64	5.37	5.37	11	PASS
802.11ac VHT40	54	4.05	4.24	11	PASS
	62	-3.58	-3.39	11	PASS
802.11ac VHT80	58	-9.14	-8.82	11	PASS

U-NII-2C

Mode	Channel Number	Read Value (dBm /MHz)	Power Spectral Density (dBm /MHz)	Limit (dBm /MHz)	Conclusion
802.11a	100	6.90	6.90	11	PASS
	104	7.57	7.57	11	PASS
	120	7.78	7.78	11	PASS
	136	8.34	8.34	11	PASS
	140	4.46	4.46	11	PASS
802.11n HT20	100	6.96	6.96	11	PASS
	104	7.62	7.62	11	PASS
	120	7.77	7.77	11	PASS
	136	8.13	8.13	11	PASS
	140	3.92	3.92	11	PASS
802.11n HT40	102	-3.91	-3.72	11	PASS
	110	2.60	2.79	11	PASS
	118	3.64	3.83	11	PASS
	126	3.17	3.36	11	PASS
	134	3.80	3.99	11	PASS
	142	3.78	3.97	11	PASS
802.11ac VHT20	100	7.08	7.08	11	PASS
	104	7.84	7.84	11	PASS
	120	7.44	7.44	11	PASS
	136	8.00	8.00	11	PASS
	140	4.11	4.11	11	PASS
802.11ac VHT40	102	-3.84	-3.65	11	PASS
	110	3.96	4.15	11	PASS
	118	3.96	4.15	11	PASS
	126	3.71	3.90	11	PASS



	134	4.28	4.47	11	PASS
	142	4.07	4.26	11	PASS
802.11ac VHT80	106	-7.38	-7.06	11	PASS
	122	0.13	0.45	11	PASS
	138	0.74	1.06	11	PASS

U-NII-3

Mode	Channel Number	Read Value (dBm/470kHz)	Power Spectral Density (dBm/500kHz)	Limit (dBm/500kHz)	Conclusion
802.11a	149	5.67	5.94	30	PASS
	157	5.35	5.62	30	PASS
	165	5.16	5.43	30	PASS
802.11n HT20	149	4.64	4.91	30	PASS
	157	4.38	4.65	30	PASS
	165	4.17	4.44	30	PASS
802.11n HT40	151	-0.26	0.20	30	PASS
	159	-0.38	0.08	30	PASS
802.11ac VHT20	149	4.35	4.62	30	PASS
	157	4.13	4.40	30	PASS
	165	3.89	4.16	30	PASS
802.11ac VHT40	151	-0.04	0.42	30	PASS
	159	-0.38	0.08	30	PASS
802.11ac VHT80	155	-3.67	-3.08	30	PASS

Note: PSD=Read Value+Duty cycle+10*LOG(500/470) correction factor

U-NII-1, 802.11a, Channel No.: 36



U-NII-1, 802.11n HT20, Channel No.: 36

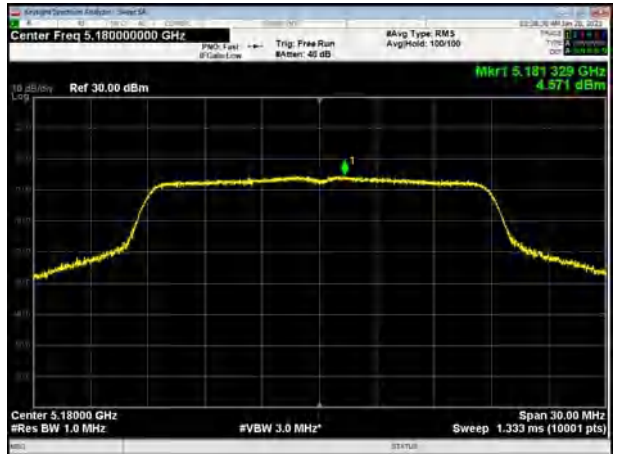

U-NII-1, 802.11a, Channel No.: 40



U-NII-1, 802.11n HT20, Channel No.: 40

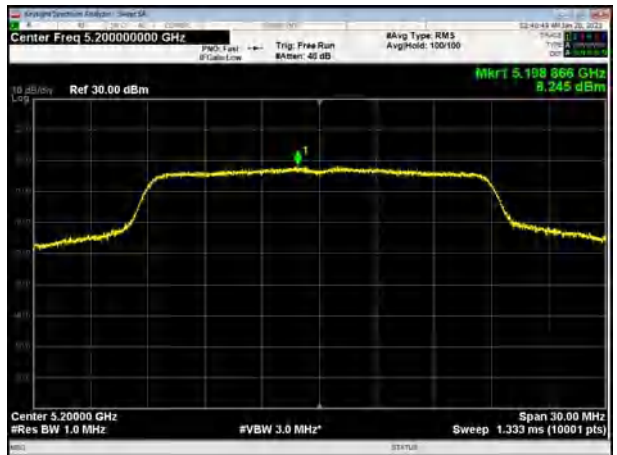

U-NII-1, 802.11a, Channel No.: 48

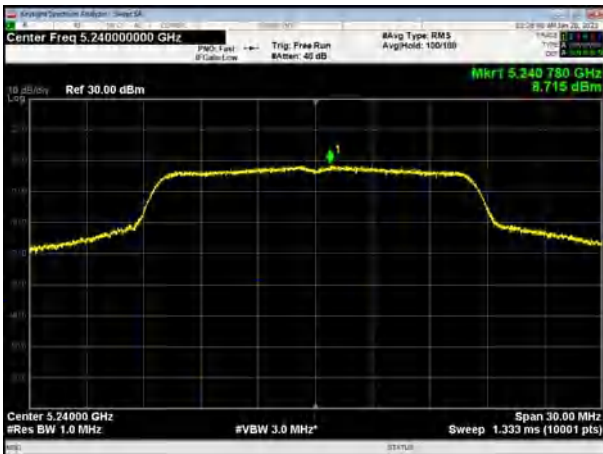

U-NII-1, 802.11n HT20, Channel No.: 48

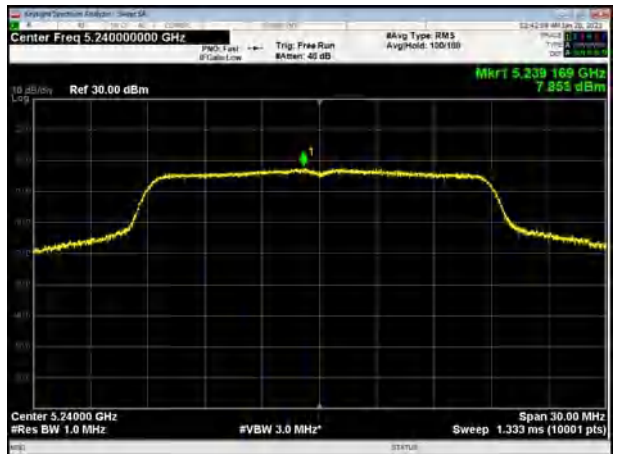

U-NII-1, 802.11n HT40, Channel No.: 38



U-NII-1, 802.11ac VHT20, Channel No.: 36

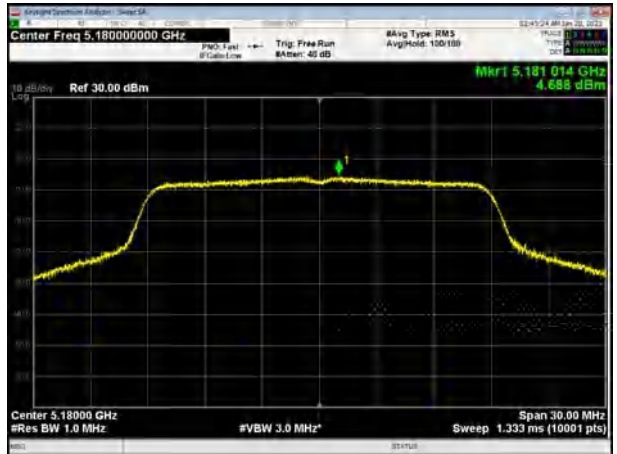

U-NII-1, 802.11n HT40, Channel No.: 46

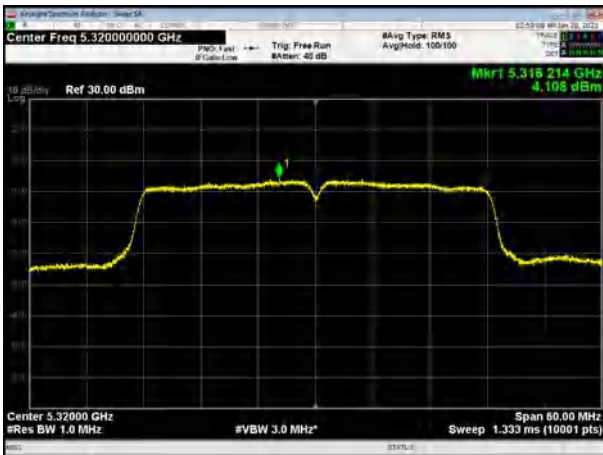

U-NII-1, 802.11ac VHT20, Channel No.: 40

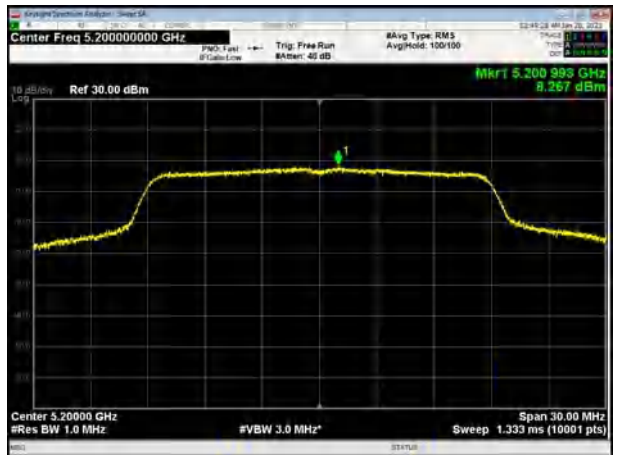

U-NII-1, 802.11ac VHT40, Channel No.: 38

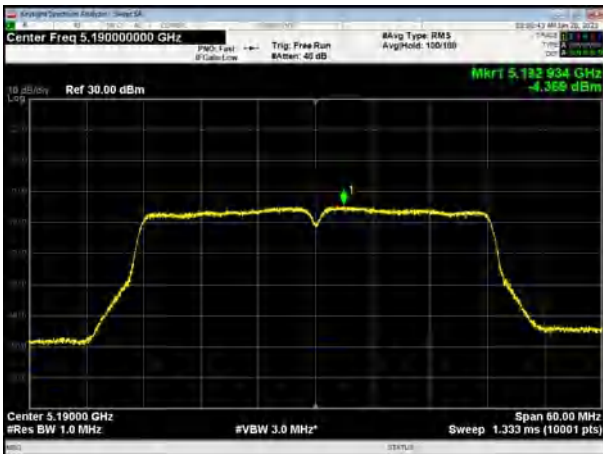

U-NII-1, 802.11ac VHT20, Channel No.: 48

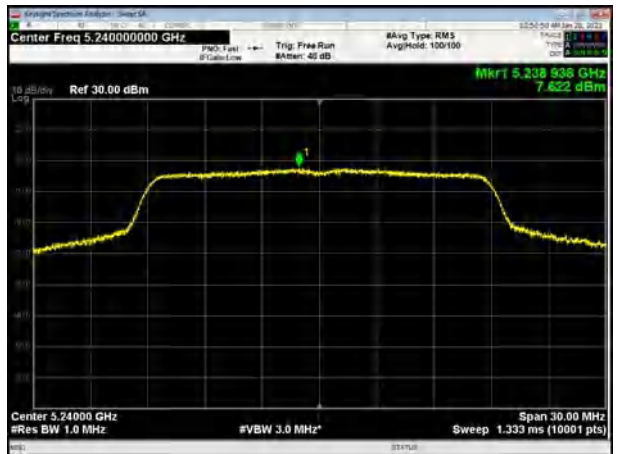

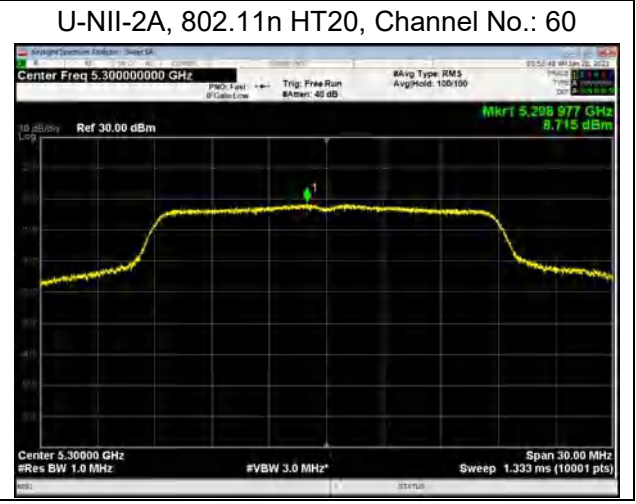
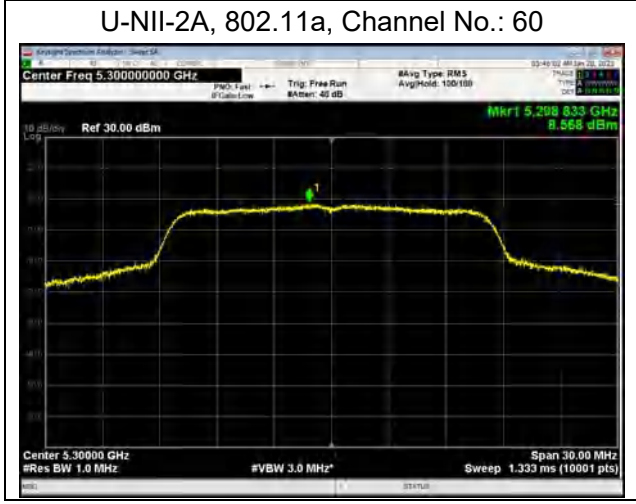
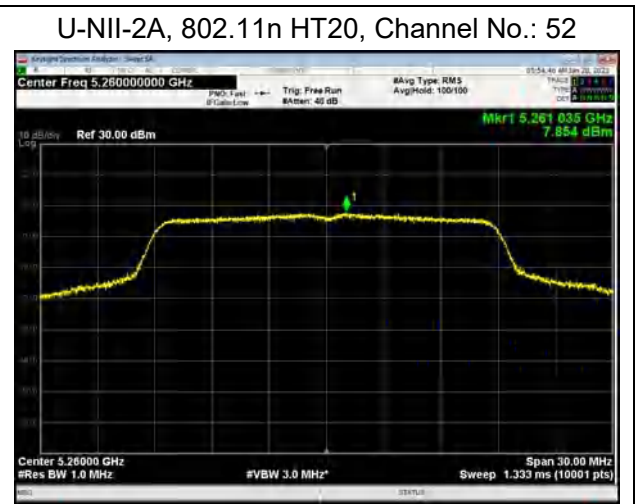
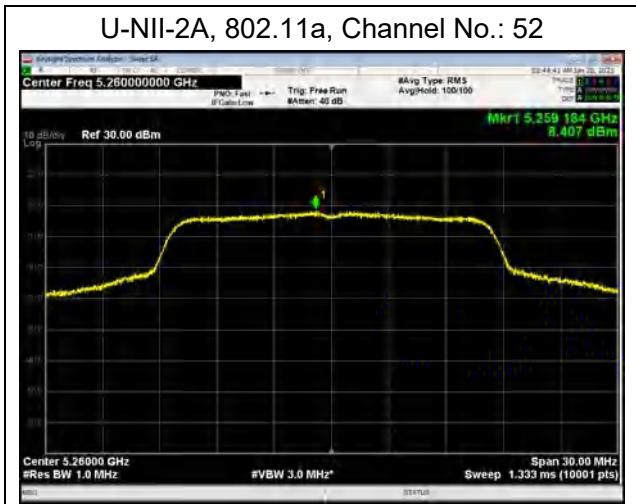
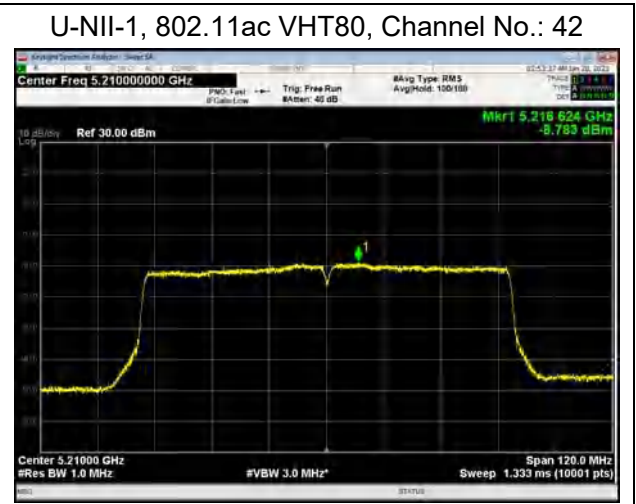
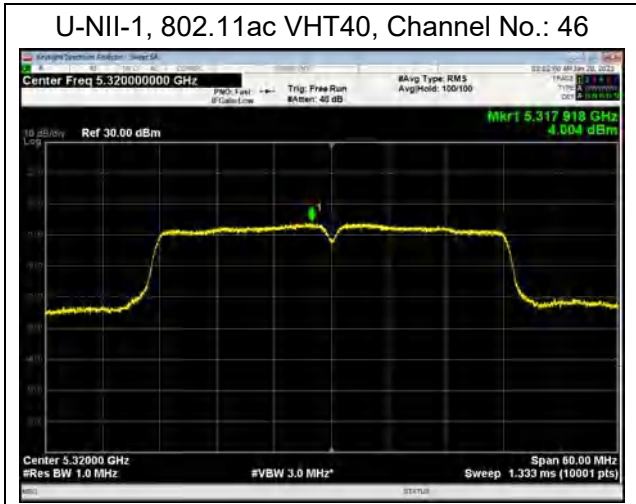

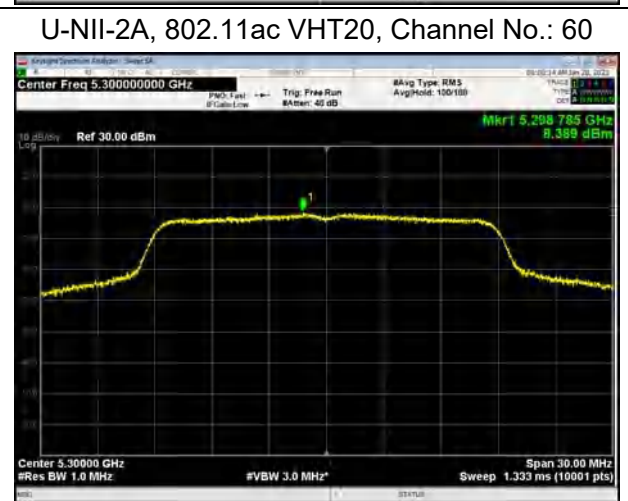
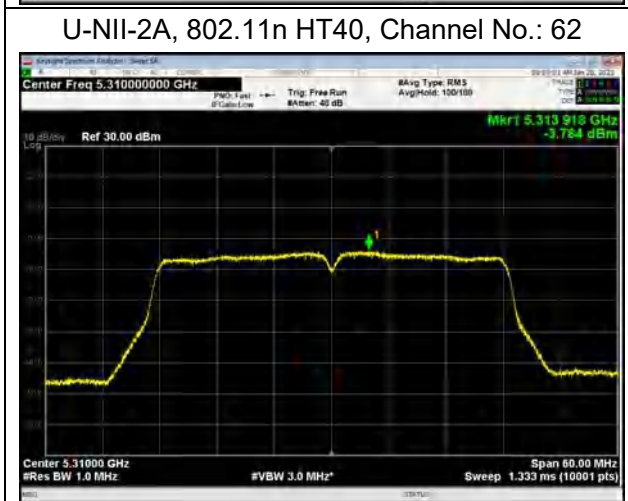
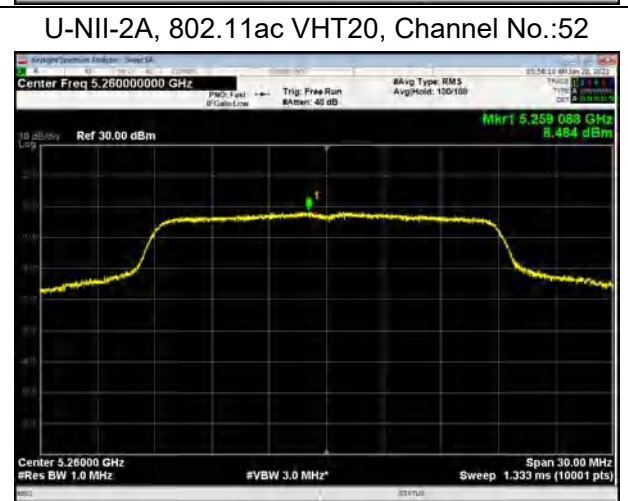
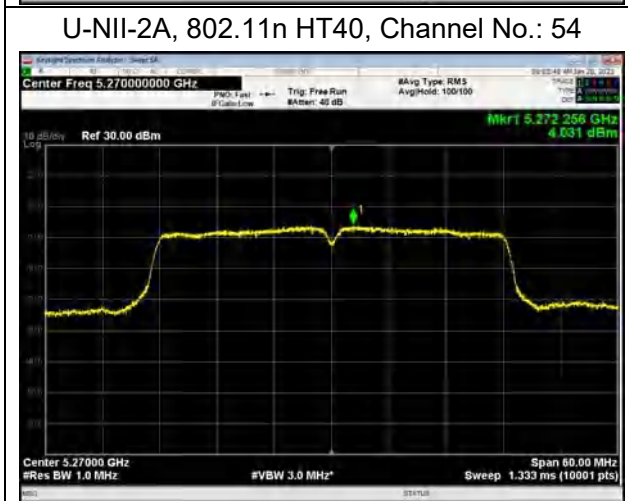
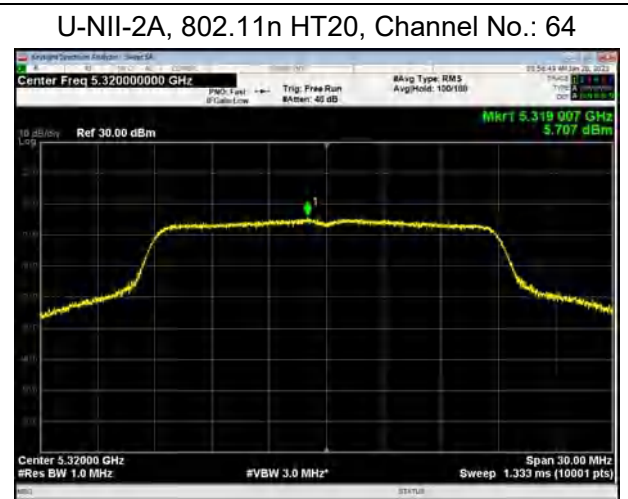
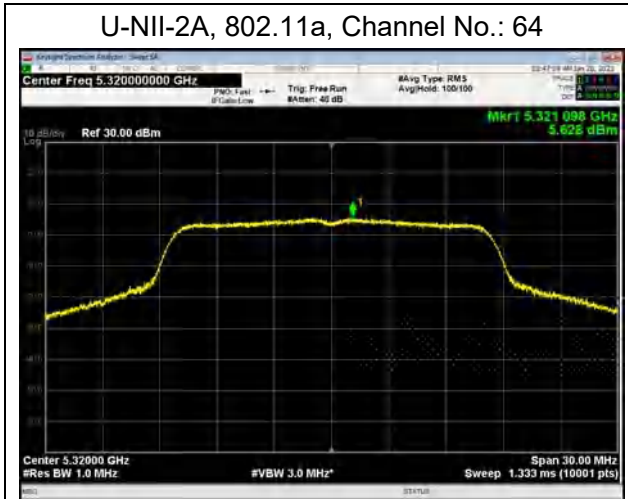

U-NII-2A, 802.11ac VHT40, Channel No.: 54

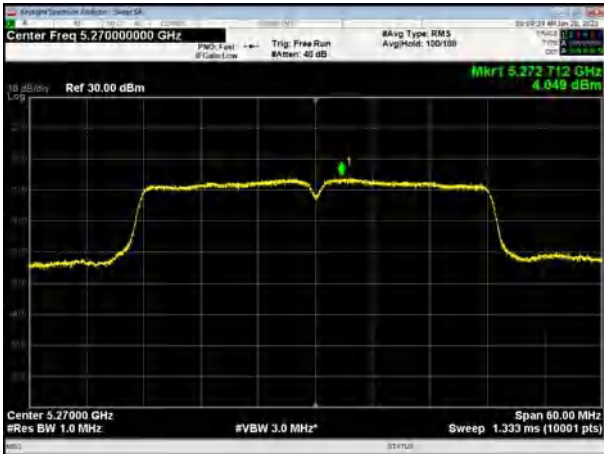

U-NII-2A, 802.11ac VHT20, Channel No.: 64

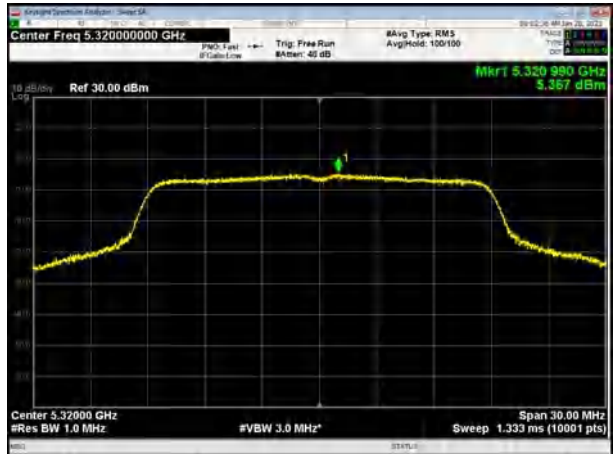

U-NII-2A, 802.11ac VHT40, Channel No.: 62

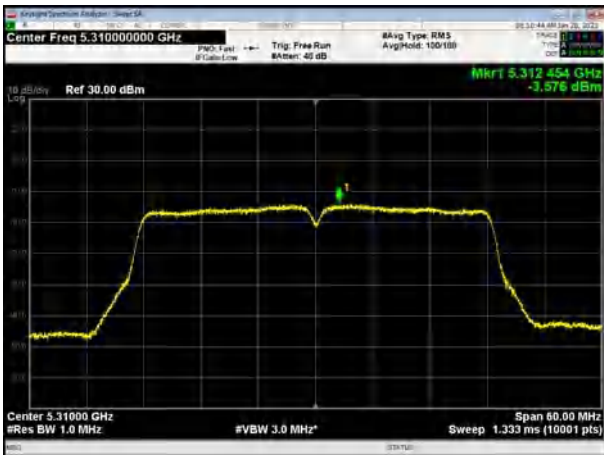

U-NII-2A, 802.11ac VHT80, Channel No.: 58

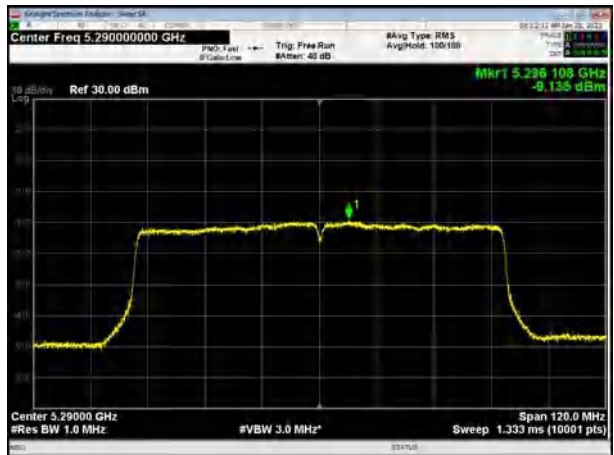



U-NII-2C, 802.11a, Channel No.: 100

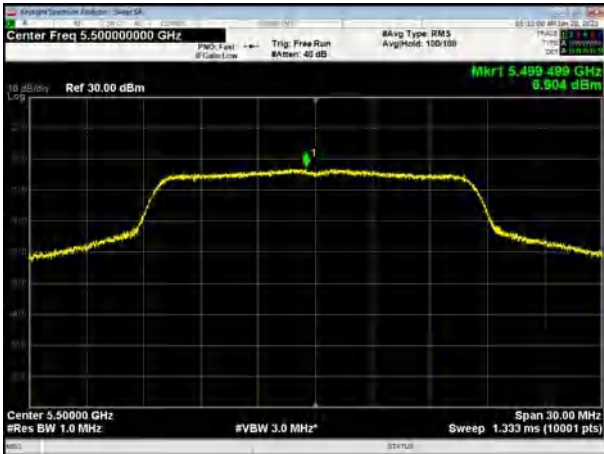

U-NII-2C, 802.11n HT20, Channel No.: 100



U-NII-2C, 802.11a, Channel No.: 104

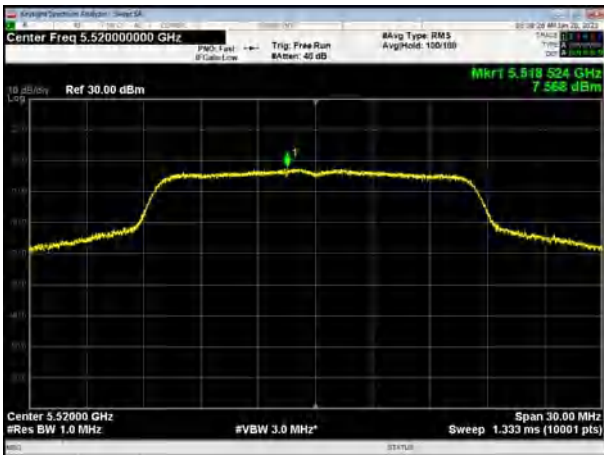

U-NII-2C, 802.11n HT20, Channel No.: 104

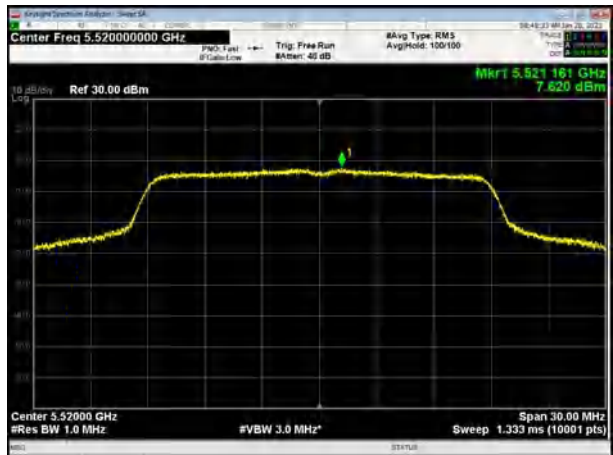

U-NII-2C, 802.11a, Channel No.: 120



U-NII-2C, 802.11n HT20, Channel No.: 120

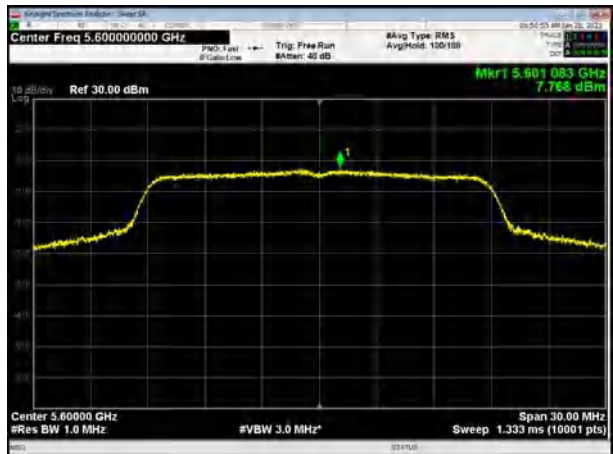

U-NII-2C, 802.11a, Channel No.: 136



U-NII-2C, 802.11n HT20, Channel No.: 136

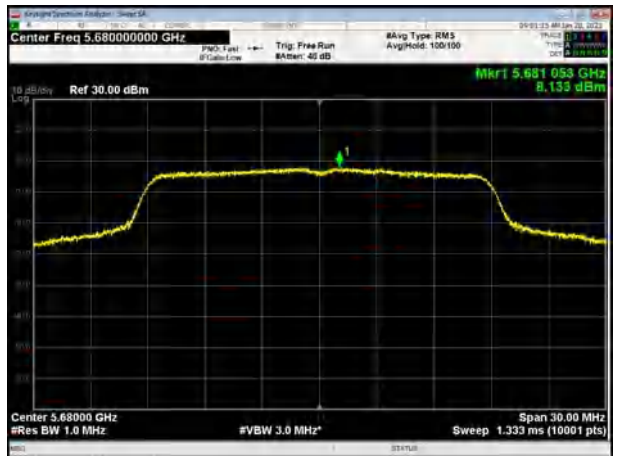

U-NII-2C, 802.11a, Channel No.: 140



U-NII-2C, 802.11n HT20, Channel No.: 140

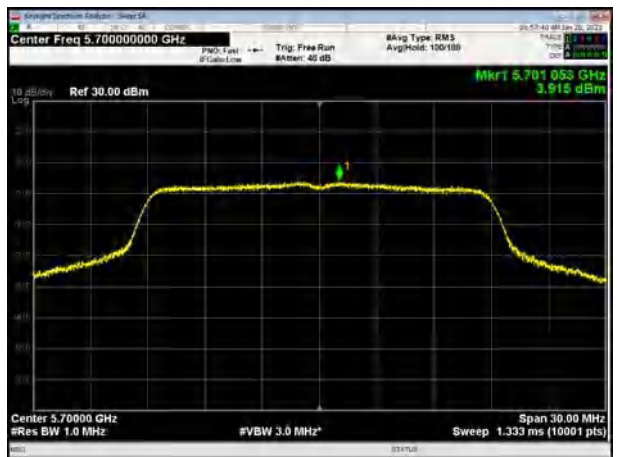

U-NII-2C, 802.11n HT40, Channel No.: 102



U-NII-2C, 802.11ac VHT20, Channel No.: 100

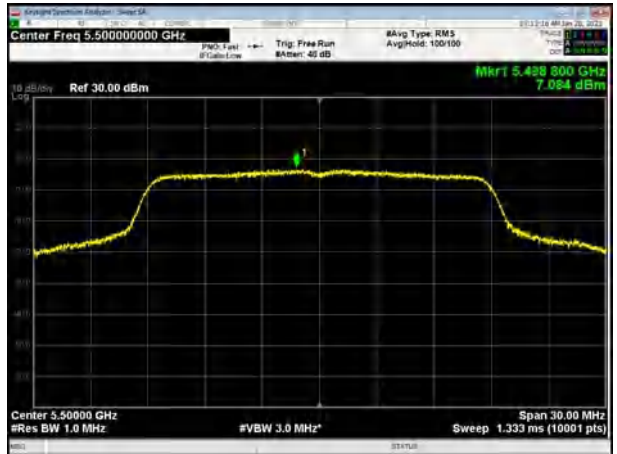

U-NII-2C, 802.11n HT40, Channel No.: 110

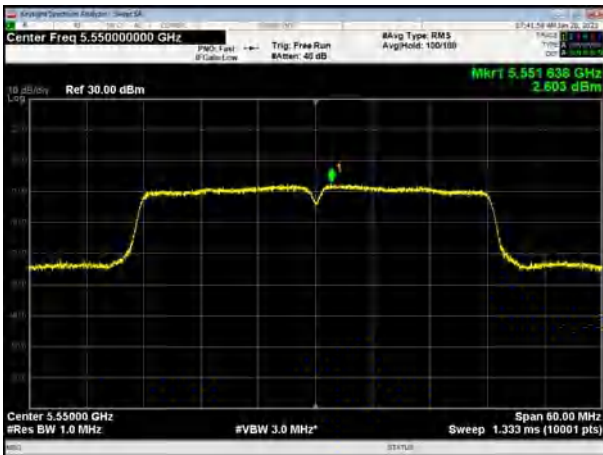

U-NII-2C, 802.11ac VHT20, Channel No.: 104

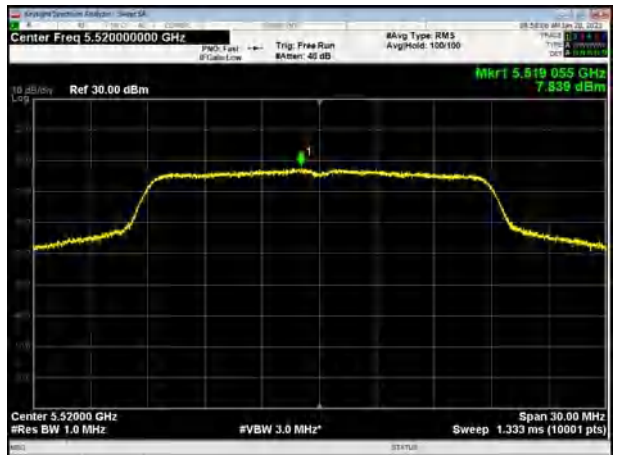

U-NII-2C, 802.11n HT40, Channel No.: 118

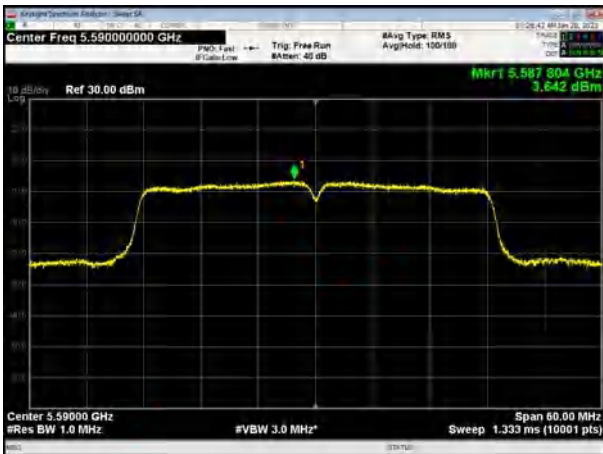

U-NII-2C, 802.11ac VHT20, Channel No.: 120

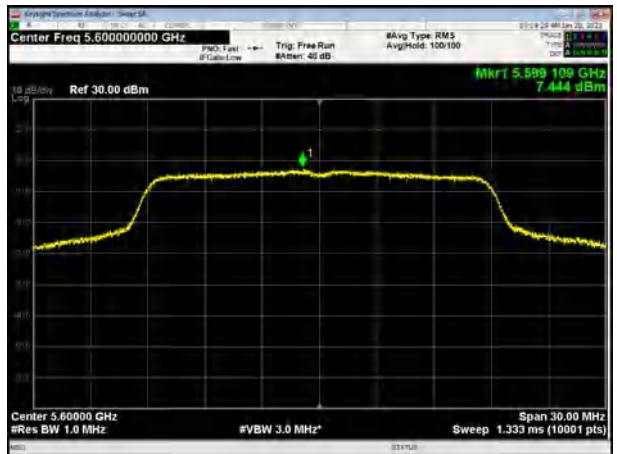

U-NII-2C, 802.11n HT40, Channel No.: 126



U-NII-2C, 802.11ac VHT20, Channel No.: 136

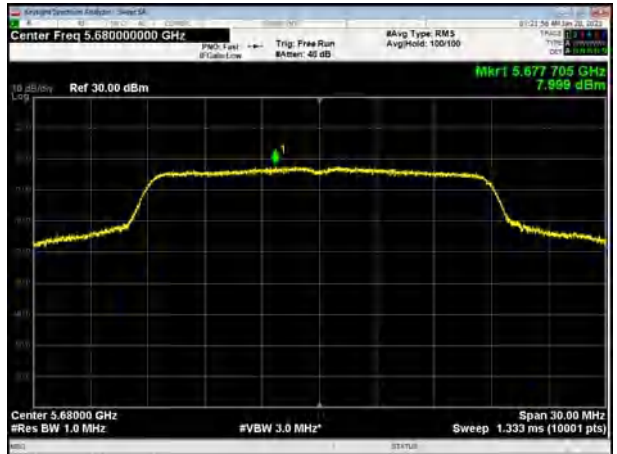

U-NII-2C, 802.11n HT40, Channel No.: 134

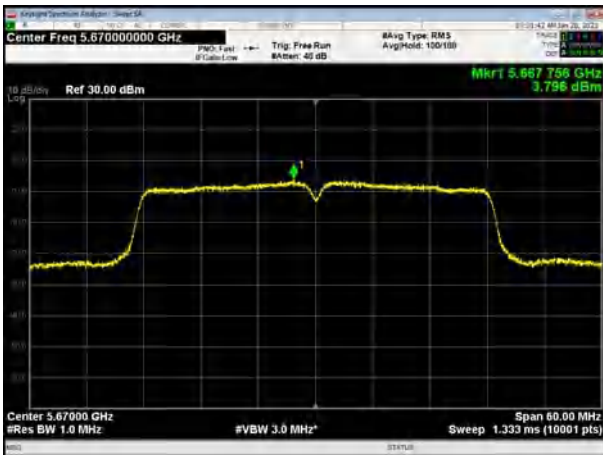

U-NII-2C, 802.11ac VHT20, Channel No.: 140

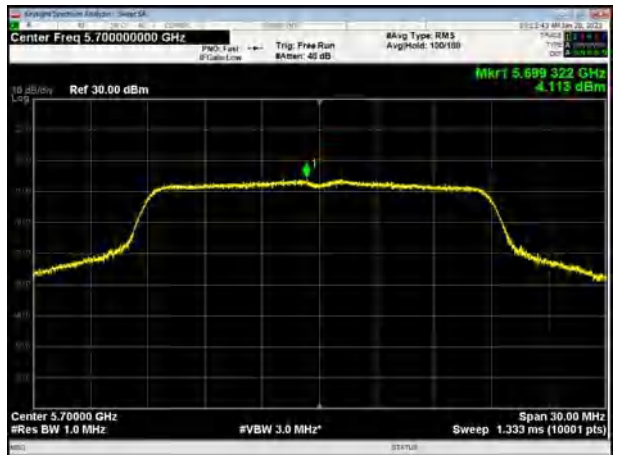

U-NII-2C, 802.11n HT40, Channel No.: 142

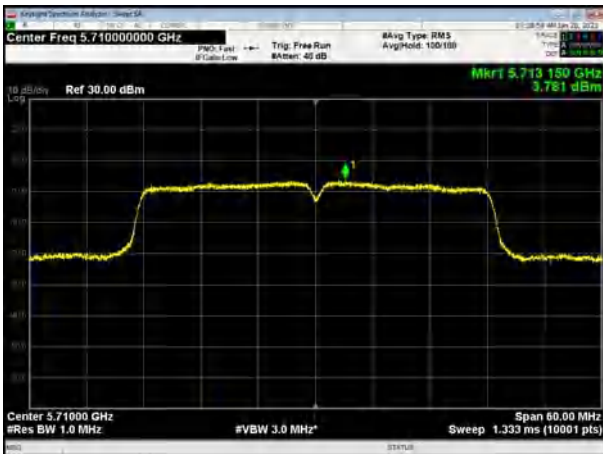

U-NII-2C, 802.11ac VHT40, Channel No.: 102

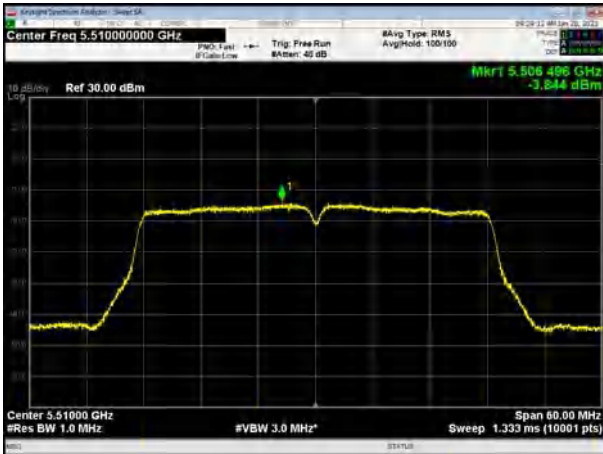

U-NII-2C, 802.11ac VHT80, Channel No.: 106

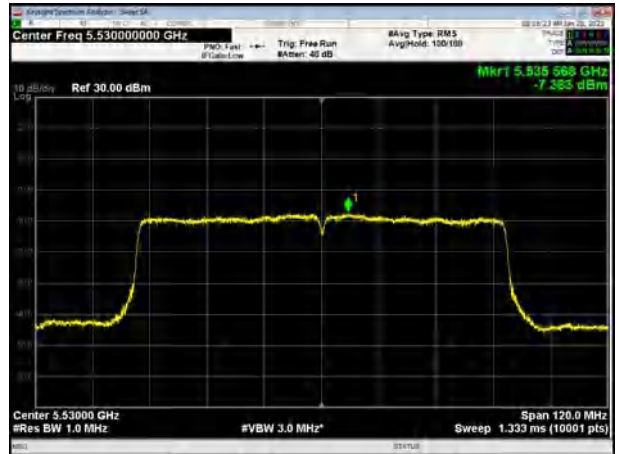

U-NII-2C, 802.11ac VHT40, Channel No.: 110



U-NII-2C, 802.11ac VHT80, Channel No.: 122

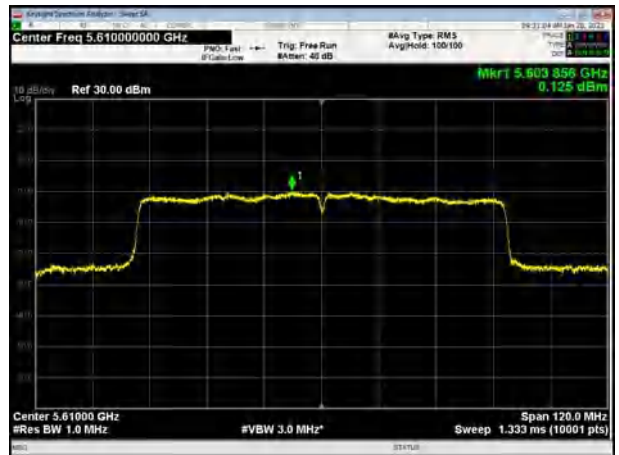

U-NII-2C, 802.11ac VHT40, Channel No.: 118

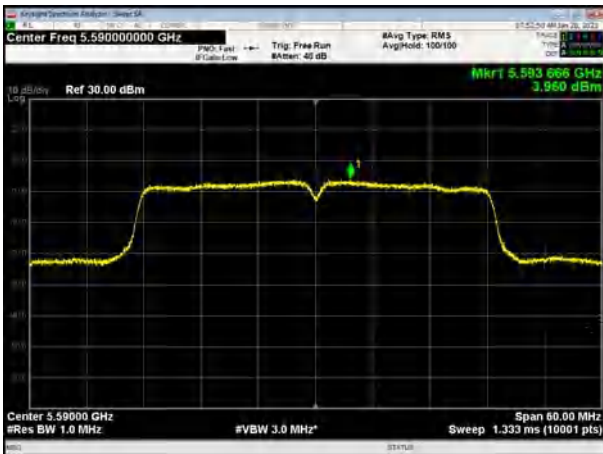

U-NII-2C, 802.11ac VHT80, Channel No.: 138

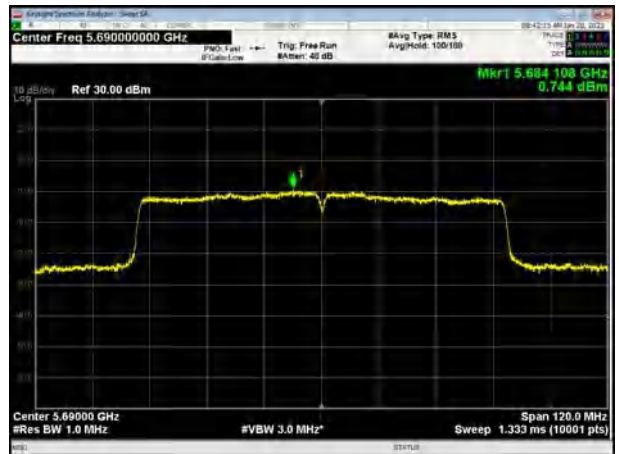

U-NII-2C, 802.11ac VHT40, Channel No.: 126



U-NII-2C, 802.11ac VHT40, Channel No.: 134

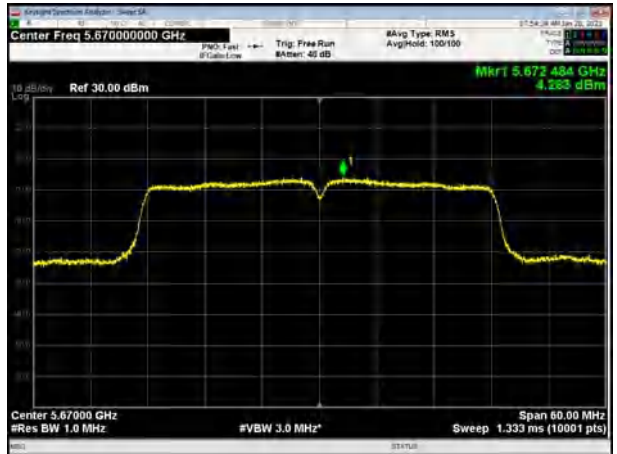

U-NII-2C, 802.11ac VHT40, Channel No.: 142

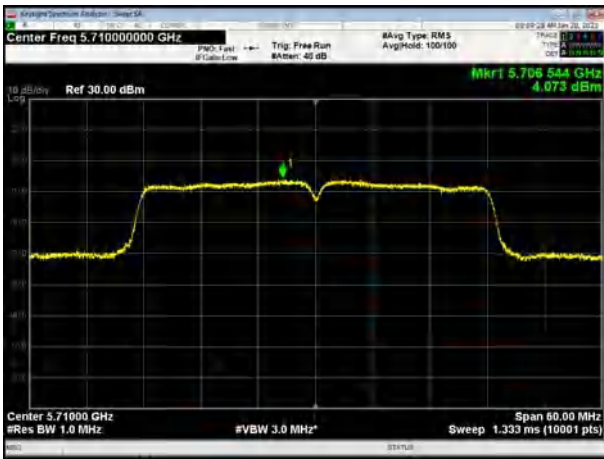



U-NII-3, 802.11a, Channel No.: 149

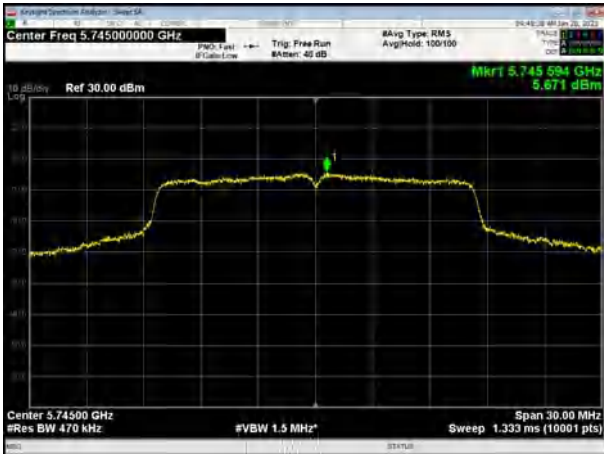

U-NII-3, 802.11n HT20, Channel No.: 149



U-NII-3, 802.11a, Channel No.: 157

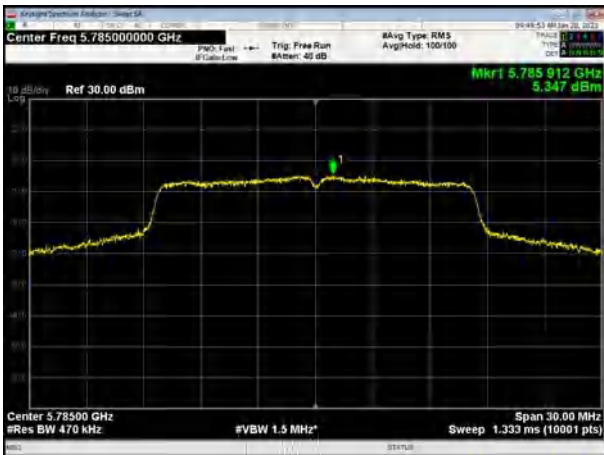

U-NII-3, 802.11n HT20, Channel No.: 157

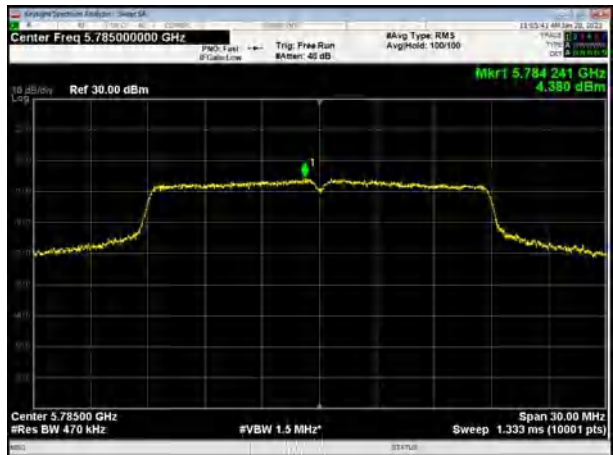

U-NII-3, 802.11a, Channel No.: 165

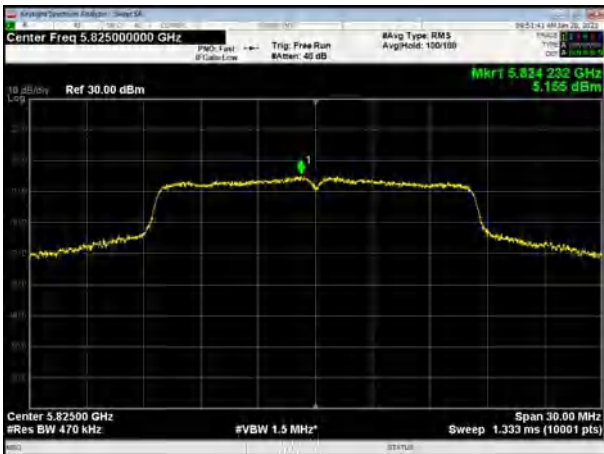

U-NII-3, 802.11n HT20, Channel No.: 165

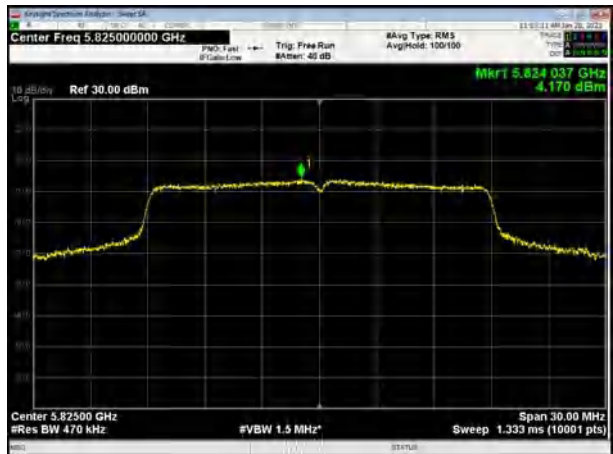

U-NII-3, 802.11n HT40, Channel No.: 151



U-NII-3, 802.11ac VHT20, Channel No.: 149

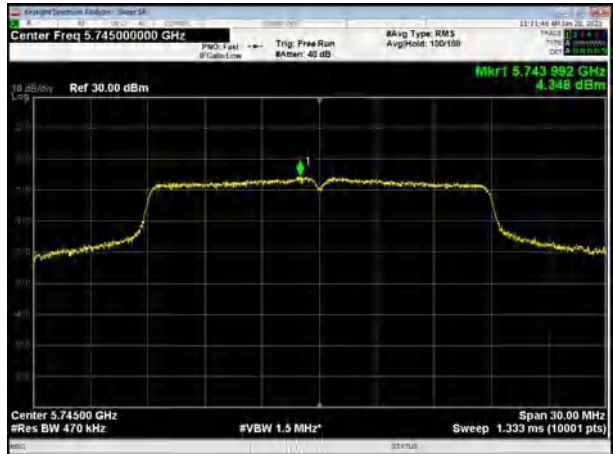

U-NII-3, 802.11n HT40, Channel No.: 159

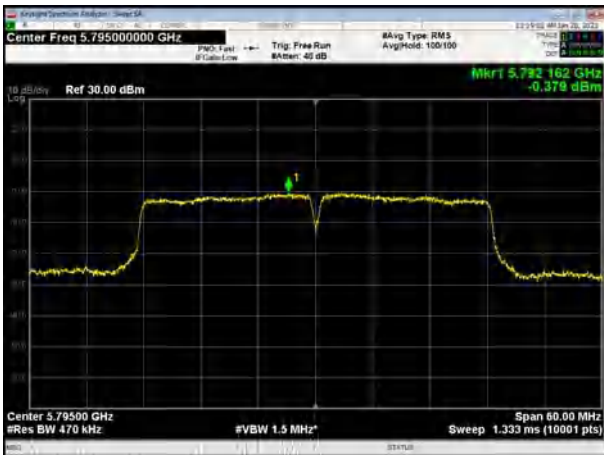

U-NII-3, 802.11ac VHT20, Channel No.: 157



U-NII-3, 802.11ac VHT40, Channel No.: 151



U-NII-3, 802.11ac VHT20, Channel No.: 165



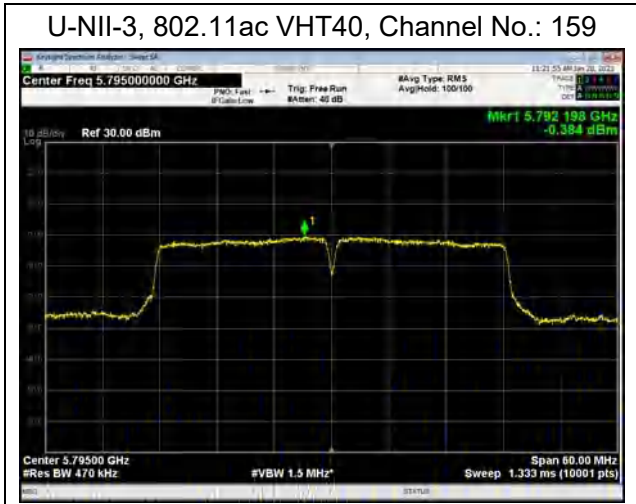

5.5. Unwanted Emission

Ambient condition

Temperature	Relative humidity	Pressure
23°C ~25°C	45%~50%	101.5kPa

Method of Measurement

The test set-up was made in accordance to the general provisions of ANSI C63.10. The Equipment Under Test (EUT) was set up on a non-conductive table in the semi-anechoic chamber. The test was performed at the distance of 3 m between the EUT and the receiving antenna. The radiated emissions measurements were made in a typical installation configuration.

Sweep the whole frequency band range from 9kHz to the 10th harmonic of the carrier, and the emissions less than 20 dB below the permissible value are reported.

During the test, the height of receive antenna shall be moved from 1 to 4 meters, and the antenna shall be performed under horizontal and vertical polarization. The turntable shall be rotated from 0 to 360 degrees for detecting the maximum of radiated spurious signal level. The measurements shall be repeated with orthogonal polarization of the test antenna. The data of cable loss and antenna factor has been calibrated in full testing frequency range before the testing.

Set the spectrum analyzer in the following:

9kHz~150 kHz

RBW=200Hz, VBW=1kHz/ Sweep=AUTO

150 kHz~30MHz

RBW=9KHz, VBW=30KHz,/ Sweep=AUTO

Below 1GHz

RBW=100kHz / VBW=300kHz / Sweep=AUTO

a) Peak emission levels are measured by setting the instrument as follows:

Above 1GHz

PEAK: RBW=1MHz VBW=3MHz/ Sweep=AUTO

b) Average emission levels are measured by setting the instrument as follows:

Above 1GHz

AVERAGE: RBW=1MHz / VBW=3MHz / Sweep=AUTO

c) Detector: The measurements employing a CISPR quasi-peak detector except for the frequency bands 9-90 kHz, 110-490 kHz and above 1000 MHz. Radiated emission limits in these three bands are based on measurements employing an average detector.

d) Averaging type = power (i.e., rms) (As an alternative, the detector and averaging type may be set for linear voltage averaging. Some instruments require linear display mode to use linear voltage averaging. Log or dB averaging shall not be used.)

e) Sweep time = auto.

f) Perform a trace average of at least 100 traces if the transmission is continuous. If the transmission is not continuous, then the number of traces shall be increased by a factor of $1 / D$, where D is the duty cycle. For example, with 50% duty cycle, at least 200 traces shall be averaged. (If a specific



emission is demonstrated to be continuous—i.e., 100% duty cycle—then rather than turning ON and OFF with the transmit cycle, at least 100 traces shall be averaged.)

g) If tests are performed with the EUT transmitting at a duty cycle less than 98%, then a correction factor shall be added to the measurement results prior to comparing with the emission limit, to compute the emission level that would have been measured had the test been performed at 100% duty cycle. The correction factor is computed as follows:

1) If power averaging (rms) mode was used in the preceding step e), then the correction factor is $[10 \log (1 / D)]$, where D is the duty cycle. For example, if the transmit duty cycle was 50%, then 3 dB shall be added to the measured emission levels.

2) If linear voltage averaging mode was used in the preceding step e), then the correction factor is $[20 \log (1 / D)]$, where D is the duty cycle. For example, if the transmit duty cycle was 50%, then 6 dB shall be added to the measured emission levels.

3) If a specific emission is demonstrated to be continuous (100% duty cycle) rather than turning ON and OFF with the transmit cycle, then no duty cycle correction is required for that emission.

Reduce the video bandwidth until no significant variations in the displayed signal are observed in subsequent traces, provided the video bandwidth is no less than 1 Hz. For regulatory requirements that specify averaging only over the transmit duration (e.g., digital transmission system [DTS] and Unlicensed National Information Infrastructure [U-NII]), the video bandwidth shall be greater than $[1 / (\text{minimum transmitter on time})]$ and no less than 1 Hz.

The field strength of spurious emission was measured in the following position: EUT stand-up position (Z axis), lie-down position (X, Y axis). The worst emission was found in stand-up position (Z axis) and the loop antenna is vertical, others antenna are vertical and horizontal.

The test is in transmitting mode.

9KHz~~~30MHz

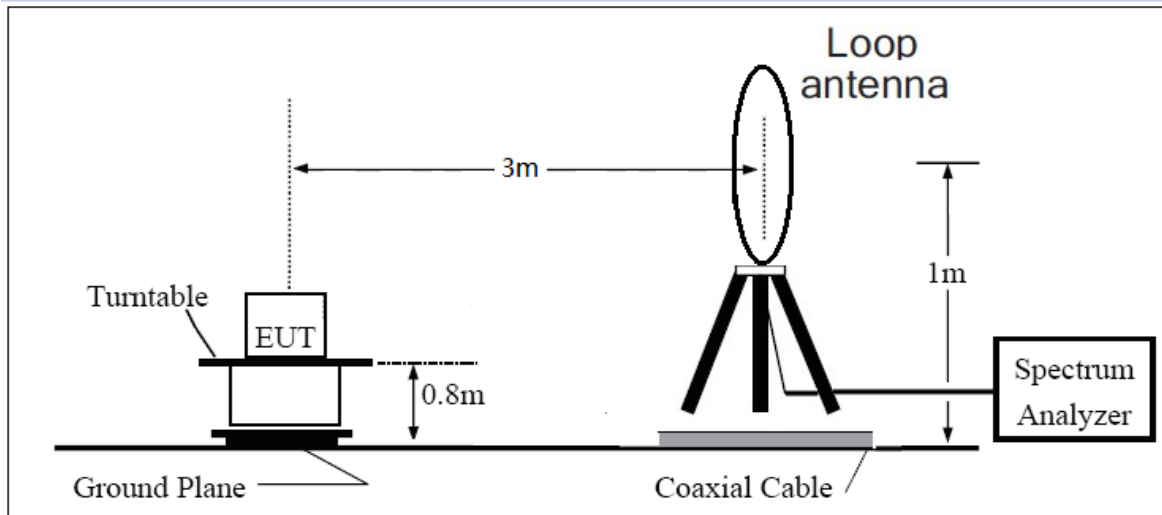

30MHz~~~ 1GHz

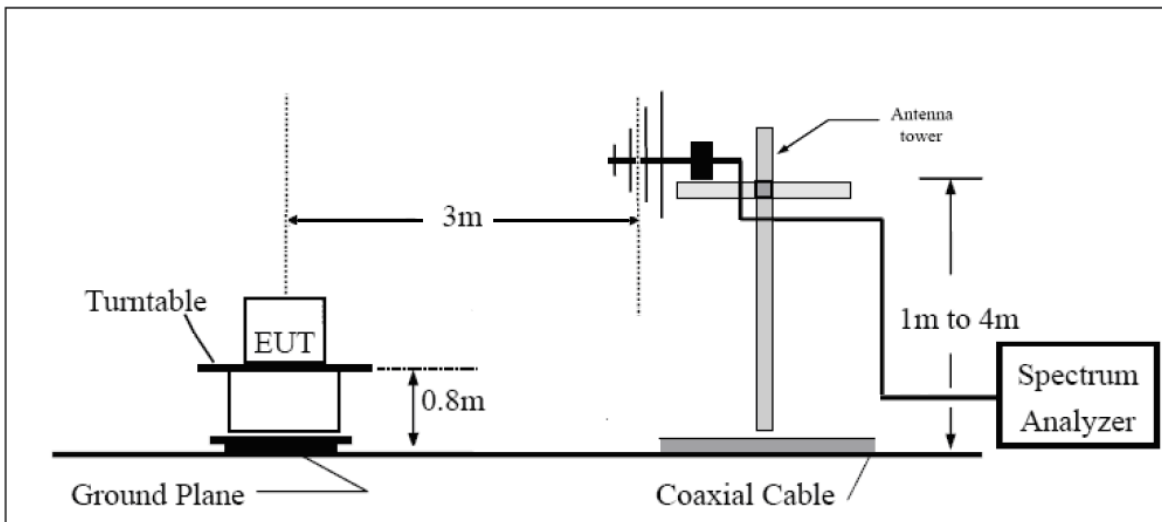

Above 1GHz

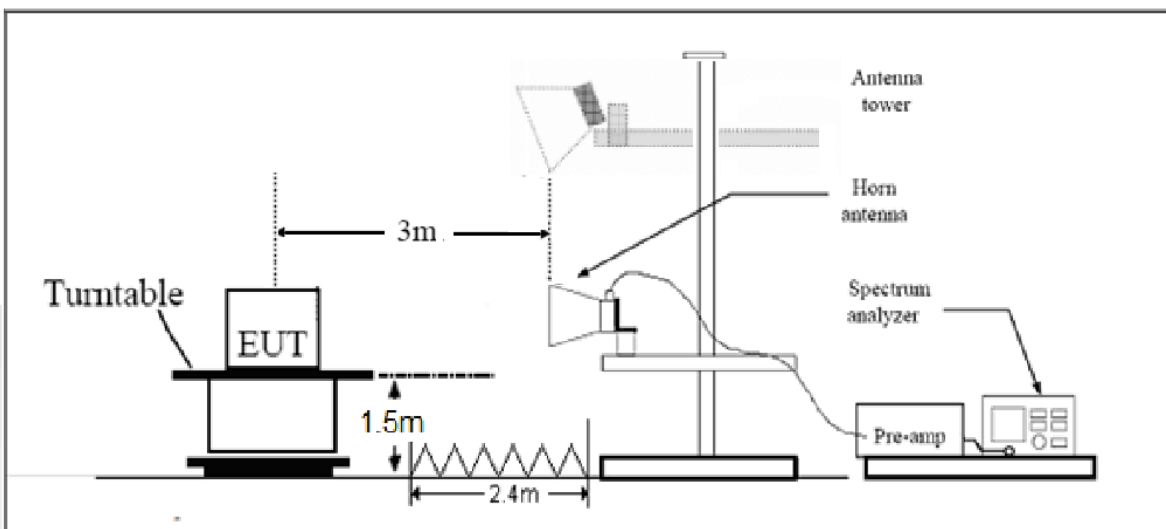

Note: Area side:2.4mX3.6m

Limits

- (1) For transmitters operating in the 5725-5850 MHz band: All emissions shall be limited to a level of -27 dBm/MHz at 75 MHz or more above or below the band edge increasing linearly to 10 dBm/MHz at 25 MHz above or below the band edge, and from 25 MHz above or below the band edge increasing linearly to a level of 15.6 dBm/MHz at 5 MHz above or below the band edge, and from 5 MHz above or below the band edge increasing linearly to a level of 27 dBm/MHz at the band edge.
- (2) For transmitters operating in the 5.15-5.25 GHz band: All emissions outside of the 5.15-5.35 GHz band shall not exceed an e.i.r.p. of -27 dBm/MHz(68.2dBμV/m).
- (3) For transmitters operating in the 5.25-5.35 GHz band: All emissions outside of the 5.15-5.35 GHz band shall not exceed an e.i.r.p. of -27 dBm/MHz(68.2dBμV/m).
- (4) For transmitters operating in the 5.47-5.725 GHz band: All emissions outside of the 5.47-5.725 GHz band shall not exceed an e.i.r.p. of -27 dBm/MHz(68.2dBμV/m).

Note: the following formula is used to convert the EIRP to field strength

§1、 $E[\text{dB}\mu\text{V}/\text{m}] = \text{EIRP}[\text{dBm}] - 20 \log(d[\text{meters}]) + 104.77$, where E = field strength and

d = distance at which field strength limit is specified in the rules;

§2、 $E[\text{dB}\mu\text{V}/\text{m}] = \text{EIRP}[\text{dBm}] + 95.2$, for d = 3 meters

- (5) Unwanted spurious emissions fallen in restricted bands per FCC Part15.205 shall comply with the general field strength limits set forth in § 15.209 as below table.

Frequency of emission (MHz)	Field strength(uV/m)	Field strength(dBuV/m)
0.009–0.490	2400/F(kHz)	/
0.490–1.705	24000/F(kHz)	/
1.705–30.0	30	/
30-88	100	40
88-216	150	43.5
216-960	200	46
Above960	500	54

MHz	MHz	MHz	GHz
0.090 - 0.110	16.42 - 16.423	399.9 - 410	4.5 - 5.15
0.495 - 0.505	16.69475 - 16.69525	608 - 614	5.35 - 5.46
2.1735 - 2.1905	16.80425 - 16.80475	960 - 1240	7.25 - 7.75
4.125 - 4.128	25.5 - 25.67	1300 - 1427	8.025 - 8.5
4.17725 - 4.17775	37.5 - 38.25	1435 - 1626.5	9.0 - 9.2
4.20725 - 4.20775	73 - 74.6	1645.5 - 1846.5	9.3 - 9.5
6.215 - 6.218	74.8 - 75.2	1660 - 1710	10.6 - 12.7
6.26775 - 6.26825	108 - 121.94	1718.8 - 1722.2	13.25 - 13.4
6.31175 - 6.31225	123 - 138	2200 - 2300	14.47 - 14.5
8.291 - 8.294	149.9 - 150.05	2310 - 2390	15.35 - 16.2
8.362 - 8.366	156.52475 - 156.52525	2483.5 - 2500	17.7 - 21.4
8.37625 - 8.38675	156.7 - 156.9	2690 - 2900	22.01 - 23.12
8.41425 - 8.41475	162.0125 - 167.17	3260 - 3267	23.6 - 24.0
12.29 - 12.293	167.72 - 173.2	3332 - 3339	31.2 - 31.8
12.51975 - 12.52025	240 - 285	3345.8 - 3358	36.43 - 36.5
12.57675 - 12.57725	322 - 335.4	3600 - 4400	(2)
13.36 - 13.41			

Measurement Uncertainty

The assessed measurement uncertainty to ensure 95% confidence level for the normal distribution is with the coverage factor $k = 1.96$.

Frequency	Uncertainty
9KHz-30MHz	3.55 dB
30MHz-200MHz	4.17 dB
200MHz-1GHz	4.84 dB
1-18GHz	4.35 dB
18-26.5GHz	5.90 dB
26.5GHz~40GHz	5.92 dB



Test Results:

The modulation and bandwidth are similar for 802.11n mode for 20MHz/40MHz and 802.11ac mode for V20MHz/V40MHz, therefore investigated worst case to representative mode in test report.

A font (Level in dB μ V/m) in the test plot =(level in dB μ V/m)

A font (Level in dB μ V) in the test plot =(level in dB μ V/m)

The signal beyond the limit is carrier.

U-NII-1

802.11a-Channel 36: Peak + Average

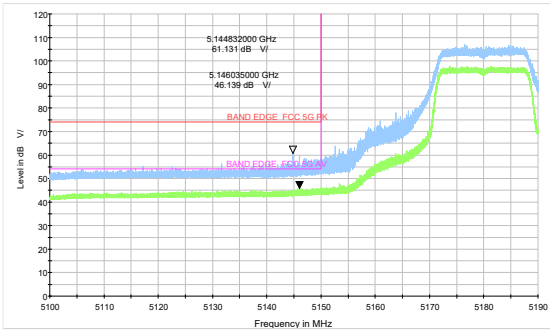

802.11a-Channel 48: Peak + Average

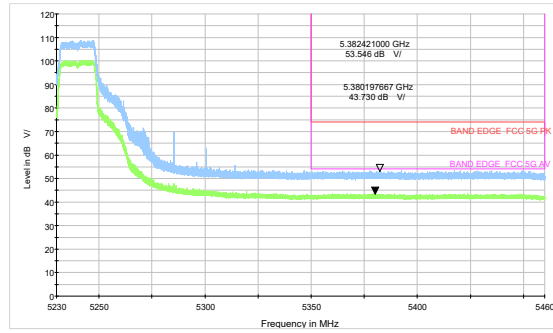

802.11ac VHT20 -Channel 36: Peak + Average

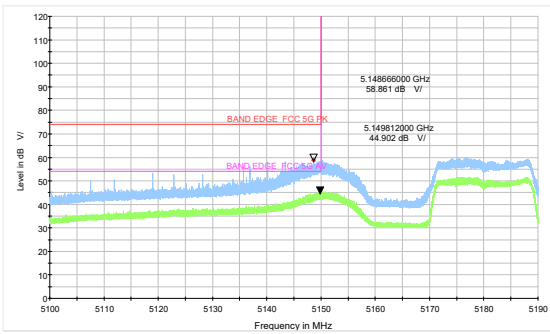

802.11ac VHT20 -Channel 48: Peak + Average

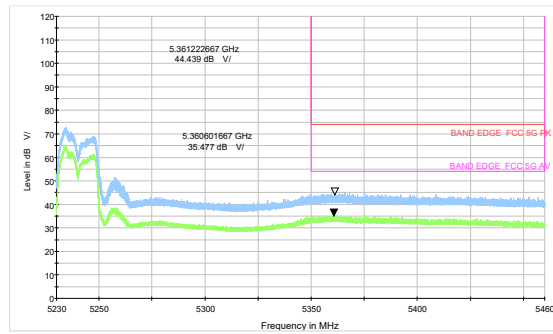

802.11ac VHT40-Channel 38: Peak + Average

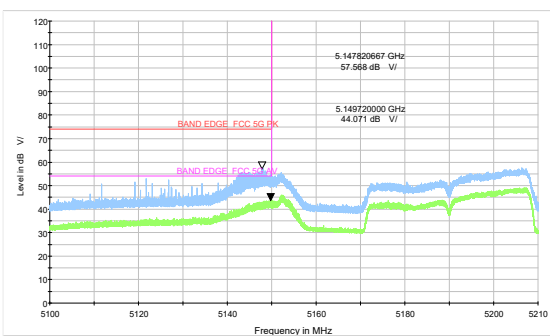

802.11ac VHT40-Channel 46: Peak + Average

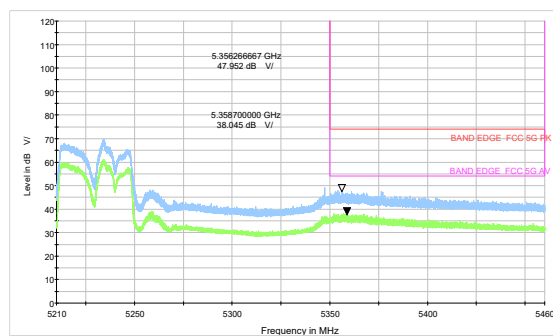

802.11ac VHT80 –Channel 42: Peak + Average

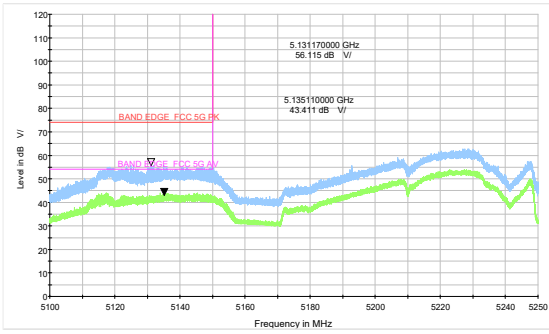

U-NII-2A

802.11a-Channel 52: Peak + Average

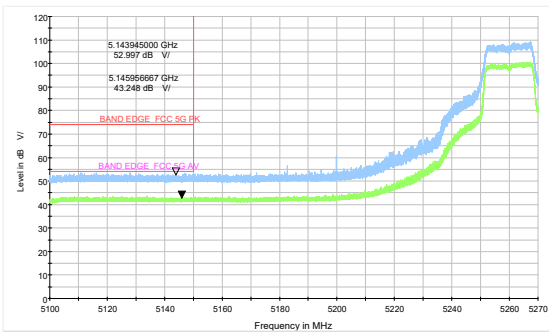

802.11a-Channel 64: Peak + Average

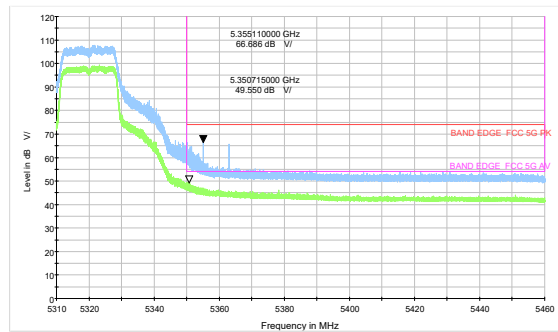

802.11ac VHT20 -Channel 52: Peak + Average

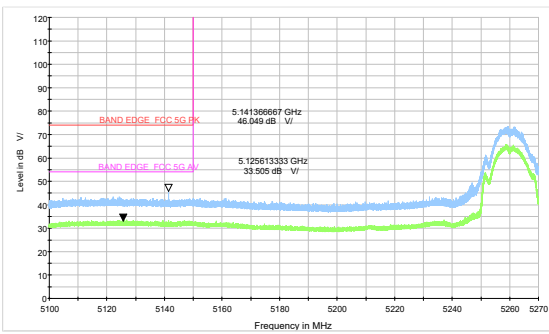

802.11ac VHT20 -Channel 64: Peak + Average

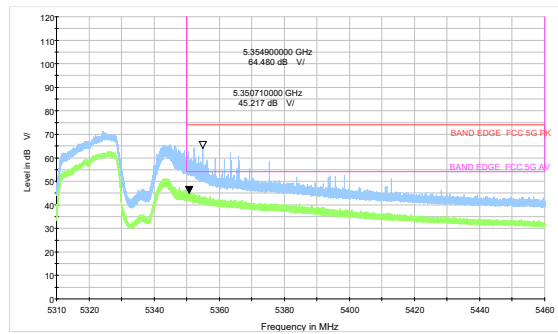

802.11ac VHT40-Channel 54: Peak + Average

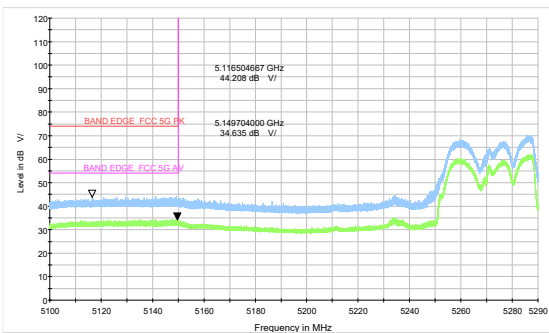

802.11ac VHT40-Channel 62: Peak + Average

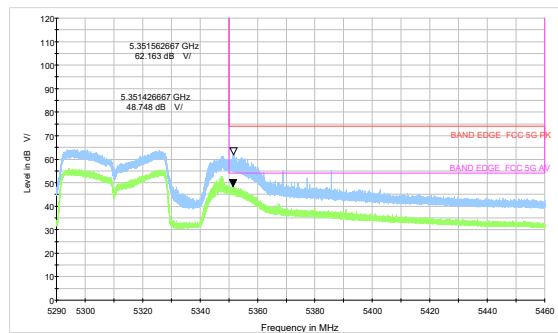



802.11ac VHT80 –Channel 58: Peak + Average

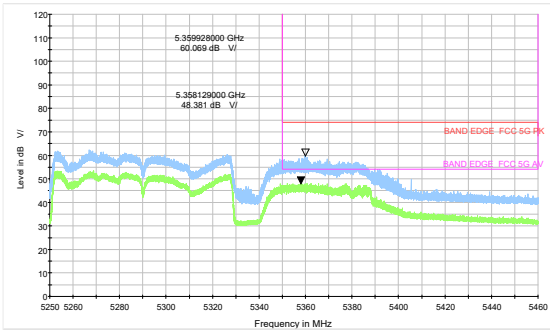

U-NII-2C

802.11a-Channel 100: Peak + Average

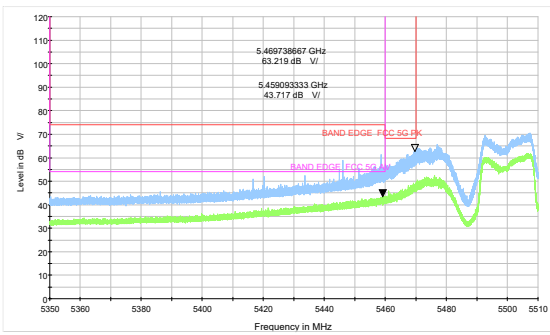

802.11ac VHT20 -Channel 100: Peak + Average

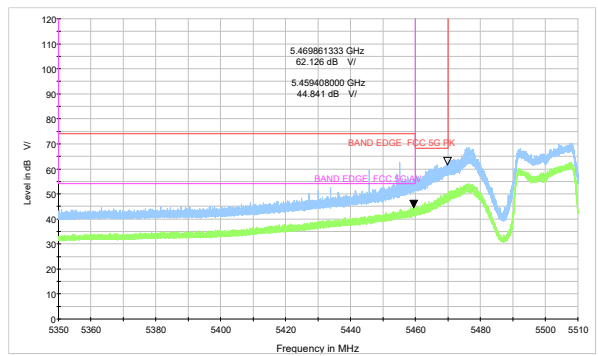

802.11a-Channel 140: Peak

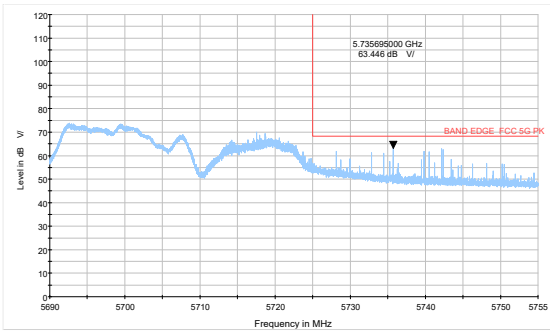

802.11ac VHT20 -Channel 140: Peak

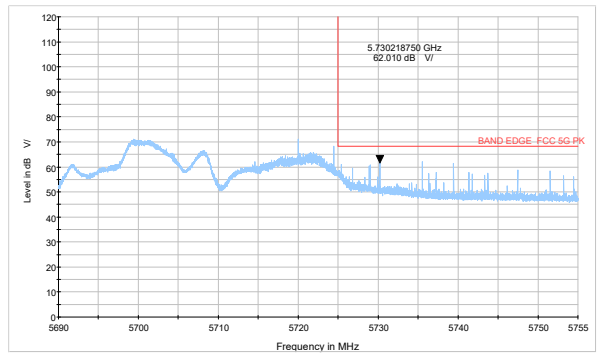

802.11ac VHT40-Channel 102: Peak + Average

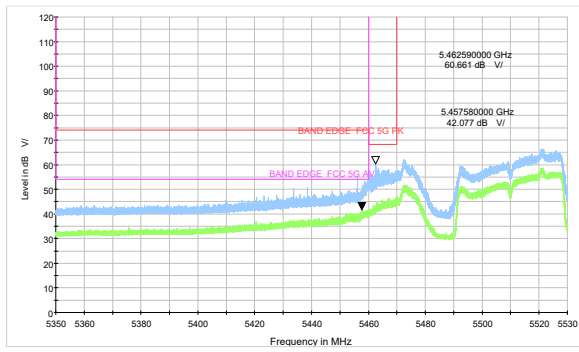

802.11ac VHT40-Channel 134: Peak + Average

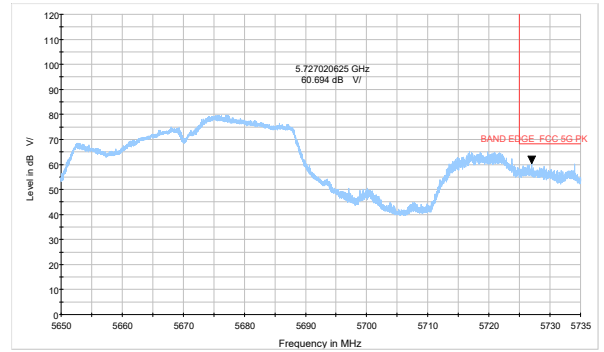

802.11ac VHT40-Channel 142: Peak

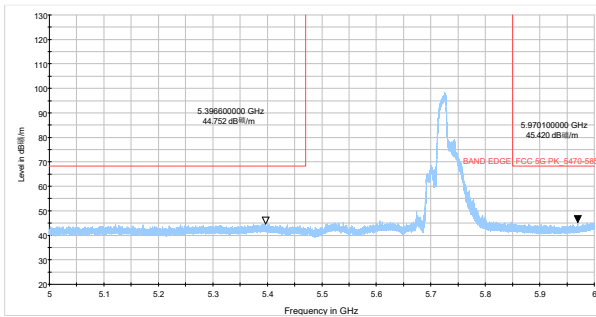

802.11ac VHT80 -Channel 106: Peak + Average

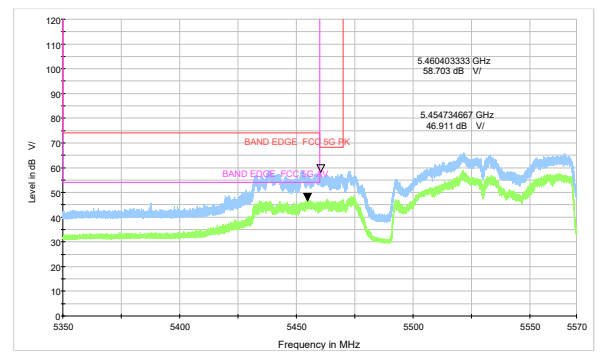

802.11ac VHT80 -Channel 138: Peak

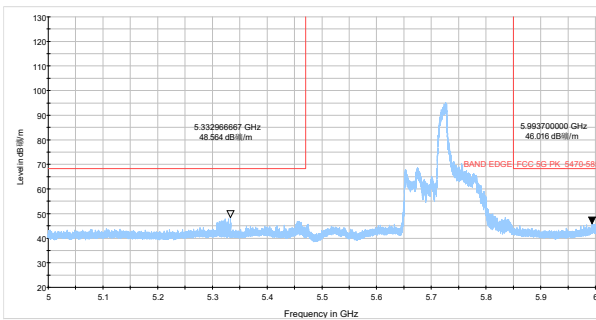



U-NII-3

802.11a-Channel 149: Peak

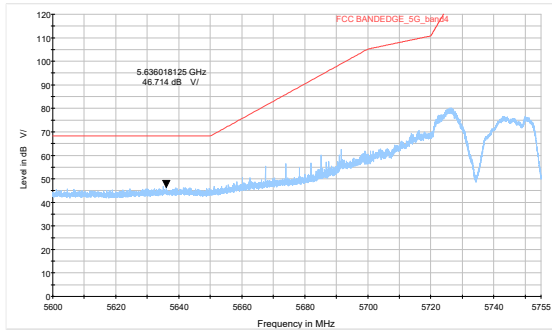

802.11a-Channel 165: Peak

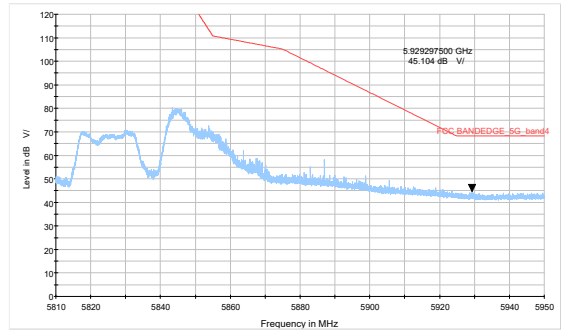

802.11ac VHT20-Channel 149: Peak

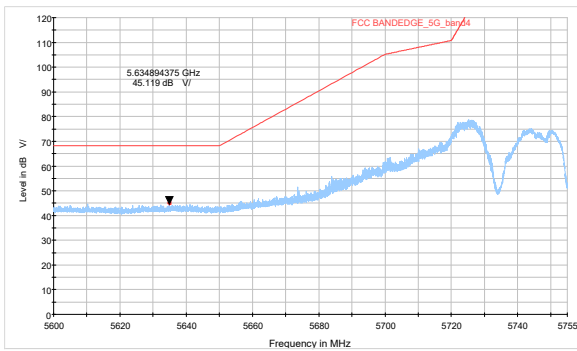

802.11ac VHT20-Channel 165: Peak

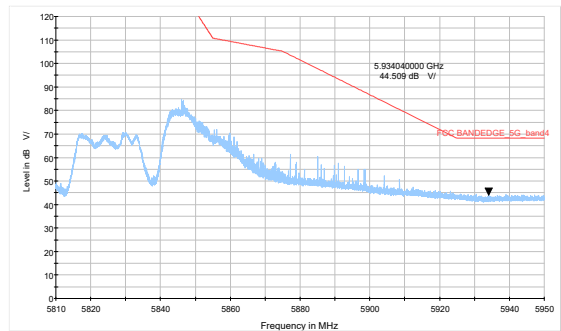

802.11ac VHT40-Channel 151: Peak

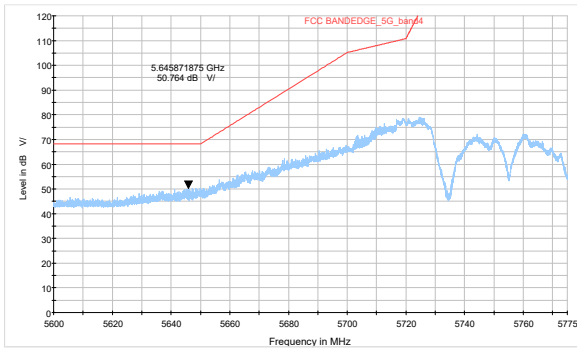

802.11ac VHT40-Channel 159: Peak

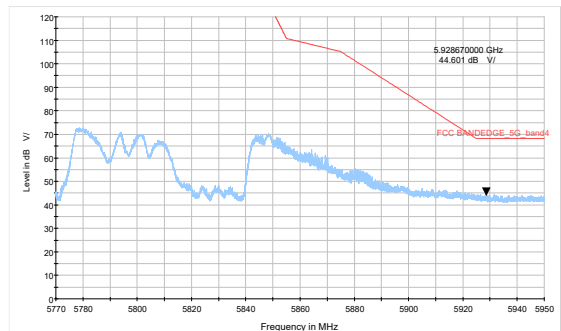

802.11ac VHT80- Channel 122: Peak

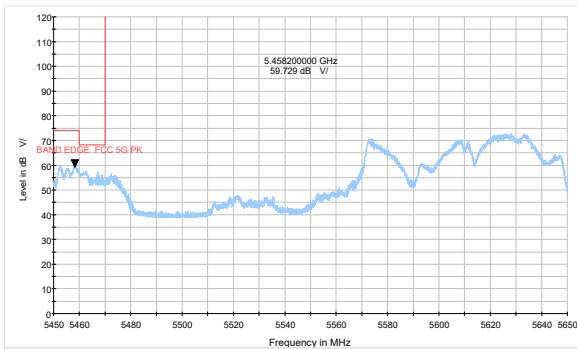

802.11ac VHT80- Channel 155: Peak

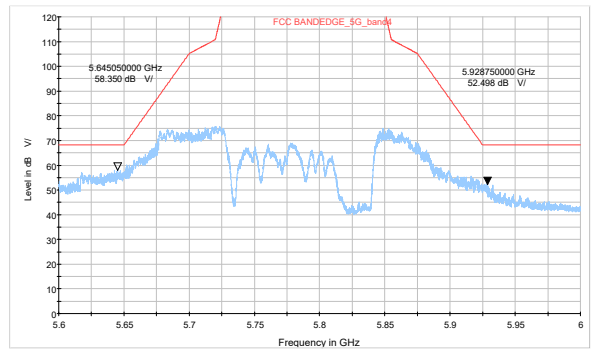



Result of RE

Test result

A font (Level in dB μ V/) in the test plot =(level in dB μ V/m)

During the test, the Radiates Emission from 30MHz to 1GHz was performed in all modes with all channels, 802.11a, Channel 64 are selected as the worst condition. The test data of the worst-case condition was recorded in this report.

Continuous TX mode:

FCC RE 9K-90KHz AV

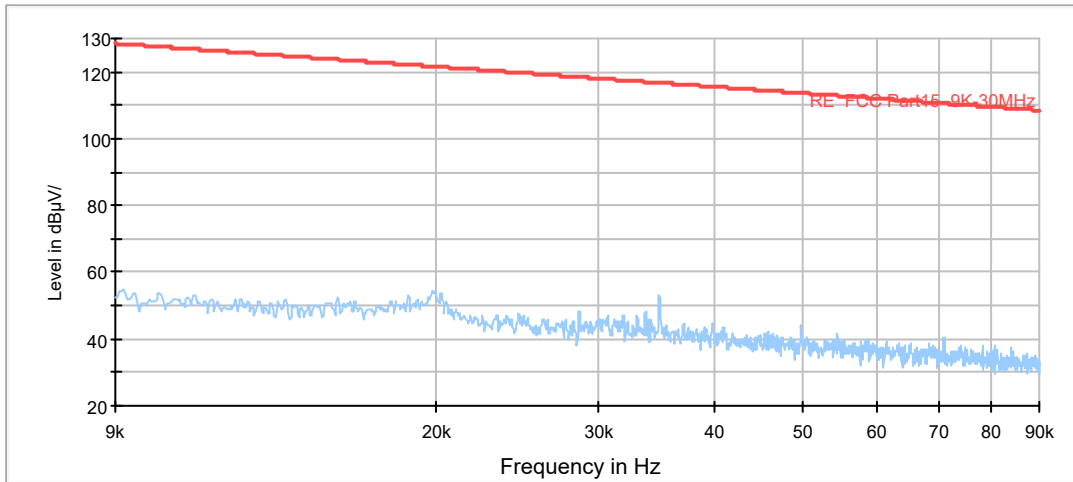

Radiates Emission from 9KHz to 90KHz

FCC RE 90K-110KHz QP

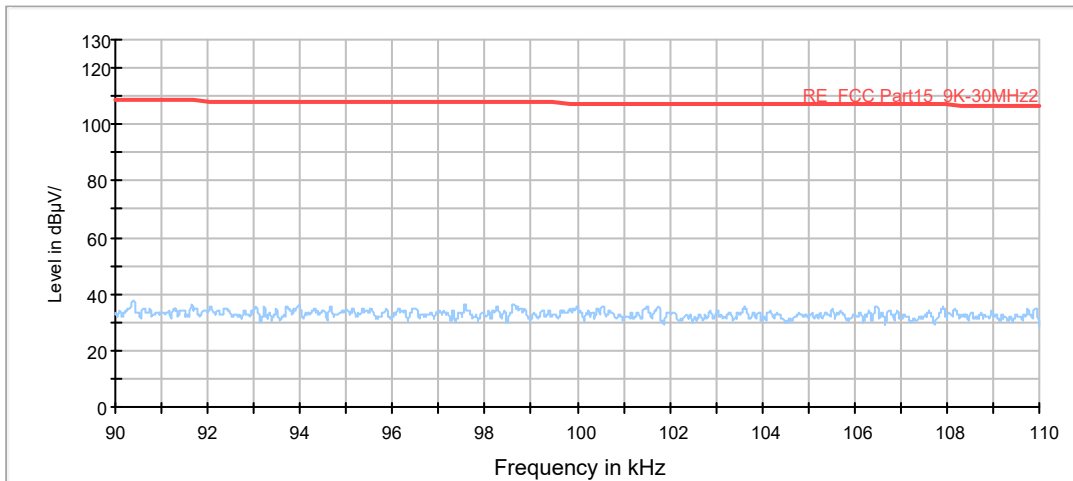

Radiates Emission from 90KHz to 110KHz



FCC RE 110K-490KHz AV

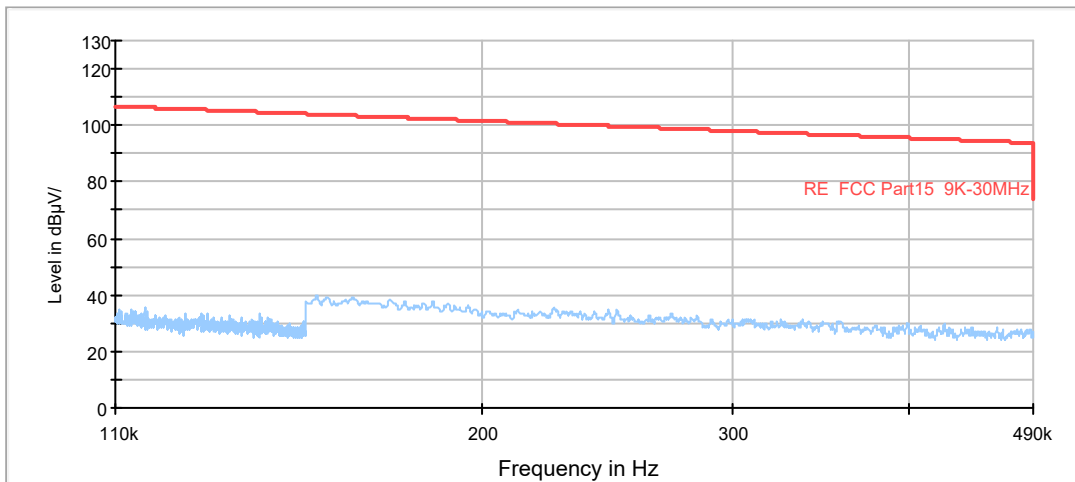

Radiates Emission from 110KHz to 490KHz

FCC RE 490K-30MHz QP

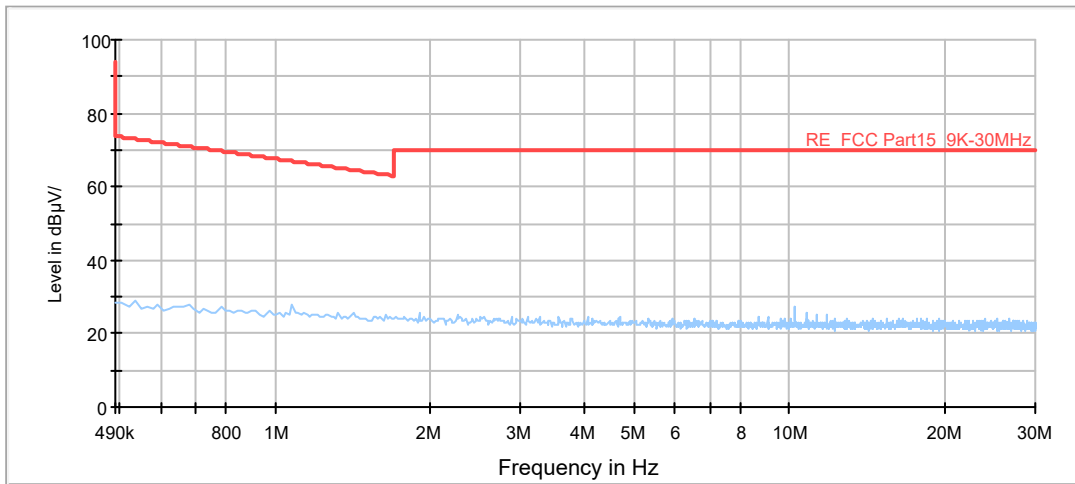

Radiates Emission from 490KHz to 30MHz

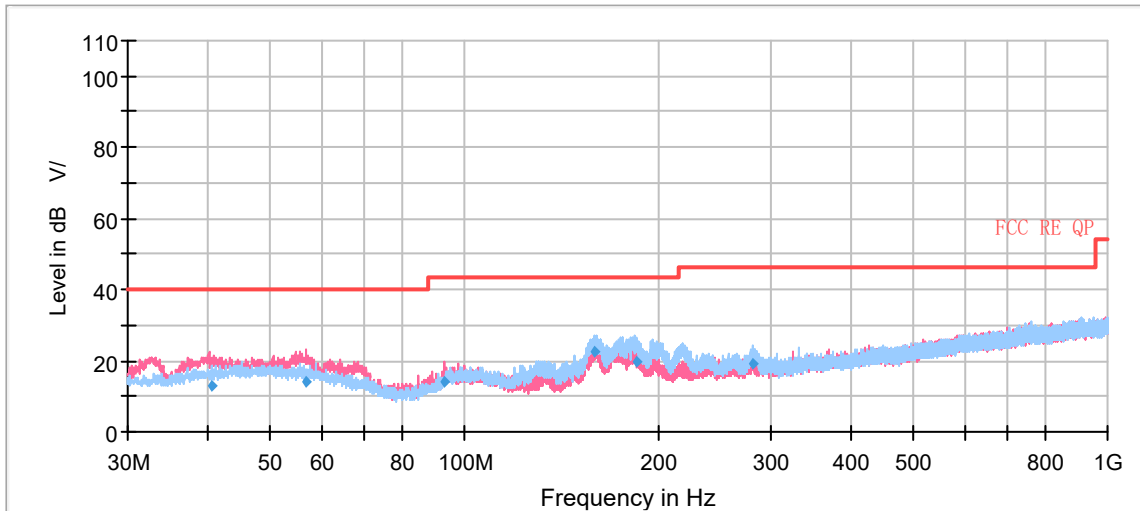

Radiates Emission from 30MHz to 1GHz

Frequency (MHz)	Quasi-Peak (dBuV/m)	Height (cm)	Polarization	Azimuth (deg)	Correct Factor (dB)	Margin (dB)	Limit (dBuV/m)
40.600333	12.86	185.0	V	206.0	20	27.14	40.00
56.819667	14.38	100.0	V	41.0	20	25.62	40.00
93.381000	14.07	100.0	V	161.0	17	29.43	43.50
159.642333	22.77	175.0	H	222.0	15	20.73	43.50
184.759333	19.65	184.0	H	65.0	17	23.85	43.50
281.521000	19.00	109.0	H	68.0	20	27.00	46.00

Remark: 1. Correction Factor = Antenna factor+ Insertion loss(cable loss+amplifier gain)

2. Margin = Limit – Quasi-Peak



802.11a CH36

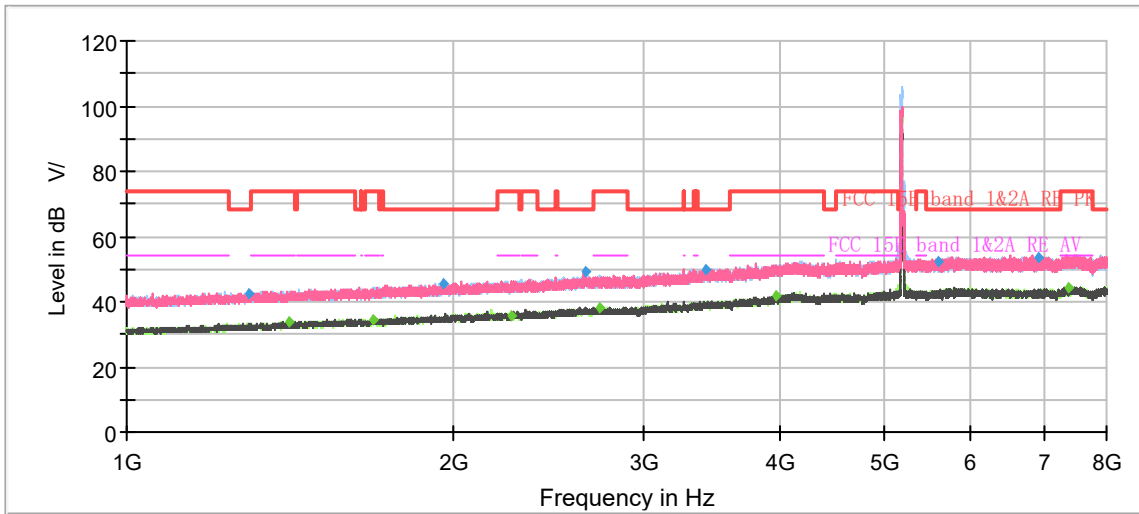

Radiates Emission from 1GHz to 8GHz

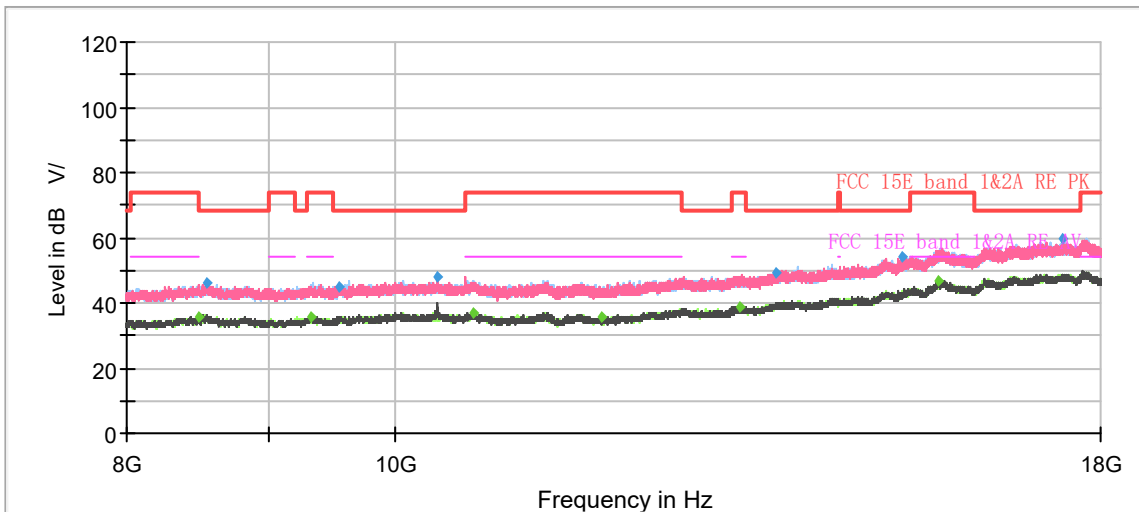

Note: The signal beyond the limit is carrier.
Radiates Emission from 8GHz to 18GHz



Frequency (MHz)	Peak (dBuV/m)	Average (dBuV/m)	Limit (dBuV/m)	Margin (dB)	Height (cm)	Polarization	Azimuth (deg)	Correct Factor (dB)
1294.933333	42.73	---	68.20	25.47	100.0	H	68.0	-7
1414.166667	---	33.78	54.00	20.22	100.0	H	174.0	-6
1686.233333	---	34.67	54.00	19.33	100.0	V	233.0	-5
1958.300000	45.77	---	68.20	22.43	200.0	H	270.0	-3
2258.133333	---	35.45	54.00	18.55	200.0	H	209.0	-2
2652.466667	48.98	---	68.20	19.22	200.0	H	170.0	0
2725.966667	---	38.02	54.00	15.98	200.0	H	255.0	1
3412.200000	50.13	---	68.20	18.07	100.0	V	233.0	4
3962.633333	---	41.85	54.00	12.15	100.0	H	196.0	6
5599.233333	52.54	---	68.20	15.66	200.0	V	21.0	10
6918.033333	53.76	---	68.20	14.44	200.0	H	86.0	11
7371.400000	---	44.37	54.00	9.63	200.0	H	209.0	11

Remark: 1. Correction Factor = Antenna factor+ Insertion loss (cable loss + amplifier gain)

802.11a CH40

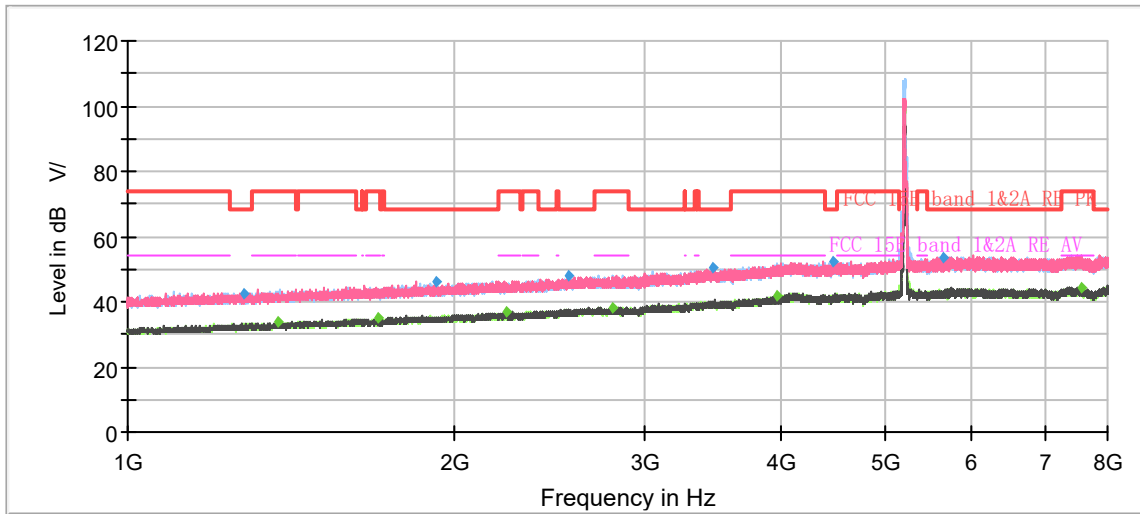

Radiates Emission from 1GHz to 8GHz

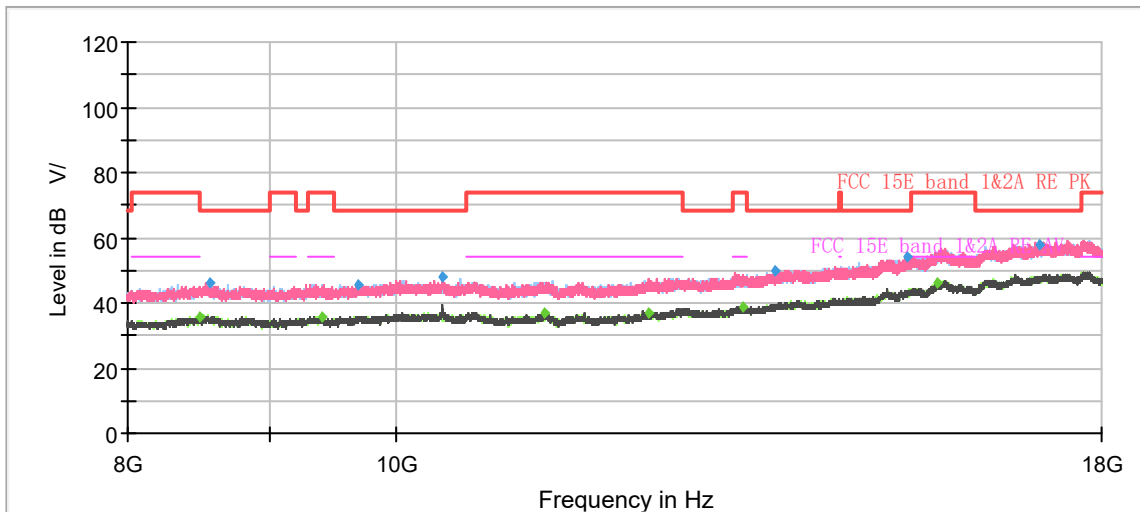

Note: The signal beyond the limit is carrier.
Radiates Emission from 8GHz to 18GHz



Frequency (MHz)	Peak (dBuV/m)	Average (dBuV/m)	Limit (dBuV/m)	Margin (dB)	Height (cm)	Polarization	Azimuth (deg)	Correct Factor (dB)
1281.866667	42.44	---	68.20	25.76	100.0	V	261.0	-7
1377.533333	---	33.74	54.00	20.26	100.0	H	173.0	-6
1700.233333	---	34.78	54.00	19.22	200.0	H	263.0	-5
1921.900000	46.14	---	68.20	22.06	100.0	V	145.0	-3
2238.066667	---	36.88	54.00	17.12	200.0	V	85.0	-2
2550.500000	48.21	---	68.20	19.99	200.0	V	77.0	0
2796.200000	---	38.05	54.00	15.95	200.0	H	330.0	1
3458.866667	50.16	---	68.20	18.04	200.0	H	164.0	4
3957.733333	---	41.69	54.00	12.31	100.0	V	224.0	6
4469.433333	52.21	---	68.20	15.99	200.0	V	145.0	7
5654.533333	53.60	---	68.20	14.60	200.0	H	263.0	10
7566.000000	---	44.39	54.00	9.61	200.0	H	308.0	11

Remark: 1. Correction Factor = Antenna factor+ Insertion loss (cable loss + amplifier gain)

802.11a CH48

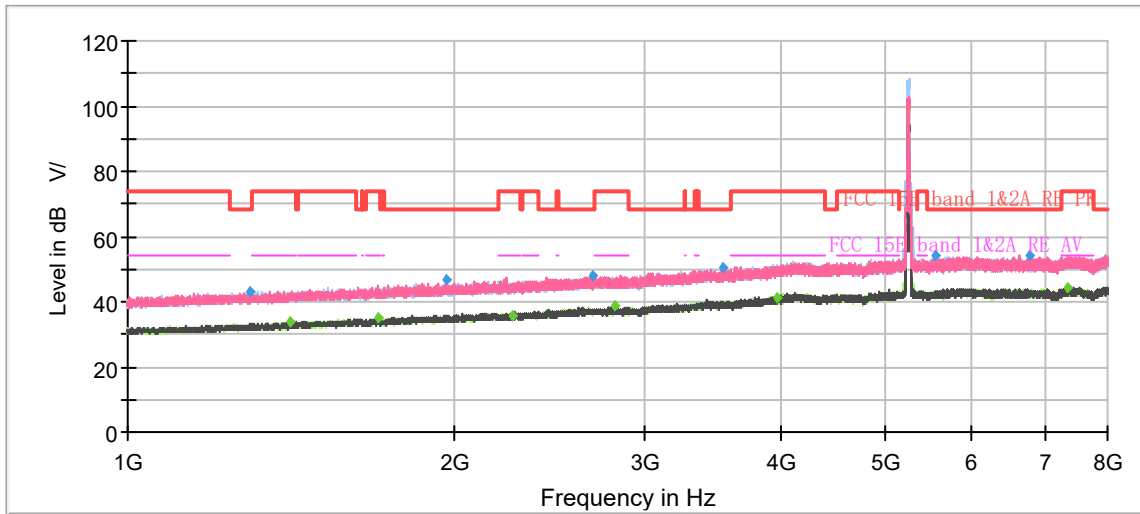

Radiates Emission from 1GHz to 8GHz

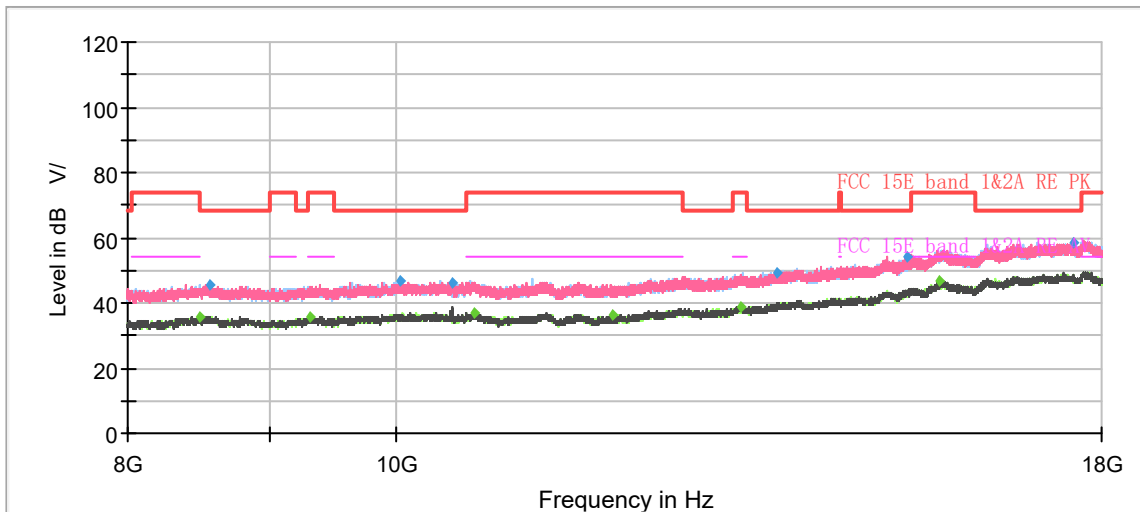

Note: The signal beyond the limit is carrier.
Radiates Emission from 8GHz to 18GHz



Frequency (MHz)	Peak (dBuV/m)	Average (dBuV/m)	Limit (dBuV/m)	Margin (dB)	Height (cm)	Polarization	Azimuth (deg)	Correct Factor (dB)
1297.500000	43.12	---	68.20	25.08	200.0	V	30.0	-7
1410.200000	---	33.69	54.00	20.31	200.0	V	53.0	-6
1701.866667	---	34.79	54.00	19.21	100.0	V	102.0	-5
1964.133333	46.48	---	68.20	21.72	200.0	V	173.0	-3
2262.333333	---	35.84	54.00	18.16	200.0	V	128.0	-2
2680.000000	48.23	---	68.20	19.97	200.0	H	255.0	0
2812.300000	---	38.61	54.00	15.39	100.0	V	335.0	1
3536.566667	50.44	---	68.20	17.76	100.0	V	276.0	4
3970.333333	---	41.43	54.00	12.57	200.0	H	232.0	6
5554.900000	54.01	---	68.20	14.19	100.0	H	248.0	10
6786.200000	53.88	---	68.20	14.32	200.0	V	120.0	10
7354.133333	---	44.37	54.00	9.63	100.0	H	248.0	11

Remark: 1. Correction Factor = Antenna factor+ Insertion loss (cable loss + amplifier gain)