



RF TEST REPORT

Applicant Honor Device Co., Ltd.
FCC ID 2AYGCTFY-LX2
Product Smart Phone
Model TFY-LX2
Report No. R2201A0038-R6
Issue Date February 14, 2022

TA Technology (Shanghai) Co., Ltd. tested the above equipment in accordance with the requirements in **FCC CFR47 Part 15C (2020)**. The test results show that the equipment tested is capable of demonstrating compliance with the requirements as documented in this report.

Prepared by: Peng Tao

Approved by: Kai Xu

TA Technology (Shanghai) Co., Ltd.

No.145, Jintang Rd, Tangzhen Industry Park, Pudong Shanghai, China

TEL: +86-021-50791141/2/3

FAX: +86-021-50791141/2/3-8000



TABLE OF CONTENT

| | |
|---|-----|
| 1. Test Laboratory | 4 |
| 1.1. Notes of the test report..... | 4 |
| 1.2. Test facility | 4 |
| 1.3. Testing Location..... | 4 |
| 2. General Description of Equipment under Test..... | 5 |
| 2.1. Applicant and Manufacturer Information..... | 5 |
| 2.2. General information..... | 5 |
| 3. Applied Standards | 7 |
| 4. Test Configuration | 8 |
| 5. Test Case Results | 9 |
| 5.1. Maximum output power | 9 |
| 5.2. 99% Bandwidth and 6dB Bandwidth | 12 |
| 5.3. Band Edge | 26 |
| 5.4. Power Spectral Density | 41 |
| 5.5. Spurious RF Conducted Emissions..... | 50 |
| 5.6. Unwanted Emission | 68 |
| 5.7. Conducted Emission | 111 |
| 6. Main Test Instruments..... | 116 |
| ANNEX A: The EUT Appearance | 117 |
| ANNEX B: Test Setup Photos | 118 |
| ANNEX C: Product Change Description..... | 119 |

Summary of measurement results

| Number | Test Case | Clause in FCC rules | Verdict |
|--------|---------------------------------|-------------------------|---------|
| 1 | Maximum output power | 15.247(b)(3) | PASS |
| 2 | 6 dB bandwidth | 15.247(a)(2) | PASS |
| 3 | Power spectral density | 15.247(e) | PASS |
| 4 | Band Edge | 15.247(d) | PASS |
| 5 | Spurious RF Conducted Emissions | 15.247(d) | PASS |
| 6 | Unwanted Emissions | 15.247(d),15.205,15.209 | PASS |
| 7 | Conducted Emissions | 15.207 | PASS |

Date of Testing: January 11, 2022 and January 24, 2022

Date of Sample Received: January 10, 2022

Note: All indications of Pass/Fail in this report are opinions expressed by TA Technology (Shanghai) Co., Ltd. based on interpretations and/or observations of test results. Measurement Uncertainties were not taken into account and are published for informational purposes only.

TFY-LX2 (Report No.: R2201A0038-R6) is a variant model of TFY-LX3 (Report No.: R2201A0036-R6V1). Test values partial duplicated from Original for variant.

There is only tested Unwanted Emissions, and did not worsen, so they were not recorded in the report.

The difference between model TFY-LX3 and model TFY-LX2 is show in the below table:

| | Model | TFY-LX3 | TFY-LX2 |
|--------------------|------------|--|--|
| Licensed Frequency | LTE BAND | B2/B4/B5/B7/B13/B26/B38/B66 | B5/B7/B38/B41 |
| | UMTS BAND | B2/B4/B5 | B2/B5 |
| | Antenna | The antenna matching and routing are the same. The frequency is different. | The antenna matching and routing are the same. The frequency is different. |
| RF | RF circuit | The RF circuit of the same frequency is the same. | The RF circuit of the same frequency is the same. the different frequency changed by hardware and some RF parameters. Changes are followed: delete B4/B13/B66 SAWS、Diplexer、 switch and RF matching components. |
| Others | | the same | the same |

The detailed product change description please refers to the Difference Declaration Letter.



1. Test Laboratory

1.1. Notes of the test report

This report shall not be reproduced in full or partial, without the written approval of **TA technology (shanghai) co., Ltd.** The results documented in this report apply only to the tested sample, under the conditions and modes of operation as described herein .Measurement Uncertainties were not taken into account and are published for informational purposes only. This report is written to support regulatory compliance of the applicable standards stated above.

1.2. Test facility

FCC (Designation number: CN1179, Test Firm Registration Number: 446626)

TA Technology (Shanghai) Co., Ltd. has been listed on the US Federal Communications Commission list of test facilities recognized to perform measurements.

A2LA (Certificate Number: 3857.01)

TA Technology (Shanghai) Co., Ltd. has been listed by American Association for Laboratory Accreditation to perform measurement.

1.3. Testing Location

Company: TA Technology (Shanghai) Co., Ltd.
Address: No.145, Jintang Rd, Tangzhen Industry Park, Pudong
City: Shanghai
Post code: 201201
Country: P. R. China
Contact: Xu Kai
Telephone: +86-021-50791141/2/3
Fax: +86-021-50791141/2/3-8000
Website: <http://www.ta-shanghai.com>
E-mail: xukai@ta-shanghai.com

2. General Description of Equipment under Test

2.1. Applicant and Manufacturer Information

| | |
|----------------------|--|
| Applicant | Honor Device Co., Ltd. |
| Applicant address | Shum Yip Sky Park, No. 8089, Hongli West Road, Shenzhen, China |
| Manufacturer | Honor Device Co., Ltd. |
| Manufacturer address | Shum Yip Sky Park, No. 8089, Hongli West Road, Shenzhen, China |

2.2. General information

| EUT Description | | | |
|------------------------------|---|--|-----|
| Model | TFY-LX2 | | |
| SN | A7NX011C30000083 | | |
| Hardware Version | HL6TFYM | | |
| Software Version | 4.2.0.35(C900E14R1P1) | | |
| Power Supply | Battery / AC adapter | | |
| Antenna Type | Internal Antenna | | |
| Antenna Connector | A permanently attached antenna (meet with the standard FCC Part 15.203 requirement) | | |
| Antenna Gain | -1.8dBi | | |
| additional beamforming gain | NA | | |
| Operating Frequency Range(s) | 802.11b/g/n(HT20): 2412 ~ 2462 MHz 802.11n(HT40): 2422 ~ 2452 MHz Bluetooth LE V5.0: 2402 ~2480 MHz | | |
| Modulation Type | 802.11b: DSSS 802.11g/n(HT20/HT40): OFDM Bluetooth LE: GFSK | | |
| Max. Conducted Power | Wi-Fi 2.4G: 19.02dBm Bluetooth LE: 6.95dBm | | |
| EUT Accessory | | | |
| Accessory | Model | Manufacture | No. |
| Adapter | HW-100225E00 | Honor Device Co., Ltd. (Manufacturer:Huntkey) | 1 |
| | HW-100225U00 | Honor Device Co., Ltd. (Manufacturer:Huntkey) | 2 |
| | HW-100225B00 | Honor Device Co., Ltd. (Manufacturer:Huntkey) | 3 |
| | HN-100225E00 | Honor Device Co., Ltd. (Manufacturer: Salcomp) | 4 |
| | HN-100225U00 | Honor Device Co., Ltd. (Manufacturer: Salcomp) | 5 |
| Battery | HB416492EFW | Honor Device Co., Ltd. (Manufacturer: Sunwoda Electronic Co.,LTD) | 1 |



| | | | |
|--|---------------------|---|---|
| | HB416492EFW | Honor Device Co., Ltd. (Manufacturer:NVT) | 2 |
| Earphone | MEND1532B528A11 | Jiangxi Lianchuang Hongsheng Electronic Co., LTD. | 1 |
| | 1293-3283-3.5mm-339 | BOLUO COUNTY QUANCHENG ELECTRONIC CO.,LTD. | 2 |
| | EPAB542-2WH05-DH | FOXCONN INTERCONNECT TECHNOLOGY LIMITED | 3 |
| USB Cable | RY0002 | NingBo Broad Telecommunication Co., Ltd. | 1 |
| | AU2-CRO013HF | Freeport Resources Enterprises Corp. | 2 |
| | 2120-00001-0 | MING JI ELECTRONICS CO., LTD. | 3 |
| | L125UC007-CS-H | LUXSHARE PRECISION INDUSTRY CO., LTD. | 4 |
| | CUDU01B-HC451-EH | FOXCONN INTERCONNECT TECHNOLOGY LIMITED | 5 |
| <p>Note: 1. The EUT is sent from the applicant to TA and the information of the EUT is declared by the applicant.</p> <p>2. There are more than one Adapter, Battery, Earphone and USB Cable, each one should be applied throughout the compliance test respectively, however, only the worst case (Adapter 1, Battery 2, Earphone 1 and USB Cable 3) will be recorded in this report.</p> | | | |

3. Applied Standards

According to the specifications of the manufacturer, it must comply with the requirements of the following standards:

Test standards:

FCC CFR47 Part 15C (2020) Radio Frequency Devices

ANSI C63.10 (2013)

Reference standard:

KDB 558074 D01 15.247 Meas Guidance v05r02

4. Test Configuration

Test Mode

The EUT has been associated with peripherals and configuration operated in a manner tended to maximize its emission characteristics in a typical application.

The radiated emission was measured in the following position: EUT stand-up position (Z axis), lie-down position (X, Y axis). The worst emission was found in lie-down position (X axis) and the loop antenna is vertical, the others are vertical and horizontal. and the worst case was recorded.

In order to find the worst case condition, Pre-tests are needed at the presence of different data rate. Preliminary tests have been done on all the configuration for confirming worst case. Data rate below means worst-case rate of each test item.

Worst-case data rates are shown as following table.

| Test Mode | Data Rate |
|-----------------------|-----------|
| Bluetooth(Low Energy) | 1Mbps |
| 802.11b | 1 Mbps |
| 802.11g | 6 Mbps |
| 802.11n HT20 | MCS0 |
| 802.11n HT40 | MCS0 |

5. Test Case Results

5.1. Maximum output power

Ambient condition

| Temperature | Relative humidity | Pressure |
|-------------|-------------------|----------|
| 23°C ~25°C | 45%~50% | 101.5kPa |

Methods of Measurement

During the process of the testing, The EUT was connected to Power meter with a known loss. The EUT is max power transmission with proper modulation.

Test Setup

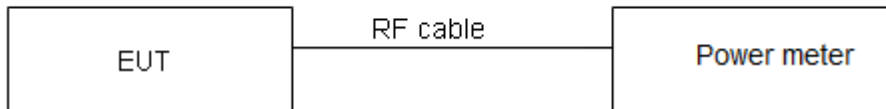

Limits

Rule Part 15.247 (b) (3) specifies that " For systems using digital modulation in the 902–928 MHz, 2400–2483.5 MHz: 1 Watt."

| | |
|----------------------|-------------------|
| Average Output Power | $\leq 1W$ (30dBm) |
|----------------------|-------------------|

Measurement Uncertainty

The assessed measurement uncertainty to ensure 95% confidence level for the normal distribution is with the coverage factor $k = 2$, $U = 0.44$ dB.

**Test Results**

| Test Mode | T _{on} (ms) | T _(on+off) (ms) | Duty cycle | Duty cycle correction Factor(dB) |
|--------------|----------------------|----------------------------|------------|----------------------------------|
| 802.11b | 12.44 | 12.60 | 0.99 | 0.00 |
| 802.11g | 2.06 | 2.10 | 0.98 | 0.00 |
| 802.11n HT20 | 1.92 | 1.96 | 0.98 | 0.00 |
| 802.11n HT40 | 0.95 | 1.00 | 0.95 | 0.24 |
| Bluetooth LE | 2.14 | 2.50 | 0.86 | 0.66 |

Note: when Duty cycle ≥ 0.98 , Duty cycle correction Factor not required.



| Test Mode | Carrier frequency (MHz) / Channel | Average Power Measured (dBm) | Average Power with duty factor (dBm) | Limit (dBm) | Conclusion |
|------------------------|-----------------------------------|------------------------------|--------------------------------------|-------------|------------|
| 802.11b | 2412/CH 1 | 18.75 | 18.75 | 30 | PASS |
| | 2437/CH 6 | 18.46 | 18.46 | 30 | PASS |
| | 2462/CH11 | 18.60 | 18.60 | 30 | PASS |
| 802.11g | 2412/CH 1 | 14.67 | 14.67 | 30 | PASS |
| | 2417/CH 2 | 16.37 | 16.37 | 30 | PASS |
| | 2422/CH 3 | 18.80 | 18.80 | 30 | PASS |
| | 2427/CH 4 | 18.80 | 18.80 | 30 | PASS |
| | 2437/CH 6 | 19.02 | 19.02 | 30 | PASS |
| | 2447/CH 8 | 18.84 | 18.84 | 30 | PASS |
| | 2452/CH 9 | 18.51 | 18.51 | 30 | PASS |
| | 2457/CH 10 | 16.32 | 16.32 | 30 | PASS |
| | 2462/CH 11 | 14.34 | 14.34 | 30 | PASS |
| 802.11n HT20 | 2412/CH 1 | 14.47 | 14.47 | 30 | PASS |
| | 2417/CH 2 | 16.21 | 16.21 | 30 | PASS |
| | 2422/CH 3 | 18.72 | 18.72 | 30 | PASS |
| | 2427/CH 4 | 18.73 | 18.73 | 30 | PASS |
| | 2437/CH 6 | 18.87 | 18.87 | 30 | PASS |
| | 2447/CH 8 | 18.68 | 18.68 | 30 | PASS |
| | 2452/CH 9 | 18.30 | 18.30 | 30 | PASS |
| | 2457/CH 10 | 16.14 | 16.14 | 30 | PASS |
| | 2462/CH 11 | 14.12 | 14.12 | 30 | PASS |
| 802.11n HT40 | 2422/CH 3 | 11.34 | 11.58 | 30 | PASS |
| | 2427/CH 4 | 11.24 | 11.48 | 30 | PASS |
| | 2432/CH 5 | 12.76 | 13.00 | 30 | PASS |
| | 2437/CH 6 | 14.10 | 14.34 | 30 | PASS |
| | 2442/CH 7 | 12.64 | 12.88 | 30 | PASS |
| | 2447/CH 8 | 11.54 | 11.78 | 30 | PASS |
| | 2452/CH 9 | 11.25 | 11.49 | 30 | PASS |
| Bluetooth (Low Energy) | 2402/CH 0 | 5.69 | 6.35 | 30 | PASS |
| | 2440/CH 19 | 5.24 | 5.90 | 30 | PASS |
| | 2480/CH 39 | 6.29 | 6.95 | 30 | PASS |

Note: Average Power with duty factor = Average Power Measured +Duty cycle correction factor

5.2. 99% Bandwidth and 6dB Bandwidth

Ambient condition

| Temperature | Relative humidity | Pressure |
|-------------|-------------------|----------|
| 23°C ~25°C | 45%~50% | 101.5kPa |

Method of Measurement

The EUT was connected to the spectrum analyzer through an external attenuator (20dB) and a known loss cable. RBW is set to 100 kHz; VBW is set to 300 kHz on spectrum analyzer. Dector=Peak, Trace mode=max hold.

The EUT was connected to the spectrum analyzer through a known loss cable. The resolution bandwidth (RBW) shall be in the range of 1% to 5% of the actual occupied / x dB bandwidth and the video bandwidth (VBW) shall not be smaller than three times the RBW value.

Test Setup

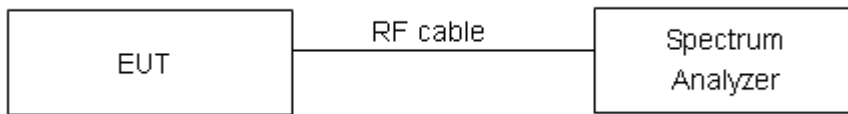

Limits

Rule Part 15.247 (a) (2) specifies that “Systems using digital modulation techniques may operate in the 902–928 MHz, 2400–2483.5 MHz bands. The minimum 6 dB bandwidth shall be at least 500 kHz.”

| | |
|------------------------|-----------|
| minimum 6 dB bandwidth | ≥ 500 kHz |
|------------------------|-----------|

Measurement Uncertainty

The assessed measurement uncertainty to ensure 95% confidence level for the normal distribution is with the coverage factor $k = 2$, $U = 936$ Hz.

Test Results:

| Test Mode | Carrier frequency (MHz) | 99% bandwidth (MHz) | Minimum 6 dB bandwidth (MHz) | Limit (kHz) | Conclusion |
|---------------------------|-------------------------|---------------------|------------------------------|-------------|------------|
| 802.11b | 2412/CH 1 | 13.61 | 8.08 | 500 | PASS |
| | 2437/CH 6 | 14.07 | 9.07 | 500 | PASS |
| | 2462/CH11 | 13.71 | 8.54 | 500 | PASS |
| 802.11g | 2412/CH 1 | 16.41 | 16.30 | 500 | PASS |
| | 2417/CH 2 | 16.49 | 15.36 | 500 | PASS |
| | 2422/CH 3 | 16.74 | 14.48 | 500 | PASS |
| | 2427/CH 4 | 16.85 | 12.94 | 500 | PASS |
| | 2437/CH 6 | 16.84 | 15.92 | 500 | PASS |
| | 2447/CH 8 | 16.71 | 15.00 | 500 | PASS |
| | 2452/CH 9 | 16.57 | 14.94 | 500 | PASS |
| | 2457/CH 10 | 16.47 | 15.67 | 500 | PASS |
| | 2462/CH 11 | 16.45 | 14.75 | 500 | PASS |
| 802.11n HT20 | 2412/CH 1 | 17.61 | 12.58 | 500 | PASS |
| | 2417/CH 2 | 17.68 | 16.36 | 500 | PASS |
| | 2422/CH 3 | 17.84 | 15.97 | 500 | PASS |
| | 2427/CH 4 | 17.94 | 16.27 | 500 | PASS |
| | 2437/CH 6 | 17.99 | 17.56 | 500 | PASS |
| | 2447/CH 8 | 17.88 | 16.00 | 500 | PASS |
| | 2452/CH 9 | 17.78 | 14.78 | 500 | PASS |
| | 2457/CH 10 | 17.66 | 15.10 | 500 | PASS |
| | 2462/CH 11 | 17.67 | 15.37 | 500 | PASS |
| 802.11n HT40 | 2422/CH 3 | 36.14 | 35.09 | 500 | PASS |
| | 2427/CH 4 | 36.24 | 35.74 | 500 | PASS |
| | 2432/CH 5 | 36.30 | 36.34 | 500 | PASS |
| | 2437/CH 6 | 36.32 | 36.33 | 500 | PASS |
| | 2442/CH 7 | 36.22 | 36.32 | 500 | PASS |
| | 2447/CH 8 | 36.13 | 35.34 | 500 | PASS |
| | 2452/CH 9 | 35.98 | 35.11 | 500 | PASS |
| Bluetooth (Low Energy) | 2402/CH 0 | 1.04 | 0.65 | 500 | PASS |
| | 2440/CH 19 | 1.04 | 0.65 | 500 | PASS |
| | 2480/CH 39 | 1.05 | 0.65 | 500 | PASS |



99%bandwidth

802.11b, Carrier frequency (MHz): 2412



802.11g, Carrier frequency (MHz): 2412

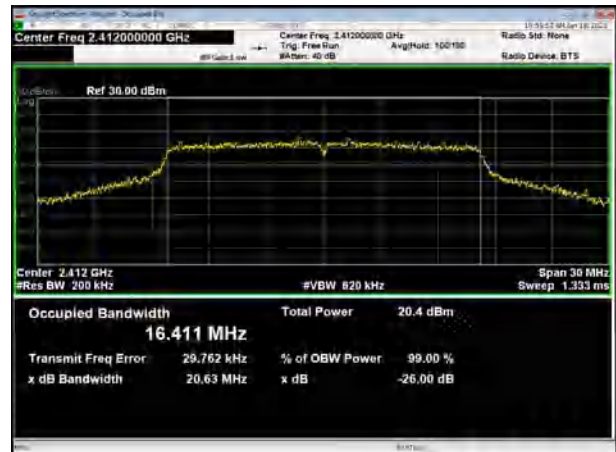

802.11b, Carrier frequency (MHz): 2437



802.11g, Carrier frequency (MHz): 2417



802.11b, Carrier frequency (MHz):2462



802.11g, Carrier frequency (MHz): 2422

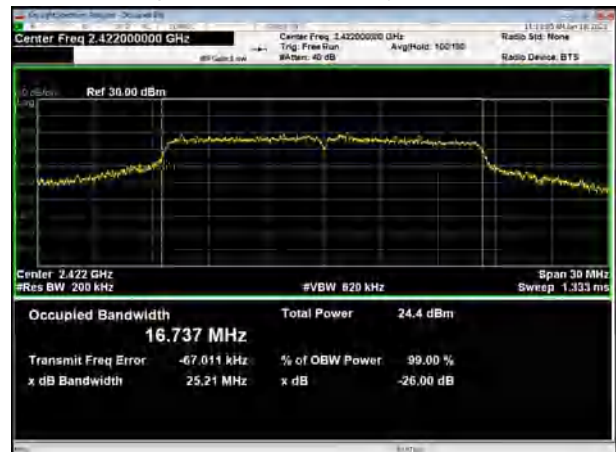



802.11g, Carrier frequency (MHz): 2427

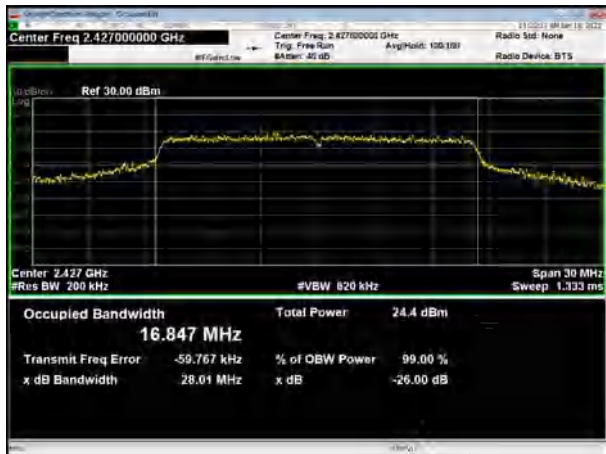

802.11g, Carrier frequency (MHz): 2437

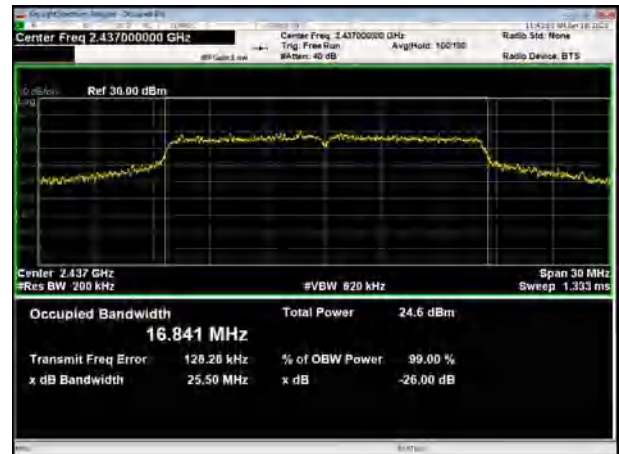

802.11g, Carrier frequency (MHz): 2447

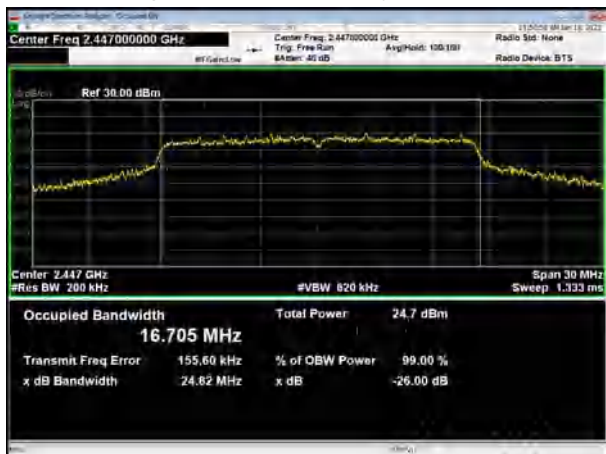

802.11g, Carrier frequency (MHz): 2452

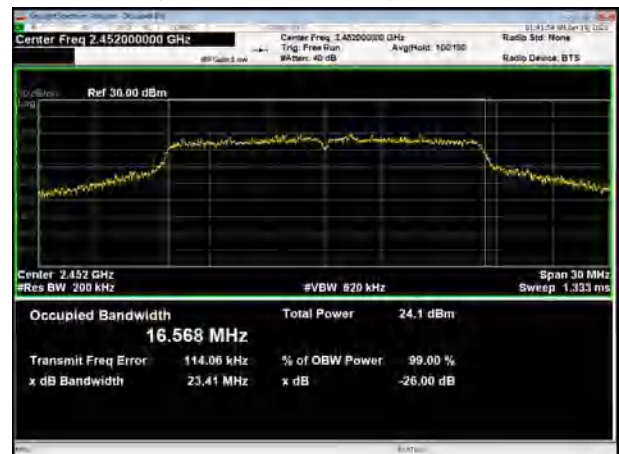

802.11g, Carrier frequency (MHz): 2457

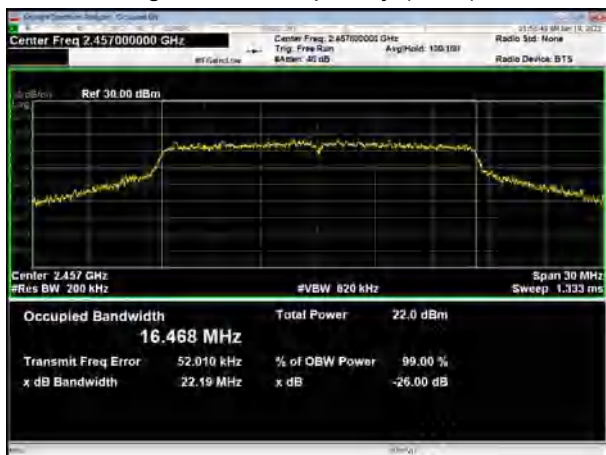

802.11g, Carrier frequency (MHz): 2462



802.11n(HT20), Carrier frequency (MHz): 2412

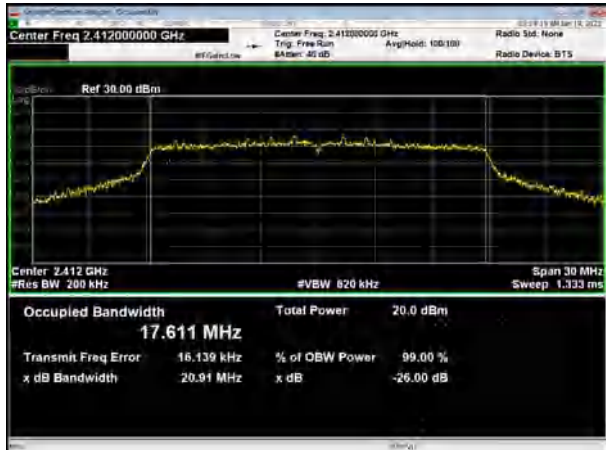

802.11n(HT40), Carrier frequency (MHz): 2422

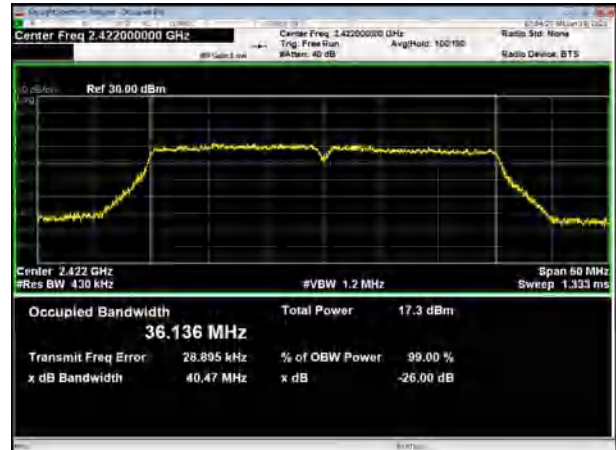

802.11n(HT20), Carrier frequency (MHz): 2417



802.11n(HT40), Carrier frequency (MHz): 2427

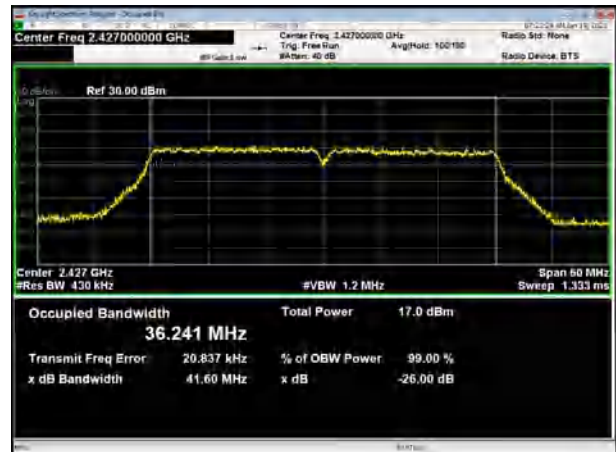

802.11n(HT20), Carrier frequency (MHz): 2422

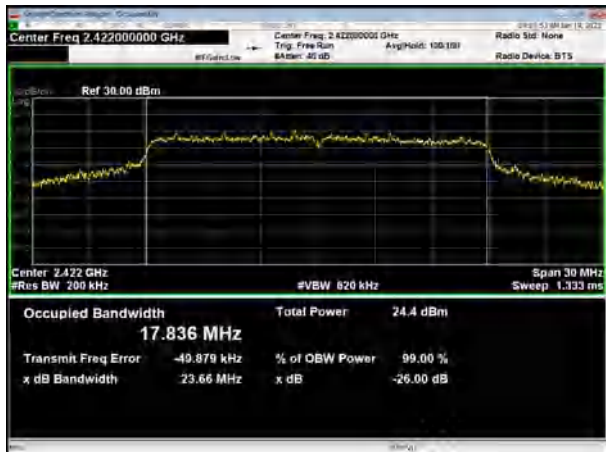

802.11n(HT40), Carrier frequency (MHz): 2432

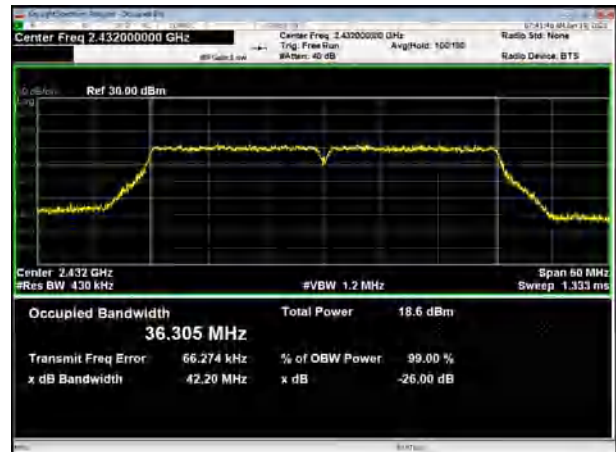

802.11n(HT20), Carrier frequency (MHz): 2427

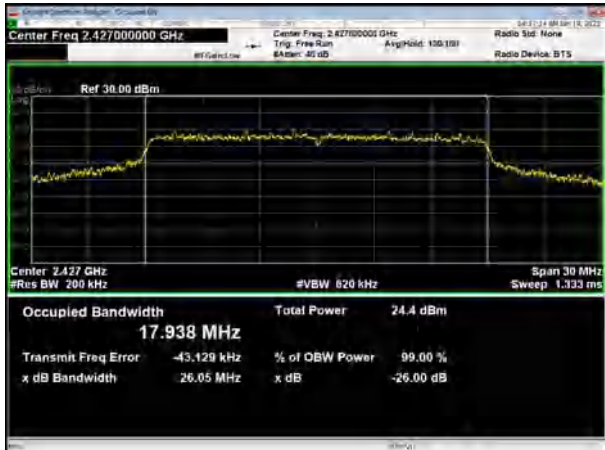

802.11n(HT40), Carrier frequency (MHz): 2437

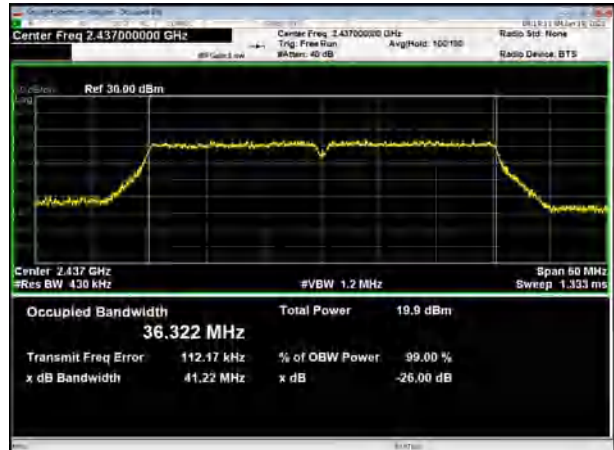

802.11n(HT20), Carrier frequency (MHz): 2437



802.11n(HT40), Carrier frequency (MHz): 2442

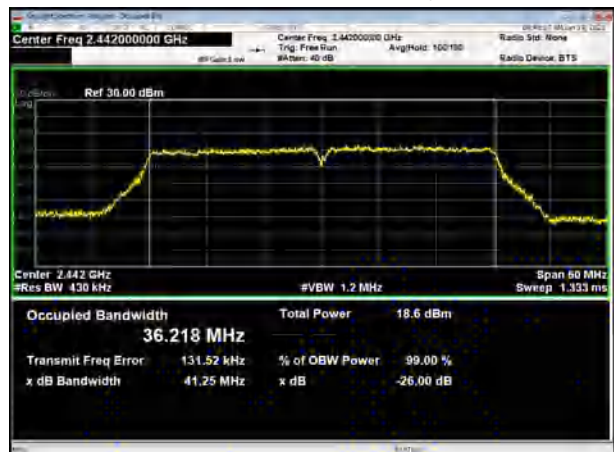

802.11n(HT20), Carrier frequency (MHz): 2447



802.11n(HT40), Carrier frequency (MHz): 2447

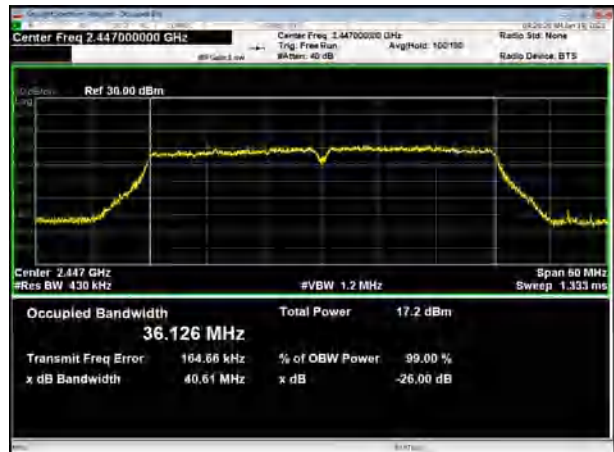

802.11n(HT20), Carrier frequency (MHz): 2452

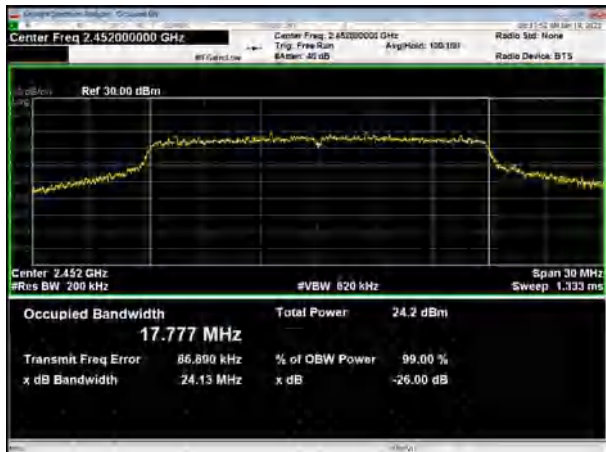

802.11n(HT40), Carrier frequency (MHz): 2452



802.11n(HT20), Carrier frequency (MHz): 2457

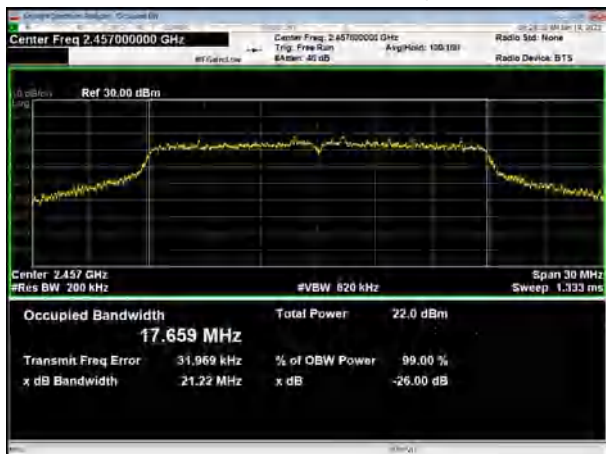

802.11n(HT20), Carrier frequency (MHz): 2462



Bluetooth LE Carrier frequency (MHz): 2402



Bluetooth LE Carrier frequency (MHz): 2440



Bluetooth LE Carrier frequency (MHz): 2480

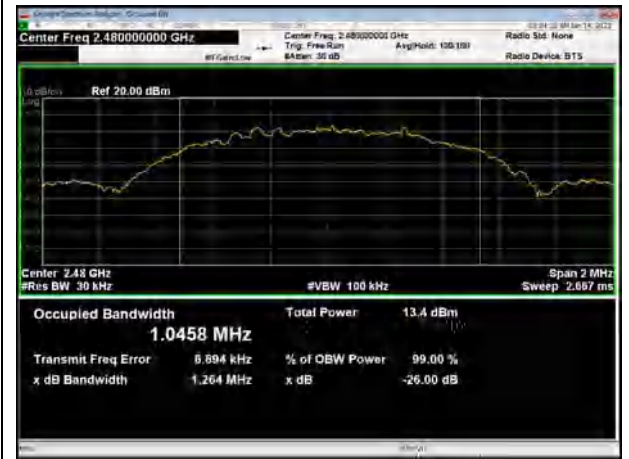



6 dB bandwidth

802.11b, Carrier frequency (MHz): 2412



802.11g, Carrier frequency (MHz): 2412



802.11b, Carrier frequency (MHz): 2437



802.11g, Carrier frequency (MHz): 2417

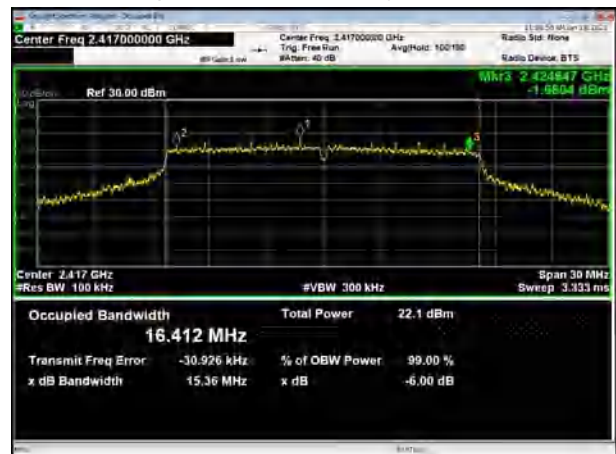

802.11b, Carrier frequency (MHz): 2462



802.11g, Carrier frequency (MHz): 2422



802.11g, Carrier frequency (MHz): 2427

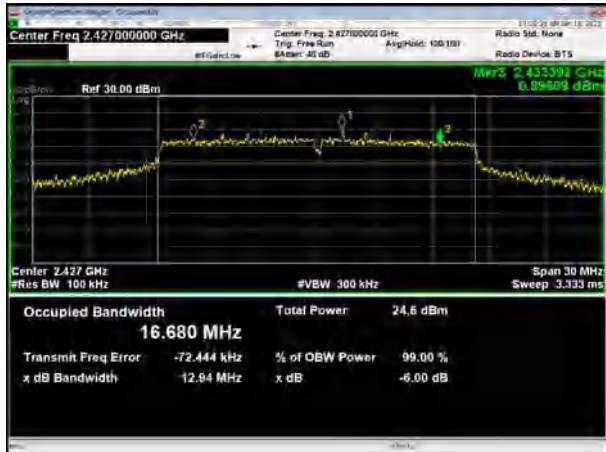

802.11g, Carrier frequency (MHz): 2437



802.11g, Carrier frequency (MHz): 2447

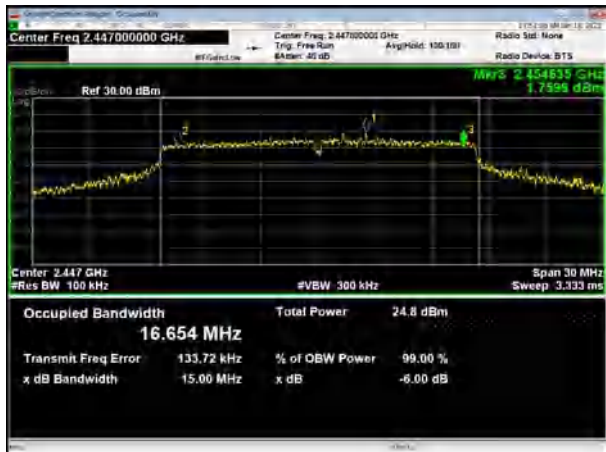

802.11g, Carrier frequency (MHz): 2452



802.11g, Carrier frequency (MHz): 2457

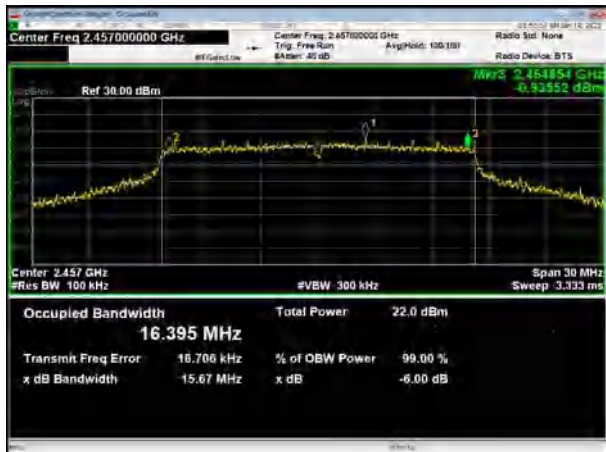

802.11g, Carrier frequency (MHz): 2462



802.11n(HT20), Carrier frequency (MHz): 2412



802.11n(HT40), Carrier frequency (MHz): 2422

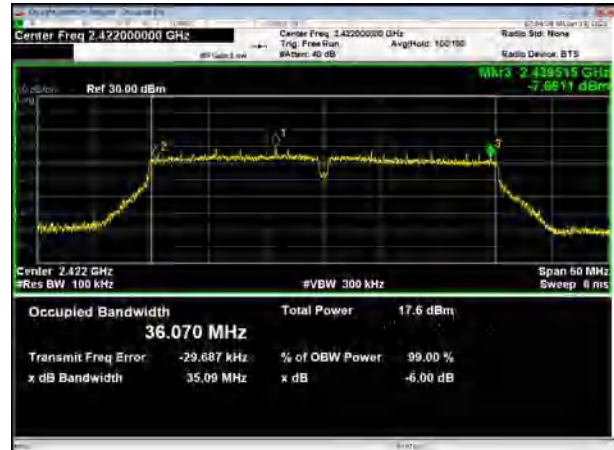

802.11n(HT20), Carrier frequency (MHz): 2417

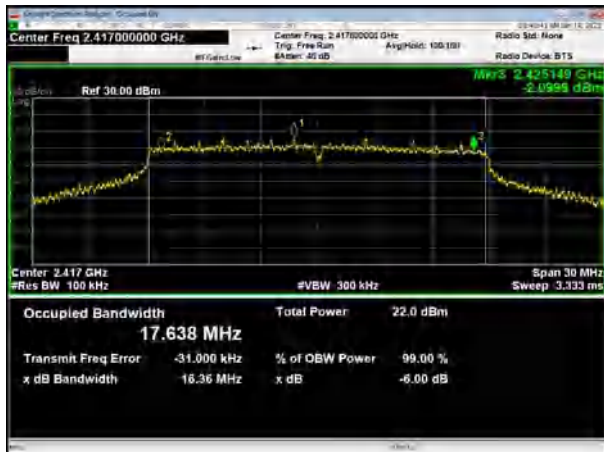

802.11n(HT40), Carrier frequency (MHz): 2427



802.11n(HT20), Carrier frequency (MHz): 2422

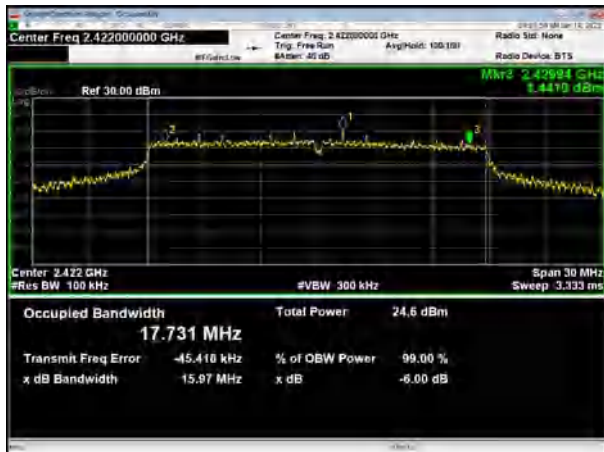

802.11n(HT40), Carrier frequency (MHz): 2432



802.11n(HT20), Carrier frequency (MHz): 2427

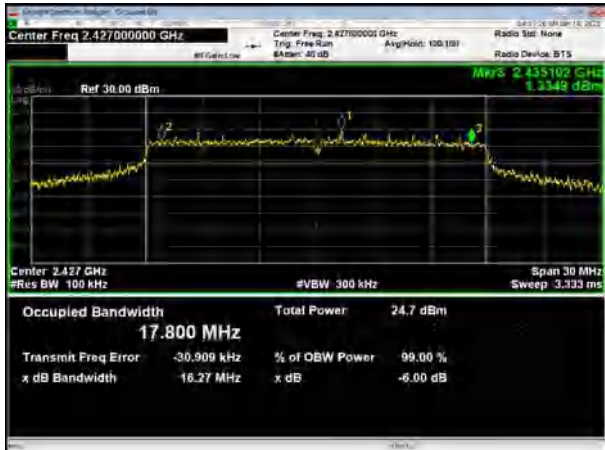

802.11n(HT40), Carrier frequency (MHz): 2437



802.11n(HT20), Carrier frequency (MHz): 2437



802.11n(HT40), Carrier frequency (MHz): 2442



802.11n(HT20), Carrier frequency (MHz): 2447



802.11n(HT40), Carrier frequency (MHz): 2447



802.11n(HT20), Carrier frequency (MHz): 2452



802.11n(HT40), Carrier frequency (MHz): 2452

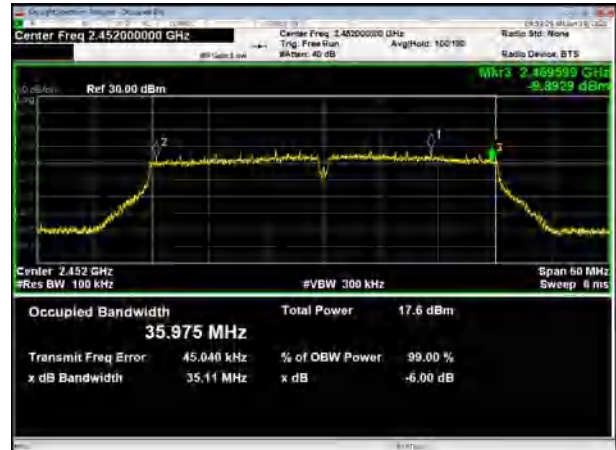

802.11n(HT20), Carrier frequency (MHz): 2457

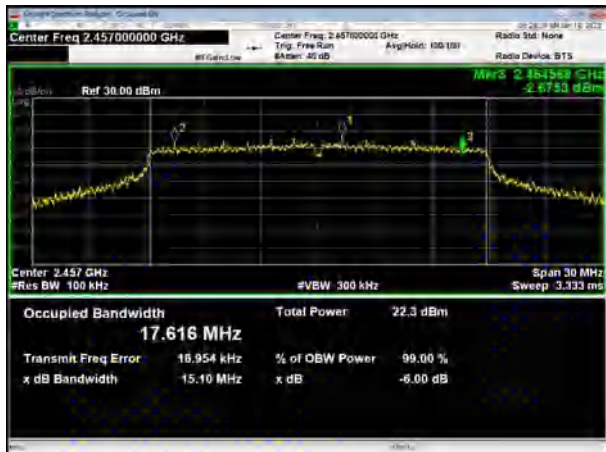

802.11n(HT20), Carrier frequency (MHz): 2462

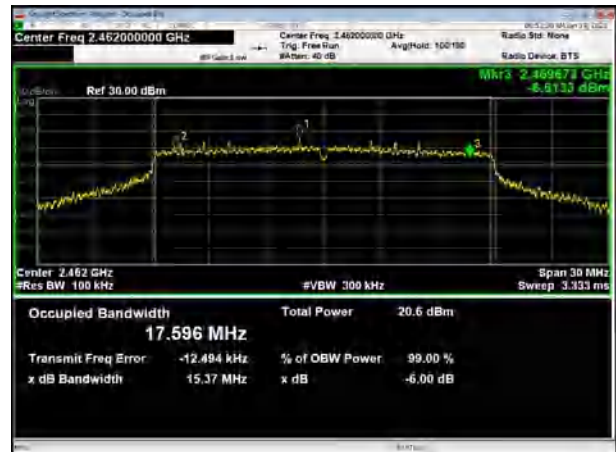

Bluetooth LE Carrier frequency (MHz): 2402



Bluetooth LE Carrier frequency (MHz): 2440



Bluetooth LE Carrier frequency (MHz): 2480



5.3. Band Edge

Ambient condition

| Temperature | Relative humidity | Pressure |
|-------------|-------------------|----------|
| 23°C ~25°C | 45%~50% | 101.5kPa |

Method of Measurement

The EUT was connected to the spectrum analyzer through an external attenuator (20dB) and a known loss cable the band edge of the lowest and highest channels were measured. The peak detector is used and RBW is set to 100 kHz and VBW is set to 300 kHz on spectrum analyzer. Spectrum analyzer plots are included on the following pages.

Test Setup

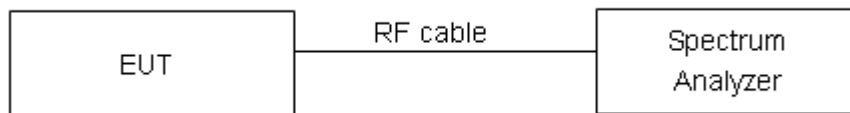

Limits

Rule Part 15.247(d) specifies that “In any 100 kHz bandwidth outside the frequency band in which the spread spectrum or digitally modulated intentional radiator is operating, the radio frequency power that is produced by the intentional radiator shall be at least 20 dB below that in the 100 kHz bandwidth within the band that contains the highest level of the desired power, based on either an RF conducted or a radiated measurement, provided the transmitter demonstrates compliance with the peak conducted power limits.” If the transmitter complies with the conducted power limits based on the use of RMS averaging over a time interval, as permitted under paragraph (b)(3) of this section, the attenuation required under this paragraph shall be 30 dB instead of 20 dB.”

Measurement Uncertainty

The assessed measurement uncertainty to ensure 95% confidence level for the normal distribution is with the coverage factor $k = 1.96$.

| Frequency | Uncertainty |
|-----------|-------------|
| 2GHz-3GHz | 1.407 dB |



Test Results: PASS

802.11b, Channel No.: 1



802.11b, Channel No.: 11





802.11g, Channel No.: 1



802.11g, Channel No.: 2





802.11g, Channel No.: 3



802.11g, Channel No.: 4





802.11g, Channel No.: 8



802.11g, Channel No.: 9





802.11g, Channel No.: 10



802.11g, Channel No.: 11





802.11n(HT20), Channel No. 1



802.11n(HT20), Channel No. 2





802.11n(HT20), Channel No. 3



802.11n(HT20), Channel No. 4





802.11n(HT20), Channel No. 8



802.11n(HT20), Channel No. 9





802.11n(HT20), Channel No. 10

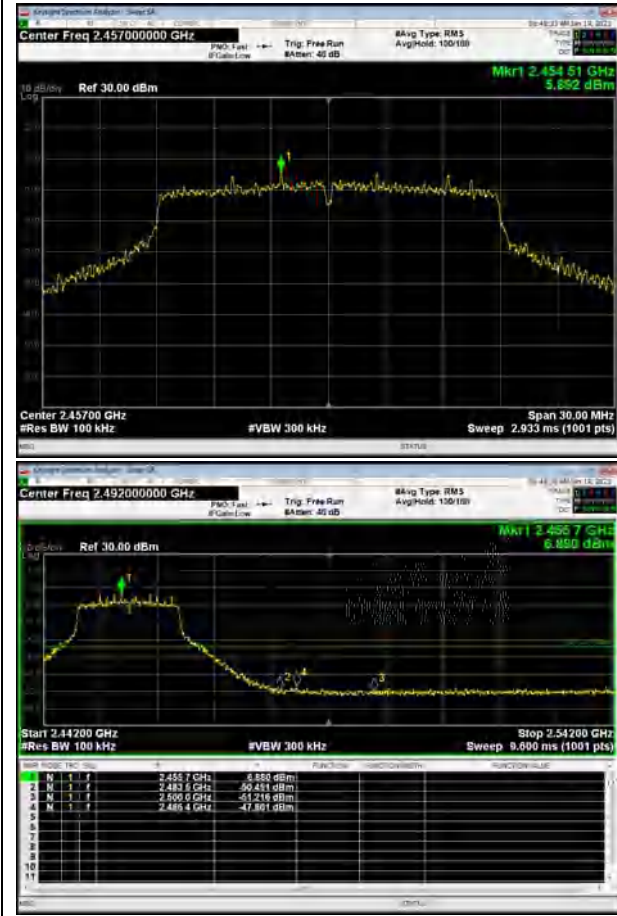

802.11n(HT20), Channel No. 11





802.11n(HT40), Channel No. 3



802.11n(HT40), Channel No. 4





802.11n(HT40), Channel No. 5



802.11n(HT40), Channel No. 6





802.11n(HT40), Channel No. 7



802.11n(HT40), Channel No. 8







Bluetooth LE, Channel No.: 0

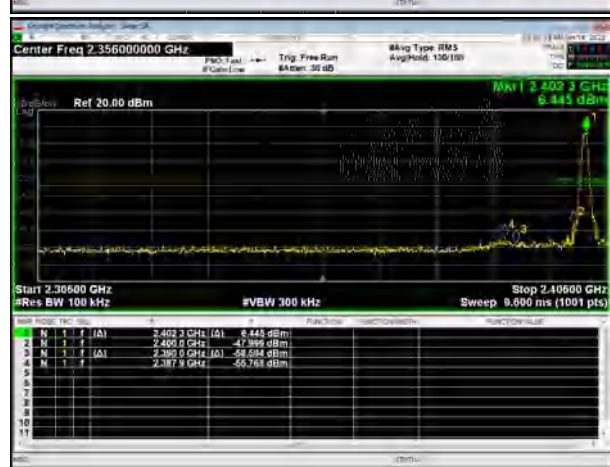
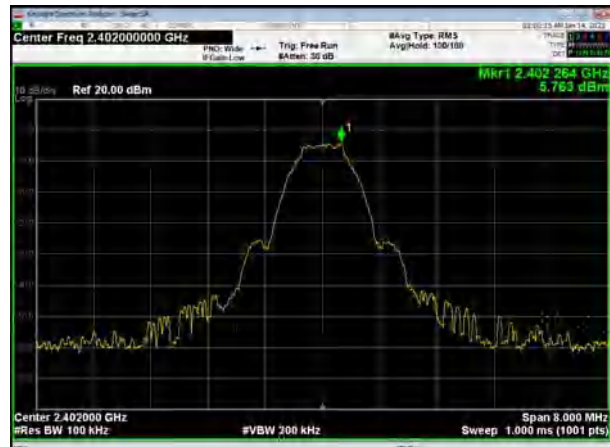

Bluetooth LE, Channel No.: 39

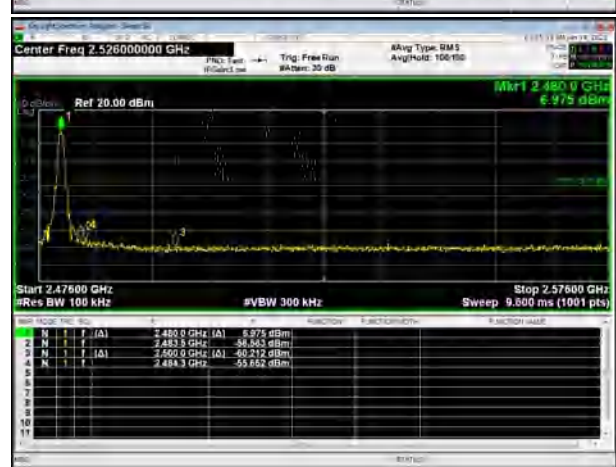

5.4. Power Spectral Density

Ambient condition

| Temperature | Relative humidity | Pressure |
|-------------|-------------------|----------|
| 23°C ~25°C | 45%~50% | 101.5kPa |

Method of Measurement

During the process of the testing, The EUT was connected to Spectrum Analyzer with a known loss.

The EUT is max power transmission with proper modulation.

Method AVGPSD-1 was used for this test.

- a) Set instrument center frequency to DTS channel center frequency
- b) Set span to at least 1.5 times the OBW
- c) Set RBW to: $3\text{kHz} \leq \text{RBW} \leq 100\text{kHz}$
- d) Set VBW $\geq [3 \times \text{RBW}]$
- e) Detector=power averaging(rms) or sample detector(when rms not available)
- f) Ensure that the number of measurement points in the sweep $2[2 \times \text{span}/\text{RBWT}]$
- g)Sweep time auto couple
- h) Employ trace averaging(rms) mode over a minimum of 100 traces
- i) Use the peak marker function to determine the maximum amplitude level.
- j) If the measured value exceeds requirement, then reduce RBW (but no less than 3 kHz) and repeat(note that this may require zooming in on the emission of interest and reducing the span to meet the minimum measurement point requirement as the RBW is reduced)

Method AVGPSD-2 was used for this test.

- a) Measure the duty cycle(D)of the transmitter output signal as described in 11.6
- b) Set instrument center frequency to DTS channel center frequency
- c)Set span to at least 1.5 times the OBW
- d) Set RBW to: $3\text{kHz} \leq \text{RBW} \leq 100\text{Kh}$
- e) Set VBW $\geq [3 \times \text{RBW}]$
- f)Detector= power averaging(rms) or sample detector (when rms not available)
- g) Ensure that the number of measurement points in the sweep $2[2 \times \text{span}/\text{RBW}]$
- h) Sweep time =auto couple
- i) Do not use sweep triggering; allow sweep to "free run"
- j) Employ trace averaging(rms) mode over a minimum of 100 traces
- k) Use the peak marker function to determine the maximum amplitude level
- l) Add $[10 \log(1/ D)]$, where D is the duty cycle measured in step a), to the measured PSD to

compute the average PSD during the actual transmission time

m) If measured value exceeds requirement specified by regulatory agency then reduce RBW (but no less than 3 kHz) and repeat (note that this may require zooming in on the emission of interest and reducing the span to meet the minimum measurement point requirement as the RBW is reduced)

Test setup

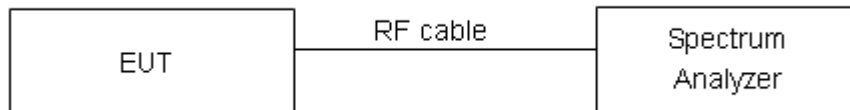

Limits

Rule Part 15.247(e) specifies that "For digitally modulated systems, the power spectral density conducted from the intentional radiator to the antenna shall not be greater than 8 dBm in any 3 kHz band during any time interval of continuous transmission."

| | |
|--------|------------------------------------|
| Limits | $\leq 8 \text{ dBm} / 3\text{kHz}$ |
|--------|------------------------------------|

Measurement Uncertainty

The assessed measurement uncertainty to ensure 95% confidence level for the normal distribution is with the coverage factor $k = 2$, $U = 0.75\text{dB}$.

**Test Results:**

| Test Mode | Channel Number | Read Value (dBm / 3kHz) | Power Spectral Density (dBm / 3kHz) | Limit (dBm / 3kHz) | Conclusion |
|---------------------------|----------------|-------------------------|-------------------------------------|--------------------|------------|
| 802.11b | 2412/CH 1 | -13.41 | -13.41 | 8 | PASS |
| | 2437/CH 6 | -14.21 | -14.21 | 8 | PASS |
| | 2462/CH11 | -13.54 | -13.54 | 8 | PASS |
| 802.11g | 2412/CH 1 | -19.29 | -19.29 | 8 | PASS |
| | 2417/CH 2 | -17.86 | -17.86 | 8 | PASS |
| | 2422/CH 3 | -15.53 | -15.53 | 8 | PASS |
| | 2427/CH 4 | -15.66 | -15.66 | 8 | PASS |
| | 2437/CH 6 | -15.31 | -15.31 | 8 | PASS |
| | 2447/CH 8 | -15.25 | -15.25 | 8 | PASS |
| | 2452/CH 9 | -15.76 | -15.76 | 8 | PASS |
| | 2457/CH 10 | -18.14 | -18.14 | 8 | PASS |
| | 2462/CH 11 | -19.50 | -19.50 | 8 | PASS |
| 802.11n HT20 | 2412/CH 1 | -19.97 | -19.97 | 8 | PASS |
| | 2417/CH 2 | -18.34 | -18.34 | 8 | PASS |
| | 2422/CH 3 | -15.86 | -15.86 | 8 | PASS |
| | 2427/CH 4 | -15.96 | -15.96 | 8 | PASS |
| | 2437/CH 6 | -15.54 | -15.54 | 8 | PASS |
| | 2447/CH 8 | -16.42 | -16.42 | 8 | PASS |
| | 2452/CH 9 | -16.67 | -16.67 | 8 | PASS |
| | 2457/CH 10 | -17.79 | -17.79 | 8 | PASS |
| | 2462/CH 11 | -19.64 | -19.64 | 8 | PASS |
| 802.11n HT40 | 2422/CH 3 | -27.06 | -26.82 | 8 | PASS |
| | 2427/CH 4 | -26.43 | -26.19 | 8 | PASS |
| | 2432/CH 5 | -26.35 | -26.11 | 8 | PASS |
| | 2437/CH 6 | -24.45 | -24.21 | 8 | PASS |
| | 2442/CH 7 | -25.14 | -24.90 | 8 | PASS |
| | 2447/CH 8 | -26.03 | -25.79 | 8 | PASS |
| | 2452/CH 9 | -25.84 | -25.60 | 8 | PASS |
| Bluetooth (Low Energy) | 2402/CH 0 | -15.36 | -14.70 | 8 | PASS |
| | 2440/CH 19 | -15.98 | -15.32 | 8 | PASS |
| | 2480/CH 39 | -15.00 | -14.34 | 8 | PASS |

Note: Power Spectral Density =Read Value+Duty cycle correction factor

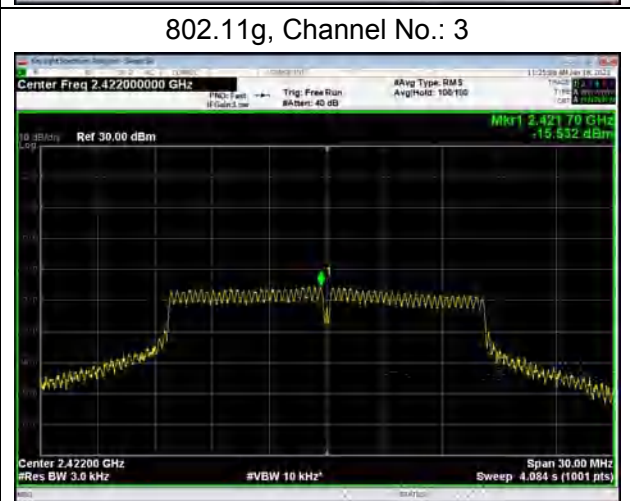
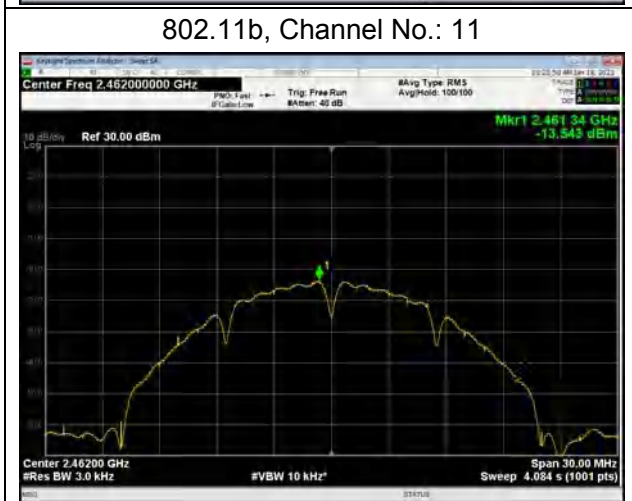
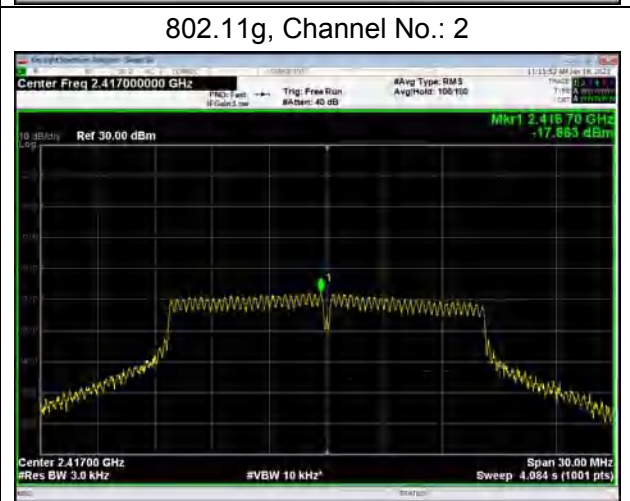
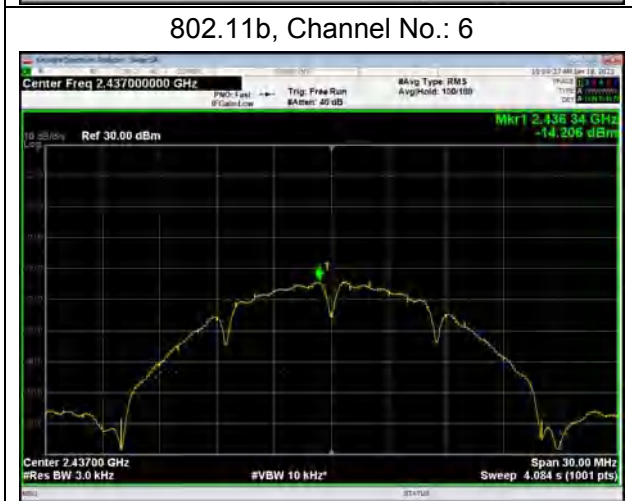
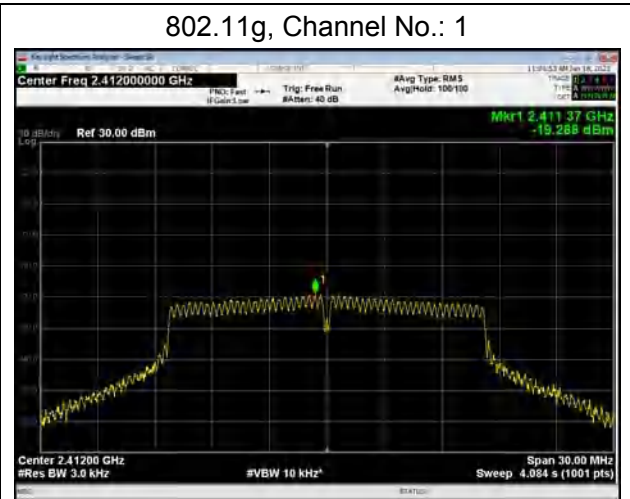



802.11g, Channel No.: 4

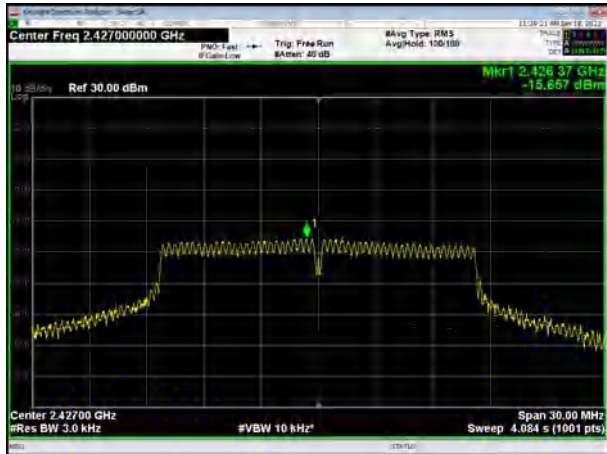

802.11g, Channel No.: 6

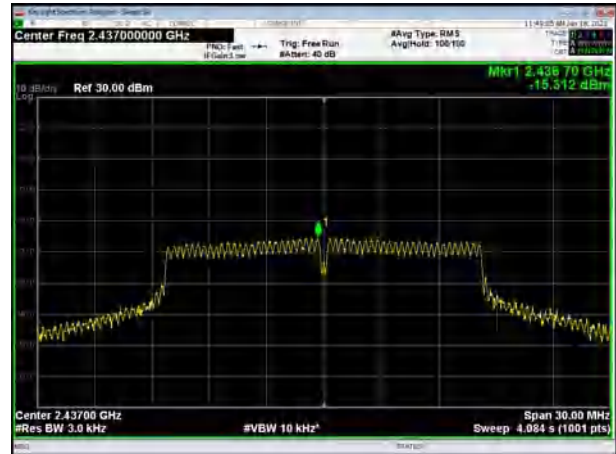

802.11g, Channel No.: 8



802.11g, Channel No.: 9

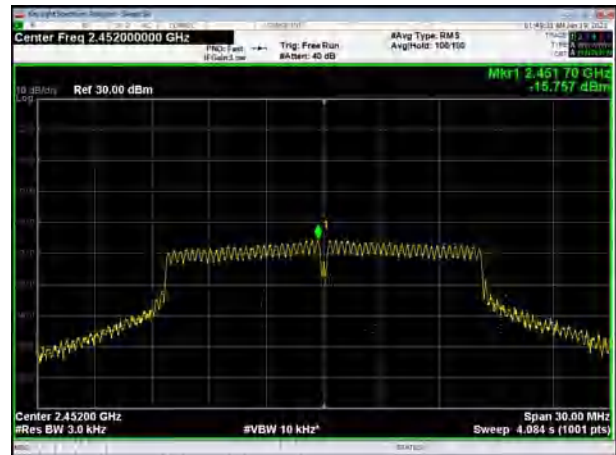

802.11g, Channel No.: 10

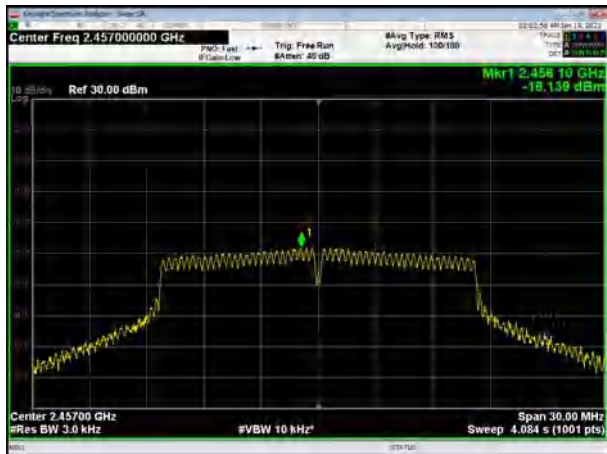

802.11g, Channel No.: 11

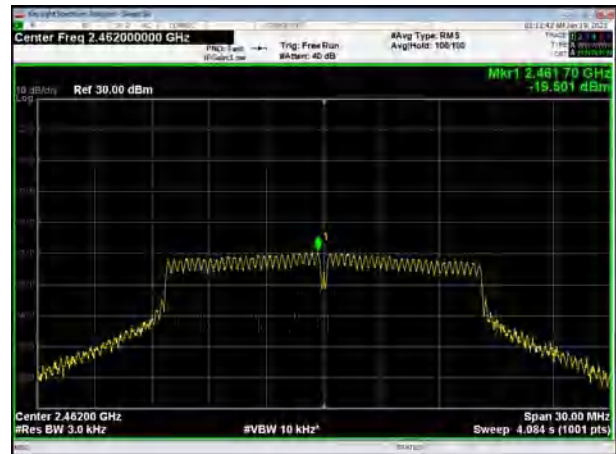



802.11n(HT20), Channel No. 1

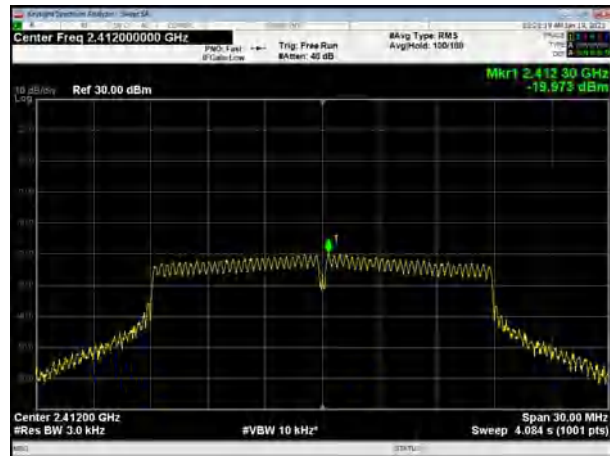

802.11n(HT40), Channel No. 3



802.11n(HT20), Channel No. 2

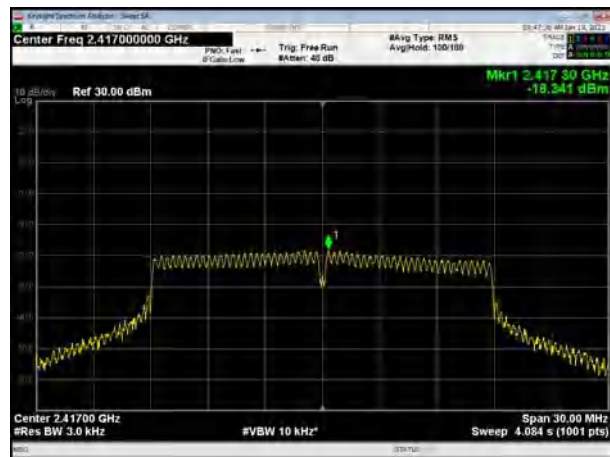

802.11n(HT40), Channel No. 4

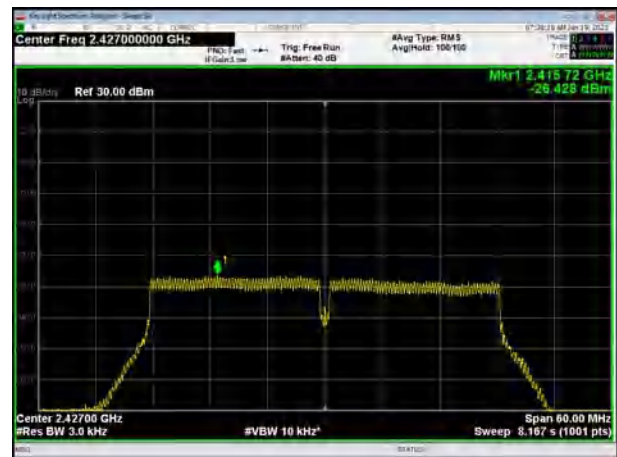

802.11n(HT20), Channel No. 3



802.11n(HT40), Channel No. 5

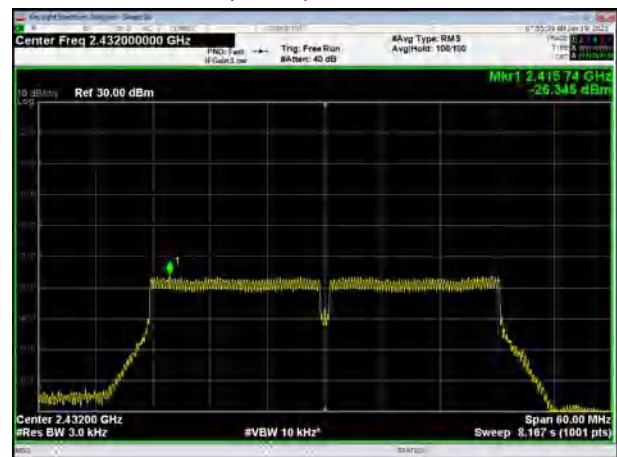



802.11n(HT20), Channel No. 4

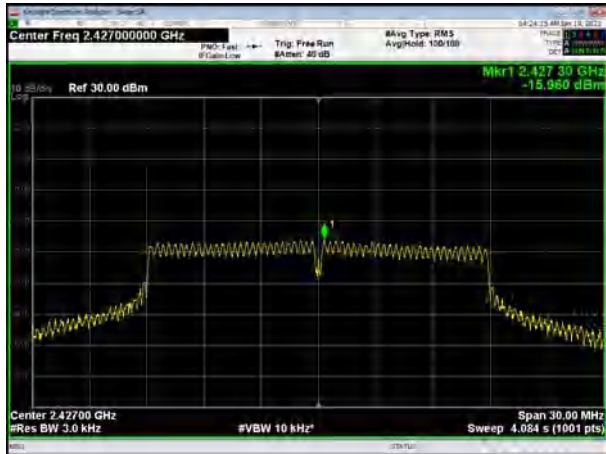

802.11n(HT40), Channel No. 6

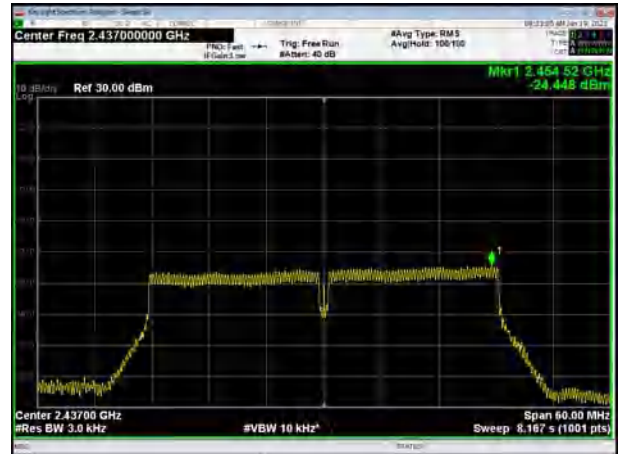

802.11n(HT20), Channel No. 6



802.11n(HT40), Channel No. 7



802.11n(HT20), Channel No. 8

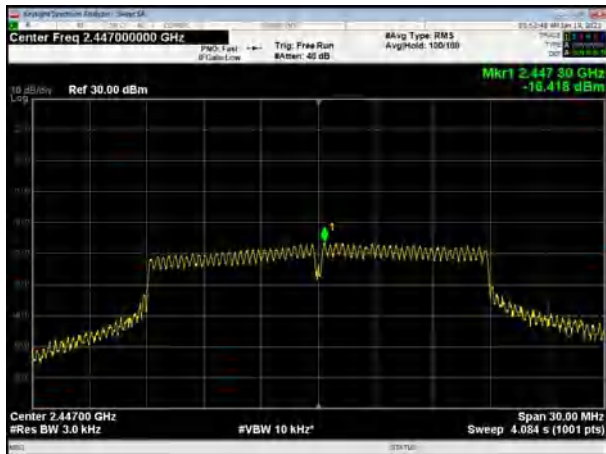

802.11n(HT40), Channel No. 8

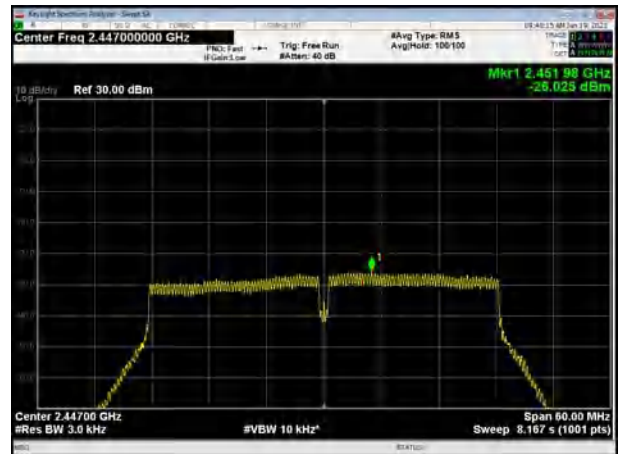



802.11n(HT20), Channel No. 9

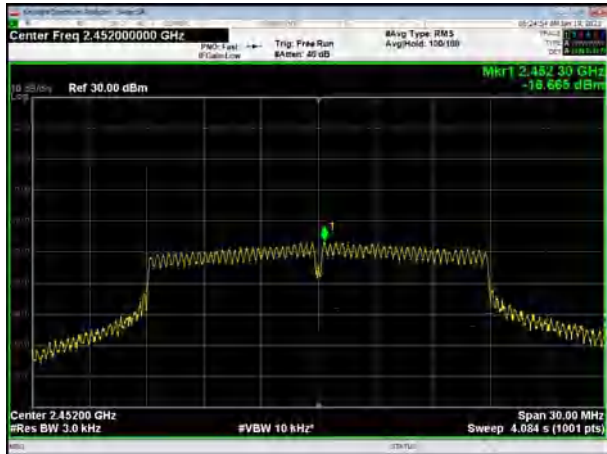

802.11n(HT40), Channel No. 9



802.11n(HT20), Channel No. 10

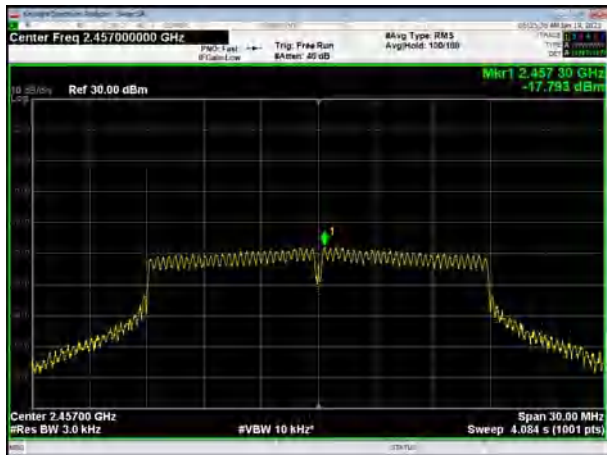

802.11n(HT20), Channel No. 11

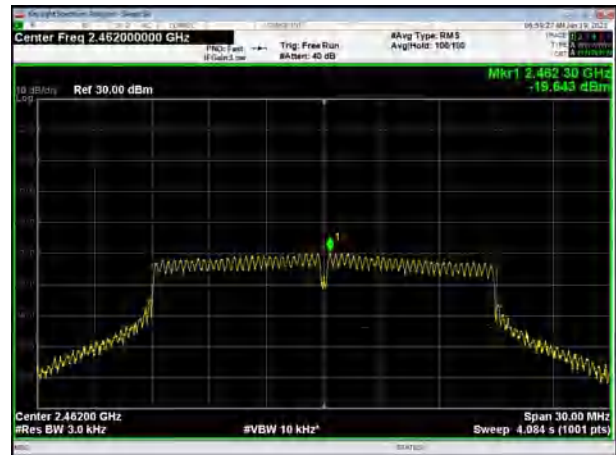

Bluetooth LE, Channel No.: 0



Bluetooth LE, Channel No.: 19



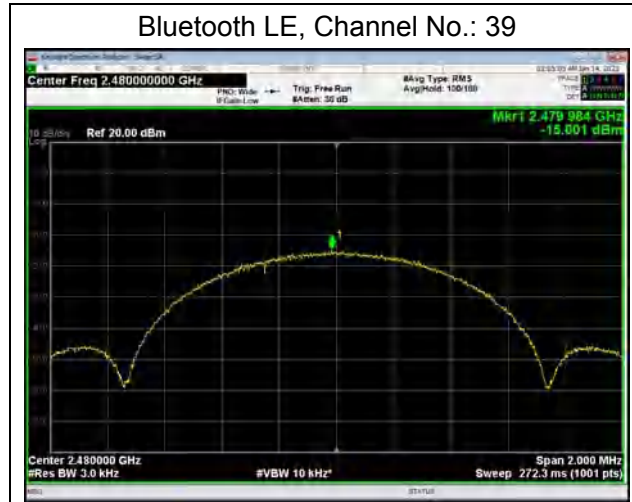

5.5. Spurious RF Conducted Emissions

Ambient condition

| Temperature | Relative humidity | Pressure |
|-------------|-------------------|----------|
| 23°C ~25°C | 45%~50% | 101.5kPa |

Method of Measurement

The EUT was connected to the spectrum analyzer with a known loss. The spectrum analyzer scans from 30MHz to the 10th harmonic of the carrier. The peak detector is used. Set RBW to 100 kHz and VBW to 300 kHz, Sweep is set to ATUO.

The test is in transmitting mode.

Test setup



Limits

Rule Part 15.247(d) pacifies that “In any 100 kHz bandwidth outside the frequency band in which the spread spectrum or digitally modulated intentional radiator is operating, the radio frequency power that is produced by the intentional radiator shall be at least 20 dB below that in the 100 kHz bandwidth within the band that contains the highest level of the desired power, based on either an RF conducted or a radiated measurement, provided the transmitter demonstrates compliance with the peak conducted power limits. If the transmitter complies with the conducted power limits based on the use of RMS averaging over a time interval, as permitted under paragraph (b)(3) of this section, the attenuation required under this paragraph shall be 30 dB instead of 20 dB. ”

Antenna 1

| Test Mode | Carrier frequency (MHz) | Reference value (dBm) | Limit |
|-----------|-------------------------|-----------------------|--------|
| 802.11b | 2412/CH 1 | 10.56 | -19.44 |
| | 2437/CH 6 | 9.96 | -20.04 |
| | 2462/CH11 | 10.41 | -19.59 |
| 802.11g | 2412/CH 1 | 5.66 | -24.34 |
| | 2417/CH 2 | 6.46 | -23.54 |
| | 2422/CH 3 | 7.50 | -22.50 |
| | 2427/CH 4 | 9.13 | -20.87 |
| | 2437/CH 6 | 8.43 | -21.57 |
| | 2447/CH 8 | 9.29 | -20.71 |
| | 2452/CH 9 | 7.93 | -22.07 |
| | 2457/CH 10 | 3.82 | -26.18 |



| | | | |
|---------------------------|------------|-------|--------|
| | 2462/CH 11 | 2.40 | -27.60 |
| 802.11n HT20 | 2412/CH 1 | 5.44 | -24.56 |
| | 2417/CH 2 | 5.78 | -24.22 |
| | 2422/CH 3 | 8.24 | -21.76 |
| | 2427/CH 4 | 8.15 | -21.85 |
| | 2437/CH 6 | 8.50 | -21.50 |
| | 2447/CH 8 | 7.75 | -22.25 |
| | 2452/CH 9 | 9.86 | -20.14 |
| | 2457/CH 10 | 7.49 | -22.51 |
| | 2462/CH 11 | 5.19 | -24.81 |
| 802.11n HT40 | 2422/CH 3 | -2.97 | -32.97 |
| | 2427/CH 4 | -1.97 | -31.97 |
| | 2432/CH 5 | -1.50 | -31.50 |
| | 2437/CH 6 | 0.28 | -29.72 |
| | 2442/CH 7 | -0.54 | -30.54 |
| | 2447/CH 8 | -1.30 | -31.30 |
| | 2452/CH 9 | -1.22 | -31.22 |
| Bluetooth (Low Energy) | 2402/CH 0 | 6.31 | -23.69 |
| | 2440/CH 19 | 6.00 | -24.00 |
| | 2480/CH 39 | 6.90 | -23.10 |

Measurement Uncertainty

The assessed measurement uncertainty to ensure 95% confidence level for the normal distribution is with the coverage factor $k = 1.96$.

| Frequency | Uncertainty |
|-------------|-------------|
| 100kHz-2GHz | 0.684 dB |
| 2GHz-26GHz | 1.407 dB |



Test Results:

802.11b, Channel No.: 1



802.11g, Channel No.: 1

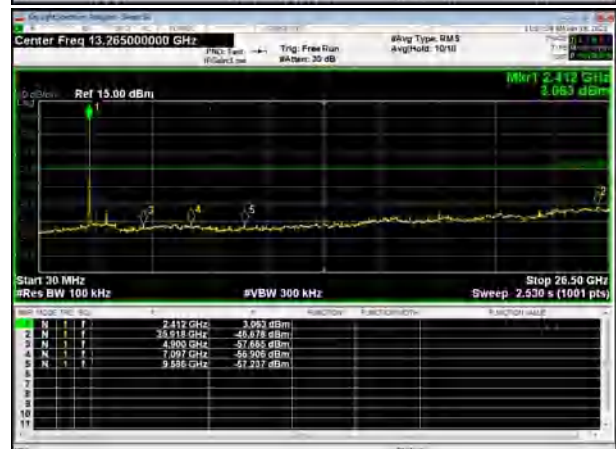
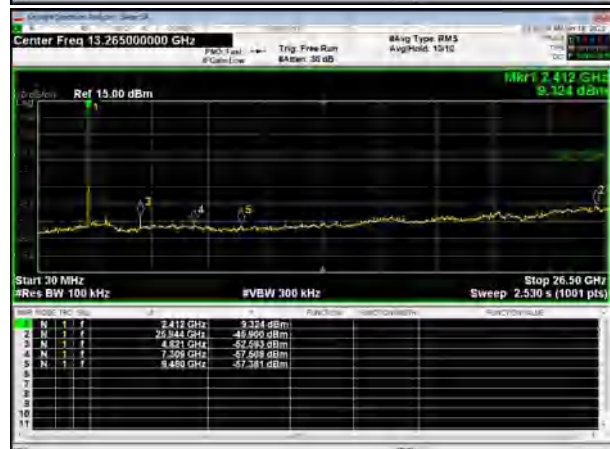



802.11b, Channel No.: 6



802.11g, Channel No.: 2





802.11b, Channel No.: 11



802.11g, Channel No.: 3

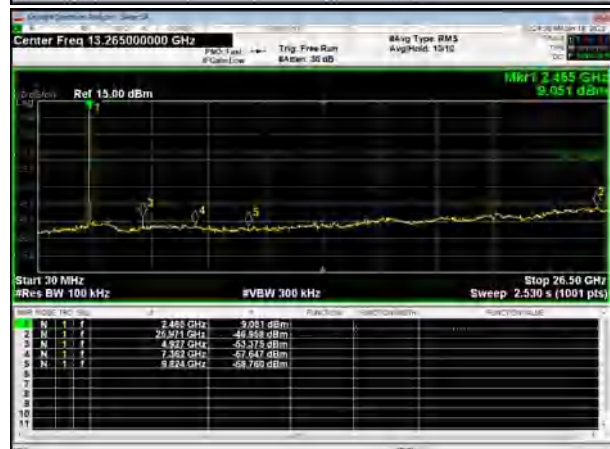



802.11g, Channel No.: 4



802.11g, Channel No.: 6





802.11g, Channel No.: 8



802.11g, Channel No.: 9





802.11g, Channel No.: 10



802.11g, Channel No.: 11





802.11n(HT20), Channel No. 1



802.11n(HT40), Channel No. 3





802.11n(HT20), Channel No. 2

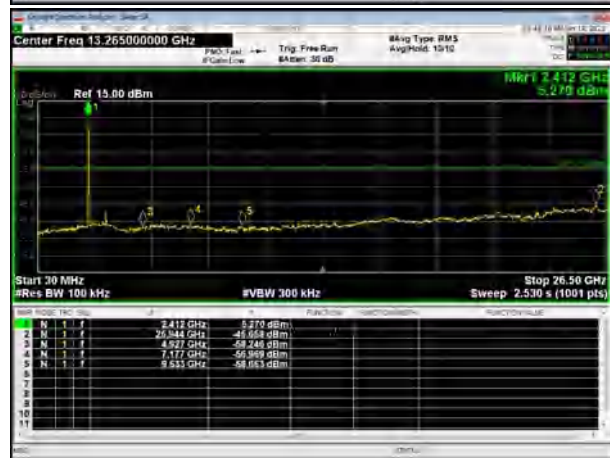

802.11n(HT40), Channel No. 4

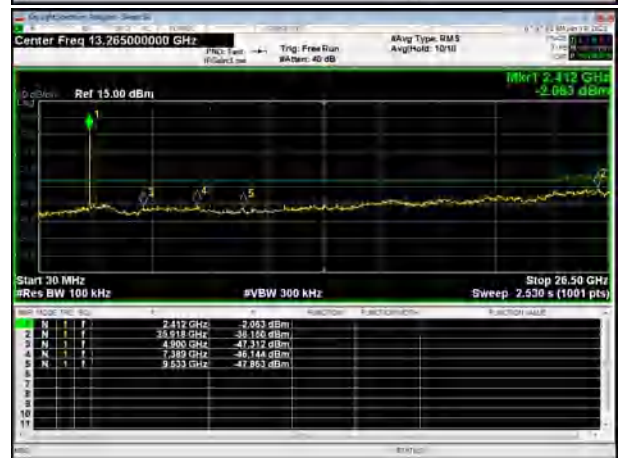



802.11n(HT20), Channel No. 3



802.11n(HT40), Channel No. 5

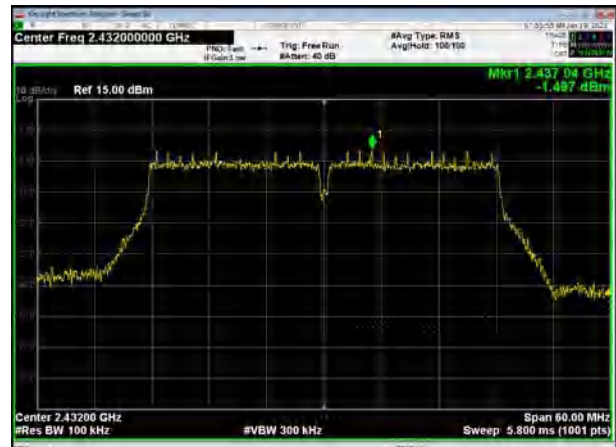



802.11n(HT20), Channel No. 4



802.11n(HT40), Channel No. 6





802.11n(HT20), Channel No. 6



802.11n(HT40), Channel No. 7

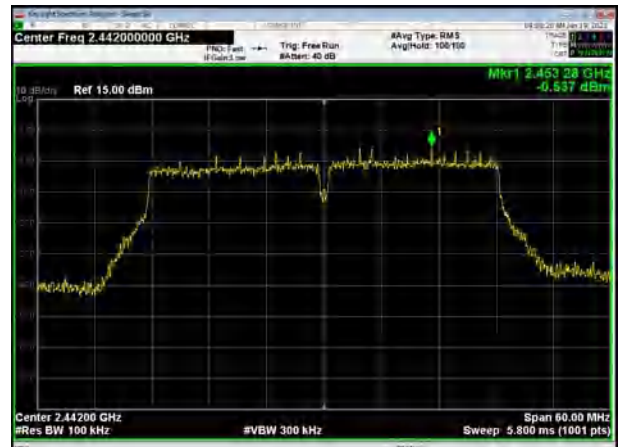



802.11n(HT20), Channel No. 8



802.11n(HT40), Channel No. 8





802.11n(HT20), Channel No. 9



802.11n(HT40), Channel No. 9





802.11n(HT20), Channel No. 10



802.11n(HT20), Channel No. 11

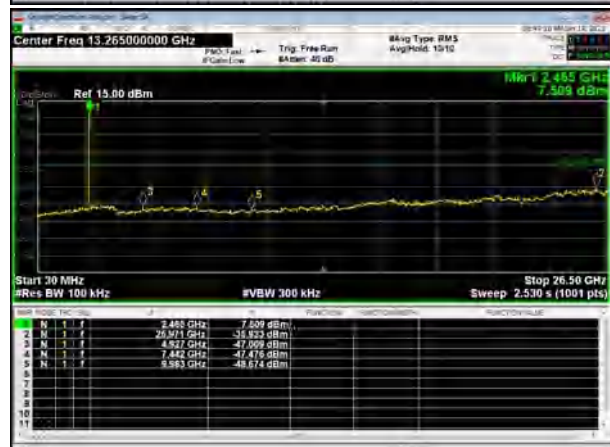



Bluetooth LE, Channel No.: 0

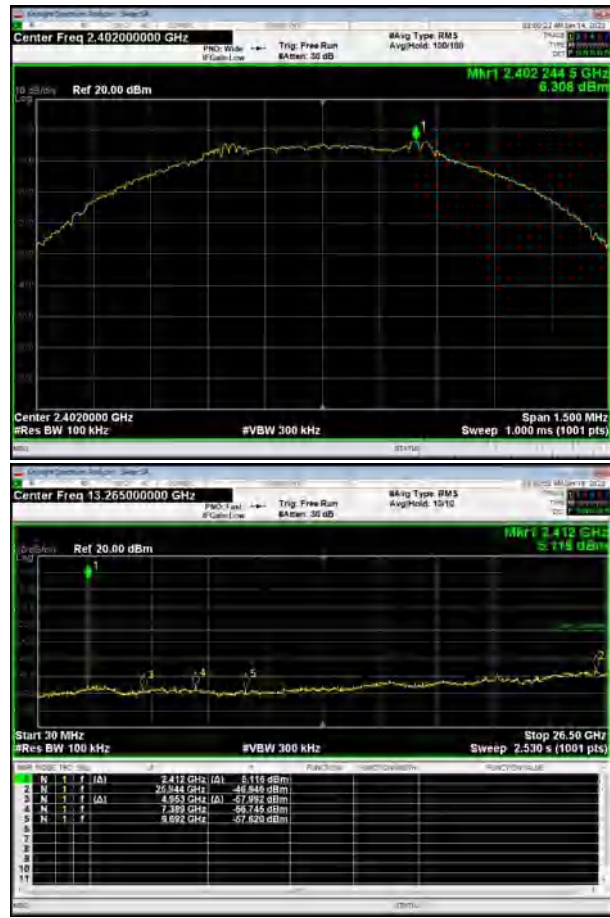

Bluetooth LE, Channel No.: 19

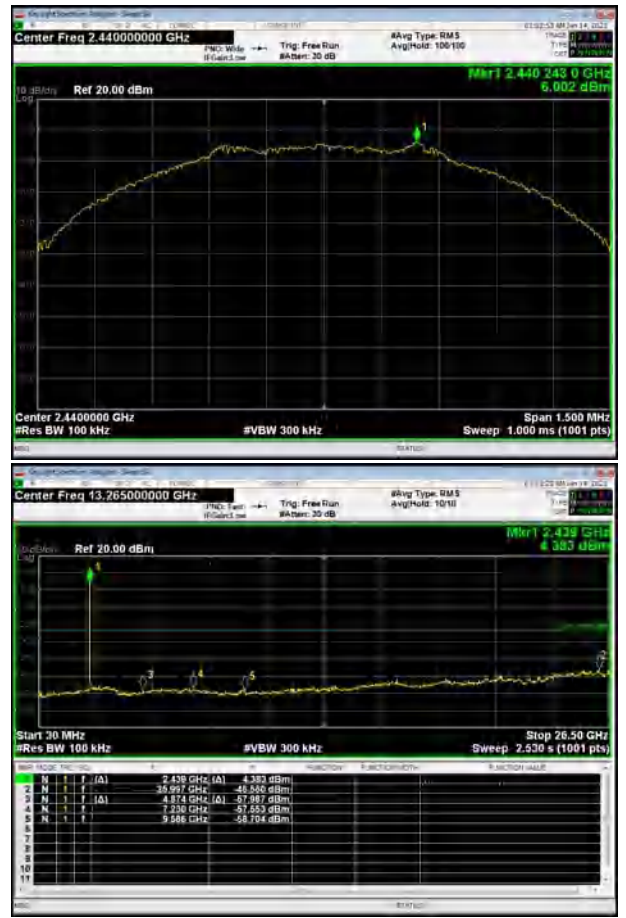



5.6. Unwanted Emission

Ambient condition

| Temperature | Relative humidity | Pressure |
|-------------|-------------------|----------|
| 23°C ~25°C | 45%~50% | 102.5kPa |

Method of Measurement

The test set-up was made in accordance to the general provisions of ANSI C63.10.

The Equipment Under Test (EUT) was set up on a non-conductive table in the semi-anechoic chamber. The test was performed at the distance of 3 m between the EUT and the receiving antenna.

The turntable shall be rotated from 0 to 360 degrees for detecting the maximum of radiated spurious signal level. The measurements shall be repeated with orthogonal polarization of the test antenna. The data of cable loss and antenna factor has been calibrated in full testing frequency range before the testing. Sweep the Restricted Band and the emissions less than 20 dB below the permissible value are reported.

The radiated emissions measurements were made in a typical installation configuration.

Sweep the whole frequency band through the range from 9 kHz to the 10th harmonic of the carrier, and the emissions less than 20 dB below the permissible value are reported.

This method refer to ANSI C63.10.

The procedure for peak unwanted emissions measurements above 1000 MHz is as follows:

Set the spectrum analyzer in the following:

9kHz~150 kHz

RBW=200Hz, VBW=1kHz/ Sweep=AUTO

150 kHz~30MHz

RBW=9KHz, VBW=30KHz,/ Sweep=AUTO

Below 1GHz

RBW=100kHz / VBW=300kHz / Sweep=AUTO

a) Peak emission levels are measured by setting the instrument as follows:

Above 1GHz

PEAK: RBW=1MHz VBW=3MHz/ Sweep=AUTO

b) Average emission levels are measured by setting the instrument as follows:

Above 1GHz

AVERAGE: RBW=1MHz / VBW=3MHz / Sweep=AUTO

c) Detector: The measurements employing a CISPR quasi-peak detector except for the frequency bands 9-90 kHz, 110-490 kHz and above 1000 MHz. Radiated emission limits in these three bands are based on measurements employing an average detector.

d) Averaging type = power (i.e., rms) (As an alternative, the detector and averaging type may be set for linear voltage averaging. Some instruments require linear display mode to use linear voltage



averaging. Log or dB averaging shall not be used.)

e) Sweep time = auto.

f) Perform a trace average of at least 100 traces if the transmission is continuous. If the transmission is not continuous, then the number of traces shall be increased by a factor of $1 / D$, where D is the duty cycle. For example, with 50% duty cycle, at least 200 traces shall be averaged. (If a specific emission is demonstrated to be continuous—i.e., 100% duty cycle—then rather than turning ON and OFF with the transmit cycle, at least 100 traces shall be averaged.)

g) If tests are performed with the EUT transmitting at a duty cycle less than 98%, then a correction factor shall be added to the measurement results prior to comparing with the emission limit, to compute the emission level that would have been measured had the test been performed at 100% duty cycle. The correction factor is computed as follows:

1) If power averaging (rms) mode was used in the preceding step e), then the correction factor is $[10 \log (1 / D)]$, where D is the duty cycle. For example, if the transmit duty cycle was 50%, then 3 dB shall be added to the measured emission levels.

2) If linear voltage averaging mode was used in the preceding step e), then the correction factor is $[20 \log (1 / D)]$, where D is the duty cycle. For example, if the transmit duty cycle was 50%, then 6 dB shall be added to the measured emission levels.

3) If a specific emission is demonstrated to be continuous (100% duty cycle) rather than turning ON and OFF with the transmit cycle, then no duty cycle correction is required for that emission.

The test is in transmitting mode.

Test setup

9KHz ~ 30MHz

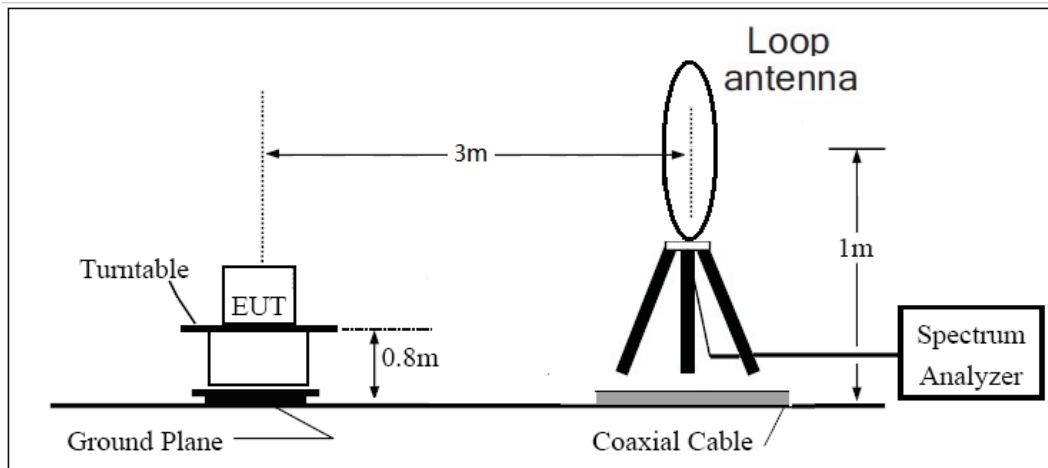

30MHz ~ 1GHz

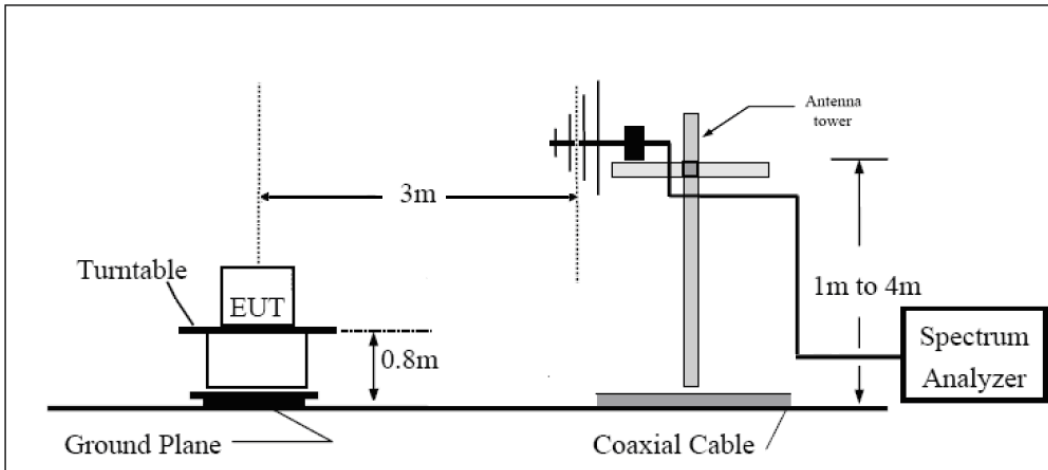

Above 1GHz

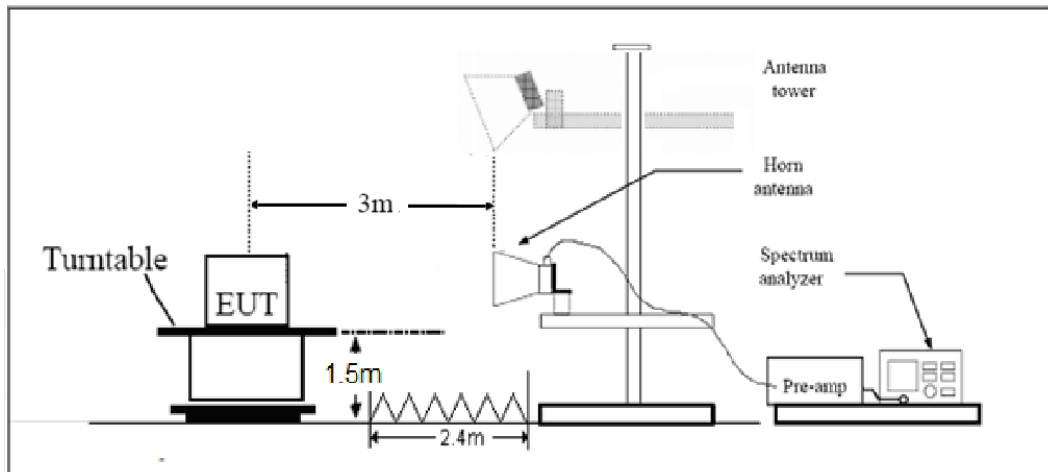

Note: Area side:2.4mX3.6m

**Limits**

Rule Part 15.247(d) specifies that “In addition, radiated emissions which fall in the restricted bands, as defined in § 15.205(a), must also comply with the radiated emission limits specified in § 15.209(a) (see § 15.205(c)).”

Limit in restricted band

| Frequency of emission (MHz) | Field strength(uV/m) | Field strength(dBuV/m) |
|-----------------------------|----------------------|------------------------|
| 0.009–0.490 | 2400/F(kHz) | / |
| 0.490–1.705 | 24000/F(kHz) | / |
| 1.705–30.0 | 30 | / |
| 30-88 | 100 | 40 |
| 88-216 | 150 | 43.5 |
| 216-960 | 200 | 46 |
| Above960 | 500 | 54 |

§15.35(b)

There is also a limit on the radio frequency emissions, as measured using instrumentation with a peak detector function, corresponding to 20 dB above the maximum permitted average limit.

Peak Limit=74 dBuV/m

Average Limit=54 dBuV/m



Spurious Radiated Emissions are permitted in any of the frequency bands listed below:

| MHz | MHz | MHz | GHz |
|--------------------------|---------------------|---------------|------------------|
| 0.090-0.110 | 16.42-16.423 | 399.9-410 | 4.5-5.15 |
| ¹ 0.495-0.505 | 16.69475-16.69525 | 608-614 | 5.35-5.46 |
| 2.1735-2.1905 | 16.80425-16.80475 | 960-1240 | 7.25-7.75 |
| 4.125-4.128 | 25.5-25.67 | 1300-1427 | 8.025-8.5 |
| 4.17725-4.17775 | 37.5-38.25 | 1435-1626.5 | 9.0-9.2 |
| 4.20725-4.20775 | 73-74.6 | 1645.5-1646.5 | 9.3-9.5 |
| 6.215-6.218 | 74.8-75.2 | 1660-1710 | 10.6-12.7 |
| 6.26775-6.26825 | 108-121.94 | 1718.8-1722.2 | 13.25-13.4 |
| 6.31175-6.31225 | 123-138 | 2200-2300 | 14.47-14.5 |
| 8.291-8.294 | 149.9-150.05 | 2310-2390 | 15.35-16.2 |
| 8.362-8.366 | 156.52475-156.52525 | 2483.5-2500 | 17.7-21.4 |
| 8.37625-8.38675 | 156.7-156.9 | 2690-2900 | 22.01-23.12 |
| 8.41425-8.41475 | 162.0125-167.17 | 3260-3267 | 23.6-24.0 |
| 12.29-12.293 | 167.72-173.2 | 3332-3339 | 31.2-31.8 |
| 12.51975-12.52025 | 240-285 | 3345.8-3358 | 36.43-36.5 |
| 12.57675-12.57725 | 322-335.4 | 3600-4400 | (²) |
| 13.36-13.41 | | | |

Measurement Uncertainty

The assessed measurement uncertainty to ensure 95% confidence level for the normal distribution is with the coverage factor $k = 1.96$.

| Frequency | Uncertainty |
|---------------|-------------|
| 9KHz-30MHz | 3.55 dB |
| 30MHz-200MHz | 4.17 dB |
| 200MHz-1GHz | 4.84 dB |
| 1-18GHz | 4.35 dB |
| 18-26.5GHz | 5.90 dB |
| 26.5GHz~40GHz | 5.92 dB |



Test Results:

A font (dB μ V/m) in the test plot = (dB μ V/m)

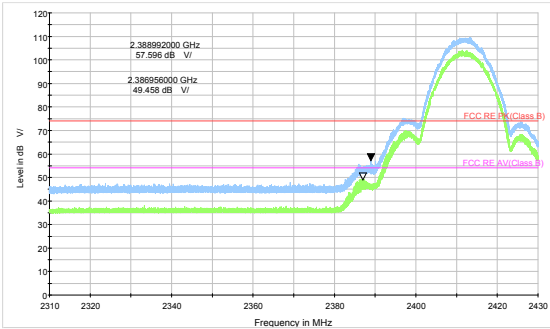

802.11b-Channel 1 Peak+ Average

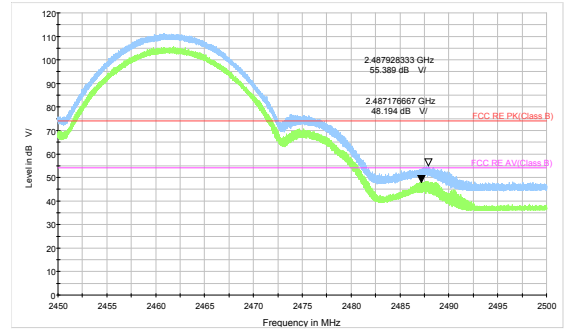

802.11b-Channel 11 Peak+ Average

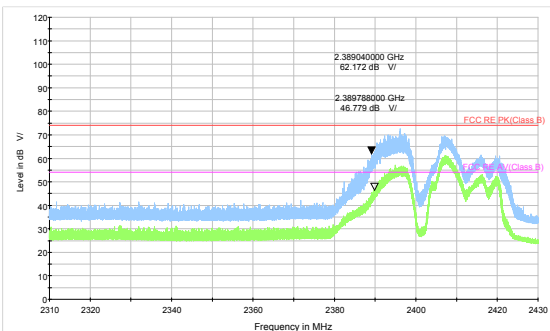

802.11g-Channel 1 Peak+ Average

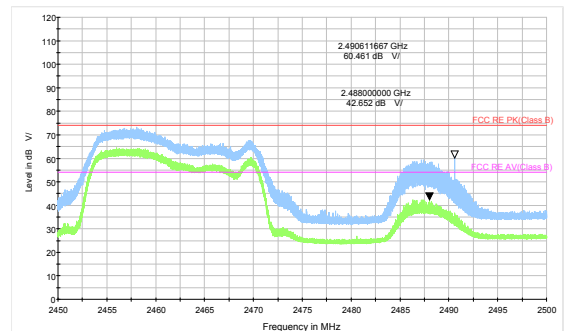

802.11g-Channel 11 Peak+ Average

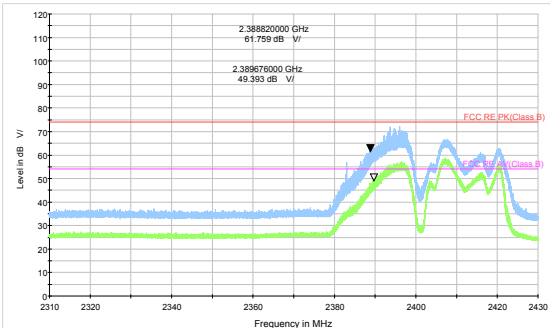

802.11n HT20 -Channel 1 Peak+ Average

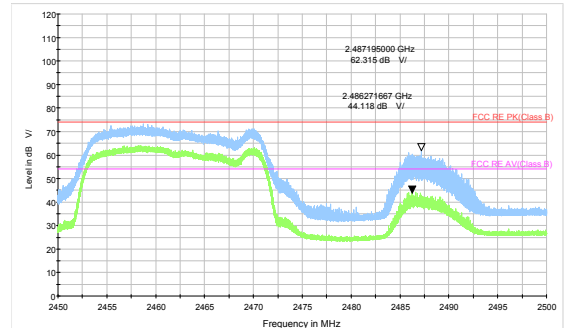

802.11n HT20 -Channel 11 Peak+ Average

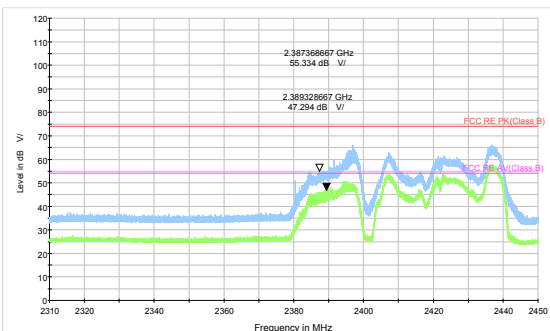

802.11n HT40 -Channel 3 Peak+ Average

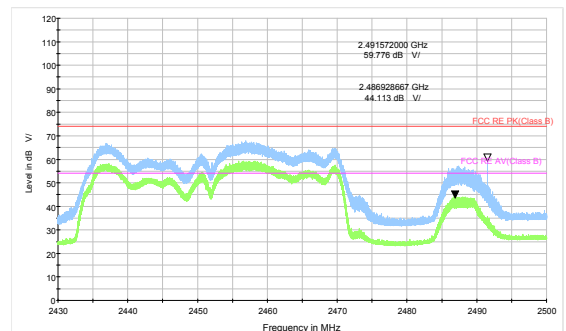

802.11n HT40 -Channel 9 Peak+ Average

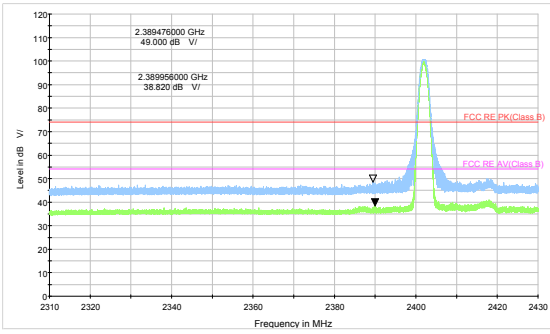

Bluetooth LE Channel 0 Peak+ Average

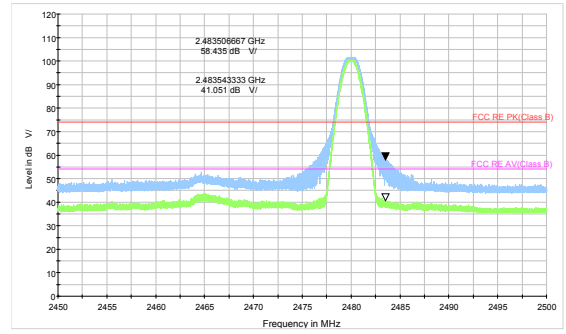

Bluetooth LE Channel 39 Peak+Average

Result of RE

Test result

Sweep the whole frequency band through the range from 9kHz to the 10th harmonic of the carrier, the Emissions in the frequency band 9kHz-30MHz and 18GHz-26.5GHz are more than 20dB below the limit are not reported.

The following graphs display the maximum values of horizontal and vertical by software. For above 1GHz, Blue trace uses the peak detection, Green trace uses the average detection.

During the test, the Radiates Emission from 30MHz to 1GHz was performed in all modes with all channels, 802.11g CH6 and Bluetooth LE-Channel 0 are selected as the worst condition. The test data of the worst-case condition was recorded in this report.

A font ($\text{Level in dB}\mu\text{V/}$)in the test plot =(level in dB $\mu\text{V/m}$)

A font (dB V/)in the test plot =(dB $\mu\text{V/m}$)

Continuous TX mode:

FCC RE 9K-90KHz AV

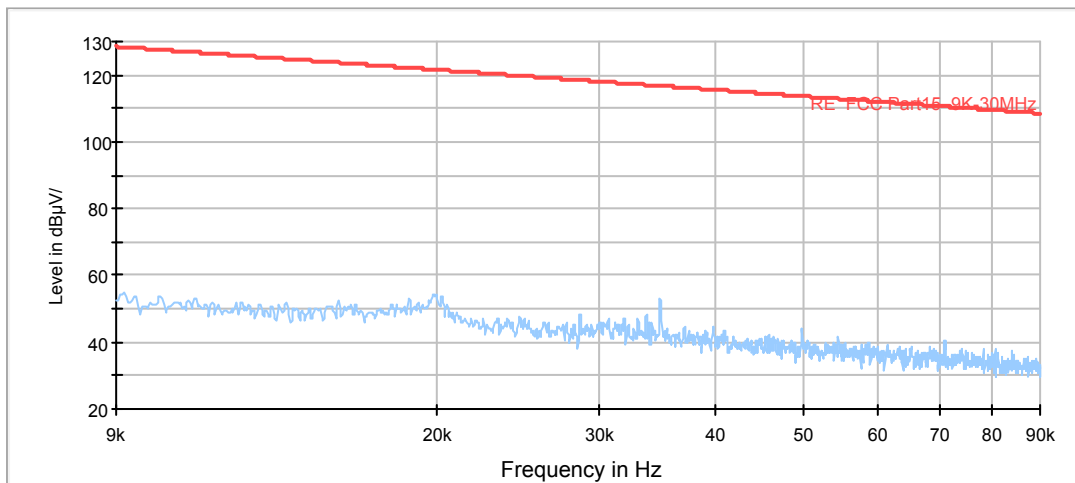

Radiates Emission from 9KHz to 90KHz



FCC RE 90K-110KHz QP

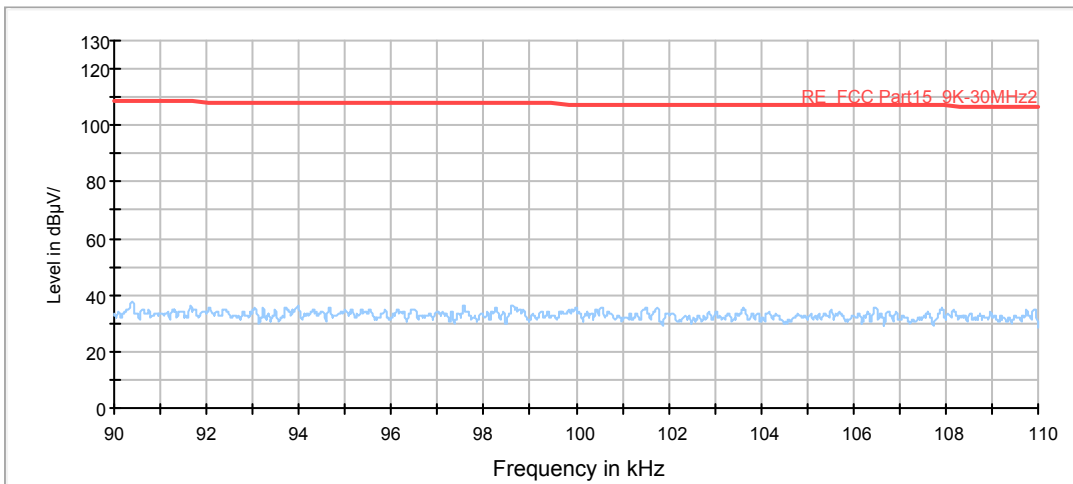

Radiates Emission from 90KHz to 110KHz

FCC RE 110K-490KHz AV

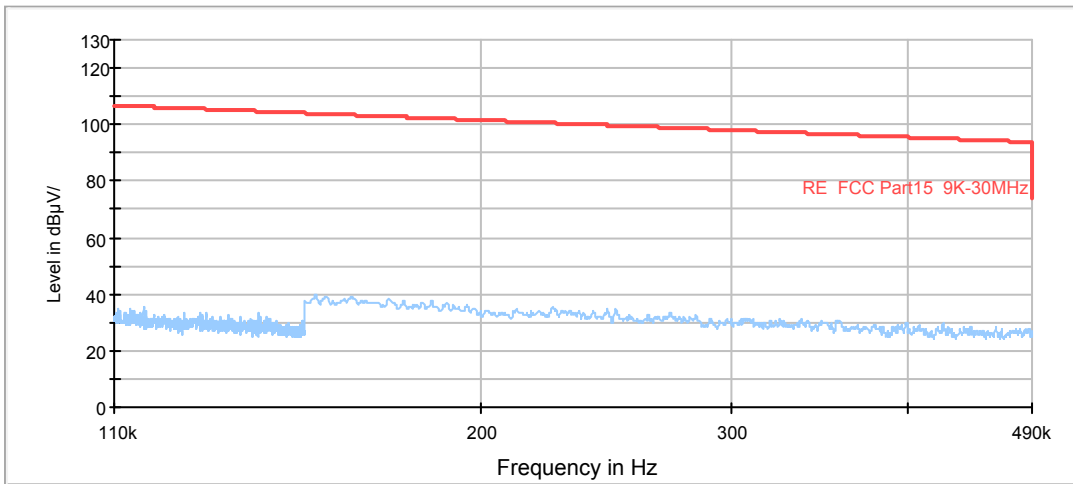

Radiates Emission from 110KHz to 490KHz

FCC RE 490K-30MHz QP

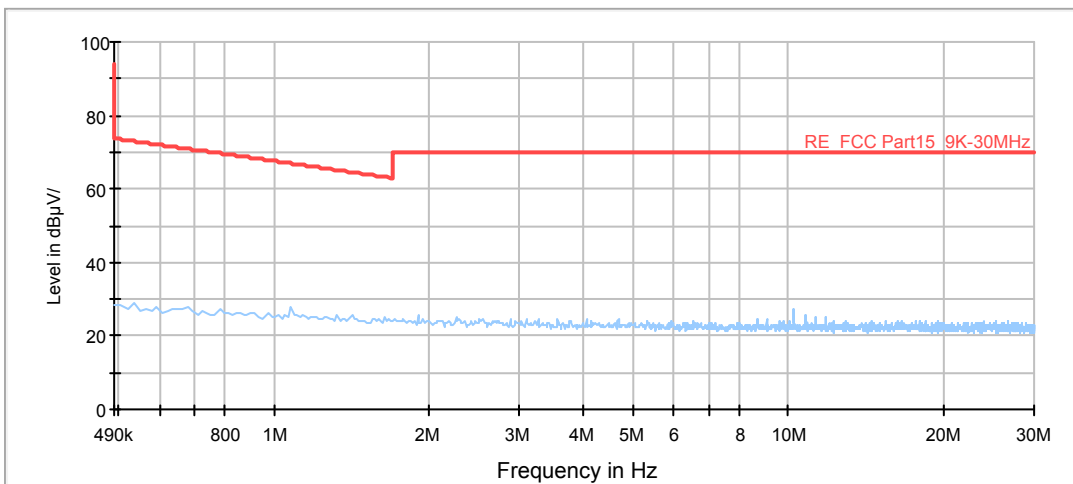

Radiates Emission from 490KHz to 30MHz

Wi-Fi 2.4G:

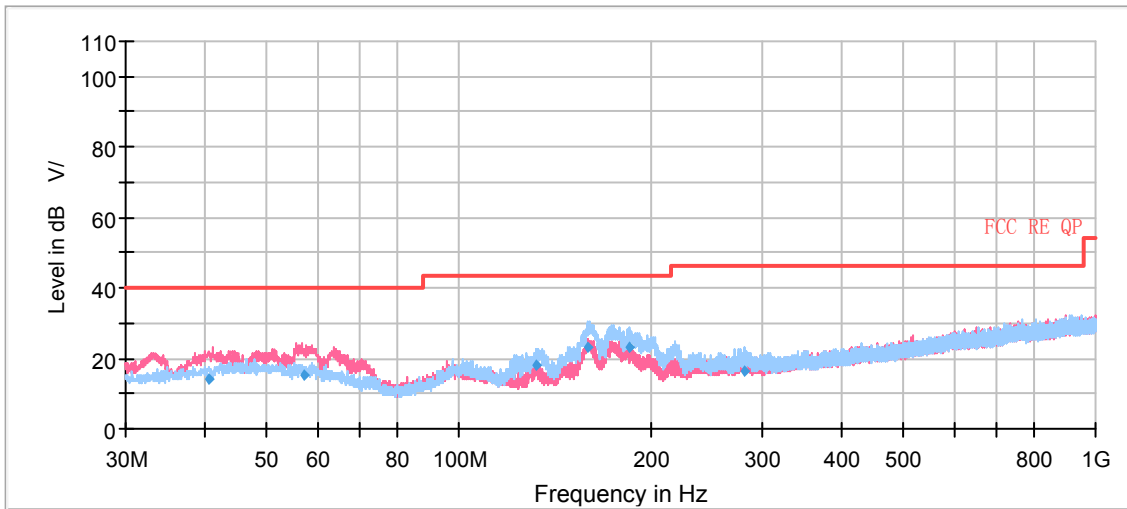

Radiates Emission from 30MHz to 1GHz

| Frequency (MHz) | Quasi-Peak (dBuV/m) | Height (cm) | Polarization | Azimuth (deg) | Correct Factor (dB) | Margin (dB) | Limit (dBuV/m) |
|-----------------|---------------------|-------------|--------------|---------------|---------------------|-------------|----------------|
| 40.635000 | 14.33 | 100.0 | V | 13.0 | 20 | 25.67 | 40.00 |
| 57.082667 | 15.49 | 110.0 | V | 0.0 | 20 | 24.51 | 40.00 |
| 132.801333 | 18.06 | 225.0 | H | 85.0 | 15 | 25.44 | 43.50 |
| 159.879667 | 23.26 | 175.0 | H | 237.0 | 15 | 20.24 | 43.50 |
| 185.311333 | 23.08 | 175.0 | H | 83.0 | 17 | 20.42 | 43.50 |
| 281.631667 | 16.19 | 110.0 | H | 64.0 | 20 | 29.81 | 46.00 |

Remark: 1. Correction Factor = Antenna factor+ Insertion loss(cable loss+amplifier gain)

2. Margin = Limit – Quasi-Peak

Bluetooth LE:

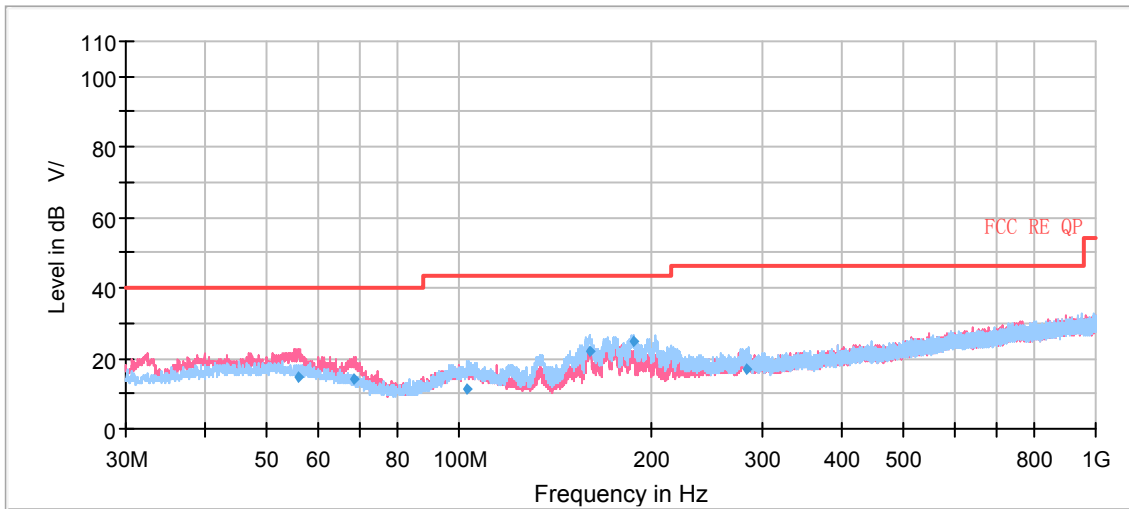

Radiates Emission from 30MHz to 1GHz

| Frequency (MHz) | Quasi-Peak (dBuV/m) | Height (cm) | Polarization | Azimuth (deg) | Correct Factor (dB) | Margin (dB) | Limit (dBuV/m) |
|-----------------|---------------------|-------------|--------------|---------------|---------------------|-------------|----------------|
| 55.874333 | 14.75 | 100.0 | V | 88.0 | 20 | 25.25 | 40.00 |
| 68.531000 | 13.94 | 100.0 | V | 21.0 | 17 | 26.06 | 40.00 |
| 103.287000 | 11.54 | 210.0 | H | 244.0 | 19 | 31.96 | 43.50 |
| 160.832667 | 22.27 | 184.0 | H | 76.0 | 15 | 21.23 | 43.50 |
| 187.704000 | 24.86 | 175.0 | H | 76.0 | 17 | 18.64 | 43.50 |
| 283.764667 | 17.12 | 100.0 | H | 60.0 | 20 | 28.88 | 46.00 |

- Remark: 1. Correction Factor = Antenna factor+ Insertion loss(cable loss+amplifier gain)**
2. Margin = Limit – Quasi-Peak

802.11b CH1

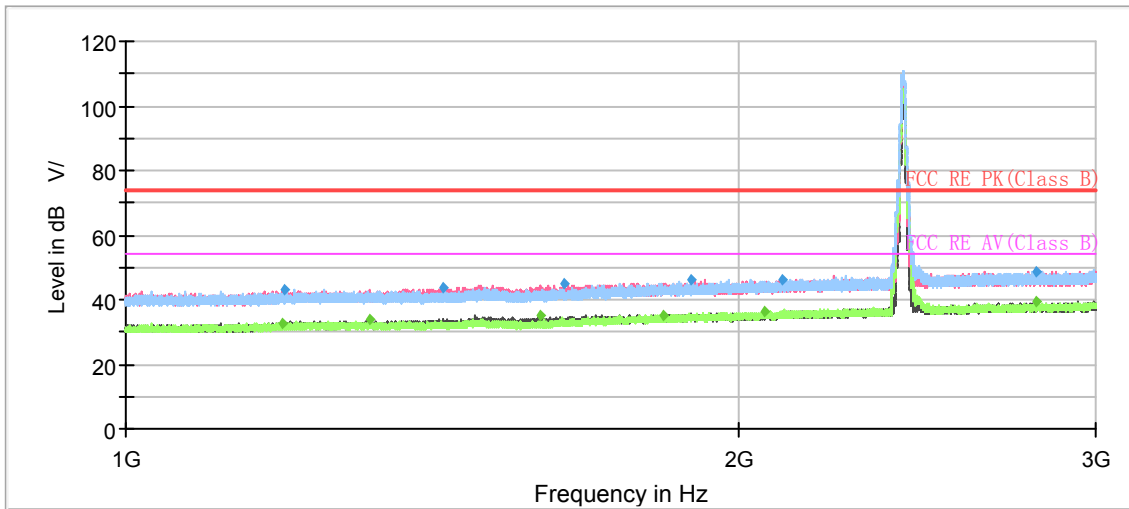

Note: The signal beyond the limit is carrier.

Radiates Emission from 1GHz to 3GHz

| Frequency (MHz) | MaxPeak (dB μ V/m) | Average (dB μ V/m) | Limit (dB μ V/m) | Margin (dB) | Height (cm) | Pol | Azimuth (deg) | Corr. (dB/m) |
|-----------------|------------------------|------------------------|----------------------|-------------|-------------|-----|---------------|--------------|
| 1193.133333 | --- | 32.86 | 54.00 | 21.14 | 200.0 | H | 0.0 | -8 |
| 1196.066667 | 43.15 | --- | 74.00 | 30.85 | 100.0 | V | 185.0 | -8 |
| 1317.733333 | --- | 33.75 | 54.00 | 20.25 | 200.0 | H | 104.0 | -7 |
| 1432.333333 | 43.57 | --- | 74.00 | 30.43 | 100.0 | V | 266.0 | -6 |
| 1600.066667 | --- | 35.08 | 54.00 | 18.92 | 100.0 | V | 185.0 | -5 |
| 1641.666667 | 44.77 | --- | 74.00 | 29.23 | 100.0 | V | 2.0 | -5 |
| 1839.133333 | --- | 35.33 | 54.00 | 18.67 | 100.0 | V | 38.0 | -4 |
| 1897.533333 | 46.11 | --- | 74.00 | 27.89 | 100.0 | V | 68.0 | -4 |
| 2060.600000 | --- | 36.30 | 54.00 | 17.70 | 100.0 | H | 119.0 | -3 |
| 2105.333333 | 45.95 | --- | 74.00 | 28.05 | 200.0 | V | 268.0 | -2 |
| 2802.333333 | --- | 39.60 | 54.00 | 14.40 | 200.0 | H | 82.0 | 1 |
| 2803.333333 | 48.82 | --- | 74.00 | 25.18 | 200.0 | H | 0.0 | 1 |

Remark: 1. Correction Factor = Antenna factor+ Insertion loss (cable loss + amplifier gain)

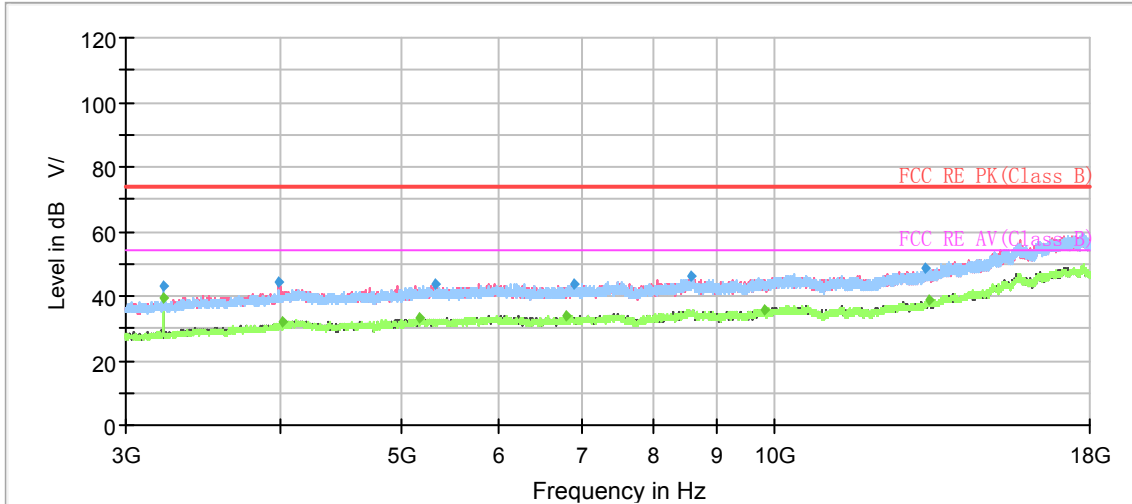

Radiates Emission from 3GHz to 18GHz

| Frequency (MHz) | MaxPeak (dB μ V/m) | Average (dB μ V/m) | Limit (dB μ V/m) | Margin (dB) | Height (cm) | Pol | Azimuth (deg) | Corr. (dB/m) |
|-----------------|------------------------|------------------------|----------------------|-------------|-------------|-----|---------------|--------------|
| 3216.000000 | --- | 39.51 | 54.00 | 14.49 | 100.0 | H | 309.0 | -8 |
| 3216.000000 | 42.95 | --- | 74.00 | 31.05 | 200.0 | H | 307.0 | -8 |
| 3985.000000 | 44.01 | --- | 74.00 | 29.99 | 200.0 | V | 251.0 | -4 |
| 4020.500000 | --- | 32.11 | 54.00 | 21.89 | 200.0 | V | 344.0 | -4 |
| 5179.500000 | --- | 33.21 | 54.00 | 20.79 | 200.0 | H | 323.0 | -1 |
| 5327.000000 | 43.42 | --- | 74.00 | 30.58 | 200.0 | H | 220.0 | -1 |
| 6801.000000 | --- | 34.00 | 54.00 | 20.00 | 200.0 | H | 189.0 | 0 |
| 6913.500000 | 43.94 | --- | 74.00 | 30.06 | 200.0 | H | 58.0 | 1 |
| 8583.000000 | 46.12 | --- | 74.00 | 27.88 | 100.0 | V | 208.0 | 4 |
| 9848.000000 | --- | 35.95 | 54.00 | 18.05 | 200.0 | V | 171.0 | 4 |
| 13254.000000 | 48.73 | --- | 74.00 | 25.27 | 200.0 | V | 227.0 | 9 |
| 13348.500000 | --- | 38.91 | 54.00 | 15.09 | 200.0 | H | 58.0 | 9 |

Remark: 1. Correction Factor = Antenna factor+ Insertion loss (cable loss + amplifier gain)



802.11b CH6

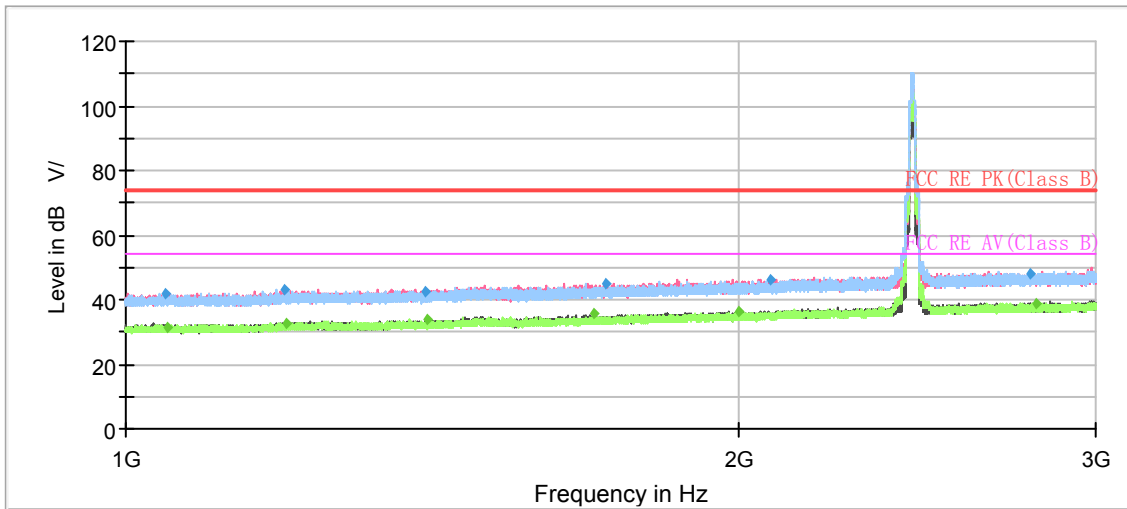

Note: The signal beyond the limit is carrier.

Radiates Emission from 1GHz to 3GHz

| Frequency (MHz) | MaxPeak (dB μ V/m) | Average (dB μ V/m) | Limit (dB μ V/m) | Margin (dB) | Height (cm) | Pol | Azimuth (deg) | Corr. (dB/m) |
|-----------------|------------------------|------------------------|----------------------|-------------|-------------|-----|---------------|--------------|
| 1046.666667 | 41.72 | --- | 74.00 | 32.28 | 200.0 | V | 270.0 | -9 |
| 1048.200000 | --- | 31.66 | 54.00 | 22.34 | 200.0 | V | 233.0 | -9 |
| 1196.533333 | 42.99 | --- | 74.00 | 31.01 | 200.0 | V | 175.0 | -8 |
| 1200.533333 | --- | 32.85 | 54.00 | 21.15 | 200.0 | H | 0.0 | -8 |
| 1403.066667 | 42.65 | --- | 74.00 | 31.35 | 100.0 | V | 317.0 | -6 |
| 1405.866667 | --- | 33.71 | 54.00 | 20.29 | 100.0 | V | 264.0 | -6 |
| 1700.333333 | --- | 35.39 | 54.00 | 18.61 | 100.0 | V | 349.0 | -5 |
| 1723.600000 | 45.12 | --- | 74.00 | 28.88 | 100.0 | V | 287.0 | -4 |
| 2002.866667 | --- | 36.24 | 54.00 | 17.76 | 100.0 | V | 272.0 | -3 |
| 2075.400000 | 46.29 | --- | 74.00 | 27.71 | 200.0 | H | 10.0 | -3 |
| 2787.600000 | 48.25 | --- | 74.00 | 25.75 | 100.0 | V | 272.0 | 1 |
| 2805.333333 | --- | 38.61 | 54.00 | 15.39 | 100.0 | V | 287.0 | 1 |

Remark: 1. Correction Factor = Antenna factor+ Insertion loss (cable loss + amplifier gain)

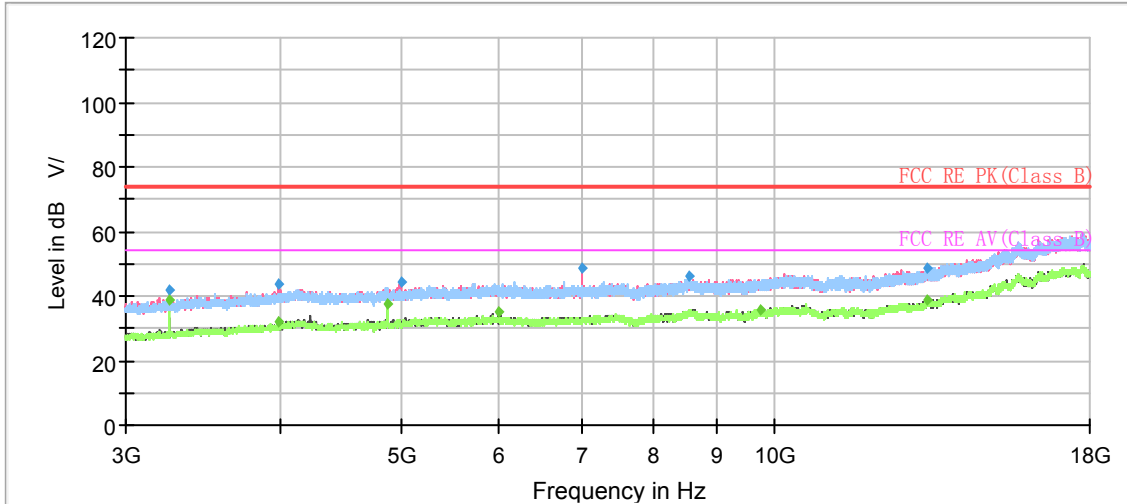

Radiates Emission from 3GHz to 18GHz

| Frequency (MHz) | MaxPeak (dB μ V/m) | Average (dB μ V/m) | Limit (dB μ V/m) | Margin (dB) | Height (cm) | Pol | Azimuth (deg) | Corr. (dB/m) |
|-----------------|------------------------|------------------------|----------------------|-------------|-------------|-----|---------------|--------------|
| 3249.000000 | --- | 38.79 | 54.00 | 15.21 | 100.0 | H | 261.0 | -7 |
| 3249.500000 | 41.97 | --- | 74.00 | 32.03 | 100.0 | H | 269.0 | -7 |
| 3991.500000 | 43.85 | --- | 74.00 | 30.15 | 200.0 | V | 235.0 | -4 |
| 3992.000000 | --- | 32.20 | 54.00 | 21.80 | 200.0 | V | 138.0 | -4 |
| 4874.000000 | --- | 37.52 | 54.00 | 16.48 | 100.0 | H | 301.0 | -2 |
| 4999.000000 | 44.05 | --- | 74.00 | 29.95 | 200.0 | V | 105.0 | -1 |
| 5999.500000 | --- | 34.85 | 54.00 | 19.15 | 100.0 | V | 89.0 | 0 |
| 6994.000000 | 48.67 | --- | 74.00 | 25.33 | 100.0 | V | 339.0 | 1 |
| 8546.500000 | 45.94 | --- | 74.00 | 28.06 | 100.0 | V | 300.0 | 4 |
| 9751.000000 | --- | 35.76 | 54.00 | 18.24 | 200.0 | V | 123.0 | 4 |
| 13299.000000 | --- | 38.81 | 54.00 | 15.19 | 200.0 | H | 250.0 | 9 |
| 13327.500000 | 48.75 | --- | 74.00 | 25.25 | 200.0 | H | 250.0 | 9 |

Remark: 1. Correction Factor = Antenna factor+ Insertion loss (cable loss + amplifier gain)

802.11b CH11

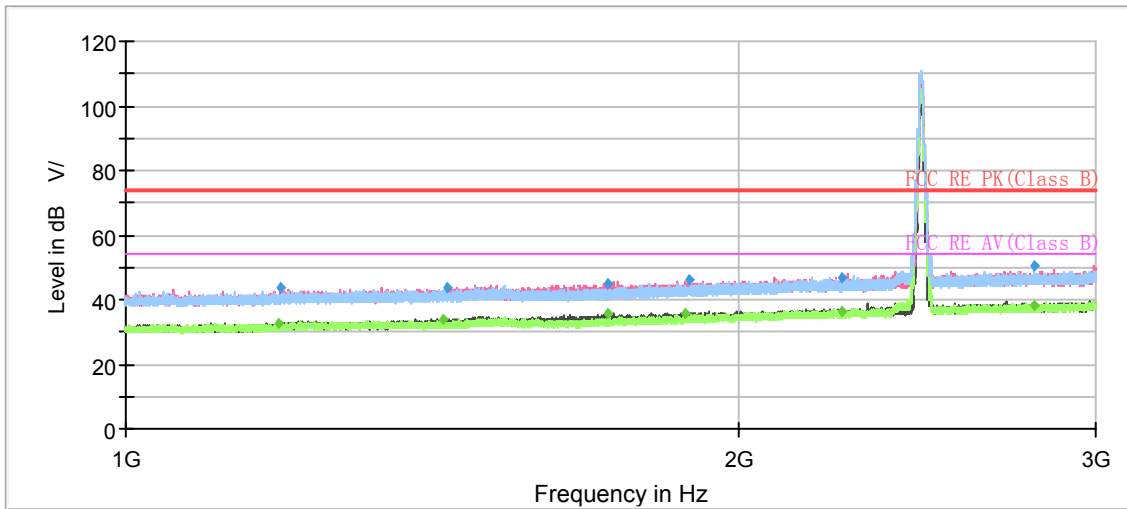

Note: The signal beyond the limit is carrier.

Radiates Emission from 1GHz to 3GHz

| Frequency (MHz) | MaxPeak (dB μ V/m) | Average (dB μ V/m) | Limit (dB μ V/m) | Margin (dB) | Height (cm) | Pol | Azimuth (deg) | Corr. (dB/m) |
|-----------------|------------------------|------------------------|----------------------|-------------|-------------|-----|---------------|--------------|
| 1190.066667 | --- | 32.87 | 54.00 | 21.13 | 100.0 | V | 358.0 | -8 |
| 1192.533333 | 43.68 | --- | 74.00 | 30.32 | 100.0 | V | 321.0 | -8 |
| 1434.000000 | --- | 33.72 | 54.00 | 20.28 | 100.0 | V | 0.0 | -6 |
| 1438.733333 | 43.43 | --- | 74.00 | 30.57 | 200.0 | V | 149.0 | -6 |
| 1724.533333 | 45.04 | --- | 74.00 | 28.96 | 100.0 | V | 200.0 | -4 |
| 1725.000000 | --- | 35.41 | 54.00 | 18.59 | 100.0 | V | 306.0 | -4 |
| 1884.133333 | --- | 35.41 | 54.00 | 18.59 | 100.0 | V | 321.0 | -4 |
| 1894.266667 | 46.20 | --- | 74.00 | 27.80 | 100.0 | V | 299.0 | -4 |
| 2249.933333 | --- | 36.38 | 54.00 | 17.62 | 100.0 | H | 68.0 | -2 |
| 2252.666667 | 47.03 | --- | 74.00 | 26.97 | 100.0 | V | 239.0 | -2 |
| 2797.533333 | 50.54 | --- | 74.00 | 23.46 | 200.0 | H | 5.0 | 1 |
| 2800.466667 | --- | 38.30 | 54.00 | 15.70 | 100.0 | V | 269.0 | 1 |

Remark: 1. Correction Factor = Antenna factor+ Insertion loss (cable loss + amplifier gain)

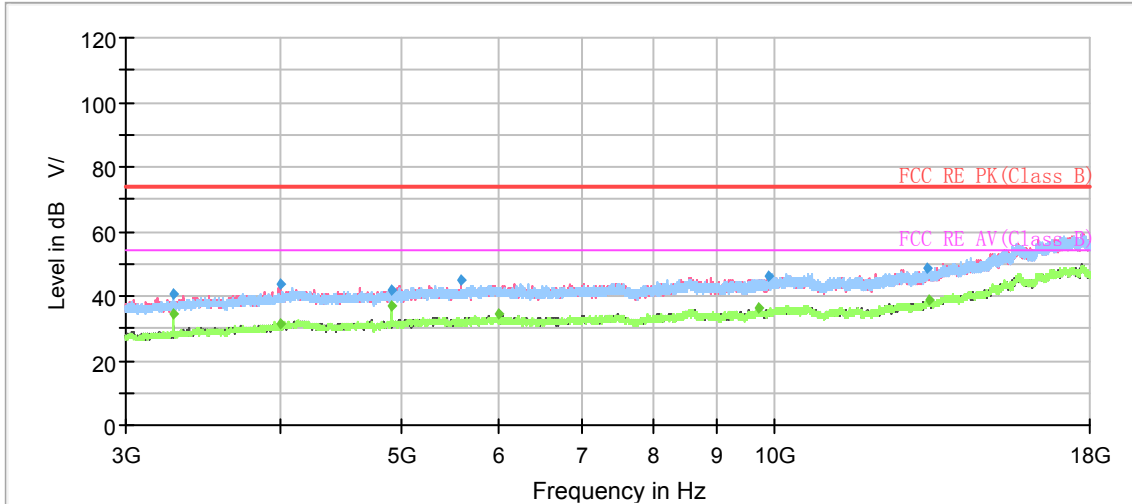

Radiates Emission from 3GHz to 18GHz

| Frequency (MHz) | MaxPeak (dB μ V/m) | Average (dB μ V/m) | Limit (dB μ V/m) | Margin (dB) | Height (cm) | Pol | Azimuth (deg) | Corr. (dB/m) |
|-----------------|------------------------|------------------------|----------------------|-------------|-------------|-----|---------------|--------------|
| 3282.000000 | 40.43 | --- | 74.00 | 33.57 | 200.0 | H | 316.0 | -7 |
| 3282.500000 | --- | 34.72 | 54.00 | 19.28 | 200.0 | H | 300.0 | -7 |
| 3995.500000 | 43.45 | --- | 74.00 | 30.55 | 200.0 | V | 133.0 | -4 |
| 4003.500000 | --- | 31.37 | 54.00 | 22.63 | 100.0 | H | 14.0 | -4 |
| 4921.500000 | 41.88 | --- | 74.00 | 32.12 | 100.0 | H | 212.0 | -2 |
| 4924.000000 | --- | 36.71 | 54.00 | 17.29 | 200.0 | H | 300.0 | -2 |
| 5593.500000 | 45.19 | --- | 74.00 | 28.81 | 100.0 | V | 298.0 | 0 |
| 6002.500000 | --- | 34.50 | 54.00 | 19.50 | 200.0 | V | 157.0 | 0 |
| 9715.000000 | --- | 36.03 | 54.00 | 17.97 | 200.0 | H | 308.0 | 4 |
| 9888.000000 | 45.97 | --- | 74.00 | 28.03 | 100.0 | V | 283.0 | 4 |
| 13318.000000 | 48.76 | --- | 74.00 | 25.24 | 200.0 | V | 0.0 | 9 |
| 13333.500000 | --- | 38.66 | 54.00 | 15.34 | 100.0 | V | 322.0 | 9 |

Remark: 1. Correction Factor = Antenna factor+ Insertion loss (cable loss + amplifier gain)



802.11g CH1

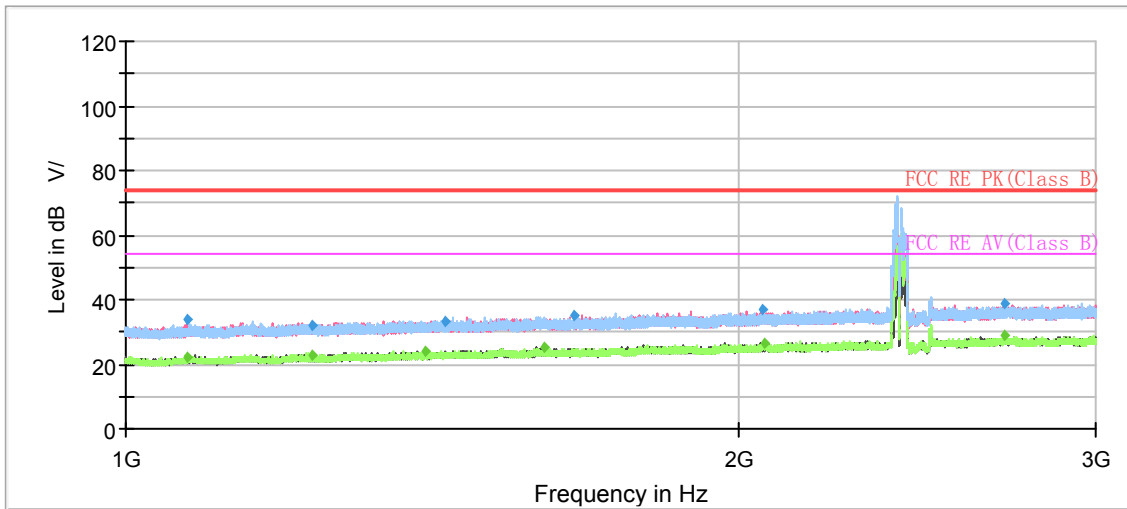

Note: The signal beyond the limit is carrier.

Radiates Emission from 1GHz to 3GHz

| Frequency (MHz) | MaxPeak (dB μ V/m) | Average (dB μ V/m) | Limit (dB μ V/m) | Margin (dB) | Height (cm) | Pol | Azimuth (deg) | Corr. (dB/m) |
|-----------------|------------------------|------------------------|----------------------|-------------|-------------|-----|---------------|--------------|
| 1071.600000 | 33.75 | --- | 74.00 | 40.25 | 100.0 | V | 96.0 | -18 |
| 1071.733333 | --- | 21.92 | 54.00 | 32.08 | 200.0 | H | 154.0 | -18 |
| 1234.666667 | --- | 22.48 | 54.00 | 31.52 | 100.0 | V | 9.0 | -17 |
| 1234.800000 | 32.23 | --- | 74.00 | 41.77 | 200.0 | H | 216.0 | -17 |
| 1402.800000 | --- | 23.90 | 54.00 | 30.10 | 100.0 | V | 184.0 | -16 |
| 1435.133333 | 33.47 | --- | 74.00 | 40.53 | 200.0 | V | 188.0 | -16 |
| 1606.333333 | --- | 25.37 | 54.00 | 28.63 | 200.0 | H | 253.0 | -15 |
| 1662.066667 | 35.23 | --- | 74.00 | 38.77 | 100.0 | V | 24.0 | -15 |
| 2056.666667 | 36.72 | --- | 74.00 | 37.28 | 200.0 | H | 95.0 | -13 |
| 2059.666667 | --- | 26.22 | 54.00 | 27.78 | 200.0 | H | 117.0 | -13 |
| 2706.466667 | --- | 29.06 | 54.00 | 24.94 | 200.0 | V | 260.0 | -9 |
| 2707.800000 | 39.01 | --- | 74.00 | 34.99 | 100.0 | H | 256.0 | -9 |

Remark: 1. Correction Factor = Antenna factor+ Insertion loss (cable loss + amplifier gain)

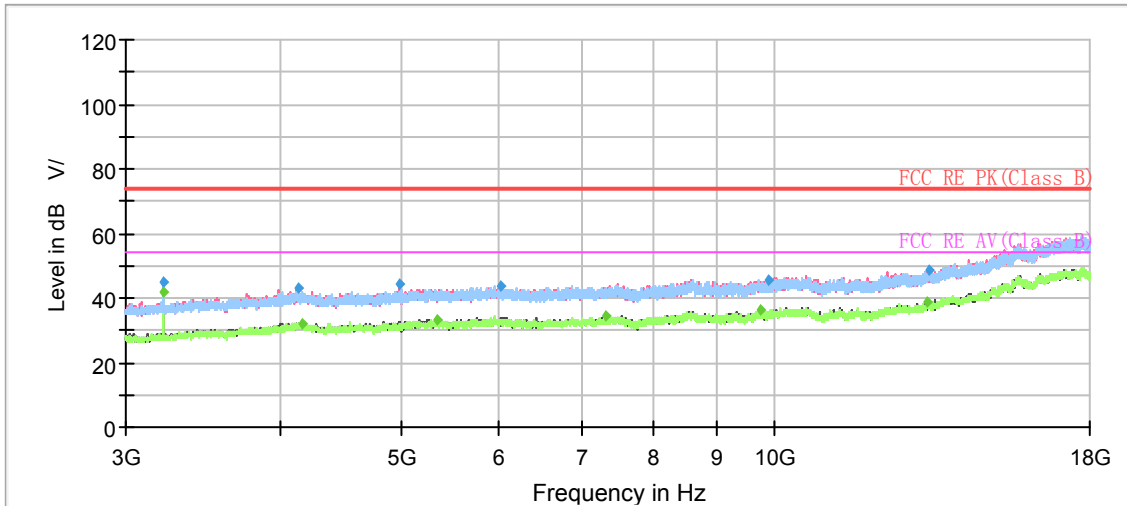

Radiates Emission from 3GHz to 18GHz

| Frequency (MHz) | MaxPeak (dB μ V/m) | Average (dB μ V/m) | Limit (dB μ V/m) | Margin (dB) | Height (cm) | Pol | Azimuth (deg) | Corr. (dB/m) |
|-----------------|------------------------|------------------------|----------------------|-------------|-------------|-----|---------------|--------------|
| 3216.000000 | --- | 41.90 | 54.00 | 12.10 | 100.0 | H | 311.0 | -8 |
| 3216.000000 | 44.80 | --- | 74.00 | 29.20 | 100.0 | H | 311.0 | -8 |
| 4138.000000 | 43.30 | --- | 74.00 | 30.70 | 100.0 | H | 0.0 | -3 |
| 4161.500000 | --- | 32.03 | 54.00 | 21.97 | 100.0 | V | 289.0 | -3 |
| 4983.500000 | 44.50 | --- | 74.00 | 29.50 | 200.0 | V | 34.0 | -1 |
| 5360.500000 | --- | 33.16 | 54.00 | 20.84 | 200.0 | H | 224.0 | -1 |
| 6024.500000 | 43.76 | --- | 74.00 | 30.24 | 100.0 | V | 39.0 | 0 |
| 7332.000000 | --- | 34.19 | 54.00 | 19.81 | 100.0 | H | 269.0 | 1 |
| 9754.000000 | --- | 36.59 | 54.00 | 17.41 | 200.0 | V | 151.0 | 4 |
| 9900.000000 | 45.56 | --- | 74.00 | 28.44 | 100.0 | V | 144.0 | 4 |
| 13324.500000 | --- | 38.56 | 54.00 | 15.44 | 100.0 | H | 93.0 | 9 |
| 13351.500000 | 48.66 | --- | 74.00 | 25.34 | 100.0 | V | 120.0 | 9 |

Remark: 1. Correction Factor = Antenna factor+ Insertion loss (cable loss + amplifier gain)



802.11g CH6

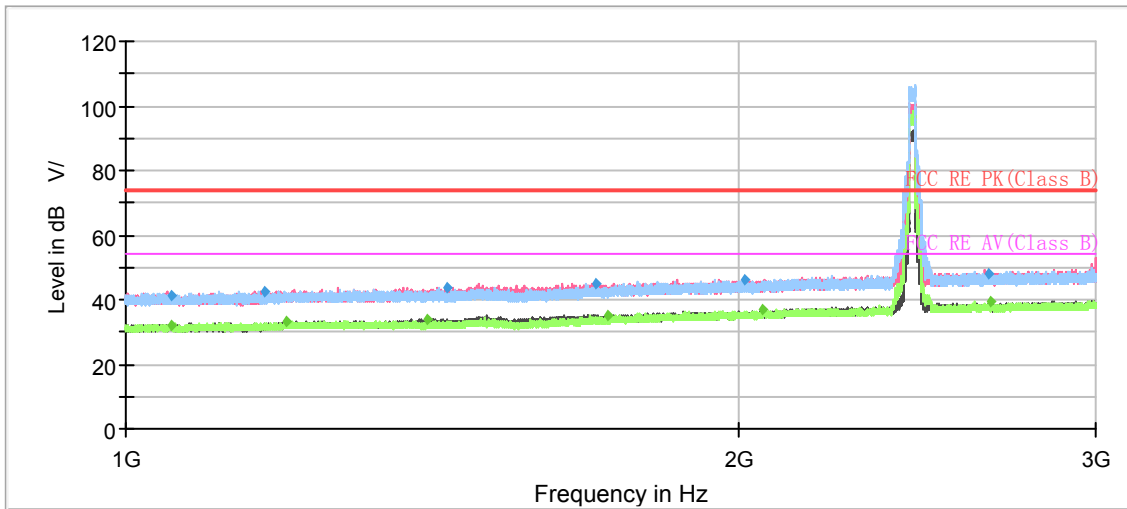

Note: The signal beyond the limit is carrier.

Radiates Emission from 1GHz to 3GHz

| Frequency (MHz) | MaxPeak (dB μ V/m) | Average (dB μ V/m) | Limit (dB μ V/m) | Margin (dB) | Height (cm) | Pol | Azimuth (deg) | Corr. (dB/m) |
|-----------------|------------------------|------------------------|----------------------|-------------|-------------|-----|---------------|--------------|
| 1052.200000 | 41.13 | --- | 74.00 | 32.87 | 100.0 | H | 0.0 | -9 |
| 1052.666667 | --- | 31.94 | 54.00 | 22.06 | 100.0 | V | 18.0 | -9 |
| 1171.400000 | 42.54 | --- | 74.00 | 31.46 | 100.0 | H | 352.0 | -8 |
| 1198.600000 | --- | 32.99 | 54.00 | 21.01 | 100.0 | V | 92.0 | -8 |
| 1405.933333 | --- | 34.00 | 54.00 | 20.00 | 100.0 | V | 55.0 | -6 |
| 1438.333333 | 43.89 | --- | 74.00 | 30.11 | 100.0 | V | 25.0 | -6 |
| 1704.600000 | 45.02 | --- | 74.00 | 28.98 | 100.0 | V | 70.0 | -5 |
| 1724.600000 | --- | 35.09 | 54.00 | 18.91 | 100.0 | V | 48.0 | -4 |
| 2015.133333 | 46.16 | --- | 74.00 | 27.84 | 200.0 | V | 166.0 | -3 |
| 2055.800000 | --- | 36.66 | 54.00 | 17.34 | 100.0 | H | 345.0 | -3 |
| 2659.533333 | 47.93 | --- | 74.00 | 26.07 | 200.0 | V | 328.0 | 0 |
| 2660.866667 | --- | 39.52 | 54.00 | 14.48 | 200.0 | V | 313.0 | 0 |

Remark: 1. Correction Factor = Antenna factor+ Insertion loss (cable loss + amplifier gain)

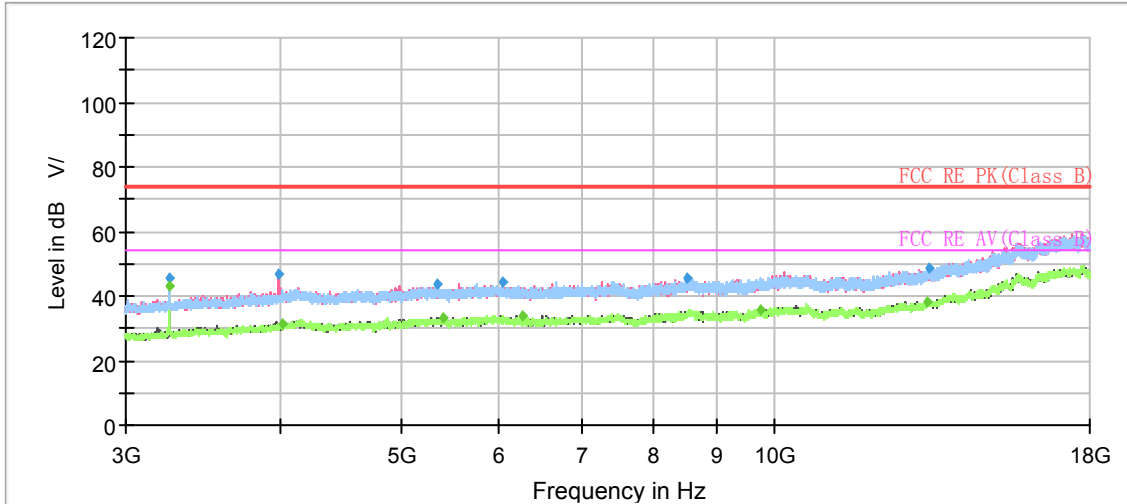

Radiates Emission from 3GHz to 18GHz

| Frequency (MHz) | MaxPeak (dB μ V/m) | Average (dB μ V/m) | Limit (dB μ V/m) | Margin (dB) | Height (cm) | Pol | Azimuth (deg) | Corr. (dB/m) |
|-----------------|------------------------|------------------------|----------------------|-------------|-------------|-----|---------------|--------------|
| 3249.000000 | 45.49 | --- | 74.00 | 28.51 | 100.0 | H | 312.0 | -7 |
| 3249.000000 | --- | 42.95 | 54.00 | 11.05 | 100.0 | H | 312.0 | -7 |
| 3987.500000 | 46.69 | --- | 74.00 | 27.31 | 200.0 | V | 167.0 | -4 |
| 4018.500000 | --- | 31.27 | 54.00 | 22.73 | 100.0 | V | 0.0 | -4 |
| 5359.500000 | 43.48 | --- | 74.00 | 30.52 | 200.0 | V | 151.0 | -1 |
| 5409.000000 | --- | 33.45 | 54.00 | 20.55 | 200.0 | V | 151.0 | -1 |
| 6053.000000 | 44.52 | --- | 74.00 | 29.48 | 200.0 | V | 109.0 | 0 |
| 6278.500000 | --- | 33.97 | 54.00 | 20.03 | 100.0 | H | 33.0 | 0 |
| 8521.000000 | 45.60 | --- | 74.00 | 28.40 | 100.0 | H | 41.0 | 4 |
| 9745.500000 | --- | 35.99 | 54.00 | 18.01 | 200.0 | V | 125.0 | 4 |
| 13315.500000 | --- | 38.46 | 54.00 | 15.54 | 200.0 | V | 221.0 | 9 |
| 13336.500000 | 48.63 | --- | 74.00 | 25.37 | 200.0 | V | 312.0 | 9 |

Remark: 1. Correction Factor = Antenna factor+ Insertion loss (cable loss + amplifier gain)



802.11g CH11

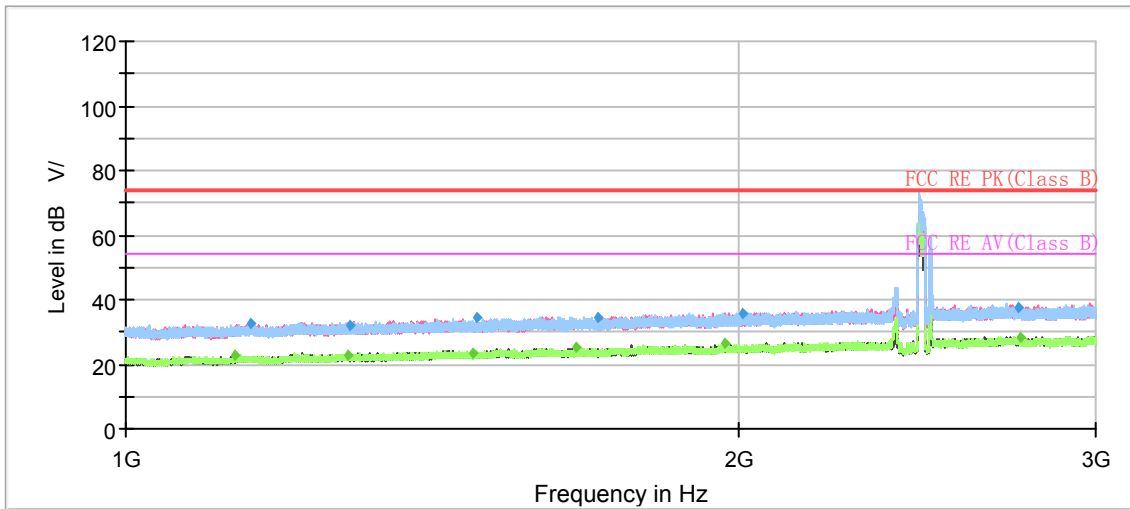

Note: The signal beyond the limit is carrier.

Radiates Emission from 1GHz to 3GHz

| Frequency (MHz) | MaxPeak (dB μ V/m) | Average (dB μ V/m) | Limit (dB μ V/m) | Margin (dB) | Height (cm) | Pol | Azimuth (deg) | Corr. (dB/m) |
|-----------------|------------------------|------------------------|----------------------|-------------|-------------|-----|---------------|--------------|
| 1132.533333 | --- | 22.52 | 54.00 | 31.48 | 200.0 | H | 169.0 | -18 |
| 1153.333333 | 32.88 | --- | 74.00 | 41.12 | 200.0 | H | 146.0 | -18 |
| 1287.333333 | --- | 22.90 | 54.00 | 31.10 | 200.0 | H | 315.0 | -17 |
| 1288.600000 | 32.11 | --- | 74.00 | 41.89 | 100.0 | V | 95.0 | -17 |
| 1480.266667 | --- | 23.36 | 54.00 | 30.64 | 100.0 | V | 0.0 | -16 |
| 1489.533333 | 34.61 | --- | 74.00 | 39.39 | 200.0 | H | 183.0 | -16 |
| 1667.000000 | --- | 24.94 | 54.00 | 29.06 | 200.0 | V | 156.0 | -15 |
| 1705.466667 | 34.45 | --- | 74.00 | 39.55 | 200.0 | H | 234.0 | -15 |
| 1969.400000 | --- | 26.40 | 54.00 | 27.60 | 200.0 | H | 212.0 | -13 |
| 2013.333333 | 35.98 | --- | 74.00 | 38.02 | 200.0 | H | 242.0 | -13 |
| 2748.066667 | 37.62 | --- | 74.00 | 36.38 | 100.0 | V | 274.0 | -9 |
| 2751.533333 | --- | 28.05 | 54.00 | 25.95 | 100.0 | V | 357.0 | -9 |

Remark: 1. Correction Factor = Antenna factor+ Insertion loss (cable loss + amplifier gain)

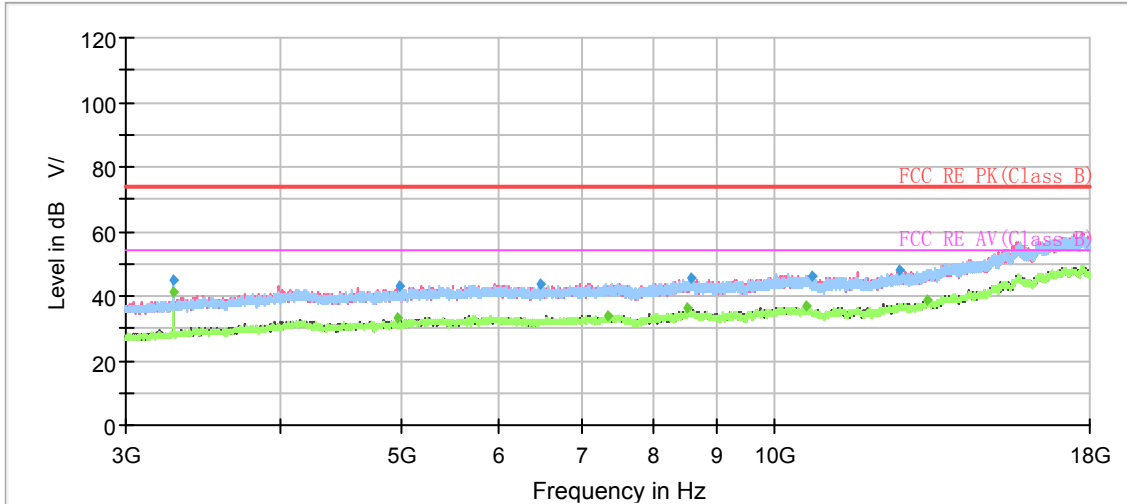

Radiates Emission from 3GHz to 18GHz

| Frequency (MHz) | MaxPeak (dB μ V/m) | Average (dB μ V/m) | Limit (dB μ V/m) | Margin (dB) | Height (cm) | Pol | Azimuth (deg) | Corr. (dB/m) |
|-----------------|------------------------|------------------------|----------------------|-------------|-------------|-----|---------------|--------------|
| 3282.500000 | --- | 41.50 | 54.00 | 12.50 | 100.0 | H | 311.0 | -7 |
| 3282.500000 | 45.04 | --- | 74.00 | 28.96 | 100.0 | H | 311.0 | -7 |
| 4978.000000 | --- | 33.25 | 54.00 | 20.75 | 200.0 | V | 106.0 | -1 |
| 4984.500000 | 43.23 | --- | 74.00 | 30.77 | 200.0 | V | 130.0 | -1 |
| 6475.000000 | 43.79 | --- | 74.00 | 30.21 | 200.0 | H | 285.0 | 0 |
| 7336.500000 | --- | 33.86 | 54.00 | 20.14 | 200.0 | H | 91.0 | 1 |
| 8527.000000 | --- | 36.18 | 54.00 | 17.82 | 200.0 | V | 170.0 | 4 |
| 8574.500000 | 45.37 | --- | 74.00 | 28.63 | 200.0 | H | 325.0 | 4 |
| 10629.500000 | --- | 36.67 | 54.00 | 17.33 | 200.0 | V | 51.0 | 5 |
| 10726.500000 | 46.34 | --- | 74.00 | 27.66 | 200.0 | V | 235.0 | 5 |
| 12624.500000 | 48.14 | --- | 74.00 | 25.86 | 200.0 | H | 108.0 | 8 |
| 13327.000000 | --- | 38.93 | 54.00 | 15.07 | 200.0 | H | 132.0 | 9 |

Remark: 1. Correction Factor = Antenna factor+ Insertion loss (cable loss + amplifier gain)



802.11n (HT20) CH1

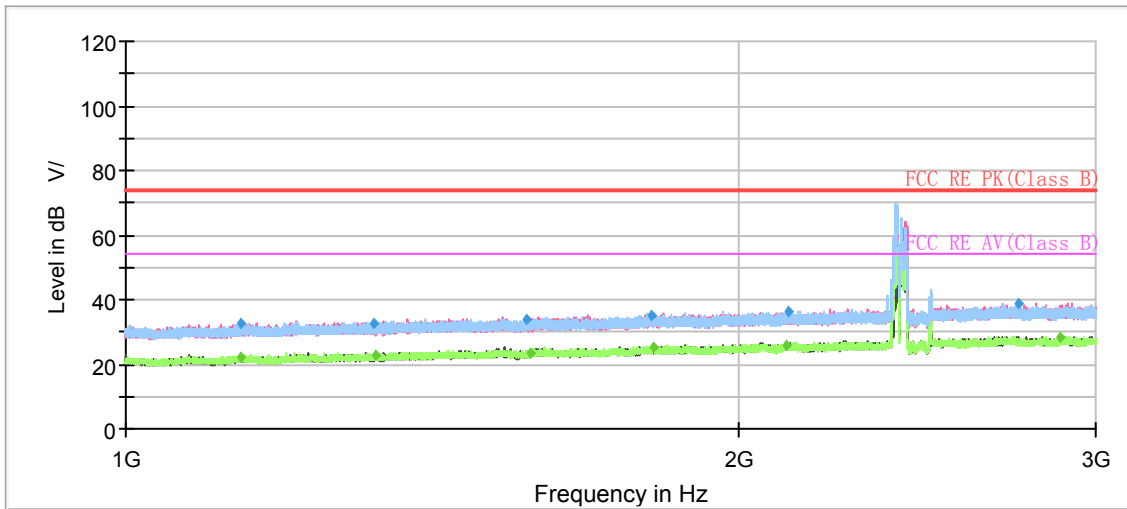

Note: The signal beyond the limit is carrier.

Radiates Emission from 1GHz to 3GHz

| Frequency (MHz) | MaxPeak (dB μ V/m) | Average (dB μ V/m) | Limit (dB μ V/m) | Margin (dB) | Height (cm) | Pol | Azimuth (deg) | Corr. (dB/m) |
|-----------------|------------------------|------------------------|----------------------|-------------|-------------|-----|---------------|--------------|
| 1138.066667 | --- | 22.13 | 54.00 | 31.87 | 100.0 | V | 196.0 | -18 |
| 1139.333333 | 32.41 | --- | 74.00 | 41.59 | 100.0 | H | 108.0 | -18 |
| 1324.800000 | 32.67 | --- | 74.00 | 41.33 | 200.0 | H | 0.0 | -17 |
| 1327.733333 | --- | 22.70 | 54.00 | 31.30 | 100.0 | V | 188.0 | -17 |
| 1574.066667 | 33.58 | --- | 74.00 | 40.42 | 100.0 | V | 232.0 | -15 |
| 1580.600000 | --- | 23.18 | 54.00 | 30.82 | 200.0 | V | 324.0 | -15 |
| 1813.266667 | 34.86 | --- | 74.00 | 39.14 | 200.0 | H | 273.0 | -14 |
| 1816.600000 | --- | 25.48 | 54.00 | 28.52 | 200.0 | H | 296.0 | -14 |
| 2114.733333 | --- | 26.08 | 54.00 | 27.92 | 100.0 | V | 204.0 | -12 |
| 2120.066667 | 36.01 | --- | 74.00 | 37.99 | 200.0 | V | 119.0 | -12 |
| 2747.800000 | 38.60 | --- | 74.00 | 35.40 | 100.0 | V | 328.0 | -9 |
| 2880.400000 | --- | 28.56 | 54.00 | 25.44 | 200.0 | V | 17.0 | -9 |

Remark: 1. Correction Factor = Antenna factor+ Insertion loss (cable loss + amplifier gain)

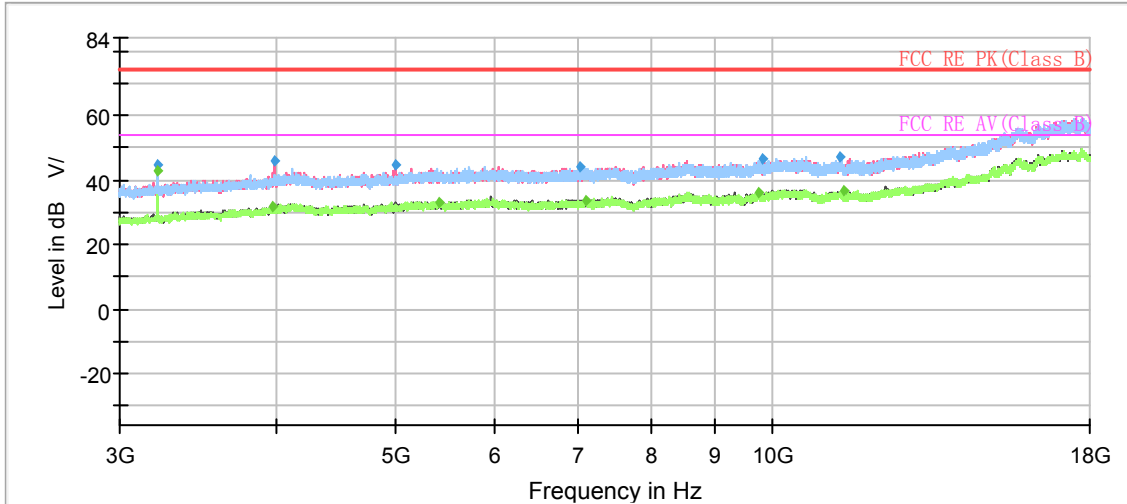

Radiates Emission from 3GHz to 18GHz

| Frequency (MHz) | MaxPeak (dB μ V/m) | Average (dB μ V/m) | Limit (dB μ V/m) | Margin (dB) | Height (cm) | Pol | Azimuth (deg) | Corr. (dB/m) |
|-----------------|------------------------|------------------------|----------------------|-------------|-------------|-----|---------------|--------------|
| 3216.000000 | --- | 42.47 | 54.00 | 11.53 | 100.0 | H | 221.0 | -8 |
| 3216.000000 | 44.57 | --- | 74.00 | 29.43 | 100.0 | H | 221.0 | -8 |
| 3974.000000 | --- | 31.91 | 54.00 | 22.09 | 100.0 | V | 81.0 | -4 |
| 3998.500000 | 46.06 | --- | 74.00 | 27.94 | 200.0 | V | 143.0 | -4 |
| 4996.500000 | 44.44 | --- | 74.00 | 29.56 | 200.0 | V | 101.0 | -1 |
| 5417.000000 | --- | 33.00 | 54.00 | 21.00 | 200.0 | H | 258.0 | -1 |
| 7014.000000 | 43.71 | --- | 74.00 | 30.29 | 200.0 | V | 158.0 | 1 |
| 7085.000000 | --- | 33.84 | 54.00 | 20.16 | 200.0 | V | 0.0 | 1 |
| 9751.000000 | --- | 36.07 | 54.00 | 17.93 | 200.0 | H | 218.0 | 4 |
| 9843.000000 | 46.38 | --- | 74.00 | 27.62 | 100.0 | H | 6.0 | 4 |
| 11360.000000 | 46.93 | --- | 74.00 | 27.07 | 200.0 | V | 0.0 | 6 |
| 11407.500000 | --- | 36.53 | 54.00 | 17.47 | 200.0 | H | 83.0 | 6 |

Remark: 1. Correction Factor = Antenna factor+ Insertion loss (cable loss + amplifier gain)

802.11n (HT20) CH6

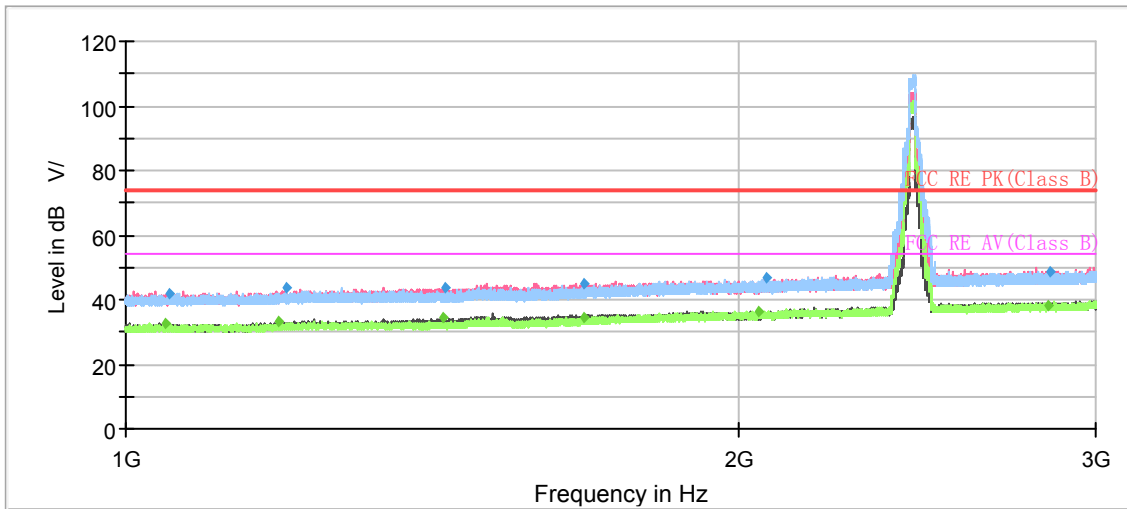

Note: The signal beyond the limit is carrier.

Radiates Emission from 1GHz to 3GHz

| Frequency (MHz) | MaxPeak (dB μ V/m) | Average (dB μ V/m) | Limit (dB μ V/m) | Margin (dB) | Height (cm) | Pol | Azimuth (deg) | Corr. (dB/m) |
|-----------------|------------------------|------------------------|----------------------|-------------|-------------|-----|---------------|--------------|
| 1047.066667 | --- | 32.46 | 54.00 | 21.54 | 200.0 | V | 318.0 | -9 |
| 1051.200000 | 41.75 | --- | 74.00 | 32.25 | 200.0 | V | 276.0 | -9 |
| 1187.533333 | --- | 32.93 | 54.00 | 21.07 | 200.0 | V | 348.0 | -8 |
| 1199.000000 | 43.86 | --- | 74.00 | 30.14 | 100.0 | H | 191.0 | -8 |
| 1431.466667 | --- | 34.32 | 54.00 | 19.68 | 200.0 | V | 261.0 | -6 |
| 1435.866667 | 43.89 | --- | 74.00 | 30.11 | 200.0 | V | 231.0 | -6 |
| 1678.666667 | --- | 34.42 | 54.00 | 19.58 | 200.0 | V | 111.0 | -5 |
| 1679.200000 | 44.86 | --- | 74.00 | 29.14 | 200.0 | V | 276.0 | -5 |
| 2049.133333 | --- | 36.54 | 54.00 | 17.46 | 100.0 | H | 121.0 | -3 |
| 2066.866667 | 46.49 | --- | 74.00 | 27.51 | 200.0 | H | 350.0 | -3 |
| 2842.533333 | --- | 38.36 | 54.00 | 15.64 | 200.0 | V | 209.0 | 1 |
| 2847.400000 | 48.43 | --- | 74.00 | 25.57 | 200.0 | V | 103.0 | 1 |

Remark: 1. Correction Factor = Antenna factor+ Insertion loss (cable loss + amplifier gain)

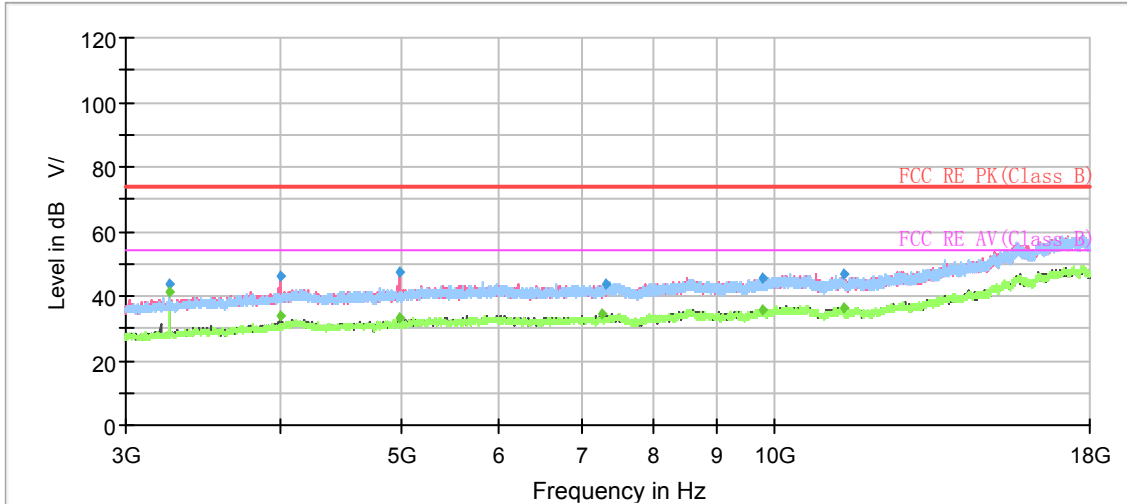

Radiates Emission from 3GHz to 18GHz

| Frequency (MHz) | MaxPeak (dB μ V/m) | Average (dB μ V/m) | Limit (dB μ V/m) | Margin (dB) | Height (cm) | Pol | Azimuth (deg) | Corr. (dB/m) |
|-----------------|------------------------|------------------------|----------------------|-------------|-------------|-----|---------------|--------------|
| 3249.000000 | 43.85 | --- | 74.00 | 30.15 | 100.0 | H | 295.0 | -7 |
| 3249.000000 | --- | 41.36 | 54.00 | 12.64 | 100.0 | H | 295.0 | -7 |
| 3998.500000 | 46.10 | --- | 74.00 | 27.90 | 200.0 | V | 140.0 | -4 |
| 3998.500000 | --- | 34.15 | 54.00 | 19.85 | 200.0 | V | 140.0 | -4 |
| 4988.500000 | 47.49 | --- | 74.00 | 26.51 | 200.0 | V | 38.0 | -1 |
| 4998.000000 | --- | 33.40 | 54.00 | 20.60 | 200.0 | V | 109.0 | -1 |
| 7273.000000 | --- | 34.29 | 54.00 | 19.71 | 100.0 | V | 344.0 | 1 |
| 7308.000000 | 43.54 | --- | 74.00 | 30.46 | 200.0 | V | 69.0 | 1 |
| 9783.500000 | 45.43 | --- | 74.00 | 28.57 | 200.0 | V | 93.0 | 4 |
| 9785.000000 | --- | 35.68 | 54.00 | 18.32 | 200.0 | H | 15.0 | 4 |
| 11387.500000 | 46.57 | --- | 74.00 | 27.43 | 200.0 | H | 116.0 | 6 |
| 11398.000000 | --- | 36.45 | 54.00 | 17.55 | 200.0 | H | 229.0 | 6 |

Remark: 1. Correction Factor = Antenna factor+ Insertion loss (cable loss + amplifier gain)

802.11n (HT20) CH11

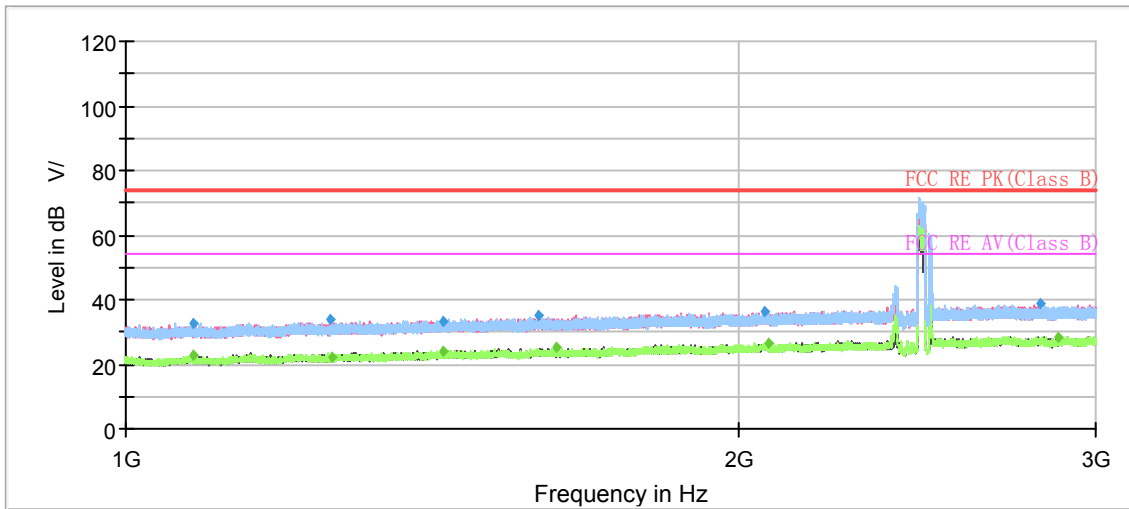

Note: The signal beyond the limit is carrier.

Radiates Emission from 1GHz to 3GHz

| Frequency (MHz) | MaxPeak (dB μ V/m) | Average (dB μ V/m) | Limit (dB μ V/m) | Margin (dB) | Height (cm) | Pol | Azimuth (deg) | Corr. (dB/m) |
|-----------------|------------------------|------------------------|----------------------|-------------|-------------|-----|---------------|--------------|
| 1079.866667 | --- | 22.57 | 54.00 | 31.43 | 200.0 | V | 316.0 | -18 |
| 1080.466667 | 32.68 | --- | 74.00 | 41.32 | 200.0 | V | 133.0 | -18 |
| 1261.000000 | 33.83 | --- | 74.00 | 40.17 | 100.0 | V | 300.0 | -17 |
| 1264.466667 | --- | 21.96 | 54.00 | 32.04 | 200.0 | V | 111.0 | -17 |
| 1432.466667 | 33.13 | --- | 74.00 | 40.87 | 200.0 | H | 114.0 | -16 |
| 1433.266667 | --- | 24.17 | 54.00 | 29.83 | 100.0 | H | 0.0 | -16 |
| 1596.200000 | 34.88 | --- | 74.00 | 39.12 | 100.0 | H | 3.0 | -15 |
| 1626.466667 | --- | 25.23 | 54.00 | 28.77 | 200.0 | V | 178.0 | -15 |
| 2059.733333 | 36.12 | --- | 74.00 | 37.88 | 200.0 | H | 237.0 | -13 |
| 2070.066667 | --- | 26.20 | 54.00 | 27.80 | 200.0 | H | 339.0 | -13 |
| 2819.933333 | 38.73 | --- | 74.00 | 35.27 | 200.0 | H | 237.0 | -9 |
| 2874.866667 | --- | 28.61 | 54.00 | 25.39 | 200.0 | V | 0.0 | -9 |

Remark: 1. Correction Factor = Antenna factor+ Insertion loss (cable loss + amplifier gain)

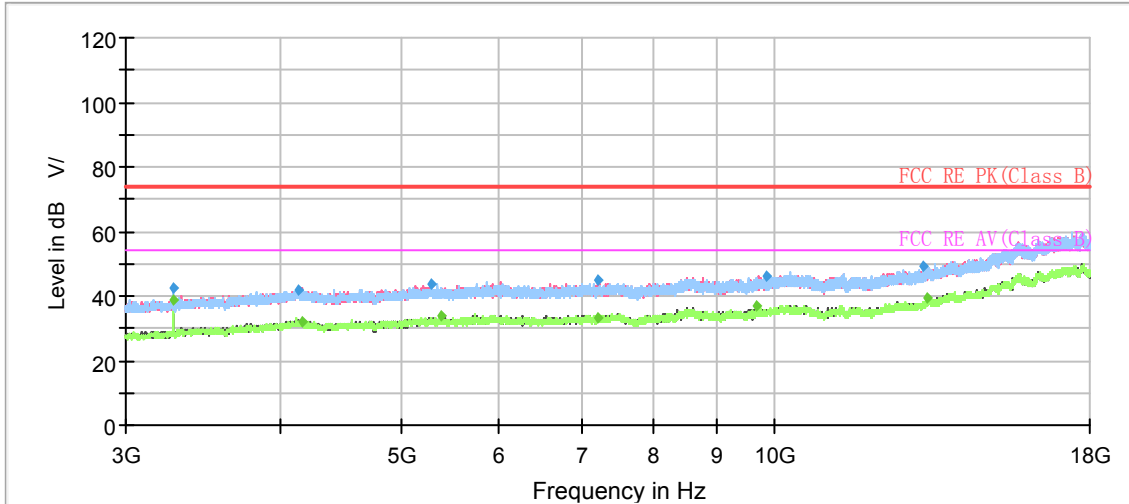

Radiates Emission from 3GHz to 18GHz

| Frequency (MHz) | MaxPeak (dB μ V/m) | Average (dB μ V/m) | Limit (dB μ V/m) | Margin (dB) | Height (cm) | Pol | Azimuth (deg) | Corr. (dB/m) |
|-----------------|------------------------|------------------------|----------------------|-------------|-------------|-----|---------------|--------------|
| 3282.500000 | --- | 38.69 | 54.00 | 15.31 | 200.0 | H | 254.0 | -7 |
| 3282.500000 | 42.24 | --- | 74.00 | 31.76 | 200.0 | H | 254.0 | -7 |
| 4132.000000 | 42.10 | --- | 74.00 | 31.90 | 100.0 | V | 243.0 | -3 |
| 4165.500000 | --- | 32.13 | 54.00 | 21.87 | 200.0 | V | 2.0 | -3 |
| 5297.000000 | 43.55 | --- | 74.00 | 30.45 | 100.0 | V | 132.0 | -1 |
| 5389.000000 | --- | 33.71 | 54.00 | 20.29 | 200.0 | V | 220.0 | -1 |
| 7215.500000 | --- | 33.16 | 54.00 | 20.84 | 100.0 | V | 39.0 | 1 |
| 7224.000000 | 44.67 | --- | 74.00 | 29.33 | 100.0 | V | 354.0 | 1 |
| 9696.000000 | --- | 36.64 | 54.00 | 17.36 | 200.0 | H | 325.0 | 4 |
| 9856.500000 | 45.91 | --- | 74.00 | 28.09 | 200.0 | H | 74.0 | 4 |
| 13195.000000 | 49.05 | --- | 74.00 | 24.95 | 200.0 | H | 270.0 | 9 |
| 13312.000000 | --- | 39.59 | 54.00 | 14.41 | 200.0 | V | 2.0 | 9 |

Remark: 1. Correction Factor = Antenna factor+ Insertion loss (cable loss + amplifier gain)

802.11n (HT40) CH3

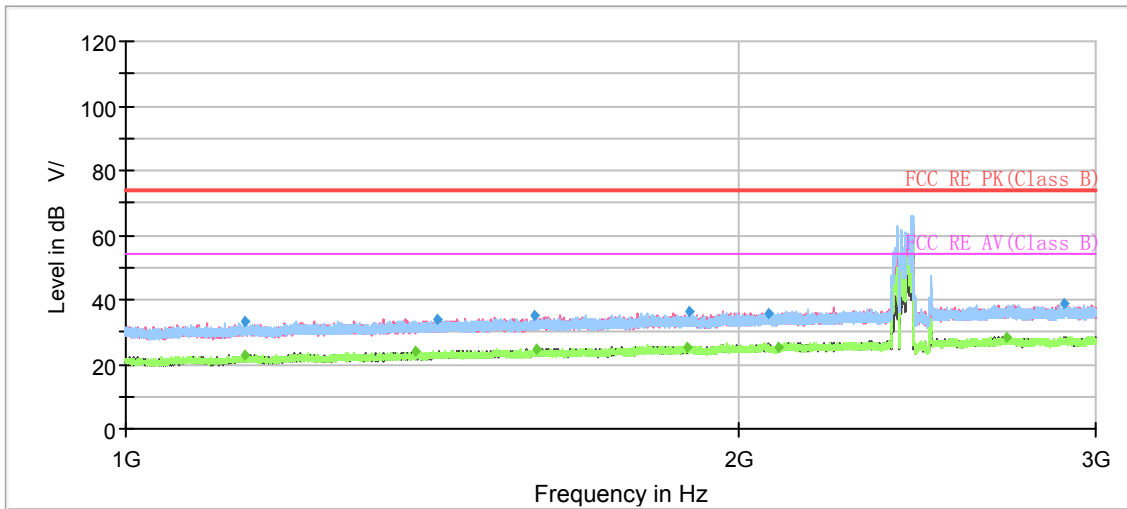

Note: The signal beyond the limit is carrier.

Radiates Emission from 1GHz to 3GHz

| Frequency (MHz) | MaxPeak (dB μ V/m) | Average (dB μ V/m) | Limit (dB μ V/m) | Margin (dB) | Height (cm) | Pol | Azimuth (deg) | Corr. (dB/m) |
|-----------------|------------------------|------------------------|----------------------|-------------|-------------|-----|---------------|--------------|
| 1143.466667 | --- | 22.91 | 54.00 | 31.09 | 200.0 | V | 160.0 | -18 |
| 1144.066667 | 32.94 | --- | 74.00 | 41.06 | 200.0 | H | 251.0 | -18 |
| 1387.733333 | --- | 24.19 | 54.00 | 29.81 | 200.0 | V | 285.0 | -16 |
| 1424.066667 | 33.97 | --- | 74.00 | 40.03 | 100.0 | H | 116.0 | -16 |
| 1587.466667 | 35.14 | --- | 74.00 | 38.86 | 200.0 | V | 20.0 | -15 |
| 1591.000000 | --- | 24.39 | 54.00 | 29.61 | 200.0 | V | 337.0 | -15 |
| 1889.466667 | --- | 25.47 | 54.00 | 28.53 | 100.0 | H | 152.0 | -14 |
| 1891.466667 | 36.41 | --- | 74.00 | 37.59 | 100.0 | H | 293.0 | -14 |
| 2073.066667 | 35.69 | --- | 74.00 | 38.31 | 100.0 | V | 94.0 | -13 |
| 2094.400000 | --- | 25.46 | 54.00 | 28.54 | 200.0 | V | 263.0 | -12 |
| 2709.466667 | --- | 28.56 | 54.00 | 25.44 | 100.0 | V | 109.0 | -9 |
| 2893.133333 | 38.46 | --- | 74.00 | 35.54 | 100.0 | V | 109.0 | -9 |

Remark: 1. Correction Factor = Antenna factor+ Insertion loss (cable loss + amplifier gain)

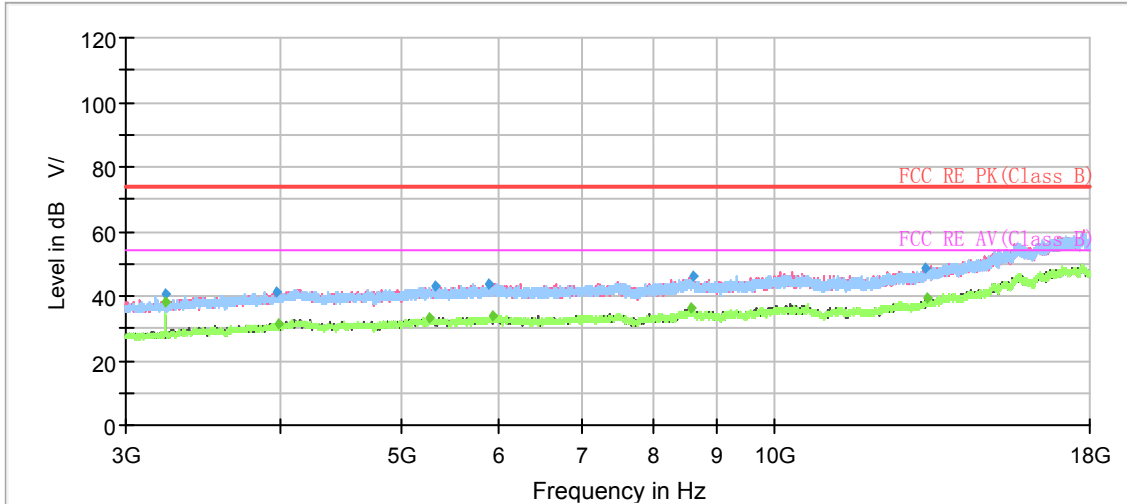

Radiates Emission from 3GHz to 18GHz

| Frequency (MHz) | MaxPeak (dB μ V/m) | Average (dB μ V/m) | Limit (dB μ V/m) | Margin (dB) | Height (cm) | Pol | Azimuth (deg) | Corr. (dB/m) |
|-----------------|------------------------|------------------------|----------------------|-------------|-------------|-----|---------------|--------------|
| 3229.000000 | --- | 38.09 | 54.00 | 15.91 | 100.0 | H | 257.0 | -7 |
| 3229.000000 | 40.91 | --- | 74.00 | 33.09 | 200.0 | H | 260.0 | -7 |
| 3970.000000 | 41.47 | --- | 74.00 | 32.53 | 100.0 | V | 149.0 | -4 |
| 3987.000000 | --- | 31.36 | 54.00 | 22.64 | 200.0 | V | 182.0 | -4 |
| 5271.500000 | --- | 33.22 | 54.00 | 20.78 | 200.0 | V | 356.0 | -1 |
| 5326.500000 | 42.91 | --- | 74.00 | 31.09 | 100.0 | H | 81.0 | -1 |
| 5895.000000 | 43.98 | --- | 74.00 | 30.02 | 200.0 | H | 0.0 | 0 |
| 5942.000000 | --- | 33.96 | 54.00 | 20.04 | 200.0 | V | 301.0 | 0 |
| 8577.000000 | --- | 36.16 | 54.00 | 17.84 | 100.0 | H | 0.0 | 4 |
| 8604.500000 | 46.02 | --- | 74.00 | 27.98 | 200.0 | H | 27.0 | 4 |
| 13251.000000 | 48.61 | --- | 74.00 | 25.39 | 100.0 | H | 281.0 | 9 |
| 13311.000000 | --- | 39.17 | 54.00 | 14.83 | 200.0 | H | 35.0 | 9 |

Remark: 1. Correction Factor = Antenna factor+ Insertion loss (cable loss + amplifier gain)



802.11n (HT40) CH6

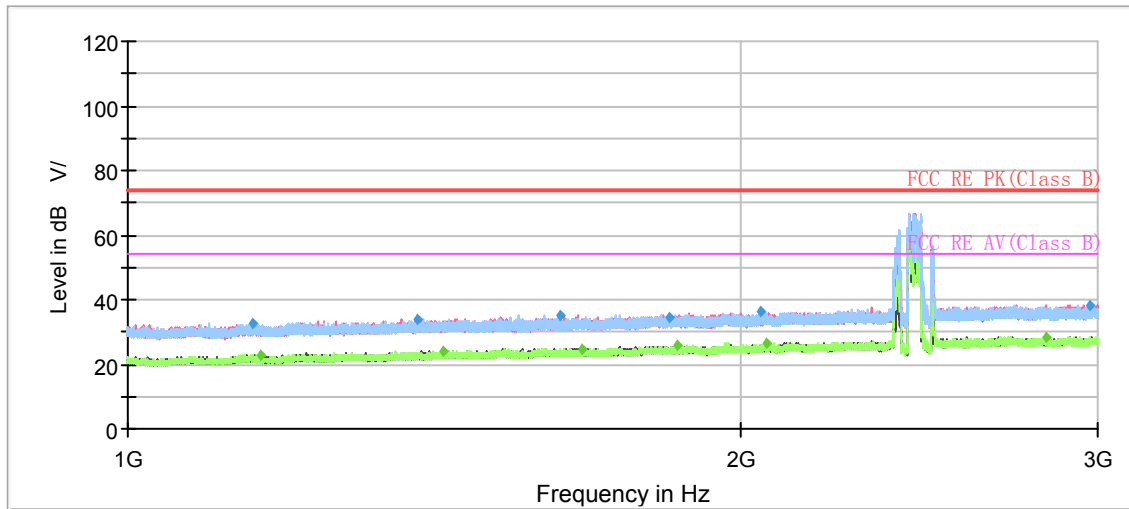

Note: The signal beyond the limit is carrier.

Radiates Emission from 1GHz to 3GHz

| Frequency (MHz) | MaxPeak (dB μ V/m) | Average (dB μ V/m) | Limit (dB μ V/m) | Margin (dB) | Height (cm) | Pol | Azimuth (deg) | Corr. (dB/m) |
|-----------------|--------------------|--------------------|------------------|-------------|-------------|-----|---------------|--------------|
| 1153.200000 | 32.68 | --- | 74.00 | 41.32 | 200.0 | V | 322.0 | -18 |
| 1162.733333 | --- | 23.03 | 54.00 | 30.97 | 100.0 | V | 246.0 | -18 |
| 1389.333333 | 33.94 | --- | 74.00 | 40.06 | 100.0 | V | 168.0 | -16 |
| 1429.533333 | --- | 23.97 | 54.00 | 30.03 | 200.0 | V | 285.0 | -16 |
| 1630.733333 | 35.32 | --- | 74.00 | 38.68 | 200.0 | H | 314.0 | -15 |
| 1672.866667 | --- | 24.91 | 54.00 | 29.09 | 100.0 | H | 240.0 | -15 |
| 1845.333333 | 34.32 | --- | 74.00 | 39.68 | 100.0 | V | 87.0 | -14 |
| 1862.800000 | --- | 25.92 | 54.00 | 28.08 | 100.0 | H | 93.0 | -14 |
| 2045.600000 | 36.55 | --- | 74.00 | 37.45 | 200.0 | V | 0.0 | -13 |
| 2059.866667 | --- | 26.66 | 54.00 | 27.34 | 200.0 | V | 0.0 | -13 |
| 2830.133333 | --- | 28.51 | 54.00 | 25.49 | 100.0 | V | 0.0 | -9 |
| 2974.800000 | 38.46 | --- | 74.00 | 35.54 | 200.0 | V | 226.0 | -9 |

Remark: 1. Correction Factor = Antenna factor+ Insertion loss (cable loss + amplifier gain)

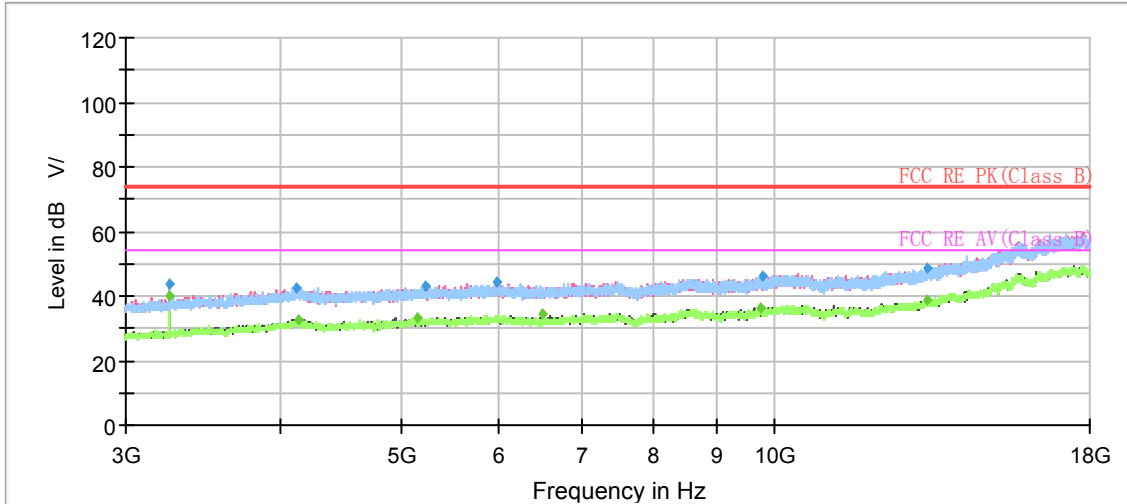

Radiates Emission from 3GHz to 18GHz

| Frequency (MHz) | MaxPeak (dB μ V/m) | Average (dB μ V/m) | Limit (dB μ V/m) | Margin (dB) | Height (cm) | Pol | Azimuth (deg) | Corr. (dB/m) |
|-----------------|------------------------|------------------------|----------------------|-------------|-------------|-----|---------------|--------------|
| 3249.000000 | --- | 40.27 | 54.00 | 13.73 | 200.0 | H | 260.0 | -7 |
| 3249.500000 | 43.94 | --- | 74.00 | 30.06 | 100.0 | H | 304.0 | -7 |
| 4118.000000 | 42.77 | --- | 74.00 | 31.23 | 100.0 | V | 175.0 | -3 |
| 4134.000000 | --- | 32.60 | 54.00 | 21.40 | 100.0 | V | 47.0 | -3 |
| 5154.500000 | --- | 33.33 | 54.00 | 20.67 | 100.0 | H | 335.0 | -1 |
| 5243.500000 | 43.00 | --- | 74.00 | 31.00 | 100.0 | V | 31.0 | -1 |
| 5976.500000 | 44.19 | --- | 74.00 | 29.81 | 200.0 | H | 55.0 | 0 |
| 6498.500000 | --- | 34.55 | 54.00 | 19.45 | 100.0 | V | 142.0 | 0 |
| 9749.500000 | --- | 36.39 | 54.00 | 17.61 | 200.0 | V | 237.0 | 4 |
| 9791.500000 | 45.87 | --- | 74.00 | 28.13 | 200.0 | H | 251.0 | 4 |
| 13292.500000 | 48.54 | --- | 74.00 | 25.46 | 100.0 | H | 0.0 | 9 |
| 13307.000000 | --- | 39.06 | 54.00 | 14.94 | 200.0 | H | 0.0 | 9 |

Remark: 1. Correction Factor = Antenna factor+ Insertion loss (cable loss + amplifier gain)

802.11n (HT40) CH9

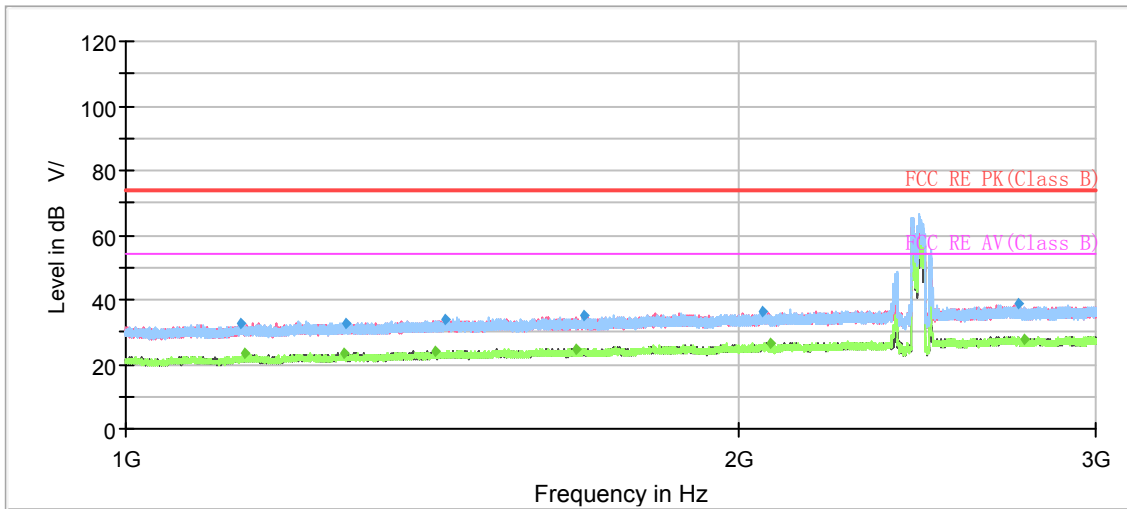

Note: The signal beyond the limit is carrier.

Radiates Emission from 1GHz to 3GHz

| Frequency (MHz) | MaxPeak (dB μ V/m) | Average (dB μ V/m) | Limit (dB μ V/m) | Margin (dB) | Height (cm) | Pol | Azimuth (deg) | Corr. (dB/m) |
|-----------------|------------------------|------------------------|----------------------|-------------|-------------|-----|---------------|--------------|
| 1138.400000 | 32.55 | --- | 74.00 | 41.45 | 200.0 | H | 74.0 | -18 |
| 1145.133333 | --- | 23.19 | 54.00 | 30.81 | 200.0 | H | 197.0 | -18 |
| 1280.733333 | --- | 23.57 | 54.00 | 30.43 | 100.0 | H | 356.0 | -17 |
| 1282.533333 | 32.80 | --- | 74.00 | 41.20 | 200.0 | H | 146.0 | -17 |
| 1420.600000 | --- | 23.97 | 54.00 | 30.03 | 100.0 | V | 5.0 | -16 |
| 1435.066667 | 33.88 | --- | 74.00 | 40.12 | 200.0 | H | 161.0 | -16 |
| 1666.400000 | --- | 24.91 | 54.00 | 29.09 | 100.0 | V | 12.0 | -15 |
| 1680.133333 | 35.22 | --- | 74.00 | 38.79 | 100.0 | H | 267.0 | -15 |
| 2055.066667 | 36.52 | --- | 74.00 | 37.48 | 200.0 | V | 354.0 | -13 |
| 2074.333333 | --- | 26.24 | 54.00 | 27.76 | 200.0 | H | 45.0 | -13 |
| 2749.600000 | 38.70 | --- | 74.00 | 35.30 | 200.0 | H | 251.0 | -9 |
| 2765.933333 | --- | 27.85 | 54.00 | 26.15 | 200.0 | H | 81.0 | -9 |

Remark: 1. Correction Factor = Antenna factor+ Insertion loss (cable loss + amplifier gain)

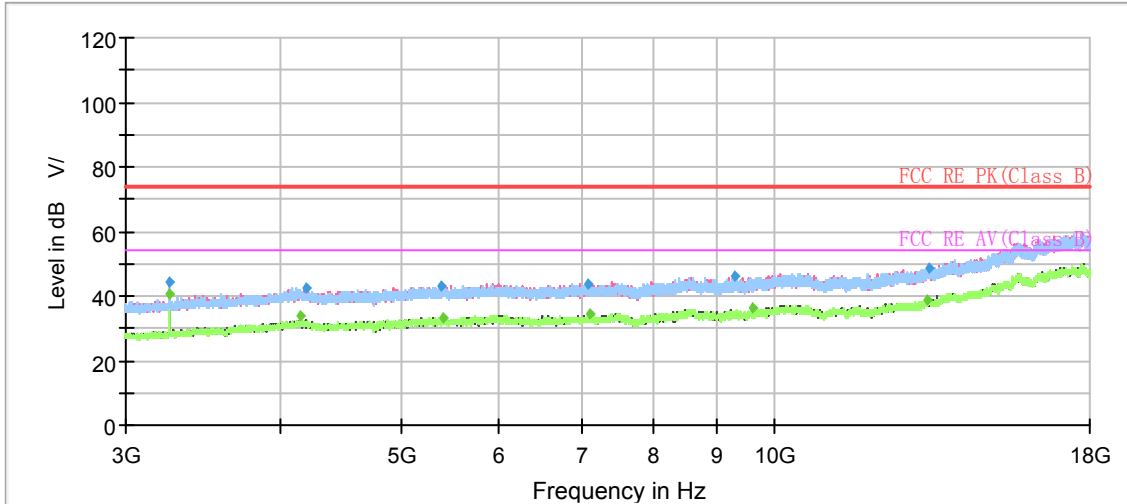

Radiates Emission from 3GHz to 18GHz

| Frequency (MHz) | MaxPeak (dB μ V/m) | Average (dB μ V/m) | Limit (dB μ V/m) | Margin (dB) | Height (cm) | Pol | Azimuth (deg) | Corr. (dB/m) |
|-----------------|------------------------|------------------------|----------------------|-------------|-------------|-----|---------------|--------------|
| 3249.000000 | --- | 40.85 | 54.00 | 13.15 | 200.0 | H | 269.0 | -7 |
| 3249.000000 | 44.40 | --- | 74.00 | 29.60 | 100.0 | H | 309.0 | -7 |
| 4144.000000 | --- | 33.57 | 54.00 | 20.43 | 200.0 | H | 160.0 | -3 |
| 4191.500000 | 42.28 | --- | 74.00 | 31.72 | 200.0 | H | 89.0 | -3 |
| 5395.500000 | 43.06 | --- | 74.00 | 30.94 | 100.0 | V | 64.0 | -1 |
| 5401.500000 | --- | 33.13 | 54.00 | 20.87 | 100.0 | V | 283.0 | -1 |
| 7076.000000 | 43.97 | --- | 74.00 | 30.03 | 200.0 | V | 358.0 | 1 |
| 7106.500000 | --- | 34.27 | 54.00 | 19.73 | 200.0 | H | 73.0 | 1 |
| 9292.500000 | 45.91 | --- | 74.00 | 28.09 | 200.0 | H | 49.0 | 3 |
| 9635.000000 | --- | 36.30 | 54.00 | 17.70 | 200.0 | V | 0.0 | 4 |
| 13317.000000 | --- | 38.97 | 54.00 | 15.03 | 200.0 | V | 342.0 | 9 |
| 13352.500000 | 48.35 | --- | 74.00 | 25.65 | 100.0 | V | 96.0 | 9 |

Remark: 1. Correction Factor = Antenna factor+ Insertion loss (cable loss + amplifier gain)

Bluetooth LE-Channel 0

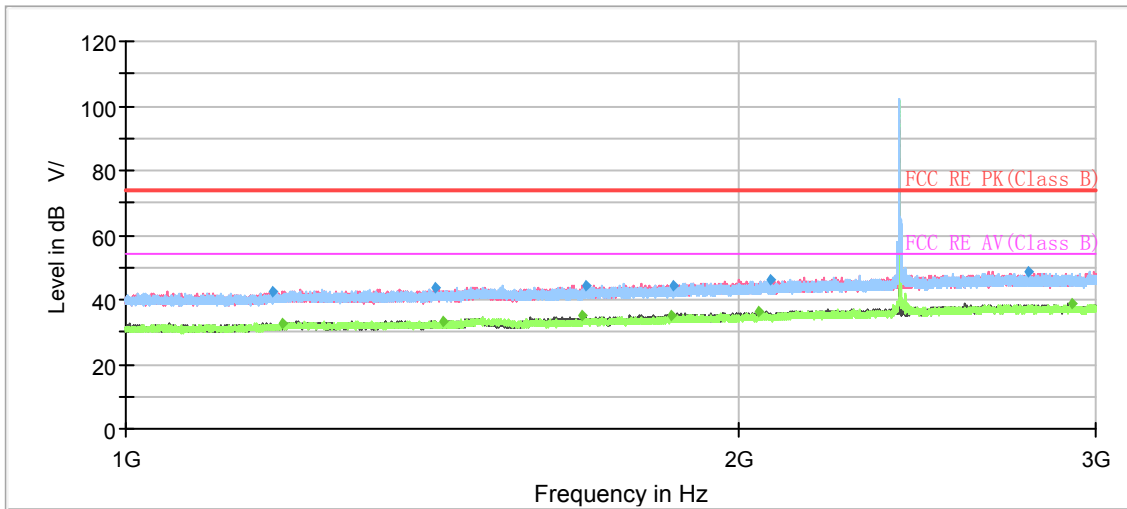

Note: The signal beyond the limit is carrier.

Radiates Emission from 1GHz to 3GHz

| Frequency (MHz) | MaxPeak (dB μ V/m) | Average (dB μ V/m) | Limit (dB μ V/m) | Margin (dB) | Height (cm) | Pol | Azimuth (deg) | Corr. (dB/m) |
|-----------------|------------------------|------------------------|----------------------|-------------|-------------|-----|---------------|--------------|
| 1181.600000 | 42.41 | --- | 74.00 | 31.59 | 200.0 | H | 120.0 | -8 |
| 1194.733333 | --- | 32.74 | 54.00 | 21.26 | 200.0 | V | 0.0 | -8 |
| 1420.466667 | 43.43 | --- | 74.00 | 30.57 | 100.0 | H | 0.0 | -6 |
| 1433.133333 | --- | 33.50 | 54.00 | 20.50 | 100.0 | H | 224.0 | -6 |
| 1677.200000 | --- | 34.84 | 54.00 | 19.16 | 200.0 | V | 75.0 | -5 |
| 1683.600000 | 44.37 | --- | 74.00 | 29.63 | 200.0 | H | 185.0 | -5 |
| 1855.400000 | --- | 35.25 | 54.00 | 18.75 | 100.0 | V | 64.0 | -4 |
| 1857.866667 | 44.29 | --- | 74.00 | 29.71 | 200.0 | V | 339.0 | -4 |
| 2048.866667 | --- | 36.03 | 54.00 | 17.97 | 100.0 | V | 293.0 | -3 |
| 2074.266667 | 45.96 | --- | 74.00 | 28.04 | 200.0 | H | 156.0 | -3 |
| 2782.333333 | 48.67 | --- | 74.00 | 25.33 | 200.0 | V | 339.0 | 1 |
| 2920.733333 | --- | 38.91 | 54.00 | 15.09 | 100.0 | H | 346.0 | 1 |

Remark: 1. Correction Factor = Antenna factor+ Insertion loss (cable loss + amplifier gain)

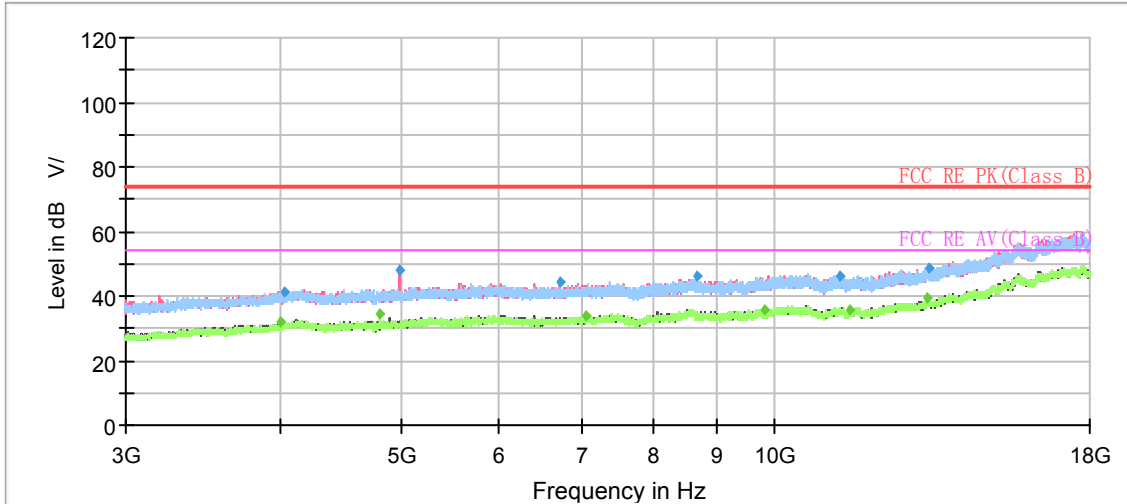

Radiates Emission from 3GHz to 18GHz

| Frequency (MHz) | MaxPeak (dB μ V/m) | Average (dB μ V/m) | Limit (dB μ V/m) | Margin (dB) | Height (cm) | Pol | Azimuth (deg) | Corr. (dB/m) |
|-----------------|------------------------|------------------------|----------------------|-------------|-------------|-----|---------------|--------------|
| 3997.000000 | --- | 31.71 | 54.00 | 22.29 | 200.0 | V | 85.0 | -4 |
| 4024.000000 | 41.25 | --- | 74.00 | 32.75 | 100.0 | V | 113.0 | -4 |
| 4803.500000 | --- | 34.32 | 54.00 | 19.68 | 100.0 | H | 329.0 | -2 |
| 4997.000000 | 47.93 | --- | 74.00 | 26.07 | 100.0 | V | 354.0 | -1 |
| 6714.000000 | 44.45 | --- | 74.00 | 29.55 | 200.0 | V | 53.0 | 0 |
| 7060.000000 | --- | 34.00 | 54.00 | 20.00 | 100.0 | H | 0.0 | 1 |
| 8669.500000 | 45.92 | --- | 74.00 | 28.08 | 200.0 | H | 194.0 | 4 |
| 9820.000000 | --- | 35.71 | 54.00 | 18.29 | 200.0 | V | 7.0 | 4 |
| 11321.000000 | 46.30 | --- | 74.00 | 27.70 | 200.0 | H | 22.0 | 6 |
| 11527.500000 | --- | 35.60 | 54.00 | 18.40 | 200.0 | V | 245.0 | 6 |
| 13326.000000 | --- | 39.15 | 54.00 | 14.85 | 200.0 | H | 314.0 | 9 |
| 13330.500000 | 48.68 | --- | 74.00 | 25.32 | 200.0 | H | 0.0 | 9 |

Remark: 1. Correction Factor = Antenna factor+ Insertion loss (cable loss + amplifier gain)

Bluetooth LE-Channel 19

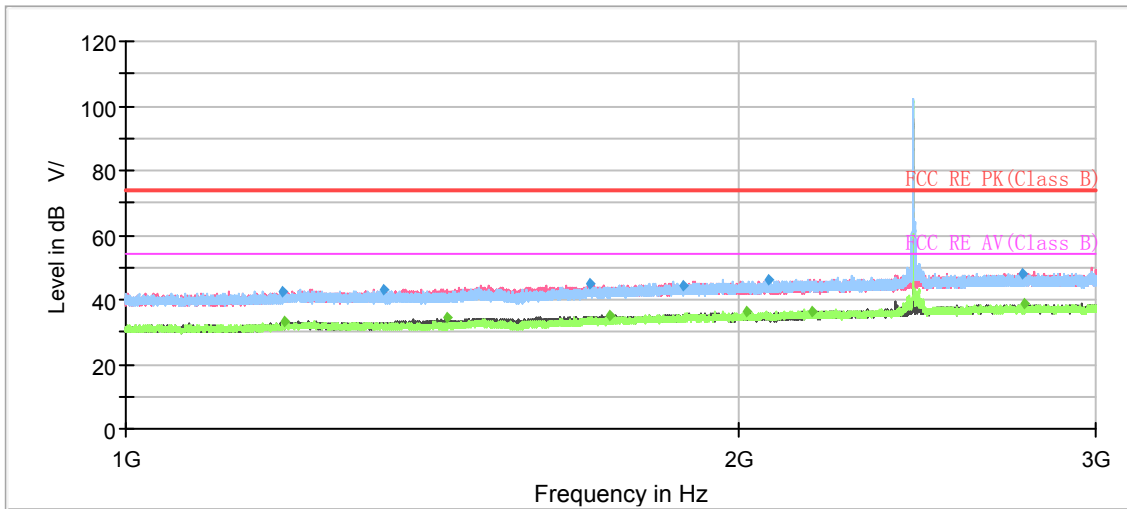

Note: The signal beyond the limit is carrier.

Radiates Emission from 1GHz to 3GHz

| Frequency (MHz) | MaxPeak (dB μ V/m) | Average (dB μ V/m) | Limit (dB μ V/m) | Margin (dB) | Height (cm) | Pol | Azimuth (deg) | Corr. (dB/m) |
|-----------------|------------------------|------------------------|----------------------|-------------|-------------|-----|---------------|--------------|
| 1194.533333 | 42.49 | --- | 74.00 | 31.51 | 100.0 | V | 184.0 | -8 |
| 1196.666667 | --- | 32.96 | 54.00 | 21.04 | 100.0 | V | 16.0 | -8 |
| 1340.533333 | 43.33 | --- | 74.00 | 30.67 | 100.0 | V | 126.0 | -7 |
| 1439.933333 | --- | 34.34 | 54.00 | 19.66 | 100.0 | V | 0.0 | -6 |
| 1691.133333 | 44.62 | --- | 74.00 | 29.38 | 200.0 | H | 75.0 | -5 |
| 1731.666667 | --- | 34.91 | 54.00 | 19.09 | 200.0 | V | 277.0 | -4 |
| 1880.466667 | 44.51 | --- | 74.00 | 29.49 | 200.0 | V | 219.0 | -4 |
| 2020.066667 | --- | 36.31 | 54.00 | 17.69 | 100.0 | H | 0.0 | -3 |
| 2069.533333 | 46.21 | --- | 74.00 | 27.79 | 200.0 | H | 68.0 | -3 |
| 2176.266667 | --- | 36.26 | 54.00 | 17.74 | 100.0 | H | 0.0 | -2 |
| 2763.266667 | 48.01 | --- | 74.00 | 25.99 | 200.0 | H | 339.0 | 1 |
| 2767.333333 | --- | 38.61 | 54.00 | 15.39 | 200.0 | H | 141.0 | 1 |

Remark: 1. Correction Factor = Antenna factor+ Insertion loss (cable loss + amplifier gain)

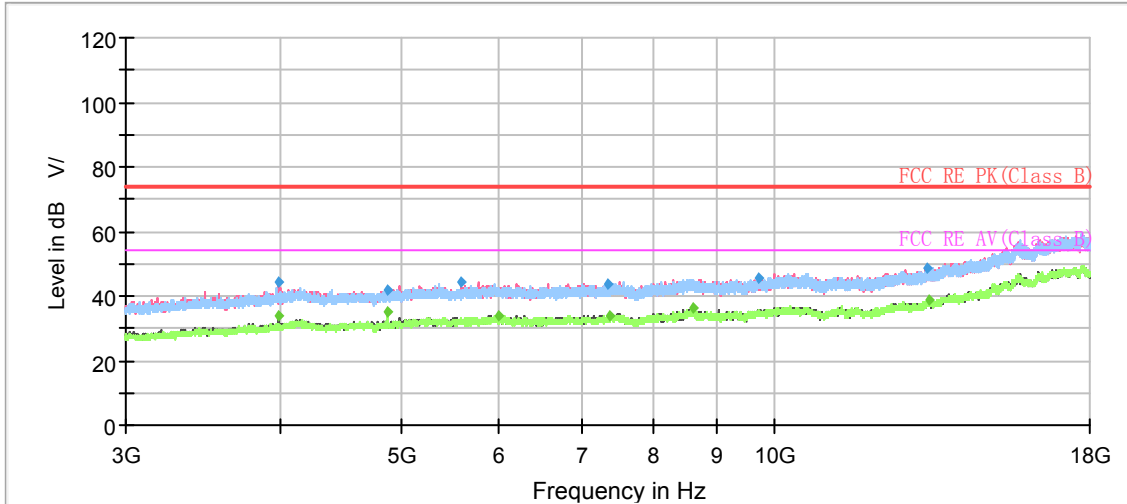

Radiates Emission from 3GHz to 18GHz

| Frequency (MHz) | MaxPeak (dB μ V/m) | Average (dB μ V/m) | Limit (dB μ V/m) | Margin (dB) | Height (cm) | Pol | Azimuth (deg) | Corr. (dB/m) |
|-----------------|------------------------|------------------------|----------------------|-------------|-------------|-----|---------------|--------------|
| 3982.500000 | --- | 33.84 | 54.00 | 20.16 | 200.0 | V | 139.0 | -4 |
| 3982.500000 | 44.29 | --- | 74.00 | 29.71 | 200.0 | V | 139.0 | -4 |
| 4879.500000 | --- | 35.04 | 54.00 | 18.96 | 100.0 | H | 0.0 | -2 |
| 4880.500000 | 41.64 | --- | 74.00 | 32.36 | 100.0 | H | 337.0 | -2 |
| 5585.000000 | 44.53 | --- | 74.00 | 29.47 | 200.0 | V | 202.0 | 0 |
| 5998.000000 | --- | 33.91 | 54.00 | 20.09 | 200.0 | H | 189.0 | 0 |
| 7358.500000 | 43.76 | --- | 74.00 | 30.24 | 200.0 | H | 290.0 | 1 |
| 7372.500000 | --- | 34.12 | 54.00 | 19.88 | 200.0 | H | 219.0 | 1 |
| 8621.000000 | --- | 36.07 | 54.00 | 17.93 | 200.0 | H | 219.0 | 4 |
| 9741.000000 | 45.57 | --- | 74.00 | 28.43 | 100.0 | H | 171.0 | 4 |
| 13321.500000 | 48.47 | --- | 74.00 | 25.53 | 200.0 | H | 1.0 | 9 |
| 13344.500000 | --- | 38.91 | 54.00 | 15.09 | 200.0 | H | 141.0 | 9 |

Remark: 1. Correction Factor = Antenna factor+ Insertion loss (cable loss + amplifier gain)

Bluetooth LE-Channel 39

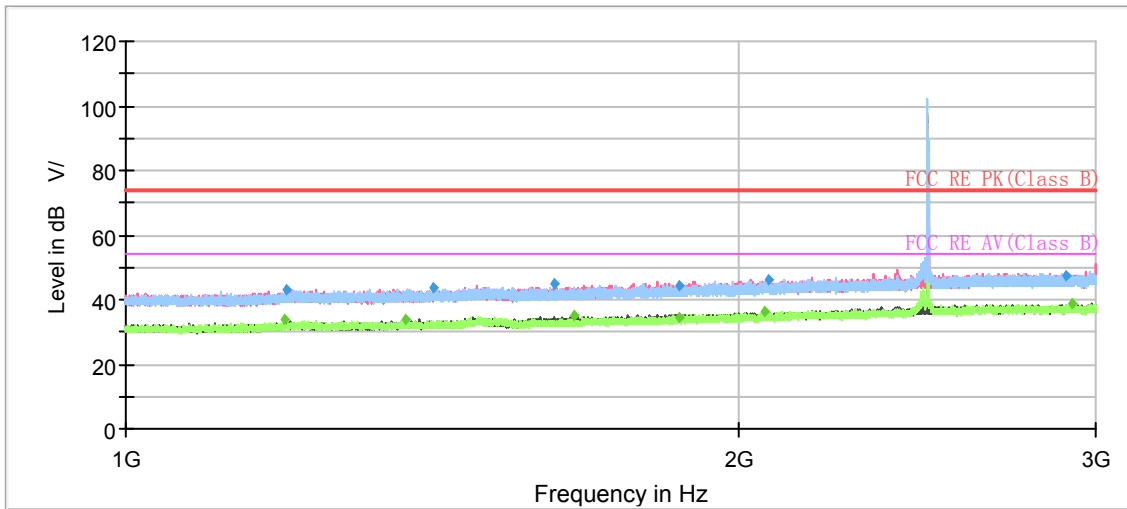

Note: The signal beyond the limit is carrier.

Radiates Emission from 1GHz to 3GHz

| Frequency (MHz) | MaxPeak (dB μ V/m) | Average (dB μ V/m) | Limit (dB μ V/m) | Margin (dB) | Height (cm) | Pol | Azimuth (deg) | Corr. (dB/m) |
|-----------------|------------------------|------------------------|----------------------|-------------|-------------|-----|---------------|--------------|
| 1196.733333 | --- | 34.11 | 54.00 | 19.89 | 100.0 | V | 181.0 | -8 |
| 1199.266667 | 42.98 | --- | 74.00 | 31.02 | 100.0 | V | 0.0 | -8 |
| 1371.800000 | --- | 33.81 | 54.00 | 20.19 | 200.0 | V | 75.0 | -7 |
| 1418.133333 | 43.40 | --- | 74.00 | 30.60 | 200.0 | H | 179.0 | -6 |
| 1623.866667 | 44.69 | --- | 74.00 | 29.31 | 200.0 | V | 225.0 | -5 |
| 1662.933333 | --- | 34.84 | 54.00 | 19.16 | 200.0 | V | 0.0 | -5 |
| 1873.333333 | 44.25 | --- | 74.00 | 29.75 | 100.0 | V | 293.0 | -4 |
| 1873.466667 | --- | 34.57 | 54.00 | 19.43 | 100.0 | V | 134.0 | -4 |
| 2061.466667 | --- | 36.18 | 54.00 | 17.82 | 100.0 | V | 173.0 | -3 |
| 2068.800000 | 46.12 | --- | 74.00 | 27.88 | 200.0 | V | 75.0 | -3 |
| 2901.200000 | 47.17 | --- | 74.00 | 26.83 | 100.0 | V | 248.0 | 1 |
| 2923.400000 | --- | 38.55 | 54.00 | 15.45 | 100.0 | H | 165.0 | 1 |

Remark: 1. Correction Factor = Antenna factor+ Insertion loss (cable loss + amplifier gain)

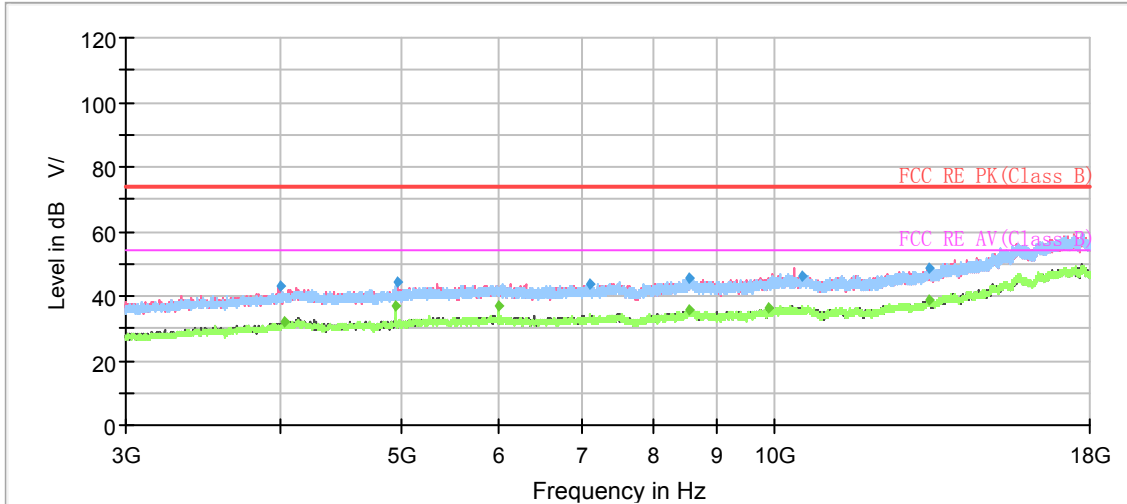

Radiates Emission from 3GHz to 18GHz

| Frequency (MHz) | MaxPeak (dB μ V/m) | Average (dB μ V/m) | Limit (dB μ V/m) | Margin (dB) | Height (cm) | Pol | Azimuth (deg) | Corr. (dB/m) |
|-----------------|------------------------|------------------------|----------------------|-------------|-------------|-----|---------------|--------------|
| 3999.500000 | 43.01 | --- | 74.00 | 30.99 | 200.0 | V | 199.0 | -4 |
| 4028.000000 | --- | 31.83 | 54.00 | 22.17 | 100.0 | V | 97.0 | -4 |
| 4960.000000 | --- | 36.71 | 54.00 | 17.29 | 100.0 | H | 345.0 | -2 |
| 4978.000000 | 44.54 | --- | 74.00 | 29.46 | 200.0 | V | 144.0 | -1 |
| 5998.000000 | --- | 37.22 | 54.00 | 16.78 | 200.0 | H | 162.0 | 0 |
| 7098.000000 | 43.69 | --- | 74.00 | 30.31 | 200.0 | H | 170.0 | 1 |
| 8532.000000 | --- | 35.59 | 54.00 | 18.41 | 100.0 | V | 329.0 | 4 |
| 8558.500000 | 45.66 | --- | 74.00 | 28.34 | 100.0 | H | 52.0 | 4 |
| 9895.000000 | --- | 36.04 | 54.00 | 17.96 | 200.0 | V | 49.0 | 4 |
| 10543.500000 | 46.28 | --- | 74.00 | 27.72 | 100.0 | V | 227.0 | 5 |
| 13335.000000 | 48.51 | --- | 74.00 | 25.49 | 200.0 | H | 1.0 | 9 |
| 13345.500000 | --- | 38.97 | 54.00 | 15.03 | 200.0 | H | 276.0 | 9 |

Remark: 1. Correction Factor = Antenna factor+ Insertion loss (cable loss + amplifier gain)



During the test, the Radiates Emission from 18GHz to 26.5GHz was performed in all modes with all channels, 802.11g CH6 and Bluetooth LE-Channel 0 are selected as the worst condition. The test data of the worst-case condition was recorded in this report.

WIFI 2.4G:

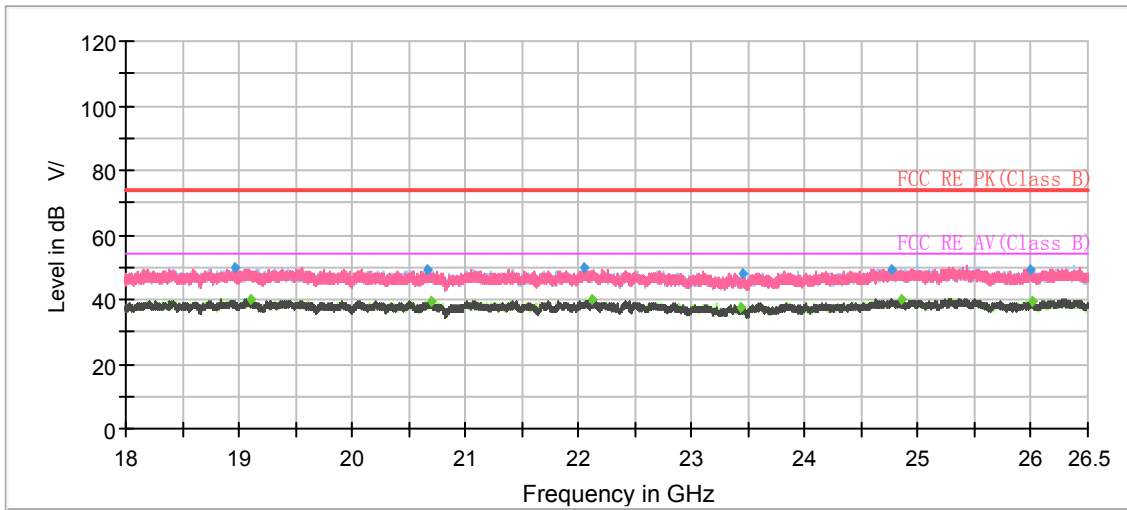

Radiates Emission from 18GHz to 26.5GHz

| Frequency (MHz) | MaxPeak (dB μ V/m) | Average (dB μ V/m) | Limit (dB μ V/m) | Margin (dB) | Height (cm) | PoI | Azimuth (deg) | Corr. (dB/m) |
|-----------------|------------------------|------------------------|----------------------|-------------|-------------|-----|---------------|--------------|
| 18963.05 | 49.89 | --- | 74.00 | 24.11 | 200.0 | H | 351.00 | -1 |
| 19103.30 | --- | 40.06 | 54.00 | 13.94 | 100.0 | H | 263.00 | -1 |
| 20670.70 | 49.08 | --- | 74.00 | 24.92 | 100.0 | V | 211.00 | 0 |
| 20705.83 | --- | 39.37 | 54.00 | 14.63 | 200.0 | H | 21.00 | 0 |
| 22049.12 | 49.65 | --- | 74.00 | 24.35 | 200.0 | V | 187.00 | 1 |
| 22121.08 | --- | 39.92 | 54.00 | 14.08 | 200.0 | V | 202.00 | 1 |
| 23428.67 | --- | 37.79 | 54.00 | 16.21 | 100.0 | H | 233.00 | 2 |
| 23449.35 | 47.96 | --- | 74.00 | 26.04 | 200.0 | V | 292.00 | 2 |
| 24760.62 | 49.49 | --- | 74.00 | 24.51 | 200.0 | H | 150.00 | 3 |
| 24844.77 | --- | 40.07 | 54.00 | 13.93 | 200.0 | H | 188.00 | 3 |
| 26000.20 | 49.33 | --- | 74.00 | 24.67 | 200.0 | H | 173.00 | 3 |
| 26000.77 | --- | 39.66 | 54.00 | 14.34 | 200.0 | V | 307.00 | 3 |

Remark: 1. Correction Factor = Antenna factor+ Insertion loss (cable loss + amplifier gain)

Bluetooth LE:

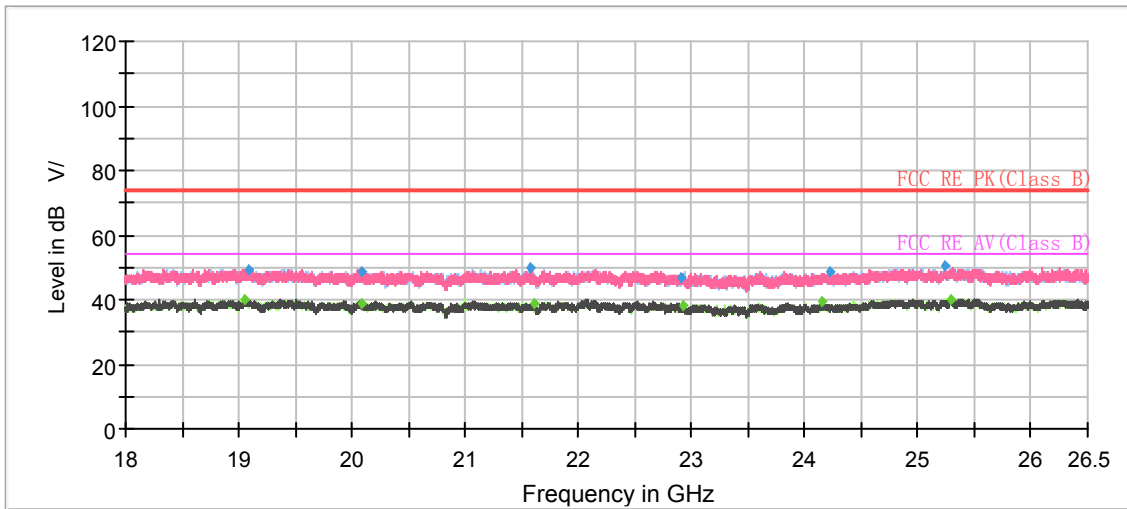

Radiates Emission from 18GHz to 26.5GHz

| Frequency (MHz) | MaxPeak (dB μ V/m) | Average (dB μ V/m) | Limit (dB μ V/m) | Margin (dB) | Height (cm) | Pol | Azimuth (deg) | Corr. (dB/m) |
|-----------------|------------------------|------------------------|----------------------|-------------|-------------|-----|---------------|--------------|
| 19054.28 | --- | 39.88 | 54.00 | 14.12 | 200.0 | V | 201.00 | -1 |
| 19094.52 | 49.51 | --- | 74.00 | 24.49 | 200.0 | H | 32.00 | -1 |
| 20082.78 | --- | 39.07 | 54.00 | 14.93 | 100.0 | V | 105.00 | -1 |
| 20083.07 | 48.60 | --- | 74.00 | 25.40 | 200.0 | H | 243.00 | -1 |
| 21577.37 | 50.00 | --- | 74.00 | 24.00 | 100.0 | V | 8.00 | 0 |
| 21604.57 | --- | 38.74 | 54.00 | 15.26 | 200.0 | V | 61.00 | 1 |
| 22902.23 | 47.03 | --- | 74.00 | 26.97 | 100.0 | H | 300.00 | 2 |
| 22921.22 | --- | 38.35 | 54.00 | 15.65 | 200.0 | V | 352.00 | 2 |
| 24157.97 | --- | 39.09 | 54.00 | 14.91 | 100.0 | V | 196.00 | 2 |
| 24217.47 | 48.48 | --- | 74.00 | 25.52 | 200.0 | V | 352.00 | 2 |
| 25236.05 | 50.46 | --- | 74.00 | 23.54 | 100.0 | H | 247.00 | 3 |
| 25284.22 | --- | 40.19 | 54.00 | 13.81 | 100.0 | V | 0.00 | 3 |

Remark: 1. Correction Factor = Antenna factor+ Insertion loss (cable loss + amplifier gain)

5.7. Conducted Emission

Ambient condition

| Temperature | Relative humidity | Pressure |
|-------------|-------------------|----------|
| 23°C ~25°C | 45%~50% | 101.5kPa |

Methods of Measurement

The EUT is placed on a non-metallic table of 80cm height above the horizontal metal reference ground plane. During the test, the EUT was operating in its typical mode. The test method is according to ANSI C63.10. Connect the AC power line of the EUT to the L.I.S.N. Use EMI receiver to detect the average and Quasi-peak value. RBW is set to 9 kHz, VBW is set to 30kHz.

The measurement result should include both L line and N line.

The test is in transmitting mode.

Test Setup

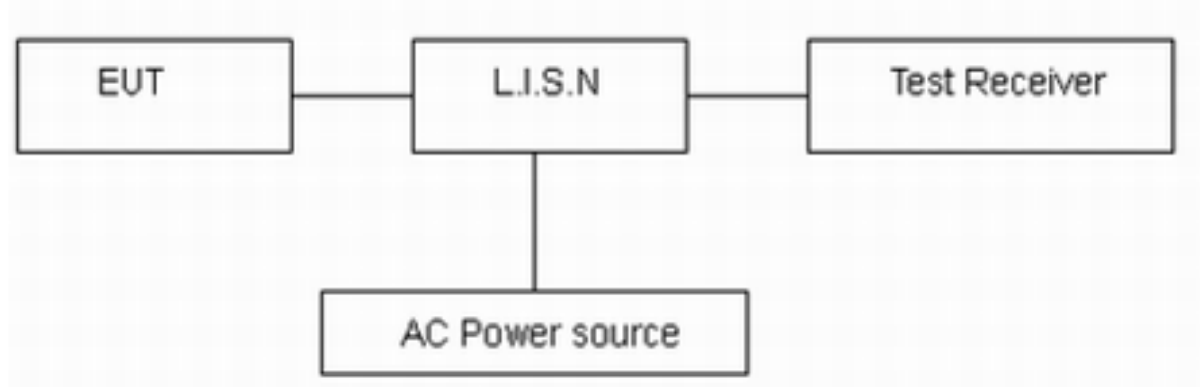

Note: AC Power source is used to change the voltage 110V/60Hz.

Limits

| Frequency (MHz) | Conducted Limits(dBμV) | |
|-----------------|------------------------|-----------|
| | Quasi-peak | Average |
| 0.15 - 0.5 | 66 to 56 * | 56 to 46* |
| 0.5 - 5 | 56 | 46 |
| 5 - 30 | 60 | 50 |

*: Decreases with the logarithm of the frequency.

Measurement Uncertainty

The assessed measurement uncertainty to ensure 95% confidence level for the normal distribution is with the coverage factor $k = 1.96$, $U = 2.69$ dB.

Test Results:

Following plots, Blue trace uses the peak detection and Green trace uses the average detection. During the test, the Conducted Emission was performed in all modes (WIFI 2.4G /Bluetooth LE) with all channels, 802.11g CH6 and Bluetooth LE-Channel 0 are selected as the worst condition. The test data of the worst-case condition was recorded in this report.

WIFI 2.4G:

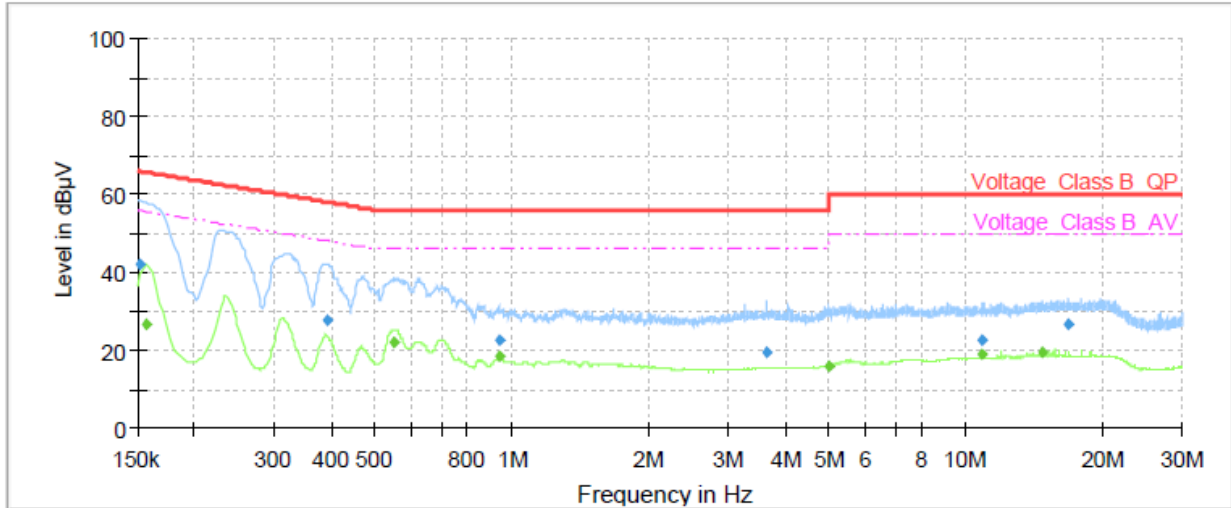

| Frequency (MHz) | QuasiPeak (dBµV) | Average (dBµV) | Limit (dBµV) | Margin (dB) | Meas. Time (ms) | Bandwidth (kHz) | Line | Filter | Corr. (dB) |
|-----------------|------------------|----------------|--------------|-------------|-----------------|-----------------|------|--------|------------|
| 0.15 | 41.95 | --- | 65.88 | 23.93 | 70.0 | 9.000 | L1 | ON | 21 |
| 0.16 | --- | 26.56 | 55.63 | 29.07 | 70.0 | 9.000 | L1 | ON | 21 |
| 0.39 | 27.93 | --- | 58.00 | 30.07 | 70.0 | 9.000 | L1 | ON | 20 |
| 0.55 | --- | 21.96 | 46.00 | 24.04 | 70.0 | 9.000 | L1 | ON | 20 |
| 0.94 | 22.65 | --- | 56.00 | 33.35 | 70.0 | 9.000 | L1 | ON | 20 |
| 0.94 | --- | 18.22 | 46.00 | 27.78 | 70.0 | 9.000 | L1 | ON | 20 |
| 3.64 | 19.34 | --- | 56.00 | 36.66 | 70.0 | 9.000 | L1 | ON | 19 |
| 5.00 | --- | 15.95 | 46.00 | 30.05 | 70.0 | 9.000 | L1 | ON | 19 |
| 10.89 | --- | 18.89 | 50.00 | 31.11 | 70.0 | 9.000 | L1 | ON | 20 |
| 10.90 | 22.59 | --- | 60.00 | 37.41 | 70.0 | 9.000 | L1 | ON | 20 |
| 14.70 | --- | 19.69 | 50.00 | 30.31 | 70.0 | 9.000 | L1 | ON | 20 |
| 16.89 | 26.68 | --- | 60.00 | 33.32 | 70.0 | 9.000 | L1 | ON | 20 |

Remark: Correct factor=cable loss + LISN factor

L line Conducted Emission from 150 KHz to 30 MHz

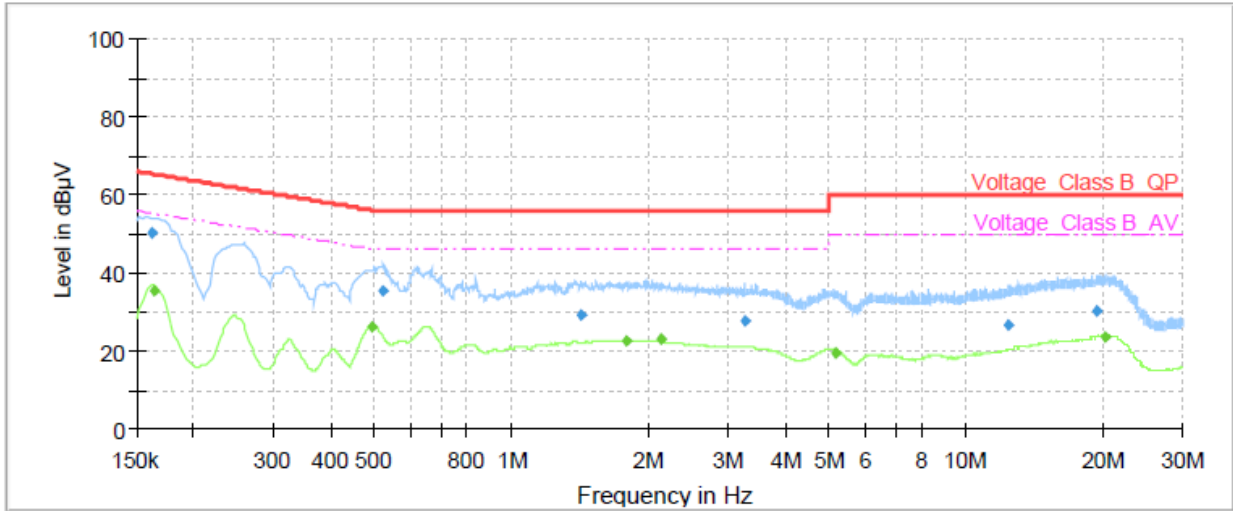

| Frequency (MHz) | QuasiPeak (dBµV) | Average (dBµV) | Limit (dBµV) | Margin (dB) | Meas. Time (ms) | Bandwidth (kHz) | Line | Filter | Corr. (dB) |
|-----------------|------------------|----------------|--------------|-------------|-----------------|-----------------|------|--------|------------|
| 0.16 | 50.13 | --- | 65.40 | 15.27 | 70.0 | 9.000 | N | ON | 21 |
| 0.16 | --- | 35.41 | 55.28 | 19.87 | 70.0 | 9.000 | N | ON | 21 |
| 0.49 | --- | 26.30 | 46.10 | 19.80 | 70.0 | 9.000 | N | ON | 20 |
| 0.52 | 35.35 | --- | 56.00 | 20.65 | 70.0 | 9.000 | N | ON | 20 |
| 1.42 | 29.46 | --- | 56.00 | 26.54 | 70.0 | 9.000 | N | ON | 20 |
| 1.78 | --- | 22.70 | 46.00 | 23.30 | 70.0 | 9.000 | N | ON | 20 |
| 2.14 | --- | 22.84 | 46.00 | 23.16 | 70.0 | 9.000 | N | ON | 20 |
| 3.25 | 27.56 | --- | 56.00 | 28.44 | 70.0 | 9.000 | N | ON | 19 |
| 5.17 | --- | 19.64 | 50.00 | 30.36 | 70.0 | 9.000 | N | ON | 19 |
| 12.37 | 26.86 | --- | 60.00 | 33.14 | 70.0 | 9.000 | N | ON | 20 |
| 19.44 | 30.19 | --- | 60.00 | 29.81 | 70.0 | 9.000 | N | ON | 20 |
| 20.21 | --- | 23.73 | 50.00 | 26.27 | 70.0 | 9.000 | N | ON | 20 |

Remark: Correct factor=cable loss + LISN factor

N line Conducted Emission from 150 KHz to 30 MHz

Bluetooth LE:

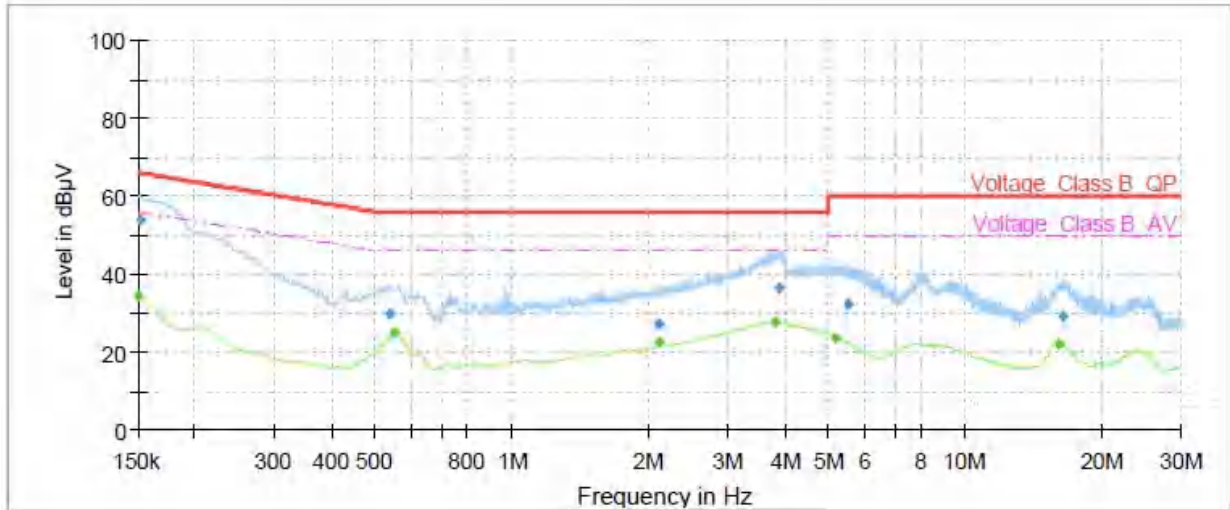

| Frequency (MHz) | QuasiPeak (dBµV) | Average (dBµV) | Limit (dBµV) | Margin (dB) | Meas. Time (ms) | Bandwidth (kHz) | Line | Filter | Corr. (dB) |
|-----------------|------------------|----------------|--------------|-------------|-----------------|-----------------|------|--------|------------|
| 0.15 | --- | 34.51 | 56.00 | 21.49 | 70.0 | 9.000 | L1 | ON | 21 |
| 0.15 | 53.91 | --- | 65.88 | 11.97 | 70.0 | 9.000 | L1 | ON | 21 |
| 0.54 | 29.75 | --- | 56.00 | 26.25 | 70.0 | 9.000 | L1 | ON | 20 |
| 0.55 | --- | 25.07 | 46.00 | 20.93 | 70.0 | 9.000 | L1 | ON | 20 |
| 2.11 | --- | 22.76 | 46.00 | 23.24 | 70.0 | 9.000 | L1 | ON | 20 |
| 2.12 | 27.13 | --- | 56.00 | 28.87 | 70.0 | 9.000 | L1 | ON | 20 |
| 3.80 | --- | 27.95 | 46.00 | 18.05 | 70.0 | 9.000 | L1 | ON | 19 |
| 3.89 | 36.59 | --- | 56.00 | 19.41 | 70.0 | 9.000 | L1 | ON | 19 |
| 5.16 | --- | 23.71 | 50.00 | 26.29 | 70.0 | 9.000 | L1 | ON | 19 |
| 5.50 | 32.32 | --- | 60.00 | 27.68 | 70.0 | 9.000 | L1 | ON | 19 |
| 16.05 | --- | 22.12 | 50.00 | 27.88 | 70.0 | 9.000 | L1 | ON | 20 |
| 16.49 | 29.22 | --- | 60.00 | 30.78 | 70.0 | 9.000 | L1 | ON | 20 |

Remark: Correct factor=cable loss + LISN factor

L line Conducted Emission from 150 KHz to 30 MHz

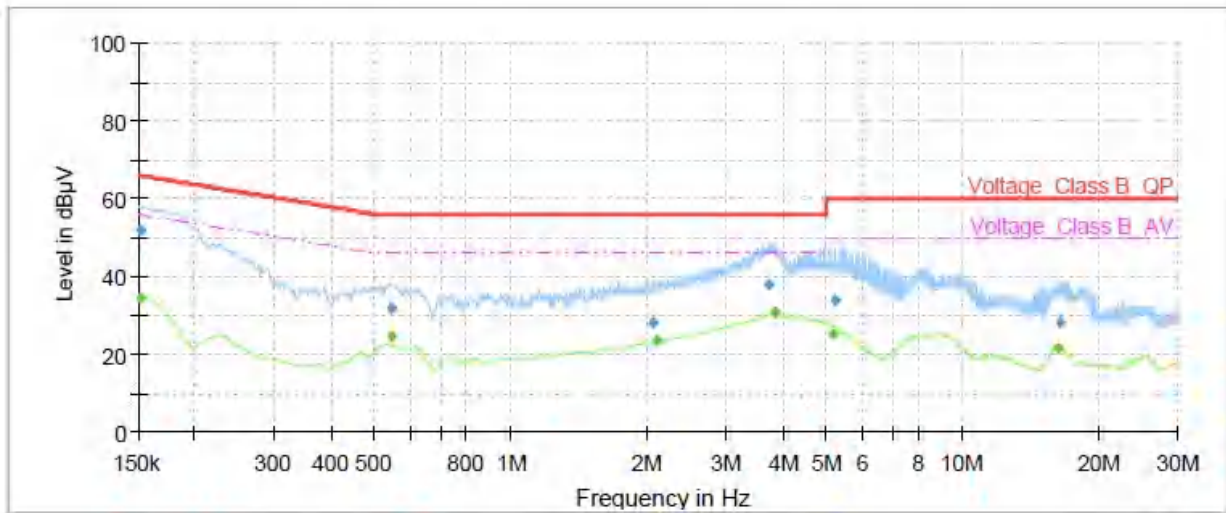

| Frequency (MHz) | QuasiPeak (dBµV) | Average (dBµV) | Limit (dBµV) | Margin (dB) | Meas. Time (ms) | Bandwidth (kHz) | Line | Filter | Corr. (dB) |
|-----------------|------------------|----------------|--------------|-------------|-----------------|-----------------|------|--------|------------|
| 0.15 | --- | 34.40 | 55.88 | 21.48 | 70.0 | 9.000 | N | ON | 21 |
| 0.15 | 51.82 | --- | 65.88 | 14.06 | 70.0 | 9.000 | N | ON | 21 |
| 0.54 | 31.59 | --- | 56.00 | 24.41 | 70.0 | 9.000 | N | ON | 20 |
| 0.55 | --- | 24.69 | 46.00 | 21.31 | 70.0 | 9.000 | N | ON | 20 |
| 2.06 | 28.08 | --- | 56.00 | 27.92 | 70.0 | 9.000 | N | ON | 20 |
| 2.12 | --- | 23.42 | 46.00 | 22.58 | 70.0 | 9.000 | N | ON | 20 |
| 3.71 | 38.01 | --- | 56.00 | 17.99 | 70.0 | 9.000 | N | ON | 19 |
| 3.84 | --- | 30.54 | 46.00 | 15.46 | 70.0 | 9.000 | N | ON | 19 |
| 5.14 | --- | 25.06 | 50.00 | 24.94 | 70.0 | 9.000 | N | ON | 19 |
| 5.23 | 33.97 | --- | 60.00 | 26.03 | 70.0 | 9.000 | N | ON | 19 |
| 16.23 | --- | 21.76 | 50.00 | 28.24 | 70.0 | 9.000 | N | ON | 20 |
| 16.40 | 28.19 | --- | 60.00 | 31.81 | 70.0 | 9.000 | N | ON | 20 |

Remark: Correct factor=cable loss + LISN factor

N line Conducted Emission from 150 KHz to 30 MHz



6. Main Test Instruments

| Name | Manufacturer | Type | Serial Number | Calibration Date | Expiration Date |
|--------------------------|--------------|---------|---------------|------------------|-----------------|
| EMI Test Receiver | R&S | ESCI7 | 100936 | 2021-12-12 | 2022-12-11 |
| Signal Analyzer | R&S | FSV40 | 100815 | 2021-05-15 | 2022-05-14 |
| TRILOG Broadband Antenna | SCHWARZBECK | 9163 | 1023 | 2021-06-07 | 2024-06-06 |
| Horn Antenna | R&S | HF907 | 102723 | 2021-07-26 | 2024-07-25 |
| Horn Antenna | ETS-Lindgren | 3160-09 | 00102643 | 2020-10-10 | 2023-10-09 |
| Software | R&S | EMC32 | 9.26.01 | / | / |
| Artificial main network | R&S | ENV216 | 101171 | 2020-12-13 | 2022-12-12 |
| EMI Test Receiver | R&S | ESR | 101667 | 2021-05-15 | 2022-05-14 |
| Software | R&S | EMC32 | 10.35.10 | / | / |
| Spectrum Analyzer | KEYSIGHT | N9020A | MY54420163 | 2021-12-12 | 2022-12-11 |
| Power probe | R&S | NRP18S | 101954 | 2021-05-15 | 2022-05-14 |
| Climate Chamber | ESPEC | SU-242 | 93000506 | 2021-12-12 | 2022-12-11 |

*****END OF REPORT*****



ANNEX A: The EUT Appearance

The EUT Appearance are submitted separately.



ANNEX B: Test Setup Photos

The Test Setup Photos are submitted separately.



ANNEX C: Product Change Description

The Product Change Description are submitted separately.