



RF TEST REPORT

Applicant Honor Device Co., Ltd.
FCC ID 2AYGCTFY-LX1
Product Smart Phone
Model TFY-LX1
Report No. R2201A0039-R2V1
Issue Date March 2, 2022

TA Technology (Shanghai) Co., Ltd. tested the above equipment in accordance with the requirements in **FCC CFR47 Part 2 (2020)/ FCC CFR 47 Part 24E (2020)**. The test results show that the equipment tested is capable of demonstrating compliance with the requirements as documented in this report.

Prepared by: Peng Tao

Approved by: Kai Xu

TA Technology (Shanghai) Co., Ltd.

No.145, Jintang Rd, Tangzhen Industry Park, Pudong Shanghai, China

TEL: +86-021-50791141/2/3

FAX: +86-021-50791141/2/3-8000

TABLE OF CONTENT

1. Test Laboratory	5
1.1. Notes of the test report.....	5
1.2. Test facility.....	5
1.3. Testing Location	5
2. General Description of Equipment under Test.....	6
2.1. Applicant and Manufacturer Information	6
2.2. General information	6
3. Applied Standards.....	8
4. Test Configuration.....	9
5. Test Case Results.....	10
5.1. RF Power Output and Effective Isotropic Radiated Power	10
5.2. Occupied Bandwidth	12
5.3. Band Edge Compliance.....	16
5.4. Peak-to-Average Power Ratio (PAPR)	19
5.5. Frequency Stability.....	21
5.6. Spurious Emissions at Antenna Terminals	24
5.7. Radiates Spurious Emission	27
6. Main Test Instruments	32
ANNEX A: The EUT Appearance.....	33
ANNEX B: Test Setup Photos	34
ANNEX C: Product Change Description	35



Version	Revision description	Issue Date
Rev.0	Initial issue of report.	February 11, 2022
Rev.1	Update description in Page 4.	March 2, 2022

Note: This revised report (Report No. R2201A0039-R2V1) supersedes and replaces the previously issued report (Report No. R2201A0039-R2). Please discard or destroy the previously issued report and dispose of it accordingly.

Summary of measurement results

No.	Test Case	Clause in FCC rules	Verdict
1	RF Power Output and Effective Isotropic Radiated Power	2.1046 24.232(c)	PASS
2	Occupied Bandwidth	2.1049	PASS
3	Band Edge Compliance	2.1051 /24.238(a)	PASS
4	Peak-to-Average Power Ratio	24.232/KDB 971168 D01(5.7)	PASS
5	Frequency Stability	2.1055 / 24.235	PASS
6	Spurious Emissions at Antenna Terminals	2.1051 / 24.238(a)	PASS
7	Radiates Spurious Emission	2.1053 / 24.238(a)	PASS

Date of Testing: January 13, 2022 ~ January 27, 2022

Date of Sample Received: January 10, 2022

Note: PASS: The EUT complies with the essential requirements in the standard.

FAIL: The EUT does not comply with the essential requirements in the standard.

All indications of Pass/Fail in this report are opinions expressed by TA Technology (Shanghai) Co., Ltd. based on interpretations and/or observations of test results. Measurement Uncertainties were not taken into account and are published for informational purposes only.

TFY-LX1 (Report No.: R2201A0039-R2V1) is a variant model of TFY-LX3 (Report No.: R2201A0036-R2V1). Test values duplicated from Original for variant. There is only tested Radiates Spurious Emission, and did not worsen, so they were not recorded in the report. The difference between model TFY-LX3 and model TFY-LX1 is show in the below table:

Difference	Model	TFY-LX3	TFY-LX1
Licensed Frequency	LTE BAND	B2/4/5/7/13/26/38/66 Not support CA	B5/B7 Support CA
	UMTS BAND	B2/B4/B5	B2/B5
	Antenna	The antenna matching and routing are the same. The frequency is different.	The antenna matching and routing are the same. The frequency is different.
Unlicensed Frequency	NFC	Not support	Support. Add NFC functionality via hardware
	Antenna	BT+Wi-Fi+GPS antenna	BT+Wi-Fi+GPS Add NFC antenna
RF	RF circuit	The RF circuit of the same frequency is the same.	The RF circuit of the same frequency is the same. The different frequency changed by hardware and some RF parameters. Changes are followed: 1. delete B4/B13/B38/B66 SAWS, Diplexer, switch, LNA and RF matching components. 2. LTE bands support 64QAM.

The detailed product change description please refers to the ***Difference Declaration Letter***.

1. Test Laboratory

1.1. Notes of the test report

This report shall not be reproduced in full or partial, without the written approval of **TA technology (shanghai) co., Ltd.** The results documented in this report apply only to the tested sample, under the conditions and modes of operation as described herein. Measurement Uncertainties were not taken into account and are published for informational purposes only. This report is written to support regulatory compliance of the applicable standards stated above.

1.2. Test facility

FCC (Designation number: CN1179, Test Firm Registration Number: 446626)

TA Technology (Shanghai) Co., Ltd. has been listed on the US Federal Communications Commission list of test facilities recognized to perform measurements.

A2LA (Certificate Number: 3857.01)

TA Technology (Shanghai) Co., Ltd. has been listed by American Association for Laboratory Accreditation to perform measurement.

1.3. Testing Location

Company: TA Technology (Shanghai) Co., Ltd.
Address: No.145, Jintang Rd, Tangzhen Industry Park, Pudong
City: Shanghai
Post code: 201201
Country: P. R. China
Contact: Xu Kai
Telephone: +86-021-50791141/2/3
Fax: +86-021-50791141/2/3-8000
Website: <http://www.ta-shanghai.com>
E-mail: xukai@ta-shanghai.com

2. General Description of Equipment under Test

2.1. Applicant and Manufacturer Information

Applicant	Honor Device Co., Ltd.
Applicant address	Shum Yip Sky Park, No. 8089, Hongli West Road, Shenzhen, China
Manufacturer	Honor Device Co., Ltd.
Manufacturer address	Shum Yip Sky Park, No. 8089, Hongli West Road, Shenzhen, China

2.2. General information

EUT Description			
Model	TFY-LX1		
SN	A7NX011C22000163		
Hardware Version	HL6TFYM		
Software Version	4.2.0.35(C900E14R1P1)		
Power Supply	Battery / AC adapter		
Antenna Type	Internal Antenna		
Antenna Gain	Band	Main Antenna	Sencond Antenna
	GSM1900	-1.60 dBi	0.11 dBi
	WCDMA Band II	-1.60 dBi	0.11 dBi
Test Mode(s)	GSM1900; WCDMA Band II;		
Test Modulation	(GSM/GPRS)GMSK, (EGPRS) GMSK/ 8PSK; (WCDMA) BPSK, QPSK;		
GPRS Multislot Class	12		
EGPRS Multislot Class	12		
HSDPA UE Category	14		
HSUPA UE Category	6		
DC-HSDPA UE Category	24		
Maximum E.I.R.P	GSM 1900:	30.02 dBm	
	WCDMA Band II:	23.44 dBm	
Rated Power Supply Voltage	3.87V		
Operating Voltage	Minimum: 3.60V Maximum: 4.45V		
Operating Temperature	Lowest: 0°C Highest: 35°C		
Testing Temperature	Lowest: 0°C Highest: 35°C		
Operating Frequency Range(s)	Band	Tx (MHz)	Rx (MHz)
	GSM1900	1850 ~ 1910	1930 ~ 1990
	WCDMA Band II	1850 ~ 1910	1930 ~ 1990
EUT Accessory			
Accessory	Model	Manufacture	No.
Adapter	HW-100225E00	Honor Device Co., Ltd. (Manufacturer:Huntkey)	1
	HW-100225U00	Honor Device Co., Ltd.	2



		(Manufacturer:Huntkey)	
	HW-100225B00	Honor Device Co., Ltd. (Manufacturer:Huntkey)	3
	HN-100225E00	Honor Device Co., Ltd. (Manufacturer: Salcomp)	4
	HN-100225U00	Honor Device Co., Ltd. (Manufacturer: Salcomp)	5
Battery	HB416492EFW	Honor Device Co., Ltd. (Manufacturer: Sunwoda Electronic Co.,LTD)	1
	HB416492EFW	Honor Device Co., Ltd. (Manufacturer:NVT)	2
Earphone	MEND1532B528A11	Jiangxi Lianchuang Hongsheng Electronic Co., LTD.	1
	1293-3283-3.5mm-339	BOLUO COUNTY QUANCHENG ELECTRONIC CO.,LTD.	2
	EPAB542-2WH05-DH	FOXCONN INTERCONNECT TECHNOLOGY LIMITED	3
USB Cable	RY0002	NingBo Broad Telecommunication Co., Ltd.	1
	AU2-CRO013HF	Freeport Resources Enterprises Corp.	2
	2120-00001-0	MING JI ELECTRONICS CO., LTD.	3
	L125UC007-CS-H	LUXSHARE PRECISION INDUSTRY CO., LTD.	4
	CUDU01B-HC451-EH	FOXCONN INTERCONNECT TECHNOLOGY LIMITED	5
<p>Note: 1. The EUT is sent from the applicant to TA and the information of the EUT is declared by the applicant.</p> <p>2. There are more than one Adapter, Battery, Earphone and USB Cable, each one should be applied throughout the compliance test respectively, however, only the worst case (Adapter 1, Battery 2, Earphone 1 and USB Cable 3) will be recorded in this report.</p>			

3. Applied Standards

According to the specifications of the manufacturer, it must comply with the requirements of the following standards:

Test standards:

FCC CFR 47 Part 24E (2020)

FCC CFR47 Part 2 (2020)

Reference standard:

ANSI C63.26 (2015)

KDB 971168 D01 Power Meas License Digital Systems v03r01

4. Test Configuration

Radiated measurements are performed by rotating the EUT in three different orthogonal test planes. EUT stand-up position (Z axis), lie-down position (X, Y axis). Receiver antenna polarization (horizontal and vertical), the worst emission was found in position (X axis, horizontal polarization for GSM/WCDMA Band (Main Antenna); Z axis, horizontal polarization for GSM/WCDMA Band (Second Antenna); and the worst case was recorded.

All mode and data rates and positions and RB size and modulations were investigated. Subsequently, only the worst case emissions are reported. The following testing in GSM/WCDMA is set based on the maximum RF Output Power.

Test modes are chosen to be reported as the worst case configuration below:

Test items	Modes/Modulation	
	GSM 1900	WCDMA Band II
RF Power Output and Effective Isotropic Radiated Power	GSM GPRS EGPRS	RMC/AMR HSDPA/HSUPA DC-HSDPA
Occupied Bandwidth	GSM GPRS(1Tx slot) EGPRS(1Tx slot)	RMC
Band Edge Compliance	GSM GPRS(1Tx slot) EGPRS(1Tx slot)	RMC
Peak-to-Average Power Ratio	GSM GPRS(1Tx slot) EGPRS(1Tx slot)	RMC
Frequency Stability	GSM GPRS(1Tx slot) EGPRS(1Tx slot)	RMC
Spurious Emissions at Antenna Terminals	GSM	RMC
Radiates Spurious Emission	GSM	RMC

5. Test Case Results

5.1.RF Power Output and Effective Isotropic Radiated Power

Ambient condition

Temperature	Relative humidity	Pressure
23°C ~25°C	45%~50%	101.5kPa

Methods of Measurement

During the process of the testing, The EUT was connected to the Base Station Simulator with a known loss. The EUT is controlled by the Base Station Simulator test set to ensure max power transmission with proper modulation.

ERP can then be calculated as follows:

$$\text{EIRP (dBm)} = \text{Output Power (dBm)} - \text{Losses (dB)} + \text{Antenna Gain (dBi)}$$

where:dBd refers to gain relative to an ideal dipole.

$$\text{EIRP (dBm)} = \text{ERP (dBm)} + 2.15 \text{ (dB.)}$$

Test Setup

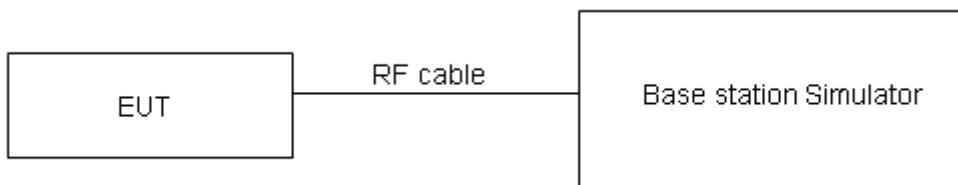

Limits

No specific RF power output requirements in part 2.1046.

Rule Part 24.232(c) Mobile and portable stations are limited to 2 watts EIRP.

Rule Part 24.232(e) Peak transmit power must be measured over any interval of continuous transmission using instrumentation calibrated in terms of an rms-equivalent voltage.

Limit	≤ 2 W (33 dBm)
-------	----------------

Measurement Uncertainty

The assessed measurement uncertainty to ensure 95% confidence level for the normal distribution is with the coverage factor $k = 2$, $U = 0.4$ dB for RF power output, $k = 2$, $U = 1.19$ dB for EIRP.

Test Results

GSM 1900		Maximum Output Power (dBm)			Main Antenna EIRP (dBm)			Second Antenna EIRP (dBm)		
		Channel 512	Channel 661	Channel 810	Channel 512	Channel 661	Channel 810	Channel 512	Channel 661	Channel 810
		1850.2 (MHz)	1880 (MHz)	1909.8 (MHz)	1850.2 (MHz)	1880 (MHz)	1909.8 (MHz)	1850.2 (MHz)	1880 (MHz)	1909.8 (MHz)
GSM(GMSK)	Results	29.65	29.91	29.84	28.05	28.31	28.24	29.76	30.02	29.95
GPRS/EGPRS (GMSK)	1TXslot	29.34	29.87	29.58	27.74	28.27	27.98	29.45	29.98	29.69
	2TXslots	26.21	26.53	26.30	24.61	24.93	24.70	26.32	26.64	26.41
	3TXslots	23.87	24.17	23.94	22.27	22.57	22.34	23.98	24.28	24.05
	4TXslots	22.51	22.54	22.33	20.91	20.94	20.73	22.62	22.65	22.44
EGPRS	1TXslot	24.72	24.92	24.72	23.12	23.32	23.12	24.83	25.03	24.83
	2TXslots	22.76	22.74	22.15	21.16	21.14	20.55	22.87	22.85	22.26
	3TXslots	20.01	20.15	19.95	18.41	18.55	18.35	20.12	20.26	20.06
	4TXslots	19.02	18.94	18.74	17.42	17.34	17.14	19.13	19.05	18.85

WCDMA Band II		Maximum Output Power (dBm)			Main Antenna EIRP (dBm)			Second Antenna EIRP (dBm)		
		Channel 9262	Channel 9400	Channel 9538	Channel 9262	Channel 9400	Channel 9538	Channel 9262	Channel 9400	Channel 9538
		1852.4 (MHz)	1880 (MHz)	1907.6 (MHz)	1852.4 (MHz)	1880 (MHz)	1907.6 (MHz)	1852.4 (MHz)	1880 (MHz)	1907.6 (MHz)
RMC		23.04	23.33	23.25	21.44	21.73	21.65	23.15	23.44	23.36
AMR		23.18	23.23	23.31	21.58	21.63	21.71	23.29	23.34	23.42
HSDPA	Sub - Test 1	21.80	22.19	22.27	20.20	20.59	20.67	21.91	22.30	22.38
	Sub - Test 2	22.06	22.11	22.31	20.46	20.51	20.71	22.17	22.22	22.42
	Sub - Test 3	21.28	21.77	21.63	19.68	20.17	20.03	21.39	21.88	21.74
	Sub - Test 4	21.54	21.73	21.65	19.94	20.13	20.05	21.65	21.84	21.76
HSUPA	Sub - Test 1	22.08	22.21	22.23	20.48	20.61	20.63	22.19	22.32	22.34
	Sub - Test 2	20.08	20.39	20.05	18.48	18.79	18.45	20.19	20.50	20.16
	Sub - Test 3	20.80	21.07	21.11	19.20	19.47	19.51	20.91	21.18	21.22
	Sub - Test 4	20.10	20.33	20.13	18.50	18.73	18.53	20.21	20.44	20.24
	Sub - Test 5	22.04	22.23	22.07	20.44	20.63	20.47	22.15	22.34	22.18
DC-HSDPA	Sub - Test 1	21.80	22.27	22.17	20.20	20.67	20.57	21.91	22.38	22.28
	Sub - Test 2	22.06	22.21	22.03	20.46	20.61	20.43	22.17	22.32	22.14
	Sub - Test 3	21.60	21.81	21.63	20.00	20.21	20.03	21.71	21.92	21.74
	Sub - Test 4	21.30	21.59	21.61	19.70	19.99	20.01	21.41	21.70	21.72

5.2.Occupied Bandwidth

Ambient condition

Temperature	Relative humidity	Pressure
23°C ~25°C	45%~50%	101.5kPa

Method of Measurement

The EUT was connected to Spectrum Analyzer and Base Station Simulator via power Splitter. The occupied bandwidth is measured using spectrum analyzer.

RBW is set to $\geq 1\%EBW$, VBW is set to 3x RBW.

99% power and -26dBc occupied bandwidths are recorded. Spectrum analyzer plots are included on the following pages.

Test Setup

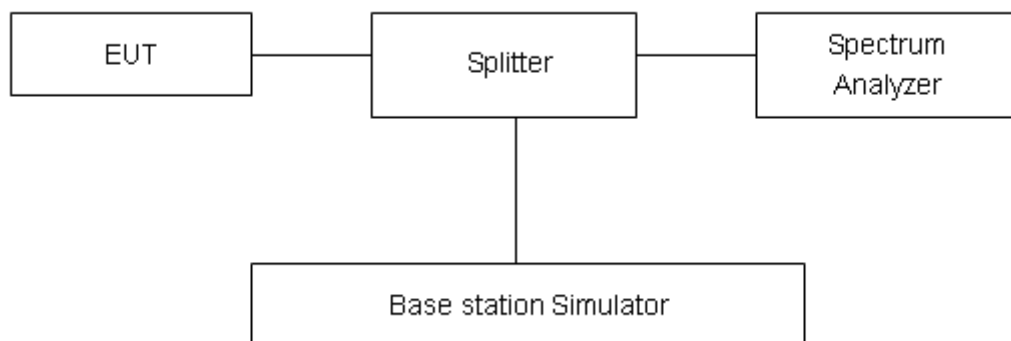

Limits

No specific occupied bandwidth requirements in part 2.1049.

Measurement Uncertainty

The assessed measurement uncertainty to ensure 95% confidence level for the normal distribution is with the coverage factor $k = 2$, $U = 624\text{Hz}$.

Test Result

Mode	Channel	Frequency (MHz)	99% Power Bandwidth (MHz)	-26dBc Bandwidth(MHz)
GSM 1900 (GMSK)	512	1850.2	0.244	0.313
	661	1880	0.249	0.313
	810	1909.8	0.247	0.312
GPRS 1900 (GMSK)	512	1850.2	0.247	0.320
	661	1880	0.245	0.303
	810	1909.8	0.245	0.320
EGPRS 1900 (8PSK)	512	1850.2	0.244	0.310
	661	1880	0.239	0.307
	810	1909.8	0.245	0.309
WCDMA Band II (RMC)	9262	1852.4	4.139	4.680
	9400	1880	4.135	4.711
	9538	1907.6	4.142	4.700

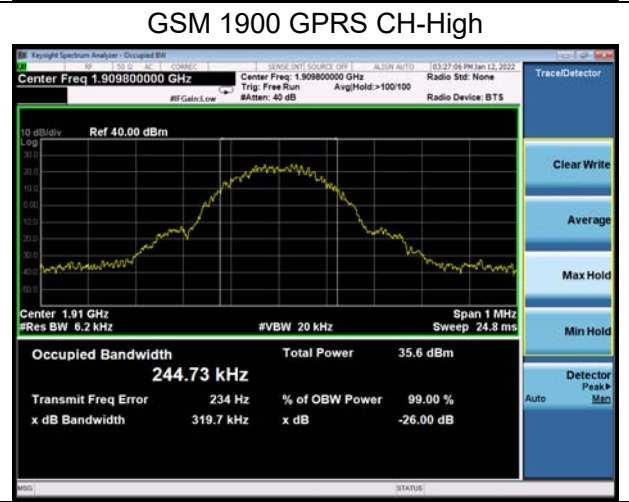
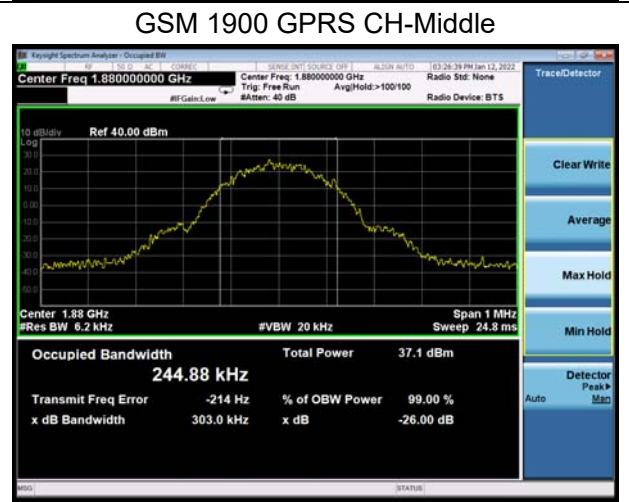
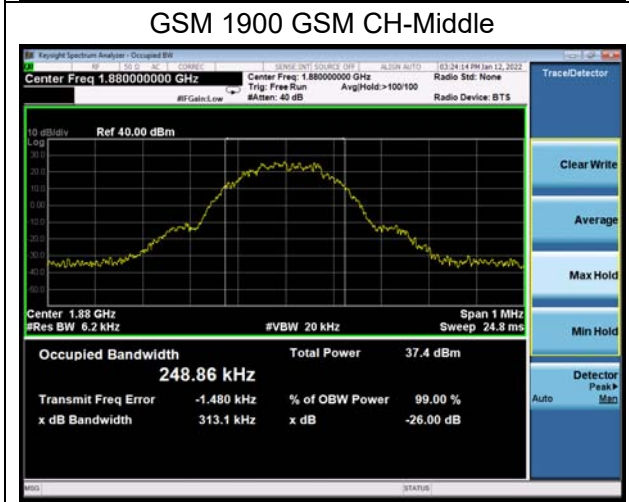
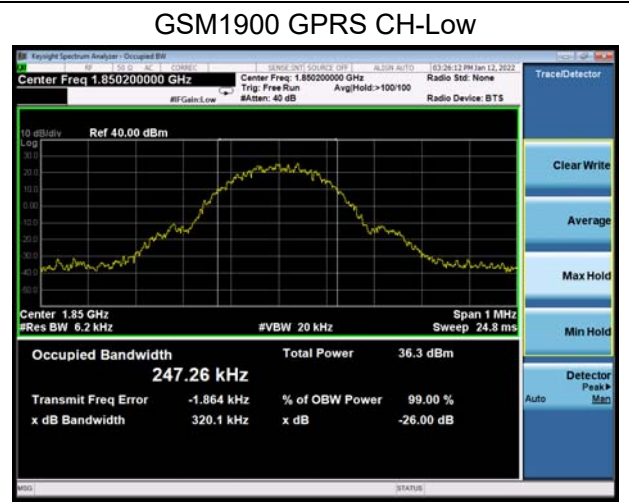
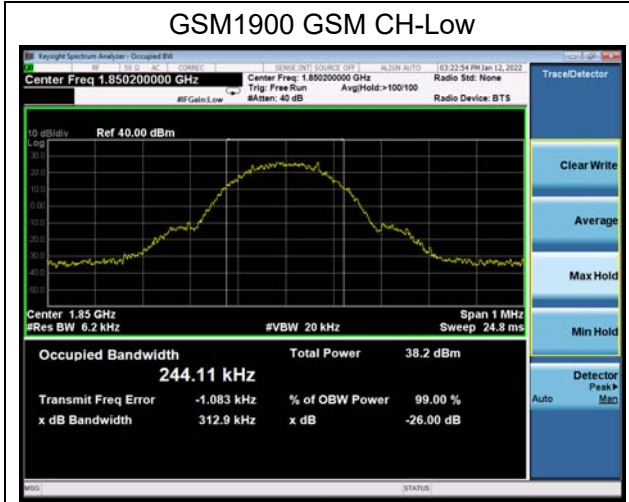

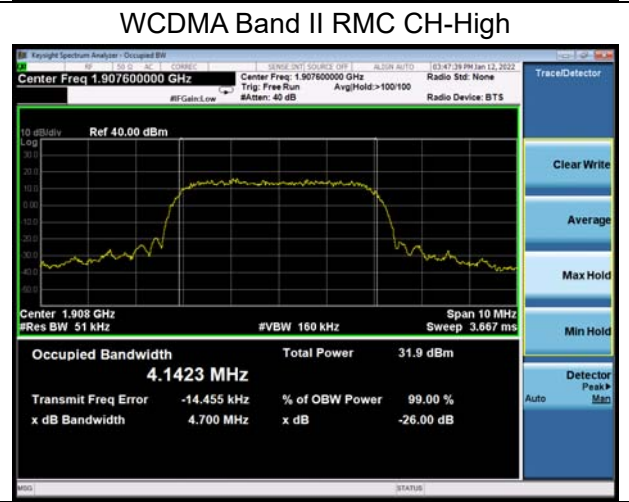
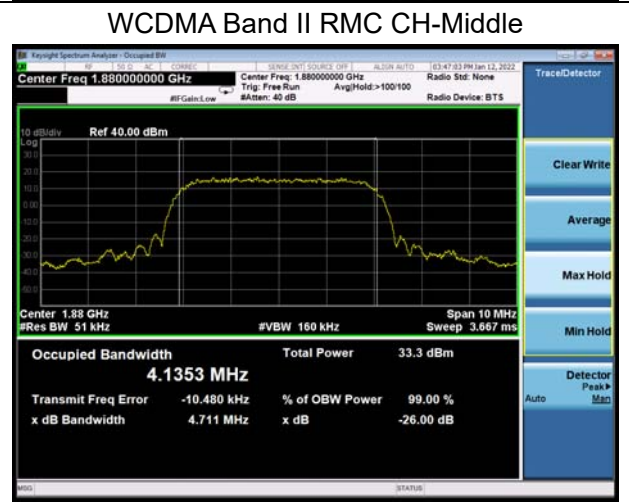
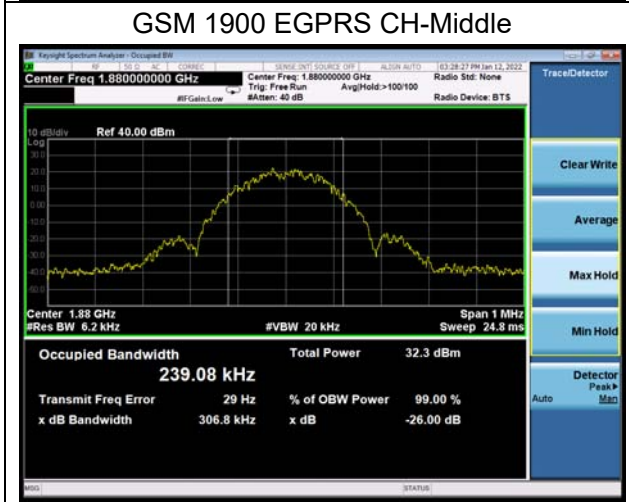
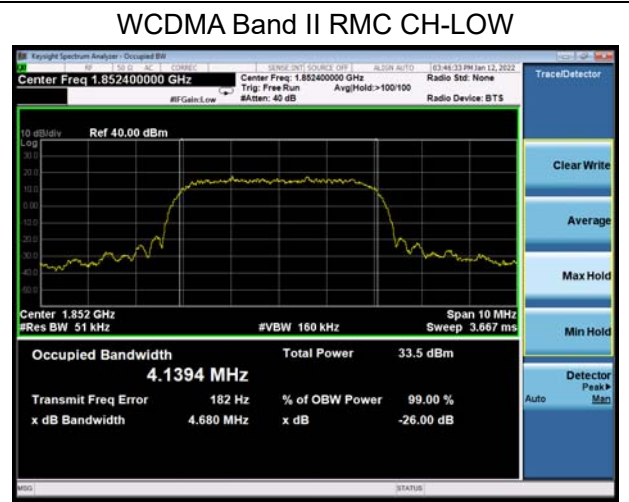
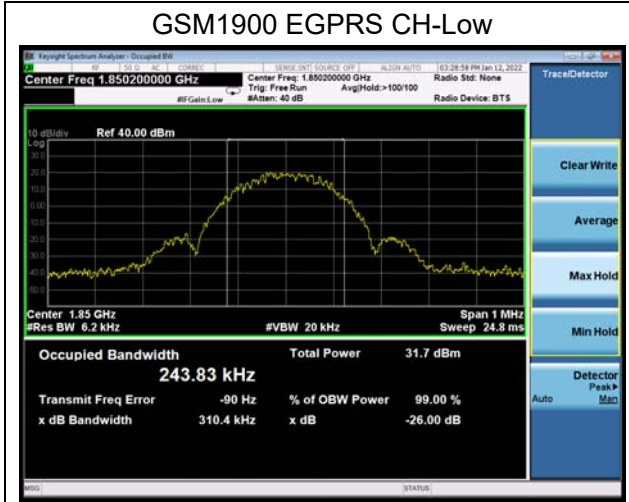

5.3. Band Edge Compliance

Ambient condition

Temperature	Relative humidity	Pressure
23°C ~25°C	45%~50%	101.5kPa

Method of Measurement

The EUT was connected to Spectrum Analyzer and Base Station Simulator via power Splitter. The band edge of the lowest and highest channels were measured. The Average detector is used and RBW is set to $\geq 1\%EBW$, VBW is set to 3x RBW.

Spectrum analyzer plots are included on the following pages.

Test Setup

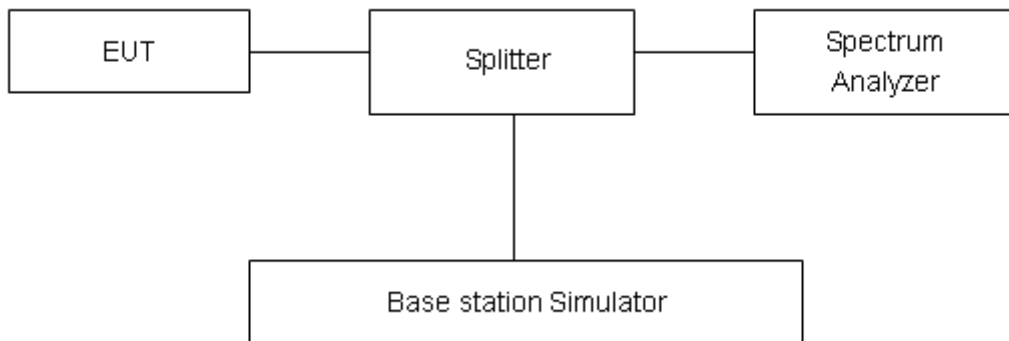

Limits

Rule Part 24.238(a) specifies that “on any frequency outside a licensee's frequency block, the power of any emission shall be attenuated below the transmitter power (P) by at least $43 + 10 \log_{10} (P)$ dB.”

Limit	-13 dBm
-------	---------

Measurement Uncertainty

The assessed measurement uncertainty to ensure 95% confidence level for the normal distribution is with the coverage factor $k = 1.96$, $U=0.684dB$.

Test Result:

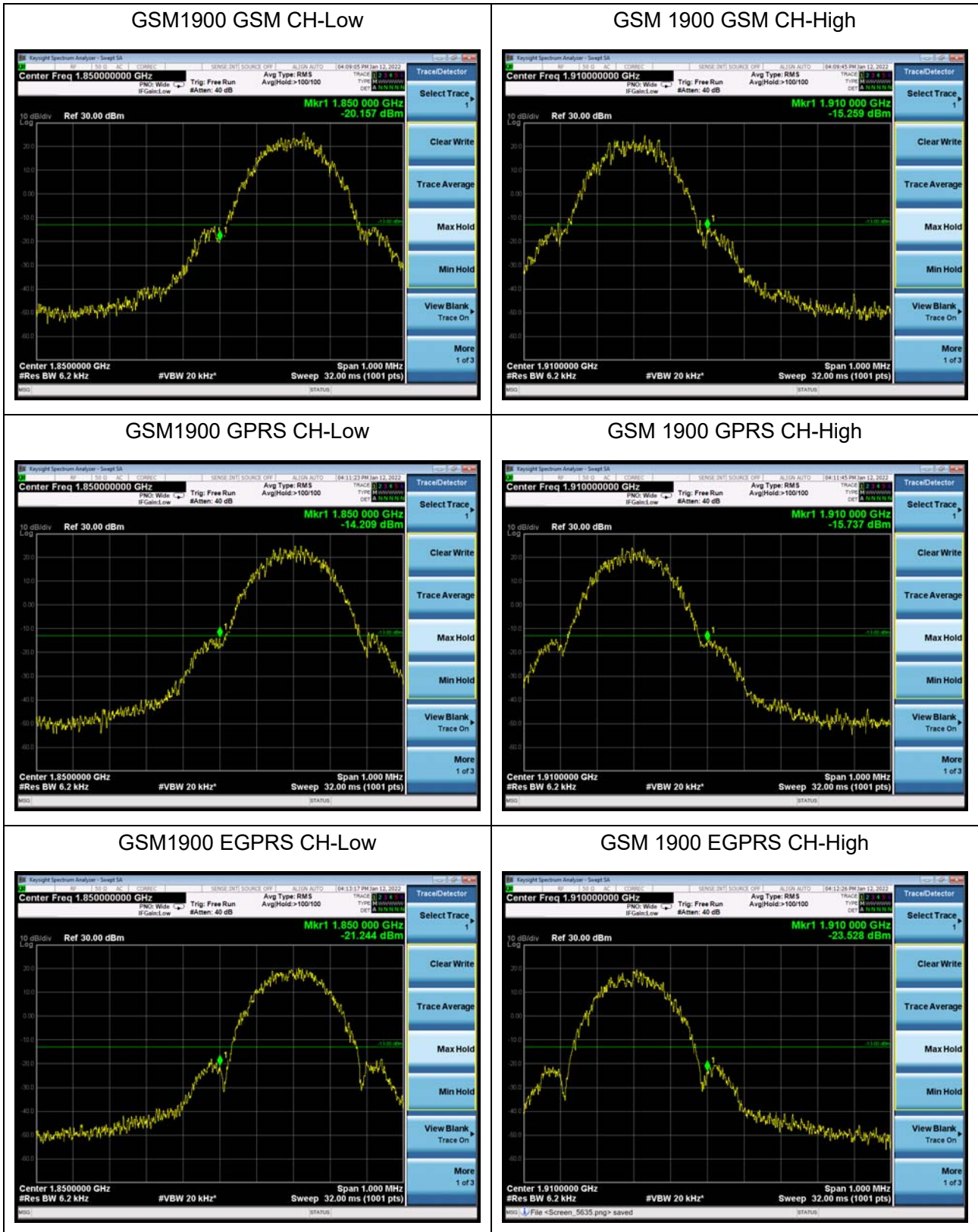



WCDMA Band II RMC CH-Low



WCDMA Band II RMC CH-High



5.4. Peak-to-Average Power Ratio (PAPR)

Ambient condition

Temperature	Relative humidity	Pressure
23°C ~25°C	45%~50%	101.5kPa

Methods of Measurement

Measure the total peak power and record as PPk. And measure the total average power and record as PAvg. Both the peak and average power levels must be expressed in the same logarithmic units (e.g., dBm). Determine the PAPR from:

$$PAPR (dB) = PPk (dBm) - PAvg (dBm).$$

Test Setup

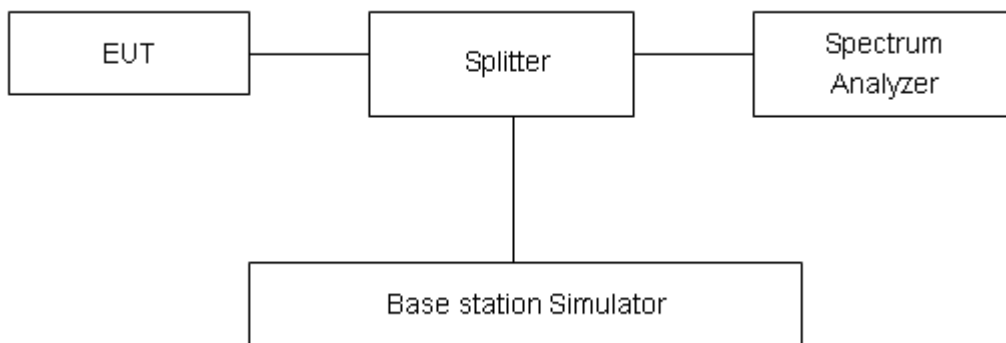

Limits

In measuring transmissions in this band using an average power technique, the peak-to-average ratio (PAR) of the transmission may not exceed 13 dB in 24.232(d).

Measurement Uncertainty

The assessed measurement uncertainty to ensure 95% confidence level for the normal distribution is with the coverage factor $k = 2$, $U = 0.4$ dB.

**Test Results**

Mode	Channel	Frequency (MHz)	Peak(dBm)	Avg(dBm)	PAPR(dB)	Limit(dB)	Conclusion
GSM 1900 (GMSK)	512	1850.2	30.85	28.02	2.83	≤13	PASS
	661	1880	31.39	28.60	2.79	≤13	PASS
	810	1909.8	29.58	26.59	2.99	≤13	PASS
GPRS 1900 (GMSK)	512	1850.2	30.84	28.04	2.80	≤13	PASS
	661	1880	31.41	28.62	2.79	≤13	PASS
	810	1909.8	29.61	26.58	3.03	≤13	PASS
EGPRS 1900 (8PSK)	512	1850.2	29.51	23.61	5.90	≤13	PASS
	661	1880	29.82	23.92	5.90	≤13	PASS
	810	1909.8	27.94	21.66	6.28	≤13	PASS
WCDMA Band II (RMC)	9262	1852.4	27.10	24.24	2.86	≤13	PASS
	9400	1880	27.51	24.60	2.91	≤13	PASS
	9538	1907.6	25.82	23.05	2.77	≤13	PASS

5.5. Frequency Stability

Ambient condition

Temperature	Relative humidity	Pressure
23°C ~25°C	45%~50%	101.5kPa

Method of Measurement

Frequency Stability (Temperature Variation)

The temperature inside the climate chamber is varied from 0°C to +35°C in 10°C step size,

(1) With all power removed, the temperature was decreased to 0°C and permitted to stabilize for three hours.

(2) Measure the carrier frequency with the test equipment in a “call mode”. These measurements should be made within 1 minute of powering up the mobile station, to prevent significant self warming.

(3) Repeat the above measurements at 10°C increments from 0°C to +35°C. Allow at least 1.5 hours at each temperature, un-powered, before making measurements.

Frequency Stability (Voltage Variation)

The frequency stability shall be measured with variation of primary supply voltage as follows:

Primary Supply Voltage: The primary supply voltage is varied from 85% to 115% of the nominal value for non hand-carried battery and AC powered equipment. For hand-carried, battery-powered equipment, primary supply voltage is reduced to the battery operating end point which shall be specified by the manufacturer.

This transceiver is specified to operate with an input voltage of between 3.60 V and 4.45 V, with a nominal voltage of 3.87V.

Test setup

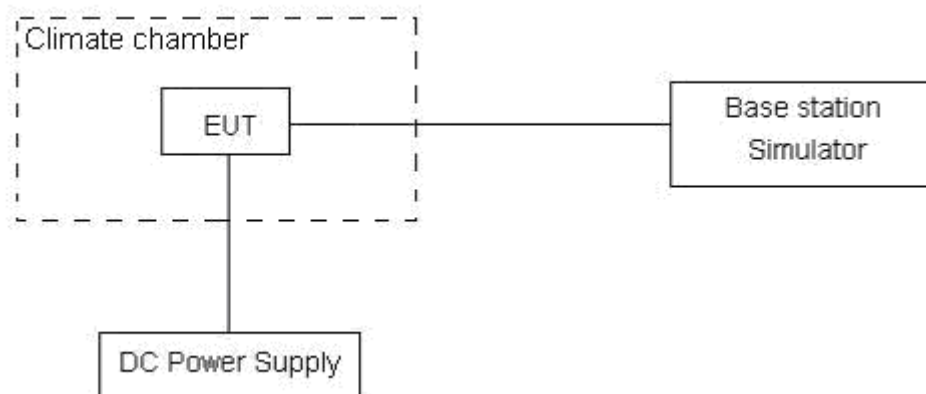

Limits

The frequency stability shall be sufficient to ensure that the fundamental emission stays within the authorized frequency block

Measurement Uncertainty

The assessed measurement uncertainty to ensure 99.75% confidence level for the normal distribution is with the coverage factor $k = 3$, $U = 0.01\text{ppm}$.

Test Result

GSM1900						
Condition		Freq.Error (Hz)	Freq.Error (Hz)	Frequency Stability (ppm)	Frequency Stability (ppm)	Verdict
Temperature	Voltage	GMSK	8PSK	GMSK	8PSK	
Normal (25°C)	Normal	9.95	5.21	0.00529	0.00277	PASS
Extreme (35°C)		2.85	2.25	0.00152	0.00120	PASS
Extreme (30°C)		13.41	16.18	0.00713	0.00861	PASS
Extreme (20°C)		1.15	14.74	0.00061	0.00784	PASS
Extreme (10°C)		4.19	12.60	0.00223	0.00670	PASS
Extreme (0°C)		10.25	12.57	0.00545	0.00669	PASS
25°C	LV	5.30	6.54	0.00282	0.00348	PASS
	HV	15.19	14.54	0.00808	0.00774	PASS

WCDMA Band II						
Condition		Freq.Error (Hz)	Freq.Error (Hz)	Frequency Stability (ppm)	Frequency Stability (ppm)	Verdict
Temperature	Voltage	BPSK	QPSK	BPSK	QPSK	
Normal (25°C)	Normal	17.78	16.46	0.00946	0.00876	PASS
Extreme (35°C)		8.06	13.75	0.00429	0.00731	PASS
Extreme (30°C)		5.96	17.48	0.00317	0.00930	PASS
Extreme (20°C)		2.50	14.72	0.00133	0.00783	PASS
Extreme (10°C)		11.05	9.14	0.00588	0.00486	PASS
Extreme (0°C)		4.46	7.03	0.00237	0.00374	PASS
25°C	LV	15.60	12.92	0.00830	0.00687	PASS
	HV	6.35	4.71	0.00338	0.00251	PASS

5.6. Spurious Emissions at Antenna Terminals

Ambient condition

Temperature	Relative humidity	Pressure
23°C ~25°C	45%~50%	101.5kPa

Method of Measurement

The EUT was connected to Spectrum Analyzer and Base Station Simulator via power Splitter. The measurement is carried out using a spectrum analyzer. The spectrum analyzer scans from 9kHz to the 10th harmonic of the carrier. The peak detector is used.

RBW is set to 100kHz, VBW is set to 300kHz for 30MHz~1GHz

RBW is set to 1MHz, VBW is set to 3MHz for above 1GHz, Sweep is set to ATUO.

RBW is set to 1 kHz (0.009MHz~ 0.15 MHz),

RBW is set to 10 kHz (0.15 MHz~ 30 MHz)

RBW is set to 100 kHz (30MHz~1000 MHz)

RBW is set to 1000 kHz (above 1000MHz)

The modulation mode and RB allocation refer to section 5.1, using the maximum output power configuration.

Test setup

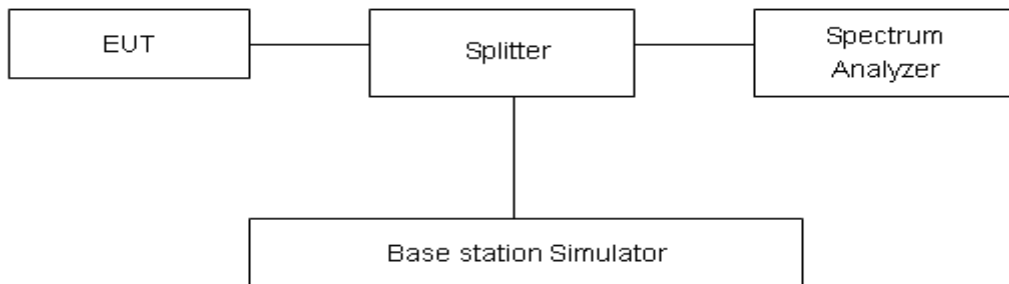

Limits

Rule Part 24.238(a) specifies that “on any frequency outside a licensee’s frequency block, the power of any emission shall be attenuated below the transmitter power (P) by at least 43 + 10 log₁₀ (P) dB.”

Limit	-13 dBm
-------	---------

Measurement Uncertainty

The assessed measurement uncertainty to ensure 99.75% confidence level for the normal distribution is with the coverage factor $k = 1.96$.

Frequency	Uncertainty
9kHz-1GHz	0.684 dB
1GHz-20GHz	1.407 dB

Test Result

Sweep the whole frequency band through the range from 9kHz to the 10th harmonic of the carrier, the emissions more than 20 dB below the limit are not reported.

The signal beyond the limit is carrier.

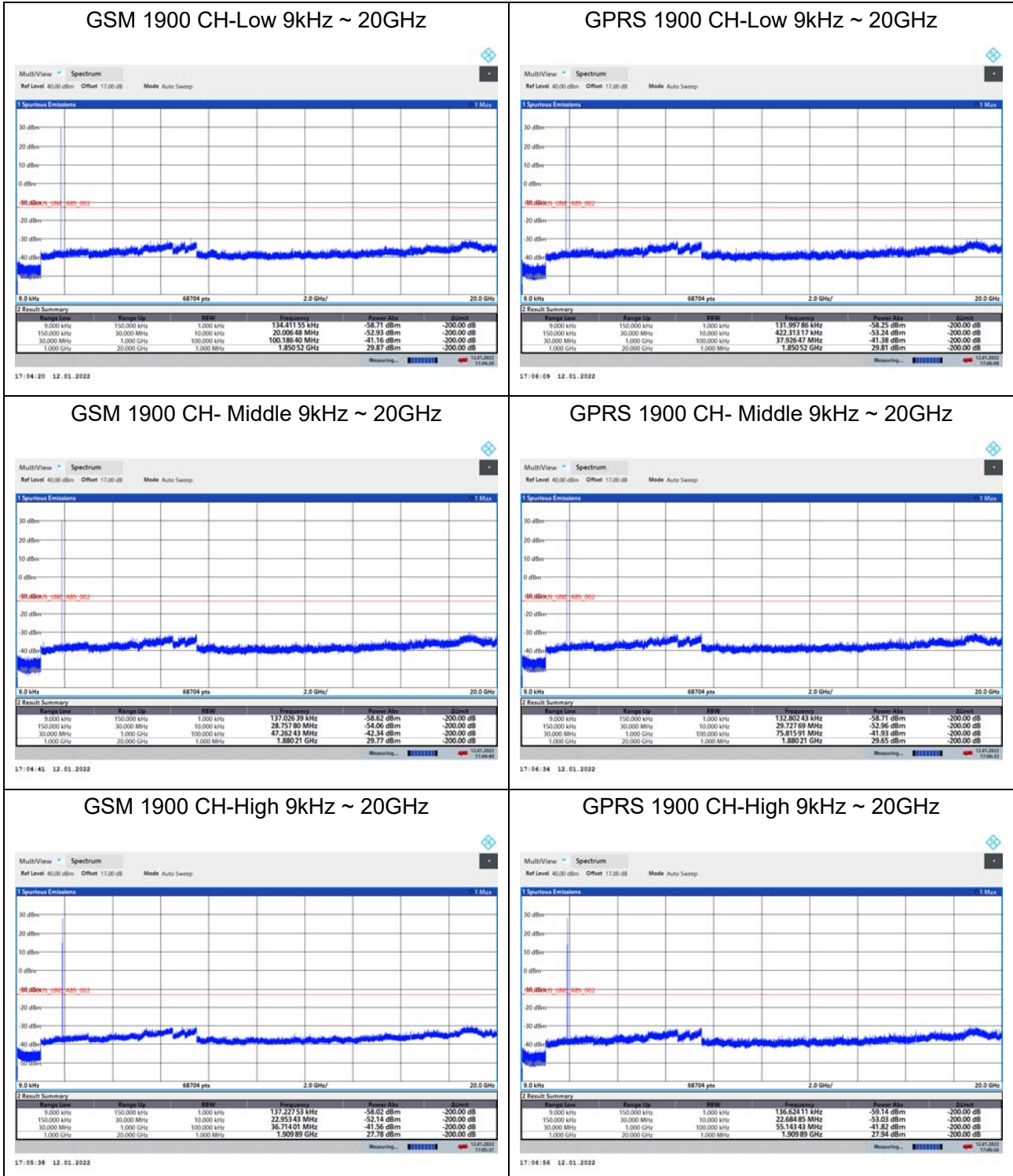



EGPRS 1900 CH-Low 9kHz ~ 20GHz

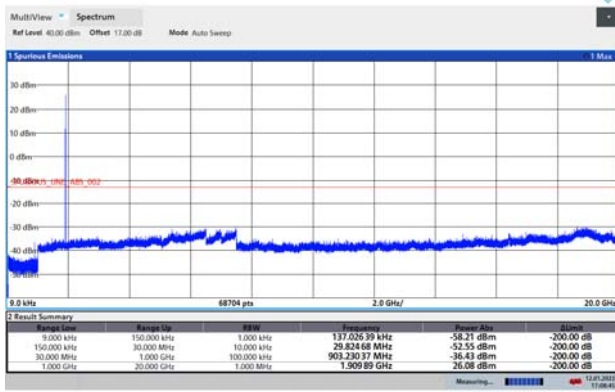

17:08:48 12.01.2022

WCDMA BAND II CH-Low 9kHz ~ 20GHz

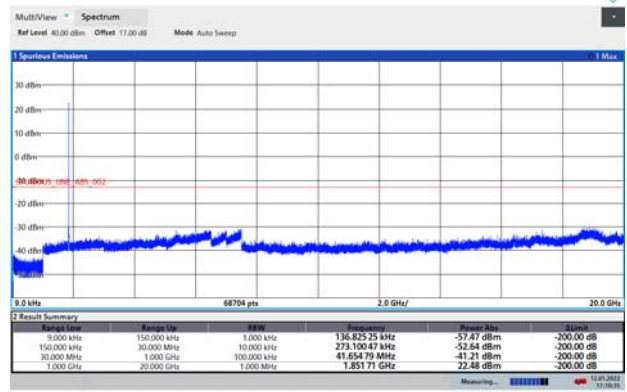

17:10:35 12.01.2022

EGPRS 1900 CH- Middle 9kHz ~ 20GHz

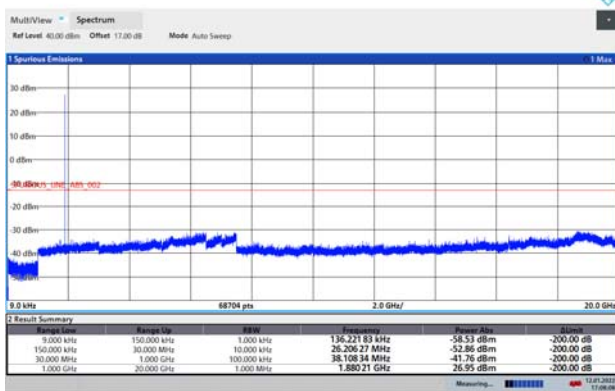

17:08:08 12.01.2022

WCDMA BAND II CH- Middle 9kHz ~ 20GHz

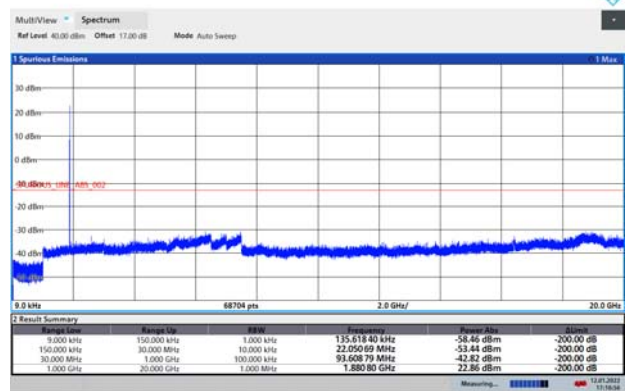

17:10:56 12.01.2022

EGPRS 1900 CH-High 9kHz ~ 20GHz

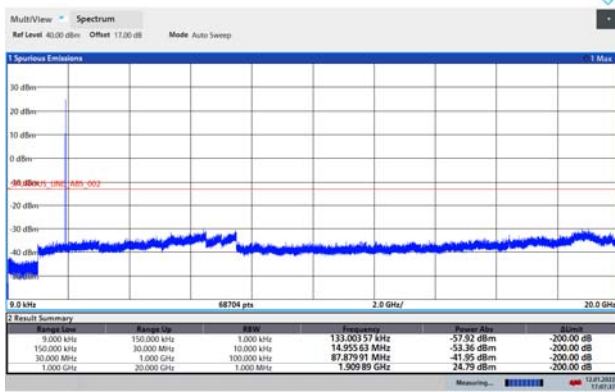

17:07:38 12.01.2022

WCDMA BAND II CH-High 9kHz ~ 20GHz

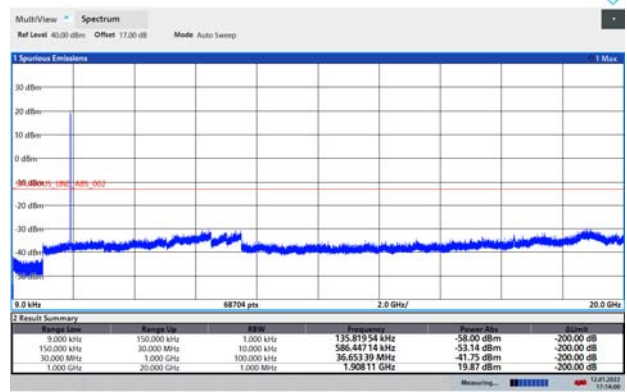

17:14:01 12.01.2022

5.7. Radiates Spurious Emission

Ambient condition

Temperature	Relative humidity	Pressure
23°C ~25°C	45%~50%	101.5kPa

Method of Measurement

- The testing follows FCC KDB 971168 v03r01 Section 5.8 and ANSI C63.26 (2015).
- Below 1GHz: The EUT is placed on a turntable 0.8 meters above the ground in the chamber, 3 meter away from the antenna. The maximal emission value is acquired by adjusting the antenna height, polarisation and turntable azimuth. Normally, the height range of antenna is 1 m to 4 m, the azimuth range of turntable is 0° to 360°, and the receive antenna has two polarizations Vertical (V) and Horizontal (H). Above 1GHz: (Note: the FCC's permission to use 1.5m as an alternative per TCBC Conf call of Dec. 2, 2014.) The EUT is placed on a turntable 1.5 meters above the ground in the chamber, 3 meter away from the antenna. The maximal emission value is acquired by adjusting the antenna height, polarisation and turntable azimuth. Normally, the height range of antenna is 1 m to 4 m, the azimuth range of turntable is 0° to 360°, and the receive antenna has two polarizations Vertical (V) and Horizontal (H).
- A loop antenna, A log-periodic antenna or horn antenna shall be substituted in place of the EUT. The log-periodic antenna will be driven by a signal generator and the level will be adjusted till the same power value on the spectrum analyzer or receiver. The level of the spurious emissions can be calculated through the level of the signal generator, cable loss, the gain of the substitution antenna and the reading of the spectrum analyzer or receiver.
- The EUT is then put into continuously transmitting mode at its maximum power level during the test. Set Test Receiver or Spectrum RBW=1MHz, VBW=3MHz, and the maximum value of the receiver should be recorded as (Pr).
- The EUT shall be replaced by a substitution antenna. In the chamber, an substitution antenna for the frequency band of interest is placed at the reference point of the chamber. An RF Signal source for the frequency band of interest is connected to the substitution antenna with a cable that has been constructed to not interfere with the radiation pattern of the antenna. A power (PMea) is applied to the input of the substitution antenna, and adjust the level of the signal generator output until the value of the receiver reach the previously recorded (Pr). The power of signal source (PMea) is recorded. The test should be performed by rotating the test item and adjusting the receiving antenna polarization.
- A amplifier should be connected to the Signal Source output port. And the cable should be connect between the Amplifier and the Substitution Antenna. The cable loss (Pcl), the Substitution Antenna Gain (Ga) and the Amplifier Gain (PAg) should be recorded after test.
- The measurement results are obtained as described below:

$$\text{Power(EIRP)} = \text{PMea} - \text{PAg} - \text{Pcl} + \text{Ga}$$
The measurement results are amend as described below:

$$\text{Power(EIRP)} = \text{PMea} - \text{Pcl} + \text{Ga}$$
- This value is EIRP since the measurement is calibrated using an antenna of known gain (2.15 dB) and known input power. ERP can be calculated from EIRP by subtracting the gain of the dipole, ERP

= EIRP-2.15dB.

The modulation mode and RB allocation refer to section 5.1, using the maximum output power configuration.

Test setup

9KHz ~ 30MHz

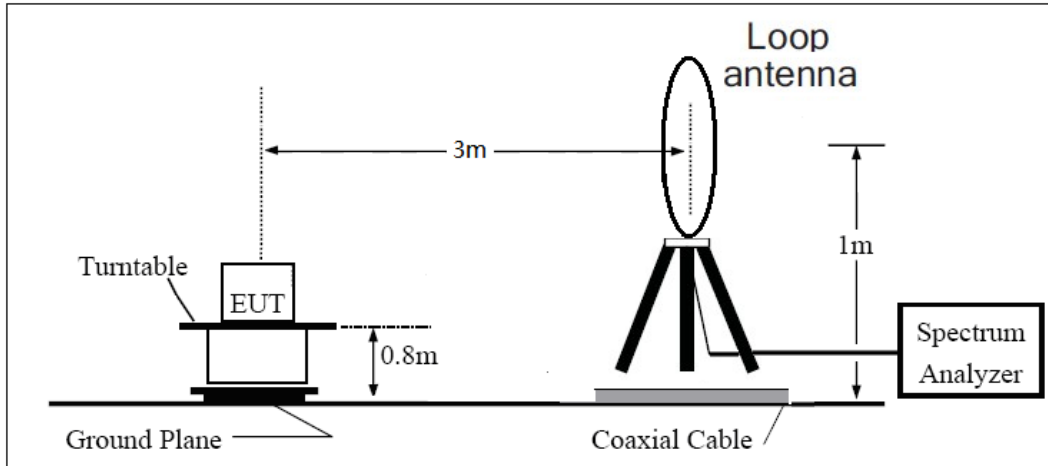

30MHz ~ 1GHz

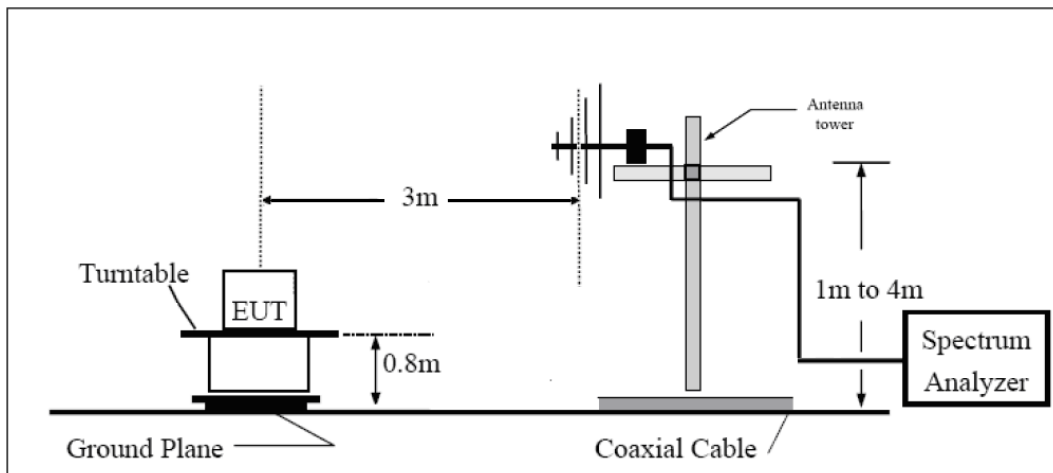

Above 1GHz

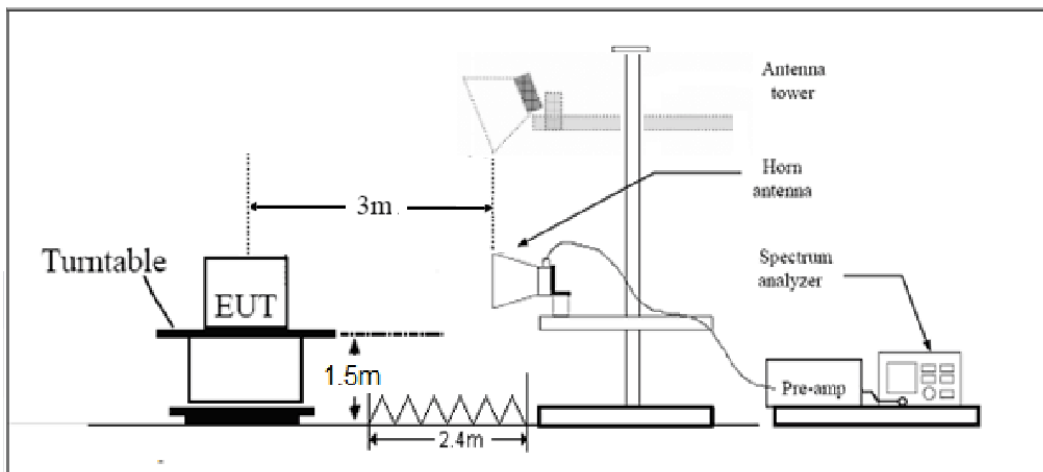

Note: Area side: 2.4mX3.6m



Limits

Rule Part 24.238(a) specifies that “on any frequency outside a licensee's frequency block, the power of any emission shall be attenuated below the transmitter power (P) by at least $43 + 10 \log_{10} (P)$ dB.”

Limit	-13 dBm
-------	---------

Measurement Uncertainty

The assessed measurement uncertainty to ensure 95% confidence level for the normal distribution is with the coverage factor $k = 1.96$, $U = 3.55$ dB.

**Test Result**

Sweep the whole frequency band through the range from 9kHz to the 10th harmonic of the carrier, the emissions below the noise floor will not be recorded in the report.

Main Antenna

GSM 1900 CH-Middle

Harmonic	Frequency (MHz)	SG (dBm)	Cable Loss (dB)	Gain (dBi)	Antenna Polarization	EIRP Level (dBm)	Limit (dBm)	Margin (dB)	Azimuth (deg)
2	3760.00	-58.03	2.60	12.50	Horizontal	-48.13	-13.00	35.13	0
3	5640.00	-56.90	3.30	12.50	Horizontal	-47.70	-13.00	34.70	180
4	7520.00	-56.41	4.20	12.20	Horizontal	-48.41	-13.00	35.41	225
5	9400.00	-52.04	4.30	11.10	Horizontal	-45.24	-13.00	32.24	180
6	11280.00	-50.11	5.90	11.90	Horizontal	-44.11	-13.00	31.11	0
7	13160.00	-51.86	5.70	14.00	Horizontal	-43.56	-13.00	30.56	90
8	15040.00	-46.13	5.80	13.10	Horizontal	-38.83	-13.00	25.83	0
9	16920.00	-48.78	6.10	14.60	Horizontal	-40.28	-13.00	27.28	90
10	18800.00	--	--	--	--	--	--	--	--

Note: 1. The other Spurious RF Radiated emissions level is no more than noise floor.

2. The worst emission was found in the antenna is Horizontal position.

WCDMA Band II CH-Middle

Harmonic	Frequency (MHz)	SG (dBm)	Cable Loss (dB)	Gain (dBi)	Antenna Polarization	EIRP Level (dBm)	Limit (dBm)	Margin (dB)	Azimuth (deg)
2	3760.00	-65.17	2.60	12.50	Horizontal	-55.27	-13.00	42.27	135
3	5640.00	-62.41	3.30	12.50	Horizontal	-53.21	-13.00	40.21	0
4	7520.00	-55.48	4.20	12.20	Horizontal	-47.48	-13.00	34.48	225
5	9400.00	-53.02	4.30	11.10	Horizontal	-46.22	-13.00	33.22	180
6	11280.00	-50.09	5.90	11.90	Horizontal	-44.09	-13.00	31.09	135
7	13160.00	-51.98	5.70	14.00	Horizontal	-43.68	-13.00	30.68	180
8	15040.00	-46.69	5.80	13.10	Horizontal	-39.39	-13.00	26.39	315
9	16920.00	-48.59	6.10	14.60	Horizontal	-40.09	-13.00	27.09	225
10	18800.00	--	--	--	--	--	--	--	--

Note: 1. The other Spurious RF Radiated emissions level is no more than noise floor.

2. The worst emission was found in the antenna is Horizontal position.

**Second Antenna**

GSM 1900 CH-Middle

Harmonic	Frequency (MHz)	SG (dBm)	Cable Loss (dB)	Gain (dBi)	Antenna Polarization	EIRP Level (dBm)	Limit (dBm)	Margin (dB)	Azimuth (deg)
2	3760.00	-54.83	2.60	12.50	Horizontal	-44.93	-13.00	31.93	45
3	5640.00	-58.74	3.30	12.50	Horizontal	-49.54	-13.00	36.54	315
4	7520.00	-57.64	4.20	12.20	Horizontal	-49.64	-13.00	36.64	225
5	9400.00	-54.81	4.30	11.10	Horizontal	-48.01	-13.00	35.01	270
6	11280.00	-51.83	5.90	11.90	Horizontal	-45.83	-13.00	32.83	180
7	13160.00	-52.52	5.70	14.00	Horizontal	-44.22	-13.00	31.22	225
8	15040.00	-47.43	5.80	13.10	Horizontal	-40.13	-13.00	27.13	0
9	16920.00	-50.11	6.10	14.60	Horizontal	-41.61	-13.00	28.61	90
10	18800.00	--	--	--	--	--	--	--	--

Note: 1. The other Spurious RF Radiated emissions level is no more than noise floor.

2. The worst emission was found in the antenna is Horizontal position.

WCDMA Band II CH-Middle

Harmonic	Frequency (MHz)	SG (dBm)	Cable Loss (dB)	Gain (dBi)	Antenna Polarization	EIRP Level (dBm)	Limit (dBm)	Margin (dB)	Azimuth (deg)
2	3760.00	-65.20	2.60	12.50	Horizontal	-55.30	-13.00	42.30	180
3	5640.00	-61.52	3.30	12.50	Horizontal	-52.32	-13.00	39.32	135
4	7520.00	-58.65	4.20	12.20	Horizontal	-50.65	-13.00	37.65	90
5	9400.00	-53.07	4.30	11.10	Horizontal	-46.27	-13.00	33.27	45
6	11280.00	-51.26	5.90	11.90	Horizontal	-45.26	-13.00	32.26	315
7	13160.00	-52.55	5.70	14.00	Horizontal	-44.25	-13.00	31.25	90
8	15040.00	-48.07	5.80	13.10	Horizontal	-40.77	-13.00	27.77	45
9	16920.00	-50.41	6.10	14.60	Horizontal	-41.91	-13.00	28.91	180
10	18800.00	--	--	--	--	--	--	--	--

Note: 1. The other Spurious RF Radiated emissions level is no more than noise floor.

2. The worst emission was found in the antenna is Horizontal position.



6. Main Test Instruments

Name	Manufacturer	Type	Serial Number	Calibration Date	Expiration Date
Base Station Simulator	R&S	CMW500	113645	2021-05-15	2022-05-14
Climate Chamber	Weiss	VT4002	58226119450 010	2021-05-15	2022-05-14
Spectrum Analyzer	Keysight	N9020A	MY52330084	2021-05-15	2022-05-14
Universal Radio Communication Tester	Key sight	E5515C	GB44400275	2021-05-15	2022-05-14
Signal Analyzer	R&S	FSV3030	101411	2021-12-12	2022-12-12
Signal Analyzer	R&S	FSV30	100815	2021-12-12	2022-12-11
TRILOG Broadband Antenna	Schwarzbeck	VULB 9163	01439	2021-06-30	2024-06-29
Horn Antenna	Schwarzbeck	BBHA 9120D	01799	2019-09-21	2022-09-20
Horn Antenna	ETS-Lindgren	3160-09	00102643	2020-08-11	2023-08-10
Software	R&S	EMC32	9.26.0	/	/

*****END OF REPORT *****



ANNEX A: The EUT Appearance

The EUT Appearance are submitted separately.



ANNEX B: Test Setup Photos

The Test Setup Photos are submitted separately.



ANNEX C: Product Change Description

The Product Change Description are submitted separately.