



802.11n(HT20), Channel No. 3



802.11n(HT40), Channel No. 5





802.11n(HT20), Channel No. 4



802.11n(HT40), Channel No. 6





802.11n(HT20), Channel No. 6



802.11n(HT40), Channel No. 7

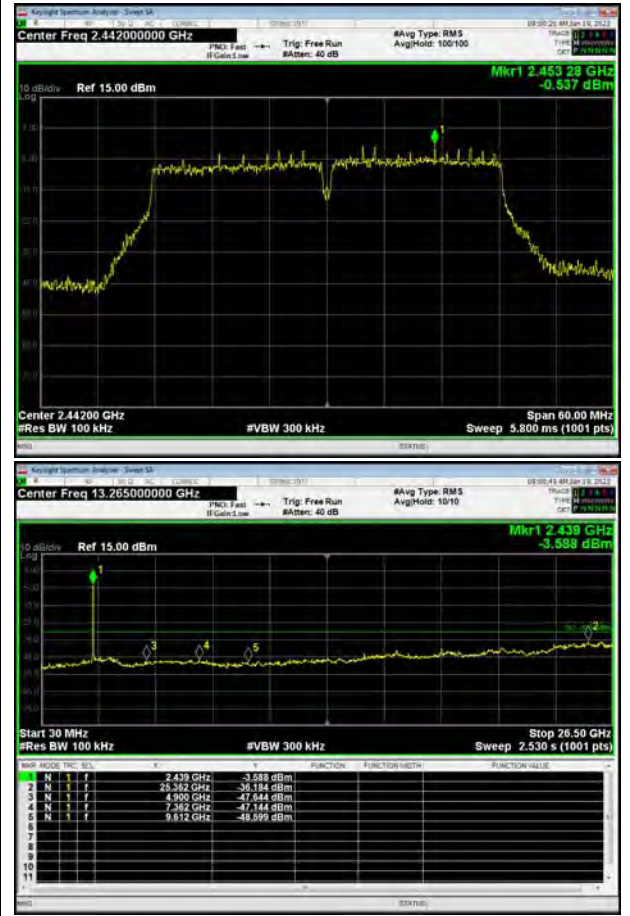



802.11n(HT20), Channel No. 8



802.11n(HT40), Channel No. 8

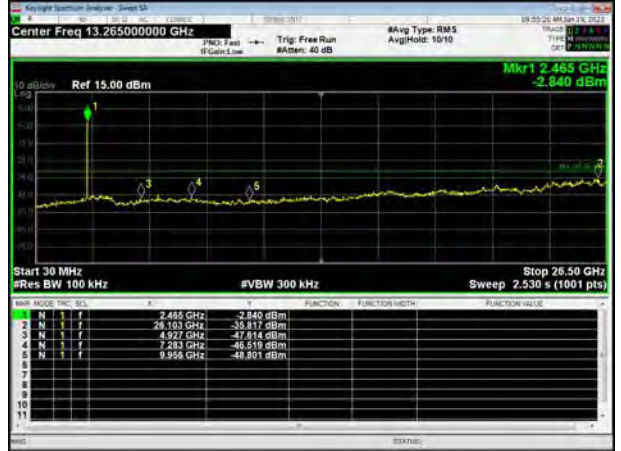
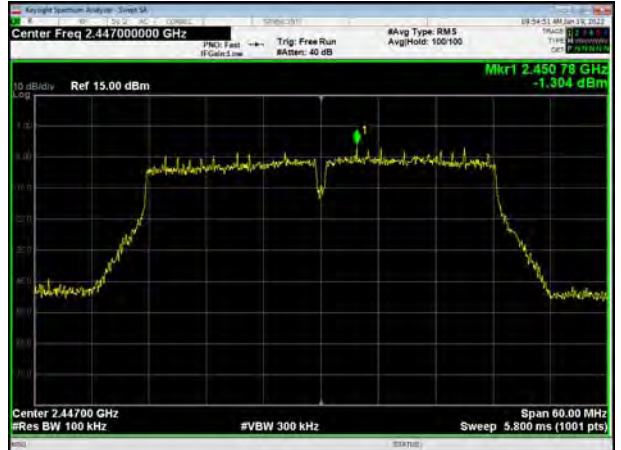



802.11n(HT20), Channel No. 9



802.11n(HT40), Channel No. 9

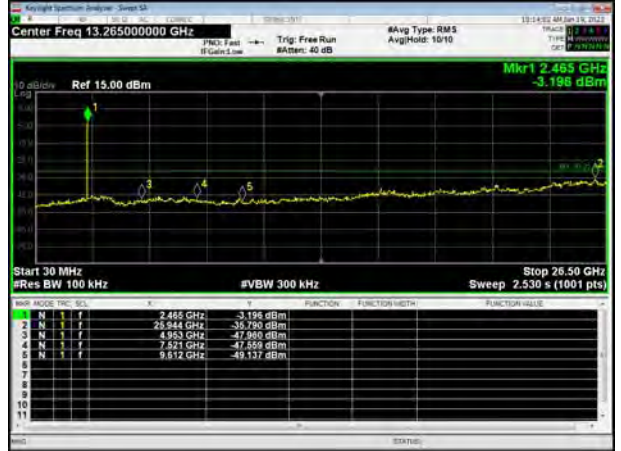
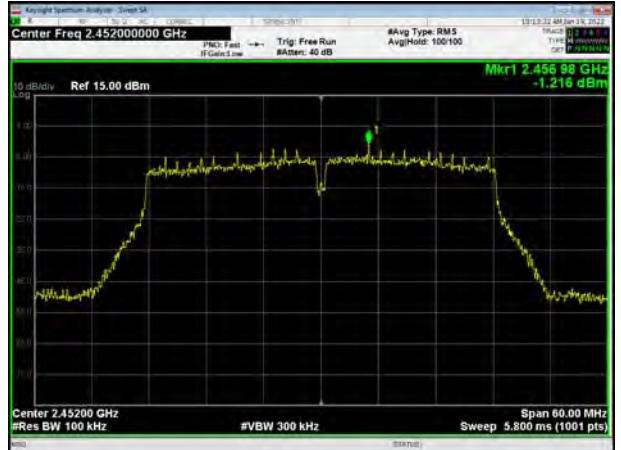



802.11n(HT20), Channel No. 10



802.11n(HT20), Channel No. 11





Bluetooth LE, Channel No.: 0



Bluetooth LE, Channel No.: 19

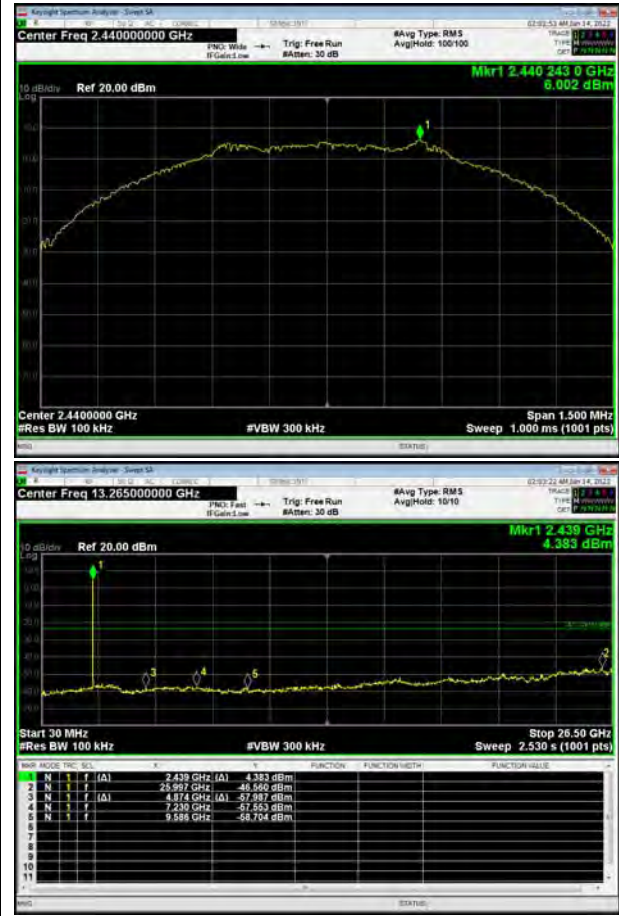

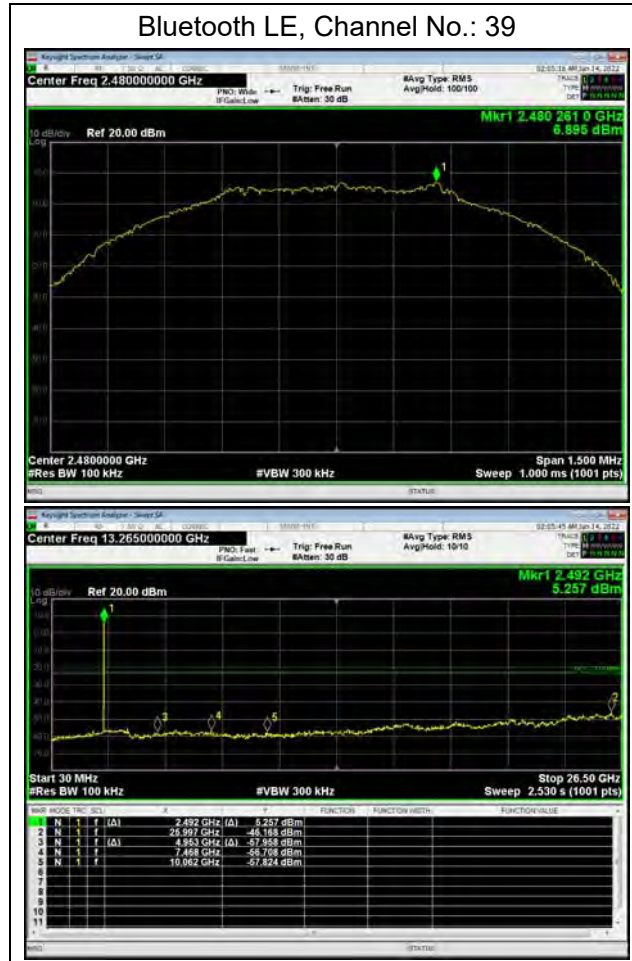

5.6. Unwanted Emission

Ambient condition

Temperature	Relative humidity	Pressure
23°C ~25°C	45%~50%	102.5kPa

Method of Measurement

The test set-up was made in accordance to the general provisions of ANSI C63.10.

The Equipment Under Test (EUT) was set up on a non-conductive table in the semi-anechoic chamber. The test was performed at the distance of 3 m between the EUT and the receiving antenna.

The turntable shall be rotated from 0 to 360 degrees for detecting the maximum of radiated spurious signal level. The measurements shall be repeated with orthogonal polarization of the test antenna. The data of cable loss and antenna factor has been calibrated in full testing frequency range before the testing. Sweep the Restricted Band and the emissions less than 20 dB below the permissible value are reported.

The radiated emissions measurements were made in a typical installation configuration.

Sweep the whole frequency band through the range from 9 kHz to the 10th harmonic of the carrier, and the emissions less than 20 dB below the permissible value are reported.

This method refer to ANSI C63.10.

The procedure for peak unwanted emissions measurements above 1000 MHz is as follows:

Set the spectrum analyzer in the following:

9kHz~150 kHz

RBW=200Hz, VBW=1kHz/ Sweep=AUTO

150 kHz~30MHz

RBW=9KHz, VBW=30KHz,/ Sweep=AUTO

Below 1GHz

RBW=100kHz / VBW=300kHz / Sweep=AUTO

a) Peak emission levels are measured by setting the instrument as follows:

Above 1GHz

PEAK: RBW=1MHz VBW=3MHz/ Sweep=AUTO

b) Average emission levels are measured by setting the instrument as follows:

Above 1GHz

AVERAGE: RBW=1MHz / VBW=3MHz / Sweep=AUTO

c) Detector: The measurements employing a CISPR quasi-peak detector except for the frequency bands 9-90 kHz, 110-490 kHz and above 1000 MHz. Radiated emission limits in these three bands are based on measurements employing an average detector.

d) Averaging type = power (i.e., rms) (As an alternative, the detector and averaging type may be set for linear voltage averaging. Some instruments require linear display mode to use linear voltage



averaging. Log or dB averaging shall not be used.)

e) Sweep time = auto.

f) Perform a trace average of at least 100 traces if the transmission is continuous. If the transmission is not continuous, then the number of traces shall be increased by a factor of $1 / D$, where D is the duty cycle. For example, with 50% duty cycle, at least 200 traces shall be averaged. (If a specific emission is demonstrated to be continuous—i.e., 100% duty cycle—then rather than turning ON and OFF with the transmit cycle, at least 100 traces shall be averaged.)

g) If tests are performed with the EUT transmitting at a duty cycle less than 98%, then a correction factor shall be added to the measurement results prior to comparing with the emission limit, to compute the emission level that would have been measured had the test been performed at 100% duty cycle. The correction factor is computed as follows:

1) If power averaging (rms) mode was used in the preceding step e), then the correction factor is $[10 \log (1 / D)]$, where D is the duty cycle. For example, if the transmit duty cycle was 50%, then 3 dB shall be added to the measured emission levels.

2) If linear voltage averaging mode was used in the preceding step e), then the correction factor is $[20 \log (1 / D)]$, where D is the duty cycle. For example, if the transmit duty cycle was 50%, then 6 dB shall be added to the measured emission levels.

3) If a specific emission is demonstrated to be continuous (100% duty cycle) rather than turning ON and OFF with the transmit cycle, then no duty cycle correction is required for that emission.

The test is in transmitting mode.

Test setup
9KHz ~ 30MHz

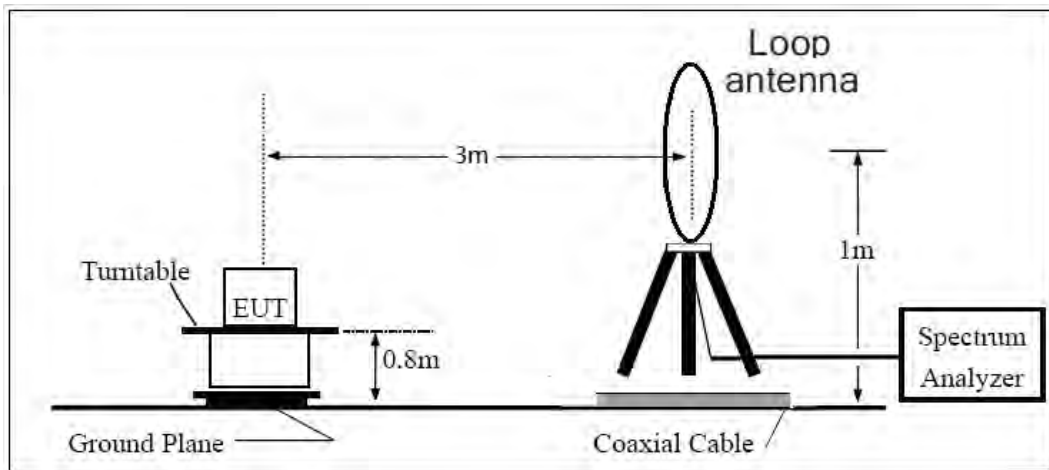

30MHz ~ 1GHz

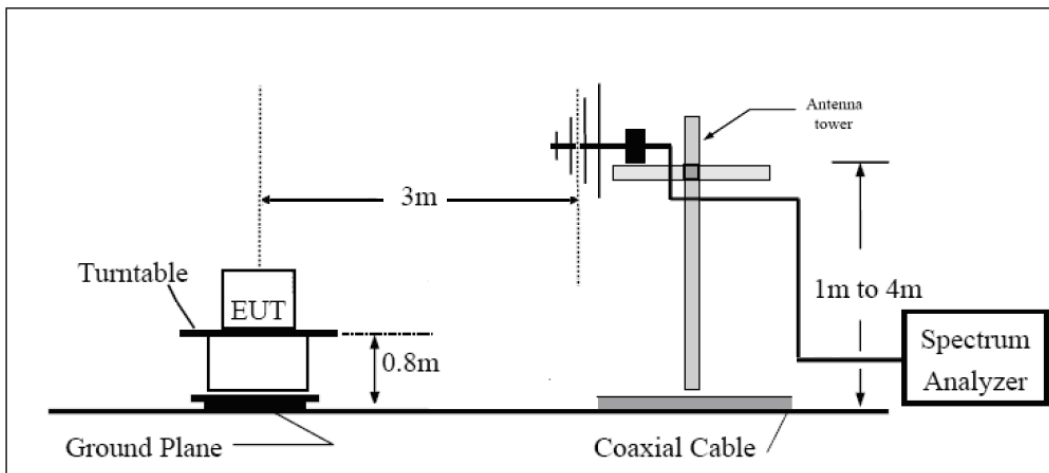

Above 1GHz

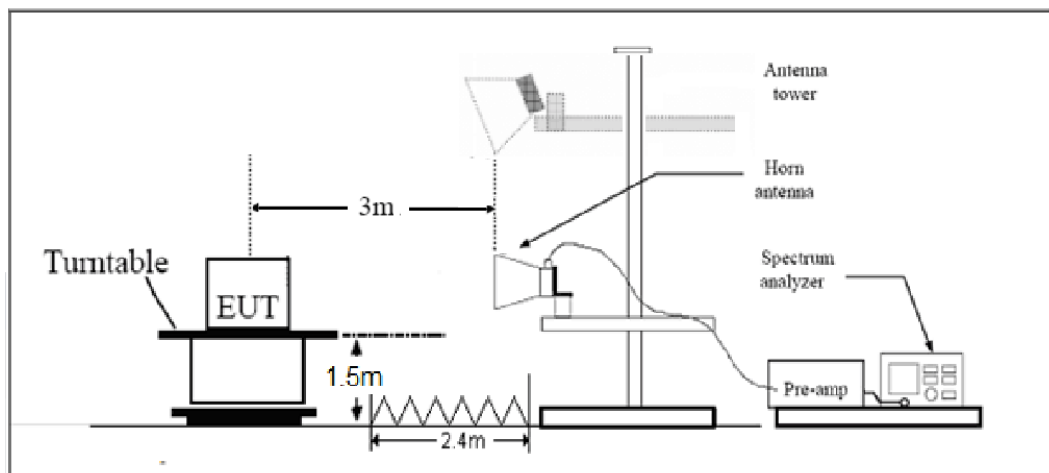

Note: Area side:2.4mX3.6m

**Limits**

Rule Part 15.247(d) specifies that “In addition, radiated emissions which fall in the restricted bands, as defined in § 15.205(a), must also comply with the radiated emission limits specified in § 15.209(a) (see § 15.205(c)).”

Limit in restricted band

Frequency of emission (MHz)	Field strength(uV/m)	Field strength(dBuV/m)
0.009–0.490	2400/F(kHz)	/
0.490–1.705	24000/F(kHz)	/
1.705–30.0	30	/
30-88	100	40
88-216	150	43.5
216-960	200	46
Above960	500	54

§15.35(b)

There is also a limit on the radio frequency emissions, as measured using instrumentation with a peak detector function, corresponding to 20 dB above the maximum permitted average limit.

Peak Limit=74 dBuV/m

Average Limit=54 dBuV/m



Spurious Radiated Emissions are permitted in any of the frequency bands listed below:

MHz	MHz	MHz	GHz
0.090-0.110	16.42-16.423	399.9-410	4.5-5.15
¹ 0.495-0.505	16.69475-16.69525	608-614	5.35-5.46
2.1735-2.1905	16.80425-16.80475	960-1240	7.25-7.75
4.125-4.128	25.5-25.67	1300-1427	8.025-8.5
4.17725-4.17775	37.5-38.25	1435-1626.5	9.0-9.2
4.20725-4.20775	73-74.6	1645.5-1646.5	9.3-9.5
6.215-6.218	74.8-75.2	1660-1710	10.6-12.7
6.26775-6.26825	108-121.94	1718.8-1722.2	13.25-13.4
6.31175-6.31225	123-138	2200-2300	14.47-14.5
8.291-8.294	149.9-150.05	2310-2390	15.35-16.2
8.362-8.366	156.52475-156.52525	2483.5-2500	17.7-21.4
8.37625-8.38675	156.7-156.9	2690-2900	22.01-23.12
8.41425-8.41475	162.0125-167.17	3260-3267	23.6-24.0
12.29-12.293	167.72-173.2	3332-3339	31.2-31.8
12.51975-12.52025	240-285	3345.8-3358	36.43-36.5
12.57675-12.57725	322-335.4	3600-4400	(²)
13.36-13.41			

Measurement Uncertainty

The assessed measurement uncertainty to ensure 95% confidence level for the normal distribution is with the coverage factor $k = 1.96$.

Frequency	Uncertainty
9KHz-30MHz	3.55 dB
30MHz-200MHz	4.17 dB
200MHz-1GHz	4.84 dB
1-18GHz	4.35 dB
18-26.5GHz	5.90 dB
26.5GHz~40GHz	5.92 dB



Test Results:

A font (dB μ V/m) in the test plot = (dB μ V/m)

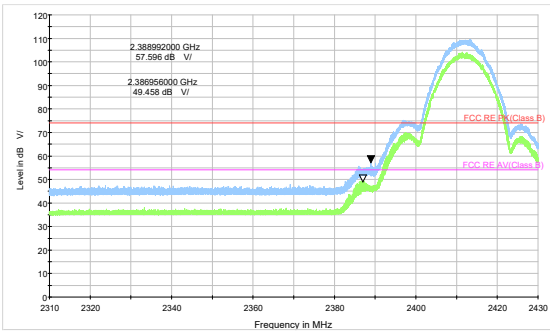

802.11b-Channel 1 Peak+ Average

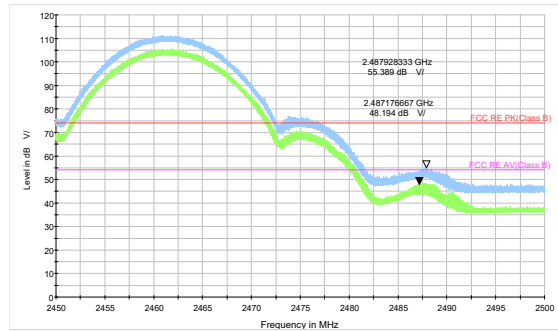

802.11b-Channel 11 Peak+ Average

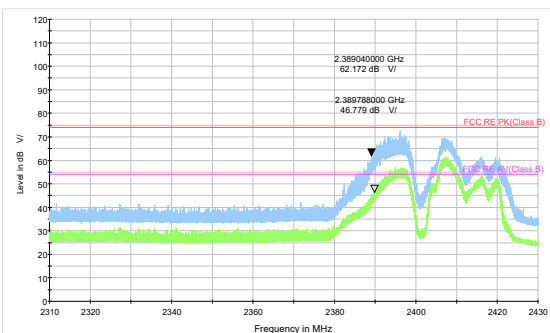

802.11g-Channel 1 Peak+ Average

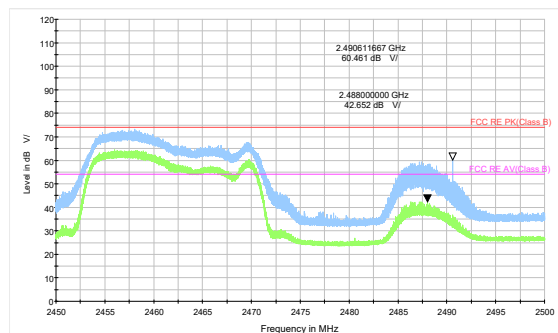

802.11g-Channel 11 Peak+ Average

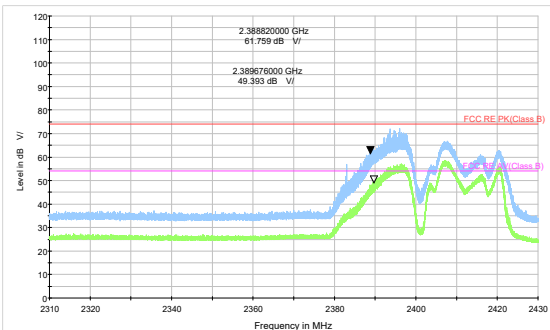

802.11n HT20 -Channel 1 Peak+ Average

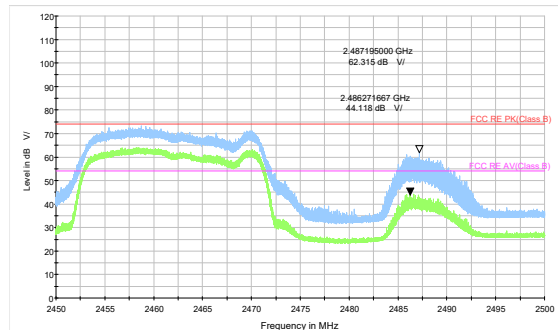

802.11n HT20 -Channel 11 Peak+ Average

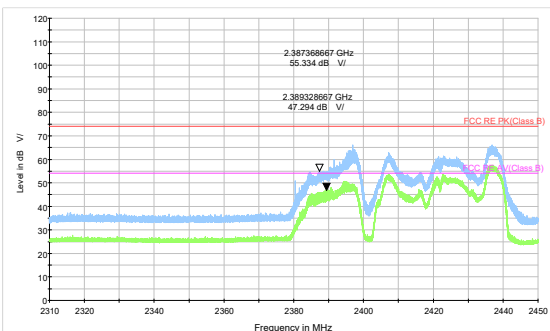

802.11n HT40 -Channel 3 Peak+ Average

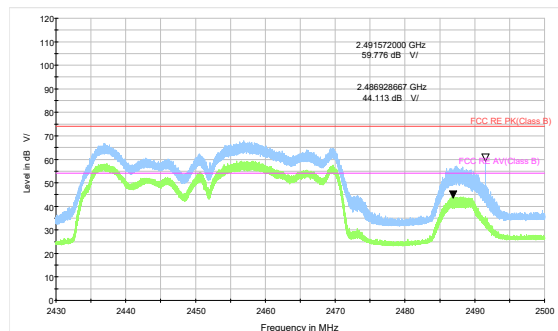

802.11n HT40 -Channel 9 Peak+ Average

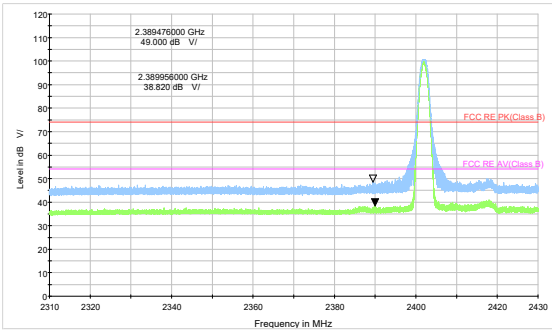

Bluetooth LE Channel 0 Peak+ Average

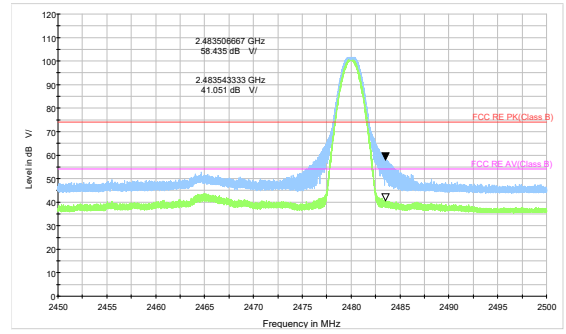

Bluetooth LE Channel 39 Peak+Average

Result of RE

Test result

Sweep the whole frequency band through the range from 9kHz to the 10th harmonic of the carrier, the Emissions in the frequency band 9kHz-30MHz and 18GHz-26.5GHz are more than 20dB below the limit are not reported.

The following graphs display the maximum values of horizontal and vertical by software. For above 1GHz, Blue trace uses the peak detection, Green trace uses the average detection.

During the test, the Radiates Emission from 30MHz to 1GHz was performed in all modes with all channels, 802.11g CH6 and Bluetooth LE-Channel 0 are selected as the worst condition. The test data of the worst-case condition was recorded in this report.

A font ($\text{Level in dB}\mu\text{V/}$)in the test plot =(level in dB $\mu\text{V/m}$)

A font (dB V/)in the test plot =(dB $\mu\text{V/m}$)

Continuous TX mode:

FCC RE 9K-90KHz AV

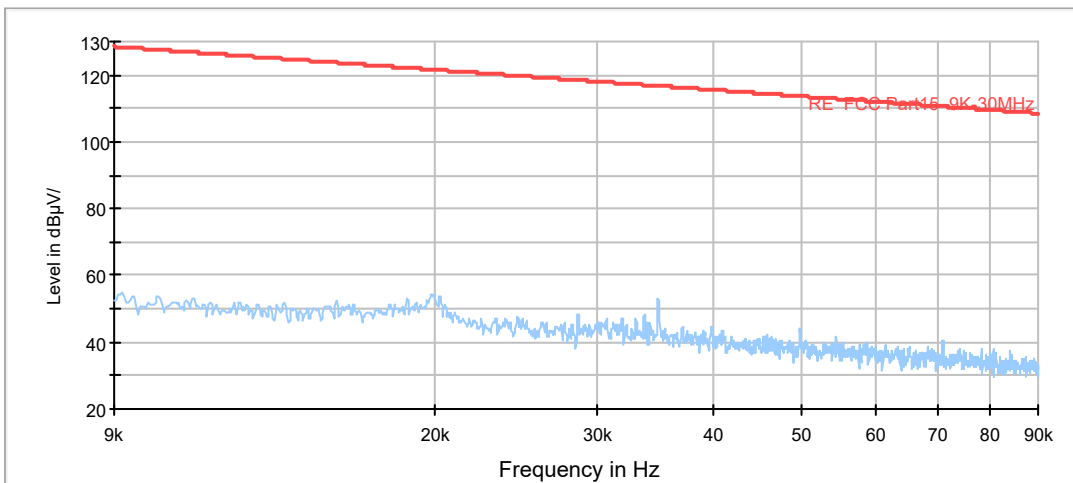

Radiates Emission from 9KHz to 90KHz



FCC RE 90K-110KHz QP

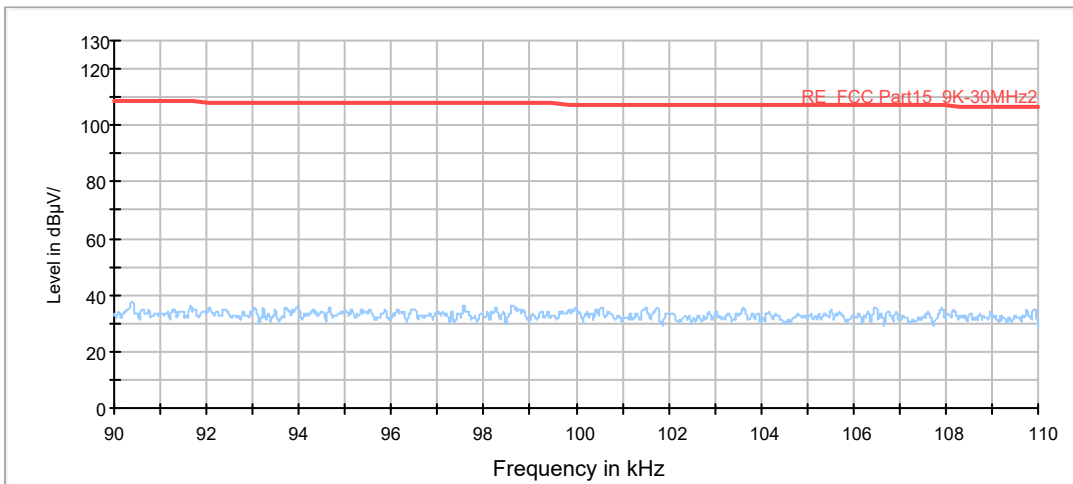

Radiates Emission from 90KHz to 110KHz

FCC RE 110K-490KHz AV

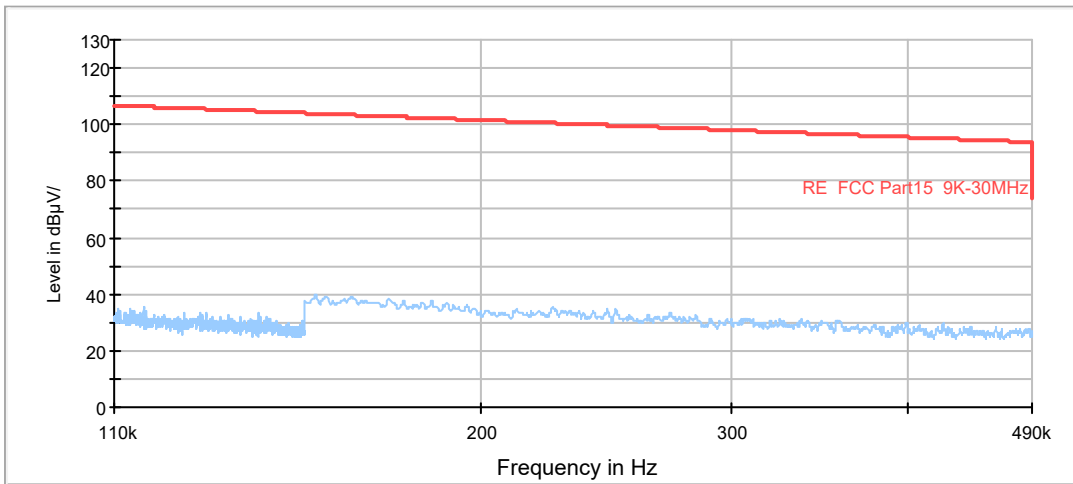

Radiates Emission from 110KHz to 490KHz

FCC RE 490K-30MHz QP

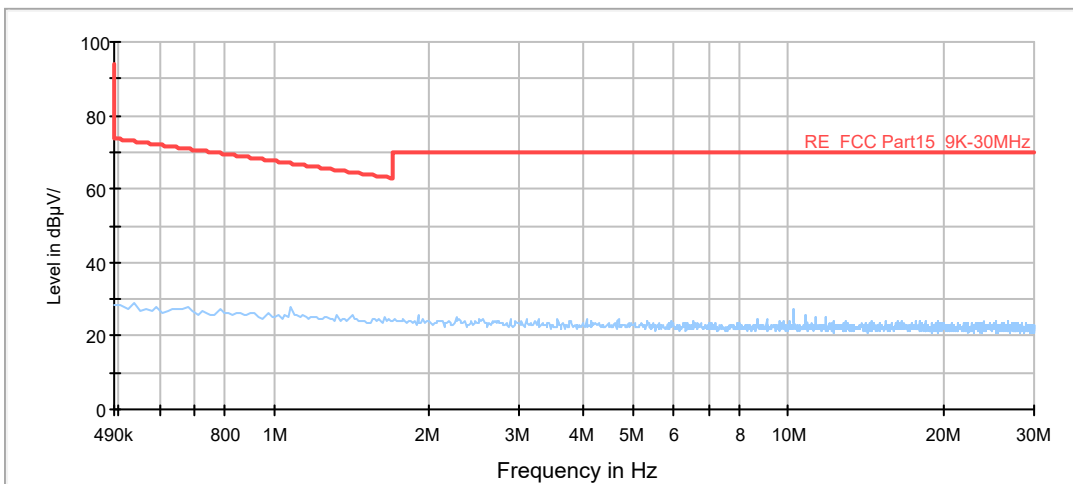

Radiates Emission from 490KHz to 30MHz



Wi-Fi 2.4G:

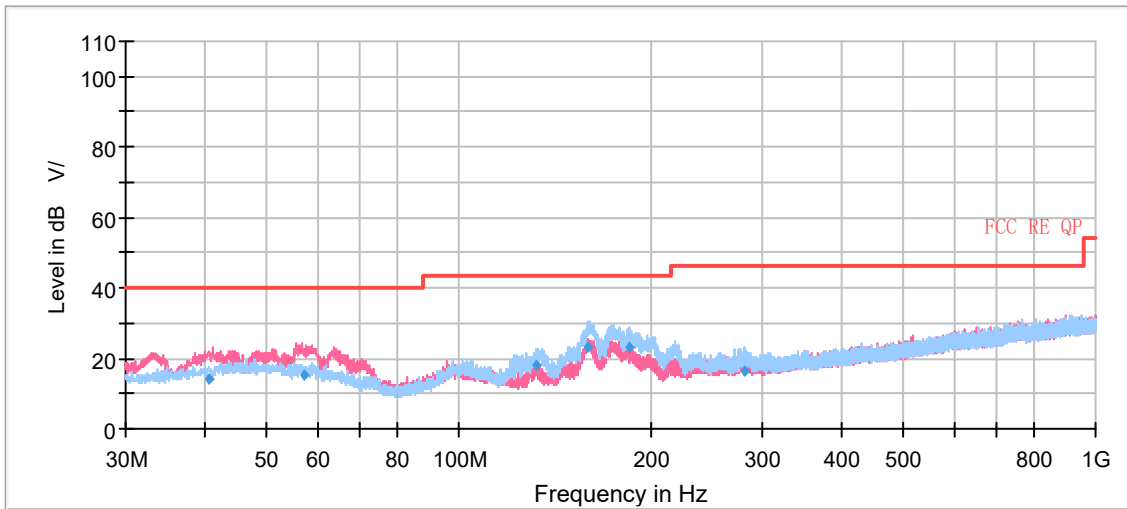

Radiates Emission from 30MHz to 1GHz

Frequency (MHz)	Quasi-Peak (dBuV/m)	Height (cm)	Polarization	Azimuth (deg)	Correct Factor (dB)	Margin (dB)	Limit (dBuV/m)
40.635000	14.33	100.0	V	13.0	20	25.67	40.00
57.082667	15.49	110.0	V	0.0	20	24.51	40.00
132.801333	18.06	225.0	H	85.0	15	25.44	43.50
159.879667	23.26	175.0	H	237.0	15	20.24	43.50
185.311333	23.08	175.0	H	83.0	17	20.42	43.50
281.631667	16.19	110.0	H	64.0	20	29.81	46.00

Remark: 1. Correction Factor = Antenna factor+ Insertion loss(cable loss+amplifier gain)

2. Margin = Limit – Quasi-Peak

Bluetooth LE:

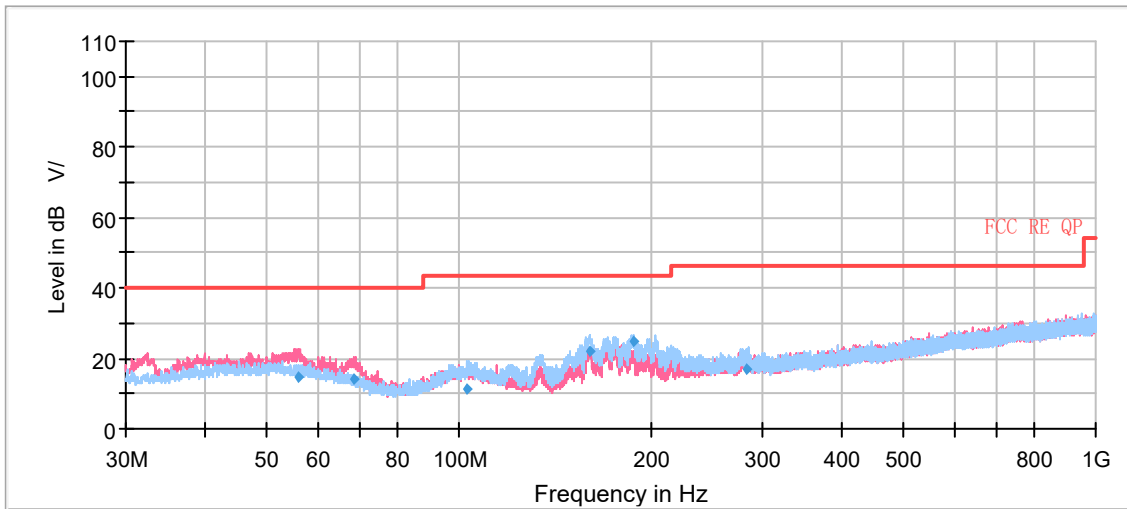

Radiates Emission from 30MHz to 1GHz

Frequency (MHz)	Quasi-Peak (dBuV/m)	Height (cm)	Polarization	Azimuth (deg)	Correct Factor (dB)	Margin (dB)	Limit (dBuV/m)
55.874333	14.75	100.0	V	88.0	20	25.25	40.00
68.531000	13.94	100.0	V	21.0	17	26.06	40.00
103.287000	11.54	210.0	H	244.0	19	31.96	43.50
160.832667	22.27	184.0	H	76.0	15	21.23	43.50
187.704000	24.86	175.0	H	76.0	17	18.64	43.50
283.764667	17.12	100.0	H	60.0	20	28.88	46.00

Remark: 1. Correction Factor = Antenna factor+ Insertion loss(cable loss+amplifier gain)

2. Margin = Limit – Quasi-Peak



802.11b CH1

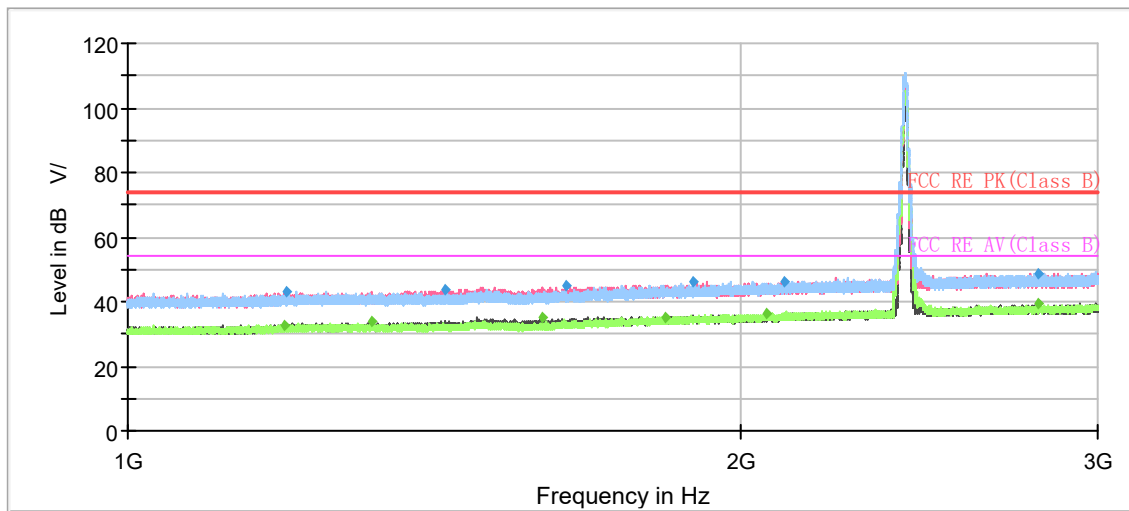

Note: The signal beyond the limit is carrier.

Radiates Emission from 1GHz to 3GHz

Frequency (MHz)	MaxPeak (dB μ V/m)	Average (dB μ V/m)	Limit (dB μ V/m)	Margin (dB)	Height (cm)	Pol	Azimuth (deg)	Corr. (dB/m)
1193.133333	---	32.86	54.00	21.14	200.0	H	0.0	-8
1196.066667	43.15	---	74.00	30.85	100.0	V	185.0	-8
1317.733333	---	33.75	54.00	20.25	200.0	H	104.0	-7
1432.333333	43.57	---	74.00	30.43	100.0	V	266.0	-6
1600.066667	---	35.08	54.00	18.92	100.0	V	185.0	-5
1641.666667	44.77	---	74.00	29.23	100.0	V	2.0	-5
1839.133333	---	35.33	54.00	18.67	100.0	V	38.0	-4
1897.533333	46.11	---	74.00	27.89	100.0	V	68.0	-4
2060.600000	---	36.30	54.00	17.70	100.0	H	119.0	-3
2105.333333	45.95	---	74.00	28.05	200.0	V	268.0	-2
2802.333333	---	39.60	54.00	14.40	200.0	H	82.0	1
2803.333333	48.82	---	74.00	25.18	200.0	H	0.0	1

Remark: 1. Correction Factor = Antenna factor+ Insertion loss (cable loss + amplifier gain)

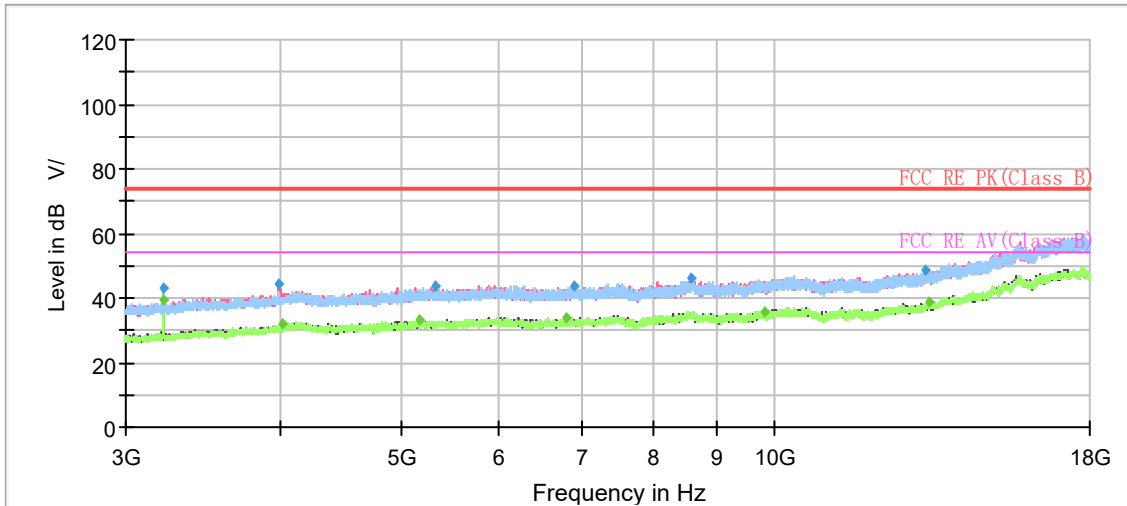

Radiates Emission from 3GHz to 18GHz

Frequency (MHz)	MaxPeak (dB μ V/m)	Average (dB μ V/m)	Limit (dB μ V/m)	Margin (dB)	Height (cm)	Pol	Azimuth (deg)	Corr. (dB/m)
3216.000000	---	39.51	54.00	14.49	100.0	H	309.0	-8
3216.000000	42.95	---	74.00	31.05	200.0	H	307.0	-8
3985.000000	44.01	---	74.00	29.99	200.0	V	251.0	-4
4020.500000	---	32.11	54.00	21.89	200.0	V	344.0	-4
5179.500000	---	33.21	54.00	20.79	200.0	H	323.0	-1
5327.000000	43.42	---	74.00	30.58	200.0	H	220.0	-1
6801.000000	---	34.00	54.00	20.00	200.0	H	189.0	0
6913.500000	43.94	---	74.00	30.06	200.0	H	58.0	1
8583.000000	46.12	---	74.00	27.88	100.0	V	208.0	4
9848.000000	---	35.95	54.00	18.05	200.0	V	171.0	4
13254.000000	48.73	---	74.00	25.27	200.0	V	227.0	9
13348.500000	---	38.91	54.00	15.09	200.0	H	58.0	9

Remark: 1. Correction Factor = Antenna factor+ Insertion loss (cable loss + amplifier gain)



802.11b CH6

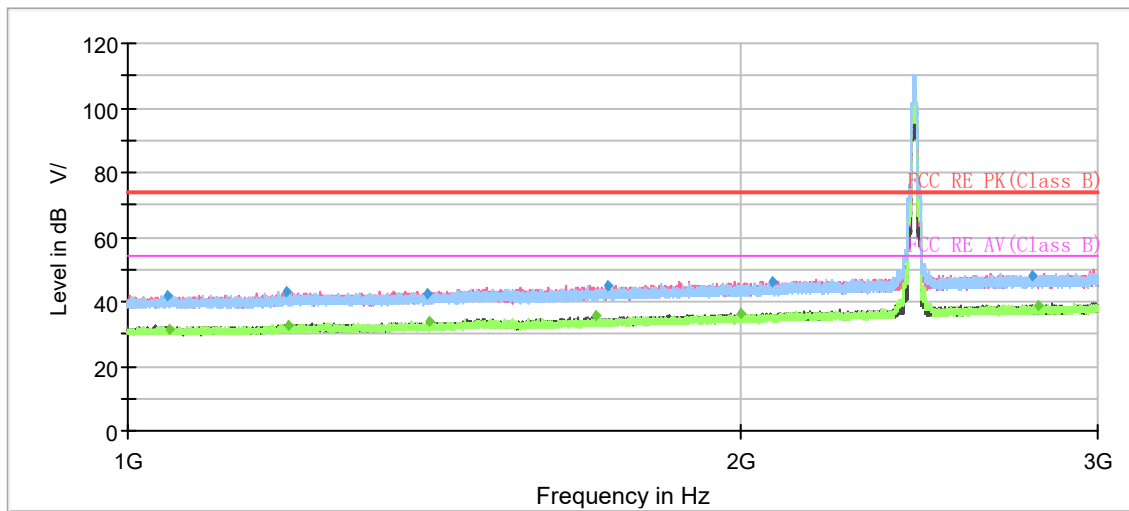

Note: The signal beyond the limit is carrier.

Radiates Emission from 1GHz to 3GHz

Frequency (MHz)	MaxPeak (dB μ V/m)	Average (dB μ V/m)	Limit (dB μ V/m)	Margin (dB)	Height (cm)	Pol	Azimuth (deg)	Corr. (dB/m)
1046.666667	41.72	---	74.00	32.28	200.0	V	270.0	-9
1048.200000	---	31.66	54.00	22.34	200.0	V	233.0	-9
1196.533333	42.99	---	74.00	31.01	200.0	V	175.0	-8
1200.533333	---	32.85	54.00	21.15	200.0	H	0.0	-8
1403.066667	42.65	---	74.00	31.35	100.0	V	317.0	-6
1405.866667	---	33.71	54.00	20.29	100.0	V	264.0	-6
1700.333333	---	35.39	54.00	18.61	100.0	V	349.0	-5
1723.600000	45.12	---	74.00	28.88	100.0	V	287.0	-4
2002.866667	---	36.24	54.00	17.76	100.0	V	272.0	-3
2075.400000	46.29	---	74.00	27.71	200.0	H	10.0	-3
2787.600000	48.25	---	74.00	25.75	100.0	V	272.0	1
2805.333333	---	38.61	54.00	15.39	100.0	V	287.0	1

Remark: 1. Correction Factor = Antenna factor+ Insertion loss (cable loss + amplifier gain)

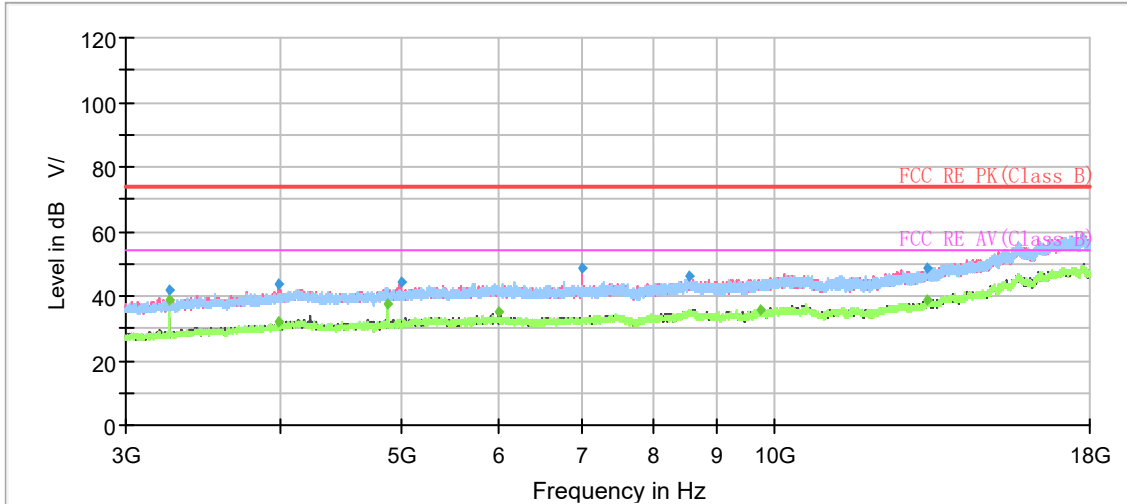

Radiates Emission from 3GHz to 18GHz

Frequency (MHz)	MaxPeak (dB μ V/m)	Average (dB μ V/m)	Limit (dB μ V/m)	Margin (dB)	Height (cm)	Pol	Azimuth (deg)	Corr. (dB/m)
3249.000000	---	38.79	54.00	15.21	100.0	H	261.0	-7
3249.500000	41.97	---	74.00	32.03	100.0	H	269.0	-7
3991.500000	43.85	---	74.00	30.15	200.0	V	235.0	-4
3992.000000	---	32.20	54.00	21.80	200.0	V	138.0	-4
4874.000000	---	37.52	54.00	16.48	100.0	H	301.0	-2
4999.000000	44.05	---	74.00	29.95	200.0	V	105.0	-1
5999.500000	---	34.85	54.00	19.15	100.0	V	89.0	0
6994.000000	48.67	---	74.00	25.33	100.0	V	339.0	1
8546.500000	45.94	---	74.00	28.06	100.0	V	300.0	4
9751.000000	---	35.76	54.00	18.24	200.0	V	123.0	4
13299.000000	---	38.81	54.00	15.19	200.0	H	250.0	9
13327.500000	48.75	---	74.00	25.25	200.0	H	250.0	9

Remark: 1. Correction Factor = Antenna factor+ Insertion loss (cable loss + amplifier gain)



802.11b CH11

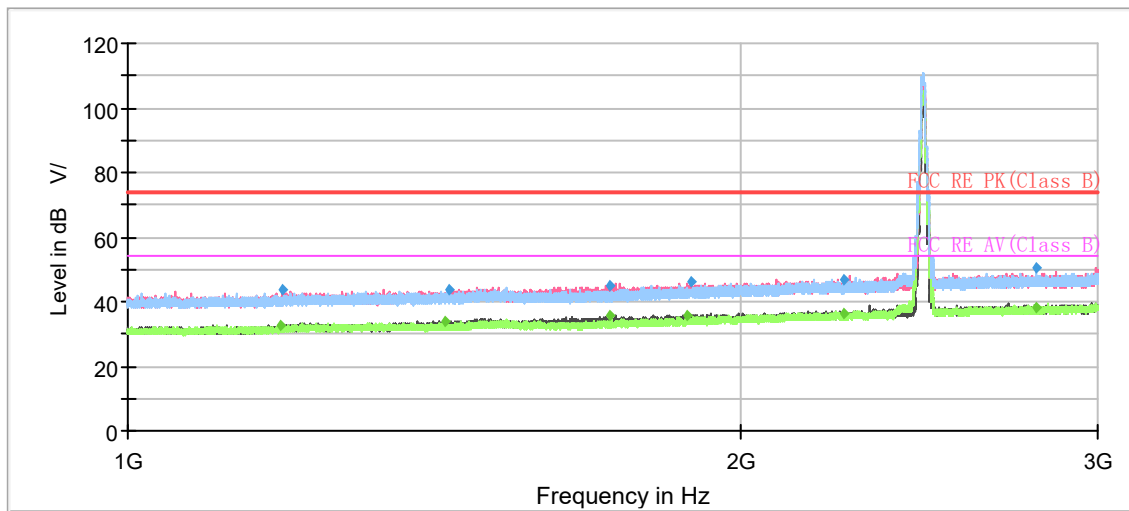

Note: The signal beyond the limit is carrier.

Radiates Emission from 1GHz to 3GHz

Frequency (MHz)	MaxPeak (dB μ V/m)	Average (dB μ V/m)	Limit (dB μ V/m)	Margin (dB)	Height (cm)	Pol	Azimuth (deg)	Corr. (dB/m)
1190.066667	---	32.87	54.00	21.13	100.0	V	358.0	-8
1192.533333	43.68	---	74.00	30.32	100.0	V	321.0	-8
1434.000000	---	33.72	54.00	20.28	100.0	V	0.0	-6
1438.733333	43.43	---	74.00	30.57	200.0	V	149.0	-6
1724.533333	45.04	---	74.00	28.96	100.0	V	200.0	-4
1725.000000	---	35.41	54.00	18.59	100.0	V	306.0	-4
1884.133333	---	35.41	54.00	18.59	100.0	V	321.0	-4
1894.266667	46.20	---	74.00	27.80	100.0	V	299.0	-4
2249.933333	---	36.38	54.00	17.62	100.0	H	68.0	-2
2252.666667	47.03	---	74.00	26.97	100.0	V	239.0	-2
2797.533333	50.54	---	74.00	23.46	200.0	H	5.0	1
2800.466667	---	38.30	54.00	15.70	100.0	V	269.0	1

Remark: 1. Correction Factor = Antenna factor+ Insertion loss (cable loss + amplifier gain)

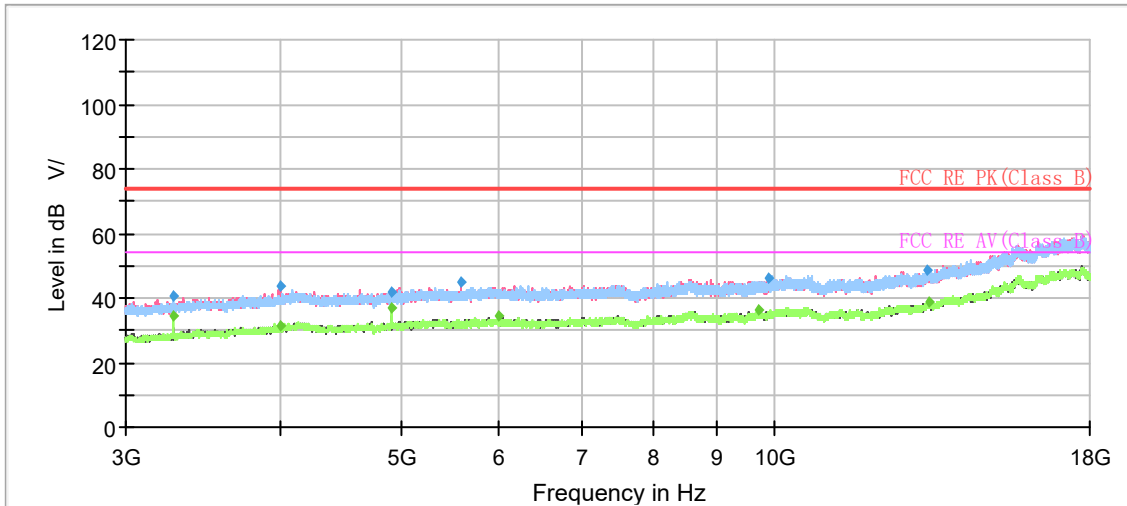

Radiates Emission from 3GHz to 18GHz

Frequency (MHz)	MaxPeak (dB μ V/m)	Average (dB μ V/m)	Limit (dB μ V/m)	Margin (dB)	Height (cm)	Pol	Azimuth (deg)	Corr. (dB/m)
3282.000000	40.43	---	74.00	33.57	200.0	H	316.0	-7
3282.500000	---	34.72	54.00	19.28	200.0	H	300.0	-7
3995.500000	43.45	---	74.00	30.55	200.0	V	133.0	-4
4003.500000	---	31.37	54.00	22.63	100.0	H	14.0	-4
4921.500000	41.88	---	74.00	32.12	100.0	H	212.0	-2
4924.000000	---	36.71	54.00	17.29	200.0	H	300.0	-2
5593.500000	45.19	---	74.00	28.81	100.0	V	298.0	0
6002.500000	---	34.50	54.00	19.50	200.0	V	157.0	0
9715.000000	---	36.03	54.00	17.97	200.0	H	308.0	4
9888.000000	45.97	---	74.00	28.03	100.0	V	283.0	4
13318.000000	48.76	---	74.00	25.24	200.0	V	0.0	9
13333.500000	---	38.66	54.00	15.34	100.0	V	322.0	9

Remark: 1. Correction Factor = Antenna factor+ Insertion loss (cable loss + amplifier gain)



802.11g CH1

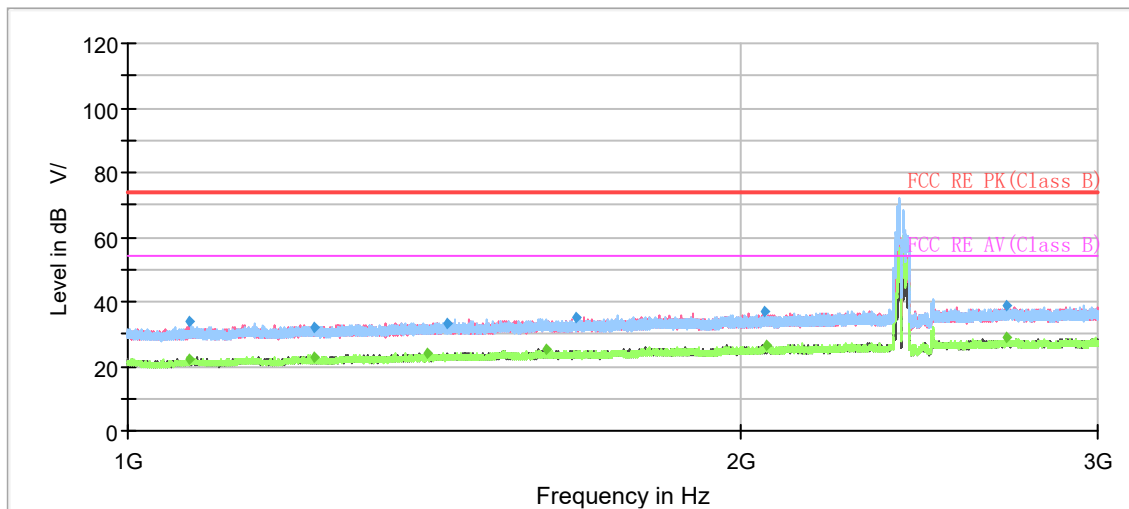

Note: The signal beyond the limit is carrier.

Radiates Emission from 1GHz to 3GHz

Frequency (MHz)	MaxPeak (dB μ V/m)	Average (dB μ V/m)	Limit (dB μ V/m)	Margin (dB)	Height (cm)	Pol	Azimuth (deg)	Corr. (dB/m)
1071.600000	33.75	---	74.00	40.25	100.0	V	96.0	-18
1071.733333	---	21.92	54.00	32.08	200.0	H	154.0	-18
1234.666667	---	22.48	54.00	31.52	100.0	V	9.0	-17
1234.800000	32.23	---	74.00	41.77	200.0	H	216.0	-17
1402.800000	---	23.90	54.00	30.10	100.0	V	184.0	-16
1435.133333	33.47	---	74.00	40.53	200.0	V	188.0	-16
1606.333333	---	25.37	54.00	28.63	200.0	H	253.0	-15
1662.066667	35.23	---	74.00	38.77	100.0	V	24.0	-15
2056.666667	36.72	---	74.00	37.28	200.0	H	95.0	-13
2059.666667	---	26.22	54.00	27.78	200.0	H	117.0	-13
2706.466667	---	29.06	54.00	24.94	200.0	V	260.0	-9
2707.800000	39.01	---	74.00	34.99	100.0	H	256.0	-9

Remark: 1. Correction Factor = Antenna factor+ Insertion loss (cable loss + amplifier gain)

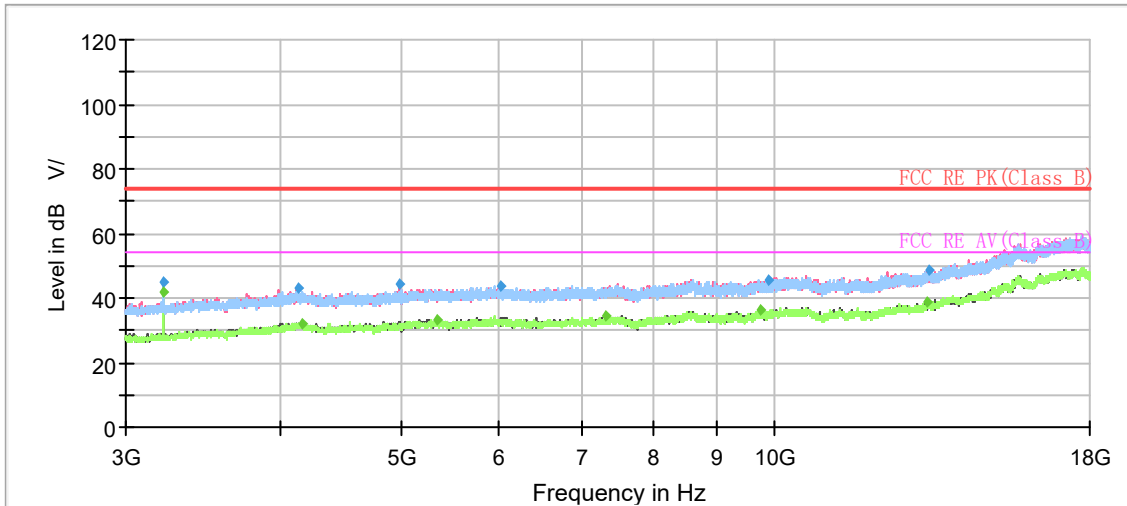

Radiates Emission from 3GHz to 18GHz

Frequency (MHz)	MaxPeak (dB μ V/m)	Average (dB μ V/m)	Limit (dB μ V/m)	Margin (dB)	Height (cm)	Pol	Azimuth (deg)	Corr. (dB/m)
3216.000000	---	41.90	54.00	12.10	100.0	H	311.0	-8
3216.000000	44.80	---	74.00	29.20	100.0	H	311.0	-8
4138.000000	43.30	---	74.00	30.70	100.0	H	0.0	-3
4161.500000	---	32.03	54.00	21.97	100.0	V	289.0	-3
4983.500000	44.50	---	74.00	29.50	200.0	V	34.0	-1
5360.500000	---	33.16	54.00	20.84	200.0	H	224.0	-1
6024.500000	43.76	---	74.00	30.24	100.0	V	39.0	0
7332.000000	---	34.19	54.00	19.81	100.0	H	269.0	1
9754.000000	---	36.59	54.00	17.41	200.0	V	151.0	4
9900.000000	45.56	---	74.00	28.44	100.0	V	144.0	4
13324.500000	---	38.56	54.00	15.44	100.0	H	93.0	9
13351.500000	48.66	---	74.00	25.34	100.0	V	120.0	9

Remark: 1. Correction Factor = Antenna factor+ Insertion loss (cable loss + amplifier gain)



802.11g CH6

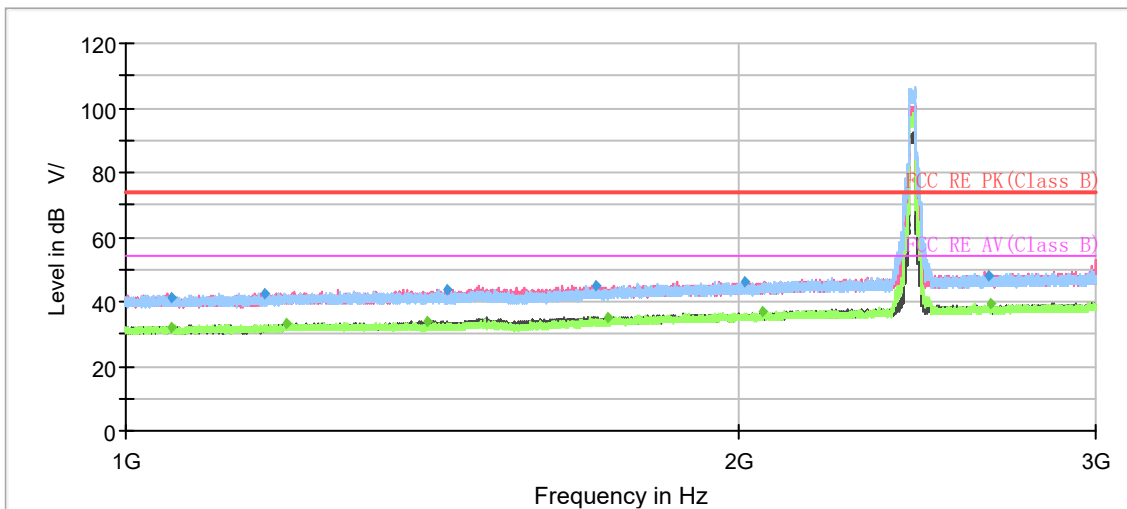

Note: The signal beyond the limit is carrier.

Radiates Emission from 1GHz to 3GHz

Frequency (MHz)	MaxPeak (dB μ V/m)	Average (dB μ V/m)	Limit (dB μ V/m)	Margin (dB)	Height (cm)	Pol	Azimuth (deg)	Corr. (dB/m)
1052.200000	41.13	---	74.00	32.87	100.0	H	0.0	-9
1052.666667	---	31.94	54.00	22.06	100.0	V	18.0	-9
1171.400000	42.54	---	74.00	31.46	100.0	H	352.0	-8
1198.600000	---	32.99	54.00	21.01	100.0	V	92.0	-8
1405.933333	---	34.00	54.00	20.00	100.0	V	55.0	-6
1438.333333	43.89	---	74.00	30.11	100.0	V	25.0	-6
1704.600000	45.02	---	74.00	28.98	100.0	V	70.0	-5
1724.600000	---	35.09	54.00	18.91	100.0	V	48.0	-4
2015.133333	46.16	---	74.00	27.84	200.0	V	166.0	-3
2055.800000	---	36.66	54.00	17.34	100.0	H	345.0	-3
2659.533333	47.93	---	74.00	26.07	200.0	V	328.0	0
2660.866667	---	39.52	54.00	14.48	200.0	V	313.0	0

Remark: 1. Correction Factor = Antenna factor+ Insertion loss (cable loss + amplifier gain)

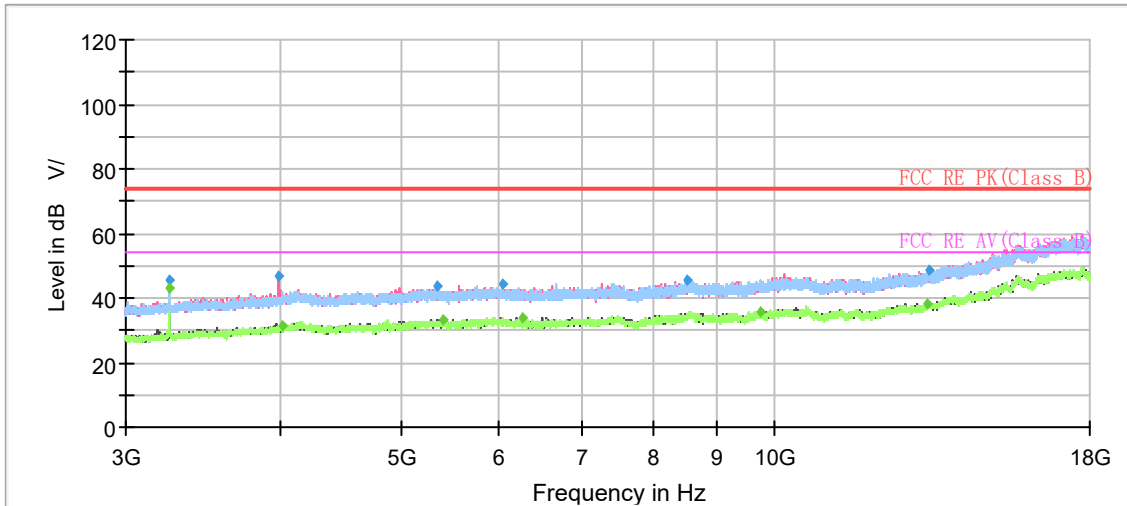

Radiates Emission from 3GHz to 18GHz

Frequency (MHz)	MaxPeak (dB μ V/m)	Average (dB μ V/m)	Limit (dB μ V/m)	Margin (dB)	Height (cm)	Pol	Azimuth (deg)	Corr. (dB/m)
3249.000000	45.49	---	74.00	28.51	100.0	H	312.0	-7
3249.000000	---	42.95	54.00	11.05	100.0	H	312.0	-7
3987.500000	46.69	---	74.00	27.31	200.0	V	167.0	-4
4018.500000	---	31.27	54.00	22.73	100.0	V	0.0	-4
5359.500000	43.48	---	74.00	30.52	200.0	V	151.0	-1
5409.000000	---	33.45	54.00	20.55	200.0	V	151.0	-1
6053.000000	44.52	---	74.00	29.48	200.0	V	109.0	0
6278.500000	---	33.97	54.00	20.03	100.0	H	33.0	0
8521.000000	45.60	---	74.00	28.40	100.0	H	41.0	4
9745.500000	---	35.99	54.00	18.01	200.0	V	125.0	4
13315.500000	---	38.46	54.00	15.54	200.0	V	221.0	9
13336.500000	48.63	---	74.00	25.37	200.0	V	312.0	9

Remark: 1. Correction Factor = Antenna factor+ Insertion loss (cable loss + amplifier gain)



802.11g CH11

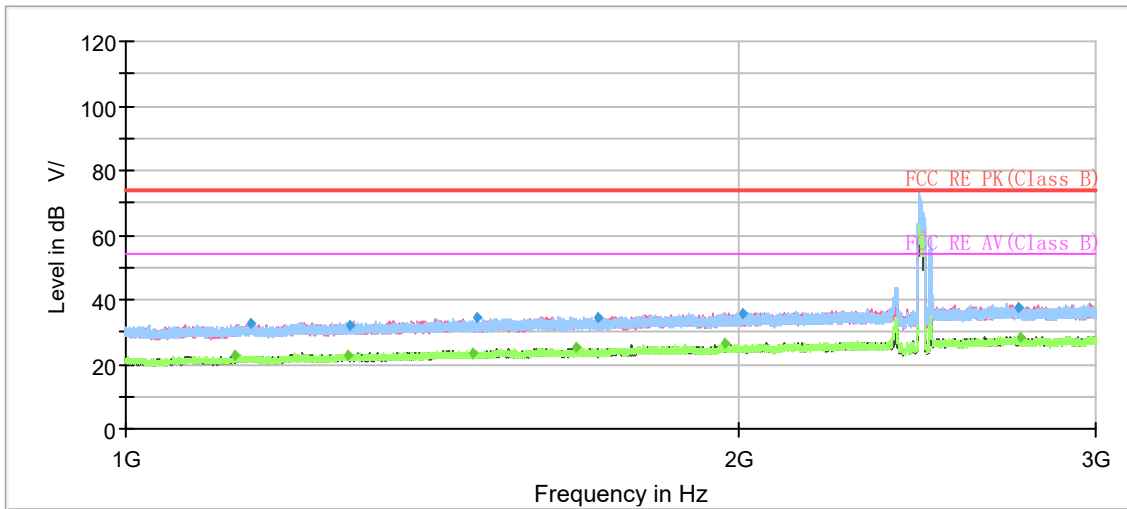

Note: The signal beyond the limit is carrier.

Radiates Emission from 1GHz to 3GHz

Frequency (MHz)	MaxPeak (dB μ V/m)	Average (dB μ V/m)	Limit (dB μ V/m)	Margin (dB)	Height (cm)	Pol	Azimuth (deg)	Corr. (dB/m)
1132.533333	---	22.52	54.00	31.48	200.0	H	169.0	-18
1153.333333	32.88	---	74.00	41.12	200.0	H	146.0	-18
1287.333333	---	22.90	54.00	31.10	200.0	H	315.0	-17
1288.600000	32.11	---	74.00	41.89	100.0	V	95.0	-17
1480.266667	---	23.36	54.00	30.64	100.0	V	0.0	-16
1489.533333	34.61	---	74.00	39.39	200.0	H	183.0	-16
1667.000000	---	24.94	54.00	29.06	200.0	V	156.0	-15
1705.466667	34.45	---	74.00	39.55	200.0	H	234.0	-15
1969.400000	---	26.40	54.00	27.60	200.0	H	212.0	-13
2013.333333	35.98	---	74.00	38.02	200.0	H	242.0	-13
2748.066667	37.62	---	74.00	36.38	100.0	V	274.0	-9
2751.533333	---	28.05	54.00	25.95	100.0	V	357.0	-9

Remark: 1. Correction Factor = Antenna factor+ Insertion loss (cable loss + amplifier gain)

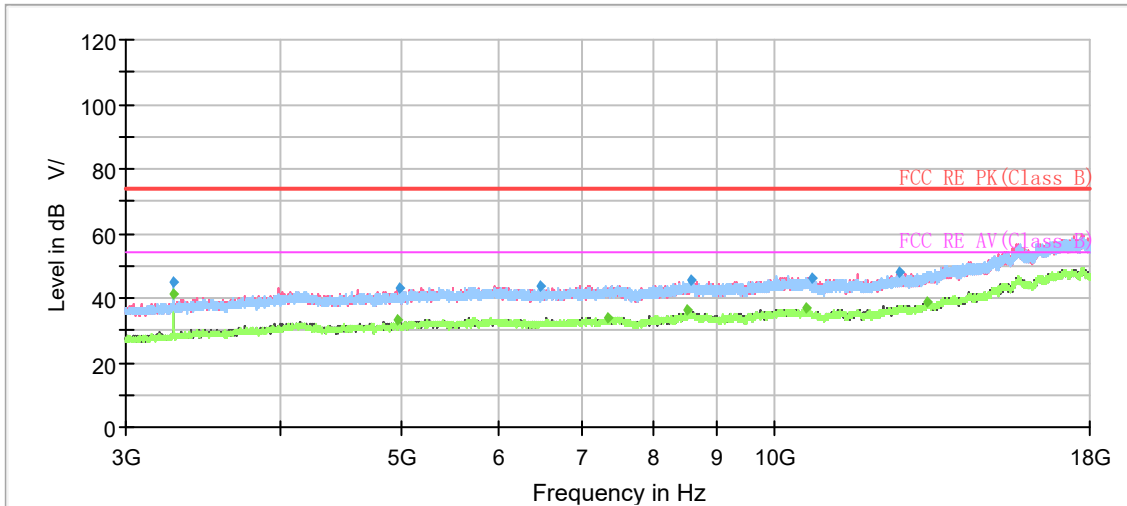

Radiates Emission from 3GHz to 18GHz

Frequency (MHz)	MaxPeak (dB μ V/m)	Average (dB μ V/m)	Limit (dB μ V/m)	Margin (dB)	Height (cm)	Pol	Azimuth (deg)	Corr. (dB/m)
3282.500000	---	41.50	54.00	12.50	100.0	H	311.0	-7
3282.500000	45.04	---	74.00	28.96	100.0	H	311.0	-7
4978.000000	---	33.25	54.00	20.75	200.0	V	106.0	-1
4984.500000	43.23	---	74.00	30.77	200.0	V	130.0	-1
6475.000000	43.79	---	74.00	30.21	200.0	H	285.0	0
7336.500000	---	33.86	54.00	20.14	200.0	H	91.0	1
8527.000000	---	36.18	54.00	17.82	200.0	V	170.0	4
8574.500000	45.37	---	74.00	28.63	200.0	H	325.0	4
10629.500000	---	36.67	54.00	17.33	200.0	V	51.0	5
10726.500000	46.34	---	74.00	27.66	200.0	V	235.0	5
12624.500000	48.14	---	74.00	25.86	200.0	H	108.0	8
13327.000000	---	38.93	54.00	15.07	200.0	H	132.0	9

Remark: 1. Correction Factor = Antenna factor+ Insertion loss (cable loss + amplifier gain)



802.11n (HT20) CH1

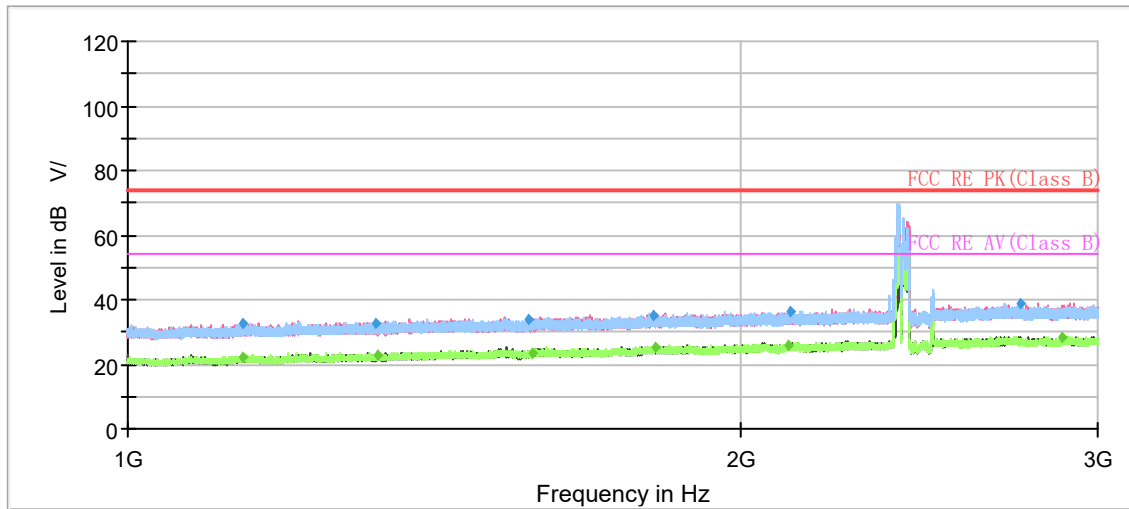

Note: The signal beyond the limit is carrier.

Radiates Emission from 1GHz to 3GHz

Frequency (MHz)	MaxPeak (dB μ V/m)	Average (dB μ V/m)	Limit (dB μ V/m)	Margin (dB)	Height (cm)	Pol	Azimuth (deg)	Corr. (dB/m)
1138.066667	---	22.13	54.00	31.87	100.0	V	196.0	-18
1139.333333	32.41	---	74.00	41.59	100.0	H	108.0	-18
1324.800000	32.67	---	74.00	41.33	200.0	H	0.0	-17
1327.733333	---	22.70	54.00	31.30	100.0	V	188.0	-17
1574.066667	33.58	---	74.00	40.42	100.0	V	232.0	-15
1580.600000	---	23.18	54.00	30.82	200.0	V	324.0	-15
1813.266667	34.86	---	74.00	39.14	200.0	H	273.0	-14
1816.600000	---	25.48	54.00	28.52	200.0	H	296.0	-14
2114.733333	---	26.08	54.00	27.92	100.0	V	204.0	-12
2120.066667	36.01	---	74.00	37.99	200.0	V	119.0	-12
2747.800000	38.60	---	74.00	35.40	100.0	V	328.0	-9
2880.400000	---	28.56	54.00	25.44	200.0	V	17.0	-9

Remark: 1. Correction Factor = Antenna factor+ Insertion loss (cable loss + amplifier gain)

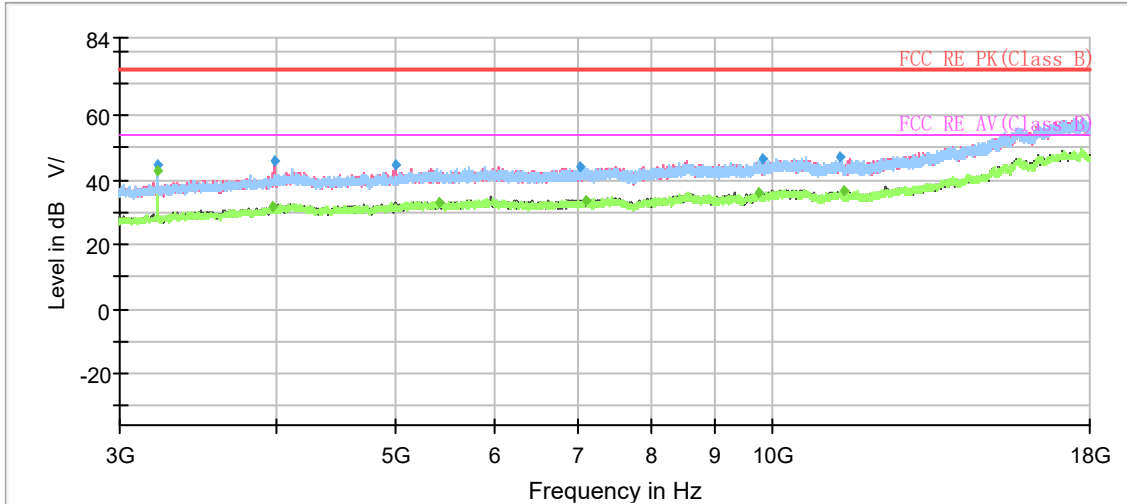

Radiates Emission from 3GHz to 18GHz

Frequency (MHz)	MaxPeak (dB μ V/m)	Average (dB μ V/m)	Limit (dB μ V/m)	Margin (dB)	Height (cm)	Pol	Azimuth (deg)	Corr. (dB/m)
3216.000000	---	42.47	54.00	11.53	100.0	H	221.0	-8
3216.000000	44.57	---	74.00	29.43	100.0	H	221.0	-8
3974.000000	---	31.91	54.00	22.09	100.0	V	81.0	-4
3998.500000	46.06	---	74.00	27.94	200.0	V	143.0	-4
4996.500000	44.44	---	74.00	29.56	200.0	V	101.0	-1
5417.000000	---	33.00	54.00	21.00	200.0	H	258.0	-1
7014.000000	43.71	---	74.00	30.29	200.0	V	158.0	1
7085.000000	---	33.84	54.00	20.16	200.0	V	0.0	1
9751.000000	---	36.07	54.00	17.93	200.0	H	218.0	4
9843.000000	46.38	---	74.00	27.62	100.0	H	6.0	4
11360.000000	46.93	---	74.00	27.07	200.0	V	0.0	6
11407.500000	---	36.53	54.00	17.47	200.0	H	83.0	6

Remark: 1. Correction Factor = Antenna factor+ Insertion loss (cable loss + amplifier gain)



802.11n (HT20) CH6

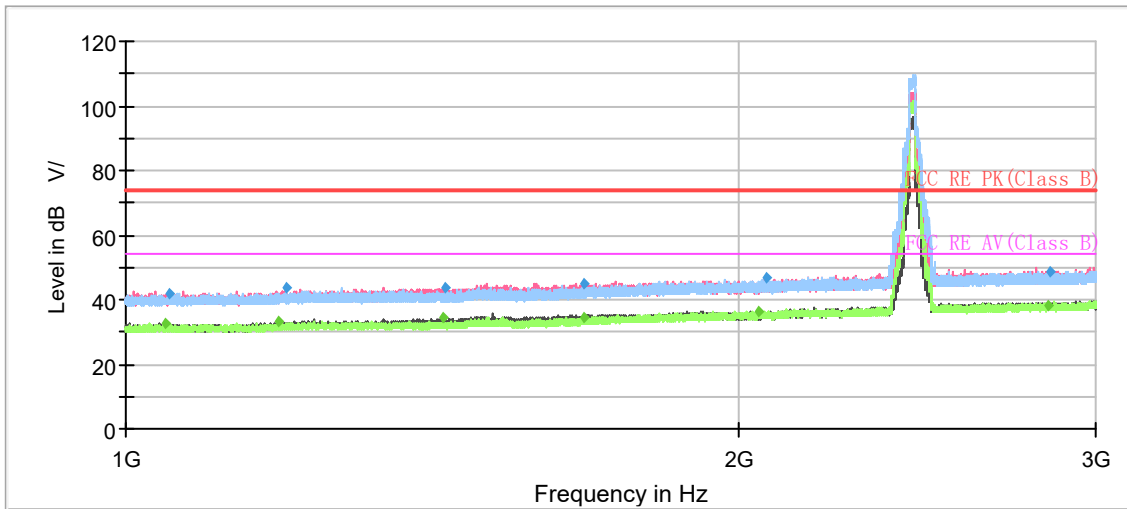

Note: The signal beyond the limit is carrier.

Radiates Emission from 1GHz to 3GHz

Frequency (MHz)	MaxPeak (dB μ V/m)	Average (dB μ V/m)	Limit (dB μ V/m)	Margin (dB)	Height (cm)	Pol	Azimuth (deg)	Corr. (dB/m)
1047.066667	---	32.46	54.00	21.54	200.0	V	318.0	-9
1051.200000	41.75	---	74.00	32.25	200.0	V	276.0	-9
1187.533333	---	32.93	54.00	21.07	200.0	V	348.0	-8
1199.000000	43.86	---	74.00	30.14	100.0	H	191.0	-8
1431.466667	---	34.32	54.00	19.68	200.0	V	261.0	-6
1435.866667	43.89	---	74.00	30.11	200.0	V	231.0	-6
1678.666667	---	34.42	54.00	19.58	200.0	V	111.0	-5
1679.200000	44.86	---	74.00	29.14	200.0	V	276.0	-5
2049.133333	---	36.54	54.00	17.46	100.0	H	121.0	-3
2066.866667	46.49	---	74.00	27.51	200.0	H	350.0	-3
2842.533333	---	38.36	54.00	15.64	200.0	V	209.0	1
2847.400000	48.43	---	74.00	25.57	200.0	V	103.0	1

Remark: 1. Correction Factor = Antenna factor+ Insertion loss (cable loss + amplifier gain)

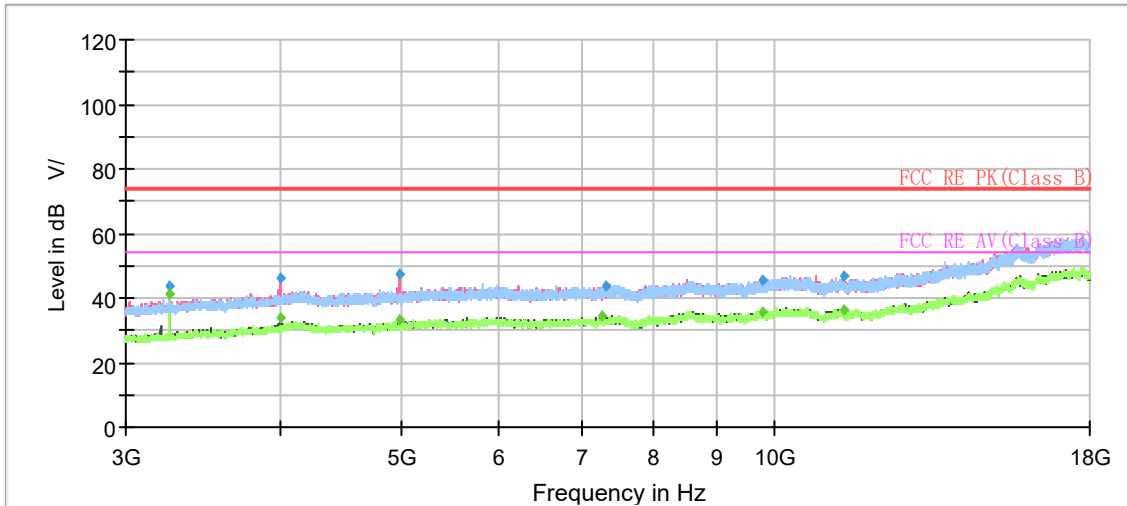

Radiates Emission from 3GHz to 18GHz

Frequency (MHz)	MaxPeak (dB μ V/m)	Average (dB μ V/m)	Limit (dB μ V/m)	Margin (dB)	Height (cm)	Pol	Azimuth (deg)	Corr. (dB/m)
3249.000000	43.85	---	74.00	30.15	100.0	H	295.0	-7
3249.000000	---	41.36	54.00	12.64	100.0	H	295.0	-7
3998.500000	46.10	---	74.00	27.90	200.0	V	140.0	-4
3998.500000	---	34.15	54.00	19.85	200.0	V	140.0	-4
4988.500000	47.49	---	74.00	26.51	200.0	V	38.0	-1
4998.000000	---	33.40	54.00	20.60	200.0	V	109.0	-1
7273.000000	---	34.29	54.00	19.71	100.0	V	344.0	1
7308.000000	43.54	---	74.00	30.46	200.0	V	69.0	1
9783.500000	45.43	---	74.00	28.57	200.0	V	93.0	4
9785.000000	---	35.68	54.00	18.32	200.0	H	15.0	4
11387.500000	46.57	---	74.00	27.43	200.0	H	116.0	6
11398.000000	---	36.45	54.00	17.55	200.0	H	229.0	6

Remark: 1. Correction Factor = Antenna factor+ Insertion loss (cable loss + amplifier gain)



802.11n (HT20) CH11

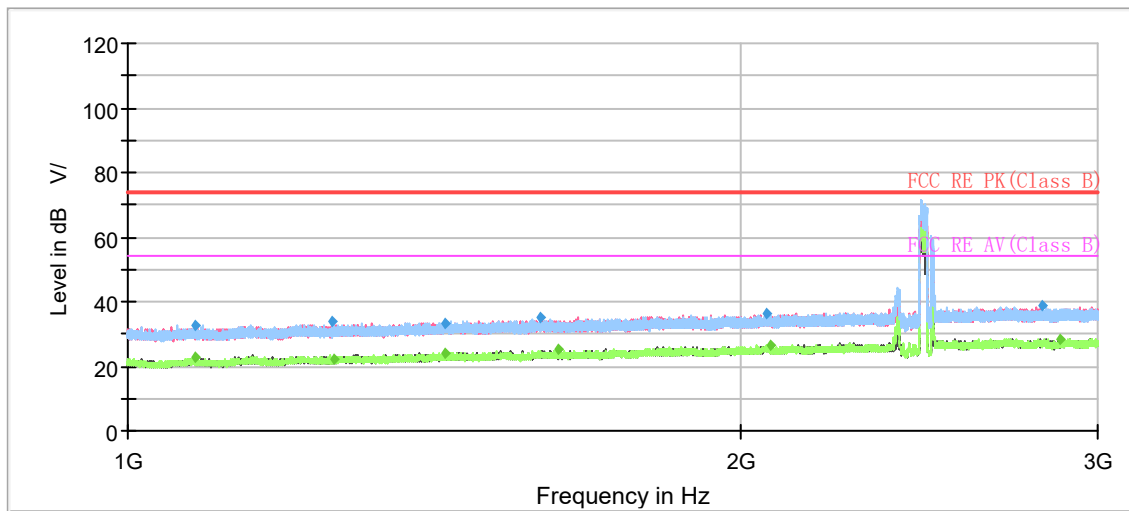

Note: The signal beyond the limit is carrier.

Radiates Emission from 1GHz to 3GHz

Frequency (MHz)	MaxPeak (dB μ V/m)	Average (dB μ V/m)	Limit (dB μ V/m)	Margin (dB)	Height (cm)	Pol	Azimuth (deg)	Corr. (dB/m)
1079.866667	---	22.57	54.00	31.43	200.0	V	316.0	-18
1080.466667	32.68	---	74.00	41.32	200.0	V	133.0	-18
1261.000000	33.83	---	74.00	40.17	100.0	V	300.0	-17
1264.466667	---	21.96	54.00	32.04	200.0	V	111.0	-17
1432.466667	33.13	---	74.00	40.87	200.0	H	114.0	-16
1433.266667	---	24.17	54.00	29.83	100.0	H	0.0	-16
1596.200000	34.88	---	74.00	39.12	100.0	H	3.0	-15
1626.466667	---	25.23	54.00	28.77	200.0	V	178.0	-15
2059.733333	36.12	---	74.00	37.88	200.0	H	237.0	-13
2070.066667	---	26.20	54.00	27.80	200.0	H	339.0	-13
2819.933333	38.73	---	74.00	35.27	200.0	H	237.0	-9
2874.866667	---	28.61	54.00	25.39	200.0	V	0.0	-9

Remark: 1. Correction Factor = Antenna factor+ Insertion loss (cable loss + amplifier gain)

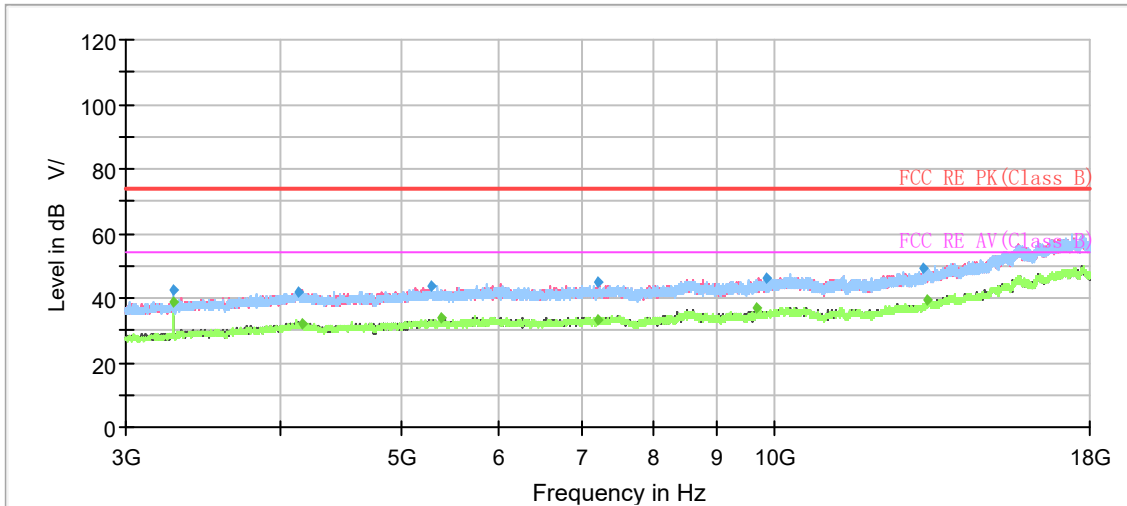

Radiates Emission from 3GHz to 18GHz

Frequency (MHz)	MaxPeak (dB μ V/m)	Average (dB μ V/m)	Limit (dB μ V/m)	Margin (dB)	Height (cm)	Pol	Azimuth (deg)	Corr. (dB/m)
3282.500000	---	38.69	54.00	15.31	200.0	H	254.0	-7
3282.500000	42.24	---	74.00	31.76	200.0	H	254.0	-7
4132.000000	42.10	---	74.00	31.90	100.0	V	243.0	-3
4165.500000	---	32.13	54.00	21.87	200.0	V	2.0	-3
5297.000000	43.55	---	74.00	30.45	100.0	V	132.0	-1
5389.000000	---	33.71	54.00	20.29	200.0	V	220.0	-1
7215.500000	---	33.16	54.00	20.84	100.0	V	39.0	1
7224.000000	44.67	---	74.00	29.33	100.0	V	354.0	1
9696.000000	---	36.64	54.00	17.36	200.0	H	325.0	4
9856.500000	45.91	---	74.00	28.09	200.0	H	74.0	4
13195.000000	49.05	---	74.00	24.95	200.0	H	270.0	9
13312.000000	---	39.59	54.00	14.41	200.0	V	2.0	9

Remark: 1. Correction Factor = Antenna factor+ Insertion loss (cable loss + amplifier gain)



802.11n (HT40) CH3

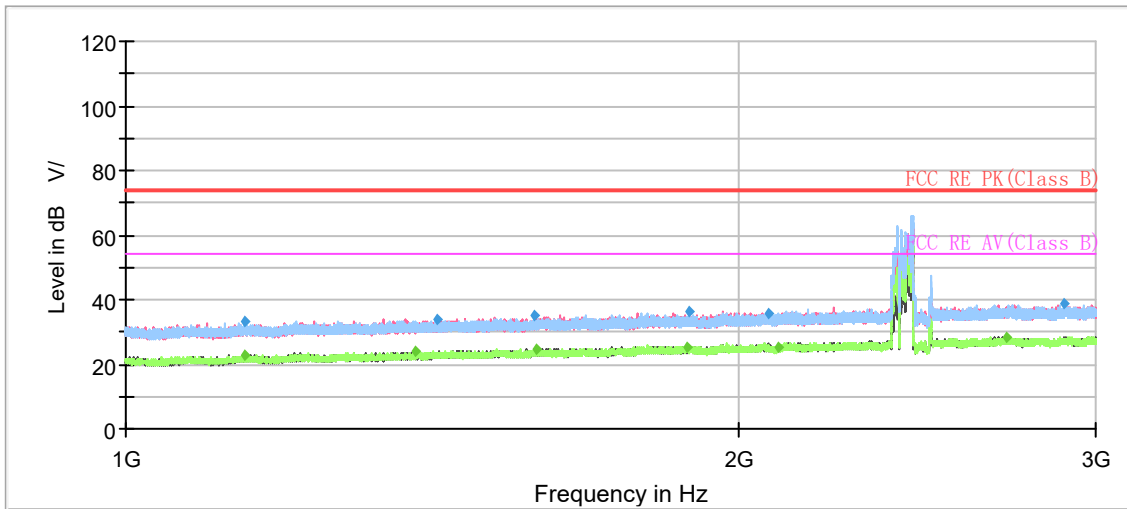

Note: The signal beyond the limit is carrier.

Radiates Emission from 1GHz to 3GHz

Frequency (MHz)	MaxPeak (dB μ V/m)	Average (dB μ V/m)	Limit (dB μ V/m)	Margin (dB)	Height (cm)	Pol	Azimuth (deg)	Corr. (dB/m)
1143.466667	---	22.91	54.00	31.09	200.0	V	160.0	-18
1144.066667	32.94	---	74.00	41.06	200.0	H	251.0	-18
1387.733333	---	24.19	54.00	29.81	200.0	V	285.0	-16
1424.066667	33.97	---	74.00	40.03	100.0	H	116.0	-16
1587.466667	35.14	---	74.00	38.86	200.0	V	20.0	-15
1591.000000	---	24.39	54.00	29.61	200.0	V	337.0	-15
1889.466667	---	25.47	54.00	28.53	100.0	H	152.0	-14
1891.466667	36.41	---	74.00	37.59	100.0	H	293.0	-14
2073.066667	35.69	---	74.00	38.31	100.0	V	94.0	-13
2094.400000	---	25.46	54.00	28.54	200.0	V	263.0	-12
2709.466667	---	28.56	54.00	25.44	100.0	V	109.0	-9
2893.133333	38.46	---	74.00	35.54	100.0	V	109.0	-9

Remark: 1. Correction Factor = Antenna factor+ Insertion loss (cable loss + amplifier gain)

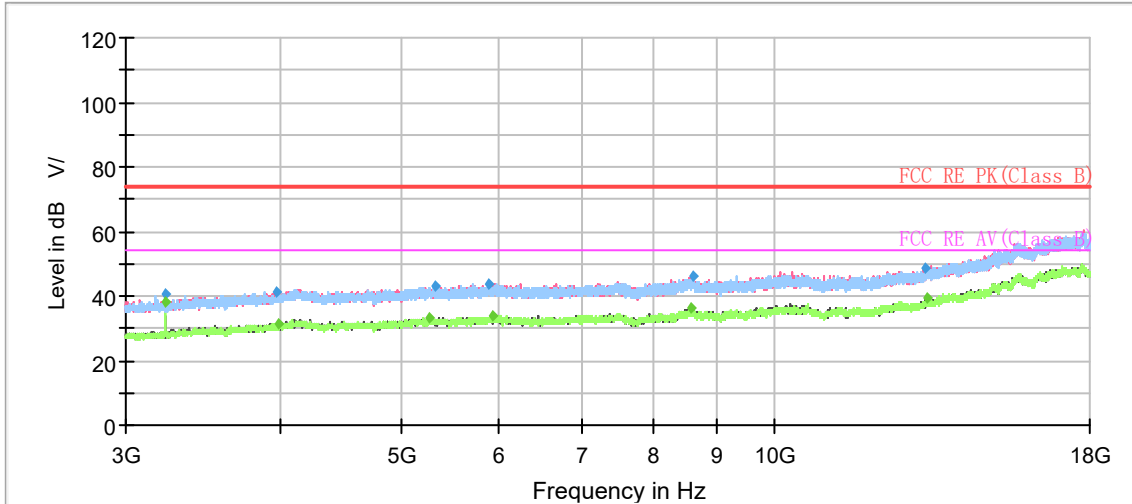

Radiates Emission from 3GHz to 18GHz

Frequency (MHz)	MaxPeak (dB μ V/m)	Average (dB μ V/m)	Limit (dB μ V/m)	Margin (dB)	Height (cm)	Pol	Azimuth (deg)	Corr. (dB/m)
3229.000000	---	38.09	54.00	15.91	100.0	H	257.0	-7
3229.000000	40.91	---	74.00	33.09	200.0	H	260.0	-7
3970.000000	41.47	---	74.00	32.53	100.0	V	149.0	-4
3987.000000	---	31.36	54.00	22.64	200.0	V	182.0	-4
5271.500000	---	33.22	54.00	20.78	200.0	V	356.0	-1
5326.500000	42.91	---	74.00	31.09	100.0	H	81.0	-1
5895.000000	43.98	---	74.00	30.02	200.0	H	0.0	0
5942.000000	---	33.96	54.00	20.04	200.0	V	301.0	0
8577.000000	---	36.16	54.00	17.84	100.0	H	0.0	4
8604.500000	46.02	---	74.00	27.98	200.0	H	27.0	4
13251.000000	48.61	---	74.00	25.39	100.0	H	281.0	9
13311.000000	---	39.17	54.00	14.83	200.0	H	35.0	9

Remark: 1. Correction Factor = Antenna factor+ Insertion loss (cable loss + amplifier gain)



802.11n (HT40) CH6

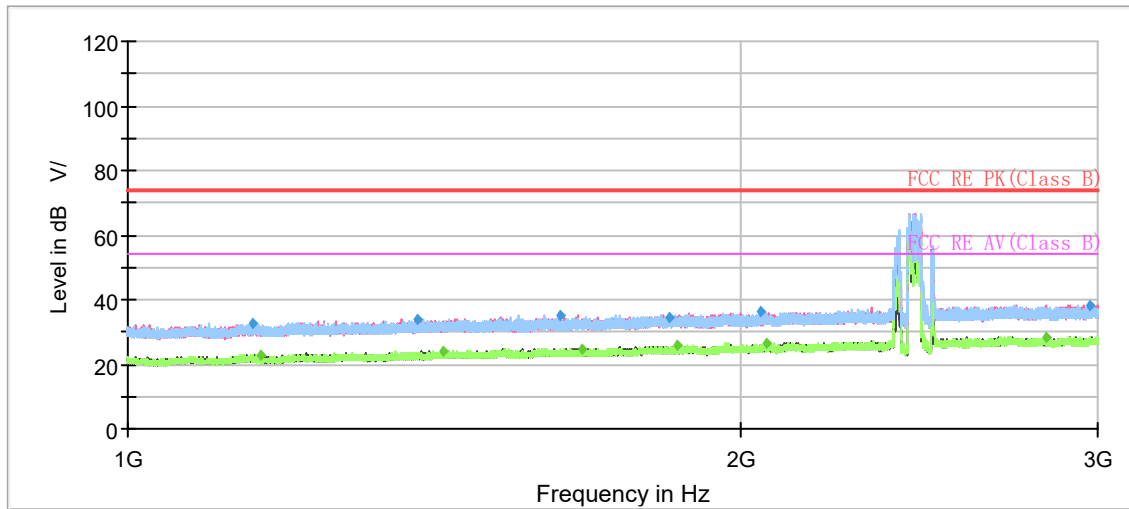

Note: The signal beyond the limit is carrier.

Radiates Emission from 1GHz to 3GHz

Frequency (MHz)	MaxPeak (dB μ V/m)	Average (dB μ V/m)	Limit (dB μ V/m)	Margin (dB)	Height (cm)	Pol	Azimuth (deg)	Corr. (dB/m)
1153.200000	32.68	---	74.00	41.32	200.0	V	322.0	-18
1162.733333	---	23.03	54.00	30.97	100.0	V	246.0	-18
1389.333333	33.94	---	74.00	40.06	100.0	V	168.0	-16
1429.533333	---	23.97	54.00	30.03	200.0	V	285.0	-16
1630.733333	35.32	---	74.00	38.68	200.0	H	314.0	-15
1672.866667	---	24.91	54.00	29.09	100.0	H	240.0	-15
1845.333333	34.32	---	74.00	39.68	100.0	V	87.0	-14
1862.800000	---	25.92	54.00	28.08	100.0	H	93.0	-14
2045.600000	36.55	---	74.00	37.45	200.0	V	0.0	-13
2059.866667	---	26.66	54.00	27.34	200.0	V	0.0	-13
2830.133333	---	28.51	54.00	25.49	100.0	V	0.0	-9
2974.800000	38.46	---	74.00	35.54	200.0	V	226.0	-9

Remark: 1. Correction Factor = Antenna factor+ Insertion loss (cable loss + amplifier gain)

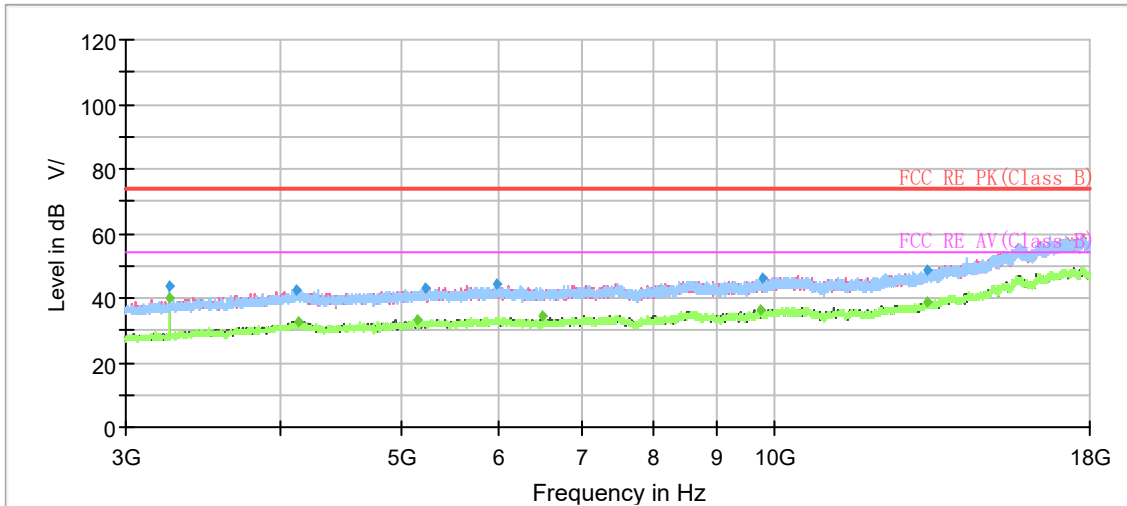

Radiates Emission from 3GHz to 18GHz

Frequency (MHz)	MaxPeak (dB μ V/m)	Average (dB μ V/m)	Limit (dB μ V/m)	Margin (dB)	Height (cm)	Pol	Azimuth (deg)	Corr. (dB/m)
3249.000000	---	40.27	54.00	13.73	200.0	H	260.0	-7
3249.500000	43.94	---	74.00	30.06	100.0	H	304.0	-7
4118.000000	42.77	---	74.00	31.23	100.0	V	175.0	-3
4134.000000	---	32.60	54.00	21.40	100.0	V	47.0	-3
5154.500000	---	33.33	54.00	20.67	100.0	H	335.0	-1
5243.500000	43.00	---	74.00	31.00	100.0	V	31.0	-1
5976.500000	44.19	---	74.00	29.81	200.0	H	55.0	0
6498.500000	---	34.55	54.00	19.45	100.0	V	142.0	0
9749.500000	---	36.39	54.00	17.61	200.0	V	237.0	4
9791.500000	45.87	---	74.00	28.13	200.0	H	251.0	4
13292.500000	48.54	---	74.00	25.46	100.0	H	0.0	9
13307.000000	---	39.06	54.00	14.94	200.0	H	0.0	9

Remark: 1. Correction Factor = Antenna factor+ Insertion loss (cable loss + amplifier gain)



802.11n (HT40) CH9

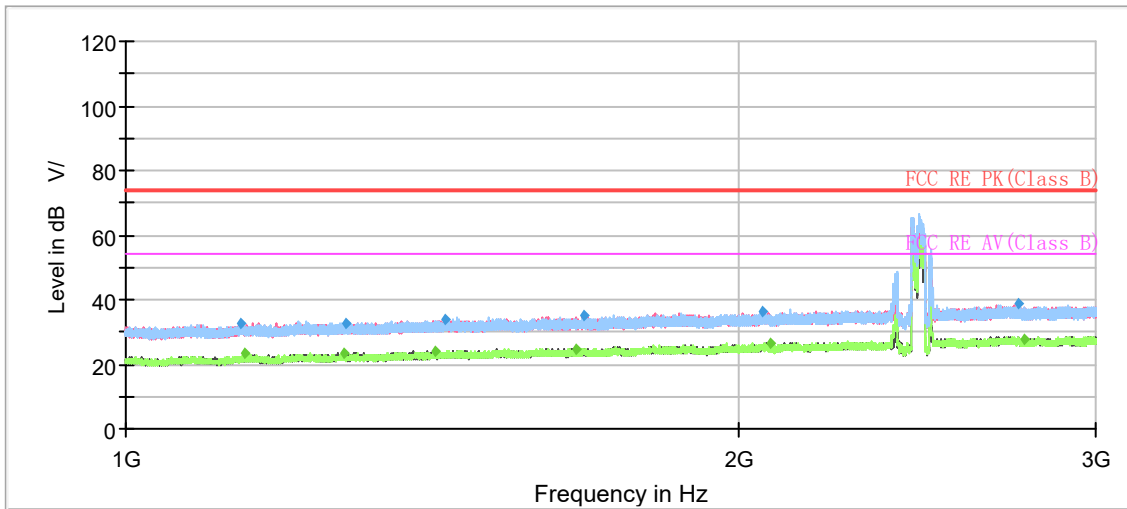

Note: The signal beyond the limit is carrier.

Radiates Emission from 1GHz to 3GHz

Frequency (MHz)	MaxPeak (dB μ V/m)	Average (dB μ V/m)	Limit (dB μ V/m)	Margin (dB)	Height (cm)	Pol	Azimuth (deg)	Corr. (dB/m)
1138.400000	32.55	---	74.00	41.45	200.0	H	74.0	-18
1145.133333	---	23.19	54.00	30.81	200.0	H	197.0	-18
1280.733333	---	23.57	54.00	30.43	100.0	H	356.0	-17
1282.533333	32.80	---	74.00	41.20	200.0	H	146.0	-17
1420.600000	---	23.97	54.00	30.03	100.0	V	5.0	-16
1435.066667	33.88	---	74.00	40.12	200.0	H	161.0	-16
1666.400000	---	24.91	54.00	29.09	100.0	V	12.0	-15
1680.133333	35.22	---	74.00	38.79	100.0	H	267.0	-15
2055.066667	36.52	---	74.00	37.48	200.0	V	354.0	-13
2074.333333	---	26.24	54.00	27.76	200.0	H	45.0	-13
2749.600000	38.70	---	74.00	35.30	200.0	H	251.0	-9
2765.933333	---	27.85	54.00	26.15	200.0	H	81.0	-9

Remark: 1. Correction Factor = Antenna factor+ Insertion loss (cable loss + amplifier gain)

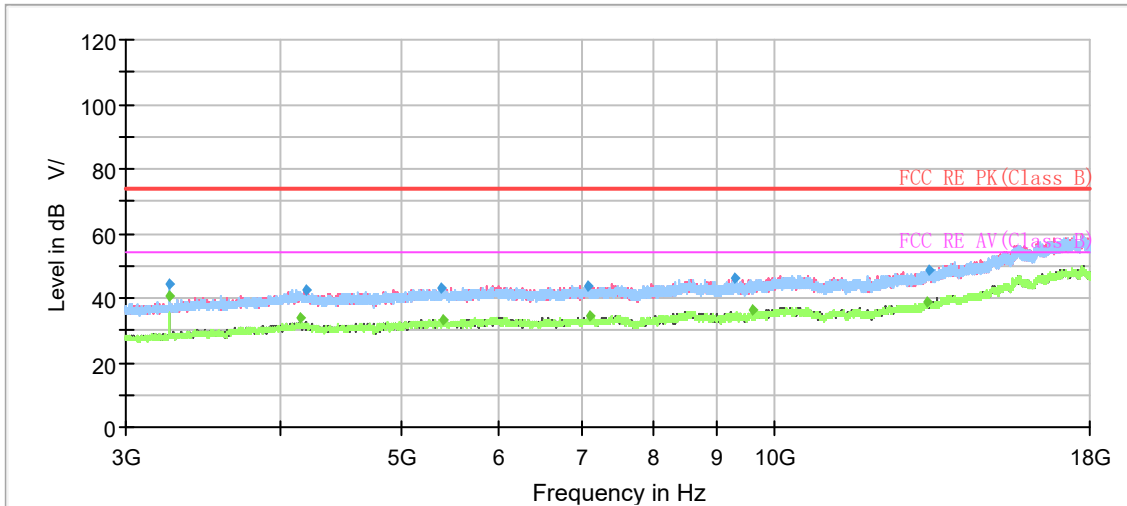

Radiates Emission from 3GHz to 18GHz

Frequency (MHz)	MaxPeak (dB μ V/m)	Average (dB μ V/m)	Limit (dB μ V/m)	Margin (dB)	Height (cm)	Pol	Azimuth (deg)	Corr. (dB/m)
3249.000000	---	40.85	54.00	13.15	200.0	H	269.0	-7
3249.000000	44.40	---	74.00	29.60	100.0	H	309.0	-7
4144.000000	---	33.57	54.00	20.43	200.0	H	160.0	-3
4191.500000	42.28	---	74.00	31.72	200.0	H	89.0	-3
5395.500000	43.06	---	74.00	30.94	100.0	V	64.0	-1
5401.500000	---	33.13	54.00	20.87	100.0	V	283.0	-1
7076.000000	43.97	---	74.00	30.03	200.0	V	358.0	1
7106.500000	---	34.27	54.00	19.73	200.0	H	73.0	1
9292.500000	45.91	---	74.00	28.09	200.0	H	49.0	3
9635.000000	---	36.30	54.00	17.70	200.0	V	0.0	4
13317.000000	---	38.97	54.00	15.03	200.0	V	342.0	9
13352.500000	48.35	---	74.00	25.65	100.0	V	96.0	9

Remark: 1. Correction Factor = Antenna factor+ Insertion loss (cable loss + amplifier gain)



Bluetooth LE-Channel 0

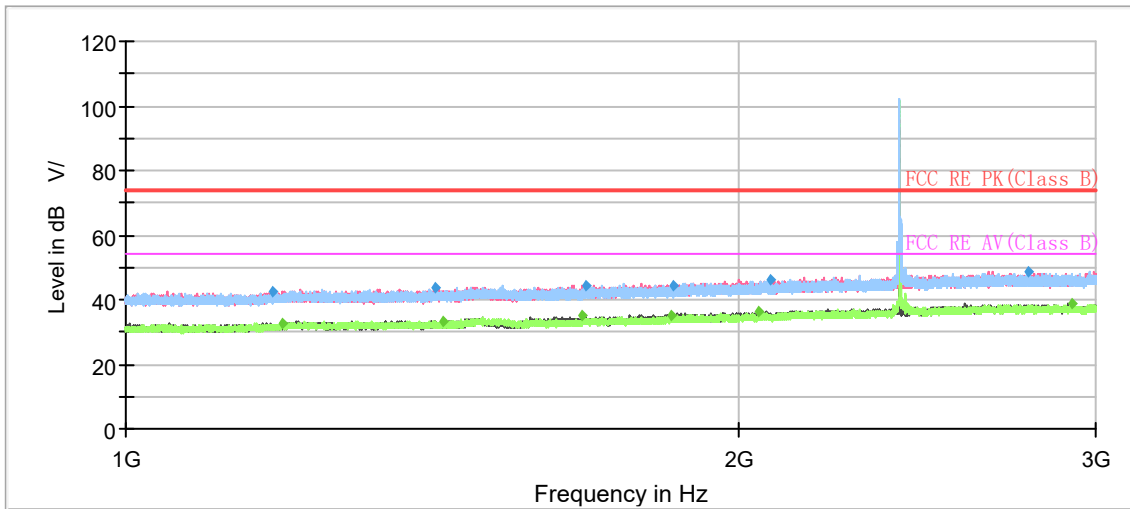

Note: The signal beyond the limit is carrier.

Radiates Emission from 1GHz to 3GHz

Frequency (MHz)	MaxPeak (dB μ V/m)	Average (dB μ V/m)	Limit (dB μ V/m)	Margin (dB)	Height (cm)	Pol	Azimuth (deg)	Corr. (dB/m)
1181.600000	42.41	---	74.00	31.59	200.0	H	120.0	-8
1194.733333	---	32.74	54.00	21.26	200.0	V	0.0	-8
1420.466667	43.43	---	74.00	30.57	100.0	H	0.0	-6
1433.133333	---	33.50	54.00	20.50	100.0	H	224.0	-6
1677.200000	---	34.84	54.00	19.16	200.0	V	75.0	-5
1683.600000	44.37	---	74.00	29.63	200.0	H	185.0	-5
1855.400000	---	35.25	54.00	18.75	100.0	V	64.0	-4
1857.866667	44.29	---	74.00	29.71	200.0	V	339.0	-4
2048.866667	---	36.03	54.00	17.97	100.0	V	293.0	-3
2074.266667	45.96	---	74.00	28.04	200.0	H	156.0	-3
2782.333333	48.67	---	74.00	25.33	200.0	V	339.0	1
2920.733333	---	38.91	54.00	15.09	100.0	H	346.0	1

Remark: 1. Correction Factor = Antenna factor+ Insertion loss (cable loss + amplifier gain)

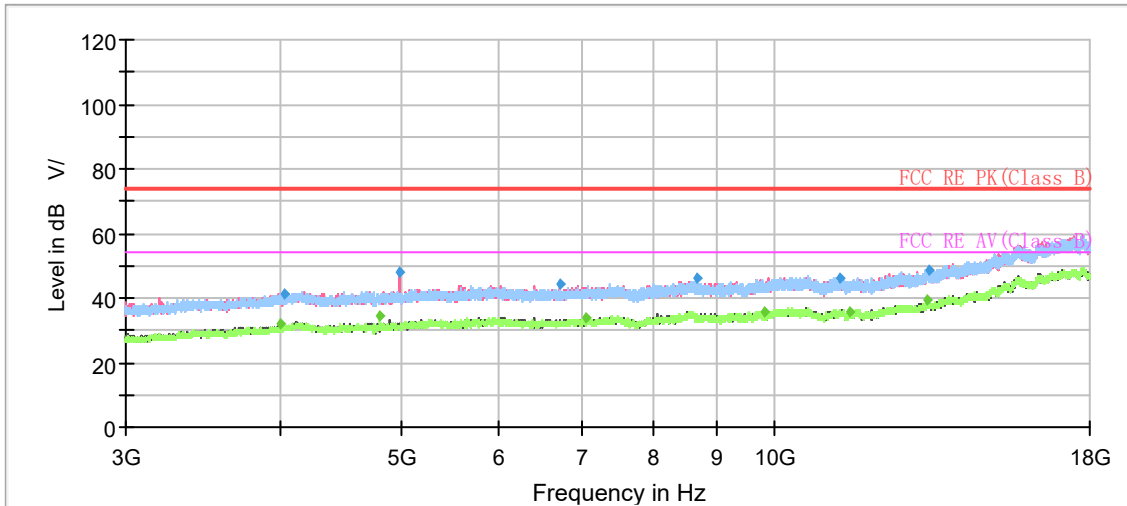

Radiates Emission from 3GHz to 18GHz

Frequency (MHz)	MaxPeak (dB μ V/m)	Average (dB μ V/m)	Limit (dB μ V/m)	Margin (dB)	Height (cm)	Pol	Azimuth (deg)	Corr. (dB/m)
3997.000000	---	31.71	54.00	22.29	200.0	V	85.0	-4
4024.000000	41.25	---	74.00	32.75	100.0	V	113.0	-4
4803.500000	---	34.32	54.00	19.68	100.0	H	329.0	-2
4997.000000	47.93	---	74.00	26.07	100.0	V	354.0	-1
6714.000000	44.45	---	74.00	29.55	200.0	V	53.0	0
7060.000000	---	34.00	54.00	20.00	100.0	H	0.0	1
8669.500000	45.92	---	74.00	28.08	200.0	H	194.0	4
9820.000000	---	35.71	54.00	18.29	200.0	V	7.0	4
11321.000000	46.30	---	74.00	27.70	200.0	H	22.0	6
11527.500000	---	35.60	54.00	18.40	200.0	V	245.0	6
13326.000000	---	39.15	54.00	14.85	200.0	H	314.0	9
13330.500000	48.68	---	74.00	25.32	200.0	H	0.0	9

Remark: 1. Correction Factor = Antenna factor+ Insertion loss (cable loss + amplifier gain)



Bluetooth LE-Channel 19

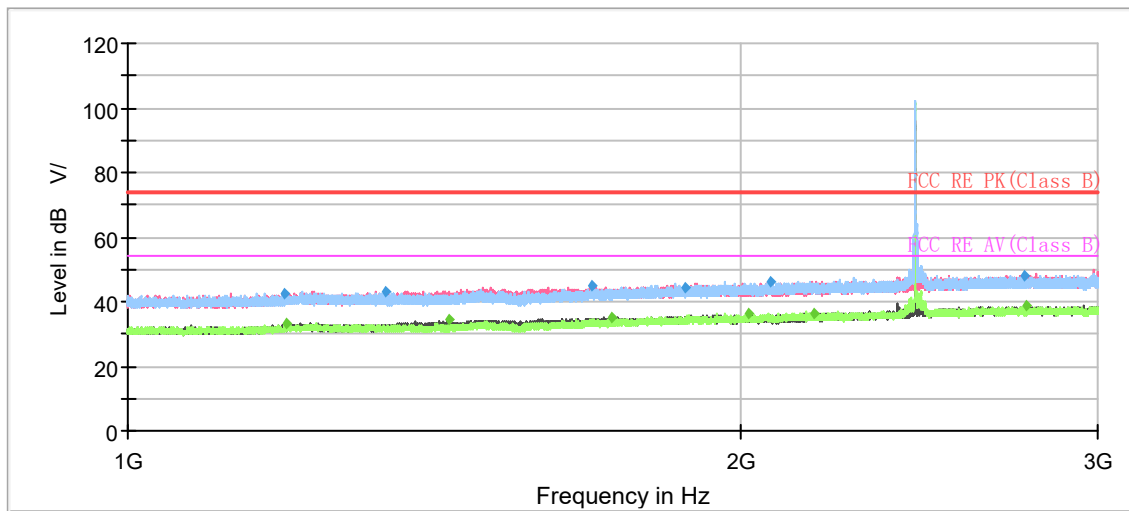

Note: The signal beyond the limit is carrier.

Radiates Emission from 1GHz to 3GHz

Frequency (MHz)	MaxPeak (dB μ V/m)	Average (dB μ V/m)	Limit (dB μ V/m)	Margin (dB)	Height (cm)	Pol	Azimuth (deg)	Corr. (dB/m)
1194.533333	42.49	---	74.00	31.51	100.0	V	184.0	-8
1196.666667	---	32.96	54.00	21.04	100.0	V	16.0	-8
1340.533333	43.33	---	74.00	30.67	100.0	V	126.0	-7
1439.933333	---	34.34	54.00	19.66	100.0	V	0.0	-6
1691.133333	44.62	---	74.00	29.38	200.0	H	75.0	-5
1731.666667	---	34.91	54.00	19.09	200.0	V	277.0	-4
1880.466667	44.51	---	74.00	29.49	200.0	V	219.0	-4
2020.066667	---	36.31	54.00	17.69	100.0	H	0.0	-3
2069.533333	46.21	---	74.00	27.79	200.0	H	68.0	-3
2176.266667	---	36.26	54.00	17.74	100.0	H	0.0	-2
2763.266667	48.01	---	74.00	25.99	200.0	H	339.0	1
2767.333333	---	38.61	54.00	15.39	200.0	H	141.0	1

Remark: 1. Correction Factor = Antenna factor+ Insertion loss (cable loss + amplifier gain)

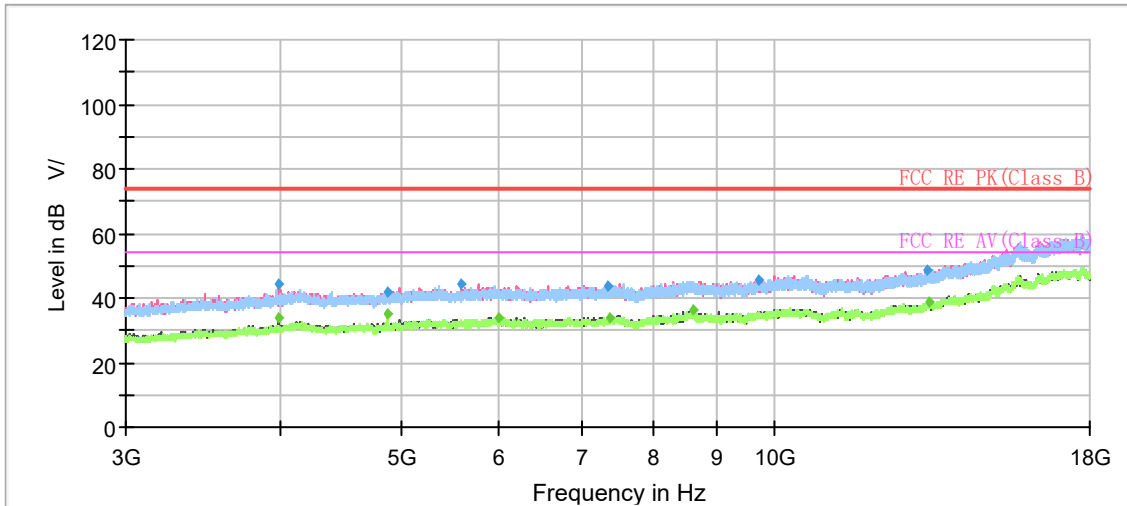

Radiates Emission from 3GHz to 18GHz

Frequency (MHz)	MaxPeak (dB μ V/m)	Average (dB μ V/m)	Limit (dB μ V/m)	Margin (dB)	Height (cm)	Pol	Azimuth (deg)	Corr. (dB/m)
3982.500000	---	33.84	54.00	20.16	200.0	V	139.0	-4
3982.500000	44.29	---	74.00	29.71	200.0	V	139.0	-4
4879.500000	---	35.04	54.00	18.96	100.0	H	0.0	-2
4880.500000	41.64	---	74.00	32.36	100.0	H	337.0	-2
5585.000000	44.53	---	74.00	29.47	200.0	V	202.0	0
5998.000000	---	33.91	54.00	20.09	200.0	H	189.0	0
7358.500000	43.76	---	74.00	30.24	200.0	H	290.0	1
7372.500000	---	34.12	54.00	19.88	200.0	H	219.0	1
8621.000000	---	36.07	54.00	17.93	200.0	H	219.0	4
9741.000000	45.57	---	74.00	28.43	100.0	H	171.0	4
13321.500000	48.47	---	74.00	25.53	200.0	H	1.0	9
13344.500000	---	38.91	54.00	15.09	200.0	H	141.0	9

Remark: 1. Correction Factor = Antenna factor+ Insertion loss (cable loss + amplifier gain)



Bluetooth LE-Channel 39

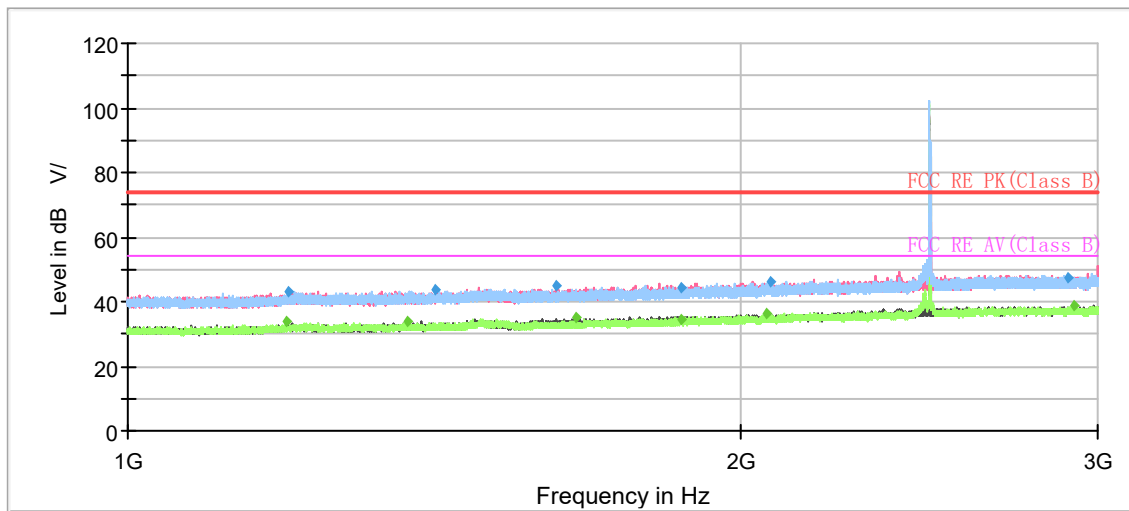

Note: The signal beyond the limit is carrier.

Radiates Emission from 1GHz to 3GHz

Frequency (MHz)	MaxPeak (dB μ V/m)	Average (dB μ V/m)	Limit (dB μ V/m)	Margin (dB)	Height (cm)	Pol	Azimuth (deg)	Corr. (dB/m)
1196.733333	---	34.11	54.00	19.89	100.0	V	181.0	-8
1199.266667	42.98	---	74.00	31.02	100.0	V	0.0	-8
1371.800000	---	33.81	54.00	20.19	200.0	V	75.0	-7
1418.133333	43.40	---	74.00	30.60	200.0	H	179.0	-6
1623.866667	44.69	---	74.00	29.31	200.0	V	225.0	-5
1662.933333	---	34.84	54.00	19.16	200.0	V	0.0	-5
1873.333333	44.25	---	74.00	29.75	100.0	V	293.0	-4
1873.466667	---	34.57	54.00	19.43	100.0	V	134.0	-4
2061.466667	---	36.18	54.00	17.82	100.0	V	173.0	-3
2068.800000	46.12	---	74.00	27.88	200.0	V	75.0	-3
2901.200000	47.17	---	74.00	26.83	100.0	V	248.0	1
2923.400000	---	38.55	54.00	15.45	100.0	H	165.0	1

Remark: 1. Correction Factor = Antenna factor+ Insertion loss (cable loss + amplifier gain)

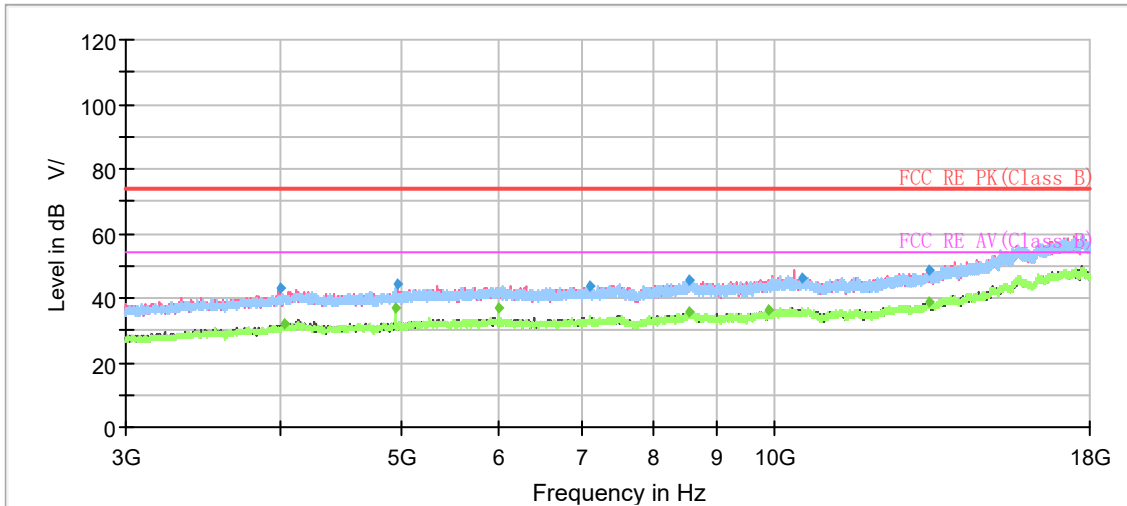

Radiates Emission from 3GHz to 18GHz

Frequency (MHz)	MaxPeak (dB μ V/m)	Average (dB μ V/m)	Limit (dB μ V/m)	Margin (dB)	Height (cm)	Pol	Azimuth (deg)	Corr. (dB/m)
3999.500000	43.01	---	74.00	30.99	200.0	V	199.0	-4
4028.000000	---	31.83	54.00	22.17	100.0	V	97.0	-4
4960.000000	---	36.71	54.00	17.29	100.0	H	345.0	-2
4978.000000	44.54	---	74.00	29.46	200.0	V	144.0	-1
5998.000000	---	37.22	54.00	16.78	200.0	H	162.0	0
7098.000000	43.69	---	74.00	30.31	200.0	H	170.0	1
8532.000000	---	35.59	54.00	18.41	100.0	V	329.0	4
8558.500000	45.66	---	74.00	28.34	100.0	H	52.0	4
9895.000000	---	36.04	54.00	17.96	200.0	V	49.0	4
10543.500000	46.28	---	74.00	27.72	100.0	V	227.0	5
13335.000000	48.51	---	74.00	25.49	200.0	H	1.0	9
13345.500000	---	38.97	54.00	15.03	200.0	H	276.0	9

Remark: 1. Correction Factor = Antenna factor+ Insertion loss (cable loss + amplifier gain)



During the test, the Radiates Emission from 18GHz to 26.5GHz was performed in all modes with all channels, 802.11g CH6 and Bluetooth LE-Channel 0 are selected as the worst condition. The test data of the worst-case condition was recorded in this report.

WIFI 2.4G:

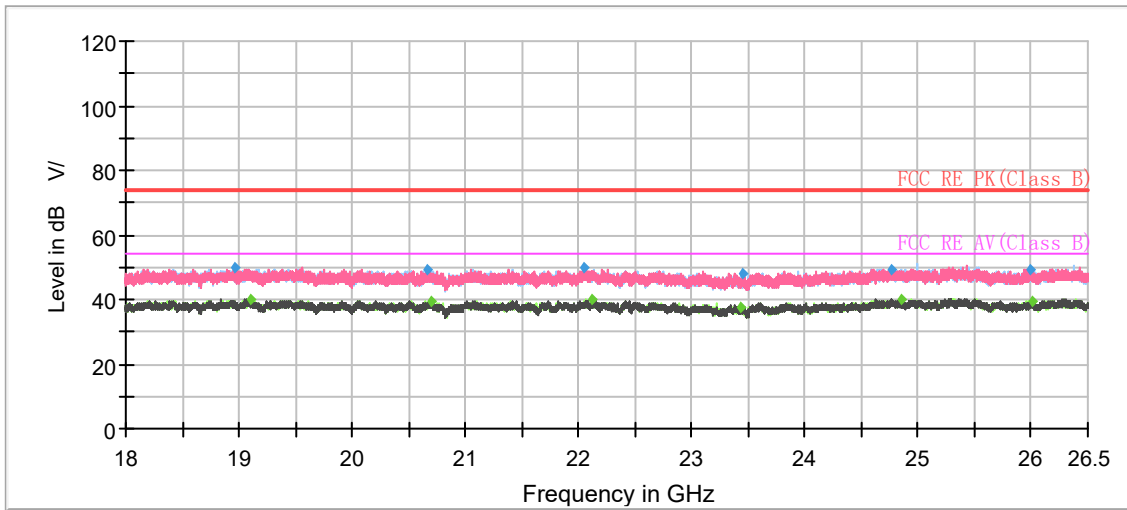

Radiates Emission from 18GHz to 26.5GHz

Frequency (MHz)	MaxPeak (dB μ V/m)	Average (dB μ V/m)	Limit (dB μ V/m)	Margin (dB)	Height (cm)	PoI	Azimuth (deg)	Corr. (dB/m)
18963.05	49.89	---	74.00	24.11	200.0	H	351.00	-1
19103.30	---	40.06	54.00	13.94	100.0	H	263.00	-1
20670.70	49.08	---	74.00	24.92	100.0	V	211.00	0
20705.83	---	39.37	54.00	14.63	200.0	H	21.00	0
22049.12	49.65	---	74.00	24.35	200.0	V	187.00	1
22121.08	---	39.92	54.00	14.08	200.0	V	202.00	1
23428.67	---	37.79	54.00	16.21	100.0	H	233.00	2
23449.35	47.96	---	74.00	26.04	200.0	V	292.00	2
24760.62	49.49	---	74.00	24.51	200.0	H	150.00	3
24844.77	---	40.07	54.00	13.93	200.0	H	188.00	3
26000.20	49.33	---	74.00	24.67	200.0	H	173.00	3
26000.77	---	39.66	54.00	14.34	200.0	V	307.00	3

Remark: 1. Correction Factor = Antenna factor+ Insertion loss (cable loss + amplifier gain)

Bluetooth LE:

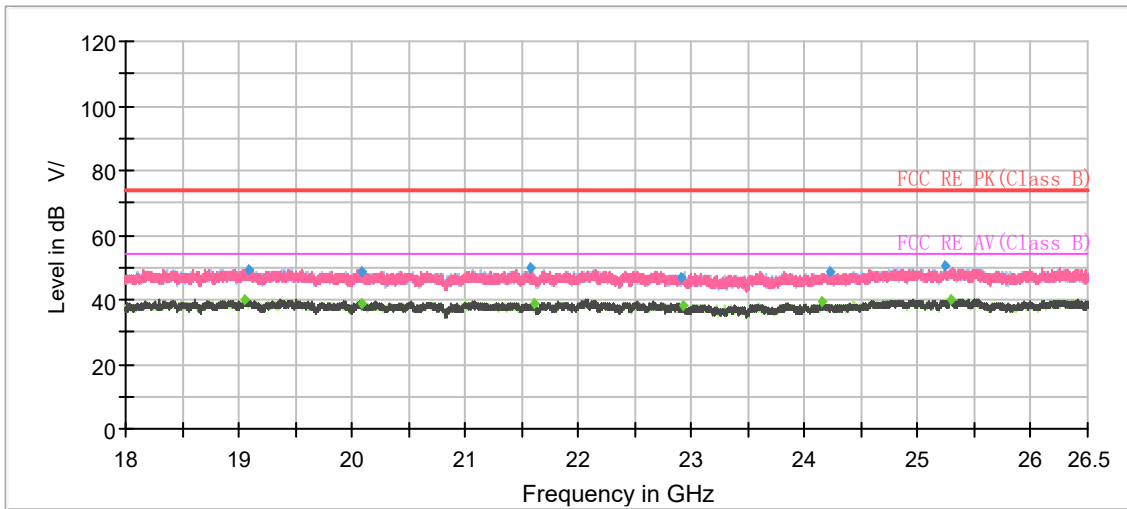

Radiates Emission from 18GHz to 26.5GHz

Frequency (MHz)	MaxPeak (dB μ V/m)	Average (dB μ V/m)	Limit (dB μ V/m)	Margin (dB)	Height (cm)	Pol	Azimuth (deg)	Corr. (dB/m)
19054.28	---	39.88	54.00	14.12	200.0	V	201.00	-1
19094.52	49.51	---	74.00	24.49	200.0	H	32.00	-1
20082.78	---	39.07	54.00	14.93	100.0	V	105.00	-1
20083.07	48.60	---	74.00	25.40	200.0	H	243.00	-1
21577.37	50.00	---	74.00	24.00	100.0	V	8.00	0
21604.57	---	38.74	54.00	15.26	200.0	V	61.00	1
22902.23	47.03	---	74.00	26.97	100.0	H	300.00	2
22921.22	---	38.35	54.00	15.65	200.0	V	352.00	2
24157.97	---	39.09	54.00	14.91	100.0	V	196.00	2
24217.47	48.48	---	74.00	25.52	200.0	V	352.00	2
25236.05	50.46	---	74.00	23.54	100.0	H	247.00	3
25284.22	---	40.19	54.00	13.81	100.0	V	0.00	3

Remark: 1. Correction Factor = Antenna factor+ Insertion loss (cable loss + amplifier gain)

5.7. Conducted Emission

Ambient condition

Temperature	Relative humidity	Pressure
23°C ~25°C	45%~50%	101.5kPa

Methods of Measurement

The EUT is placed on a non-metallic table of 80cm height above the horizontal metal reference ground plane. During the test, the EUT was operating in its typical mode. The test method is according to ANSI C63.10. Connect the AC power line of the EUT to the L.I.S.N. Use EMI receiver to detect the average and Quasi-peak value. RBW is set to 9 kHz, VBW is set to 30kHz.

The measurement result should include both L line and N line.

The test is in transmitting mode.

Test Setup

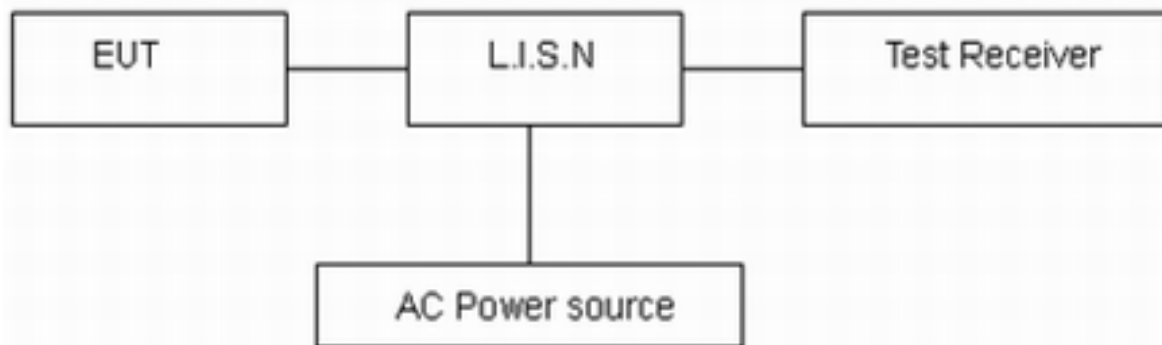

Note: AC Power source is used to change the voltage 110V/60Hz.

Limits

Frequency (MHz)	Conducted Limits(dBμV)	
	Quasi-peak	Average
0.15 - 0.5	66 to 56 *	56 to 46 *
0.5 - 5	56	46
5 - 30	60	50

*: Decreases with the logarithm of the frequency.

Measurement Uncertainty

The assessed measurement uncertainty to ensure 95% confidence level for the normal distribution is with the coverage factor $k = 1.96$, $U = 2.69$ dB.

Test Results:

Following plots, Blue trace uses the peak detection and Green trace uses the average detection. During the test, the Conducted Emission was performed in all modes (WIFI 2.4G /Bluetooth LE) with all channels, 802.11g CH6 and Bluetooth LE-Channel 0 are selected as the worst condition. The test data of the worst-case condition was recorded in this report.

WIFI 2.4G:

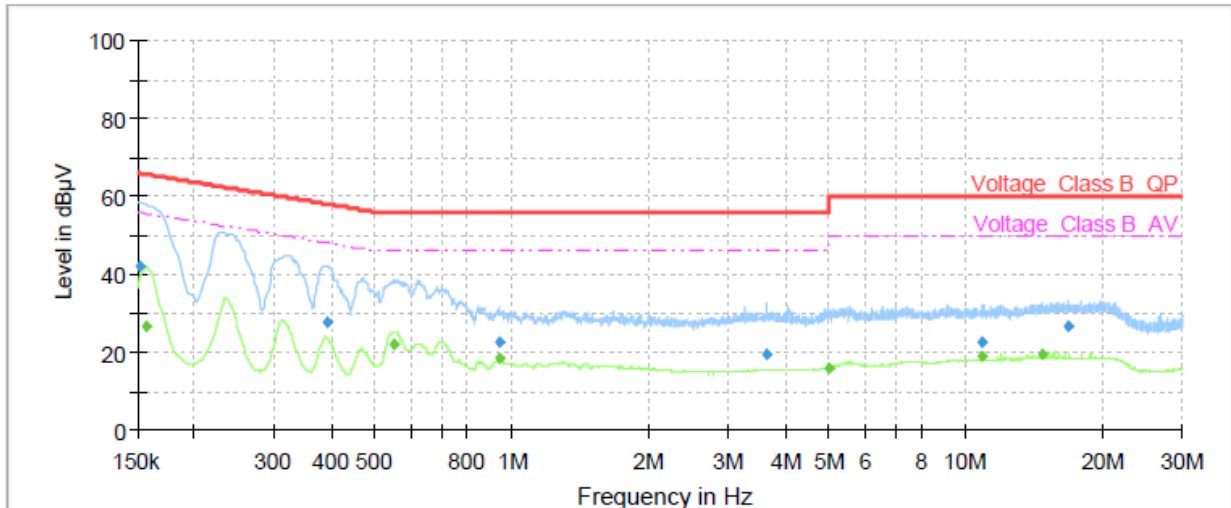

Frequency (MHz)	QuasiPeak (dBµV)	Average (dBµV)	Limit (dBµV)	Margin (dB)	Meas. Time (ms)	Bandwidth (kHz)	Line	Filter	Corr. (dB)
0.15	41.95	---	65.88	23.93	70.0	9.000	L1	ON	21
0.16	---	26.56	55.63	29.07	70.0	9.000	L1	ON	21
0.39	27.93	---	58.00	30.07	70.0	9.000	L1	ON	20
0.55	---	21.96	46.00	24.04	70.0	9.000	L1	ON	20
0.94	22.65	---	56.00	33.35	70.0	9.000	L1	ON	20
0.94	---	18.22	46.00	27.78	70.0	9.000	L1	ON	20
3.64	19.34	---	56.00	36.66	70.0	9.000	L1	ON	19
5.00	---	15.95	46.00	30.05	70.0	9.000	L1	ON	19
10.89	---	18.89	50.00	31.11	70.0	9.000	L1	ON	20
10.90	22.59	---	60.00	37.41	70.0	9.000	L1	ON	20
14.70	---	19.69	50.00	30.31	70.0	9.000	L1	ON	20
16.89	26.68	---	60.00	33.32	70.0	9.000	L1	ON	20

Remark: Correct factor=cable loss + LISN factor

L line Conducted Emission from 150 KHz to 30 MHz

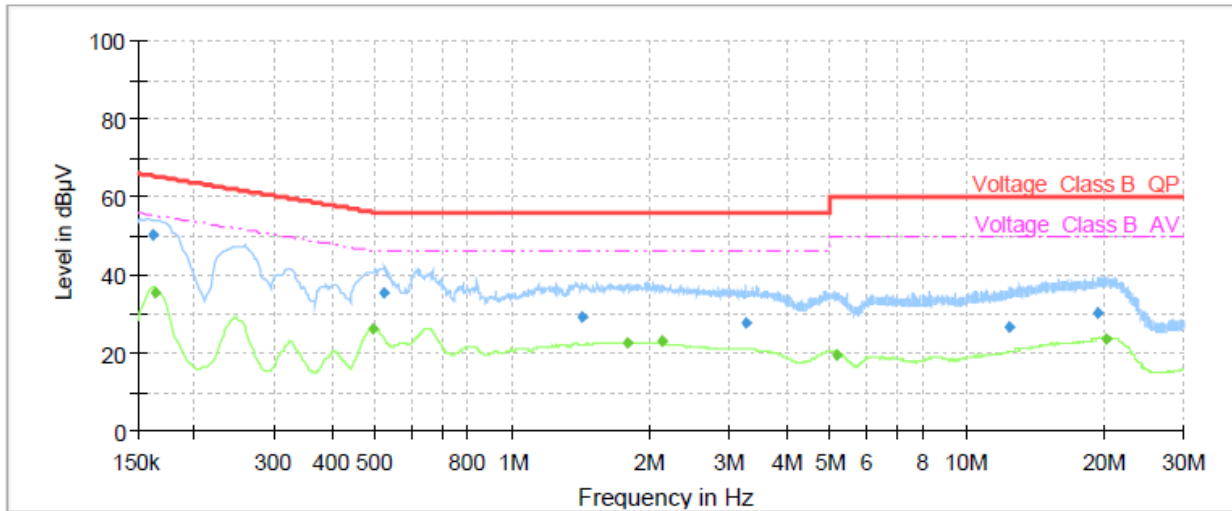

Frequency (MHz)	QuasiPeak (dBµV)	Average (dBµV)	Limit (dBµV)	Margin (dB)	Meas. Time (ms)	Bandwidth (kHz)	Line	Filter	Corr. (dB)
0.16	50.13	---	65.40	15.27	70.0	9.000	N	ON	21
0.16	---	35.41	55.28	19.87	70.0	9.000	N	ON	21
0.49	---	26.30	46.10	19.80	70.0	9.000	N	ON	20
0.52	35.35	---	56.00	20.65	70.0	9.000	N	ON	20
1.42	29.46	---	56.00	26.54	70.0	9.000	N	ON	20
1.78	---	22.70	46.00	23.30	70.0	9.000	N	ON	20
2.14	---	22.84	46.00	23.16	70.0	9.000	N	ON	20
3.25	27.56	---	56.00	28.44	70.0	9.000	N	ON	19
5.17	---	19.64	50.00	30.36	70.0	9.000	N	ON	19
12.37	26.86	---	60.00	33.14	70.0	9.000	N	ON	20
19.44	30.19	---	60.00	29.81	70.0	9.000	N	ON	20
20.21	---	23.73	50.00	26.27	70.0	9.000	N	ON	20

Remark: Correct factor=cable loss + LISN factor

N line Conducted Emission from 150 KHz to 30 MHz

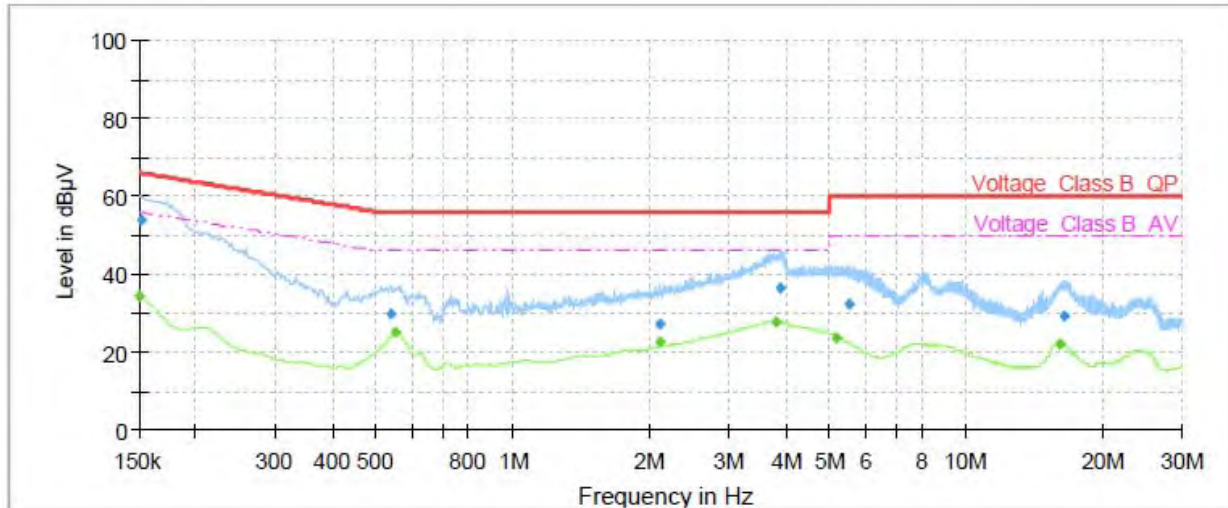
**Bluetooth LE:**

Frequency (MHz)	QuasiPeak (dBµV)	Average (dBµV)	Limit (dBµV)	Margin (dB)	Meas. Time (ms)	Bandwidth (kHz)	Line	Filter	Corr. (dB)
0.15	---	34.51	56.00	21.49	70.0	9.000	L1	ON	21
0.15	53.91	---	65.88	11.97	70.0	9.000	L1	ON	21
0.54	29.75	---	56.00	26.25	70.0	9.000	L1	ON	20
0.55	---	25.07	46.00	20.93	70.0	9.000	L1	ON	20
2.11	---	22.76	46.00	23.24	70.0	9.000	L1	ON	20
2.12	27.13	---	56.00	28.87	70.0	9.000	L1	ON	20
3.80	---	27.95	46.00	18.05	70.0	9.000	L1	ON	19
3.89	36.59	---	56.00	19.41	70.0	9.000	L1	ON	19
5.16	---	23.71	50.00	26.29	70.0	9.000	L1	ON	19
5.50	32.32	---	60.00	27.68	70.0	9.000	L1	ON	19
16.05	---	22.12	50.00	27.88	70.0	9.000	L1	ON	20
16.49	29.22	---	60.00	30.78	70.0	9.000	L1	ON	20

Remark: Correct factor=cable loss + LISN factor

L line Conducted Emission from 150 KHz to 30 MHz

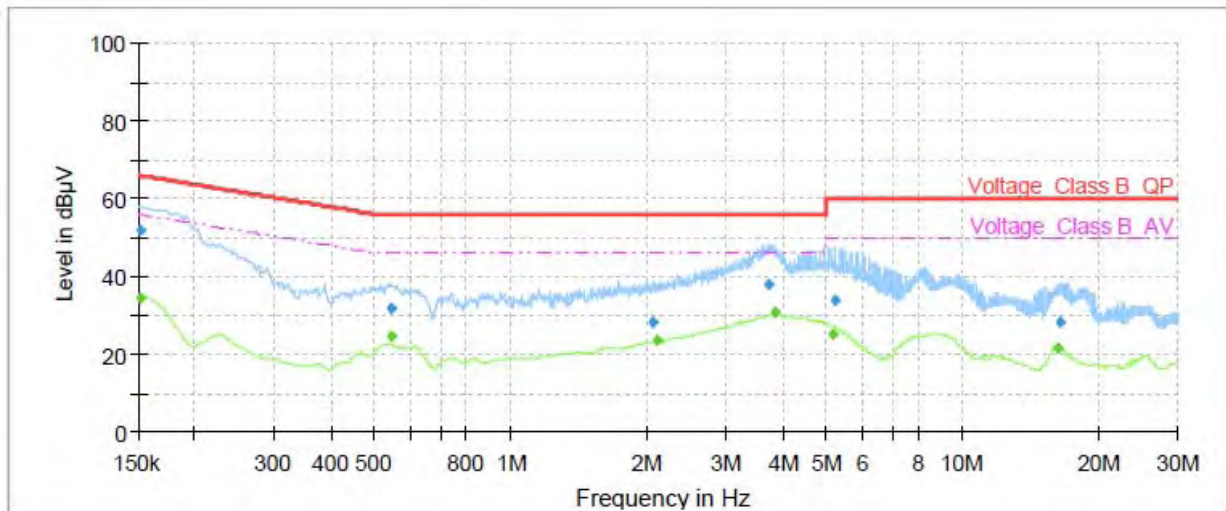

Frequency (MHz)	QuasiPeak (dBµV)	Average (dBµV)	Limit (dBµV)	Margin (dB)	Meas. Time (ms)	Bandwidth (kHz)	Line	Filter	Corr. (dB)
0.15	---	34.40	55.88	21.48	70.0	9.000	N	ON	21
0.15	51.82	---	65.88	14.06	70.0	9.000	N	ON	21
0.54	31.59	---	56.00	24.41	70.0	9.000	N	ON	20
0.55	---	24.69	46.00	21.31	70.0	9.000	N	ON	20
2.06	28.08	---	56.00	27.92	70.0	9.000	N	ON	20
2.12	---	23.42	46.00	22.58	70.0	9.000	N	ON	20
3.71	38.01	---	56.00	17.99	70.0	9.000	N	ON	19
3.84	---	30.54	46.00	15.46	70.0	9.000	N	ON	19
5.14	---	25.06	50.00	24.94	70.0	9.000	N	ON	19
5.23	33.97	---	60.00	26.03	70.0	9.000	N	ON	19
16.23	---	21.76	50.00	28.24	70.0	9.000	N	ON	20
16.40	28.19	---	60.00	31.81	70.0	9.000	N	ON	20

Remark: Correct factor=cable loss + LISN factor

N line Conducted Emission from 150 KHz to 30 MHz

6. Main Test Instruments

Name	Manufacturer	Type	Serial Number	Calibration Date	Expiration Date
EMI Test Receiver	R&S	ESCI7	100936	2021-12-12	2022-12-11
Signal Analyzer	R&S	FSV40	100815	2021-05-15	2022-05-14
TRILOG Broadband Antenna	SCHWARZBECK	9163	1023	2021-06-07	2024-06-06
Horn Antenna	R&S	HF907	102723	2021-07-26	2024-07-25
Horn Antenna	ETS-Lindgren	3160-09	00102643	2020-10-10	2023-10-09
Software	R&S	EMC32	9.26.01	/	/
Artificial main network	R&S	ENV216	101171	2020-12-13	2022-12-12
EMI Test Receiver	R&S	ESR	101667	2021-05-15	2022-05-14
Software	R&S	EMC32	10.35.10	/	/
Spectrum Analyzer	KEYSIGHT	N9020A	MY54420163	2021-12-12	2022-12-11
Power probe	R&S	NRP18S	101954	2021-05-15	2022-05-14
Climate Chamber	ESPEC	SU-242	93000506	2021-12-12	2022-12-11

*****END OF REPORT *****

ANNEX A: The EUT Appearance

The EUT Appearance are submitted separately.

ANNEX B: Test Setup Photos

The Test Setup Photos are submitted separately.

ANNEX C: Product Change Description

The Product Change Description are submitted separately.