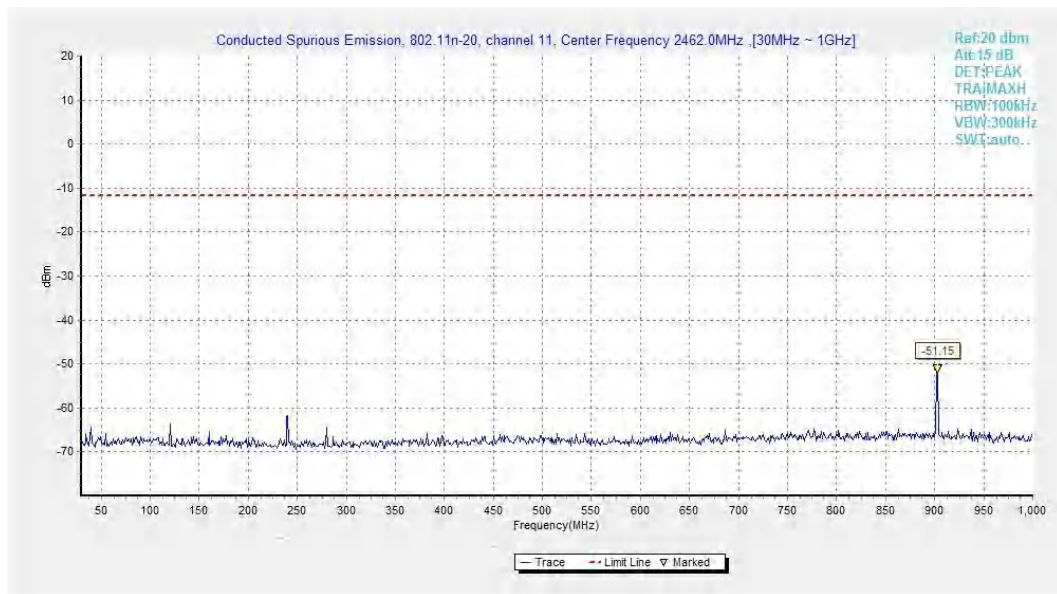
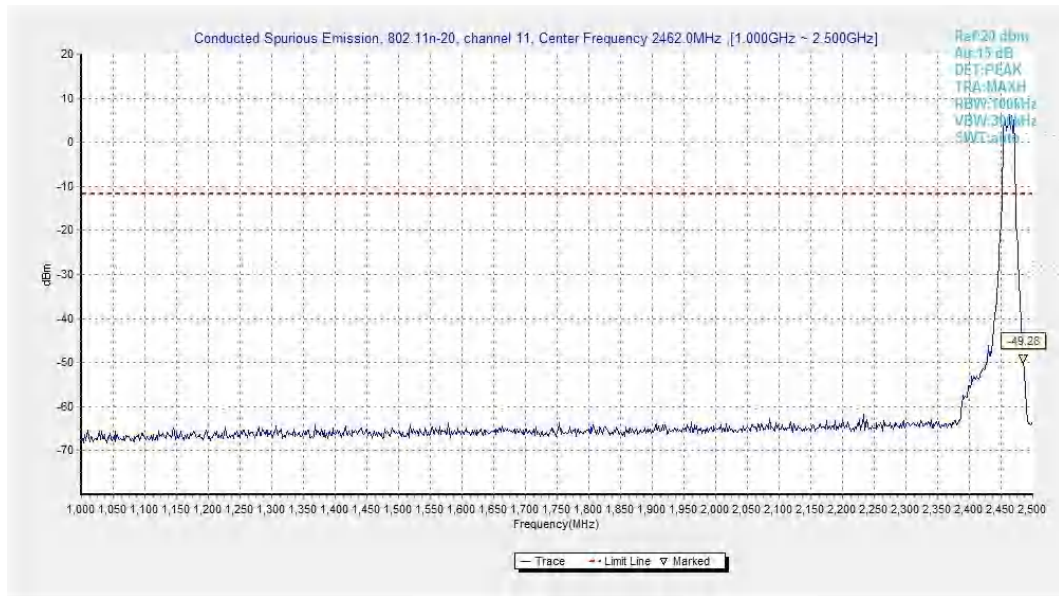


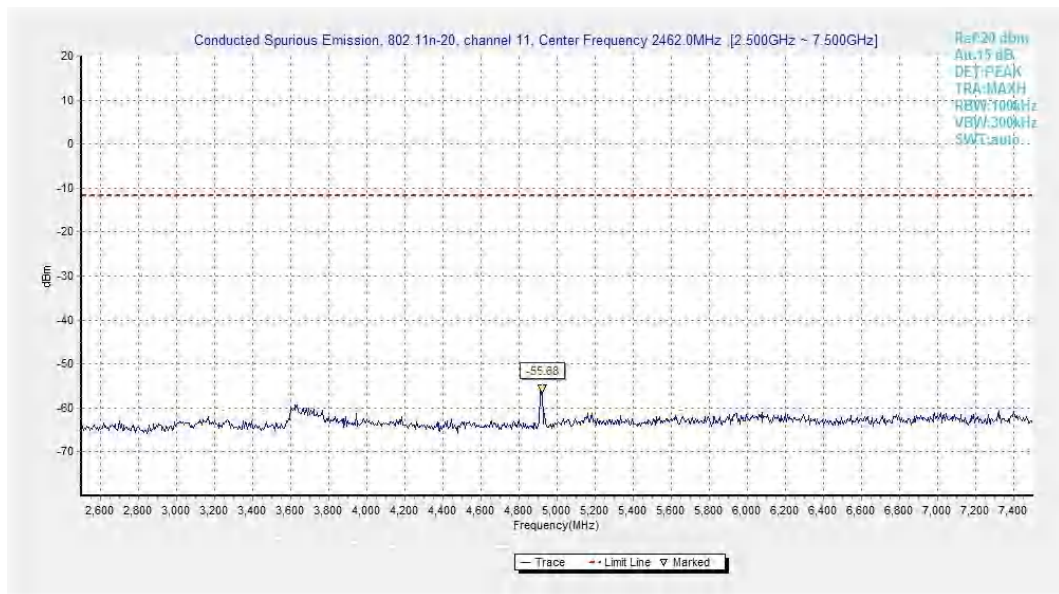
**Fig.A.6.1.65 Transmitter Spurious Emission - Conducted (802.11n-HT20, Ch11, Center Frequency)**



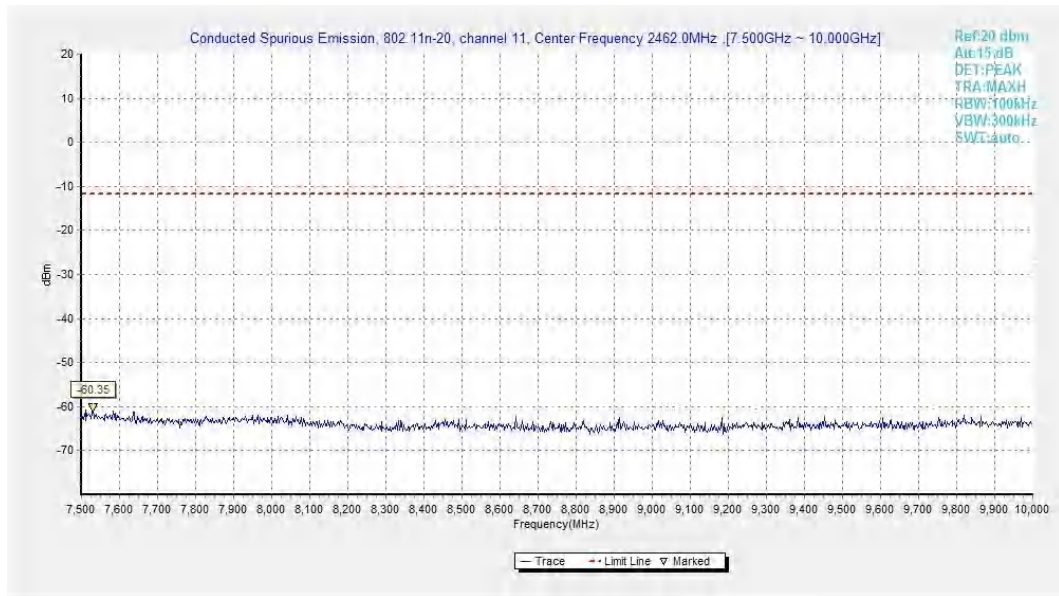
**Fig.A.6.1.66 Transmitter Spurious Emission - Conducted (802.11n-HT20, Ch11, 30 MHz-1 GHz)**



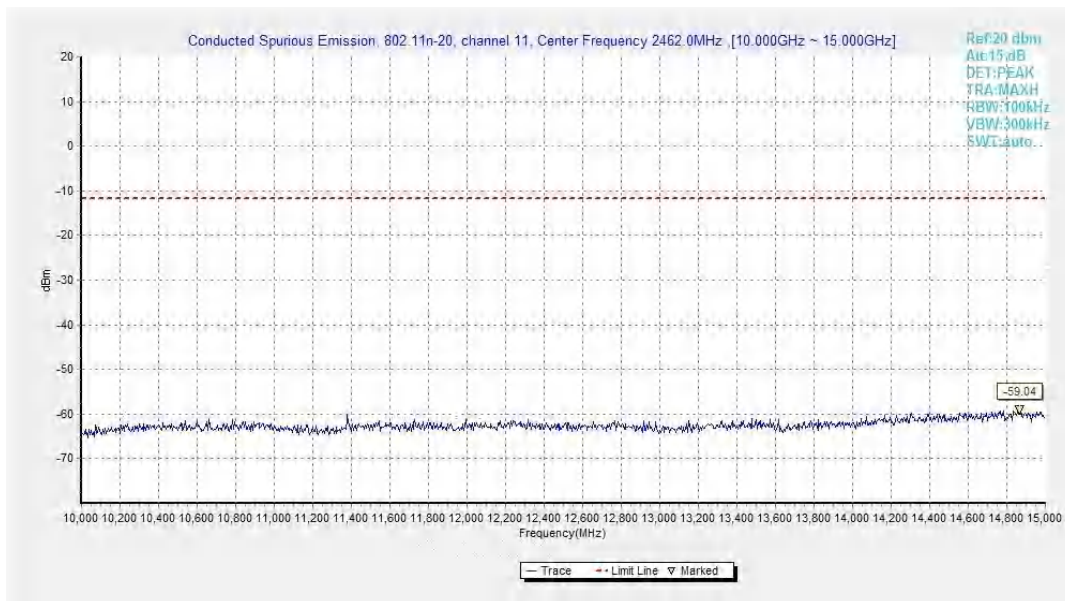
**Fig.A.6.1.67 Transmitter Spurious Emission - Conducted (802.11n-HT20, Ch11, 1 GHz-2.5 GHz)**



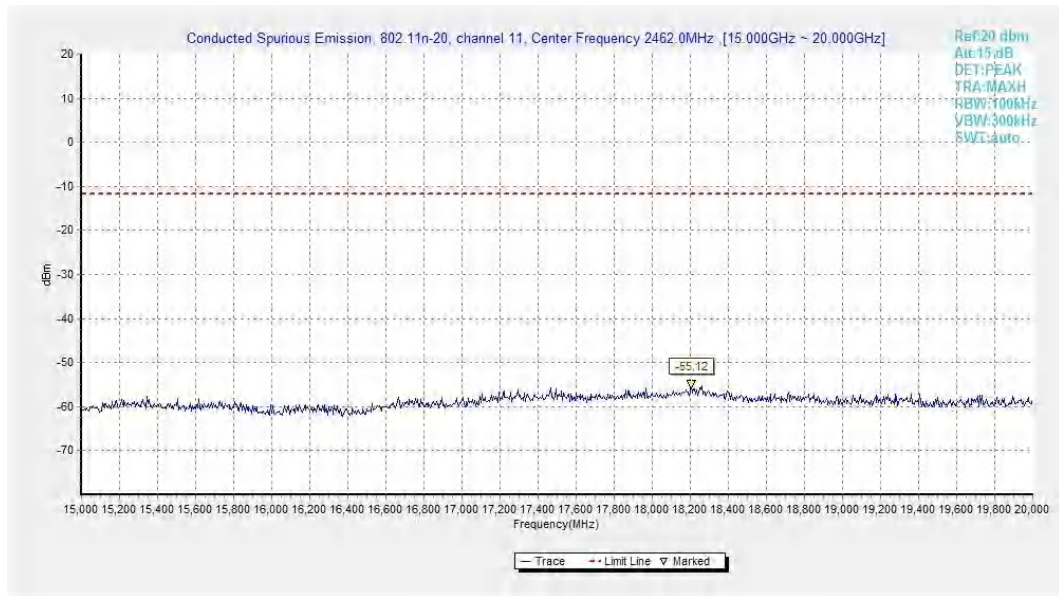
**Fig.A.6.1.68 Transmitter Spurious Emission - Conducted (802.11n-HT20, Ch11, 2.5 GHz-7.5 GHz)**



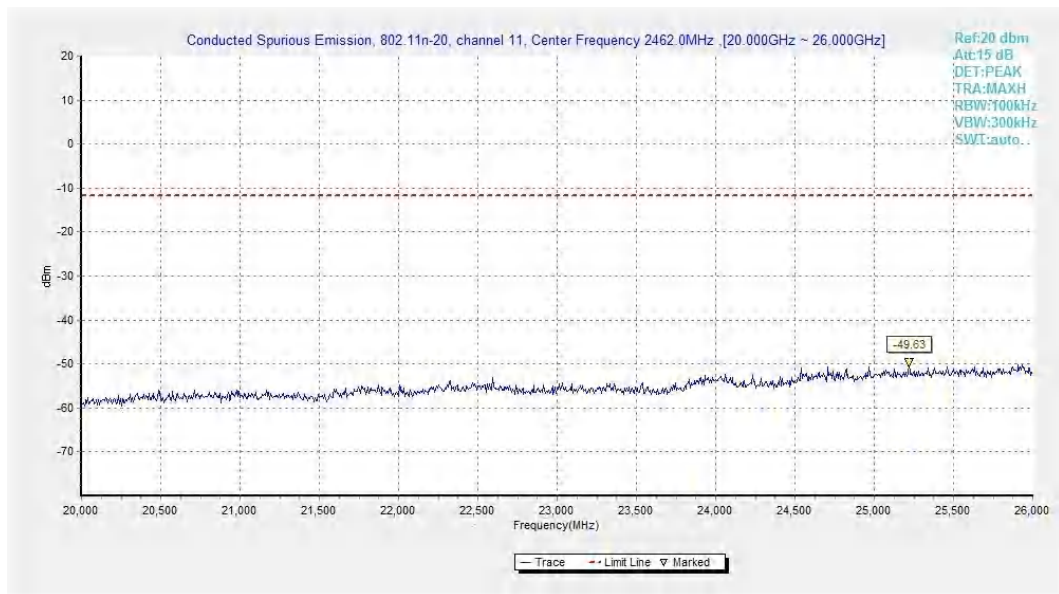
**Fig.A.6.1.69 Transmitter Spurious Emission - Conducted (802.11n-HT20, Ch11, 7.5 GHz-10 GHz)**



**Fig.A.6.1.70 Transmitter Spurious Emission - Conducted (802.11n-HT20, Ch11, 10 GHz-15 GHz)**

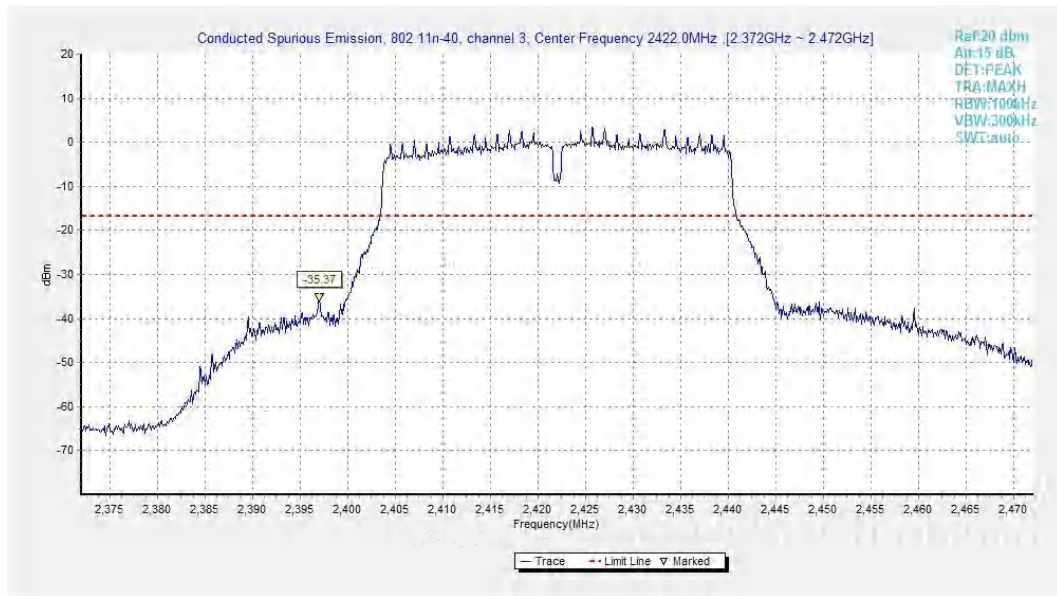


**Fig.A.6.1.71 Transmitter Spurious Emission - Conducted (802.11n-HT20, Ch11, 15 GHz-20 GHz)**

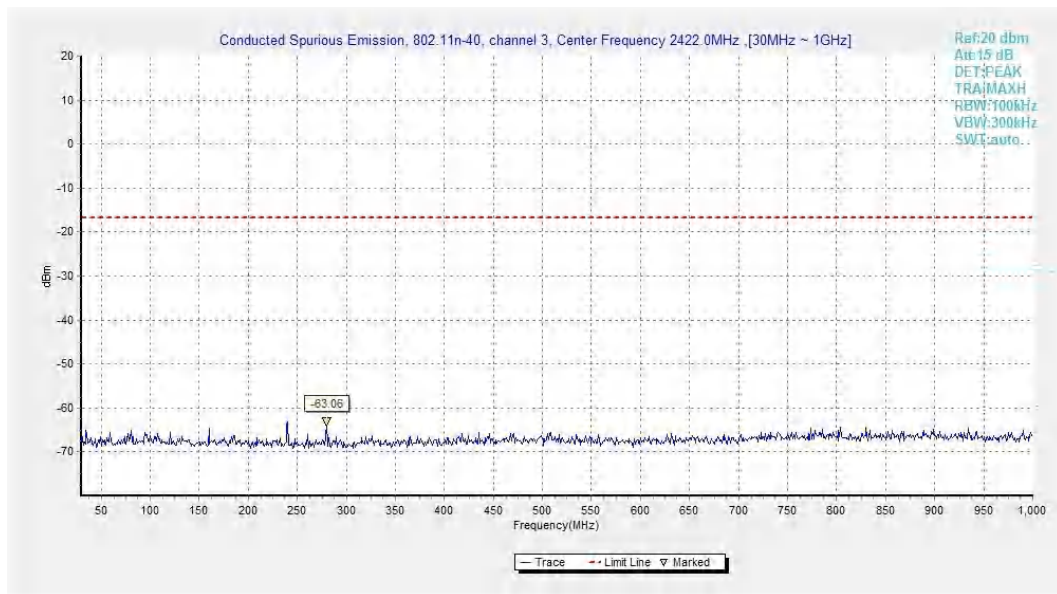


**Fig.A.6.1.72 Transmitter Spurious Emission - Conducted (802.11n-HT20, Ch11, 20 GHz-26 GHz)**

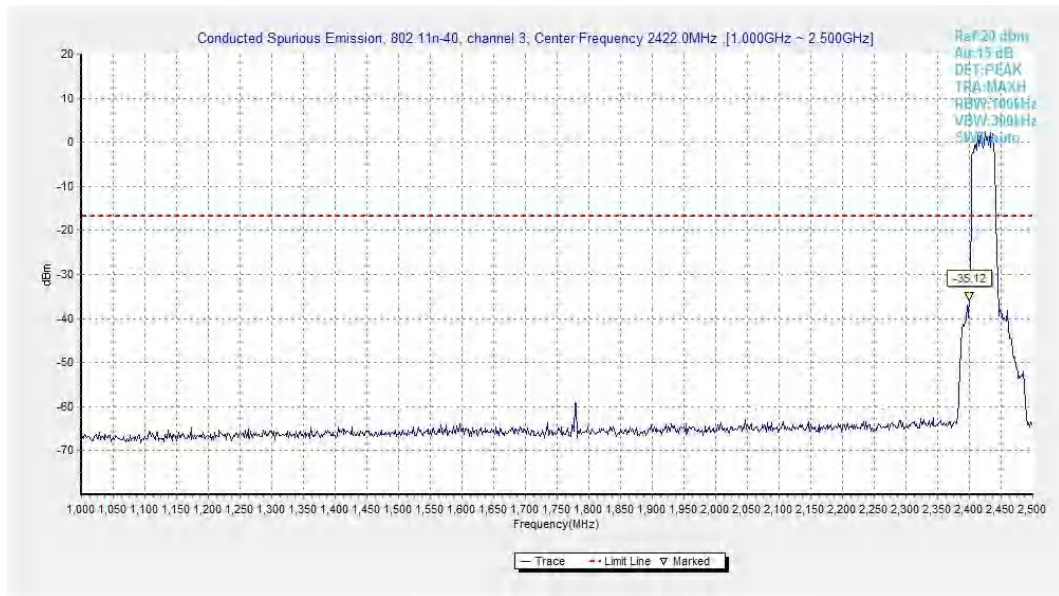




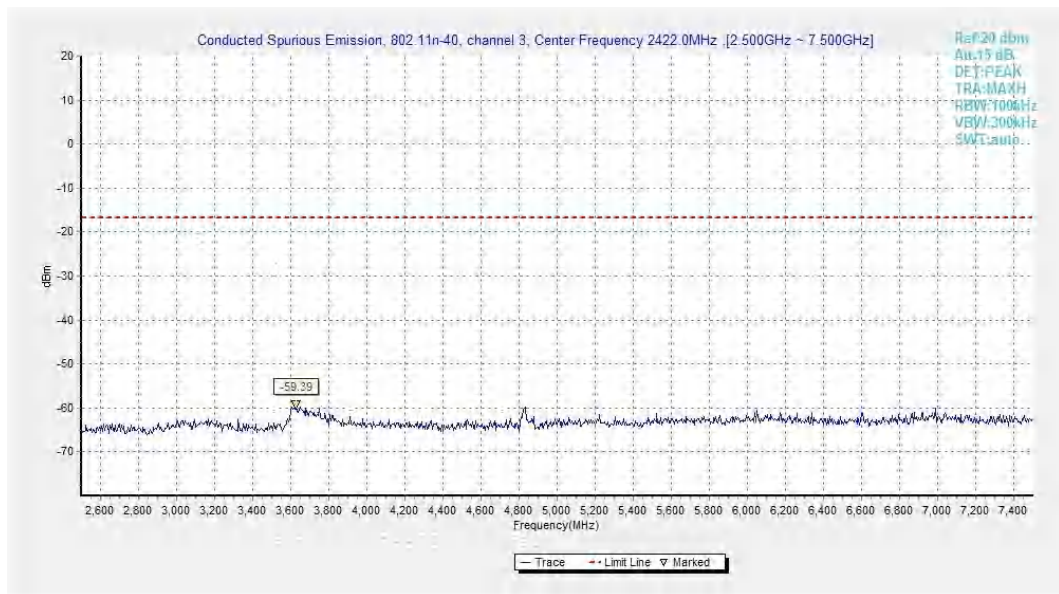
**Fig.A.6.1.73 Transmitter Spurious Emission - Conducted (802.11n-HT40, Ch3, Center Frequency)**



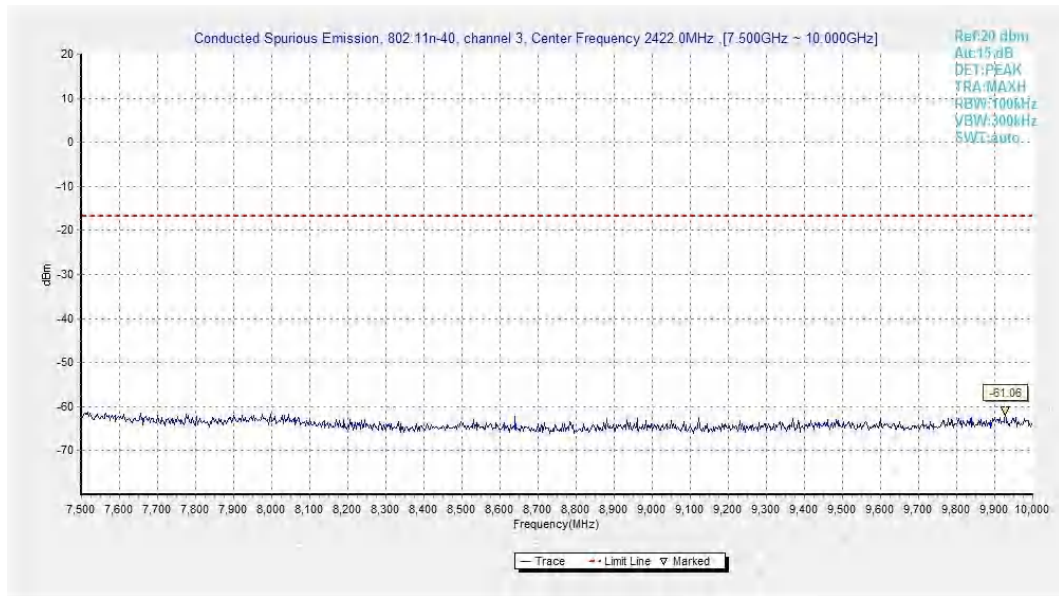
**Fig.A.6.1.74 Transmitter Spurious Emission - Conducted (802.11n-HT40, Ch3, 30 MHz-1 GHz)**



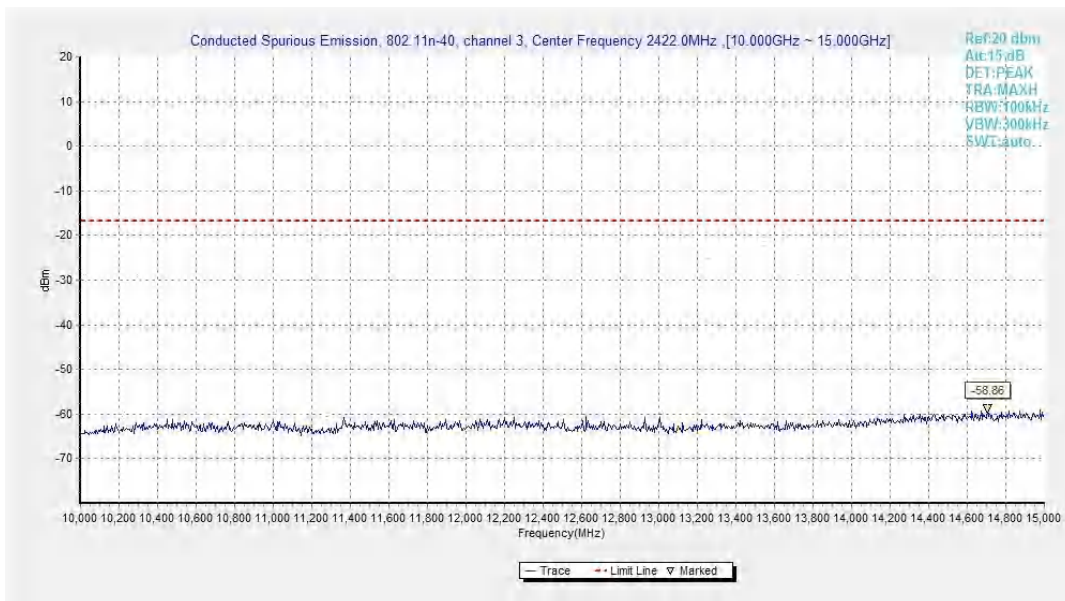
**Fig.A.6.1.75 Transmitter Spurious Emission - Conducted (802.11n-HT40, Ch3, 1 GHz-2.5 GHz)**



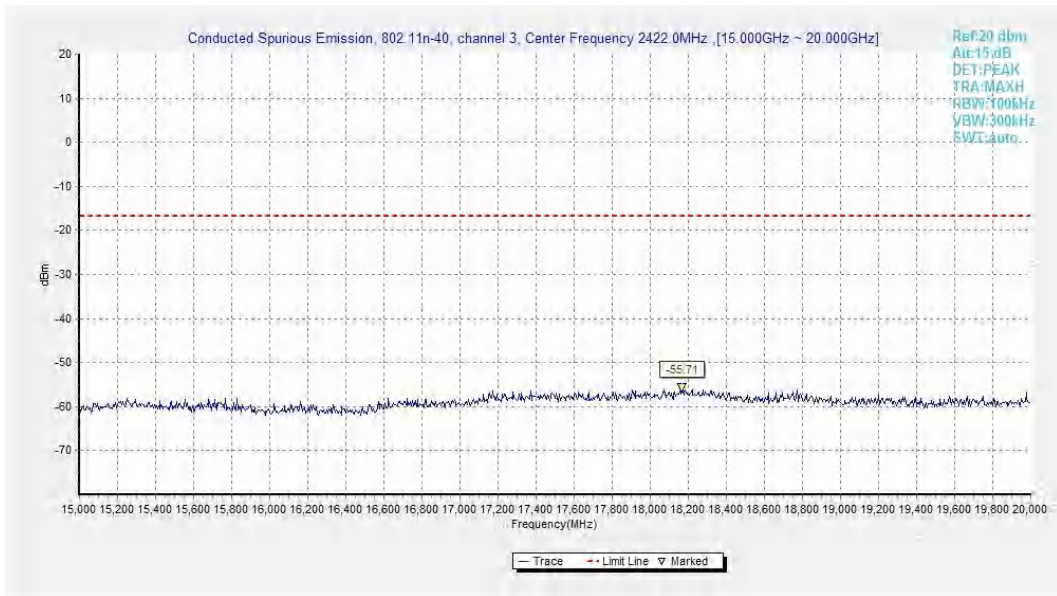
**Fig.A.6.1.76 Transmitter Spurious Emission - Conducted (802.11n-HT40, Ch3, 2.5 GHz-7.5 GHz)**



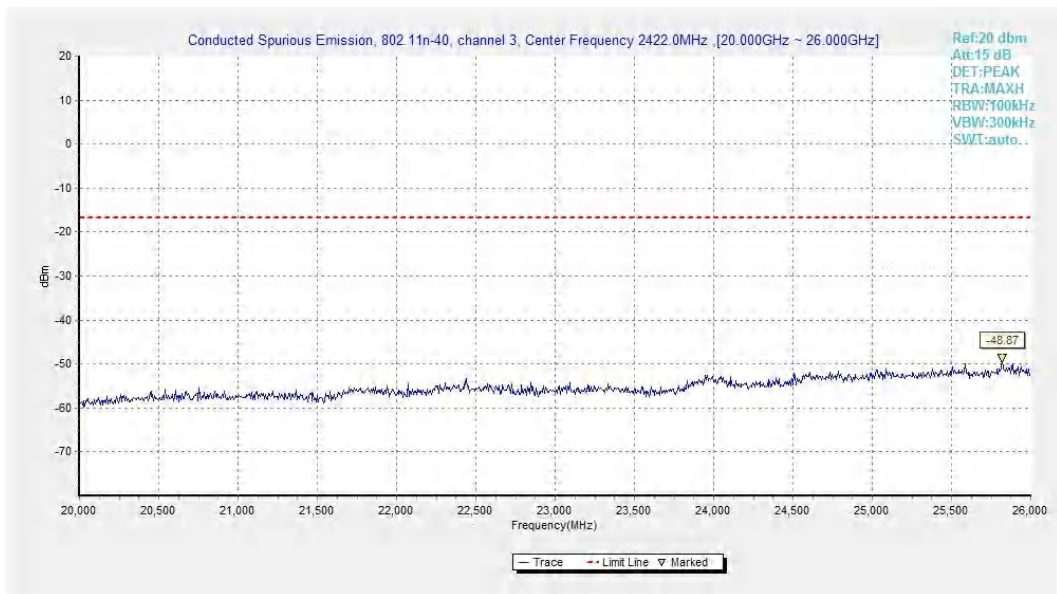
**Fig.A.6.1.77 Transmitter Spurious Emission - Conducted (802.11n-HT40, Ch3, 7.5 GHz-10 GHz)**



**Fig.A.6.1.78 Transmitter Spurious Emission - Conducted (802.11n-HT40, Ch3, 10 GHz-15 GHz)**

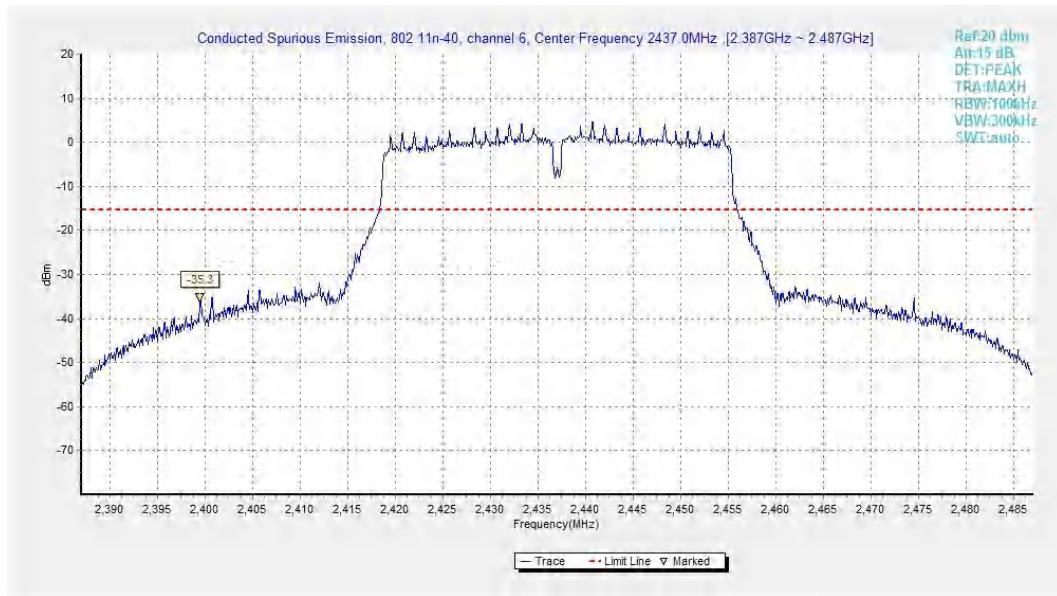


**Fig.A.6.1.79 Transmitter Spurious Emission - Conducted (802.11n-HT40, Ch3, 15 GHz-20 GHz)**

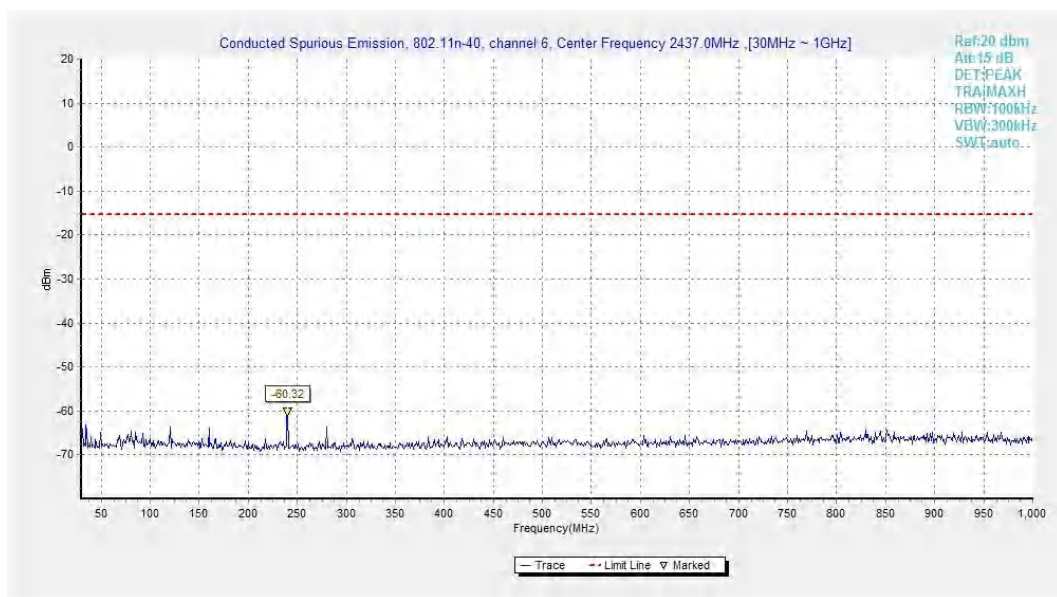


**Fig.A.6.1.80 Transmitter Spurious Emission - Conducted (802.11n-HT40, Ch3, 20 GHz-26 GHz)**

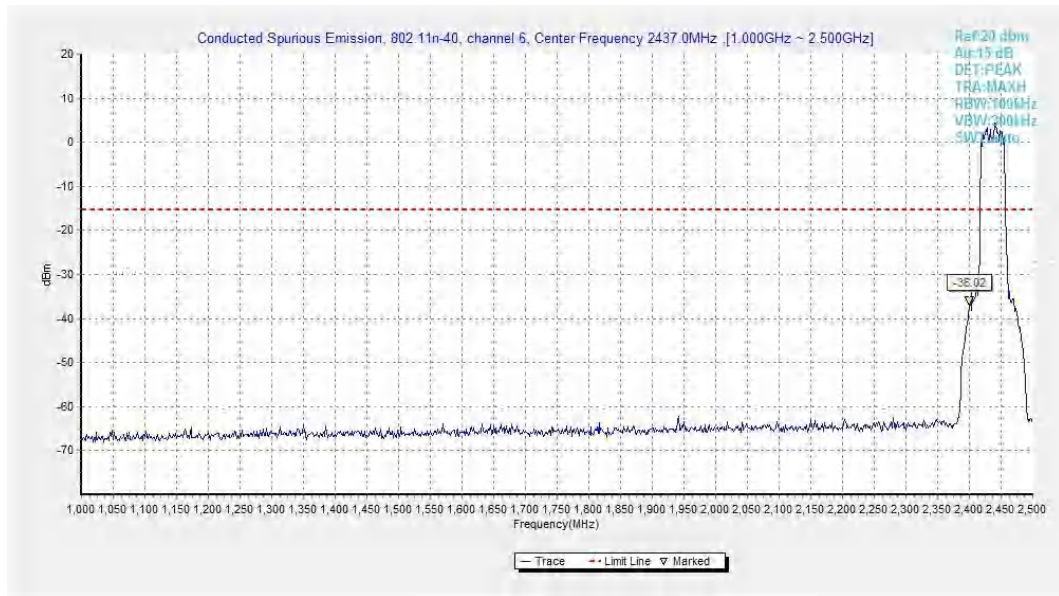




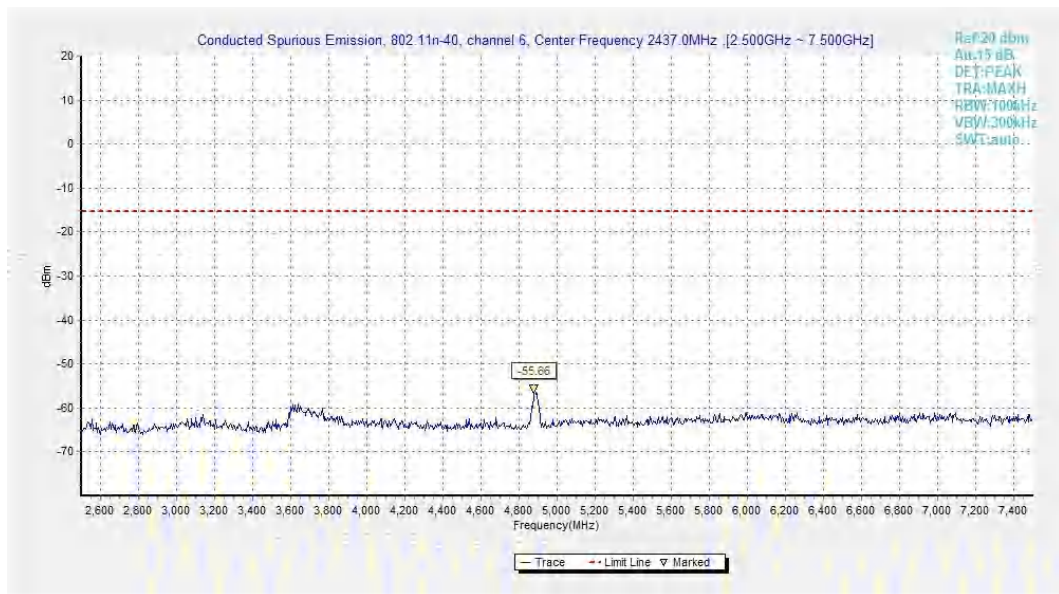
**Fig.A.6.1.81 Transmitter Spurious Emission - Conducted (802.11n-HT40, Ch6, Center Frequency)**



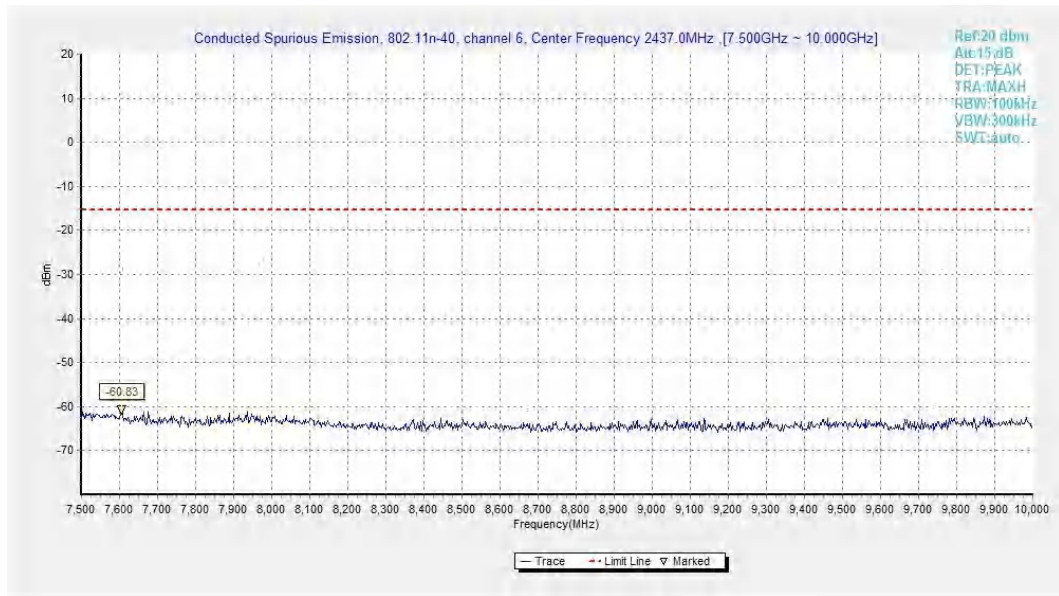
**Fig.A.6.1.82 Transmitter Spurious Emission - Conducted (802.11n-HT40, Ch6, 30 MHz-1 GHz)**



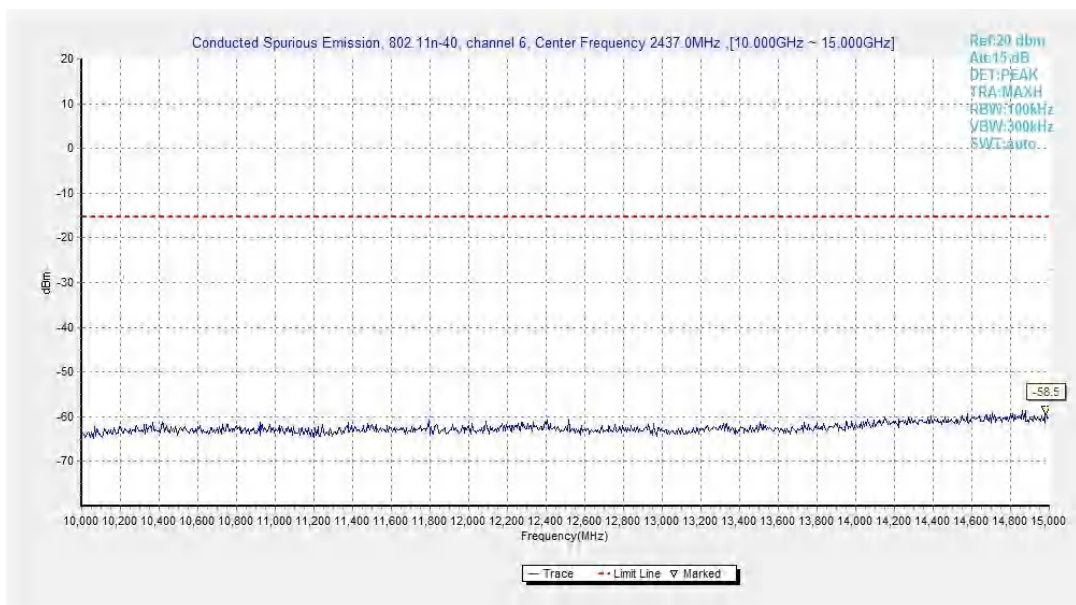
**Fig.A.6.1.83 Transmitter Spurious Emission - Conducted (802.11n-HT40, Ch6, 1 GHz-2.5 GHz)**



**Fig.A.6.1.84 Transmitter Spurious Emission - Conducted (802.11n-HT40, Ch6, 2.5 GHz-7.5 GHz)**

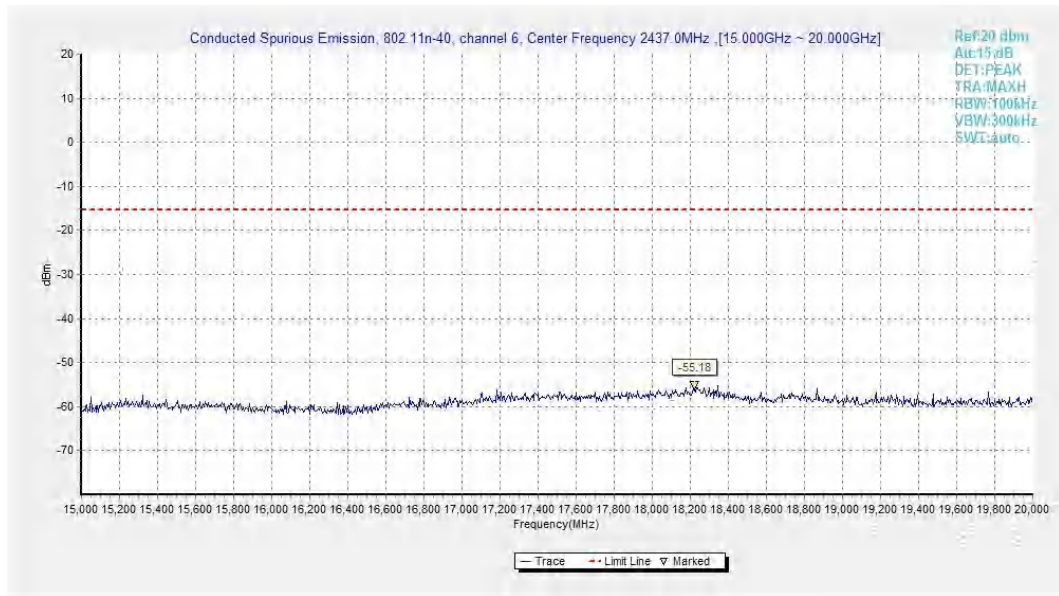


**Fig.A.6.1.85 Transmitter Spurious Emission - Conducted (802.11n-HT40, Ch6, 7.5 GHz-10 GHz)**

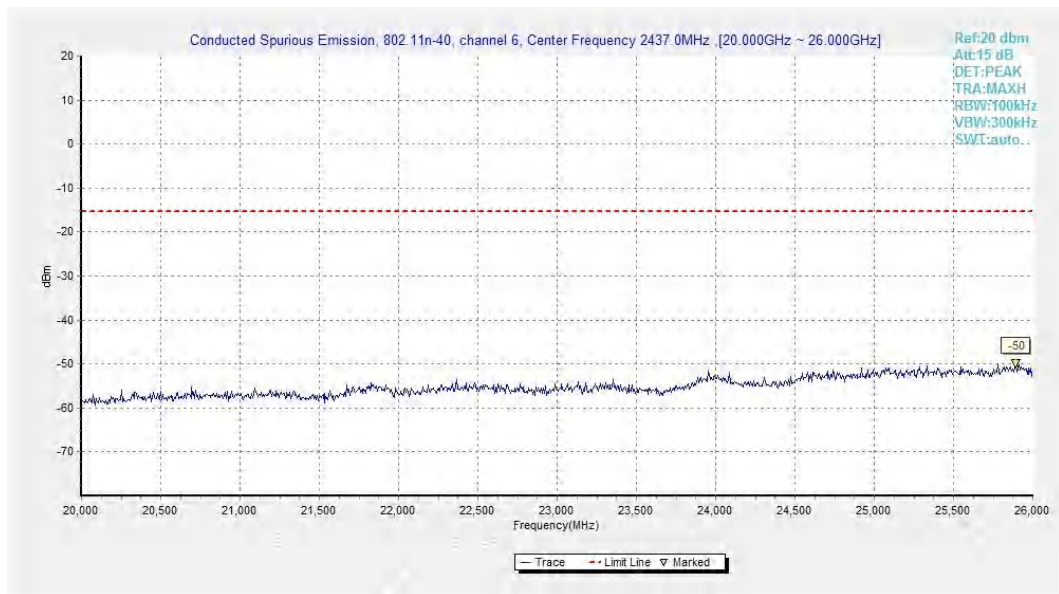


**Fig.A.6.1.86 Transmitter Spurious Emission - Conducted (802.11n-HT40, Ch6, 10 GHz-15 GHz)**



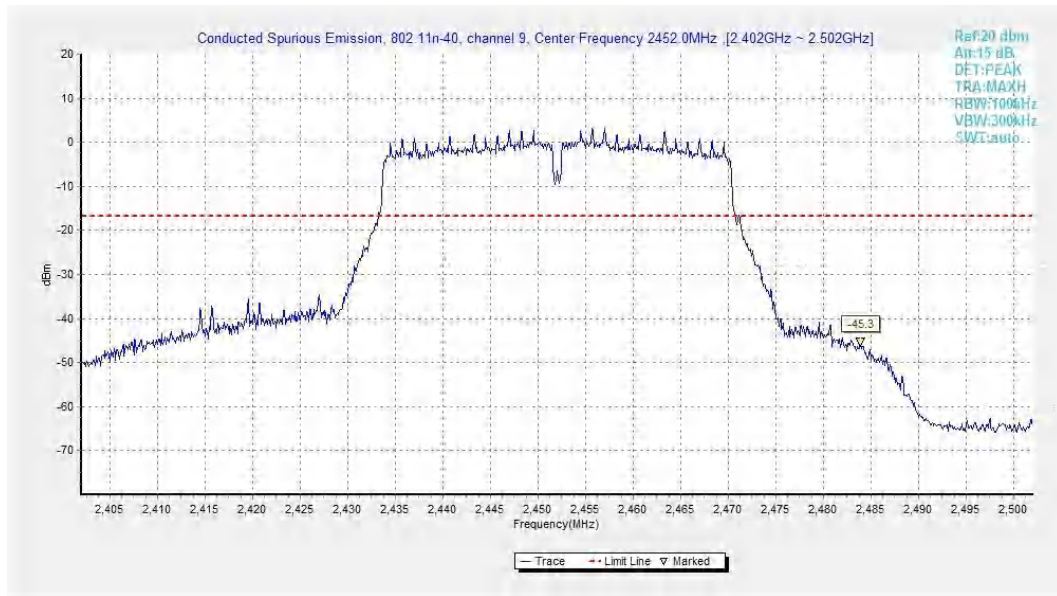


**Fig.A.6.1.87 Transmitter Spurious Emission - Conducted (802.11n-HT40, Ch6, 15 GHz-20 GHz)**

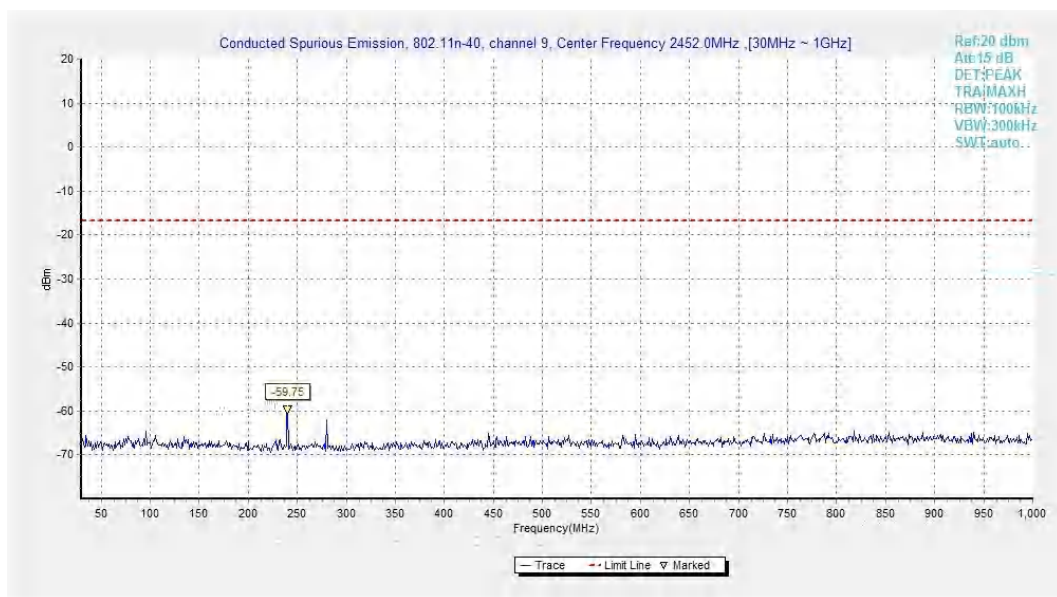


**Fig.A.6.1.88 Transmitter Spurious Emission - Conducted (802.11n-HT40, Ch6, 20 GHz-26 GHz)**

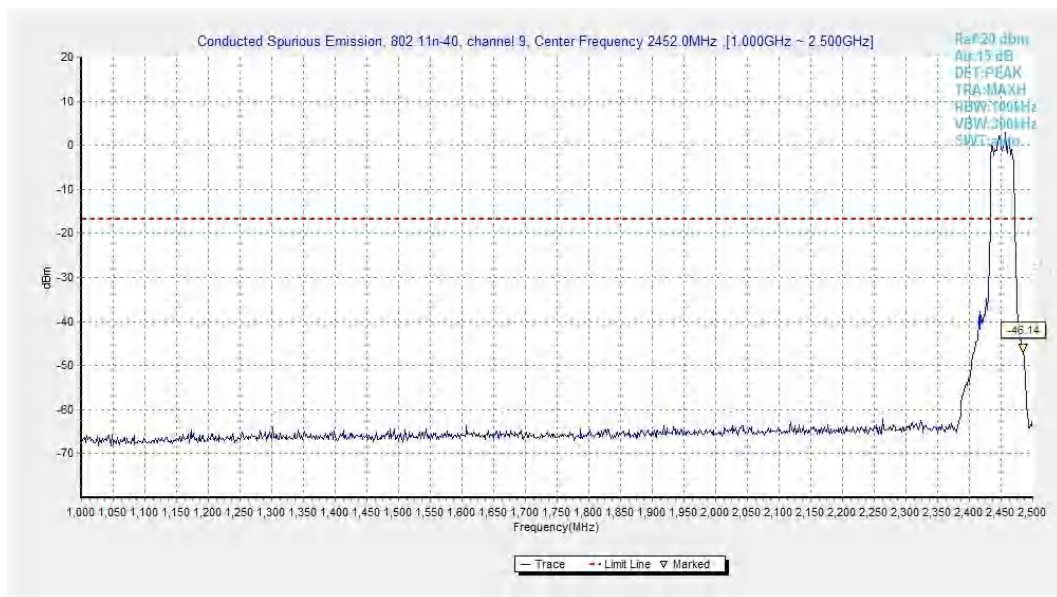




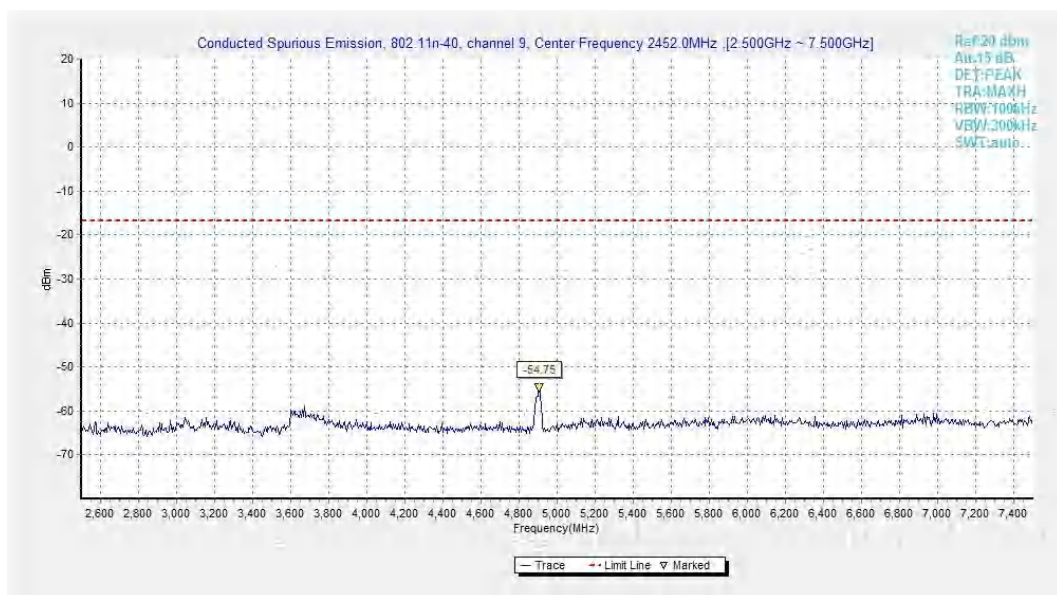
**Fig.A.6.1.89 Transmitter Spurious Emission - Conducted (802.11n-HT40, Ch9, Center Frequency)**



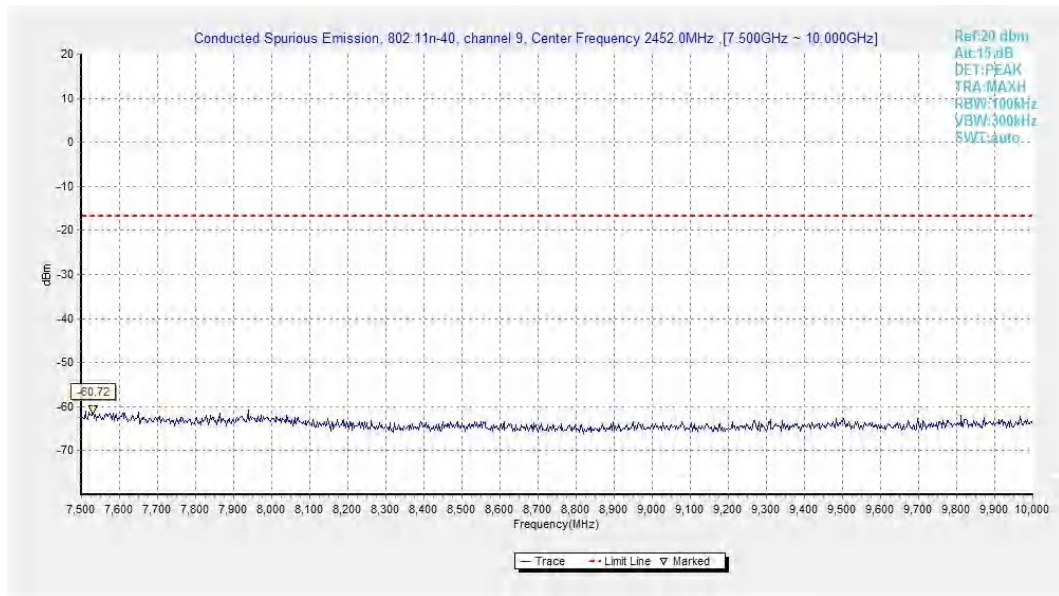
**Fig.A.6.1.90 Transmitter Spurious Emission - Conducted (802.11n-HT40, Ch9, 30 MHz-1 GHz)**



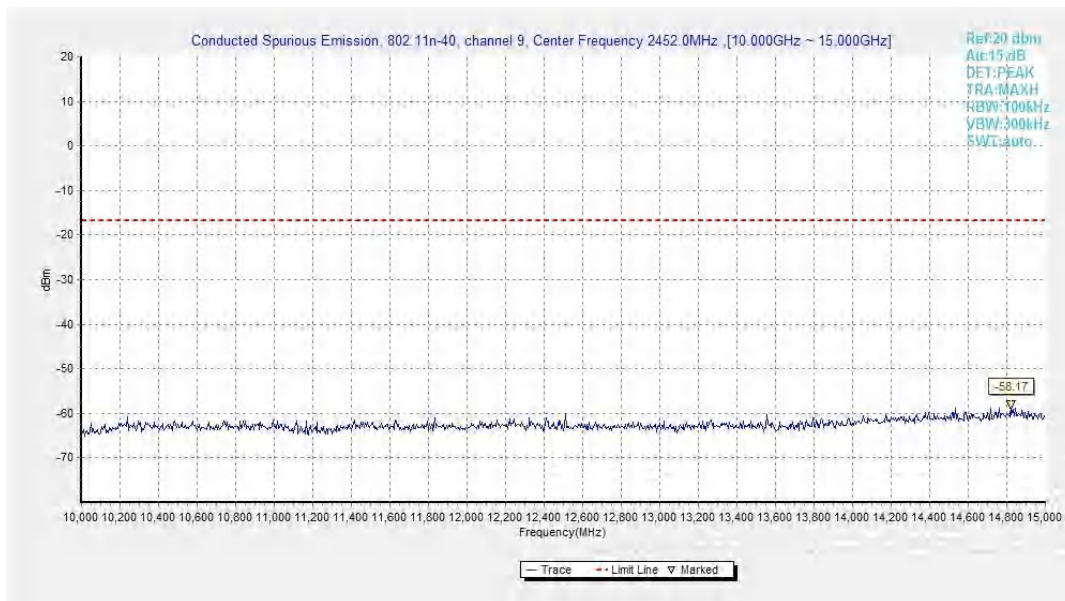
**Fig.A.6.1.91 Transmitter Spurious Emission - Conducted (802.11n-HT40, Ch9, 1 GHz-2.5 GHz)**



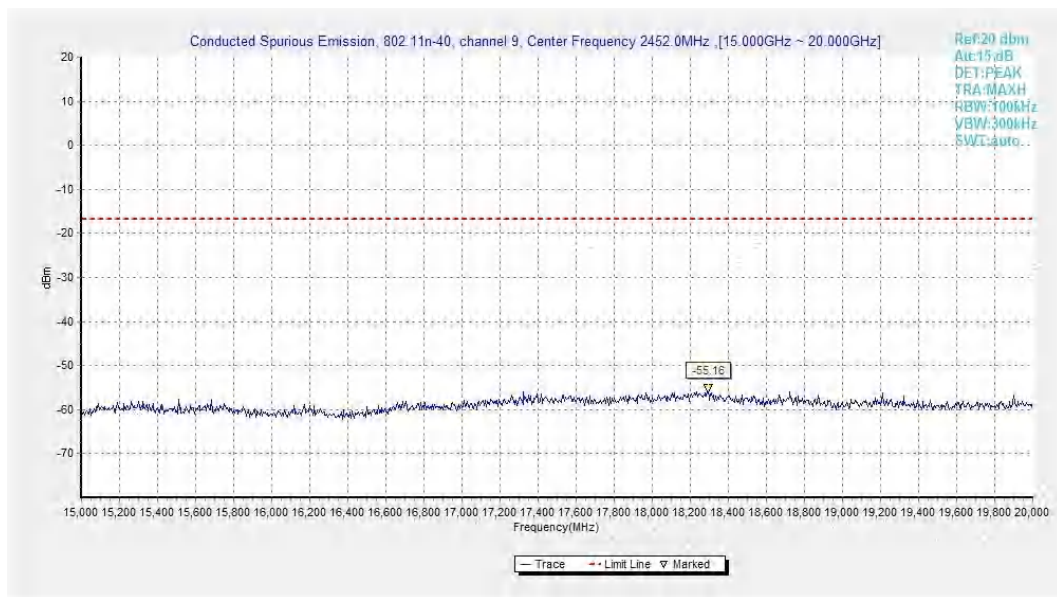
**Fig.A.6.1.92 Transmitter Spurious Emission - Conducted (802.11n-HT40, Ch9, 2.5 GHz-7.5 GHz)**



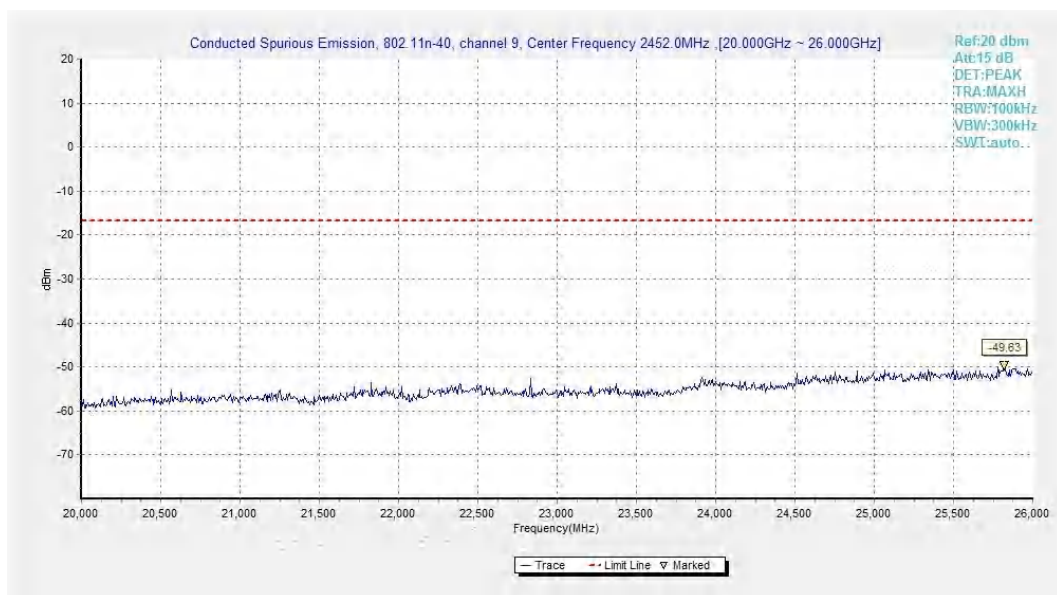
**Fig.A.6.1.93 Transmitter Spurious Emission - Conducted (802.11n-HT40, Ch9, 7.5 GHz-10 GHz)**



**Fig.A.6.1.94 Transmitter Spurious Emission - Conducted (802.11n-HT40, Ch9, 10 GHz-15 GHz)**



**Fig.A.6.1.95 Transmitter Spurious Emission - Conducted (802.11n-HT40, Ch9, 15 GHz-20 GHz)**



**Fig.A.6.1.96 Transmitter Spurious Emission - Conducted (802.11n-HT40, Ch9, 20 GHz-26 GHz)**



### A.6.2 Transmitter Spurious Emission - Radiated

**Method of Measurement:** See ANSI C63.10-2013-clause 6.4 & 6.5 & 6.6

**Measurement Limit:**

Standard	Limit
FCC 47 CFR Part 15.247, 15.205, 15.209	20dB below peak output power

radiated emissions which fall in the restricted bands, as defined in § 15.205(a), must also comply with the radiated emission limits specified in § 15.209(a) (see § 15.205(c)).

**Limit in restricted band:**

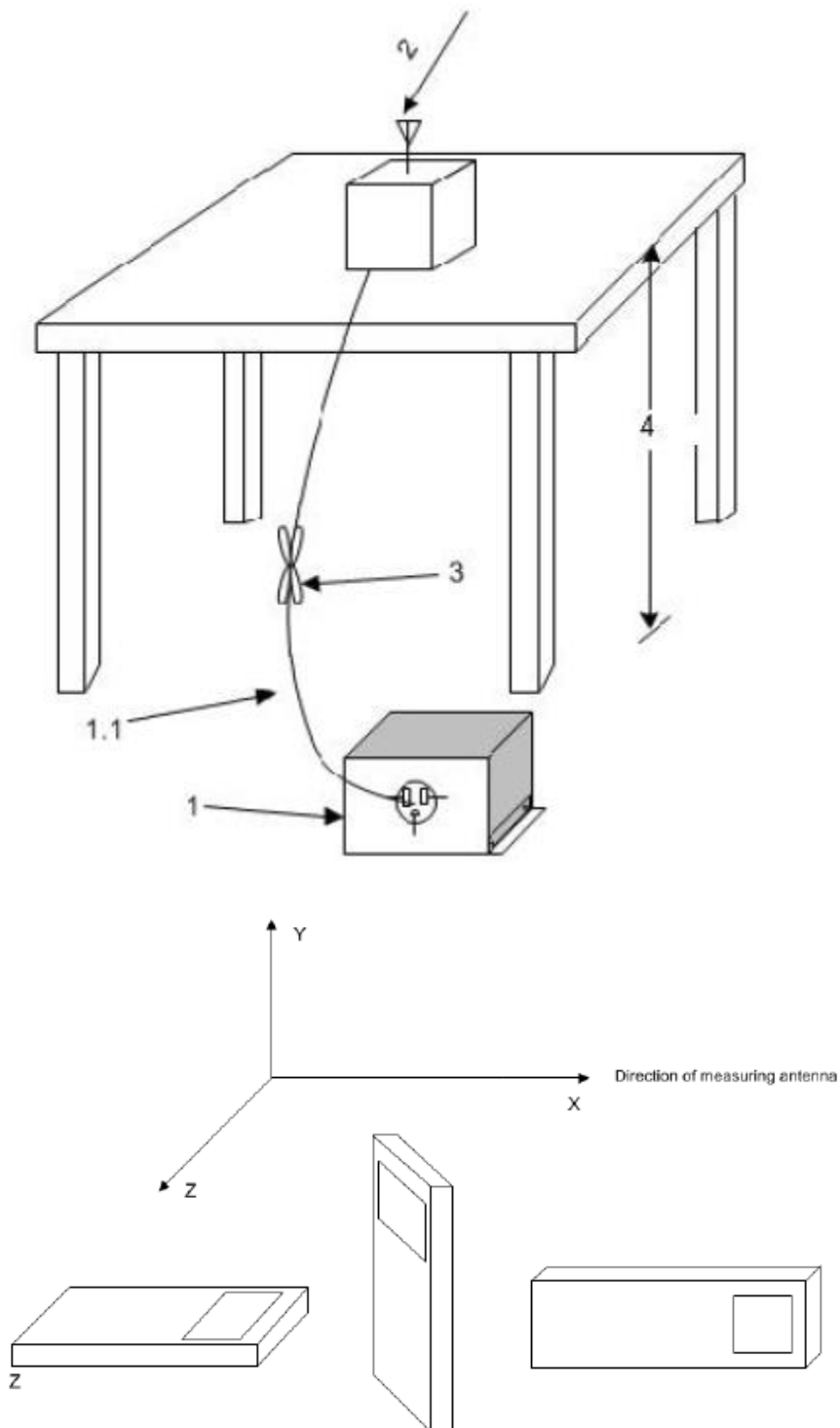
Frequency (MHz)	Field strength( $\mu$ V/m)	Measurement distance (m)
0.009 - 0.490	2400/F(kHz)	300
0.490 - 1.705	24000/F(kHz)	30
1.705 – 30.0	30	30

Frequency of emission (MHz)	Field strength(uV/m)	Field strength(dBuV/m)
30-88	100	40
88-216	150	43.5
216-960	200	46
Above 960	500	54

**Set up:**

Tabletop devices shall be placed on a nonconducting platform with nominal top surface dimensions 1 m by 1.5 m. For emissions testing at or below 1 GHz, the table height shall be 80 cm above the reference ground plane. For emission measurements above 1 GHz, the table height shall be 1.5 m.

The EUT and transmitting antenna shall be centered on the turntable.



**Test Condition**

The EUT shall be tested 1 near top, 1 near middle, and 1 near bottom. Set the unlicensed wireless device to operate in continuous transmit mode. For unlicensed wireless devices unable to be configured for 100% duty cycle even in test mode, configure the system for the maximum duty cycle supported.

When required for unlicensed wireless devices, measurements of the variation of the input power or the radiated signal level of the fundamental frequency component of the emission, as

appropriate, shall be performed with the supply voltage varied between 85% and 115% of the nominal rated supply voltage.

### **Exploratory radiated emissions measurements**

Exploratory radiated measurements shall be performed at the measurement distance or at a closer distance than that specified for compliance to determine the emission characteristics of the EUT and, if applicable, the EUT configuration that produces the maximum level of emissions. The frequencies of maximum emission may be determined by manually positioning the antenna close to the EUT, and then moving the antenna over all sides of the EUT while observing a spectral display. It is advantageous to have prior knowledge of the frequencies of emissions, although this may be determined from such a near-field scan. The near-field scan shall only be used to determine the frequency but not the amplitude of the emissions. Where exploratory measurements are not adequate to determine the worst-case operating modes and are used only to identify the frequencies of the highest emissions, additional preliminary tests can be required.

For emissions from the EUT, the maximum level shall be determined by rotating the EUT and its antenna through 0° to 360°. For each mode of operation required to be tested, the frequency spectrum (based on findings from exploratory measurements) shall be monitored.

Broadband antennas and a spectrum analyzer or a radio-noise meter with a panoramic display are often useful in this type of test. If either antenna height or EUT azimuth are not fully measured during exploratory testing, then complete testing can be required at the OATS or semi-anechoic chamber when the final full spectrum testing is performed.

### **Final radiated emissions measurements**

The final measurements are using the orientation and equipment arrangement of the EUT based on the measurement results found during the preliminary (exploratory) measurements, the EUT arrangement, appropriate modulation, and modes of operation that produce the emissions that have the highest amplitude relative to the limit shall be selected for the final measurement.

For each mode of operation required to be tested, the frequency spectrum (based on findings from exploratory measurements) shall be monitored. The highest signal levels relative to the limit shall be determined by rotating the EUT from 0° to 360° and with varying the measurement antenna height between 1 m and 4 m in vertical and horizontal polarizations.

For each mode selected, record the frequency and amplitude of the highest fundamental emission (if applicable), as well as the frequency and amplitude of the six highest spurious emissions relative to the limit. Emissions more than 20 dB below the limit do not need to be reported.

This maximization process was repeated with the EUT positioned in each of its three orthogonal orientations.

### **The receiver references:**

Frequency of emission (MHz)	RBW/VBW	Sweep Time(s)
30-1000	100KHz/300KHz	5
1000-4000	1MHz/3MHz	15
4000-18000	1MHz/3MHz	40
18000-26500	1MHz/3MHz	20



**Measurement Results:**

**EUT ID: UT22a + AE2-1 + AE1-3**

**Conclusion: Pass**

**Note:**

A "reference path loss" is established and the  $A_{Rpl}$  is the attenuation of "reference path loss", and including the gain of receive antenna, the gain of the preamplifier, the cable loss.

$P_{Mea}$  is the field strength recorded from the instrument.

The measurement results are obtained as described below:

Result= $P_{Mea}+A_{Rpl}= P_{Mea}+Cable Loss+Antenna Factor$



### Average Measurement results

#### 802.11b

##### Ch1

Frequency (MHz)	Measurement Result (dB $\mu$ V/m)	Cable Loss (dB)	Antenna Factor (dB/m)	Receiver Reading (dB $\mu$ V/m)	Limit (dB $\mu$ V/m)	Margin (dB)	Antenna Pol. (H/V)
17447.00	40.67	-26.90	45.20	22.27	54.00	13.33	V
13726.50	38.49	-29.10	40.90	26.69	54.00	15.51	H
12771.50	36.20	-30.50	39.10	27.60	54.00	17.80	H
9415.50	34.63	-32.90	37.90	29.63	54.00	19.37	V
7322.50	34.40	-35.10	36.60	32.90	54.00	19.60	V
2359.30	44.41	-20.10	28.00	36.41	54.00	9.59	H

##### Ch6

Frequency (MHz)	Measurement Result (dB $\mu$ V/m)	Cable Loss (dB)	Antenna Factor (dB/m)	Receiver Reading (dB $\mu$ V/m)	Limit (dB $\mu$ V/m)	Margin (dB)	Antenna Pol. (H/V)
17993.00	40.33	-25.50	46.70	19.13	54.00	13.67	V
13712.00	38.29	-29.10	40.90	26.49	54.00	15.71	H
12768.00	36.49	-30.50	39.10	27.89	54.00	17.51	H
9625.00	34.57	-33.10	38.00	29.67	54.00	19.43	H
7320.50	34.19	-35.10	36.60	32.69	54.00	19.81	H
4689.50	29.57	-37.40	32.90	34.07	54.00	24.43	V

##### Ch11

Frequency (MHz)	Measurement Result (dB $\mu$ V/m)	Cable Loss (dB)	Antenna Factor (dB/m)	Receiver Reading (dB $\mu$ V/m)	Limit (dB $\mu$ V/m)	Margin (dB)	Antenna Pol. (H/V)
17452.50	40.26	-26.90	45.20	21.86	54.00	13.74	H
13702.00	38.24	-29.10	40.90	26.44	54.00	15.76	V
12997.00	36.03	-30.50	39.20	27.33	54.00	17.97	H
8708.50	34.70	-34.40	38.00	31.10	54.00	19.30	H
7316.50	34.46	-35.10	36.60	32.96	54.00	19.54	H
2485.00	44.80	-20.00	28.30	36.50	54.00	9.20	H

**802.11g**

## Ch1

Frequency (MHz)	Measurement Result (dBμV/m)	Cable Loss (dB)	Antenna Factor (dB/m)	Receiver Reading (dBμV/m)	Limit (dBμV/m)	Margin (dB)	Antenna Pol. (H/V)
17964.00	40.05	-25.50	46.70	18.85	54.00	13.95	V
14129.00	38.17	-29.00	42.00	25.17	54.00	15.83	H
12777.50	36.29	-30.70	39.10	27.79	54.00	17.71	V
9510.00	34.49	-33.20	37.90	29.79	54.00	19.51	V
7317.00	34.27	-35.10	36.60	32.77	54.00	19.73	H
2390.00	48.22	-20.00	28.10	40.22	54.00	5.78	H

## Ch6

Frequency (MHz)	Measurement Result (dBμV/m)	Cable Loss (dB)	Antenna Factor (dB/m)	Receiver Reading (dBμV/m)	Limit (dBμV/m)	Margin (dB)	Antenna Pol. (H/V)
17918.50	40.08	-25.50	46.70	18.88	54.00	13.92	V
13711.00	38.03	-29.10	40.90	26.23	54.00	15.97	H
12770.50	36.13	-30.50	39.10	27.53	54.00	17.87	H
9409.50	34.70	-32.90	37.90	29.70	54.00	19.30	H
7328.50	34.01	-35.10	36.60	32.51	54.00	19.99	H
4937.50	29.30	-37.10	33.30	33.10	54.00	24.70	V

## Ch11

Frequency (MHz)	Measurement Result (dBμV/m)	Cable Loss (dB)	Antenna Factor (dB/m)	Receiver Reading (dBμV/m)	Limit (dBμV/m)	Margin (dB)	Antenna Pol. (H/V)
17999.00	40.08	-25.50	46.70	18.88	54.00	13.92	V
14584.00	38.09	-27.30	41.90	23.49	54.00	15.91	V
12770.00	36.03	-30.50	39.10	27.43	54.00	17.97	V
9313.50	34.46	-33.90	38.00	30.36	54.00	19.54	V
7324.50	34.08	-35.10	36.60	32.58	54.00	19.92	H
2485.10	46.87	-20.00	28.30	38.57	54.00	7.13	H

**802.11n-HT20**

## Ch1

Frequency (MHz)	Measurement Result (dBμV/m)	Cable Loss (dB)	Antenna Factor (dB/m)	Receiver Reading (dBμV/m)	Limit (dBμV/m)	Margin (dB)	Antenna Pol. (H/V)
17992.00	40.11	-25.50	46.70	18.91	54.00	13.89	H
13706.50	37.83	-29.10	40.90	26.03	54.00	16.17	V
12780.50	36.09	-30.70	39.10	27.59	54.00	17.91	H
9505.50	34.84	-33.20	37.90	30.14	54.00	19.16	H
7318.50	33.94	-35.10	36.60	32.44	54.00	20.06	V
2389.90	49.57	-20.00	28.10	41.57	54.00	4.43	H

## Ch6

Frequency (MHz)	Measurement Result (dBμV/m)	Cable Loss (dB)	Antenna Factor (dB/m)	Receiver Reading (dBμV/m)	Limit (dBμV/m)	Margin (dB)	Antenna Pol. (H/V)
17965.50	40.00	-25.50	46.70	18.80	54.00	14.00	V
14113.00	38.11	-29.00	42.00	25.11	54.00	15.89	V
12782.00	36.17	-30.70	39.10	27.67	54.00	17.83	V
9512.50	34.73	-33.20	37.90	30.03	54.00	19.27	V
7316.00	33.93	-35.00	36.50	32.33	54.00	20.07	H
4953.50	29.34	-37.10	33.30	33.14	54.00	24.66	V

## Ch11

Frequency (MHz)	Measurement Result (dBμV/m)	Cable Loss (dB)	Antenna Factor (dB/m)	Receiver Reading (dBμV/m)	Limit (dBμV/m)	Margin (dB)	Antenna Pol. (H/V)
17,980.00	39.98	-25.50	46.70	18.78	54.00	14.02	H
14,099.50	37.97	-29.40	41.70	25.77	54.00	16.03	V
12,769.50	36.03	-30.50	39.10	27.43	54.00	17.97	H
9,508.50	34.57	-33.20	37.90	29.87	54.00	19.43	V
7,317.50	34.00	-35.10	36.60	32.50	54.00	20.00	V
2,485.50	46.92	-20.00	28.30	38.62	54.00	7.08	H

**802.11n-HT40**

## Ch1

Frequency (MHz)	Measurement Result (dBμV/m)	Cable Loss (dB)	Antenna Factor (dB/m)	Receiver Reading (dBμV/m)	Limit (dBμV/m)	Margin (dB)	Antenna Pol. (H/V)
17933.00	39.88	-25.50	46.70	18.68	54.00	14.12	V
13695.50	38.10	-29.10	40.90	26.30	54.00	15.90	H
12768.50	36.26	-30.50	39.10	27.66	54.00	17.74	H
9894.00	34.70	-33.50	38.10	30.10	54.00	19.30	H
7311.00	34.15	-35.00	36.50	32.55	54.00	19.85	V
2389.70	48.38	-20.00	28.10	40.38	54.00	5.62	H

## Ch6

Frequency (MHz)	Measurement Result (dBμV/m)	Cable Loss (dB)	Antenna Factor (dB/m)	Receiver Reading (dBμV/m)	Limit (dBμV/m)	Margin (dB)	Antenna Pol. (H/V)
17983.50	39.97	-25.50	46.70	18.77	54.00	14.03	H
13714.50	37.99	-29.10	40.90	26.19	54.00	16.01	V
12765.00	36.23	-30.50	39.10	27.63	54.00	17.77	V
9510.00	34.96	-33.20	37.90	30.26	54.00	19.04	H
7312.00	33.98	-35.00	36.50	32.38	54.00	20.02	H
4785.00	29.32	-37.30	33.00	33.52	54.00	24.68	V

## Ch11

Frequency (MHz)	Measurement Result (dBμV/m)	Cable Loss (dB)	Antenna Factor (dB/m)	Receiver Reading (dBμV/m)	Limit (dBμV/m)	Margin (dB)	Antenna Pol. (H/V)
17931.50	39.98	-25.50	46.70	18.78	54.00	14.02	V
14169.00	38.11	-29.00	42.00	25.11	54.00	15.89	H
12769.00	36.19	-30.50	39.10	27.59	54.00	17.81	V
9504.50	34.62	-33.20	37.90	29.92	54.00	19.38	V
7220.50	34.00	-35.50	36.40	33.10	54.00	20.00	V
2485.00	48.40	-20.00	28.30	40.10	54.00	5.60	H



**Peak Measurement results**
**802.11b**
**Ch1**

Frequency (MHz)	Measurement Result (dB $\mu$ V/m)	Cable Loss (dB)	Antenna Factor (dB/m)	Receiver Reading (dB $\mu$ V/m)	Limit (dB $\mu$ V/m)	Margin (dB)	Antenna Pol. (H/V)
17418.50	52.09	-26.90	45.20	33.69	74.00	21.91	H
13681.50	49.62	-29.50	40.40	38.72	74.00	24.38	V
12274.00	47.76	-31.40	39.00	40.16	74.00	26.24	H
7321.00	46.47	-35.10	36.60	44.97	74.00	27.53	V
9215.50	45.99	-33.70	38.00	41.69	74.00	28.01	V
2389.00	56.55	-20.00	28.10	48.55	74.00	17.45	H

**Ch6**

Frequency (MHz)	Measurement Result (dB $\mu$ V/m)	Cable Loss (dB)	Antenna Factor (dB/m)	Receiver Reading (dB $\mu$ V/m)	Limit (dB $\mu$ V/m)	Margin (dB)	Antenna Pol. (H/V)
17656.50	51.51	-25.70	46.00	31.31	74.00	22.49	H
13687.50	49.74	-29.50	40.40	38.84	74.00	24.26	H
12785.50	48.10	-30.70	39.10	39.60	74.00	25.90	V
9807.00	46.20	-33.50	38.00	41.70	74.00	27.80	H
7547.50	46.01	-35.00	36.90	44.21	74.00	27.99	H
4956.50	41.34	-37.10	33.30	45.14	74.00	32.66	V

**Ch11**

Frequency (MHz)	Measurement Result (dB $\mu$ V/m)	Cable Loss (dB)	Antenna Factor (dB/m)	Receiver Reading (dB $\mu$ V/m)	Limit (dB $\mu$ V/m)	Margin (dB)	Antenna Pol. (H/V)
17657.00	52.02	-25.70	46.00	31.82	74.00	21.98	H
14566.00	49.45	-27.30	41.90	34.85	74.00	24.55	H
12663.00	47.96	-30.50	39.10	39.36	74.00	26.04	H
9747.50	45.90	-33.00	38.00	40.90	74.00	28.10	V
7324.00	45.41	-35.10	36.60	43.91	74.00	28.59	H
2485.50	56.58	-20.00	28.30	48.28	74.00	17.42	H

**802.11g**

## Ch1

Frequency (MHz)	Measurement Result (dB $\mu$ V/m)	Cable Loss (dB)	Antenna Factor (dB/m)	Receiver Reading (dB $\mu$ V/m)	Limit (dB $\mu$ V/m)	Margin (dB)	Antenna Pol. (H/V)
17912.00	51.29	-25.50	46.70	30.09	74.00	22.71	H
14139.50	49.43	-29.00	42.00	36.43	74.00	24.57	H
11300.50	47.58	-32.40	38.80	41.18	74.00	26.42	V
8772.50	46.57	-33.90	38.10	42.37	74.00	27.43	H
7322.50	45.47	-35.10	36.60	43.97	74.00	28.53	H
2389.60	60.24	-20.00	28.10	52.24	74.00	13.76	H

## Ch6

Frequency (MHz)	Measurement Result (dB $\mu$ V/m)	Cable Loss (dB)	Antenna Factor (dB/m)	Receiver Reading (dB $\mu$ V/m)	Limit (dB $\mu$ V/m)	Margin (dB)	Antenna Pol. (H/V)
17538.00	51.94	-26.90	45.20	33.54	74.00	22.06	H
14598.00	49.43	-27.30	41.90	34.83	74.00	24.57	H
11805.50	47.18	-31.80	39.00	39.98	74.00	26.82	V
9721.00	46.45	-33.00	38.00	41.45	74.00	27.55	V
7230.00	45.69	-35.50	36.40	44.79	74.00	28.31	H
4812.00	41.22	-37.30	33.00	45.42	74.00	32.78	H

## Ch11

Frequency (MHz)	Measurement Result (dB $\mu$ V/m)	Cable Loss (dB)	Antenna Factor (dB/m)	Receiver Reading (dB $\mu$ V/m)	Limit (dB $\mu$ V/m)	Margin (dB)	Antenna Pol. (H/V)
17553.00	51.58	-26.90	45.20	33.18	74.00	22.42	V
14142.00	49.28	-29.00	42.00	36.28	74.00	24.72	H
12851.50	47.72	-30.70	39.10	39.22	74.00	26.28	V
9104.50	46.05	-33.80	38.10	41.65	74.00	27.95	V
7315.50	45.50	-35.00	36.50	43.90	74.00	28.50	H
2485.50	58.93	-20.00	28.30	50.63	74.00	15.07	H

**802.11n-HT20**
**Ch1**

Frequency (MHz)	Measurement Result (dBμV/m)	Cable Loss (dB)	Antenna Factor (dB/m)	Receiver Reading (dBμV/m)	Limit (dBμV/m)	Margin (dB)	Antenna Pol. (H/V)
17940.00	51.42	-25.50	46.70	30.22	74.00	22.58	H
13990.50	49.87	-29.40	41.70	37.67	74.00	24.13	H
11877.00	47.47	-31.80	39.00	40.27	74.00	26.53	H
9944.00	46.84	-33.50	38.10	42.24	74.00	27.16	H
7334.00	45.90	-35.10	36.60	44.40	74.00	28.10	H
2389.60	60.96	-20.00	28.10	52.96	74.00	13.04	H

**Ch6**

Frequency (MHz)	Measurement Result (dBμV/m)	Cable Loss (dB)	Antenna Factor (dB/m)	Receiver Reading (dBμV/m)	Limit (dBμV/m)	Margin (dB)	Antenna Pol. (H/V)
17944.50	51.31	-25.50	46.70	30.11	74.00	22.69	H
13581.50	49.05	-29.50	40.40	38.15	74.00	24.95	V
12991.00	47.57	-30.50	39.20	38.87	74.00	26.43	V
9730.00	46.13	-33.00	38.00	41.13	74.00	27.87	V
7498.00	45.86	-34.50	36.80	43.56	74.00	28.14	V
4683.00	40.45	-37.40	32.90	44.95	74.00	33.55	H

**Ch11**

Frequency (MHz)	Measurement Result (dBμV/m)	Cable Loss (dB)	Antenna Factor (dB/m)	Receiver Reading (dBμV/m)	Limit (dBμV/m)	Margin (dB)	Antenna Pol. (H/V)
17532.00	52.03	-26.90	45.20	33.63	74.00	21.97	V
13695.50	49.39	-29.10	40.90	37.59	74.00	24.61	V
12918.50	48.96	-30.50	39.20	40.26	74.00	25.04	V
9301.00	46.83	-33.90	38.00	42.73	74.00	27.17	H
7713.00	45.45	-34.80	37.00	43.35	74.00	28.55	V
2485.20	58.02	-20.00	28.30	49.72	74.00	15.98	H

**802.11n-HT40**
**Ch1**

Frequency (MHz)	Measurement Result (dBμV/m)	Cable Loss (dB)	Antenna Factor (dB/m)	Receiver Reading (dBμV/m)	Limit (dBμV/m)	Margin (dB)	Antenna Pol. (H/V)
17933.00	39.88	-25.50	46.70	18.68	54.00	14.12	V
13695.50	38.10	-29.10	40.90	26.30	54.00	15.90	H
12768.50	36.26	-30.50	39.10	27.66	54.00	17.74	H
9894.00	34.70	-33.50	38.10	30.10	54.00	19.30	H
7311.00	34.15	-35.00	36.50	32.55	54.00	19.85	V
2389.70	48.38	-20.00	28.10	40.38	54.00	5.62	H

**Ch6**

Frequency (MHz)	Measurement Result (dBμV/m)	Cable Loss (dB)	Antenna Factor (dB/m)	Receiver Reading (dBμV/m)	Limit (dBμV/m)	Margin (dB)	Antenna Pol. (H/V)
17449.00	51.82	-26.90	45.20	33.42	74.00	22.18	H
14572.50	49.25	-27.30	41.90	34.65	74.00	24.75	V
12903.50	47.72	-30.50	39.20	39.02	74.00	26.28	H
7428.50	46.56	-35.20	36.70	44.96	74.00	27.44	V
8706.00	45.92	-34.40	38.00	42.32	74.00	28.08	V
4844.50	40.61	-37.50	33.10	44.91	74.00	33.39	H

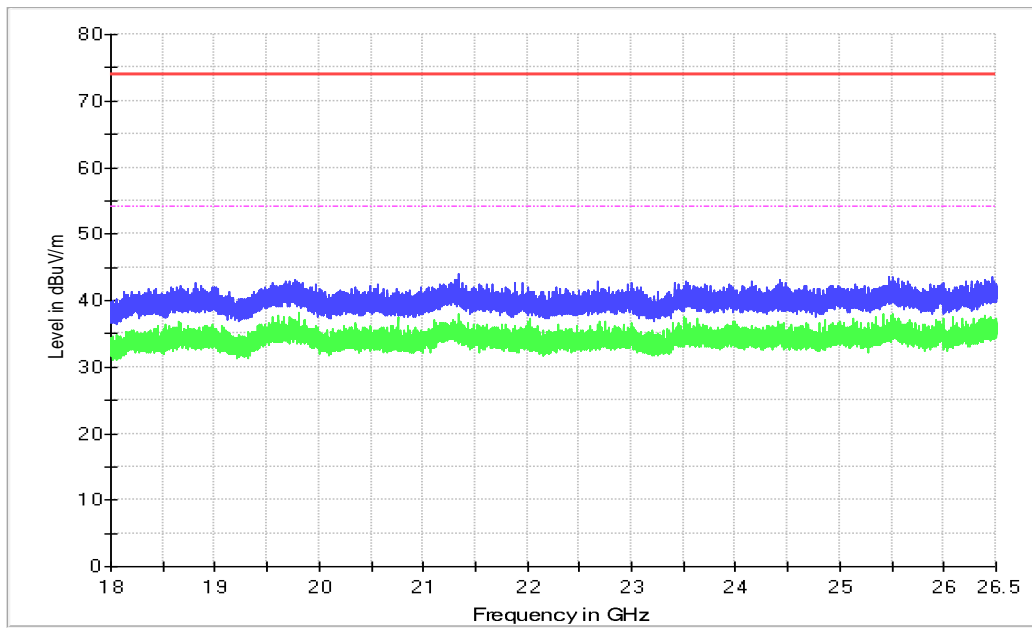
**Ch11**

Frequency (MHz)	Measurement Result (dBμV/m)	Cable Loss (dB)	Antenna Factor (dB/m)	Receiver Reading (dBμV/m)	Limit (dBμV/m)	Margin (dB)	Antenna Pol. (H/V)
17574.50	51.26	-25.70	46.00	31.06	74.00	22.74	H
14134.50	50.08	-29.00	42.00	37.08	74.00	23.92	V
12858.00	48.05	-30.70	39.10	39.55	74.00	25.95	H
9926.00	45.99	-33.50	38.10	41.39	74.00	28.01	V
7316.50	45.38	-35.10	36.60	43.88	74.00	28.62	H
2485.30	58.86	-20.00	28.30	50.56	74.00	15.14	H

Sample calculation: 17574.50MHz

$$\text{Peak ERP(dBm)} = P_{\text{Mea}}(31.06 \text{ dB}\mu\text{V/m}) + \text{Cable Loss}(-25.70) + \text{Antenna Factor}(46.00) = 51.26 \text{ dB}\mu\text{V/m}$$

**WOSRT CASE 18GHz-26.5 GHz**

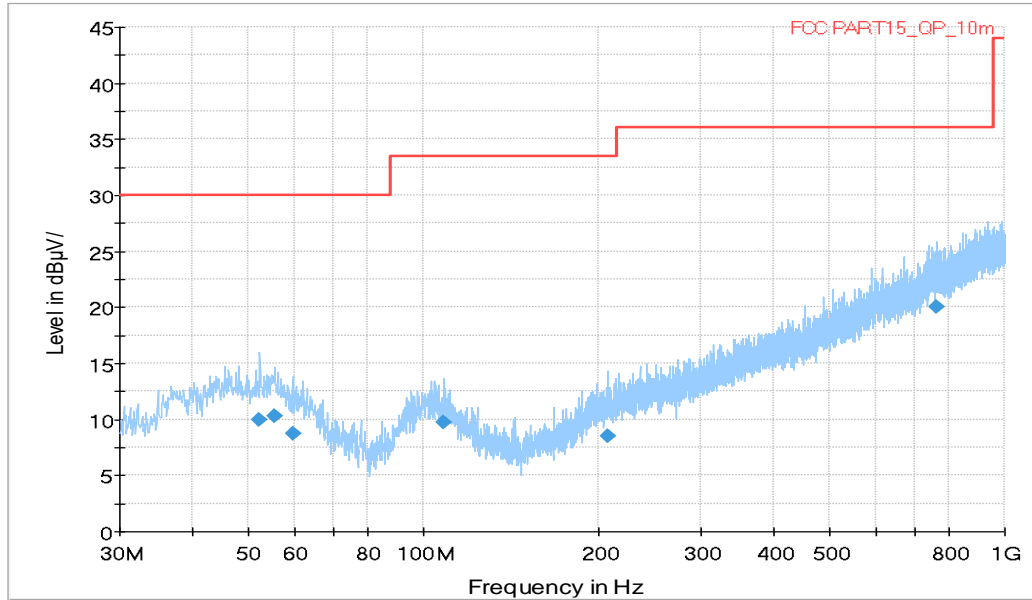




### WOSRT CASE BELOW 1GHz

- FCC Part 15C 30-1G Limit
- Peak Preview Result
- ◆ Final Result QPK

RE FCC\_30MHz-1GHz\_10m\_Direct\_testina\_FP5b



Frequency (MHz)	QuasiPeak (dBuV/m)	Height (cm)	Polarization	Azimuth (deg)	Corr. (dB)	Margin (dB)	Limit (dBuV/m)
52.213000	9.9	125.0	H	93.0	-11.2	20.1	30.0
55.414000	10.3	175.0	V	45.0	-11.3	19.7	30.0
59.585000	8.7	275.0	H	-10.0	-11.9	21.3	30.0
108.279000	9.7	100.0	V	225.0	-12.6	23.8	33.5
207.995000	8.5	175.0	H	225.0	-11.5	25.0	33.5
764.678000	20.0	225.0	V	135.0	1.9	16.0	36.0

### BELOW 30MHz

No emissions were found within 20dB of the limit below 30MHz.

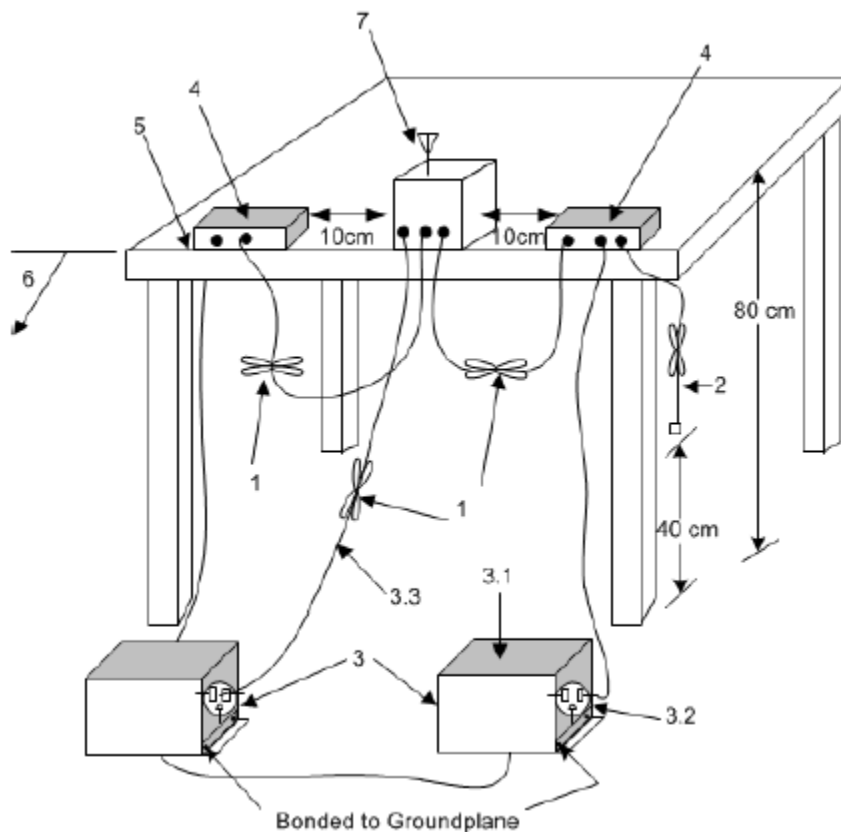
## A.7. AC Power-line Conducted Emission

**Method of Measurement:** See ANSI C63.10-clause 6.2

### **Setup:**

A stand-alone EUT shall be placed in the center along the back edge of the tabletop. For multiunit tabletop systems, the EUT shall be centered laterally (left to right facing the tabletop) on the tabletop and its rear shall be flush with the rear of the table.

Accessories that are part of an EUT system tested on a tabletop shall be placed in a test arrangement on one or both sides of the host with a 10 cm separation between the nearest points of the cabinets. The rear of the host and accessories shall be flush with the back of the supporting tabletop unless that would not be typical of normal use. If more than two accessories are present, then an equipment test arrangement shall be chosen that maintains 10 cm spacing between cabinets unless the equipment is normally located closer together.



### **Exploratory ac power-line conducted emission measurements**

Exploratory measurements shall be used to identify the frequency of the emission that has the highest amplitude relative to the limit by operating the EUT in a range of typical modes of operation, cable positions, and with a typical system equipment configuration and arrangement. For each mode of operation and for each ac power current-carrying conductor, cable manipulation shall be performed within the range of likely configurations. For this measurement or series of measurements, the frequency spectrum of interest shall be monitored looking for the emission that has the highest amplitude relative to the limit. Once that emission is found for each current-carrying conductor of each power cord associated with the EUT (but not the cords associated with non-EUT equipment in the overall system), the one configuration and

arrangement and mode of operation that produces the emission closest to the limit over all of the measured conductors shall be recorded.

#### **Final ac power-line conducted emission measurements**

Based on the exploratory tests of the EUT, the one EUT cable configuration and arrangement and mode of operation that produced the emission with the highest amplitude relative to the limit is selected for the final measurement, while applying the appropriate modulating signal to the EUT. If the EUT is relocated from an exploratory test site to a final test site, the highest emissions shall be remaximized at the final test location before final ac power-line conducted emission measurements are performed. The final test on all current-carrying conductors of all of the power cords to the equipment that comprises the EUT (but not the cords associated with other non-EUT equipment in the system) is then performed for the full frequency range for which the EUT is being tested for compliance without further variation of the EUT arrangement, cable positions, or EUT mode of operation. If the EUT is composed of equipment units that have their own separate ac power connections (e.g., floor-standing equipment with independent power cords for each shelf that are able to connect directly to the ac power network), then each current-carrying conductor of one unit is measured while the other units are connected to a second (or more) LISN(s). All units shall be measured separately. If a power strip is provided by the manufacturer, to supply all of the units making up the EUT, only the conductors in the power cord of the power strip shall be measured.

#### **Test Condition:**

<b>Voltage (V)</b>	<b>Frequency (Hz)</b>
120	60

**Conclusion: Pass**

**EUT ID: UT22a + AE2-1 + AE1-3**

## WLAN (Quasi-peak Limit)

Frequency range (MHz)	Quasi-peak Limit (dB $\mu$ V)	Result (dB $\mu$ V)		Conclusion
		With charger		
		802.11b	Idle	
0.15 to 0.5	66 to 56	Fig.A.7.1	Fig.A.7.2	<b>P</b>
0.5 to 5	56			
5 to 30	60			

NOTE: The limit decreases linearly with the logarithm of the frequency in the range 0.15 MHz to 0.5 MHz.

## WLAN (Average Limit)

Frequency range (MHz)	Average Limit (dB $\mu$ V)	Result (dB $\mu$ V)		Conclusion
		With charger		
		802.11b	Idle	
0.15 to 0.5	56 to 46	Fig.A.7.1	Fig.A.7.2	<b>P</b>
0.5 to 5	46			
5 to 30	50			

NOTE: The limit decreases linearly with the logarithm of the frequency in the range 0.15 MHz to 0.5 MHz.

**EUT ID: UT25a + AE2-2 + AE1-3**

## WLAN (Quasi-peak Limit)

Frequency range (MHz)	Quasi-peak Limit (dB $\mu$ V)	Result (dB $\mu$ V)		Conclusion
		With charger		
		802.11b	Idle	
0.15 to 0.5	67 to 56	Fig.A.7.3	/	<b>P</b>
0.5 to 5	56			
5 to 30	60			

NOTE: The limit decreases linearly with the logarithm of the frequency in the range 0.15 MHz to 0.5 MHz.

## WLAN (Average Limit)

Frequency range (MHz)	Average Limit (dB $\mu$ V)	Result (dB $\mu$ V)		Conclusion
		With charger		
		802.11b	Idle	
0.15 to 0.5	56 to 46	Fig.A.7.3	/	<b>P</b>
0.5 to 5	46			
5 to 30	50			

NOTE: The limit decreases linearly with the logarithm of the frequency in the range 0.15 MHz to 0.5 MHz.

**EUT ID: UT26a + AE2-3 + AE1-3**

## WLAN (Quasi-peak Limit)

Frequency range (MHz)	Quasi-peak Limit (dB $\mu$ V)	Result (dB $\mu$ V)		Conclusion
		With charger		
		802.11b	Idle	
0.15 to 0.5	68 to 56	Fig.A.7.4	/	<b>P</b>
0.5 to 5	56			
5 to 30	60			

NOTE: The limit decreases linearly with the logarithm of the frequency in the range 0.15 MHz to 0.5 MHz.

## WLAN (Average Limit)

Frequency range (MHz)	Average Limit (dB $\mu$ V)	Result (dB $\mu$ V)		Conclusion
		With charger		
		802.11b	Idle	
0.15 to 0.5	56 to 46	Fig.A.7.4	/	<b>P</b>
0.5 to 5	46			
5 to 30	50			

NOTE: The limit decreases linearly with the logarithm of the frequency in the range 0.15 MHz to 0.5 MHz.

**EUT ID: UT22a + AE2-4 + AE1-3**

## WLAN (Quasi-peak Limit)

Frequency range (MHz)	Quasi-peak Limit (dB $\mu$ V)	Result (dB $\mu$ V)		Conclusion
		With charger		
		802.11b	Idle	
0.15 to 0.5	69 to 56	Fig.A.7.5	/	<b>P</b>
0.5 to 5	56			
5 to 30	60			

NOTE: The limit decreases linearly with the logarithm of the frequency in the range 0.15 MHz to 0.5 MHz.

## WLAN (Average Limit)

Frequency range (MHz)	Average Limit (dB $\mu$ V)	Result (dB $\mu$ V)		Conclusion
		With charger		
		802.11b	Idle	
0.15 to 0.5	56 to 46	Fig.A.7.5	/	<b>P</b>
0.5 to 5	46			
5 to 30	50			

NOTE: The limit decreases linearly with the logarithm of the frequency in the range 0.15 MHz to 0.5 MHz.



EUT ID: UT25a + AE2-5 + AE1-3

WLAN (Quasi-peak Limit)

Frequency range (MHz)	Quasi-peak Limit (dB $\mu$ V)	Result (dB $\mu$ V)		Conclusion
		With charger		
		802.11b	Idle	
0.15 to 0.5	70 to 56	Fig.A.7.6	/	P
0.5 to 5	56			
5 to 30	60			

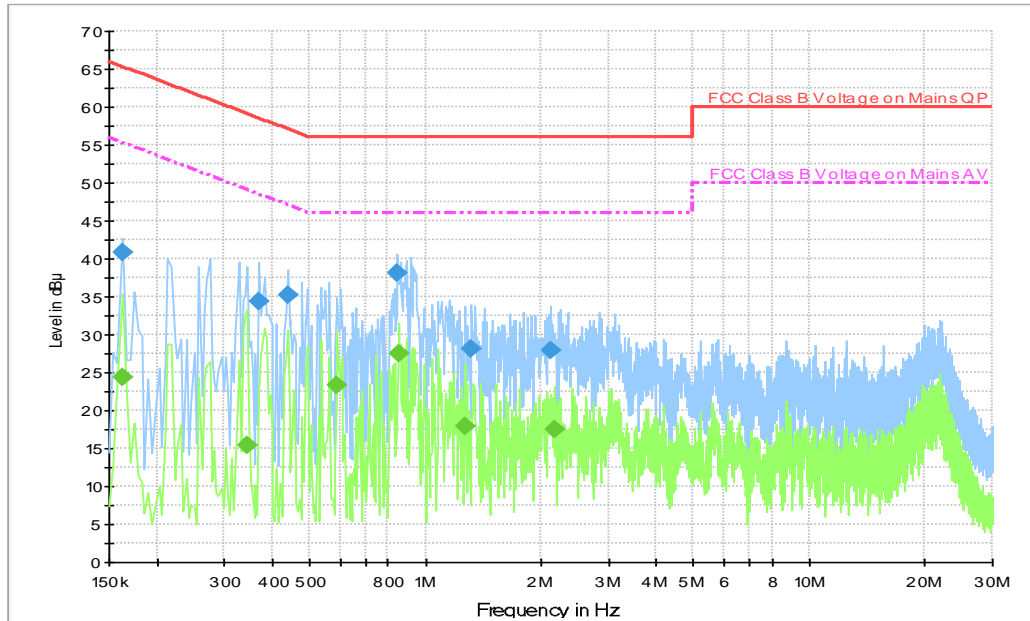
NOTE: The limit decreases linearly with the logarithm of the frequency in the range 0.15 MHz to 0.5 MHz.

WLAN (Average Limit)

Frequency range (MHz)	Average Limit (dB $\mu$ V)	Result (dB $\mu$ V)		Conclusion
		With charger		
		802.11b	Idle	
0.15 to 0.5	56 to 46	Fig.A.7.6	/	P
0.5 to 5	46			
5 to 30	50			

NOTE: The limit decreases linearly with the logarithm of the frequency in the range 0.15 MHz to 0.5 MHz.

Test graphs as below:



**Fig.A.7.1 AC Powerline Conducted Emission-802.11b(UT22a + AE2-1 + AE1-3)**

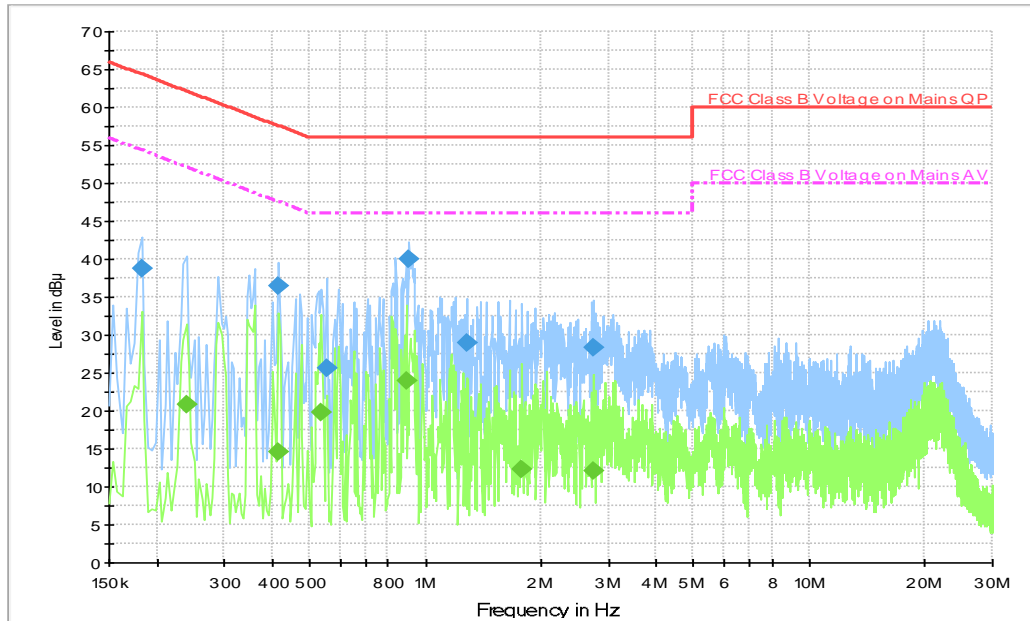
Note: The graphic result above is the maximum of the measurements for both phase line and neutral line.

**Final Result 1**

Frequency (MHz)	QuasiPeak (dBµV)	Meas. Time (ms)	Bandwidth (kHz)	Filter	Line	Corr. (dB)	Margin (dB)	Limit (dBµV)
0.162000	40.8	1000.0	9.000	On	L1	19.8	24.6	65.4
0.370000	34.3	1000.0	9.000	On	L1	19.7	24.2	58.5
0.438000	35.3	1000.0	9.000	On	L1	19.7	21.8	57.1
0.846000	38.1	1000.0	9.000	On	N	19.6	17.9	56.0
1.322000	28.2	1000.0	9.000	On	L1	19.6	27.8	56.0
2.126000	27.9	1000.0	9.000	On	L1	19.6	28.1	56.0

**Final Result 2**

Frequency (MHz)	CAverage (dBµV)	Meas. Time (ms)	Bandwidth (kHz)	Filter	Line	Corr. (dB)	Margin (dB)	Limit (dBµV)
0.162000	24.4	1000.0	9.000	On	N	19.7	30.9	55.4
0.342000	15.3	1000.0	9.000	On	N	19.7	33.8	49.2
0.590000	23.4	1000.0	9.000	On	N	19.6	22.6	46.0
0.854000	27.5	1000.0	9.000	On	N	19.6	18.5	46.0
1.270000	17.9	1000.0	9.000	On	N	19.6	28.1	46.0
2.178000	17.5	1000.0	9.000	On	N	19.6	28.5	46.0



**Fig.A.7.2 AC Powerline Conducted Emission-Idle(UT22a + AE2-1 + AE1-3)**

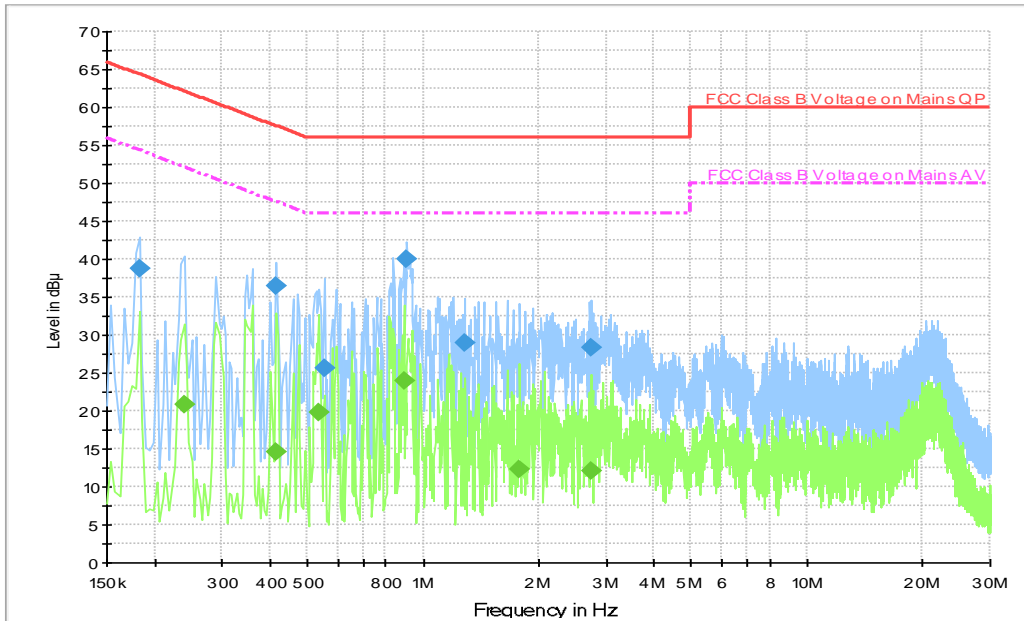
Note: The graphic result above is the maximum of the measurements for both phase line and neutral line.

**Final Result 1**

Frequency (MHz)	QuasiPeak (dBμV)	Meas. Time (ms)	Bandwidth (kHz)	Filter	Line	Corr. (dB)	Margin (dB)	Limit (dBμV)
0.182000	38.7	1000.0	9.000	On	L1	19.7	25.7	64.4
0.414000	36.5	1000.0	9.000	On	L1	19.7	21.0	57.6
0.554000	25.7	1000.0	9.000	On	L1	19.7	30.3	56.0
0.910000	40.0	1000.0	9.000	On	N	19.6	16.0	56.0
1.282000	28.9	1000.0	9.000	On	L1	19.7	27.1	56.0
2.750000	28.3	1000.0	9.000	On	L1	19.6	27.7	56.0

**Final Result 2**

Frequency (MHz)	CAverage (dBμV)	Meas. Time (ms)	Bandwidth (kHz)	Filter	Line	Corr. (dB)	Margin (dB)	Limit (dBμV)
0.238000	20.8	1000.0	9.000	On	N	19.7	31.3	52.2
0.414000	14.5	1000.0	9.000	On	L1	19.7	33.0	47.6
0.534000	19.7	1000.0	9.000	On	N	19.7	26.3	46.0
0.890000	24.0	1000.0	9.000	On	N	19.6	22.0	46.0
1.790000	12.2	1000.0	9.000	On	L1	19.6	33.8	46.0
2.750000	12.1	1000.0	9.000	On	L1	19.6	33.9	46.0



**Fig.A.7.3 AC Powerline Conducted Emission-802.11b (UT25a + AE2-2 + AE1-3)**

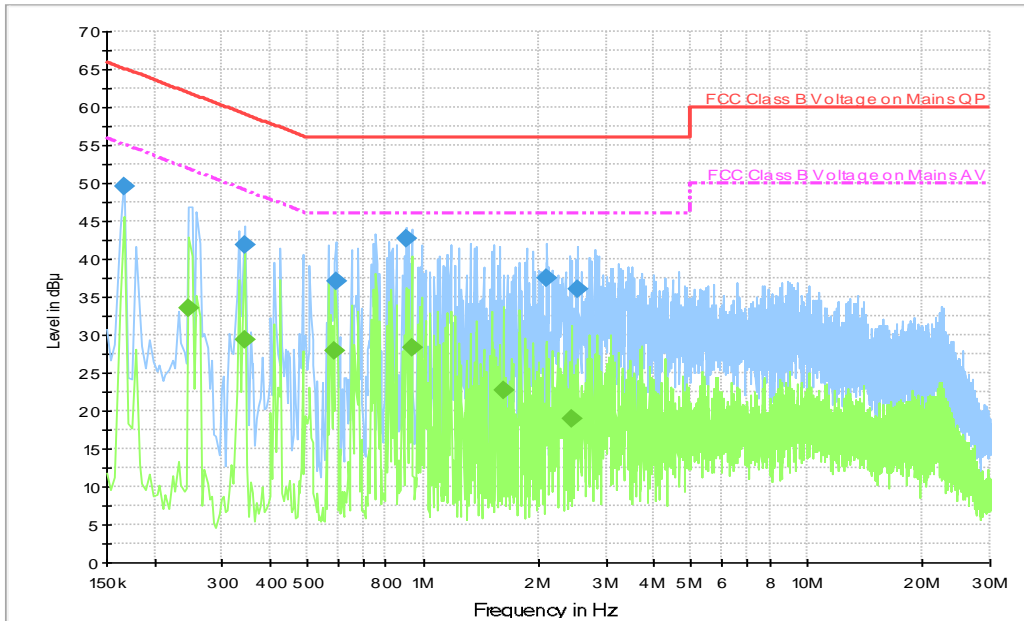
Note: The graphic result above is the maximum of the measurements for both phase line and neutral line.

**Final Result 1**

Frequency (MHz)	QuasiPeak (dBμV)	Meas. Time (ms)	Bandwidth (kHz)	Filter	Line	Corr. (dB)	Margin (dB)	Limit (dBμV)
0.398000	39.1	1000.0	9.000	On	L1	19.7	18.8	57.9
0.590000	35.9	1000.0	9.000	On	L1	19.7	20.1	56.0
0.850000	44.7	1000.0	9.000	On	N	19.6	11.3	56.0
1.814000	34.0	1000.0	9.000	On	L1	19.6	22.0	56.0
2.238000	32.9	1000.0	9.000	On	L1	19.6	23.1	56.0
3.802000	28.0	1000.0	9.000	On	N	19.6	28.0	56.0

**Final Result 2**

Frequency (MHz)	CAverage (dBμV)	Meas. Time (ms)	Bandwidth (kHz)	Filter	Line	Corr. (dB)	Margin (dB)	Limit (dBμV)
0.202000	24.3	1000.0	9.000	On	N	19.7	29.2	53.5
0.394000	31.1	1000.0	9.000	On	N	19.7	16.8	48.0
0.654000	27.8	1000.0	9.000	On	N	19.6	18.2	46.0
0.866000	30.2	1000.0	9.000	On	N	19.6	15.8	46.0
1.294000	22.9	1000.0	9.000	On	N	19.6	23.1	46.0
2.674000	14.3	1000.0	9.000	On	L1	19.6	31.7	46.0



**Fig.A.7.4 AC Powerline Conducted Emission-802.11b(UT26a + AE2-3 + AE1-3)**

Note: The graphic result above is the maximum of the measurements for both phase line and neutral line.

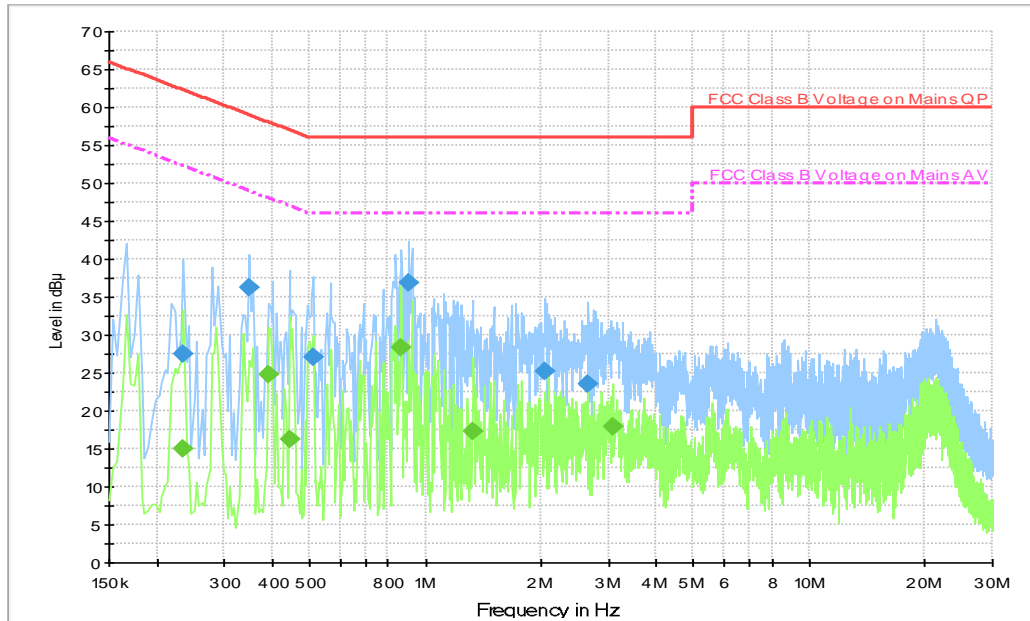
**Final Result 1**

Frequency (MHz)	QuasiPeak (dBμV)	Meas. Time (ms)	Bandwidth (kHz)	Filter	Line	Corr. (dB)	Margin (dB)	Limit (dBμV)
0.166000	49.7	1000.0	9.000	On	L1	19.8	15.5	65.2
0.342000	42.0	1000.0	9.000	On	N	19.7	17.2	59.2
0.594000	37.1	1000.0	9.000	On	L1	19.7	18.9	56.0
0.906000	42.6	1000.0	9.000	On	N	19.6	13.4	56.0
2.106000	37.6	1000.0	9.000	On	L1	19.6	18.4	56.0
2.518000	36.0	1000.0	9.000	On	L1	19.6	20.0	56.0

**Final Result 2**

Frequency (MHz)	CAverage (dBμV)	Meas. Time (ms)	Bandwidth (kHz)	Filter	Line	Corr. (dB)	Margin (dB)	Limit (dBμV)
0.246000	33.5	1000.0	9.000	On	N	19.7	18.4	51.9
0.342000	29.4	1000.0	9.000	On	N	19.7	19.7	49.2
0.590000	27.9	1000.0	9.000	On	N	19.6	18.1	46.0
0.934000	28.3	1000.0	9.000	On	N	19.6	17.7	46.0
1.614000	22.7	1000.0	9.000	On	N	19.6	23.3	46.0
2.442000	19.0	1000.0	9.000	On	N	19.6	27.0	46.0





**Fig.A.7.5 AC Powerline Conducted Emission-802.11b(UT22a + AE2-4 + AE1-3)**

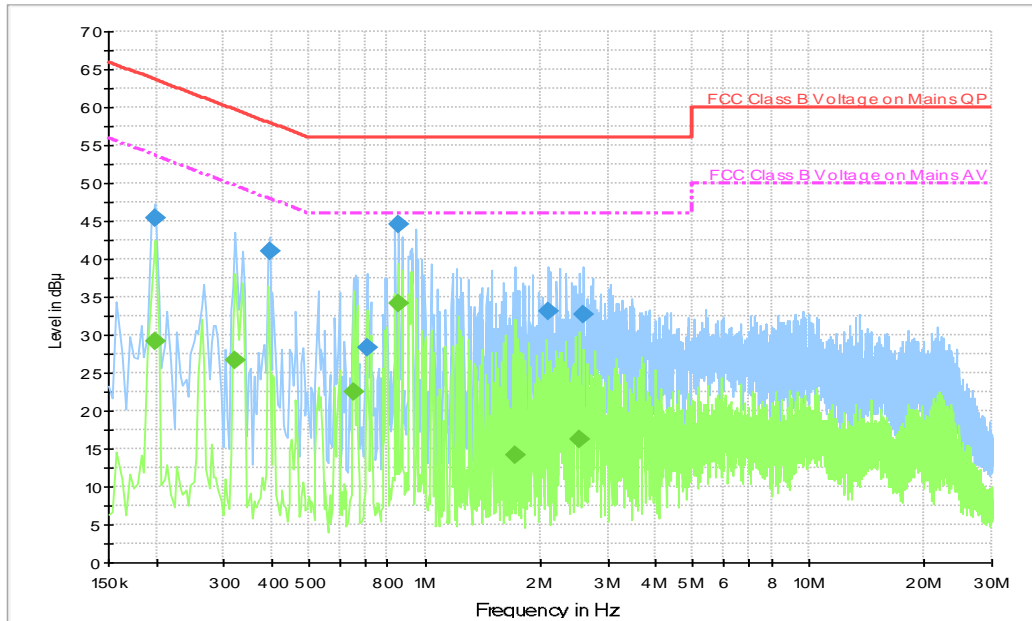
Note: The graphic result above is the maximum of the measurements for both phase line and neutral line.

**Final Result 1**

Frequency (MHz)	QuasiPeak (dBμV)	Meas. Time (ms)	Bandwidth (kHz)	Filter	Line	Corr. (dB)	Margin (dB)	Limit (dBμV)
0.234000	27.5	1000.0	9.000	On	N	19.7	34.8	62.3
0.346000	36.2	1000.0	9.000	On	L1	19.7	22.8	59.1
0.510000	27.0	1000.0	9.000	On	L1	19.7	29.0	56.0
0.906000	36.9	1000.0	9.000	On	N	19.6	19.1	56.0
2.054000	25.1	1000.0	9.000	On	L1	19.6	30.9	56.0
2.662000	23.6	1000.0	9.000	On	L1	19.6	32.4	56.0

**Final Result 2**

Frequency (MHz)	CAverage (dBμV)	Meas. Time (ms)	Bandwidth (kHz)	Filter	Line	Corr. (dB)	Margin (dB)	Limit (dBμV)
0.234000	15.0	1000.0	9.000	On	N	19.7	37.3	52.3
0.390000	24.7	1000.0	9.000	On	N	19.7	23.4	48.1
0.442000	16.3	1000.0	9.000	On	L1	19.7	30.7	47.0
0.866000	28.3	1000.0	9.000	On	N	19.6	17.7	46.0
1.334000	17.2	1000.0	9.000	On	N	19.6	28.8	46.0
3.090000	18.0	1000.0	9.000	On	N	19.6	28.0	46.0



**Fig.A.7.6 AC Powerline Conducted Emission-802.11b (UT25a + AE2-5 + AE1-3)**

Note: The graphic result above is the maximum of the measurements for both phase line and neutral line.

**Final Result 1**

Frequency (MHz)	QuasiPeak (dBµV)	Meas. Time (ms)	Bandwidth (kHz)	Filter	Line	Corr. (dB)	Margin (dB)	Limit (dBµV)
0.198000	45.5	1000.0	9.000	On	L1	19.7	18.2	63.7
0.394000	41.1	1000.0	9.000	On	L1	19.7	16.9	58.0
0.706000	28.2	1000.0	9.000	On	N	19.7	27.8	56.0
0.854000	44.6	1000.0	9.000	On	N	19.6	11.4	56.0
2.098000	33.2	1000.0	9.000	On	L1	19.6	22.8	56.0
2.582000	32.6	1000.0	9.000	On	L1	19.6	23.4	56.0

**Final Result 2**

Frequency (MHz)	CAverage (dBµV)	Meas. Time (ms)	Bandwidth (kHz)	Filter	Line	Corr. (dB)	Margin (dB)	Limit (dBµV)
0.198000	29.1	1000.0	9.000	On	L1	19.7	24.6	53.7
0.322000	26.6	1000.0	9.000	On	L1	19.7	23.0	49.7
0.650000	22.5	1000.0	9.000	On	N	19.6	23.5	46.0
0.854000	34.1	1000.0	9.000	On	N	19.6	11.9	46.0
1.714000	14.3	1000.0	9.000	On	L1	19.6	31.7	46.0
2.534000	16.3	1000.0	9.000	On	L1	19.6	29.7	46.0

## ANNEX B: EUT parameters

Disclaimer: The worse case and antenna gain provided by the client may affect the validity of the measurement results in this report, and the client shall bear the impact and consequences arising therefrom.

## ANNEX C: Accreditation Certificate



\*\*\*END OF REPORT\*\*\*