

# TEST REPORT

---

Report No.: SRTC2022-9003(F)-0092  
Model Name: PGT-N19  
Applicant: Honor Device Co., Ltd.  
Manufacturer: Honor Device Co., Ltd.  
Specification: FCC Part15B (Certification)  
(2022 edition)  
ANSI C63.4-2014  
FCC ID: 2AYGCPGT-N19

The State Radio\_monitoring\_center Testing Center (SRTC)  
15th Building, No.30 Shixing Street, Shijingshan District,  
Beijing, China

Tel: 86-10-57996183 Fax: 86-10-57996388

## CONTENTS

1. General information.....	3
1.1 Notes of the test report.....	3
1.2 Information about the testing laboratory.....	3
1.3 Applicant's details.....	3
1.4 Manufacturer's details.....	3
1.5 Application details.....	3
1.6 Reference specification.....	3
1.7 Information of EUT.....	4
1.7.1 General information.....	4
1.7.2 EUT details.....	5
1.7.3 Auxiliary equipment details.....	5
1.7.4 Test mode.....	6
2. Test information.....	7
2.1 Summary of the test results.....	7
2.2 Test result.....	8
2.2.1 Conducted Emissions-FCC Part15.107.....	8
2.2.2 Radiated Emissions-FCC Part15.109.....	14
2.3. List of test equipments.....	23

## 1. General information

### 1.1 Notes of the test report

The test report may only be reproduced or published in full. Reproduction or publication of extracts from the report requires the prior written permission of The State Radio\_monitoring\_center Testing Center (SRTC).

The test results relate only to individual items of the samples which have been tested.

### 1.2 Information about the testing laboratory

Company: The State Radio\_monitoring\_center Testing Center (SRTC)  
Test Site 1: 15th Building, No.30 Shixing Street, Shijingshan District  
Test Site 2: No.80, Zhaojiachang, Beizang, Daxing District  
City: Beijing  
Country or Region: P.R.China  
Contacted person: Liu Jia  
Tel: +86 10 57996183  
Fax: +86 10 57996388  
Email: liujiat@srtc.org.cn  
Designation Number: CN1267  
Registration number: 239125

### 1.3 Applicant's details

Company: Honor Device Co., Ltd.  
Address: Shum Yip Sky Park, No. 8089, Hongli West Road, Shenzhen, China

### 1.4 Manufacturer's details

Company: Honor Device Co., Ltd.  
Address: Shum Yip Sky Park, No. 8089, Hongli West Road, Shenzhen, China

### 1.5 Application details

Date of reception of test sample: 22<sup>th</sup> December 2022

Date of test: 22<sup>th</sup> December to 13<sup>th</sup> January 2023

### 1.6 Reference specification

FCC Part 15B, 2022 (Certification)

## 1.7 Information of EUT

### 1.7.1 General information

Model Name of EUT	PGT-N19
FCC ID	2AYGCPGT-N19
Frequency Range	GSM: GSM850 / DCS1900 WCDMA: FDD II/ FDD IV / FDD V LTE: FDD 2/ FDD 4/ FDD 5/FDD 7/ FDD 12/ FDD 13/ FDD 17/ FDD 25/ FDD 26 / FDD 66/TDD 38/TDD 41 5GNR: N2/N5/N7/N38/N41/N66/N78 Bluetooth: 2.4~2.4835GHz WiFi: 2.4~2.4835GHz 5.15-5.25GHz 5.25-5.35GHz 5.47-5.725GHz 5.725GHz-5.85GHz NFC: 13.56MHz WPT: 110kHz-140kHz
Nominal Voltage	3.91V
Power Supply	Charger/Battery
Extreme Voltage	Minimum: 3.6V Maximum: 4.4V
HW Version	HN2PGETM
SW Version	7.1.0.107(C900E100R1P2)

### 1.7.2 EUT details

No.	Model Name	IMEI
EUT1	PGT-N19	866456060028096

### 1.7.3 Auxiliary equipment details

#### AE (Auxiliary Equipment) 1#:Charger1

Manufacturer	Honor Device Co., Ltd.
Model Number	HN-110600U00
Input Voltage	100V-240V AC
Output Voltage	5Vdc2A OR 10Vdc4A OR 11Vdc6A

#### AE (Auxiliary Equipment) 2#:Charger2

Manufacturer	Honor Device Co., Ltd.
Model Number	HN-110600E00
Input Voltage	100V-240V AC
Output Voltage	5Vdc2A OR 10Vdc4A OR 11Vdc6A

#### AE (Auxiliary Equipment) 3#:Charger3

Manufacturer	Honor Device Co., Ltd.
Model Number	HN-110600B00
Input Voltage	100V-240V AC
Output Voltage	5Vdc2A OR 10Vdc4A OR 11Vdc6A

#### AE (Auxiliary Equipment) 4#: Battery1

Manufacturer	Honor Device Co., Ltd.
Model Number	HB536880EHW

#### AE (Auxiliary Equipment) 5#: USB cable1

Manufacturer	GUANGDONG MINGJI HI-TECH ELECTRONICS CO., LTD.
Model Number	213-00060-0

#### AE (Auxiliary Equipment) 6#: USB cable2

Manufacturer	ASAP TECHNOLOGY (JIANGXI) CO LTD
Model Number	L99UC139 - CS - H

Note: As the information described, the relevant tests have been performed in order to verify in which mode would have the worst features ,so all the tests shown in this test report are performed when the EUT exercised by the charger AE1, the Battery AE4 and the USB cable AE5.

#### 1.7.4 Test mode



Mode No.	Description of test mode
Mode 1	Rear camera on + GNSS RX + GSM/WCDMA/LTE/5GNR/BT/WLAN receiver
Mode 2	Front camera on + GNSS RX + GSM/WCDMA/LTE/5GNR/BT/WLAN receiver
Mode 3	USB copy(EUT with PC)
Mode 4	Mp4 + GNSS RX + GSM/WCDMA/LTE/5GNR/BT/WLAN receiver
Mode 5	Mp3 + GNSS RX + GSM/WCDMA/LTE/5GNR/BT/WLAN receiver

Note: As the information described, the relevant tests have been performed in order to verify in which mode would have the worst features ,so all the tests shown in this test report are performed when the EUT working on Mode 1 and Mode 3.

## 2. Test information

### 2.1 Summary of the test results

No.	Test case	FCC reference	Verdict
1	Conducted emissions	15.107	Pass
2	Radiated emissions	15.109	Pass

Approved By: Mr. Guo Yu Vice director of the test department 	Checked By: Mr. Liu Jian 
Tested By: Mr. Lv Youyou 	Issued date: 2023.01.13

## 2.2 Test result

### 2.2.1 Conducted Emissions-FCC Part15.107

Ambient condition:

Temperature	Relative humidity	Pressure
24.1°C	37.2%	100.9kPa

Test Setup with charger:

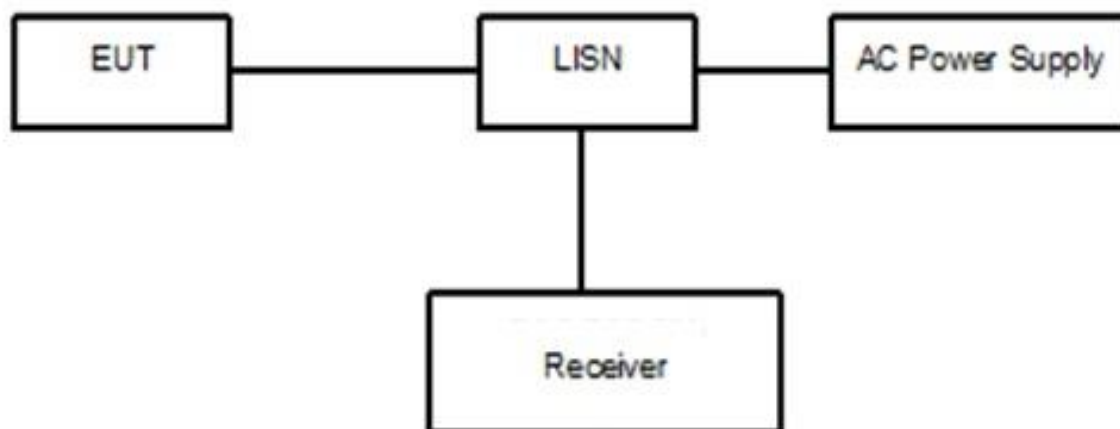

Figure 1

Test Procedure:

The EUT is placed on a non-metallic table 0.8m above the horizontal metal reference ground plane. The EUT is connected with LISN via the charger. The LISN is connected to the reference ground. The accessories of the EUT are connected with the EUT such as headset etc. Open the following functions of EUT: FM, GPS, Camera and video.

The test set-up and the test methods are performed according to ANSI C63.4:2014.

Then start the test software EMC32. Sweep the whole frequency band through the range from 150 KHz to 30 MHz with RBW 9kHz, VBW 30kHz. The measurement should be done for both L line and N line. During pre-test, the receiver uses both peak detector and average detector. And the final test, the receiver uses both average detector and Quasi-peak detector.

The data of cable loss has been calibrated in full testing frequency range before the testing.



Test Setup with laptop:

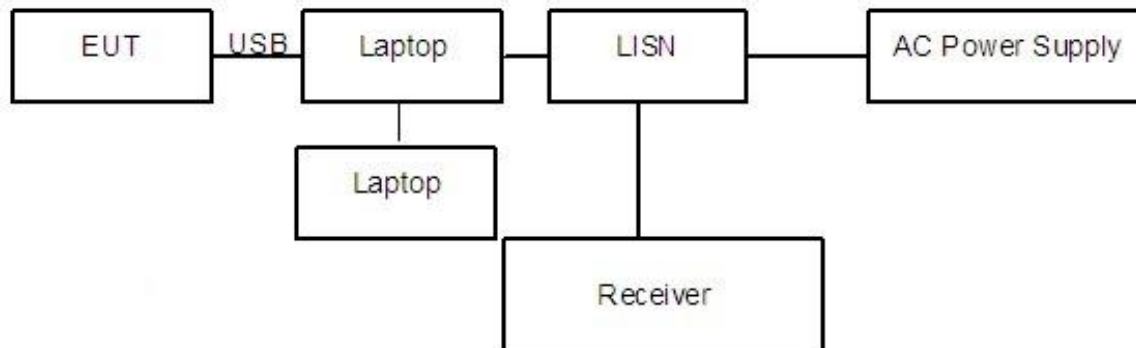

Figure 2

Test Procedure:

The EUT is placed on a non-metallic table 0.8m above the horizontal metal reference ground plane. The accessories of the EUT are connected with the EUT such as headset etc. The EUT was connected with a laptop via the USB cable and transferred the data by copying large files from laptop to the EUT. The laptop's LAN port is connected with another laptop via cable. And the data transferring between two laptops is maintained.

The AC main power supply of the laptop is connected to LISN and LISN is connected to the reference ground. The test set-up and the test methods are performed according to ANSI C63.4:2014.

Then start the test software EMC32. Sweep the whole frequency band through the range from 150 KHz to 30 MHz. The measurement should be done for both L line and N line. During pre-test, the receiver uses both peak detector and average detector. And the final test, the receiver uses both average detector and Quasi-peak detector.

The data of cable loss has been calibrated in full testing frequency range before the testing.

A “reference path loss” Corr.(dB) is established and the  $L_{cable}+ATT+VDF$  is the attenuation of “reference path loss”, and including the cable loss, the attenuation of the attenuator, the voltage division factor of AMN.

The measurement results are obtained as described below:

$$P_{result}=P_{mea}+Corr.(dB)$$

Sample calculation:  $(49.15dB\mu V) = (19.35 dB\mu V) + (29.8 dB)$ , the corresponding frequency is 0.150000MHz.

Limit:

Frequency of Emission(MHz)	Limits(dB $\mu$ V)	
	Quasi-peak	Average
0.15~0.5	66 to 56*	56 to 46*
0.5~5	56	46
5~30	60	50

Note: \* Decreases with the logarithm of the frequency

Uncertainty

Quasi-peak: 3.92dB

Average: 3.92dB

Test result:

### Noise Level of the Measuring Instrument

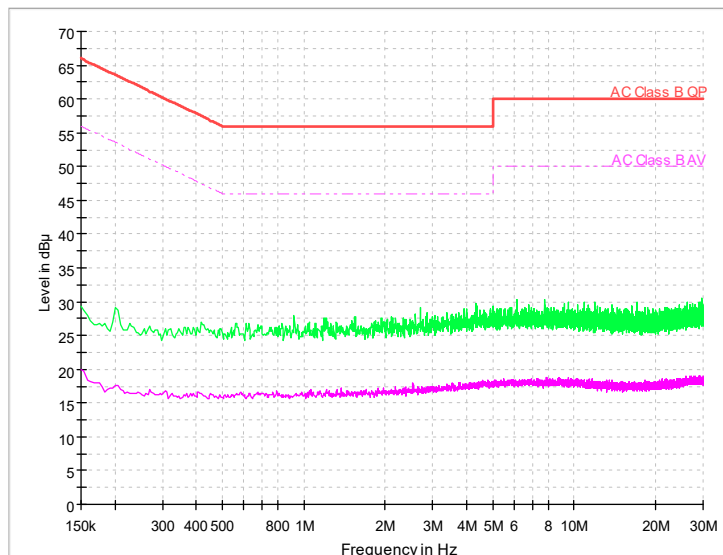

Pic1.Conducted emission L and N Line

EUT1+charger1:

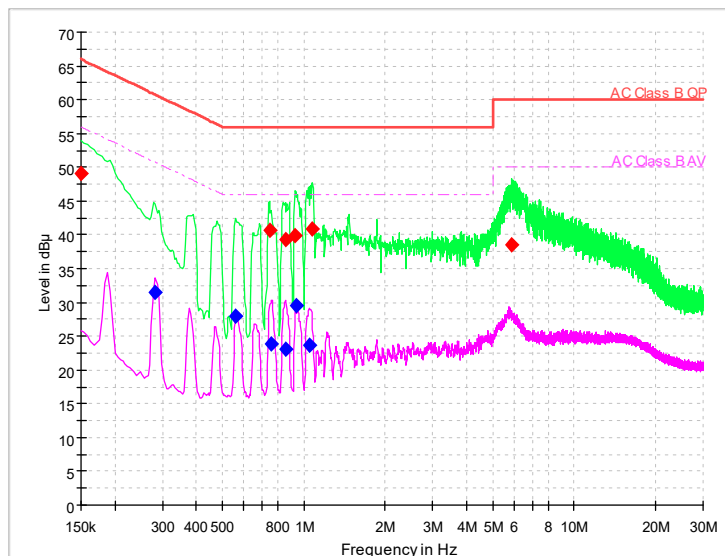

Pic2. Conducted emission L&N Line Voltage: 120VAC

Frequency (MHz)	QuasiPeak (dBµV)	Average (dBµV)	Limit (dBµV)	Margin (dB)	Line	Corr. (dB)	P <sub>mea</sub> QuasiPeak (dBµV)	P <sub>mea</sub> Average (dBµV)
0.150000	49.15	---	66.00	16.85	L1	29.8	19.35	---
0.282193	---	31.54	50.75	19.21	L1	29.8	---	1.74
0.559371	---	28.02	46.00	17.98	L1	29.8	---	-1.78
0.747000	40.67	---	56.00	15.33	L1	29.8	10.87	---
0.759793	---	23.82	46.00	22.18	L1	29.8	---	-5.98
0.853607	39.30	---	56.00	16.70	L1	29.8	9.5	---
0.853607	---	23.11	46.00	22.89	L1	29.8	---	-6.69
0.930364	39.84	---	56.00	16.16	L1	29.8	10.04	---
0.934629	---	29.47	46.00	16.53	L1	29.8	---	-0.33
1.045500	---	23.57	46.00	22.43	L1	29.8	---	-6.23
1.079614	40.91	---	56.00	15.09	L1	29.8	11.11	---
5.859879	38.49	---	60.00	21.51	L1	29.9	8.59	---

EUT1+charger1:

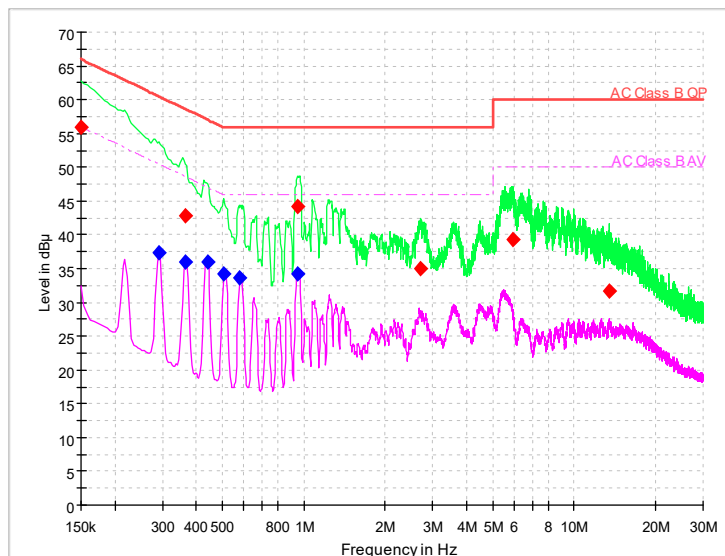

Pic3. Conducted emission L&N Line Voltage: 240VAC

Frequency (MHz)	QuasiPeak (dBµV)	Average (dBµV)	Limit (dBµV)	Margin (dB)	Line	Corr. (dB)	P <sub>mea</sub> QuasiPeak (dBµV)	P <sub>mea</sub> Average (dBµV)
0.150000	55.84	---	66.00	10.16	L1	29.8	26.04	---
0.290721	---	37.34	50.50	13.16	L1	29.8	---	7.54
0.363214	---	35.93	48.66	12.72	L1	29.8	---	6.13
0.363214	42.85	---	58.66	15.80	L1	29.8	13.05	---
0.439971	---	36.03	47.06	11.03	L1	29.8	---	6.23
0.508200	---	34.26	46.00	11.74	L1	29.8	---	4.46
0.580693	---	33.61	46.00	12.39	L1	29.8	---	3.81
0.951686	44.10	---	56.00	11.90	L1	29.8	14.3	---
0.951686	---	34.25	46.00	11.75	L1	29.8	---	4.45
2.712836	34.94	---	56.00	21.06	L1	29.9	5.04	---
5.915314	39.33	---	60.00	20.67	L1	29.9	9.43	---
13.552650	31.75	---	60.00	28.25	L1	30.0	1.75	---

EUT1+Laptop:

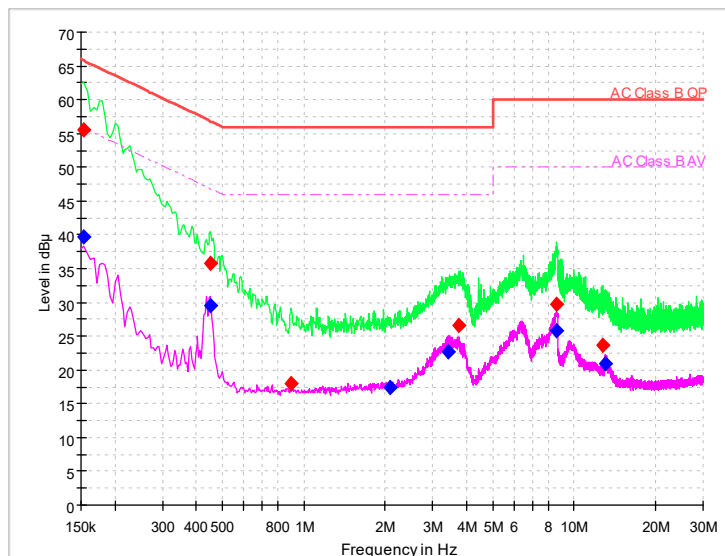

Pic4. Conducted emission L&N Line

Frequency (MHz)	QuasiPeak (dBµV)	Average (dBµV)	Limit (dBµV)	Margin (dB)	Line	Corr. (dB)	Pme a Quas	Pme a Aver
0.154264	---	39.65	55.77	16.12	L1	29.8	---	9.85
0.154264	55.45	---	65.77	10.32	L1	29.8	25.6	---
0.452764	---	29.55	46.82	17.27	L1	29.8	---	-0.25
0.452764	35.84	---	56.82	20.98	L1	29.8	6.04	---
0.900514	18.08	---	56.00	37.92	L1	29.8	-11.7	---
2.081721	---	17.31	46.00	28.69	L1	29.8	---	-12.4
3.420707	---	22.62	46.00	23.38	L1	29.9	---	-7.28
3.723471	26.62	---	56.00	29.38	L1	29.9	-3.28	---
8.593286	29.65	---	60.00	30.35	L1	29.9	-0.25	---
8.648721	---	25.72	50.00	24.28	L1	29.9	---	-4.18
12.716850	23.58	---	60.00	36.42	L1	30.0	-6.42	---
13.057993	---	20.88	50.00	29.12	L1	30.0	---	-9.12

## 2.2.2 Radiated Emissions-FCC Part15.109

Ambient condition:

Temperature	Relative humidity	Pressure
24.1°C	37.2%	100.9kPa

Test Setup:

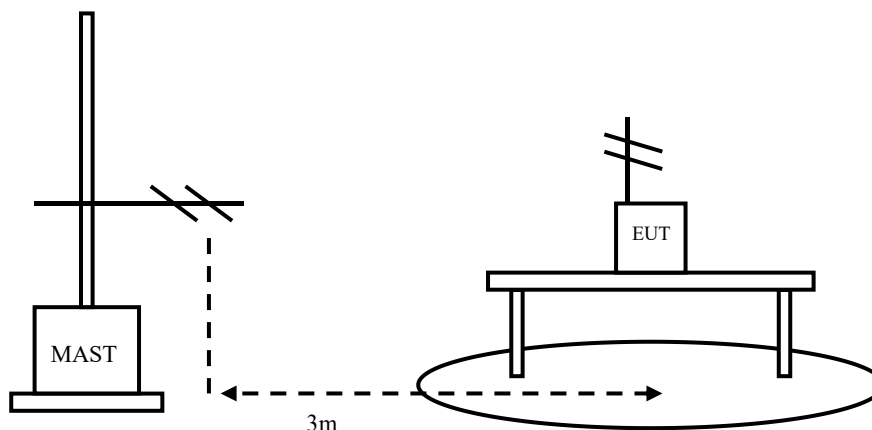

Figure 3

Test Procedure:

EUT+Charger:

The EUT should be placed on a non-metallic table 80cm above the ground plane. The receive antennas shall be moved from 1 to 4 meters. The distance between EUT and receive antenna should be 3 meters.

The accessories of the EUT are connected with the EUT such as headset etc. The EUT should work in idle mode. Open the following functions of EUT: FM, GPS, Camera and video. The test set-up and the test methods are performed according to ANSI C63.4:2014.

Then start the test software EMC32. Sweep the whole frequency band through the range from 30MHz to 1GHz, using receive log period antenna VULB 9163.

During the test, the height of receive antenna shall be moved from 1 to 4 meters, and the antenna shall be performed under horizontal and vertical polarization. The turn table shall be rotated from 0 to 360 degrees for detecting the maximum of radiated spurious signal level. The measurements shall be repeated with orthogonal polarization of the test antenna. The EUT is laid in two modes as follow: 1. put the EUT in horizontal direction; 2. put the EUT in vertical direction.

The data of cable loss and antenna factor have been calibrated in full testing frequency range before the testing. All test results are performed with max hold at the horizontal and vertical polarity.

RBW=120kHz, VBW=300kHz, when the test frequency: 30MHz<f<1GHz

RBW=1MHz, VBW=3MHz, when the test frequency: f>1GHz

### EUT+Laptop:

The EUT should be placed on a non-metallic table 80cm above the ground plane. The receive antennas shall be moved from 1 to 4 meters. The distance between EUT and receive antenna should be 3 meters.

The accessories of the EUT are connected with the EUT such as headset etc. The EUT was connected with a laptop via the USB cable and transferred the data by copying large files from laptop to the EUT. The test set-up and the test methods are performed according to ANSI C63.4:2014

Then start the test software EMC32. Sweep the whole frequency band through the range from 30MHz to 1GHz, using receive log period antenna VULB 9163.

During the test, the height of receive antenna shall be moved from 1 to 4 meters, and the antenna shall be performed under horizontal and vertical polarization. The turn table shall be rotated from 0 to 360 degrees for detecting the maximum of radiated spurious signal level. The measurements shall be repeated with orthogonal polarization of the test antenna. The EUT is laid in two modes as follow: 1. put the EUT in horizontal direction; 2. put the EUT in vertical direction.

The data of cable loss and antenna factor have been calibrated in full testing frequency range before the testing.

A “reference path loss” is established and the  $A_{Rpl}$  is the attenuation of “reference path loss”, and including the gain of receive antenna, the gain of the preamplifier, the cable loss.

The measurement results are obtained as described below:

$$\text{Result} = P_{\text{mea}} + A_{Rpl}$$

Sample calculation:  $(26.91 \text{ dB}\mu\text{V/m}) = (44.51 \text{ dB}\mu\text{V}) + (-17.6 \text{ dB/m})$ , the corresponding frequency is 48.333000MHz.

### Limit:

Frequency of Emission(MHz)	Limits	
	Detector	Unit (dB $\mu$ V/m)
30~88	Quasi-peak	40
88~216	Quasi-peak	43.5
216~960	Quasi-peak	46
960~1000	Quasi-peak	54
1000~5th harmonic of the highest frequency or 40GHz, whichever is lower	Average Peak	54 74

### Uncertainty

30MHz~1000MHz 4.73dB

1000MHz~26000MHz 4.58dB

Test result:

EUT1+charger1:

Frequency (MHz)	Result (dBuV/m)	Limit (dB $\mu$ V/m)	Margin (dB)	ARpl (dB/m)	Pmea (dBuV)	Polarity
48.333000	26.91	40.00	13.09	-17.6	44.51	V
85.435500	24.09	40.00	15.91	-22.7	46.79	V
162.841500	24.57	43.50	18.93	-21.9	46.47	V
193.978500	29.17	43.50	14.33	-19.4	48.57	V
462.911000	20.89	46.00	25.11	-11.8	32.69	V
896.064500	18.88	46.00	27.12	-3.4	22.28	V

EUT1+Laptop:

Frequency (MHz)	Result (dBuV/m)	Limit (dB $\mu$ V/m)	Margin (dB)	ARpl (dB/m)	Pmea (dBuV)	Polarity
50.612500	9.61	40.00	30.39	-17.8	27.41	V
62.737500	6.53	40.00	33.47	-19.6	26.13	V
167.982500	21.42	43.50	22.08	-21.6	43.02	V
215.949000	21.45	43.50	22.05	-18.3	39.75	V
359.994000	33.54	46.00	12.46	-13.5	47.04	V
946.553000	20.65	46.00	25.35	-3.0	23.65	V



EUT1+charger1: refer to Pic5 to Pic8

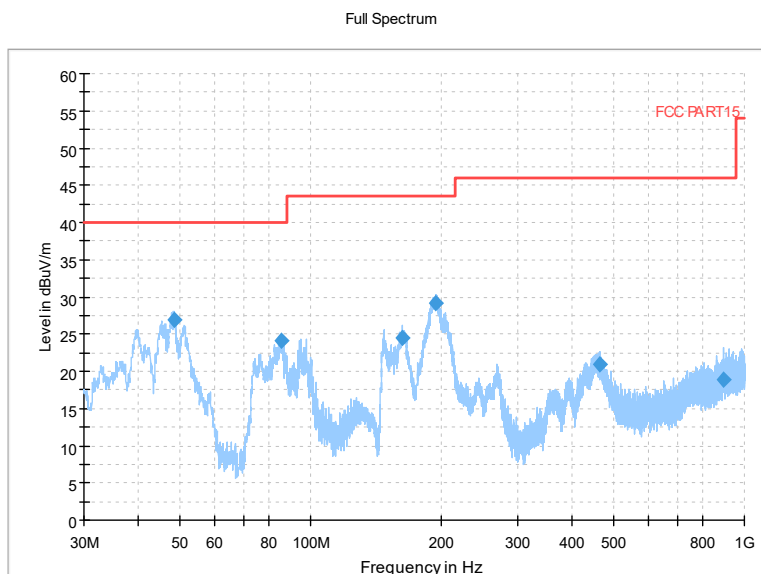

Pic5. Radiated emission (30MHz – 1GHz)

Note: The test data in the graph includes two polarizations: horizontal and vertical

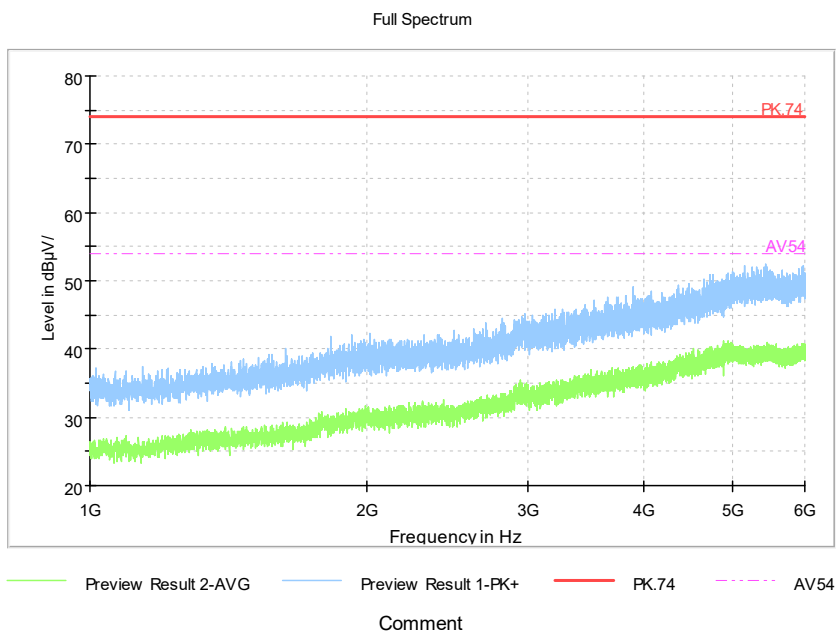

Pic6. Radiated emission (1GHz –6GHz)

Note: The test data in the graph includes two polarizations: horizontal and vertical

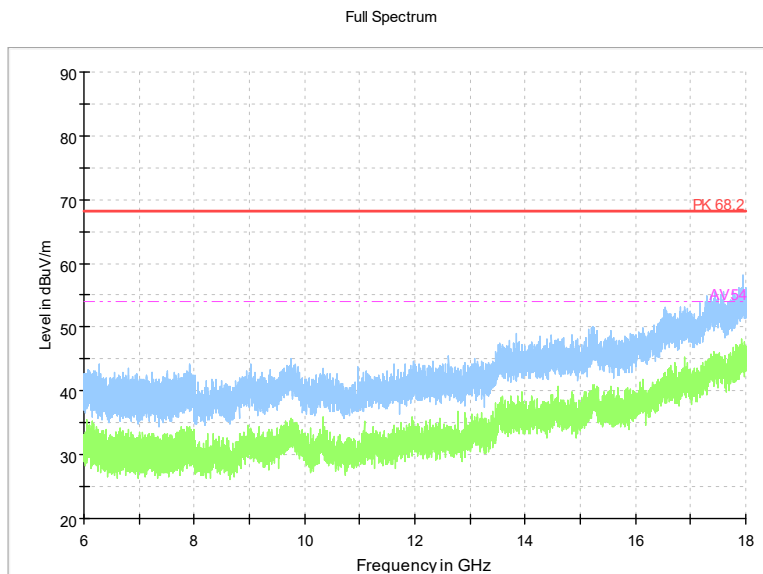

Pic7. Radiated emission (6GHz –18GHz)

Note: The test data in the graph includes two polarizations: horizontal and vertical

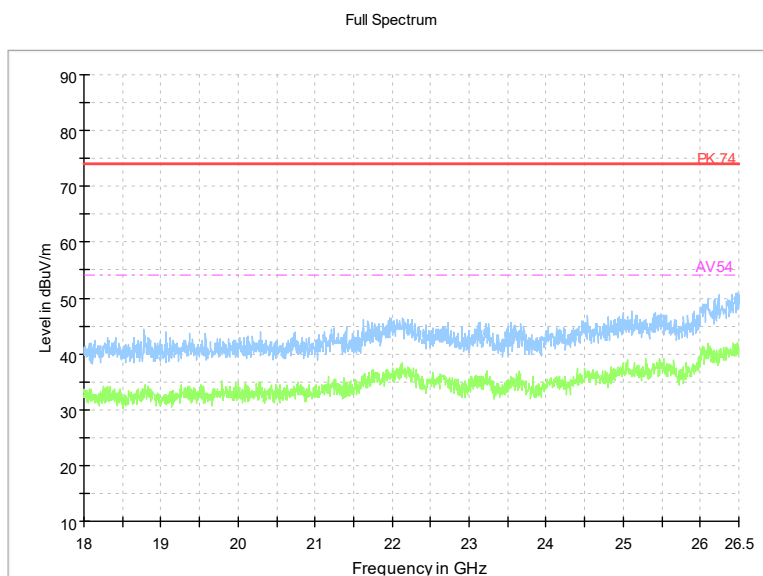

Pic8. Radiated emission (18GHz –26GHz)

Note: The test data in the graph includes two polarizations: horizontal and vertical

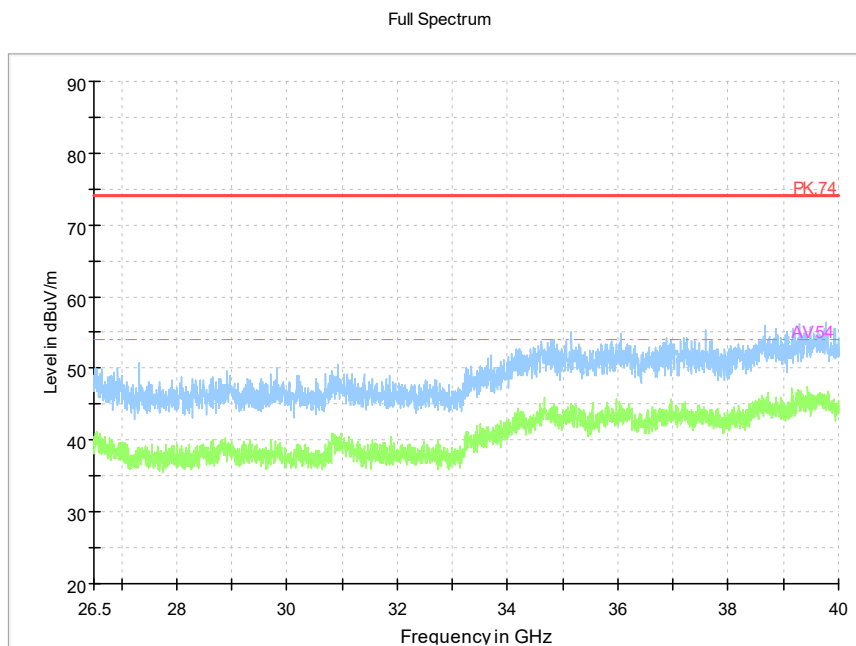

Pic12. Radiated emission (26GHz –40GHz)

Note: The test data in the graph includes two polarizations: horizontal and vertical

EUT1+ Laptop: refer to Pic9 to Pic12

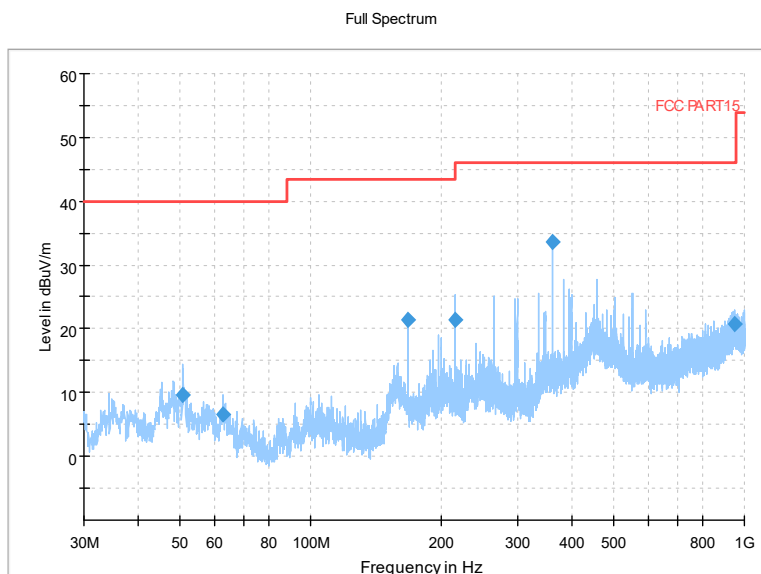

Pic9. Radiated emission (30MHz – 1GHz)

Note: The test data in the graph includes two polarizations: horizontal and vertical

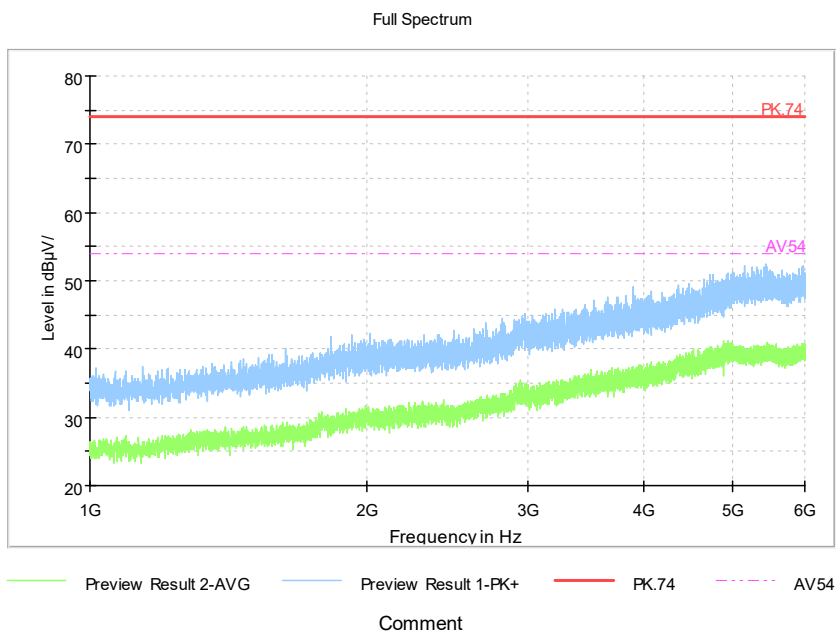

Pic10. Radiated emission (1GHz –6GHz)

Note: The test data in the graph includes two polarizations: horizontal and vertical

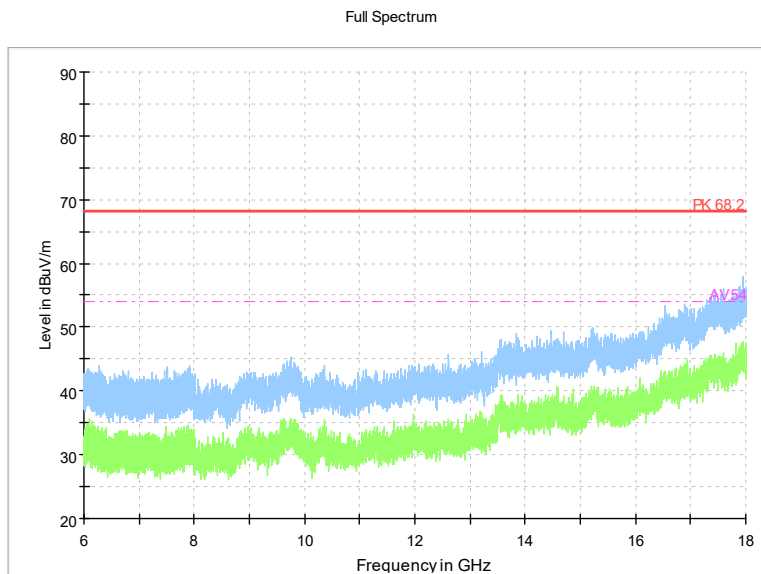

Pic11. Radiated emission (6GHz –18GHz)

Note: The test data in the graph includes two polarizations: horizontal and vertical

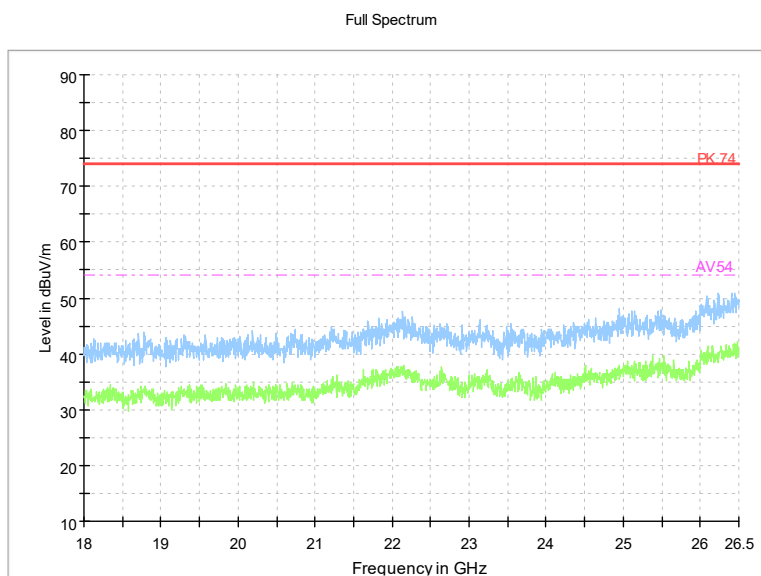

Pic12. Radiated emission (18GHz –26GHz)

Note: The test data in the graph includes two polarizations: horizontal and vertical

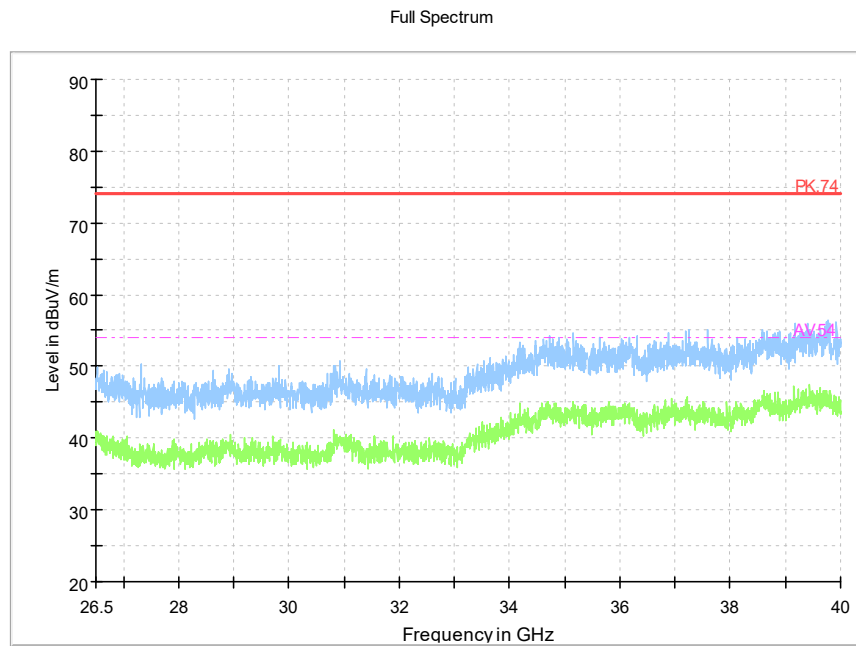

Pic12. Radiated emission (26GHz –40GHz)

Note: The test data in the graph includes two polarizations: horizontal and vertical

### 2.3. List of test equipments

No.	Name/Model	Manufacturer	S/N	Calibration Due Date	Calibration Date
1	23.18m×16.88m×9.60m Semi-Anechoic Chamber	FRANKONIA	-----	2023.11.15	2018.11.16
2	ESW EMI test receiver	R&S	101574	2023.06.19	2022.06.20
3	ESR3 EMI test receiver	R&S	102361	2023.04.11	2022.04.12
4	9.080m×5.255m×3.525m Shielding room	FRANKONIA	-----	2023.09.05	2018.09.06
5	VULB 9163 Ultra log test antenna	schwarzbeck	867	2023.05.28	2021.05.29
6	HF 907 Double-Ridged Waveguide Horn Antenna	R&S	100512	2023.05.12	2021.05.13
7	SAS-574 Horn Antenna	schwarzbeck	535	2023.06.19	2021.06.20
8	ENV216 AMN	R&S	3560.6550. 12	2023.06.19	2022.06.20
9	EMC32EMI test software	R&S	-----	-----	-----

-----The end-----