



SAR TEST REPORT

No. I20Z61402-SEM01

For

Honor Device Co., Ltd.

Smart Watch

Model Name: MUS-B19

with

Hardware Version: Au68g

Software Version: 5.0.80.99

FCC ID: 2AYGCMUS-B19

Issued Date: 2021-9-23

Note:

The test results in this test report relate only to the devices specified in this report. This report shall not be reproduced except in full without the written approval of CTTL.

The report must not be used by the client to claim product certification, approval, or endorsement by NVLAP, NIST, or any agency of the U.S. Government.

Test Laboratory:

CTTL, Telecommunication Technology Labs, CAICT

No. 51, Xueyuan Road, Haidian District, Beijing, P. R. China 100191.

Tel:+86(0)10-62304633-2512, Fax:+86(0)10-62304633-2504

Email: ctl_terminals@caict.ac.cn, website: www.caict.ac.cn



No.I21Z61402-SEM01

REPORT HISTORY

| Report Number | Revision | Issue Date | Description |
|----------------------|-----------------|-------------------|---------------------------------|
| I21Z61402-SEM01 | Rev.0 | 2021-9-23 | Initial creation of test report |



TABLE OF CONTENT

| | |
|--|-----------|
| 1 TEST LABORATORY | 5 |
| 1.1 TESTING LOCATION | 5 |
| 1.2 TESTING ENVIRONMENT..... | 5 |
| 1.3 PROJECT DATA | 5 |
| 1.4 SIGNATURE..... | 5 |
| 2 STATEMENT OF COMPLIANCE | 6 |
| 3 CLIENT INFORMATION | 7 |
| 3.1 APPLICANT INFORMATION | 7 |
| 3.2 MANUFACTURER INFORMATION | 7 |
| 4 EQUIPMENT UNDER TEST (EUT) AND ANCILLARY EQUIPMENT (AE) | 8 |
| 4.1 ABOUT EUT | 8 |
| 4.2 INTERNAL IDENTIFICATION OF EUT USED DURING THE TEST | 8 |
| 4.3 INTERNAL IDENTIFICATION OF AE USED DURING THE TEST | 8 |
| 5 TEST METHODOLOGY | 9 |
| 5.1 APPLICABLE LIMIT REGULATIONS | 9 |
| 5.2 APPLICABLE MEASUREMENT STANDARDS..... | 9 |
| 6 SPECIFIC ABSORPTION RATE (SAR) | 10 |
| 6.1 INTRODUCTION..... | 10 |
| 6.2 SAR DEFINITION..... | 10 |
| 7 TISSUE SIMULATING LIQUIDS | 11 |
| 7.1 TARGETS FOR TISSUE SIMULATING LIQUID | 11 |
| 7.2 DIELECTRIC PERFORMANCE | 11 |
| 8 SYSTEM VERIFICATION | 12 |
| 8.1 SYSTEM SETUP..... | 12 |
| 8.2 SYSTEM VERIFICATION..... | 13 |
| 9 MEASUREMENT PROCEDURES | 14 |
| 9.1 TESTS TO BE PERFORMED | 14 |
| 9.2 GENERAL MEASUREMENT PROCEDURE..... | 16 |
| 9.3 BLUETOOTH MEASUREMENT PROCEDURES FOR SAR | 17 |
| 9.4 POWER DRIFT..... | 17 |
| 10 CONDUCTED OUTPUT POWER | 18 |
| 11 TRANSMIT ANTENNA SEPARATION DISTANCES | 18 |
| 12 SAR TEST RESULT | 19 |
| 12.1 SAR RESULTS FOR LIMB-WORN..... | 19 |
| 12.2 SAR RESULTS FOR FRONT-OF-FACE..... | 20 |



13 SAR MEASUREMENT VARIABILITY.....21

14 MEASUREMENT UNCERTAINTY22

 14.1 MEASUREMENT UNCERTAINTY FOR NORMAL SAR TESTS (300MHZ~3GHZ) 22

15 MAIN TEST INSTRUMENTS.....23

ANNEX A GRAPH RESULTS.....24

ANNEX B SYSTEM VERIFICATION RESULTS27

ANNEX C SAR MEASUREMENT SETUP29

ANNEX D POSITION OF THE WIRELESS DEVICE IN RELATION TO THE PHANTOM35

ANNEX E EQUIVALENT MEDIA RECIPES37

ANNEX F SYSTEM VALIDATION38

ANNEX G PROBE CALIBRATION CERTIFICATE.....39

ANNEX H DIPOLE CALIBRATION CERTIFICATE48

ANNEX I ACCREDITATION CERTIFICATE54

1 Test Laboratory

1.1 Testing Location

| | |
|---------------|---|
| Company Name: | CTTL(Shouxiang) |
| Address: | No. 51 Shouxiang Science Building, Xueyuan Road, Haidian District, Beijing, P. R. China100191 |

1.2 Testing Environment

| | |
|-----------------------------|----------------|
| Temperature: | 18°C~25°C, |
| Relative humidity: | 30%~ 70% |
| Ground system resistance: | < 0.5 Ω |
| Ambient noise & Reflection: | < 0.012 W/kg |

1.3 Project Data

| | |
|---------------------|--------------------|
| Project Leader: | Qi Dianyuan |
| Test Engineer: | Lin Xiaojun |
| Testing Start Date: | September 12, 2021 |
| Testing End Date: | September 15, 2021 |

1.4 Signature



Lin Xiaojun

(Prepared this test report)

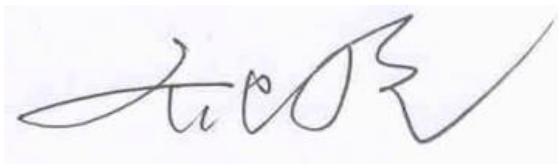

Qi Dianyuan

(Reviewed this test report)

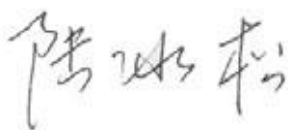

Lu Bingsong

Deputy Director of the laboratory

(Approved this test report)

2 Statement of Compliance

The maximum results of Specific Absorption Rate (SAR) found during testing for Honor Device Co., Ltd. Smart Watch MUS-B19 are as follows:

Table 2.1: Highest Reported SAR (1g)

| Exposure Configuration | Technology Band | Highest Reported SAR (W/kg) | Limited (W/kg) | Equipment Class |
|---|-----------------|-----------------------------|-----------------|-----------------|
| Limb-worn (Separation Distance 0mm) | BT | 0.27(10g) | 4.0(10g) | DSS |
| Front-of-face (Separation Distance 10mm) | BT | 0.16(1g) | 1.6(1g) | |

The SAR values found for the Mobile Phone are below the maximum recommended levels of 1.6 W/kg as averaged over any 1g tissue according to the ANSI C95.1-1992.

For body operation, this device has been tested and meets FCC RF exposure guidelines when used with any accessory that contains no metal and which provides a minimum separation distance of 10 mm between this device and the body of the user. Use of other accessories may not ensure compliance with FCC RF exposure guidelines.

The EUT battery must be fully charged and checked periodically during the test to ascertain uniform power output.

The measurement together with the test system set-up is described in annex C of this test report. A detailed description of the equipment under test can be found in chapter 4 of this test report. The highest reported SAR value is obtained at the case of **(Table 2.1)**, and the values are: **0.27 W/kg(10g)** for limb-worn and **0.16 W/kg(1g)** for front-of-face.



3 Client Information

3.1 Applicant Information

| | |
|-----------------|--|
| Company Name: | Honor Device Co., Ltd. |
| Address/Post: | Shum Yip Sky Park, No. 8089, Hongli West Road, Shenzhen, China |
| Contact Person: | zhangqian |
| E-mail: | zhangqian28@hihonor.com |
| Telephone: | 15210184193 |
| Fax: | / |

3.2 Manufacturer Information

| | |
|-----------------|--|
| Company Name: | Honor Device Co., Ltd. |
| Address/Post: | Shum Yip Sky Park, No. 8089, Hongli West Road, Shenzhen, China |
| Contact Person: | zhangqian |
| E-mail: | zhangqian28@hihonor.com |
| Telephone: | 15210184193 |
| Fax: | / |

4 Equipment Under Test (EUT) and Ancillary Equipment (AE)

4.1 About EUT

| | |
|-------------------------------------|-----------------------------|
| Description: | Smart Watch |
| Model name: | MUS-B19 |
| Operating mode(s): | BT |
| Tested Tx Frequency: | 2402 – 2480 MHz (Bluetooth) |
| Test device Production information: | Production unit |
| Device type: | Portable device |
| Antenna type: | Integrated antenna |

4.2 Internal Identification of EUT used during the test

| EUT ID* | IMEI | HW Version | SW Version |
|---------|--------------|------------|------------|
| EUT1 | A06974667B0D | Au68g | 5.0.80.99 |
| EUT2 | A0697466755F | Au68g | 5.0.80.99 |

*EUT ID: is used to identify the test sample in the lab internally.

Note: It is performed to test SAR with the EUT1&2.

4.3 Internal Identification of AE used during the test

| AE ID* | Description | Model | SN | Manufacturer |
|--------|-------------|-------------|----|---|
| AE1 | Battery | HB522628EFW | / | HONOR DEVICE CO.LTD(manufacturer: NVT) |
| AE2 | Battery | HB522628EFW | / | HONOR DEVICE CO.LTD(manufacturer: SWD) |

*AE ID: is used to identify the test sample in the lab internally.

5 TEST METHODOLOGY

5.1 Applicable Limit Regulations

ANSI C95.1–1992:IEEE Standard for Safety Levels with Respect to Human Exposure to Radio Frequency Electromagnetic Fields, 3 kHz to 300 GHz.

It specifies the maximum exposure limit of **1.6 W/kg** as averaged over any 1 gram of tissue for portable devices being used within 20 cm of the user in the uncontrolled environment.

5.2 Applicable Measurement Standards

IEEE 1528–2013: Recommended Practice for Determining the Peak Spatial-Average Specific Absorption Rate (SAR) in the Human Head from Wireless Communications Devices: Measurement Techniques.

KDB447498 D01: General RF Exposure Guidance v06: Mobile and Portable Devices RF Exposure Procedures and Equipment Authorization Policies.

KDB648474 D04 Handset SAR v01r03: SAR Evaluation Considerations for Wireless Handsets.

KDB941225 D06 Hotspot Mode SAR v02r01: SAR Evaluation Procedures for Portable Devices with Wireless Router Capabilities

KDB865664 D01 SAR measurement 100 MHz to 6 GHz v01r04: SAR Measurement Requirements for 100 MHz to 6 GHz.

KDB865664 D02 RF Exposure Reporting v01r02: RF Exposure Compliance Reporting and Documentation Considerations

6 Specific Absorption Rate (SAR)

6.1 Introduction

SAR is related to the rate at which energy is absorbed per unit mass in an object exposed to a radio field. The SAR distribution in a biological body is complicated and is usually carried out by experimental techniques or numerical modeling. The standard recommends limits for two tiers of groups, occupational/controlled and general population/uncontrolled, based on a person's awareness and ability to exercise control over his or her exposure. In general, occupational/controlled exposure limits are higher than the limits for general population/uncontrolled.

6.2 SAR Definition

The SAR definition is the time derivative (rate) of the incremental energy (dW) absorbed by (dissipated in) an incremental mass (dm) contained in a volume element (dv) of a given density (ρ). The equation description is as below:

$$SAR = \frac{d}{dt} \left(\frac{dW}{dm} \right) = \frac{d}{dt} \left(\frac{dW}{\rho dv} \right)$$

SAR is expressed in units of Watts per kilogram (W/kg)

SAR measurement can be either related to the temperature elevation in tissue by

$$SAR = c \left(\frac{\delta T}{\delta t} \right)$$

Where: C is the specific heat capacity, δT is the temperature rise and δt is the exposure duration, or related to the electrical field in the tissue by

$$SAR = \frac{\sigma |E|^2}{\rho}$$

Where: σ is the conductivity of the tissue, ρ is the mass density of tissue and E is the RMS electrical field strength.

However for evaluating SAR of low power transmitter, electrical field measurement is typically applied.

7 Tissue Simulating Liquids

7.1 Targets for tissue simulating liquid

Table 7.1: Targets for tissue simulating liquid

| Frequency(MHz) | Liquid Type | Conductivity(σ) | $\pm 10\%$ Range | Permittivity(ϵ) | $\pm 10\%$ Range |
|----------------|-------------|--------------------------|------------------|----------------------------|------------------|
| 2450 | Head | 1.80 | 1.62~1.98 | 39.2 | 35.28~43.12 |

7.2 Dielectric Performance

Table 7.2: Dielectric Performance of Tissue Simulating Liquid

| Measurement Date (yyyy-mm-dd) | Type | Frequency | Permittivity ϵ | Drift (%) | Conductivity σ (S/m) | Drift (%) |
|-------------------------------|------|-----------|-------------------------|-----------|-----------------------------|-----------|
| 2021-9-12 | Head | 2450MHz | 41.44 | 5.71 | 1.933 | 7.39 |
| 2021-9-15 | Head | 2450MHz | 41.59 | 6.10 | 1.922 | 6.78 |

Note: The liquid temperature is 22.0°C

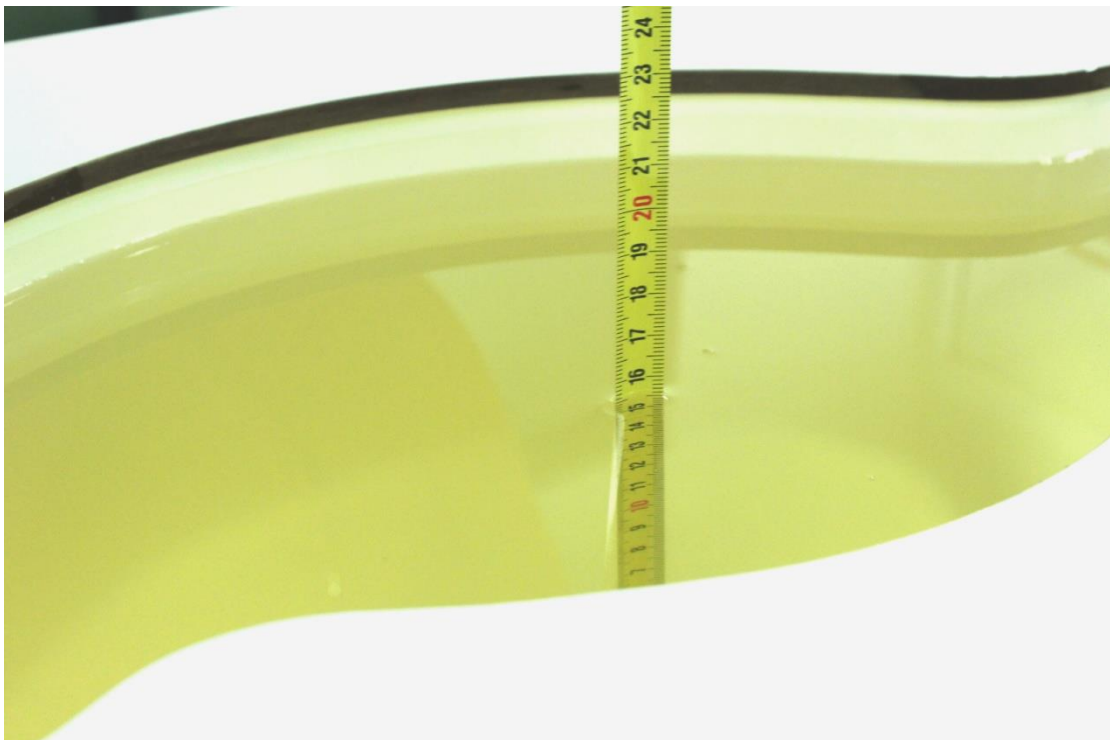

Picture 7 Liquid depth in the Head Phantom (2450 MHz)

8 System verification

8.1 System Setup

In the simplified setup for system evaluation, the DUT is replaced by a calibrated dipole and the power source is replaced by a continuous wave that comes from a signal generator. The calibrated dipole must be placed beneath the flat phantom section of the SAM twin phantom with the correct distance holder. The distance holder should touch the phantom surface with a light pressure at the reference marking and be oriented parallel to the long side of the phantom. The equipment setup is shown below:

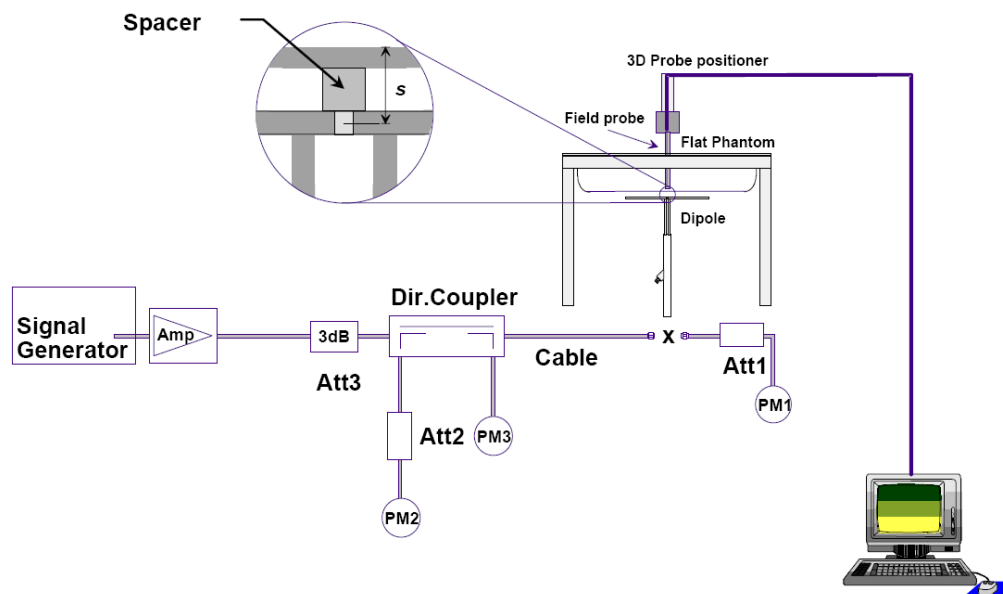

Picture 8.1 System Setup for System Evaluation



Picture 8.2 Photo of Dipole Setup

8.2 System Verification

SAR system verification is required to confirm measurement accuracy, according to the tissue dielectric media, probe calibration points and other system operating parameters required for measuring the SAR of a test device. The system verification must be performed for each frequency band and within the valid range of each probe calibration point required for testing the device.

The system verification results are required that the area scan estimated 1-g SAR is within 3% of the zoom scan 1-g SAR. The details are presented in annex B.

Table 8.1: System Verification of Head

| Measurement Date (yyyy-mm-dd) | Frequency | Target value (W/kg) | | Measured value(W/kg) | | Deviation | |
|----------------------------------|-----------|---------------------|----------------|----------------------|----------------|-----------------|----------------|
| | | 10 g Average | 1 g Average | 10 g Average | 1 g Average | 10 g Average | 1 g Average |
| 2021-9-12 | 2450 MHz | 24.9 | 53.3 | 26.0 | 56.8 | 4.58% | 6.57% |
| 2021-9-15 | 2450 MHz | 24.9 | 53.3 | 25.7 | 56.0 | 3.29% | 5.07% |

9 Measurement Procedures

9.1 Tests to be performed

In order to determine the highest value of the peak spatial-average SAR of a handset, all device positions, configurations and operational modes shall be tested for each frequency band according to steps 1 to 3 below. A flowchart of the test process is shown in picture 9.1.

Step 1: The tests described in 9.2 shall be performed at the channel that is closest to the centre of the transmit frequency band (f_c) for:

- a) all device positions (cheek and tilt, for both left and right sides of the SAM phantom, as described in annex D),
- b) all configurations for each device position in a), e.g., antenna extended and retracted, and
- c) all operational modes, e.g., analogue and digital, for each device position in a) and configuration in b) in each frequency band.

If more than three frequencies need to be tested according to 11.1 (i.e., $N_c > 3$), then all frequencies, configurations and modes shall be tested for all of the above test conditions.

Step 2: For the condition providing highest peak spatial-average SAR determined in Step 1, perform all tests described in 9.2 at all other test frequencies, i.e., lowest and highest frequencies. In addition, for all other conditions (device position, configuration and operational mode) where the peak spatial-average SAR value determined in Step 1 is within 3 dB of the applicable SAR limit, it is recommended that all other test frequencies shall be tested as well.

Step 3: Examine all data to determine the highest value of the peak spatial-average SAR found in Steps 1 to 2.

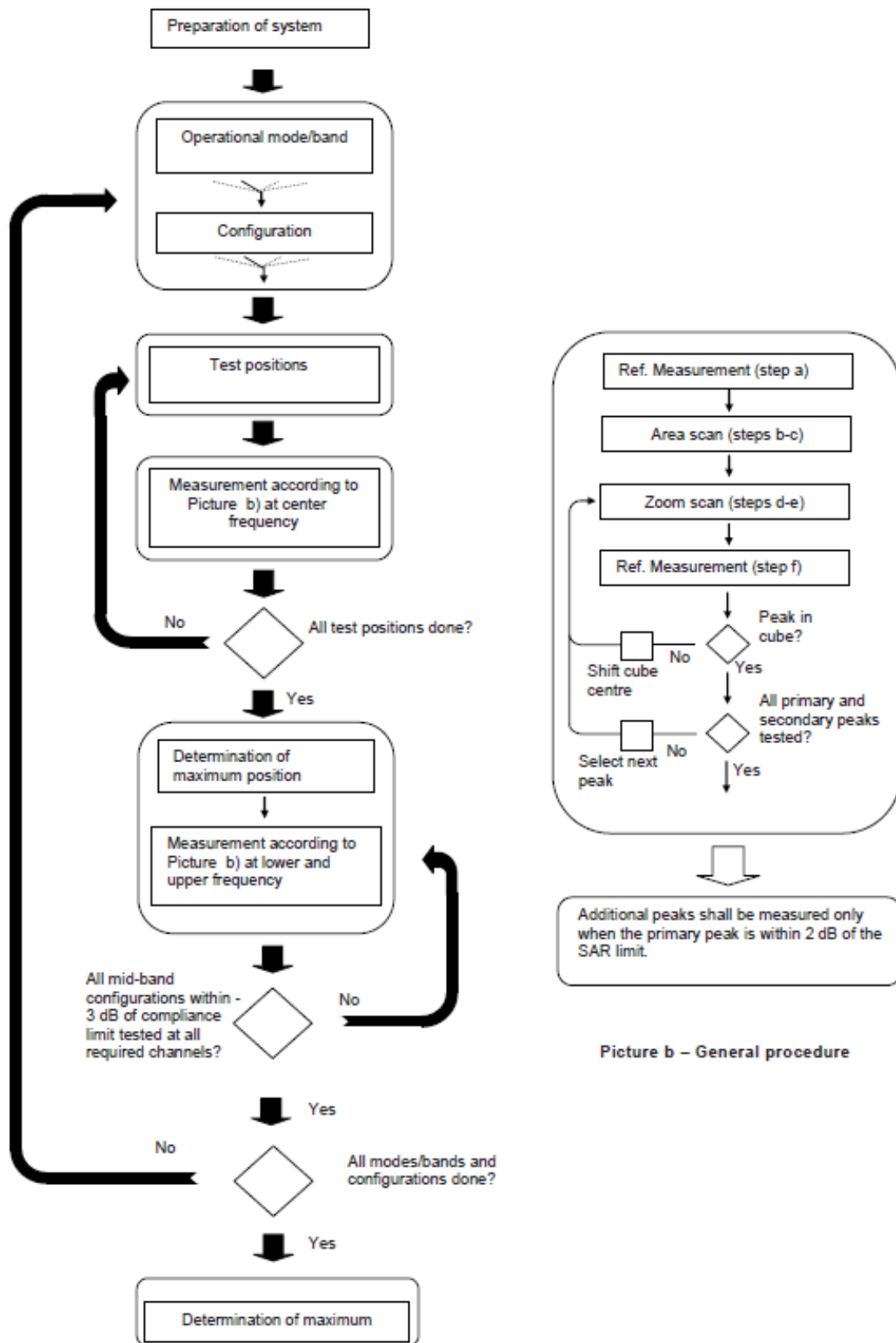

Picture a – Tests to be performed

Picture b – General procedure

Picture 9.1 Block diagram of the tests to be performed

9.2 General Measurement Procedure

The area and zoom scan resolutions specified in the table below must be applied to the SAR measurements and fully documented in SAR reports to qualify for TCB approval. Probe boundary effect error compensation is required for measurements with the probe tip closer than half a probe tip diameter to the phantom surface. Both the probe tip diameter and sensor offset distance must satisfy measurement protocols; to ensure probe boundary effect errors are minimized and the higher fields closest to the phantom surface can be correctly measured and extrapolated to the phantom surface for computing 1-g SAR. Tolerances of the post-processing algorithms must be verified by the test laboratory for the scan resolutions used in the SAR measurements, according to the reference distribution functions specified in IEEE Std 1528-2003. The results should be documented as part of the system validation records and may be requested to support test results when all the measurement parameters in the following table are not satisfied.

| | | ≤ 3 GHz | > 3 GHz | |
|---|------------------------------------|--|---|--|
| Maximum distance from closest measurement point (geometric center of probe sensors) to phantom surface | | 5 ± 1 mm | $\frac{1}{2} \delta \ln(2) \pm 0.5$ mm | |
| Maximum probe angle from probe axis to phantom surface normal at the measurement location | | $30^\circ \pm 1^\circ$ | $20^\circ \pm 1^\circ$ | |
| Maximum area scan spatial resolution: Δx_{Area} , Δy_{Area} | | ≤ 2 GHz: ≤ 15 mm 2 – 3 GHz: ≤ 12 mm | 3 – 4 GHz: ≤ 12 mm 4 – 6 GHz: ≤ 10 mm | |
| | | When the x or y dimension of the test device, in the measurement plane orientation, is smaller than the above, the measurement resolution must be \leq the corresponding x or y dimension of the test device with at least one measurement point on the test device. | | |
| Maximum zoom scan spatial resolution: Δx_{Zoom} , Δy_{Zoom} | | ≤ 2 GHz: ≤ 8 mm 2 – 3 GHz: ≤ 5 mm* | 3 – 4 GHz: ≤ 5 mm* 4 – 6 GHz: ≤ 4 mm* | |
| Maximum zoom scan spatial resolution, normal to phantom surface | uniform grid: $\Delta z_{Zoom}(n)$ | ≤ 5 mm | 3 – 4 GHz: ≤ 4 mm 4 – 5 GHz: ≤ 3 mm 5 – 6 GHz: ≤ 2 mm | |
| | graded grid | $\Delta z_{Zoom}(1)$: between 1 st two points closest to phantom surface | ≤ 4 mm | 3 – 4 GHz: ≤ 3 mm 4 – 5 GHz: ≤ 2.5 mm 5 – 6 GHz: ≤ 2 mm |
| | | $\Delta z_{Zoom}(n>1)$: between subsequent points | $\leq 1.5 \cdot \Delta z_{Zoom}(n-1)$ | |
| Minimum zoom scan volume | x, y, z | ≥ 30 mm | 3 – 4 GHz: ≥ 28 mm 4 – 5 GHz: ≥ 25 mm 5 – 6 GHz: ≥ 22 mm | |
| Note: δ is the penetration depth of a plane-wave at normal incidence to the tissue medium; see draft standard IEEE P1528-2011 for details. * When zoom scan is required and the <i>reported</i> SAR from the area scan based 1-g SAR estimation procedures of KDB 447498 is ≤ 1.4 W/kg, ≤ 8 mm, ≤ 7 mm and ≤ 5 mm zoom scan resolution may be applied, respectively, for 2 GHz to 3 GHz, 3 GHz to 4 GHz and 4 GHz to 6 GHz. | | | | |

9.3 Bluetooth Measurement Procedures for SAR

Normal network operating configurations are not suitable for measuring the SAR of 802.11 transmitters in general. Unpredictable fluctuations in network traffic and antenna diversity conditions can introduce undesirable variations in SAR results. The SAR for these devices should be measured using chipset based test mode software to ensure that the results are consistent and reliable.

Chipset based test mode software is hardware dependent and generally varies among manufacturers. The device operating parameters established in a test mode for SAR measurements must be identical to those programmed in production units, including output power levels, amplifier gain settings and other RF performance tuning parameters. The test frequencies should correspond to actual channel frequencies defined for domestic use. SAR for devices with switched diversity should be measured with only one antenna transmitting at a time during each SAR measurement, according to a fixed modulation and data rate. The same data pattern should be used for all measurements.

9.4 Power Drift

To control the output power stability during the SAR test, DASY4 system calculates the power drift by measuring the E-field at the same location at the beginning and at the end of the measurement for each test position. These drift values can be found in section 14 labeled as: (Power Drift [dB]). This ensures that the power drift during one measurement is within 5%.



10 Conducted Output Power

The maximum tune up of BT antenna is 15.5dBm

| GFSK | | | EDR2M-4_DQPSK | | | EDR3M-8DPSK | | |
|-----------|------------|------------|---------------|------------|------------|-------------|------------|------------|
| Channel 0 | Channel 39 | Channel 78 | Channel 0 | Channel 39 | Channel 78 | Channel 0 | Channel 39 | Channel 78 |
| 13.62 | 13.91 | 14.08 | 8.14 | 8.67 | 9.09 | 7.87 | 8.77 | 9.06 |

11 Transmit Antenna Separation Distances

Please refer to the picture of antenna locations in the document: "The antenna locations of SAR test-I21Z61402"

12 SAR Test Result

Note:

H1: the battery of HB522628EFW by HONOR DEVICE CO.LTD(manufacturer: NVT)

H2: the battery of HB522628EFW by HONOR DEVICE CO.LTD(manufacturer: SWD)

12.1 SAR results for Limb-worn

Table 12.1: SAR Values (BT – Limb-worn)

| Frequency | | Side | Distance | Figure No. | Conducted Power (dBm) | Max. tune-up Power (dBm) | Measured SAR(10g) (W/kg) | Reported SAR(10g) (W/kg) | Measured SAR(1g) (W/kg) | Reported SAR(1g) (W/kg) | Power Drift (dB) |
|-----------|------|------|----------|------------|-----------------------|--------------------------|--------------------------|--------------------------|-------------------------|-------------------------|------------------|
| Ch. | MHz | | | | | | | | | | |
| 0 | 2402 | Rear | 0mm | / | 13.62 | 15.50 | 0.134 | 0.21 | 0.331 | 0.51 | -0.04 |
| 39 | 2441 | Rear | 0mm | / | 13.91 | 15.50 | 0.127 | 0.18 | 0.303 | 0.44 | -0.08 |
| 78 | 2480 | Rear | 0mm | Fig.1 | 14.08 | 15.50 | 0.151 | 0.21 | 0.363 | 0.50 | -0.06 |
| 78 | 2480 | Rear | 0mm | B2 | 14.08 | 15.50 | 0.149 | 0.21 | 0.360 | 0.50 | -0.17 |

Table 12.2: SAR Values (BT – Limb-worn) (Scaled Reported SAR)

| Frequency | | Test Position | Actual duty factor | maximum duty factor | Reported SAR (10g)(W/kg) | Scaled reported SAR (10g)(W/kg) |
|-----------|------|---------------|--------------------|---------------------|--------------------------|---------------------------------|
| Ch. | MHz | | | | | |
| 78 | 2480 | Rear 0mm | 77.13% | 100% | 0.21 | 0.27 |

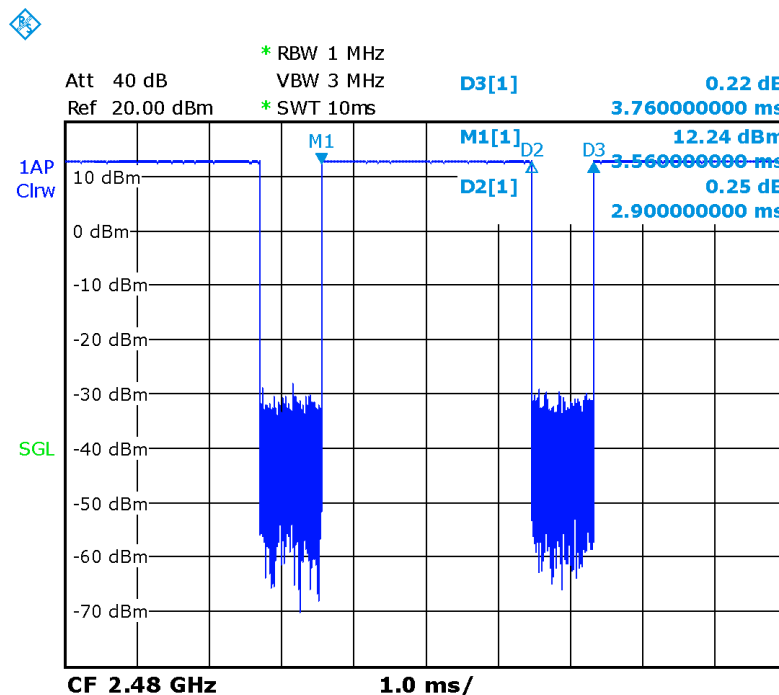

Picture 10.1 Duty factor plot

12.2 SAR results for Front-of-face

Table 12.3: SAR Values (BT – Front-of-face)

| Frequency | | Side | Distance | Figure No. | Conducted Power (dBm) | Max. tune-up Power (dBm) | Measured SAR(10g) (W/kg) | Reported SAR(10g) (W/kg) | Measured SAR(1g) (W/kg) | Reported SAR(1g) (W/kg) | Power Drift (dB) |
|-----------|------|-------|----------|------------|-----------------------|--------------------------|--------------------------|--------------------------|-------------------------|-------------------------|------------------|
| Ch. | MHz | | | | | | | | | | |
| 0 | 2402 | Front | 10mm | Fig.2 | 13.62 | 15.50 | 0.040 | 0.06 | 0.078 | 0.12 | 0.17 |
| 39 | 2441 | Front | 10mm | / | 13.91 | 15.50 | 0.032 | 0.05 | 0.062 | 0.09 | 0.07 |
| 78 | 2480 | Front | 10mm | / | 14.08 | 15.50 | 0.032 | 0.04 | 0.062 | 0.09 | -0.05 |
| 0 | 2402 | Front | 10mm | B2 | 14.08 | 15.50 | 0.038 | 0.05 | 0.071 | 0.10 | 0.14 |

Table 12.4: SAR Values (BT –Front-of-face) (Scaled Reported SAR)

| Frequency | | Test Position | Actual duty factor | maximum duty factor | Reported SAR (1g)(W/kg) | Scaled reported SAR (1g)(W/kg) |
|-----------|------|---------------|--------------------|---------------------|-------------------------|--------------------------------|
| Ch. | MHz | | | | | |
| 0 | 2402 | Front 10mm | 76.72% | 100% | 0.12 | 0.16 |

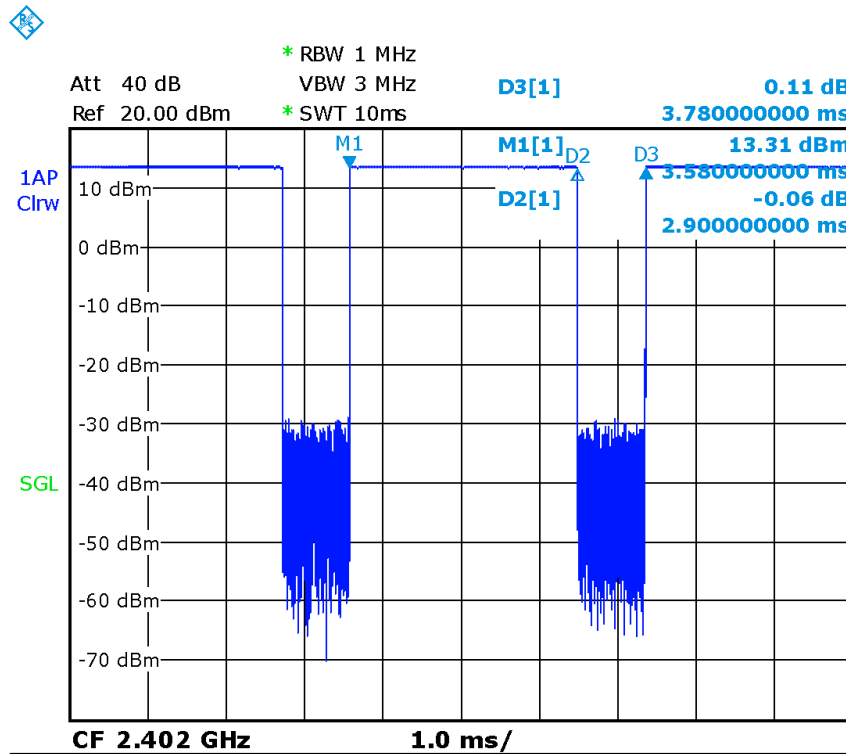

Picture 10.2 Duty factor plot

13 SAR Measurement Variability

SAR measurement variability must be assessed for each frequency band, which is determined by the SAR probe calibration point and tissue-equivalent medium used for the device measurements. When both head and body tissue-equivalent media are required for SAR measurements in a frequency band, the variability measurement procedures should be applied to the tissue medium with the highest measured SAR, using the highest measured SAR configuration for that tissue-equivalent medium.

The following procedures are applied to determine if repeated measurements are required.

- 1) Repeated measurement is not required when the original highest measured SAR is < 0.80 W/kg; steps 2) through 4) do not apply.
- 2) When the original highest measured SAR is ≥ 0.80 W/kg, repeat that measurement once.
- 3) Perform a second repeated measurement only if the ratio of largest to smallest SAR for the original and first repeated measurements is > 1.20 or when the original or repeated measurement is ≥ 1.45 W/kg ($\sim 10\%$ from the 1-g SAR limit).
- 4) Perform a third repeated measurement only if the original, first or second repeated measurement is ≥ 1.5 W/kg and the ratio of largest to smallest SAR for the original, first and second repeated measurements is > 1.20 .

14 Measurement Uncertainty

14.1 Measurement Uncertainty for Normal SAR Tests (300MHz~3GHz)

| No. | Error Description | Type | Uncertainty value | Probably Distribution | Div. | (Ci) 1g | (Ci) 10g | Std. Unc. (1g) | Std. Unc. (10g) | Degree of freedom |
|----------------------------|---|------|-------------------|-----------------------|------------|---------|----------|----------------|-----------------|-------------------|
| Measurement system | | | | | | | | | | |
| 1 | Probe calibration | B | 6.0 | N | 1 | 1 | 1 | 6.0 | 6.0 | ∞ |
| 2 | Isotropy | B | 4.7 | R | $\sqrt{3}$ | 0.7 | 0.7 | 1.9 | 1.9 | ∞ |
| 3 | Boundary effect | B | 1.0 | R | $\sqrt{3}$ | 1 | 1 | 0.6 | 0.6 | ∞ |
| 4 | Linearity | B | 4.7 | R | $\sqrt{3}$ | 1 | 1 | 2.7 | 2.7 | ∞ |
| 5 | Detection limit | B | 1.0 | N | 1 | 1 | 1 | 0.6 | 0.6 | ∞ |
| 6 | Readout electronics | B | 0.3 | R | $\sqrt{3}$ | 1 | 1 | 0.3 | 0.3 | ∞ |
| 7 | Response time | B | 0.8 | R | $\sqrt{3}$ | 1 | 1 | 0.5 | 0.5 | ∞ |
| 8 | Integration time | B | 2.6 | R | $\sqrt{3}$ | 1 | 1 | 1.5 | 1.5 | ∞ |
| 9 | RF ambient conditions-noise | B | 0 | R | $\sqrt{3}$ | 1 | 1 | 0 | 0 | ∞ |
| 10 | RFambient conditions-reflection | B | 0 | R | $\sqrt{3}$ | 1 | 1 | 0 | 0 | ∞ |
| 11 | Probe positioned mech. restrictions | B | 0.4 | R | $\sqrt{3}$ | 1 | 1 | 0.2 | 0.2 | ∞ |
| 12 | Probe positioning with respect to phantom shell | B | 2.9 | R | $\sqrt{3}$ | 1 | 1 | 1.7 | 1.7 | ∞ |
| 13 | Post-processing | B | 1.0 | R | $\sqrt{3}$ | 1 | 1 | 0.6 | 0.6 | ∞ |
| Test sample related | | | | | | | | | | |
| 14 | Test sample positioning | A | 3.3 | N | 1 | 1 | 1 | 3.3 | 3.3 | 71 |
| 15 | Device holder uncertainty | A | 3.4 | N | 1 | 1 | 1 | 3.4 | 3.4 | 5 |
| 16 | Drift of output power | B | 5.0 | R | $\sqrt{3}$ | 1 | 1 | 2.9 | 2.9 | ∞ |
| Phantom and set-up | | | | | | | | | | |
| 17 | Phantom uncertainty | B | 4.0 | R | $\sqrt{3}$ | 1 | 1 | 2.3 | 2.3 | ∞ |
| 18 | Liquid conductivity (target) | B | 5.0 | R | $\sqrt{3}$ | 0.64 | 0.43 | 1.8 | 1.2 | ∞ |
| 19 | Liquid conductivity (meas.) | A | 2.06 | N | 1 | 0.64 | 0.43 | 1.32 | 0.89 | 43 |
| 20 | Liquid permittivity (target) | B | 5.0 | R | $\sqrt{3}$ | 0.6 | 0.49 | 1.7 | 1.4 | ∞ |
| 21 | Liquid permittivity (meas.) | A | 1.6 | N | 1 | 0.6 | 0.49 | 1.0 | 0.8 | 521 |

| | | | | | | | | |
|--|--|--|--|--|--|------|------|-----|
| Combined standard uncertainty | $u_c = \sqrt{\sum_{i=1}^{21} c_i^2 u_i^2}$ | | | | | 9.55 | 9.43 | 257 |
| Expanded uncertainty (confidence interval of 95 %) | $u_e = 2u_c$ | | | | | 19.1 | 18.9 | |

15 MAIN TEST INSTRUMENTS

Table 15.1: List of Main Instruments

| No. | Name | Type | Serial Number | Calibration Date | Valid Period |
|-----|-----------------------|---------------|---------------|--------------------------|--------------|
| 01 | Network analyzer | E5071C | MY46110673 | January 14, 2021 | One year |
| 02 | Power meter | NRVD | 102083 | October 23, 2020 | One year |
| 03 | Power sensor | NRV-Z5 | 100542 | | |
| 04 | Signal Generator | E4438C | MY49071430 | February 1, 2021 | One Year |
| 05 | Amplifier | 60S1G4 | 0331848 | No Calibration Requested | |
| 06 | E-field Probe | SPEAG EX3DV4 | 7600 | November 30, 2020 | One year |
| 07 | DAE | SPEAG DAE4 | 1525 | September 1, 2021 | One year |
| 08 | Dipole Validation Kit | SPEAG D2450V2 | 853 | July 26,2021 | One year |

END OF REPORT BODY

ANNEX A Graph Results

BT_ Rear 0mm

Date: 9/12/2021

Electronics: DAE4 Sn1525

Medium: H2450

Medium parameters used: $f = 2480$ MHz; $\sigma = 1.934$ S/m; $\epsilon_r = 41.489$; $\rho = 1000$ kg/m³

Ambient Temperature: 22.9oC Liquid Temperature: 22.5oC

Communication System: BT Frequency: 2480 MHz Duty Cycle: 1:1

Probe: EX3DV4 - SN7600 ConvF(7.79, 7.79, 7.79)

Area Scan (101x101x1): Interpolated grid: dx=1.200 mm, dy=1.200 mm

Maximum value of SAR (interpolated) = 0.518 W/kg

Zoom Scan (7x8x7)/Cube 0: Measurement grid: dx=5mm, dy=5mm, dz=5mm

Reference Value = 16.02 V/m; Power Drift = -0.06 dB

Peak SAR (extrapolated) = 0.650 W/kg

SAR(1 g) = 0.363 W/kg; SAR(10 g) = 0.151 W/kg

Maximum value of SAR (measured) = 0.540 W/kg

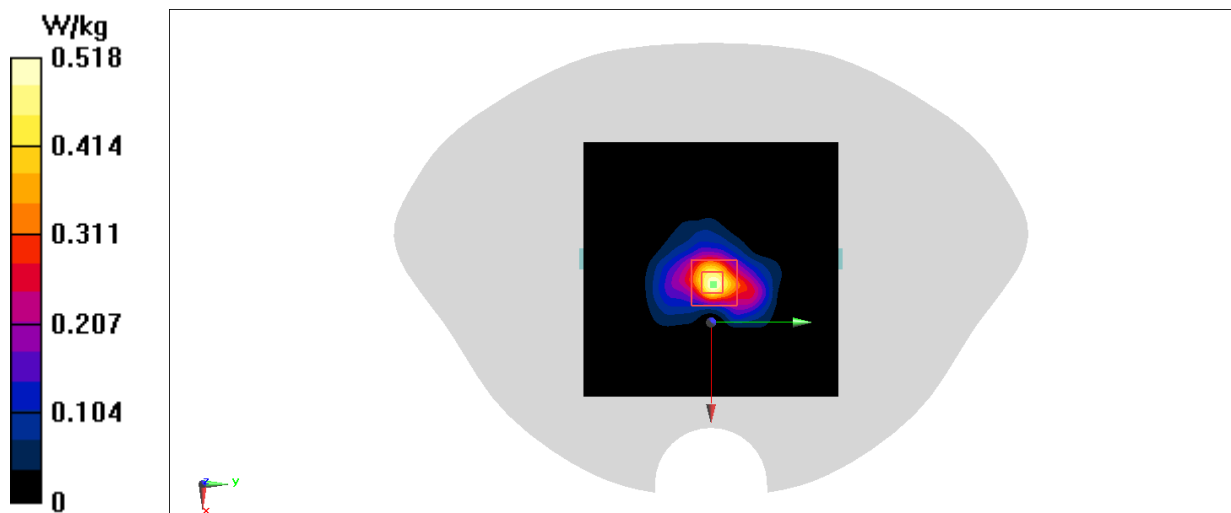

Fig A.1

BT_ Front 10mm

Date/Time: 9/15/2021

Electronics: DAE4 Sn1525

Medium: H2450

Medium parameters used (interpolated): $f = 2402$ MHz; $\sigma = 1.894$ S/m; $\epsilon_r = 41.589$; $\rho = 1000$ kg/m³

Ambient Temperature: 22.5°C Liquid Temperature: 22.3°C

Communication System: Bluetooth Frequency: 2402 MHz Duty Cycle: 1:1

Probe: EX3DV4 - SN7600 ConvF(7.79, 7.79, 7.79)

Area Scan (101x101x1): Interpolated grid: dx=1.200 mm, dy=1.200 mm

Maximum value of SAR (interpolated) = 0.137 W/kg

Zoom Scan (7x7x7)/Cube 0: Measurement grid: dx=5mm, dy=5mm, dz=5mm

Reference Value = 5.348 V/m; Power Drift = 0.17 dB

Peak SAR (extrapolated) = 0.137 W/kg

SAR(1 g) = 0.078 W/kg; SAR(10 g) = 0.040 W/kg

Maximum value of SAR (measured) = 0.115 W/kg

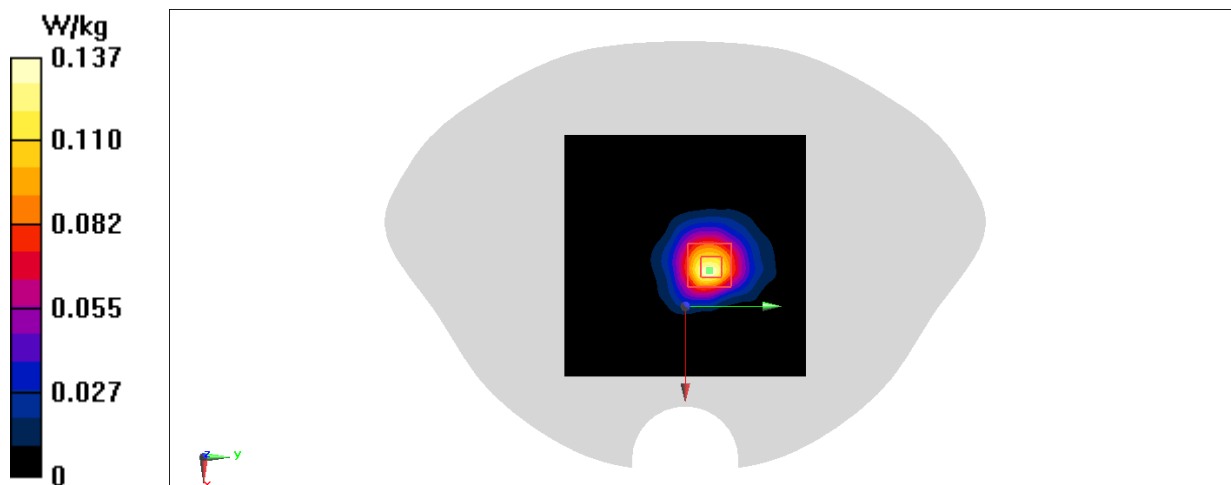
**Fig A.2**

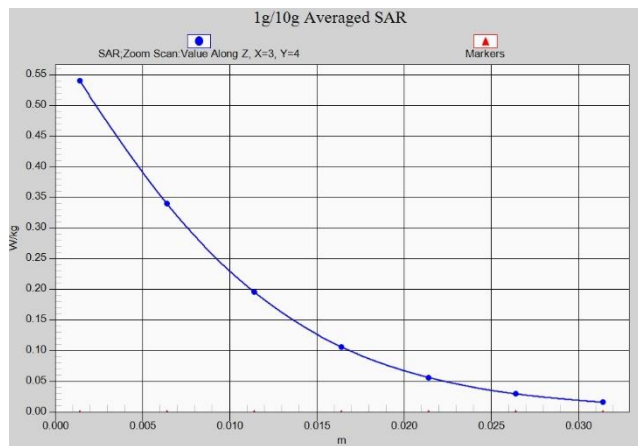

Z-Scan at power reference point (BT)

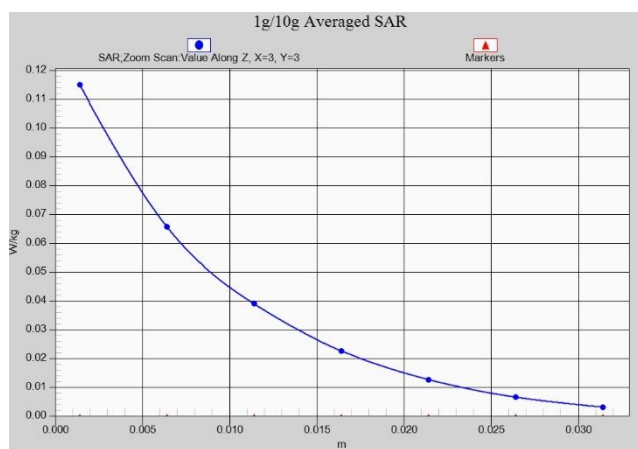

Z-Scan at power reference point (BT)

ANNEX B System Verification Results

2450 MHz

Date: 9/12/2021

Electronics: DAE4 Sn1525

Medium: H2450

Medium parameters used: $f = 2450$ MHz; $\sigma = 1.933$ S/m; $\epsilon_r = 41.437$; $\rho = 1000$ kg/m³

Ambient Temperature: 22.9°C Liquid Temperature: 22.5°C

Communication System: CW Frequency: 2450 MHz Duty Cycle: 1:1

Probe: EX3DV4 - SN7600 ConvF(7.79, 7.79, 7.79)

Area Scan 3 (81x81x1): Interpolated grid: $dx=1.200$ mm, $dy=1.200$ mm

Maximum value of SAR (interpolated) = 23.4 W/kg

Zoom Scan (7x7x7)/Cube 0: Measurement grid: $dx=5$ mm, $dy=5$ mm, $dz=5$ mm

Reference Value = 116.2 V/m; Power Drift = -0.13 dB

Peak SAR (extrapolated) = 30.2 W/kg

SAR(1 g) = 14.2 W/kg; SAR(10 g) = 6.51 W/kg

Maximum value of SAR (measured) = 24.2 W/kg

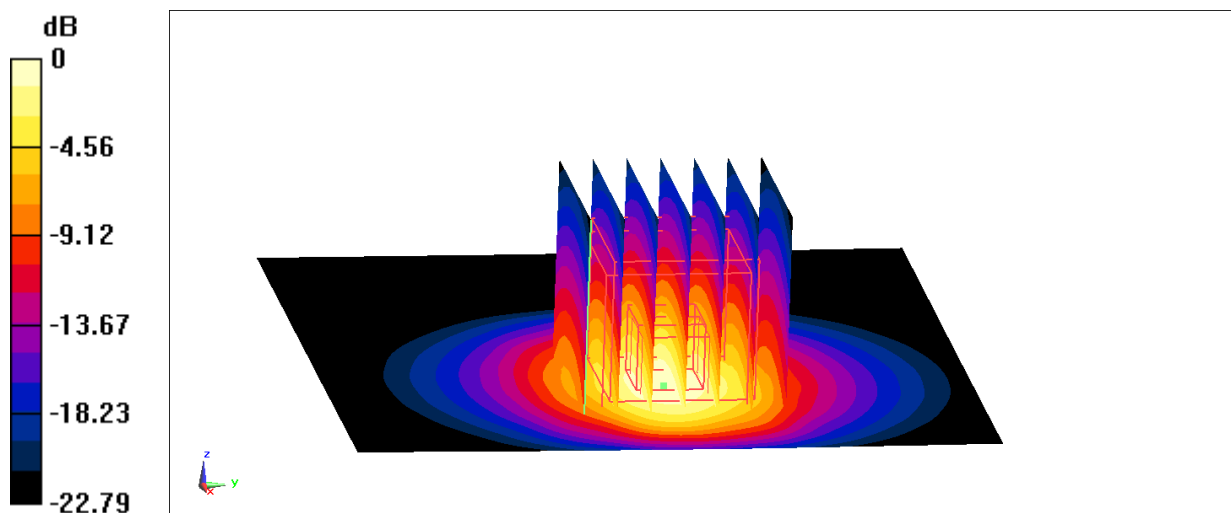

0 dB = 24.2 W/kg = 13.84 dBW/kg

Fig.B.1 validation 2450 MHz 250mW

2450 MHz

Date: 9/15/2021

Electronics: DAE4 Sn1525

Medium: H2450

Medium parameters used: $f = 2450$ MHz; $\sigma = 1.912$ S/m; $\epsilon_r = 41.589$; $\rho = 1000$ kg/m³

Ambient Temperature: 22.5oC Liquid Temperature: 22.3oC

Communication System: CW Frequency: 2450 MHz Duty Cycle: 1:1

Probe: EX3DV4 - SN7600 ConvF(7.79, 7.79, 7.79)

Area Scan 3 (81x81x1): Interpolated grid: dx=1.200 mm, dy=1.200 mm

Maximum value of SAR (interpolated) = 23.1 W/kg

Zoom Scan (7x7x7)/Cube 0: Measurement grid: dx=5mm, dy=5mm, dz=5mm

Reference Value = 115.0 V/m; Power Drift = -0.06 dB

Peak SAR (extrapolated) = 29.9 W/kg

SAR(1 g) = 14 W/kg; SAR(10 g) = 6.43 W/kg

Maximum value of SAR (measured) = 24.0 W/kg

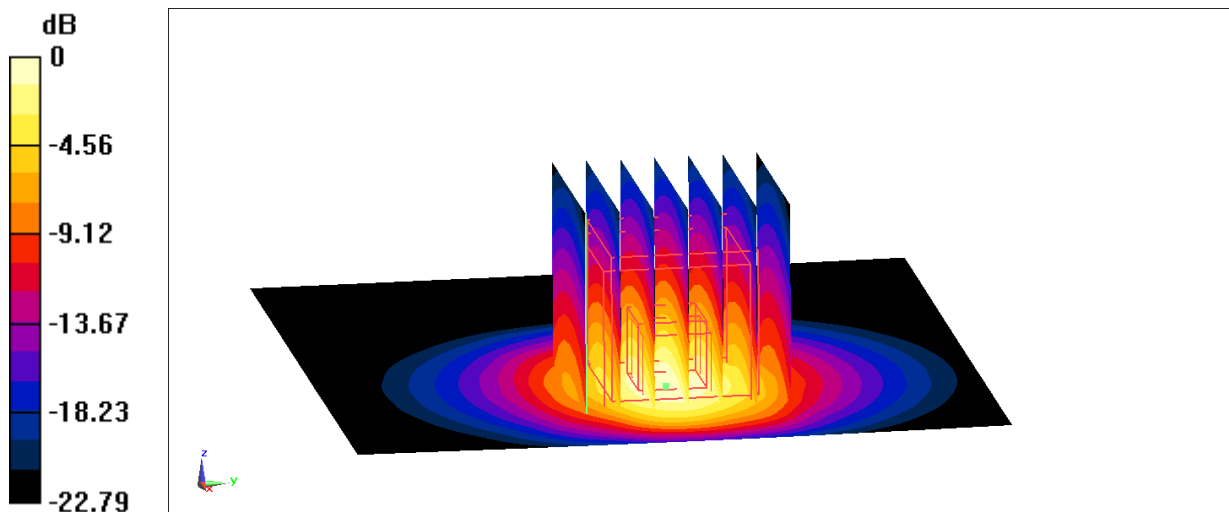

0 dB = 24.0 W/kg = 13.80 dBW/kg

Fig.B.2 validation 2450 MHz 250mW

ANNEX C SAR Measurement Setup

C.1 Measurement Set-up

The Dasy5 or DASY6 system for performing compliance tests is illustrated above graphically. This system consists of the following items:

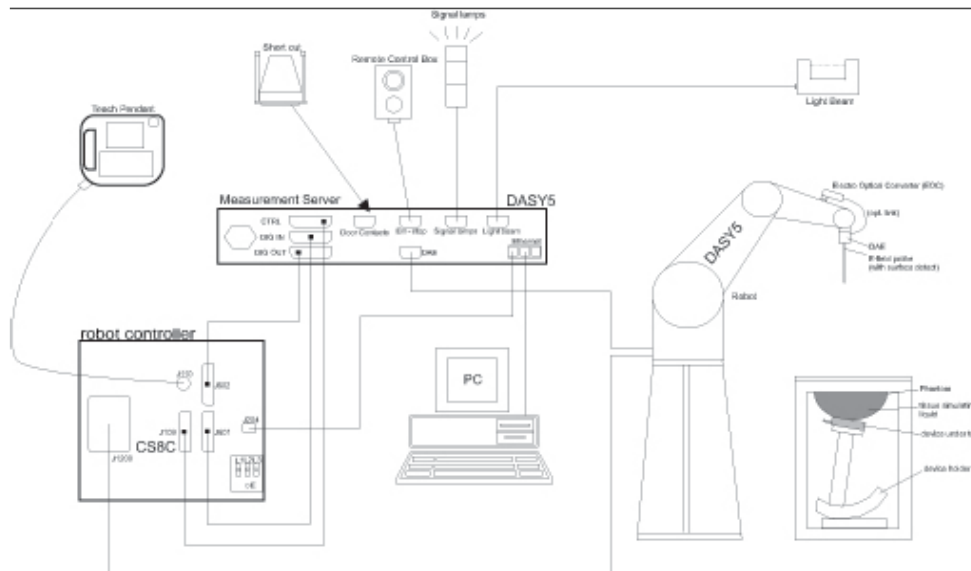

Picture C.1 SAR Lab Test Measurement Set-up

- A standard high precision 6-axis robot (StäubliTX=RX family) with controller, teach pendant and software. An arm extension for accommodating the data acquisition electronics (DAE).
- An isotropic field probe optimized and calibrated for the targeted measurement.
- A data acquisition electronics (DAE) which performs the signal amplification, signal multiplexing, AD-conversion, offset measurements, mechanical surface detection, collision detection, etc. The unit is battery powered with standard or rechargeable batteries. The signal is optically transmitted to the EOC.
- The Electro-optical converter (EOC) performs the conversion from optical to electrical signals for the digital communication to the DAE. To use optical surface detection, a special version of the EOC is required. The EOC signal is transmitted to the measurement server.
- The function of the measurement server is to perform the time critical tasks such as signal filtering, control of the robot operation and fast movement interrupts.
- The Light Beam used is for probe alignment. This improves the (absolute) accuracy of the probe positioning.
- A computer running WinXP and the DASY5 or DASY6 software.
- Remote control and teach pendant as well as additional circuitry for robot safety such as
- warning lamps, etc.
- The phantom, the device holder and other accessories according to the targeted measurement.

C.2 Dasy5 E-field Probe System

The SAR measurements were conducted with the dosimetric probe designed in the classical triangular configuration and optimized for dosimetric evaluation. The probe is constructed using the thick film technique; with printed resistive lines on ceramic substrates. The probe is equipped with an optical multifiber line ending at the front of the probe tip. It is connected to the EOC box on the robot arm and provides an automatic detection of the phantom surface. Half of the fibers are connected to a pulsed infrared transmitter, the other half to a synchronized receiver. As the probe approaches the surface, the reflection from the surface produces a coupling from the transmitting to the receiving fibers. This reflection increases first during the approach, reaches maximum and then decreases. If the probe is flatly touching the surface, the coupling is zero. The distance of the coupling maximum to the surface is independent of the surface reflectivity and largely independent of the surface to probe angle. The DASY5 or DASY6 software reads the reflection during a software approach and looks for the maximum using 2nd order curve fitting. The approach is stopped at reaching the maximum.

Probe Specifications:

| | |
|-----------------------|--|
| Model: | ES3DV3, EX3DV4 |
| Frequency | 10MHz — 6.0GHz(EX3DV4) |
| Range: | 10MHz — 4GHz(ES3DV3) |
| Calibration: | In head and body simulating tissue at Frequencies from 835 up to 5800MHz |
| Linearity: | ± 0.2 dB(30 MHz to 6 GHz) for EX3DV4 ± 0.2 dB(30 MHz to 4 GHz) for ES3DV3 |
| DynamicRange: | 10 mW/kg — 100W/kg |
| Probe Length: | 330 mm |
| Probe Tip | |
| Length: | 20 mm |
| Body Diameter: | 12 mm |
| Tip Diameter: | 2.5 mm (3.9 mm for ES3DV3) |
| Tip-Center: | 1 mm (2.0mm for ES3DV3) |
| Application: | SAR Dosimetry Testing Compliance tests of mobile phones Dosimetry in strong gradient fields |



Picture C.2 Near-field Probe



Picture C.3 E-field Probe

C.3 E-field Probe Calibration

Each E-Probe/Probe Amplifier combination has unique calibration parameters. A TEM cell calibration procedure is conducted to determine the proper amplifier settings to enter in the probe parameters. The amplifier settings are determined for a given frequency by subjecting the probe to a known E-field density (1 mW/cm²) using an RF Signal generator, TEM cell, and RF Power Meter.

The free space E-field from amplified probe outputs is determined in a test chamber. This calibration can be performed in a TEM cell if the frequency is below 1 GHz and in a waveguide or

other methodologies above 1 GHz for free space. For the free space calibration, the probe is placed in the volumetric center of the cavity and at the proper orientation with the field. The probe is then rotated 360 degrees until the three channels show the maximum reading. The power density readings equates to 1 mW/cm².

E-field temperature correlation calibration is performed in a flat phantom filled with the appropriate simulated brain tissue. The E-field in the medium correlates with the temperature rise in the dielectric medium. For temperature correlation calibration a RF transparent thermistor-based temperature probe is used in conjunction with the E-field probe.

$$SAR = C \frac{\Delta T}{\Delta t}$$

Where:

Δt = Exposure time (30 seconds),

C = Heat capacity of tissue (brain or muscle),

ΔT = Temperature increase due to RF exposure.

$$SAR = \frac{|E|^2 \cdot \sigma}{\rho}$$

Where:

σ = Simulated tissue conductivity,

ρ = Tissue density (kg/m³).

C.4 Other Test Equipment

C.4.1 Data Acquisition Electronics(DAE)

The data acquisition electronics consist of a highly sensitive electrometer-grade preamplifier with auto-zeroing, a channel and gain-switching multiplexer, a fast 16 bit AD-converter and a command decoder with a control logic unit. Transmission to the measurement server is accomplished through an optical downlink for data and status information, as well as an optical uplink for commands and the clock.

The mechanical probe mounting device includes two different sensor systems for frontal and sideways probe contacts. They are used for mechanical surface detection and probe collision detection.

The input impedance of the DAE is 200 MOhm; the inputs are symmetrical and floating. Common mode rejection is above 80 dB.

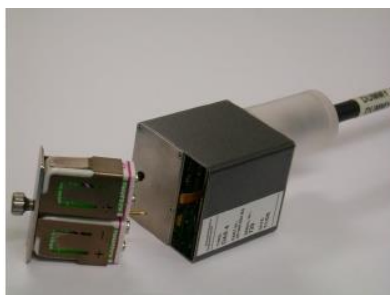

PictureC.4: DAE

C.4.2 Robot

The SPEAG DASY system uses the high precision robots (DASY5: RX160L) type from Stäubli SA (France). For the 6-axis controller system, the robot controller version from Stäubli is used. The Stäubli robot series have many features that are important for our application:

- High precision (repeatability 0.02mm)
- High reliability (industrial design)
- Low maintenance costs (virtually maintenance free due to direct drive gears; no belt drives)
- Jerk-free straight movements (brushless synchron motors; no stepper motors)
- Low ELF interference (motor control fields shielded via the closed metallic construction shields)



Picture C.5 DASY 5

C.4.3 Measurement Server

The Measurement server is based on a PC/104 CPU board with CPU (DASY5: 400 MHz, Intel Celeron), chipdisk (DASY5: 128MB), RAM (DASY5: 128MB). The necessary circuits for communication with the DAE electronic box, as well as the 16 bit AD converter system for optical detection and digital I/O interface are contained on the DASY I/O board, which is directly connected to the PC/104 bus of the CPU board.

The measurement server performs all real-time data evaluation of field measurements and surface detection, controls robot movements and handles safety operation. The PC operating system cannot interfere with these time critical processes. All connections are supervised by a watchdog, and disconnection of any of the cables to the measurement server will automatically disarm the robot and disable all program-controlled robot movements. Furthermore, the measurement server is equipped with an expansion port which is reserved for future applications. Please note that this expansion port does not have a standardized pinout, and therefore only devices provided by SPEAG can be connected. Devices from any other supplier could seriously damage the measurement server.



Picture C.6 Server for DASY 5

C.4.4 Device Holder for Phantom

The SAR in the phantom is approximately inversely proportional to the square of the distance between the source and the liquid surface. For a source at 5mm distance, a positioning uncertainty of $\pm 0.5\text{mm}$ would produce a SAR uncertainty of $\pm 20\%$. Accurate device positioning is therefore crucial for accurate and repeatable measurements. The positions in which the devices must be measured are defined by the standards.

The DASY device holder is designed to cope with the different positions given in the standard. It has two scales for device rotation (with respect to the body axis) and device inclination (with respect to the line between the ear reference points). The rotation centers for both scales are the ear reference point (ERP). Thus the device needs no repositioning when changing the angles.

The DASY device holder is constructed of low-loss POM material having the following dielectric parameters: relative permittivity $\epsilon = 3$ and loss tangent $\delta = 0.02$. The amount of dielectric material has been reduced in the closest vicinity of the device, since measurements have suggested that the influence of the clamp on the test results could thus be lowered.

<Laptop Extension Kit>

The extension is lightweight and made of POM, acrylic glass and foam. It fits easily on the upper part of the Mounting Device in place of the phone positioner. The extension is fully compatible with the Twin-SAM and ELI phantoms.



Picture C7-1: Device Holder

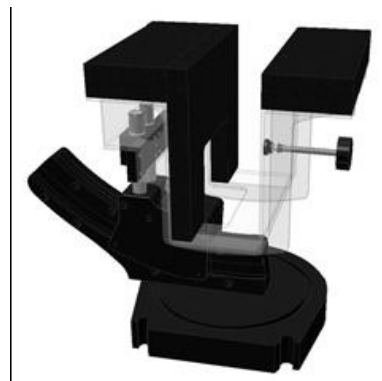

Picture C.7-2: Laptop Extension Kit

C.4.5 Phantom

The SAM Twin Phantom V4.0 is constructed of a fiberglass shell integrated in a table. The shape of the shell is based on data from an anatomical study designed to

Represent the 90th percentile of the population. The phantom enables the dissymmetric evaluation of SAR for both left and right handed handset usage, as well as body-worn usage using the flat phantom region. Reference markings on the Phantom allow the complete setup of all predefined phantom positions and measurement grids by manually teaching three points in the robot. The shell phantom has a 2mm shell thickness (except the ear region where shell thickness increases to 6 mm).

Shell Thickness: 2 ± 0.2 mm

Filling Volume: Approx. 25 liters

Dimensions: 810 x 1000 x 500 mm (H x L x W)

Available: Special



Picture C.8: SAM Twin Phantom

ANNEX D Position of the wireless device in relation to the phantom

D.1 Limb-worn device

A limb-worn device is a unit whose intended use includes being strapped to the arm or leg of the user while transmitting (except in idle mode). It is similar to a body-worn device. Therefore, the test positions of 6.1.4.4 also apply. The strap shall be opened so that it is divided into two parts as shown in Figure 10. The device shall be positioned directly against the phantom surface with the strap straightened as much as possible and the back of the device towards the phantom.

If the strap cannot normally be opened to allow placing in direct contact with the phantom surface, it may be necessary to break the strap of the device but ensuring to not damage the antenna.

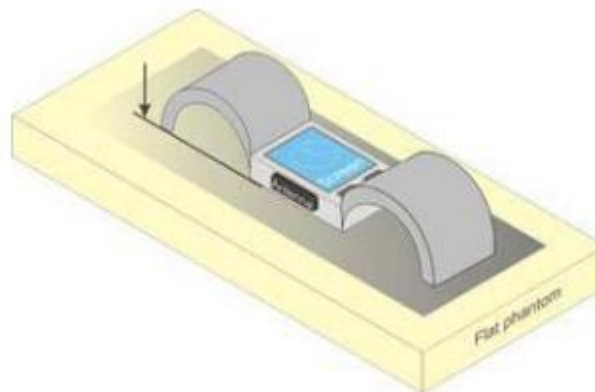

Picture D.1 Test position for limb-worn devices

D.2 Front-of-face device

A typical example of a front-of-face device is a two-way radio that is held at a distance from the face of the user when transmitting. In these cases the device under test shall be positioned at the distance to the phantom surface that corresponds to the intended use as specified by the manufacturer in the user instructions (Figure 9a). If the intended use is not specified, a separation distance of 25 mm⁵ between the phantom surface and the device shall be used.

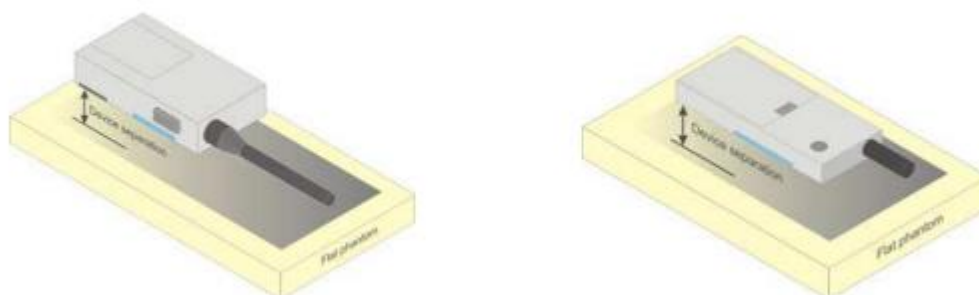

Picture D.2 Test position for front-of-face devices

D.3 DUT Setup Photos

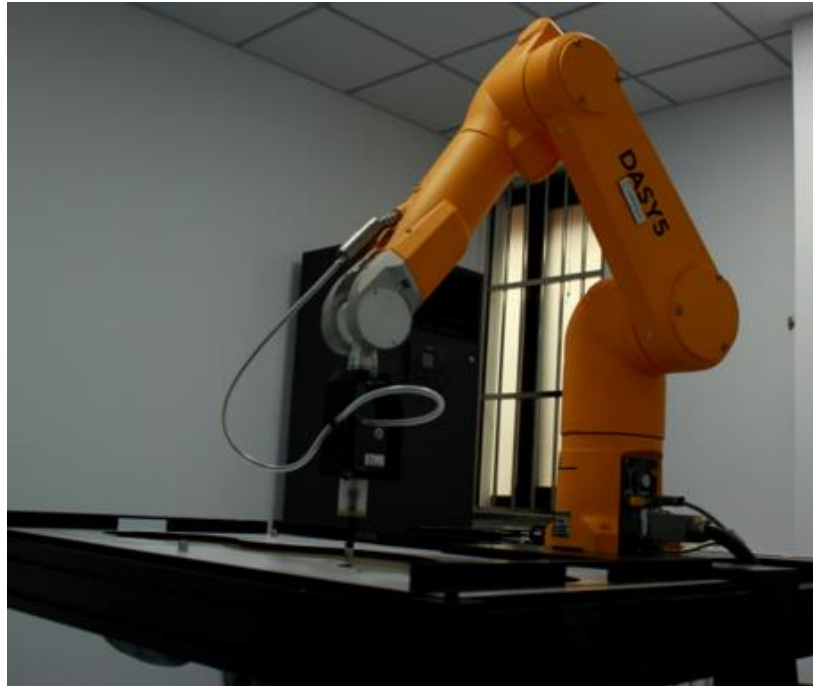

Picture D.3

ANNEX E Equivalent Media Recipes

The liquid used for the frequency range of 800-3000 MHz consisted of water, sugar, salt, preventol, glycol monobutyl and Cellulose. The liquid has been previously proven to be suited for worst-case. The Table E.1 shows the detail solution. It's satisfying the latest tissue dielectric parameters requirements proposed by the IEEE 1528 and IEC 62209.

TableE.1: Composition of the Tissue Equivalent Matter

| Frequency (MHz) | 835Head | 835Body | 1900 Head | 1900 Body | 2450 Head | 2450 Body | 5800 Head | 5800 Body |
|------------------------------------|----------------------------------|----------------------------------|----------------------------------|----------------------------------|----------------------------------|----------------------------------|----------------------------------|----------------------------------|
| Ingredients (% by weight) | | | | | | | | |
| Water | 41.45 | 52.5 | 55.242 | 69.91 | 58.79 | 72.60 | 65.53 | 65.53 |
| Sugar | 56.0 | 45.0 | \ | \ | \ | \ | \ | \ |
| Salt | 1.45 | 1.4 | 0.306 | 0.13 | 0.06 | 0.18 | \ | \ |
| Preventol | 0.1 | 0.1 | \ | \ | \ | \ | \ | \ |
| Cellulose | 1.0 | 1.0 | \ | \ | \ | \ | \ | \ |
| Glycol Monobutyl | \ | \ | 44.452 | 29.96 | 41.15 | 27.22 | \ | \ |
| Diethylenglycol monohexylether | \ | \ | \ | \ | \ | \ | 17.24 | 17.24 |
| Triton X-100 | \ | \ | \ | \ | \ | \ | 17.24 | 17.24 |
| Dielectric Parameters Target Value | $\epsilon=41.5$ $\sigma=0.90$ | $\epsilon=55.2$ $\sigma=0.97$ | $\epsilon=40.0$ $\sigma=1.40$ | $\epsilon=53.3$ $\sigma=1.52$ | $\epsilon=39.2$ $\sigma=1.80$ | $\epsilon=52.7$ $\sigma=1.95$ | $\epsilon=35.3$ $\sigma=5.27$ | $\epsilon=48.2$ $\sigma=6.00$ |

Note: There are a little adjustment respectively for 750, 1750, 2600, 5200, 5300 and 5600 based on the recipe of closest frequency in table E.1.

ANNEX F System Validation

The SAR system must be validated against its performance specifications before it is deployed. When SAR probes, system components or software are changed, upgraded or recalibrated, these must be validated with the SAR system(s) that operates with such components.

Table F.1: System Validation for 7600

| Probe SN. | Liquid name | Validation date | Frequency point | Status (OK or Not) |
|-----------|--------------|------------------|-----------------|--------------------|
| 7600 | Head 750MHz | December 2, 2020 | 750 MHz | OK |
| 7600 | Head 900MHz | December 2, 2020 | 900 MHz | OK |
| 7600 | Head 1450MHz | December 3, 2020 | 1450 MHz | OK |
| 7600 | Head 1640MHz | December 3, 2020 | 1640 MHz | OK |
| 7600 | Head 1750MHz | December 3, 2020 | 1750 MHz | OK |
| 7600 | Head 1900MHz | December 4, 2020 | 1900 MHz | OK |
| 7600 | Head 2000MHz | December 4, 2020 | 2000 MHz | OK |
| 7600 | Head 2300MHz | December 4, 2020 | 2300 MHz | OK |
| 7600 | Head 2450MHz | December 5, 2020 | 2450 MHz | OK |
| 7600 | Head 2600MHz | December 5, 2020 | 2600 MHz | OK |
| 7600 | Head 3300MHz | December 6, 2020 | 3300 MHz | OK |
| 7600 | Head 3500MHz | December 6, 2020 | 3500 MHz | OK |
| 7600 | Head 3700MHz | December 6, 2020 | 3700 MHz | OK |
| 7600 | Head 3900MHz | December 7, 2020 | 3900 MHz | OK |
| 7600 | Head 4100MHz | December 7, 2020 | 4100MHz | OK |
| 7600 | Head 4200MHz | December 7, 2020 | 4200MHz | OK |
| 7600 | Head 4400MHz | December 8, 2020 | 4400MHz | OK |
| 7600 | Head 4600MHz | December 8, 2020 | 4600MHz | OK |
| 7600 | Head 4800MHz | December 8, 2020 | 4800MHz | OK |
| 7600 | Head 4950MHz | December 8, 2020 | 4950MHz | OK |
| 7600 | Head 5250MHz | December 9, 2020 | 5250MHz | OK |
| 7600 | Head 5600MHz | December 9, 2020 | 5600 MHz | OK |
| 7600 | Head 5750MHz | December 9, 2020 | 5750 MHz | OK |



No.I201Z61402-SEM01

ANNEX G Probe Calibration Certificate

Probe 7600 Calibration Certificate



In Collaboration with
s p e a g
CALIBRATION LABORATORY



中国认可
国际互认
校准
CALIBRATION
CNAS L0570

Add: No.51 Xueyuan Road, Haidian District, Beijing, 100191, China
Tel: +86-10-62304633-2512 Fax: +86-10-62304633-2504
E-mail: cttl@chinattl.com [Http://www.chinattl.cn](http://www.chinattl.cn)

Client

CTTL

Certificate No: **Z20-60421**

| CALIBRATION CERTIFICATE | | | |
|---|---|--|-----------------------|
| Object | EX3DV4 - SN : 7600 | | |
| Calibration Procedure(s) | FF-Z11-004-02 Calibration Procedures for Dosimetric E-field Probes | | |
| Calibration date: | November 30, 2020 | | |
| This calibration Certificate documents the traceability to national standards, which realize the physical units of measurements(SI). The measurements and the uncertainties with confidence probability are given on the following pages and are part of the certificate. | | | |
| All calibrations have been conducted in the closed laboratory facility: environment temperature(22±3)°C and humidity<70%. | | | |
| Calibration Equipment used (M&TE critical for calibration) | | | |
| Primary Standards | ID # | Cal Date(Calibrated by, Certificate No.) | Scheduled Calibration |
| Power Meter NRP2 | 101919 | 16-Jun-20(CTTL, No.J20X04344) | Jun-21 |
| Power sensor NRP-Z91 | 101547 | 16-Jun-20(CTTL, No.J20X04344) | Jun-21 |
| Power sensor NRP-Z91 | 101548 | 16-Jun-20(CTTL, No.J20X04344) | Jun-21 |
| Reference 10dBAttenuator | 18N50W-10dB | 10-Feb-20(CTTL, No.J20X00525) | Feb-22 |
| Reference 20dBAttenuator | 18N50W-20dB | 10-Feb-20(CTTL, No.J20X00526) | Feb-22 |
| Reference Probe EX3DV4 | SN 7307 | 29-May-20(SPEAG, No.EX3-7307_May20) | May-21 |
| DAE4 | SN 1556 | 4-Feb-20(SPEAG, No.DAE4-1556_Feb20) | Feb-21 |
| Secondary Standards | ID # | Cal Date(Calibrated by, Certificate No.) | Scheduled Calibration |
| SignalGenerator MG3700A | 6201052605 | 23-Jun-20(CTTL, No.J20X04343) | Jun-21 |
| Network Analyzer E5071C | MY46110673 | 10-Feb-20(CTTL, No.J20X00515) | Feb-21 |
| Calibrated by: | Name Yu Zongying | Function SAR Test Engineer | Signature |
| Reviewed by: | Lin Hao | SAR Test Engineer | |
| Approved by: | Qi Dianyuan | SAR Project Leader | |
| Issued: December 02, 2020 | | | |
| This calibration certificate shall not be reproduced except in full without written approval of the laboratory. | | | |

Certificate No: Z20-60421

Page 1 of 9



Add: No.51 Xueyuan Road, Haidian District, Beijing, 100191, China
 Tel: +86-10-62304633-2512 Fax: +86-10-62304633-2504
 E-mail: cttl@chinattl.com [Http://www.chinattl.cn](http://www.chinattl.cn)

Glossary:

| | |
|-----------------------|--|
| TSL | tissue simulating liquid |
| NORM _{x,y,z} | sensitivity in free space |
| ConvF | sensitivity in TSL / NORM _{x,y,z} |
| DCP | diode compression point |
| CF | crest factor (1/duty_cycle) of the RF signal |
| A,B,C,D | modulation dependent linearization parameters |
| Polarization Φ | Φ rotation around probe axis |
| Polarization θ | θ rotation around an axis that is in the plane normal to probe axis (at measurement center), $\theta=0$ is normal to probe axis |

Connector Angle information used in DASY system to align probe sensor X to the robot coordinate system

Calibration is Performed According to the Following Standards:

- IEEE Std 1528-2013, "IEEE Recommended Practice for Determining the Peak Spatial-Averaged Specific Absorption Rate (SAR) in the Human Head from Wireless Communications Devices: Measurement Techniques", June 2013
- IEC 62209-1, "Measurement procedure for the assessment of Specific Absorption Rate (SAR) from hand-held and body-mounted devices used next to the ear (frequency range of 300 MHz to 6 GHz)", July 2016
- IEC 62209-2, "Procedure to determine the Specific Absorption Rate (SAR) for wireless communication devices used in close proximity to the human body (frequency range of 30 MHz to 6 GHz)", March 2010
- KDB 865664, "SAR Measurement Requirements for 100 MHz to 6 GHz"

Methods Applied and Interpretation of Parameters:

- NORM_{x,y,z}:** Assessed for E-field polarization $\theta=0$ ($f \leq 900\text{MHz}$ in TEM-cell; $f > 1800\text{MHz}$: waveguide). NORM_{x,y,z} are only intermediate values, i.e., the uncertainties of NORM_{x,y,z} does not effect the E^2 -field uncertainty inside TSL (see below ConvF).
- NORM(f)_{x,y,z} = NORM_{x,y,z} * frequency_response** (see Frequency Response Chart). This linearization is implemented in DASY4 software versions later than 4.2. The uncertainty of the frequency response is included in the stated uncertainty of ConvF.
- DCP_{x,y,z}:** DCP are numerical linearization parameters assessed based on the data of power sweep (no uncertainty required). DCP does not depend on frequency nor media.
- PAR:** PAR is the Peak to Average Ratio that is not calibrated but determined based on the signal characteristics.
- A_{x,y,z}; B_{x,y,z}; C_{x,y,z}; VR_{x,y,z}; A,B,C** are numerical linearization parameters assessed based on the data of power sweep for specific modulation signal. The parameters do not depend on frequency nor media. VR is the maximum calibration range expressed in RMS voltage across the diode.
- ConvF and Boundary Effect Parameters:** Assessed in flat phantom using E-field (or Temperature Transfer Standard for $f \leq 800\text{MHz}$) and inside waveguide using analytical field distributions based on power measurements for $f > 800\text{MHz}$. The same setups are used for assessment of the parameters applied for boundary compensation (alpha, depth) of which typical uncertainty valued are given. These parameters are used in DASY4 software to improve probe accuracy close to the boundary. The sensitivity in TSL corresponds to NORM_{x,y,z} * ConvF whereby the uncertainty corresponds to that given for ConvF. A frequency dependent ConvF is used in DASY version 4.4 and higher which allows extending the validity from $\pm 50\text{MHz}$ to $\pm 100\text{MHz}$.
- Spherical isotropy (3D deviation from isotropy):** in a field of low gradients realized using a flat phantom exposed by a patch antenna.
- Sensor Offset:** The sensor offset corresponds to the offset of virtual measurement center from the probe tip (on probe axis). No tolerance required.
- Connector Angle:** The angle is assessed using the information gained by determining the NORM_x (no uncertainty required).

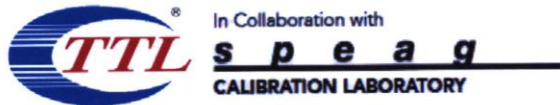

Add: No.51 Xueyuan Road, Haidian District, Beijing, 100191, China
Tel: +86-10-62304633-2512 Fax: +86-10-62304633-2504
E-mail: cttl@chinattl.com [Http://www.chinattl.cn](http://www.chinattl.cn)

DASY/EASY – Parameters of Probe: EX3DV4 – SN:7600

Basic Calibration Parameters

| | Sensor X | Sensor Y | Sensor Z | Unc (k=2) |
|--------------------------------------|----------|----------|----------|-----------|
| Norm($\mu V/(V/m)^2$) ^A | 0.70 | 0.65 | 0.67 | ±10.0% |
| DCP(mV) ^B | 109.4 | 109.2 | 108.7 | |

Modulation Calibration Parameters

| UID | Communication System Name | | A dB | B dB $\sqrt{\mu V}$ | C | D dB | VR mV | Unc ^E (k=2) |
|-----|---------------------------|---|------|---------------------|-----|------|-------|------------------------|
| 0 | CW | X | 0.0 | 0.0 | 1.0 | 0.00 | 225.0 | ±2.1% |
| | | Y | 0.0 | 0.0 | 1.0 | | 206.5 | |
| | | Z | 0.0 | 0.0 | 1.0 | | 212.8 | |

The reported uncertainty of measurement is stated as the standard uncertainty of Measurement multiplied by the coverage factor $k=2$, which for a normal distribution Corresponds to a coverage probability of approximately 95%.

^A The uncertainties of Norm X, Y, Z do not affect the E²-field uncertainty inside TSL (see Page 4).

^B Numerical linearization parameter: uncertainty not required.

^E Uncertainty is determined using the max. deviation from linear response applying rectangular distribution and is expressed for the square of the field value.



Add: No.51 Xueyuan Road, Haidian District, Beijing, 100191, China
 Tel: +86-10-62304633-2512 Fax: +86-10-62304633-2504
 E-mail: cttl@chinattl.com [Http://www.chinattl.cn](http://www.chinattl.cn)

DASY/EASY – Parameters of Probe: EX3DV4 – SN:7600**Calibration Parameter Determined in Head Tissue Simulating Media**

| f [MHz] ^C | Relative Permittivity ^F | Conductivity (S/m) ^F | ConvF X | ConvF Y | ConvF Z | Alpha ^G | Depth ^G (mm) | Unct. (k=2) |
|----------------------|------------------------------------|---------------------------------|---------|---------|---------|--------------------|-------------------------|-------------|
| 750 | 41.9 | 0.89 | 10.88 | 10.88 | 10.88 | 0.40 | 0.77 | ±12.1% |
| 900 | 41.5 | 0.97 | 10.45 | 10.45 | 10.45 | 0.17 | 1.31 | ±12.1% |
| 1450 | 40.5 | 1.20 | 9.28 | 9.28 | 9.28 | 0.10 | 1.40 | ±12.1% |
| 1640 | 40.3 | 1.29 | 9.10 | 9.10 | 9.10 | 0.21 | 1.03 | ±12.1% |
| 1750 | 40.1 | 1.37 | 9.01 | 9.01 | 9.01 | 0.20 | 1.11 | ±12.1% |
| 1900 | 40.0 | 1.40 | 8.70 | 8.70 | 8.70 | 0.26 | 1.03 | ±12.1% |
| 2000 | 40.0 | 1.40 | 8.68 | 8.68 | 8.68 | 0.21 | 1.16 | ±12.1% |
| 2300 | 39.5 | 1.67 | 8.19 | 8.19 | 8.19 | 0.37 | 0.88 | ±12.1% |
| 2450 | 39.2 | 1.80 | 7.79 | 7.79 | 7.79 | 0.35 | 1.00 | ±12.1% |
| 2600 | 39.0 | 1.96 | 7.67 | 7.67 | 7.67 | 0.46 | 0.80 | ±12.1% |
| 3300 | 38.2 | 2.71 | 7.35 | 7.35 | 7.35 | 0.43 | 0.95 | ±13.3% |
| 3500 | 37.9 | 2.91 | 7.01 | 7.01 | 7.01 | 0.44 | 0.94 | ±13.3% |
| 3700 | 37.7 | 3.12 | 6.77 | 6.77 | 6.77 | 0.42 | 1.02 | ±13.3% |
| 3900 | 37.5 | 3.32 | 6.85 | 6.85 | 6.85 | 0.35 | 1.30 | ±13.3% |
| 4100 | 37.2 | 3.53 | 6.75 | 6.75 | 6.75 | 0.40 | 1.15 | ±13.3% |
| 4200 | 37.1 | 3.63 | 6.65 | 6.65 | 6.65 | 0.35 | 1.35 | ±13.3% |
| 4400 | 36.9 | 3.84 | 6.54 | 6.54 | 6.54 | 0.35 | 1.35 | ±13.3% |
| 4600 | 36.7 | 4.04 | 6.39 | 6.39 | 6.39 | 0.45 | 1.25 | ±13.3% |
| 4800 | 36.4 | 4.25 | 6.34 | 6.34 | 6.34 | 0.40 | 1.42 | ±13.3% |
| 4950 | 36.3 | 4.40 | 6.01 | 6.01 | 6.01 | 0.45 | 1.30 | ±13.3% |
| 5250 | 35.9 | 4.71 | 5.68 | 5.68 | 5.68 | 0.45 | 1.30 | ±13.3% |
| 5600 | 35.5 | 5.07 | 5.11 | 5.11 | 5.11 | 0.50 | 1.25 | ±13.3% |
| 5750 | 35.4 | 5.22 | 5.07 | 5.07 | 5.07 | 0.50 | 1.25 | ±13.3% |

^C Frequency validity above 300 MHz of ±100MHz only applies for DASY v4.4 and higher (Page 2), else it is restricted to ±50MHz. The uncertainty is the RSS of ConvF uncertainty at calibration frequency and the uncertainty for the indicated frequency band. Frequency validity below 300 MHz is ± 10, 25, 40, 50 and 70 MHz for ConvF assessments at 30, 64, 128, 150 and 220 MHz respectively. Above 5 GHz frequency validity can be extended to ± 110 MHz.

^F At frequency below 3 GHz, the validity of tissue parameters (ϵ and σ) can be relaxed to ±10% if liquid compensation formula is applied to measured SAR values. At frequencies above 3 GHz, the validity of tissue parameters (ϵ and σ) is restricted to ±5%. The uncertainty is the RSS of the ConvF uncertainty for indicated target tissue parameters.

^G Alpha/Depth are determined during calibration. SPEAG warrants that the remaining deviation due to the boundary effect after compensation is always less than ± 1% for frequencies below 3 GHz and below ± 2% for the frequencies between 3-6 GHz at any distance larger than half the probe tip diameter from the boundary.

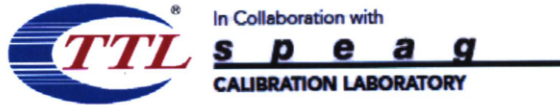

Add: No.51 Xueyuan Road, Haidian District, Beijing, 100191, China
Tel: +86-10-62304633-2512 Fax: +86-10-62304633-2504
E-mail: cttl@chinattl.com [Http://www.chinattl.cn](http://www.chinattl.cn)

Frequency Response of E-Field (TEM-Cell: ifi110 EXX, Waveguide: R22)

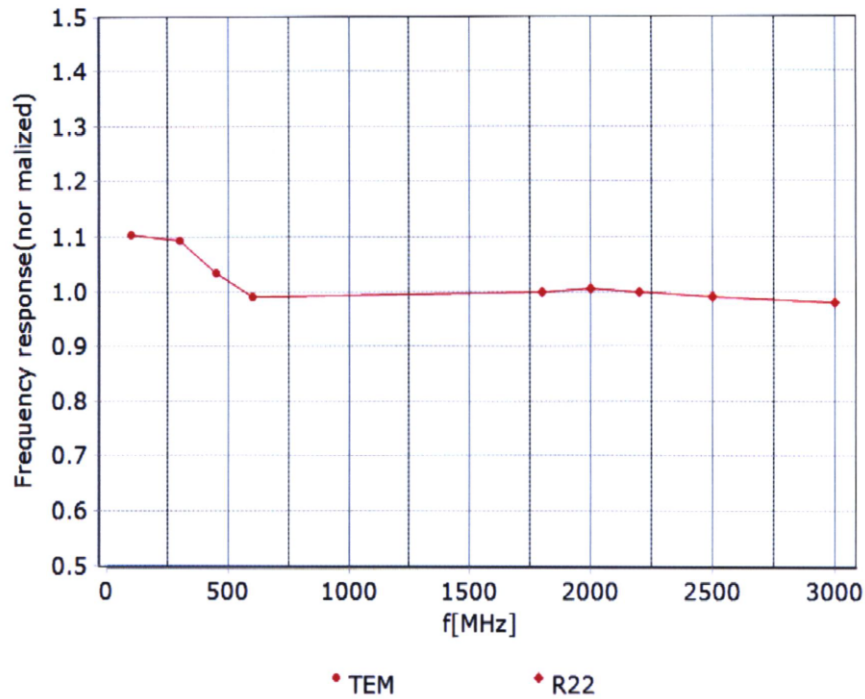

Uncertainty of Frequency Response of E-field: $\pm 7.4\%$ ($k=2$)



Add: No.51 Xueyuan Road, Haidian District, Beijing, 100191, China
 Tel: +86-10-62304633-2512 Fax: +86-10-62304633-2504
 E-mail: cttl@chinattl.com [Http://www.chinattl.cn](http://www.chinattl.cn)

Receiving Pattern (Φ), $\theta=0^\circ$

f=600 MHz, TEM

f=1800 MHz, R22

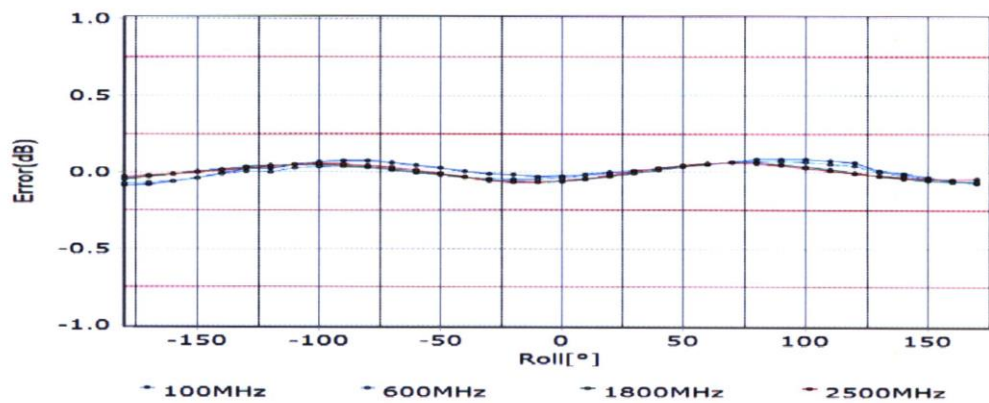
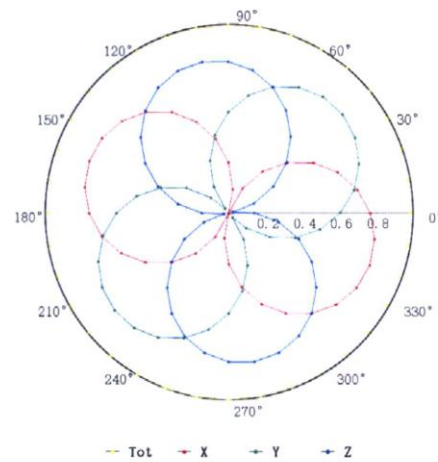
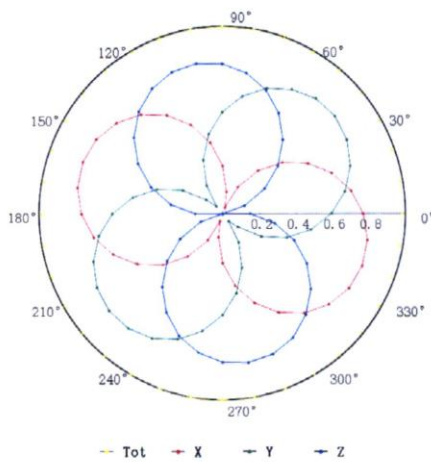

Uncertainty of Axial Isotropy Assessment: $\pm 1.2\%$ ($k=2$)



Add: No.51 Xueyuan Road, Haidian District, Beijing, 100191, China
 Tel: +86-10-62304633-2512 Fax: +86-10-62304633-2504
 E-mail: cttl@chinattl.com [Http://www.chinattl.cn](http://www.chinattl.cn)

Dynamic Range f(SAR_{head}) (TEM cell, f = 900 MHz)

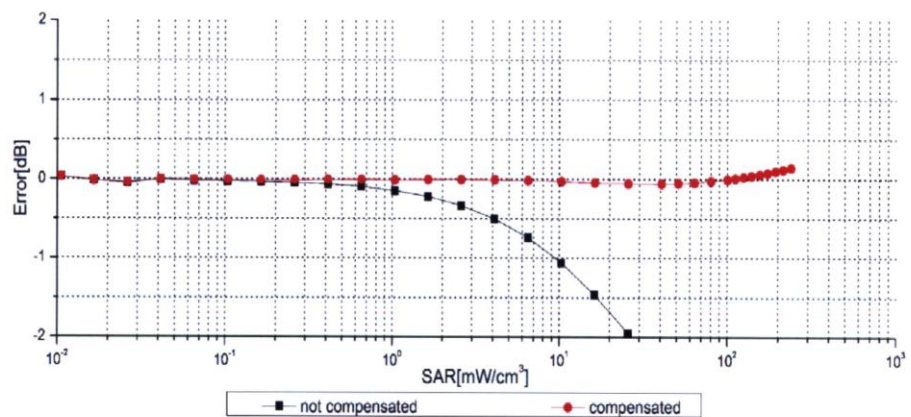
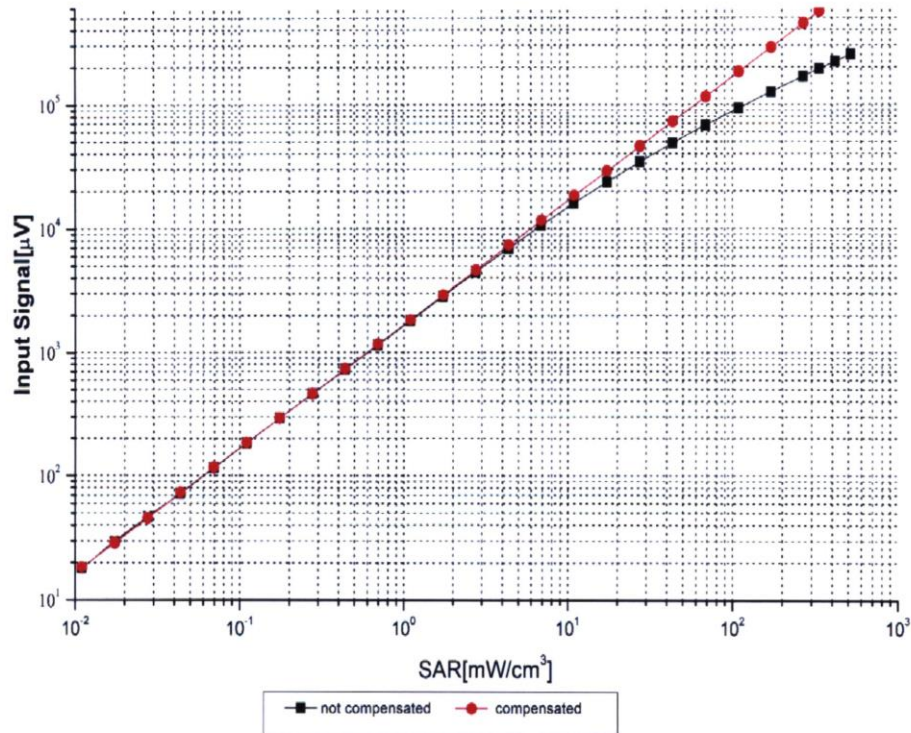

Uncertainty of Linearity Assessment: ±0.9% (k=2)



Add: No.51 Xueyuan Road, Haidian District, Beijing, 100191, China
 Tel: +86-10-62304633-2512 Fax: +86-10-62304633-2504
 E-mail: cttl@chinattl.com [Http://www.chinattl.cn](http://www.chinattl.cn)

Conversion Factor Assessment

f=750 MHz,WGLS R9(H_convF)

f=1750 MHz,WGLS R22(H_convF)

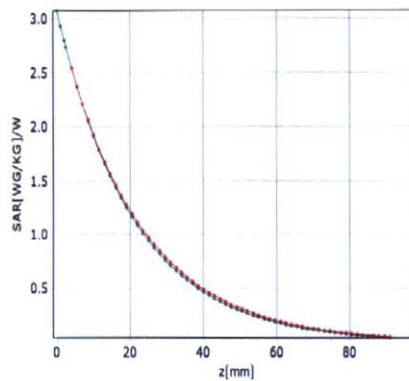

* analytical * measured

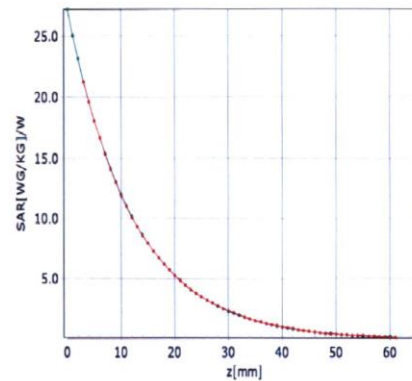

* analytical * measured

Deviation from Isotropy in Liquid

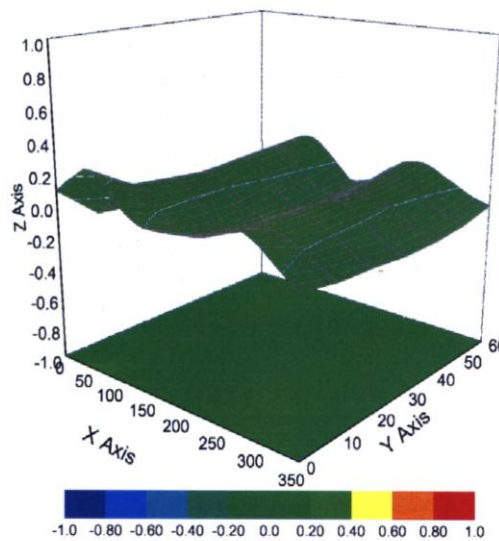

Uncertainty of Spherical Isotropy Assessment: $\pm 3.2\%$ ($k=2$)



Add: No.51 Xueyuan Road, Haidian District, Beijing, 100191, China
Tel: +86-10-62304633-2512 Fax: +86-10-62304633-2504
E-mail: cttl@chinattl.com [Http://www.chinattl.cn](http://www.chinattl.cn)

DASY/EASY – Parameters of Probe: EX3DV4 – SN:7600

Other Probe Parameters

| | |
|---|------------|
| Sensor Arrangement | Triangular |
| Connector Angle (°) | 40.7 |
| Mechanical Surface Detection Mode | enabled |
| Optical Surface Detection Mode | disable |
| Probe Overall Length | 337mm |
| Probe Body Diameter | 10mm |
| Tip Length | 10mm |
| Tip Diameter | 2.5mm |
| Probe Tip to Sensor X Calibration Point | 1mm |
| Probe Tip to Sensor Y Calibration Point | 1mm |
| Probe Tip to Sensor Z Calibration Point | 1mm |
| Recommended Measurement Distance from Surface | 1.4mm |



No.I201Z61402-SEM01

ANNEX H Dipole Calibration Certificate

2450 MHz Dipole Calibration Certificate

Calibration Laboratory of
Schmid & Partner
Engineering AG
Zeughausstrasse 43, 8004 Zurich, Switzerland



S Schweizerischer Kalibrierdienst
C Service suisse d'étalonnage
S Servizio svizzero di taratura
S Swiss Calibration Service

Accredited by the Swiss Accreditation Service (SAS)
The Swiss Accreditation Service is one of the signatories to the EA
Multilateral Agreement for the recognition of calibration certificates

Accreditation No.: SCS 0108

Client **CTTL (Auden)**

Certificate No: **D2450V2-853_Jul21**

| CALIBRATION CERTIFICATE | | | |
|--|---|-----------------------------------|------------------------|
| Object | D2450V2 - SN:853 | | |
| Calibration procedure(s) | QA CAL-05.v11 Calibration Procedure for SAR Validation Sources between 0.7-3 GHz | | |
| Calibration date: | July 26, 2021 | | |
| This calibration certificate documents the traceability to national standards, which realize the physical units of measurements (SI). The measurements and the uncertainties with confidence probability are given on the following pages and are part of the certificate. | | | |
| All calibrations have been conducted in the closed laboratory facility: environment temperature (22 ± 3)°C and humidity < 70%. | | | |
| Calibration Equipment used (M&TE critical for calibration) | | | |
| Primary Standards | ID # | Cal Date (Certificate No.) | Scheduled Calibration |
| Power meter NRP | SN: 104778 | 09-Apr-21 (No. 217-03291/03292) | Apr-22 |
| Power sensor NRP-Z91 | SN: 103244 | 09-Apr-21 (No. 217-03291) | Apr-22 |
| Power sensor NRP-Z91 | SN: 103245 | 09-Apr-21 (No. 217-03292) | Apr-22 |
| Reference 20 dB Attenuator | SN: BH9394 (20k) | 09-Apr-21 (No. 217-03343) | Apr-22 |
| Type-N mismatch combination | SN: 310982 / 06327 | 09-Apr-21 (No. 217-03344) | Apr-22 |
| Reference Probe EX3DV4 | SN: 7349 | 28-Dec-20 (No. EX3-7349_Dec20) | Dec-21 |
| DAE4 | SN: 601 | 02-Nov-20 (No. DAE4-601_Nov20) | Nov-21 |
| Secondary Standards | ID # | Check Date (in house) | Scheduled Check |
| Power meter E4419B | SN: GB39512475 | 30-Oct-14 (in house check Oct-20) | In house check: Oct-22 |
| Power sensor HP 8481A | SN: US37292783 | 07-Oct-15 (in house check Oct-20) | In house check: Oct-22 |
| Power sensor HP 8481A | SN: MY41092317 | 07-Oct-15 (in house check Oct-20) | In house check: Oct-22 |
| RF generator R&S SMT-06 | SN: 100972 | 15-Jun-15 (in house check Oct-20) | In house check: Oct-22 |
| Network Analyzer Agilent E8358A | SN: US41080477 | 31-Mar-14 (in house check Oct-20) | In house check: Oct-21 |
| Calibrated by: | Name Michael Weber | Function Laboratory Technician | Signature |
| Approved by: | Name Katja Pokovic | Function Technical Manager | Signature |
| This calibration certificate shall not be reproduced except in full without written approval of the laboratory. | | | Issued: July 26, 2021 |

Certificate No: D2450V2-853_Jul21

Page 1 of 6

Calibration Laboratory of
Schmid & Partner
Engineering AG
Zeughausstrasse 43, 8004 Zurich, Switzerland



S Schweizerischer Kalibrierdienst
C Service suisse d'étalonnage
S Servizio svizzero di taratura
S Swiss Calibration Service

Accredited by the Swiss Accreditation Service (SAS)
The Swiss Accreditation Service is one of the signatories to the EA
Multilateral Agreement for the recognition of calibration certificates

Accreditation No.: **SCS 0108**

Glossary:

| | |
|-------|---------------------------------|
| TSL | tissue simulating liquid |
| ConvF | sensitivity in TSL / NORM x,y,z |
| N/A | not applicable or not measured |

Calibration is Performed According to the Following Standards:

- IEC/IEEE 62209-1528, "Measurement Procedure For The Assessment Of Specific Absorption Rate Of Human Exposure To Radio Frequency Fields From Hand-Held And Body-Worn Wireless Communication Devices - Part 1528: Human Models, Instrumentation And Procedures (Frequency Range of 4 MHz to 10 GHz)", October 2020.
- KDB 865664, "SAR Measurement Requirements for 100 MHz to 6 GHz"

Additional Documentation:

- DASY System Handbook

Methods Applied and Interpretation of Parameters:

- Measurement Conditions:* Further details are available from the Validation Report at the end of the certificate. All figures stated in the certificate are valid at the frequency indicated.
- Antenna Parameters with TSL:* The source is mounted in a touch configuration below the center marking of the flat phantom.
- Return Loss:* This parameter is measured with the source positioned under the liquid filled phantom (as described in the measurement condition clause). The Return Loss ensures low reflected power. No uncertainty required.
- SAR measured:* SAR measured at the stated antenna input power.
- SAR normalized:* SAR as measured, normalized to an input power of 1 W at the antenna connector.
- SAR for nominal TSL parameters:* The measured TSL parameters are used to calculate the nominal SAR result.

The reported uncertainty of measurement is stated as the standard uncertainty of measurement multiplied by the coverage factor $k=2$, which for a normal distribution corresponds to a coverage probability of approximately 95%.

Measurement Conditions

DASYS system configuration, as far as not given on page 1.

| | | |
|-------------------------------------|------------------------|-------------|
| DASY Version | DASY52 | V52.10.4 |
| Extrapolation | Advanced Extrapolation | |
| Phantom | Modular Flat Phantom | |
| Distance Dipole Center - TSL | 10 mm | with Spacer |
| Zoom Scan Resolution | dx, dy, dz = 5 mm | |
| Frequency | 2450 MHz \pm 1 MHz | |

Head TSL parameters

The following parameters and calculations were applied.

| | Temperature | Permittivity | Conductivity |
|--|---------------------|---------------------|----------------------|
| Nominal Head TSL parameters | 22.0 °C | 39.2 | 1.80 mho/m |
| Measured Head TSL parameters | (22.0 \pm 0.2) °C | 37.9 \pm 6 % | 1.88 mho/m \pm 6 % |
| Head TSL temperature change during test | < 0.5 °C | ---- | ---- |

SAR result with Head TSL

| SAR averaged over 1 cm³ (1 g) of Head TSL | Condition | |
|---|--------------------|--|
| SAR measured | 250 mW input power | 13.7 W/kg |
| SAR for nominal Head TSL parameters | normalized to 1W | 53.3 W/kg \pm 17.0 % (k=2) |

| SAR averaged over 10 cm³ (10 g) of Head TSL | condition | |
|---|--------------------|--|
| SAR measured | 250 mW input power | 6.33 W/kg |
| SAR for nominal Head TSL parameters | normalized to 1W | 24.9 W/kg \pm 16.5 % (k=2) |

**Appendix (Additional assessments outside the scope of SCS 0108)****Antenna Parameters with Head TSL**

| | |
|--------------------------------------|--------------------------------|
| Impedance, transformed to feed point | 53.6 Ω + 3.8 j Ω |
| Return Loss | - 25.9 dB |

General Antenna Parameters and Design

| | |
|----------------------------------|----------|
| Electrical Delay (one direction) | 1.164 ns |
|----------------------------------|----------|

After long term use with 100W radiated power, only a slight warming of the dipole near the feedpoint can be measured.

The dipole is made of standard semirigid coaxial cable. The center conductor of the feeding line is directly connected to the second arm of the dipole. The antenna is therefore short-circuited for DC-signals. On some of the dipoles, small end caps are added to the dipole arms in order to improve matching when loaded according to the position as explained in the "Measurement Conditions" paragraph. The SAR data are not affected by this change. The overall dipole length is still according to the Standard.

No excessive force must be applied to the dipole arms, because they might bend or the soldered connections near the feedpoint may be damaged.

Additional EUT Data

| | |
|-----------------|-------|
| Manufactured by | SPEAG |
|-----------------|-------|

DASY5 Validation Report for Head TSL

Date: 26.07.2021

Test Laboratory: SPEAG, Zurich, Switzerland

DUT: Dipole 2450 MHz; Type: D2450V2; Serial: D2450V2 - SN: 853

Communication System: UID 0 - CW; Frequency: 2450 MHz
Medium parameters used: $f = 2450$ MHz; $\sigma = 1.88$ S/m; $\epsilon_r = 37.9$; $\rho = 1000$ kg/m³
Phantom section: Flat Section
Measurement Standard: DASY5 (IEEE/IEC/ANSI C63.19-2011)

DASY52 Configuration:

- Probe: EX3DV4 - SN7349; ConvF(7.96, 7.96, 7.96) @ 2450 MHz; Calibrated: 28.12.2020
- Sensor-Surface: 1.4mm (Mechanical Surface Detection)
- Electronics: DAE4 Sn601; Calibrated: 02.11.2020
- Phantom: Flat Phantom 5.0 (front); Type: QD 000 P50 AA; Serial: 1001
- DASY52 52.10.4(1535); SEMCAD X 14.6.14(7501)

Dipole Calibration for Head Tissue/Pin=250 mW, d=10mm/Zoom Scan (7x7x7)/Cube 0:

Measurement grid: dx=5mm, dy=5mm, dz=5mm
Reference Value = 116.2 V/m; Power Drift = 0.09 dB
Peak SAR (extrapolated) = 27.4 W/kg
SAR(1 g) = 13.7 W/kg; SAR(10 g) = 6.33 W/kg
Smallest distance from peaks to all points 3 dB below = 9 mm
Ratio of SAR at M2 to SAR at M1 = 50%
Maximum value of SAR (measured) = 22.7 W/kg

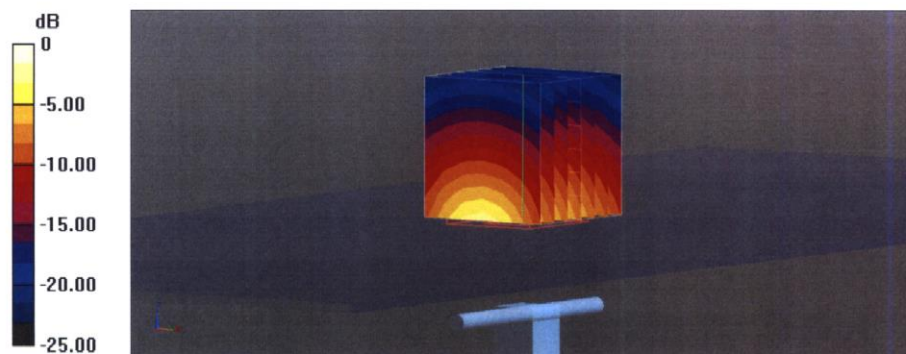

0 dB = 22.7 W/kg = 13.56 dBW/kg

Impedance Measurement Plot for Head TSL

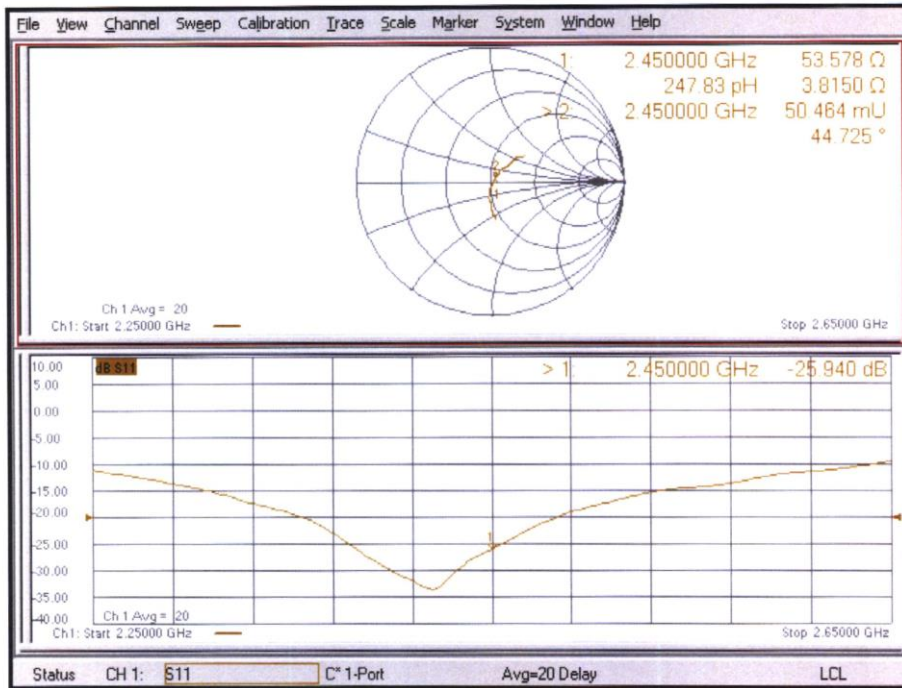

ANNEX I Accreditation Certificate

| | |
|---|--|
| United States Department of Commerce National Institute of Standards and Technology | |
|   | |
| <hr/> Certificate of Accreditation to ISO/IEC 17025:2017 <hr/> | |
| NVLAP LAB CODE: 600118-0 | |
| Telecommunication Technology Labs, CAICT Beijing China | |
| <i>is accredited by the National Voluntary Laboratory Accreditation Program for specific services, listed on the Scope of Accreditation, for:</i> | |
| Electromagnetic Compatibility & Telecommunications | |
| <i>This laboratory is accredited in accordance with the recognized International Standard ISO/IEC 17025:2017. This accreditation demonstrates technical competence for a defined scope and the operation of a laboratory quality management system (refer to joint ISO-ILAC-IAF Communique dated January 2009).</i> | |
| <hr/> 2020-09-29 through 2021-09-30 Effective Dates |   For the National Voluntary Laboratory Accreditation Program |