



**Test Results:**

The modulation and bandwidth are similar for 802.11n mode for 20MHz/40MHz and 802.11ac mode for V20MHz/V40MHz, therefore investigated worst case to representative mode in test report.

**The signal beyond the limit is carrier.**

**U-NII-1**

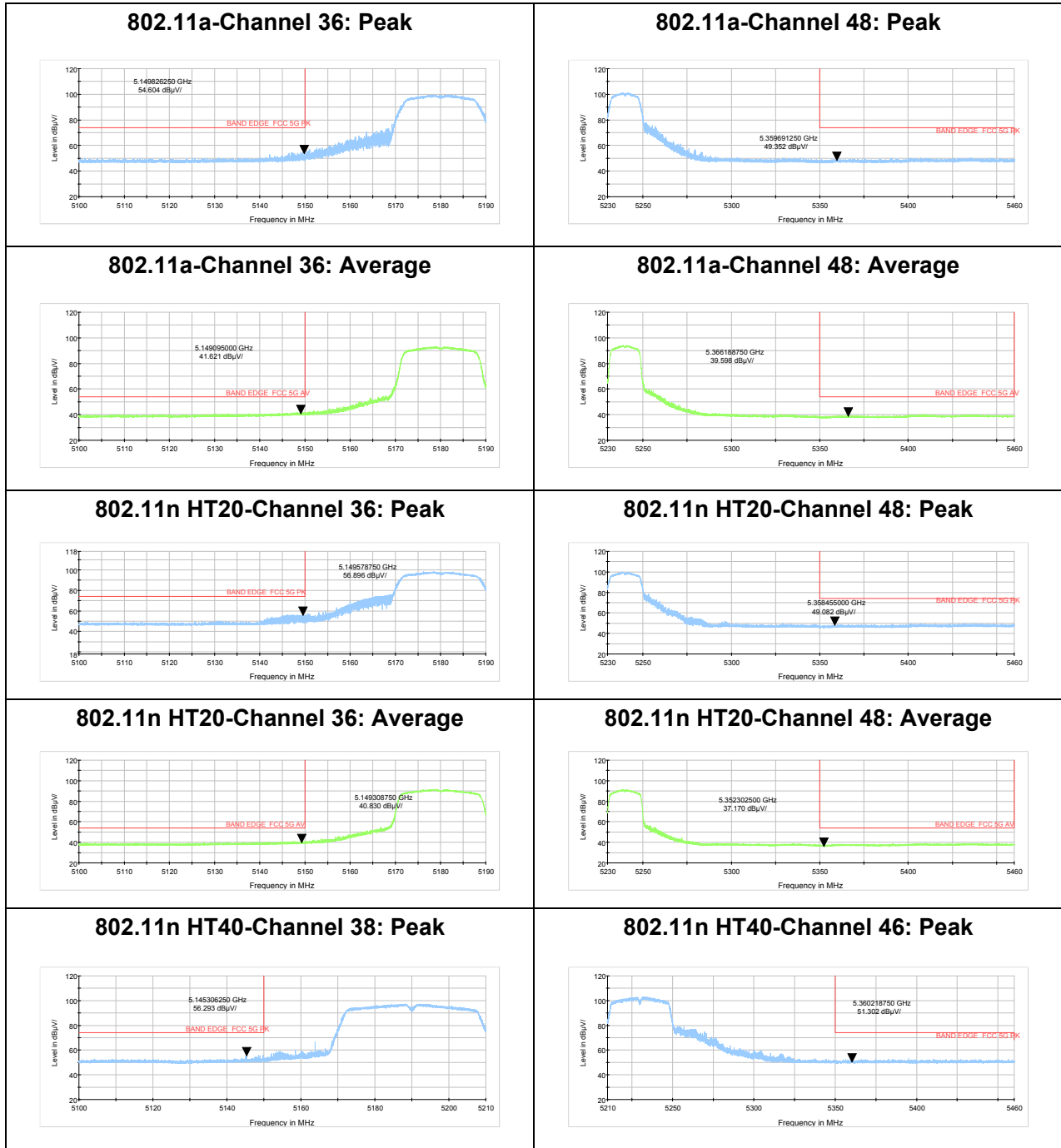



### 802.11n HT40-Channel 38: Average

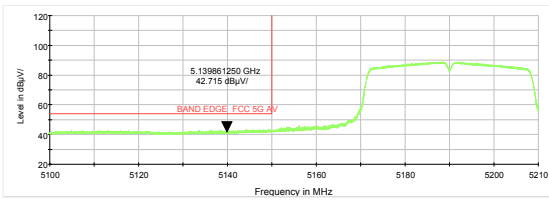

### 802.11n HT40-Channel 46: Average

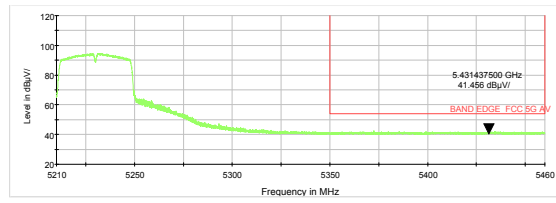

### 802.11ac VHT80 -Channel 42: Peak

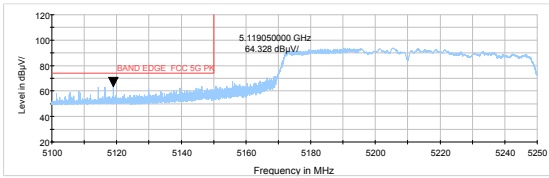

### 802.11ac VHT80- Channel 42: Average

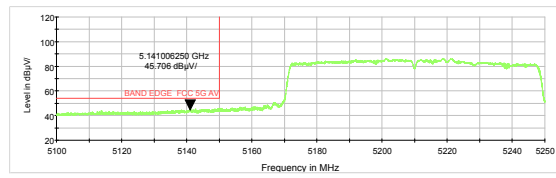



U-NII-2A

802.11a-Channel 52: Peak

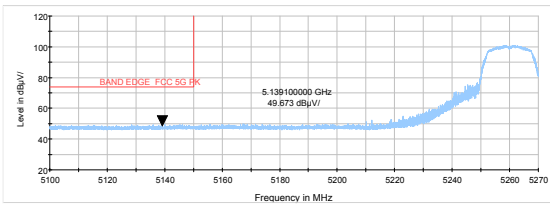

802.11a-Channel 64: Peak

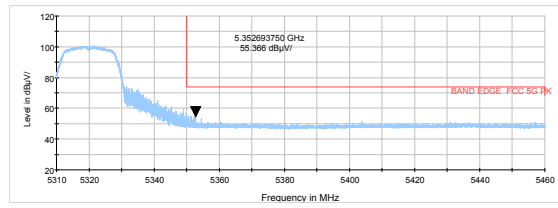

802.11a-Channel 52: Average

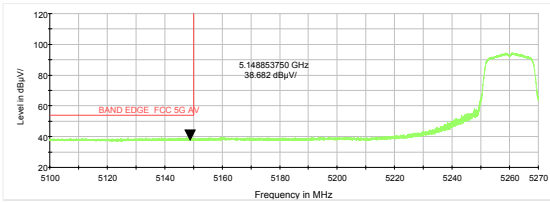

802.11a-Channel 64: Average

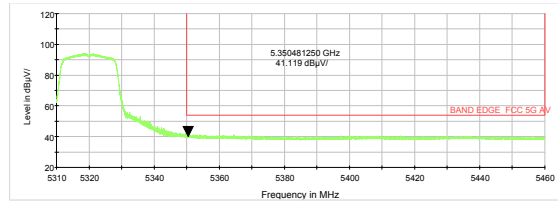

802.11n HT20-Channel 52: Peak

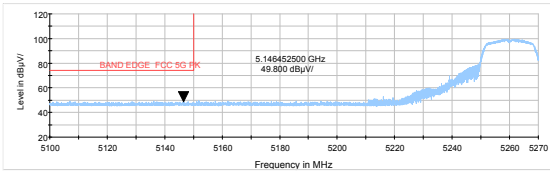

802.11n HT20-Channel 64: Peak

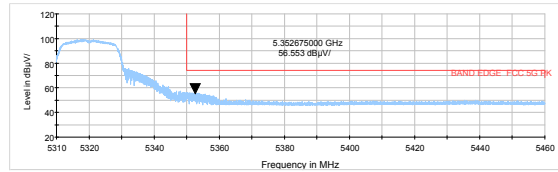

802.11n HT20-Channel 52: Average

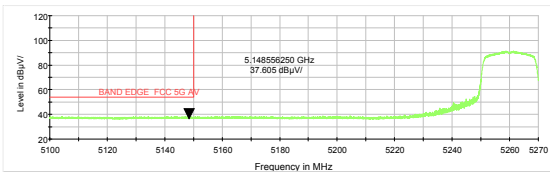

802.11n HT20-Channel 64: Average

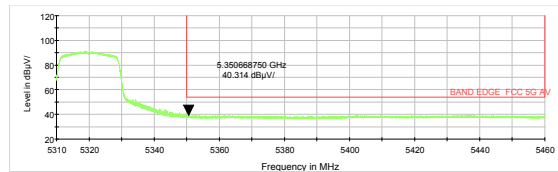

802.11n HT40-Channel 54: Peak

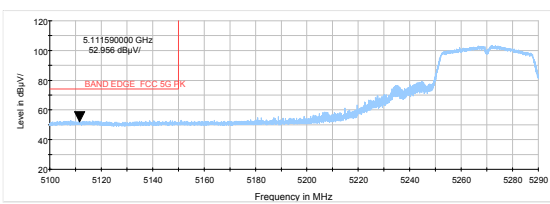

802.11n HT40-Channel 62: Peak

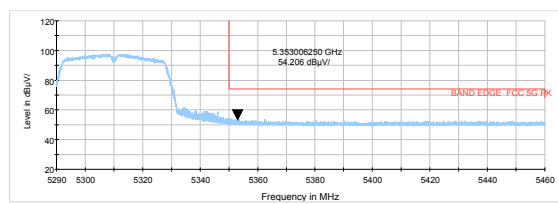

802.11n HT40-Channel 54: Average

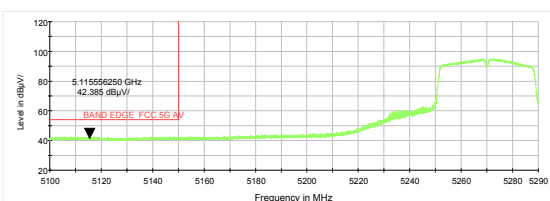

802.11n HT40-Channel 62: Average

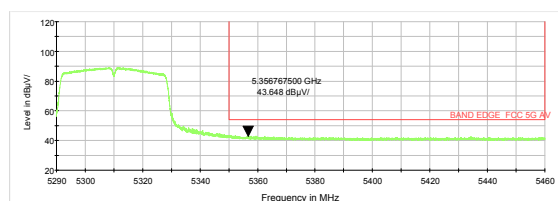



### 802.11ac VHT80 –Channel 58: Peak

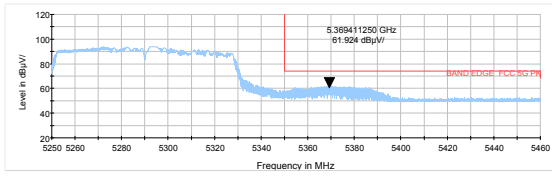

### 802.11ac VHT80- Channel 58: Average

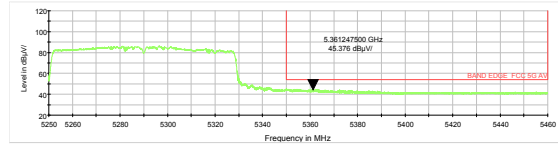



U-NII-2C

802.11a-Channel 100: Peak

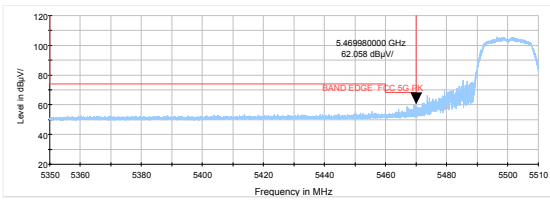

802.11n HT20-Channel 100: Peak

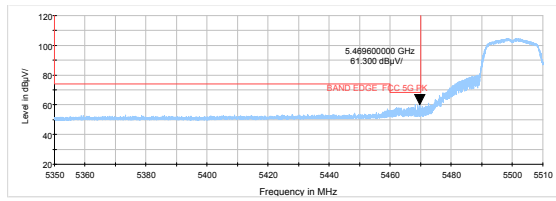

802.11a-Channel 100: Average

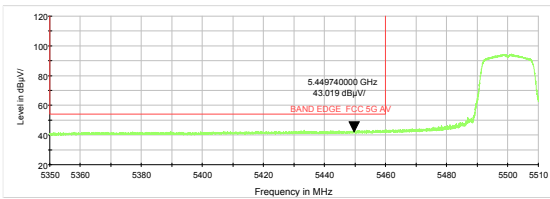

802.11n HT20-Channel 100: Average

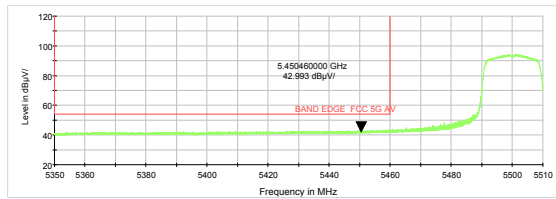

802.11a-Channel 140: Peak

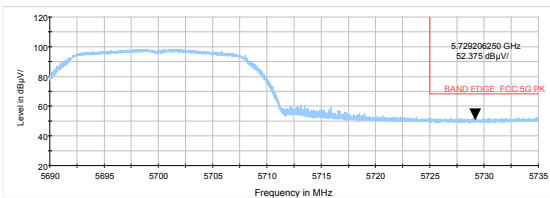

802.11n HT20-Channel 140: Peak

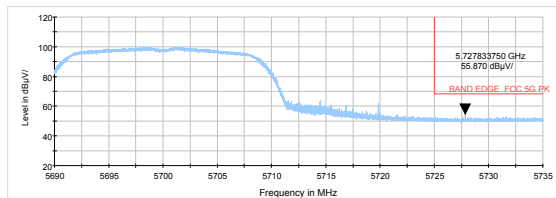

802.11n HT40-Channel 102: Peak

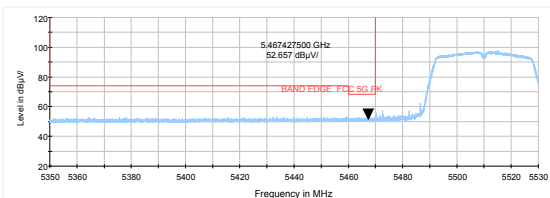

802.11ac VHT80 -Channel 106: Peak

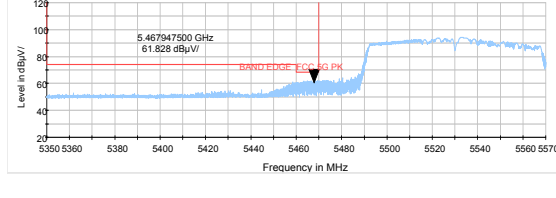

802.11n HT40-Channel 102: Average

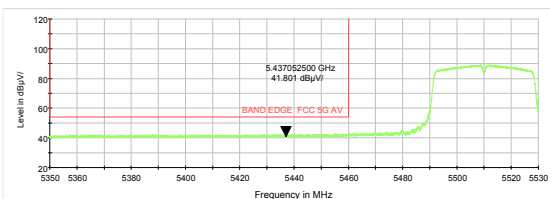

802.11ac VHT80- Channel 106: Average

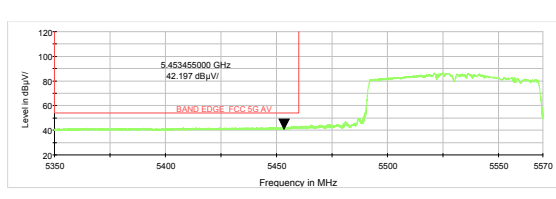

802.11n HT40-Channel 134: Peak

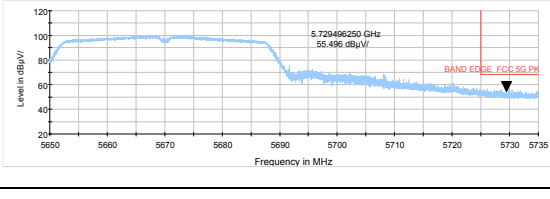

802.11ac VHT80 -Channel 122: Peak

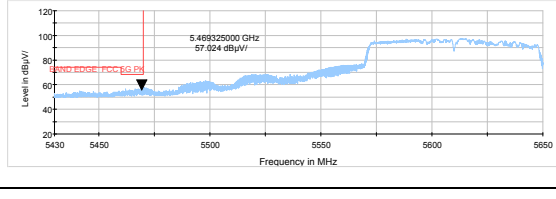



U-NII-3

802.11a-Channel 149: Peak

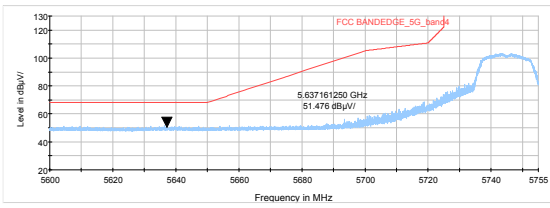

802.11a-Channel 165: Peak

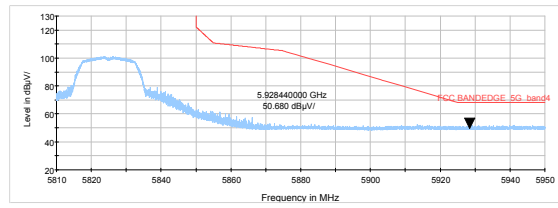

802.11n HT20-Channel 149: Peak

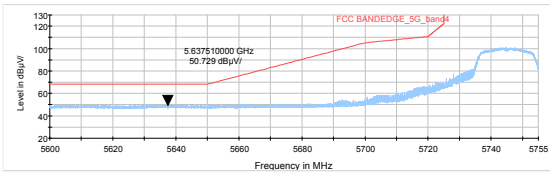

802.11n HT20-Channel 165: Peak

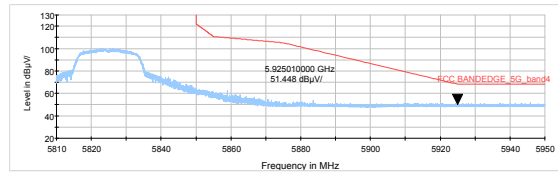

802.11n HT40-Channel 151: Peak

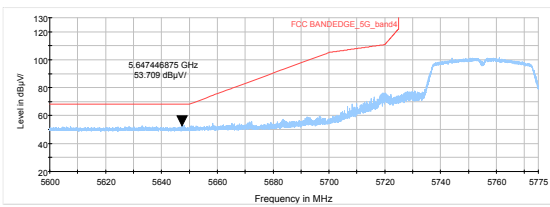

802.11n HT40-Channel 159: Peak

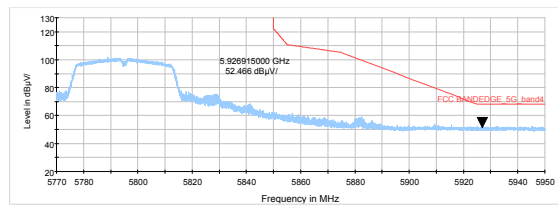

802.11ac VHT80- Channel 155: Peak

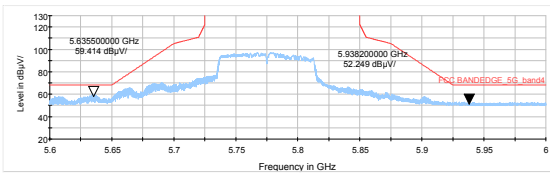

**Result of RE**

**Test result**

During the test, the Radiates Emission from 30MHz to 1GHz was performed in all modes with all channels, 802.11ac (HT80) CH155 are selected as the worst condition. The test data of the worst-case condition was recorded in this report.

**Continuous TX mode:**

FCC RE 9K-90KHz AV

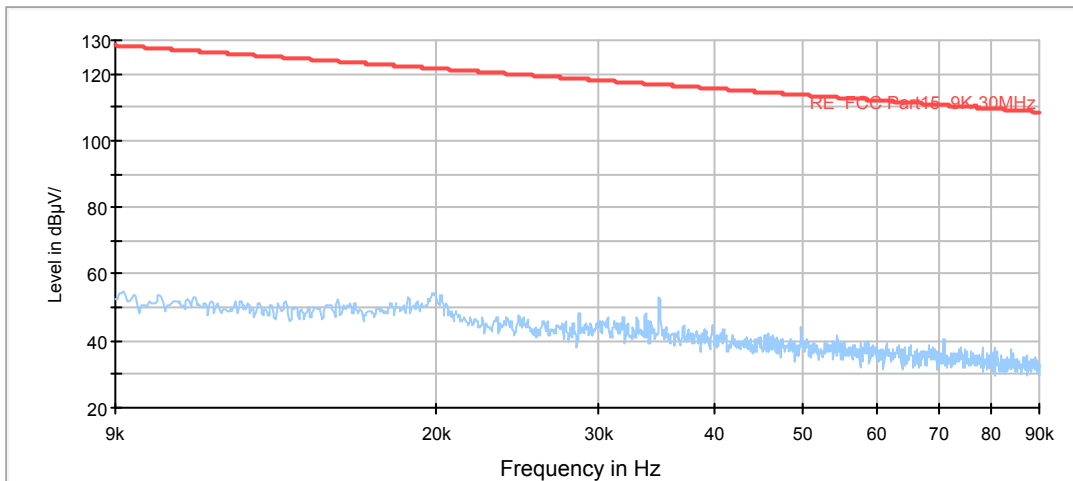

Radiates Emission from 9KHz to 90KHz

FCC RE 90K-110KHz QP

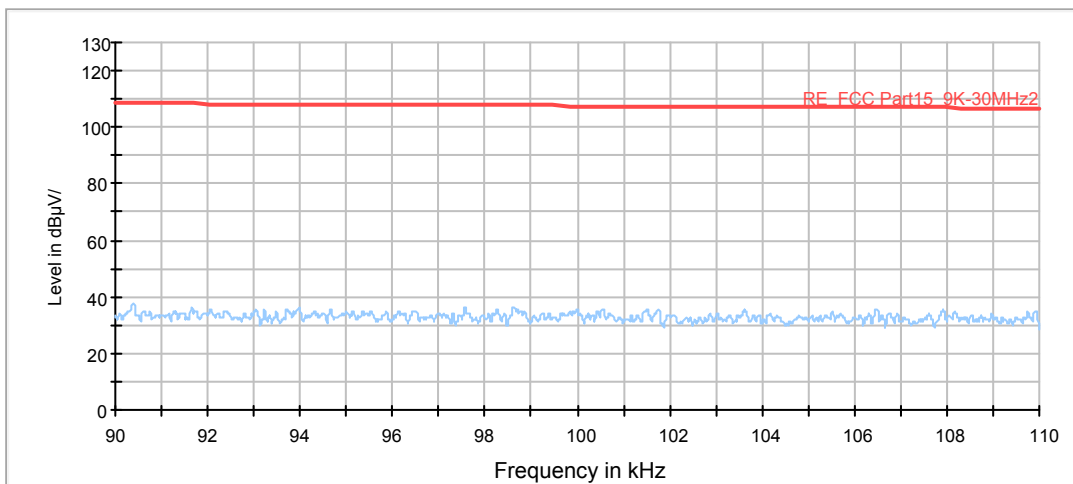

Radiates Emission from 90KHz to 110KHz



FCC RE 110K-490KHz AV

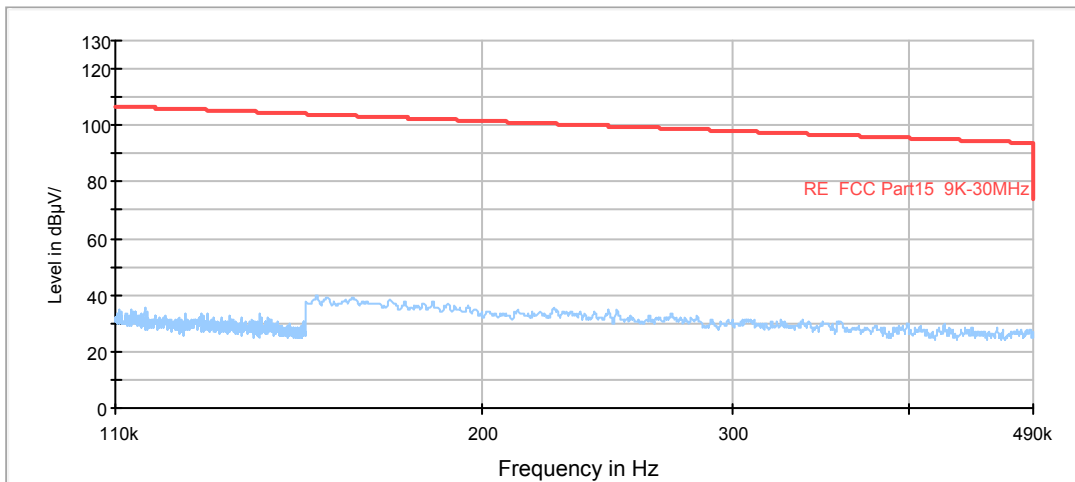

Radiates Emission from 110KHz to 490KHz

FCC RE 490K-30MHz QP

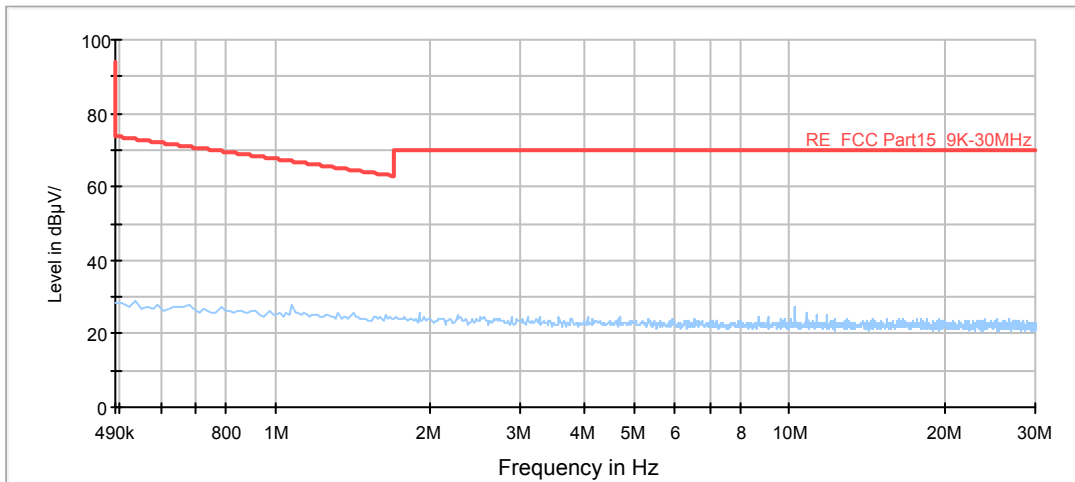

Radiates Emission from 490KHz to 30MHz



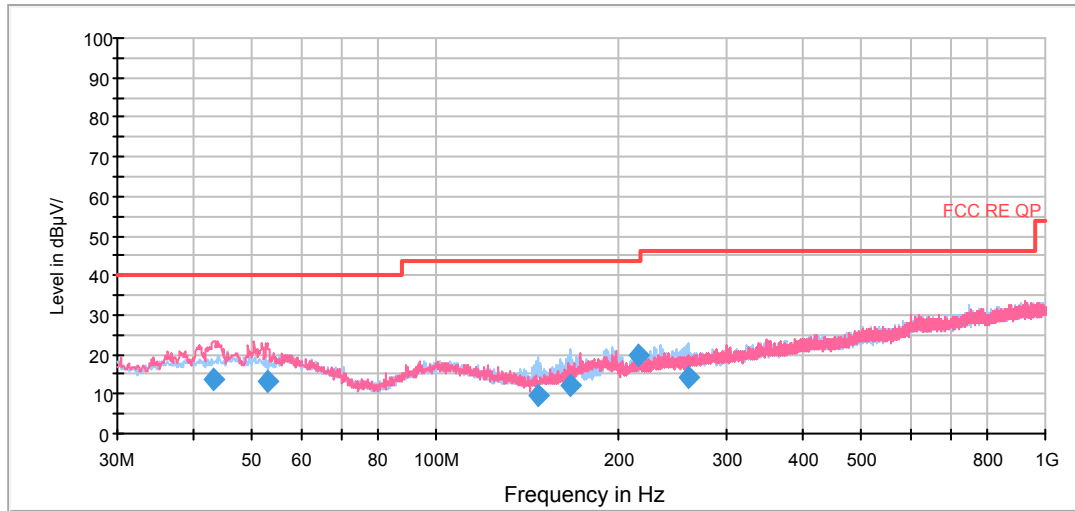

Radiates Emission from 30MHz to 1GHz

Frequency (MHz)	Quasi-Peak (dBuV/m)	Height (cm)	Polarization	Azimuth (deg)	Correct Factor (dB)	Margin (dB)	Limit (dBuV/m)
43.216250	13.9	189.0	V	110.0	14.6	26.1	40.0
52.876250	13.4	114.0	V	344.0	14.1	26.6	40.0
146.805000	9.4	189.0	H	132.0	9.8	34.1	43.5
165.640000	12.4	125.0	H	115.0	10.7	31.1	43.5
214.502500	19.8	189.0	V	255.0	13.1	23.7	43.5
259.282500	14.1	100.0	H	280.0	14.7	31.9	46.0

Remark: 1. Correction Factor = Antenna factor+ Insertion loss(cable loss+amplifier gain)  
 2. Margin = Limit – Quasi-Peak

802.11a CH36

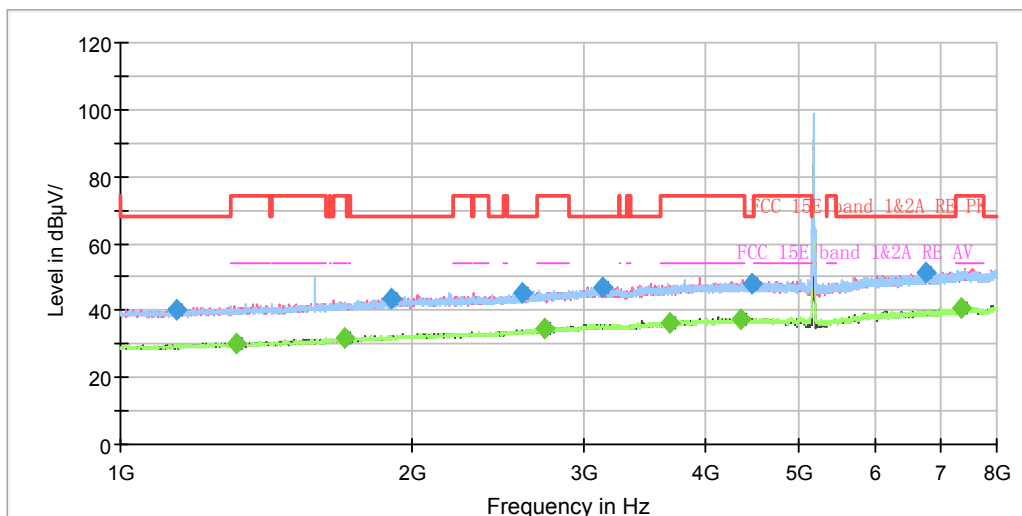

Note: The signal beyond the limit is carrier.  
Radiates Emission from 1GHz to 8GHz

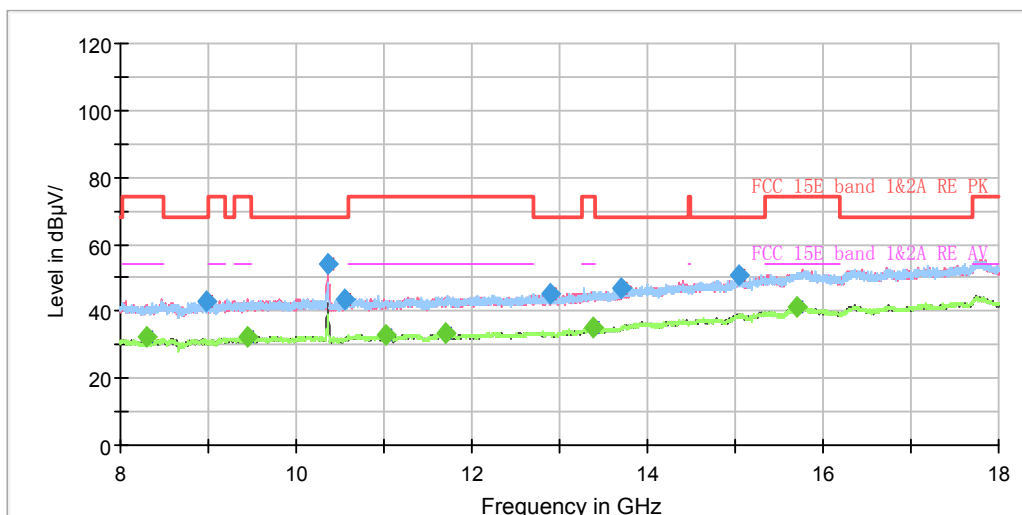

Radiates Emission from 8GHz to 18GHz



Frequency (MHz)	Peak (dBuV/m)	Average (dBuV/m)	Limit (dBuV/m)	Margin (dB)	Height (cm)	Polarization	Azimuth (deg)	Correct Factor (dB)
1140.875000	40.07	---	68.20	28.13	100.0	V	0.0	-8.2
1314.125000	---	30.00	54.00	24.00	100.0	V	0.0	-7.2
1702.625000	---	31.73	54.00	22.27	200.0	H	33.0	-5.0
1903.875000	43.42	---	68.20	24.78	100.0	H	94.0	-3.9
2597.750000	45.22	---	68.20	22.98	200.0	H	278.0	-1.0
2737.750000	---	34.33	54.00	19.67	100.0	H	267.0	-0.3
3142.875000	46.74	---	68.20	21.46	200.0	H	122.0	1.6
3676.625000	---	36.33	54.00	17.67	200.0	V	336.0	3.0
4352.125000	---	37.55	54.00	16.45	200.0	H	0.0	4.7
4483.375000	48.19	---	68.20	20.01	100.0	H	218.0	4.9
6751.375000	51.60	---	68.20	16.60	100.0	V	154.0	8.9
7343.750000	---	40.61	54.00	13.39	100.0	H	32.0	9.8

Remark: 1. Correction Factor = Antenna factor+ Insertion loss (cable loss + amplifier gain)

802.11a CH40

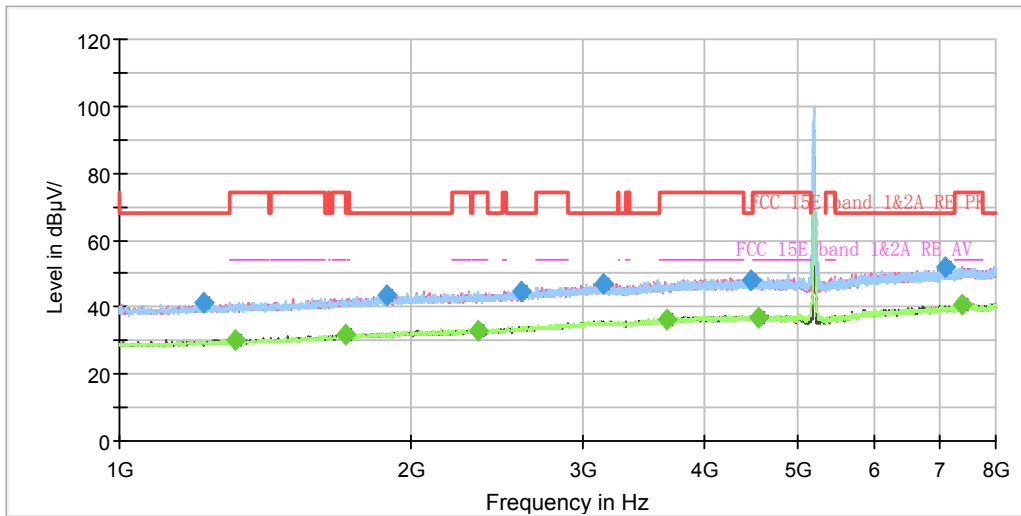

Note: The signal beyond the limit is carrier.  
Radiates Emission from 1GHz to 8GHz

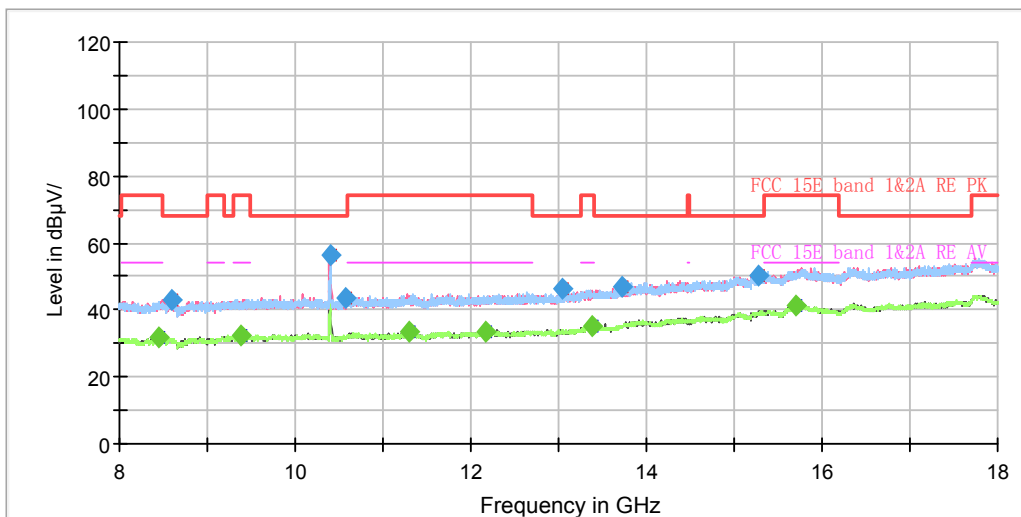

Radiates Emission from 8GHz to 18GHz



Frequency (MHz)	Peak (dBuV/m)	Average (dBuV/m)	Limit (dBuV/m)	Margin (dB)	Height (cm)	Polarization	Azimuth (deg)	Correct Factor (dB)
1219.625000	41.49	---	68.20	26.71	200.0	V	216.0	-7.7
1315.000000	---	30.10	54.00	23.90	100.0	V	0.0	-7.2
1709.625000	---	31.71	54.00	22.29	100.0	H	153.0	-5.0
1881.125000	43.43	---	68.20	24.77	100.0	V	98.0	-4.1
2343.125000	---	33.02	54.00	20.98	200.0	V	216.0	-2.1
2599.500000	44.79	---	68.20	23.41	200.0	H	13.0	-1.0
3154.250000	46.76	---	68.20	21.44	100.0	H	96.0	1.6
3673.125000	---	36.13	54.00	17.87	200.0	V	341.0	3.0
4477.250000	48.17	---	68.20	20.03	100.0	V	221.0	4.9
4563.000000	---	37.05	54.00	16.95	100.0	H	309.0	5.1
7101.375000	51.73	---	68.20	16.47	200.0	V	275.0	9.3
7377.875000	---	40.58	54.00	13.42	200.0	V	317.0	9.8

Remark: 1. Correction Factor = Antenna factor+ Insertion loss (cable loss + amplifier gain)

802.11a CH48

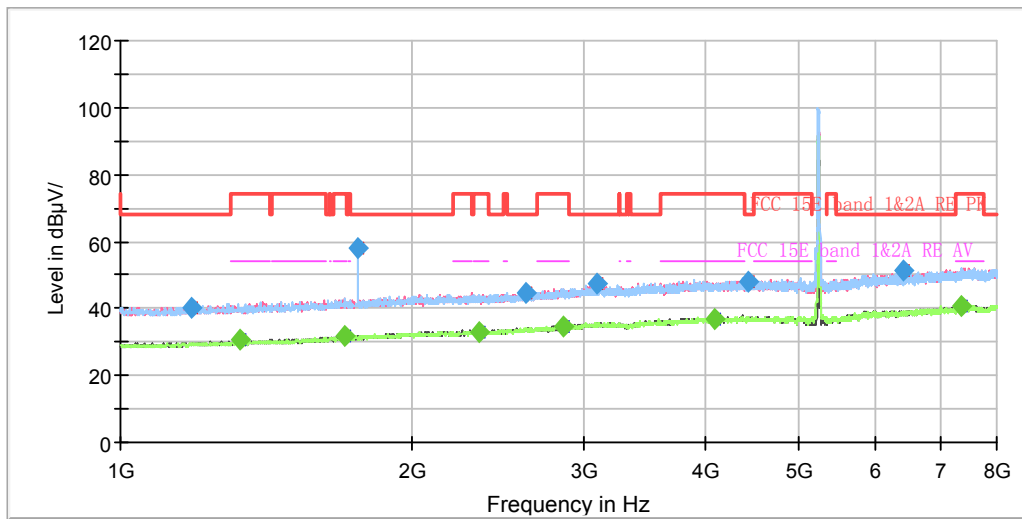

Note: The signal beyond the limit is carrier.  
Radiates Emission from 1GHz to 8GHz

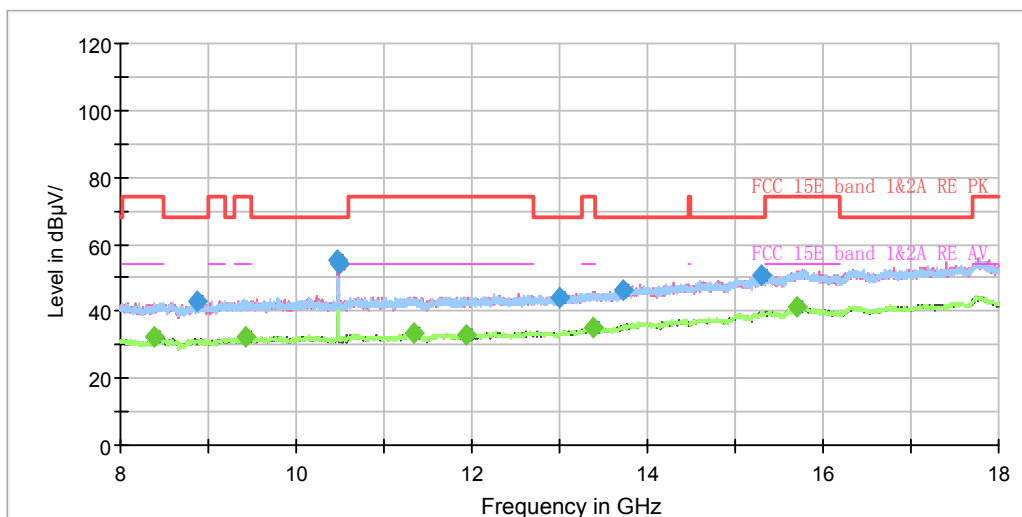

Radiates Emission from 8GHz to 18GHz



Frequency (MHz)	Peak (dBuV/m)	Average (dBuV/m)	Limit (dBuV/m)	Margin (dB)	Height (cm)	Polarization	Azimuth (deg)	Correct Factor (dB)
1184.625000	40.35	---	68.20	27.85	200.0	H	0.0	-7.8
1329.875000	---	30.42	54.00	23.58	100.0	V	78.0	-7.1
1706.125000	---	31.67	54.00	22.33	100.0	V	135.0	-5.0
1754.250000	57.83	---	68.20	10.37	200.0	H	354.0	-4.7
2339.625000	---	33.18	54.00	20.82	200.0	V	280.0	-2.2
2620.500000	44.60	---	68.20	23.60	100.0	H	298.0	-0.9
2865.500000	---	34.87	54.00	19.13	200.0	V	114.0	0.5
3100.000000	47.28	---	68.20	20.92	200.0	V	321.0	1.5
4090.500000	---	36.65	54.00	17.35	100.0	V	37.0	4.2
4443.125000	47.95	---	68.20	20.25	100.0	V	127.0	4.9
6401.375000	51.34	---	68.20	16.86	100.0	V	4.0	8.4
7361.250000	---	40.63	54.00	13.37	200.0	V	148.0	9.8

Remark: 1. Correction Factor = Antenna factor+ Insertion loss (cable loss + amplifier gain)

802.11a CH52

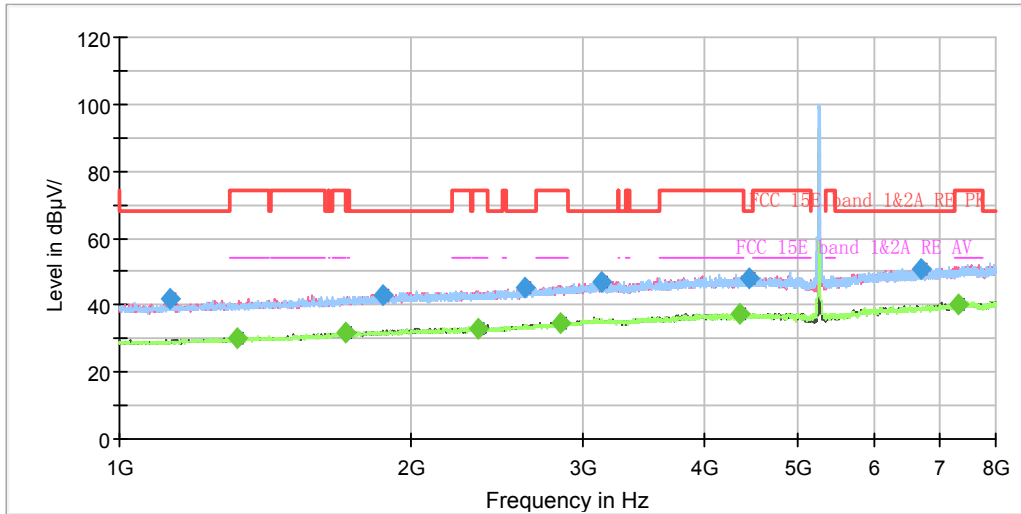

Note: The signal beyond the limit is carrier.  
Radiates Emission from 1GHz to 8GHz

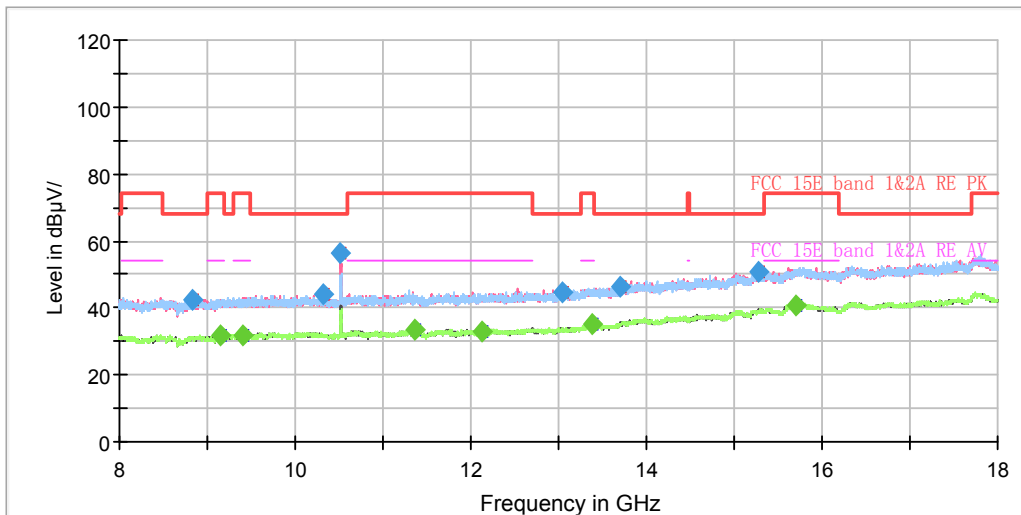

Radiates Emission from 8GHz to 18GHz





Frequency (MHz)	Peak (dBuV/m)	Average (dBuV/m)	Limit (dBuV/m)	Margin (dB)	Height (cm)	Polarization	Azimuth (deg)	Correct Factor (dB)
1127.750000	41.61	---	68.20	26.59	200.0	H	53.0	-8.2
1322.875000	---	30.18	54.00	23.82	200.0	V	164.0	-7.1
1707.875000	---	31.72	54.00	22.28	200.0	H	119.0	-5.0
1866.250000	42.93	---	68.20	25.27	200.0	V	328.0	-4.1
2337.875000	---	33.05	54.00	20.95	100.0	V	0.0	-2.2
2611.750000	45.39	---	68.20	22.81	100.0	V	351.0	-0.9
2843.625000	---	34.84	54.00	19.16	200.0	V	351.0	0.3
3139.375000	46.85	---	68.20	21.35	100.0	V	0.0	1.6
4365.250000	---	37.55	54.00	16.45	200.0	V	123.0	4.8
4459.750000	48.08	---	68.20	20.12	100.0	H	283.0	4.9
6687.500000	50.89	---	68.20	17.31	100.0	V	64.0	8.8
7335.000000	---	40.08	54.00	13.92	100.0	V	31.0	9.7

Remark: 1. Correction Factor = Antenna factor+ Insertion loss (cable loss + amplifier gain)

802.11a CH60

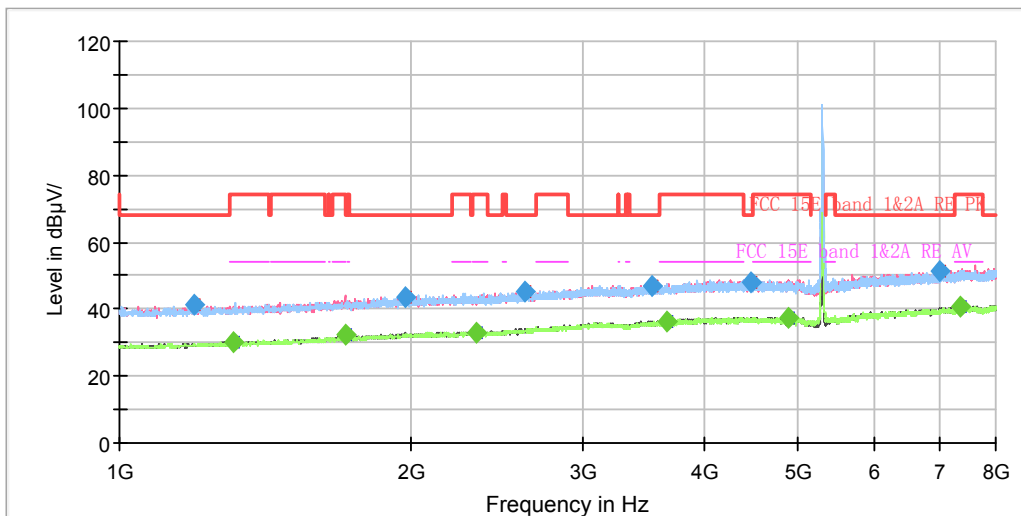

Note: The signal beyond the limit is carrier.  
Radiates Emission from 1GHz to 8GHz

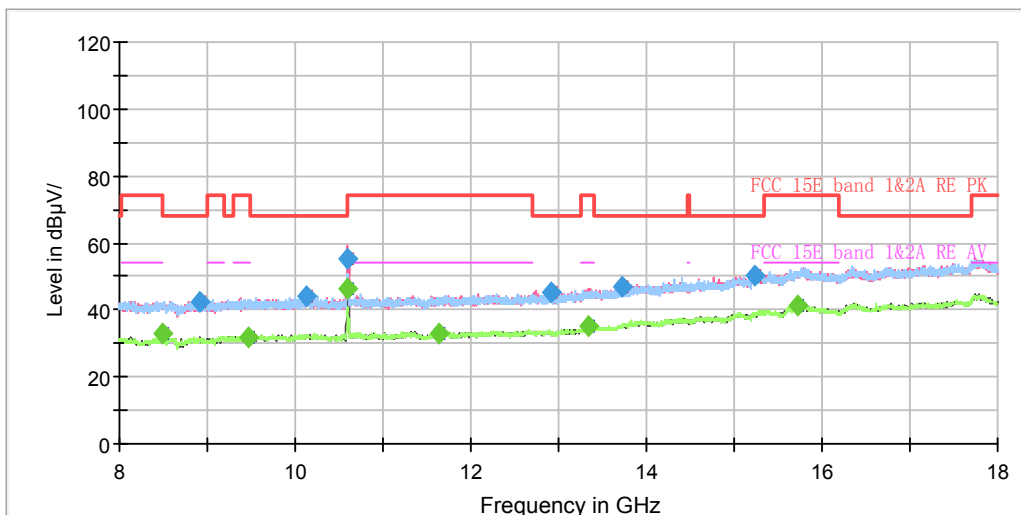

Radiates Emission from 8GHz to 18GHz



Frequency (MHz)	Peak (dBuV/m)	Average (dBuV/m)	Limit (dBuV/m)	Margin (dB)	Height (cm)	Polarization	Azimuth (deg)	Correct Factor (dB)
1193.375000	41.18	---	68.20	27.02	200.0	H	114.0	-7.8
1308.875000	---	30.01	54.00	23.99	100.0	V	0.0	-7.2
1707.875000	---	32.50	54.00	21.50	100.0	V	96.0	-5.0
1968.625000	43.72	---	68.20	24.48	100.0	H	310.0	-3.5
2333.500000	---	33.10	54.00	20.90	100.0	V	229.0	-2.2
2617.875000	45.47	---	68.20	22.73	200.0	V	314.0	-0.9
3542.750000	47.04	---	68.20	21.16	200.0	V	314.0	2.6
3658.250000	---	36.20	54.00	17.80	200.0	H	114.0	2.9
4467.625000	48.12	---	68.20	20.08	100.0	H	26.0	4.9
4883.250000	---	37.62	54.00	16.38	100.0	V	315.0	6.3
7008.625000	51.30	---	68.20	16.90	200.0	V	195.0	9.2
7361.250000	---	40.59	54.00	13.41	100.0	V	88.0	9.8

**Remark: 1. Correction Factor = Antenna factor+ Insertion loss (cable loss + amplifier gain)**

## 802.11a CH64

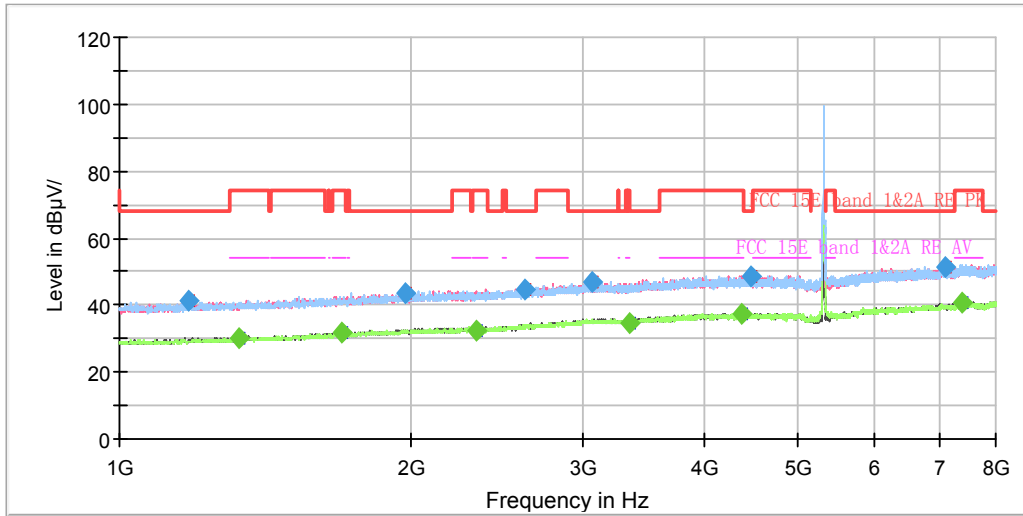

Note: The signal beyond the limit is carrier.  
Radiates Emission from 1GHz to 8GHz

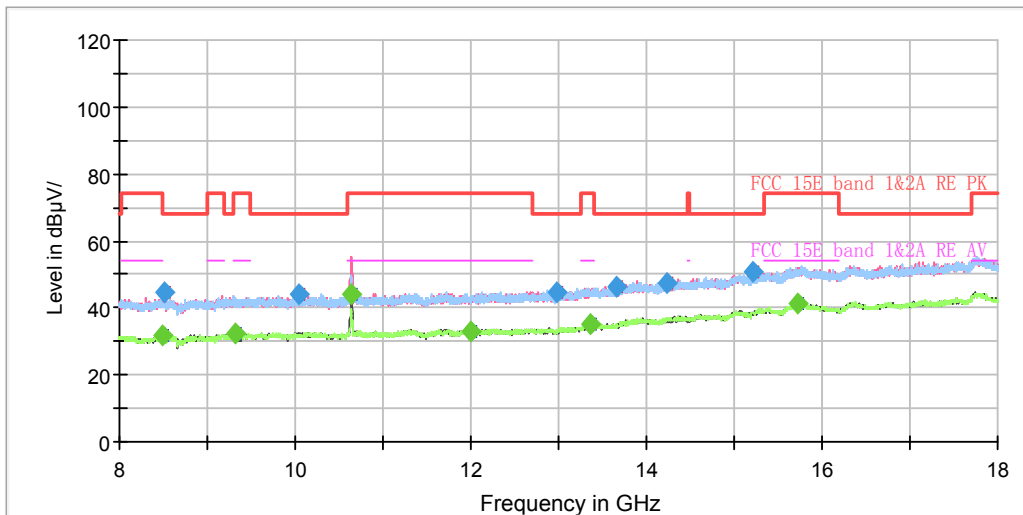

Radiates Emission from 8GHz to 18GHz



Frequency (MHz)	Peak (dBuV/m)	Average (dBuV/m)	Limit (dBuV/m)	Margin (dB)	Height (cm)	Polarization	Azimuth (deg)	Correct Factor (dB)
1180.250000	41.50	---	68.20	26.70	200.0	H	155.0	-7.9
1329.875000	---	30.17	54.00	23.83	200.0	H	0.0	-7.1
1693.875000	---	31.54	54.00	22.46	100.0	V	282.0	-5.1
1973.000000	43.77	---	68.20	24.43	100.0	V	146.0	-3.5
2337.000000	---	32.60	54.00	21.40	100.0	V	318.0	-2.2
2612.625000	44.63	---	68.20	23.57	100.0	H	262.0	-0.9
3066.750000	46.68	---	68.20	21.52	100.0	V	40.0	1.5
3352.000000	---	34.76	54.00	19.24	100.0	V	155.0	1.5
4375.750000	---	37.45	54.00	16.55	200.0	V	6.0	4.8
4480.750000	48.82	---	68.20	19.38	200.0	V	108.0	4.9
7104.875000	51.47	---	68.20	16.73	100.0	H	34.0	9.3
7377.000000	---	40.54	54.00	13.46	100.0	V	32.0	9.8

Remark: 1. Correction Factor = Antenna factor+ Insertion loss (cable loss + amplifier gain)

802.11a CH100

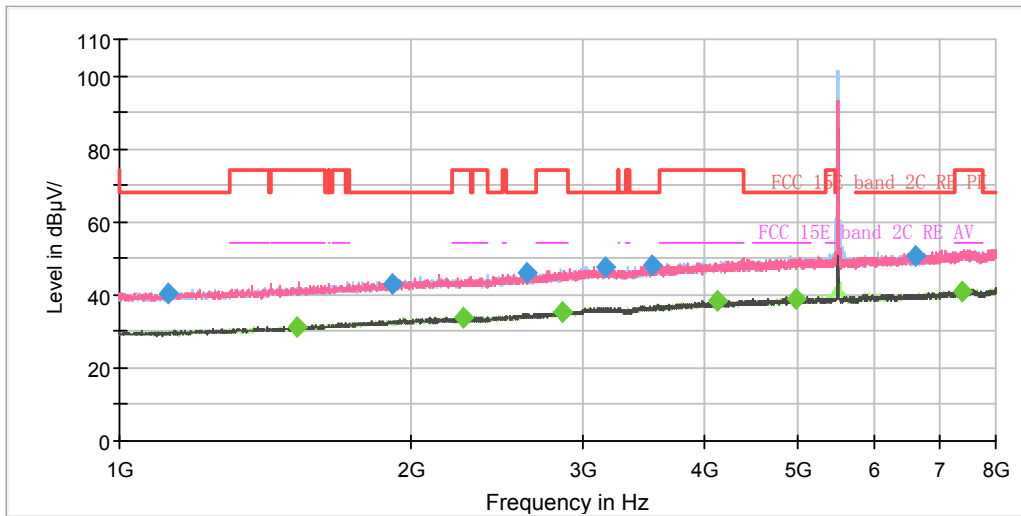

Note: The signal beyond the limit is carrier.  
Radiates Emission from 1GHz to 8GHz

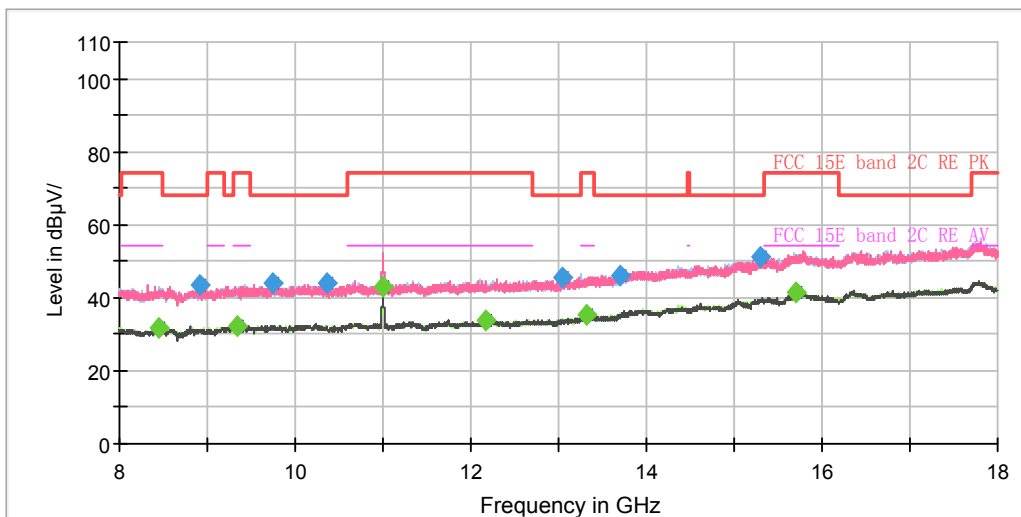

Radiates Emission from 8GHz to 18GHz



Frequency (MHz)	Peak (dBuV/m)	Average (dBuV/m)	Limit (dBuV/m)	Margin (dB)	Height (cm)	Polarization	Azimuth (deg)	Correct Factor (dB)
1120.750000	40.56	---	68.20	27.64	100.0	H	265.0	-8.2
1525.000000	---	31.07	54.00	22.93	200.0	H	294.0	-8.0
1914.375000	43.04	---	68.20	25.16	100.0	V	309.0	-3.9
2256.500000	---	33.67	54.00	20.33	200.0	V	301.0	-3.8
2863.750000	---	35.23	54.00	18.77	100.0	H	44.0	-0.9
2632.750000	45.99	---	68.20	22.21	200.0	H	80.0	-0.8
4136.000000	---	38.26	54.00	15.74	100.0	H	257.0	1.5
3172.625000	47.70	---	68.20	20.50	200.0	H	192.0	1.6
3532.250000	48.17	---	68.20	20.03	100.0	V	247.0	2.5
4967.250000	---	38.77	54.00	15.23	100.0	H	0.0	2.6
6601.750000	50.50	---	68.20	17.70	100.0	H	86.0	8.7
7393.625000	---	40.98	54.00	13.02	100.0	V	26.0	9.8

Remark: 1. Correction Factor = Antenna factor+ Insertion loss (cable loss + amplifier gain)

802.11a CH116

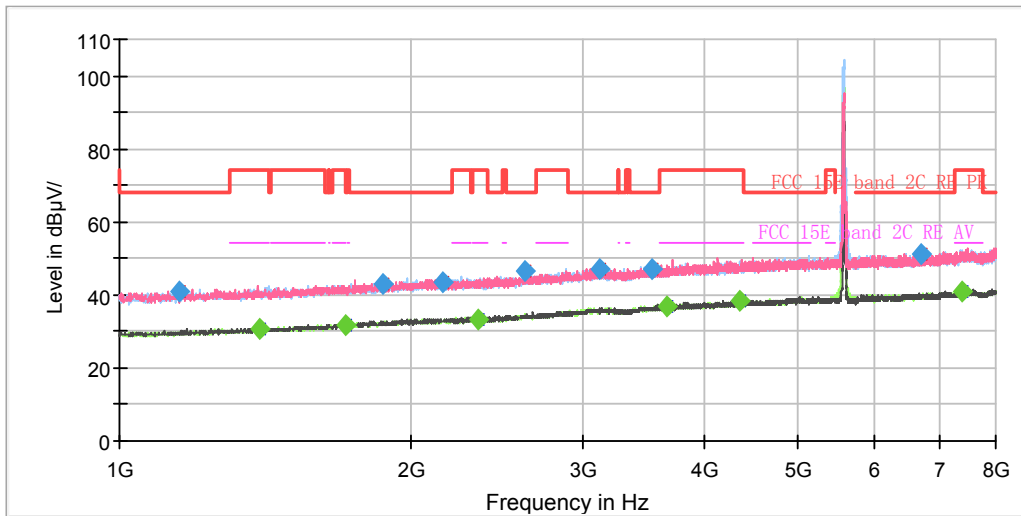

Note: The signal beyond the limit is carrier.  
Radiates Emission from 1GHz to 8GHz

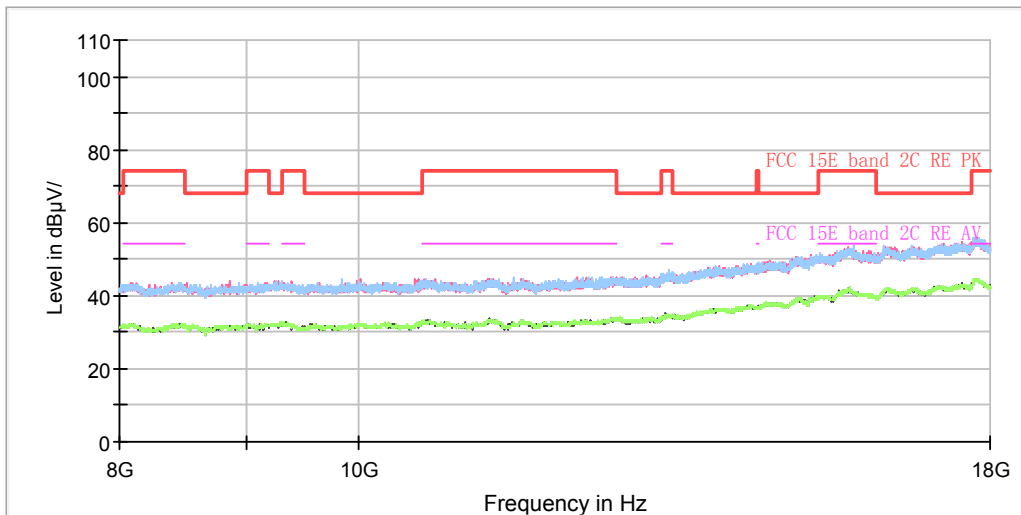

Radiates Emission from 8GHz to 18GHz





Frequency (MHz)	Peak (dBuV/m)	Average (dBuV/m)	Limit (dBuV/m)	Margin (dB)	Height (cm)	Polarization	Azimuth (deg)	Correct Factor (dB)
1153.125000	40.75	---	68.20	27.45	100.0	V	161.0	-8.1
1397.250000	---	30.49	54.00	23.51	100.0	H	252.0	-6.7
1711.375000	---	31.90	54.00	22.10	200.0	H	324.0	-5.0
1865.375000	43.20	---	68.20	25.00	100.0	H	105.0	-4.1
2155.000000	43.65	---	68.20	24.55	200.0	H	252.0	-2.7
2347.500000	---	33.42	54.00	20.58	100.0	V	161.0	-2.1
2619.625000	46.59	---	68.20	21.61	200.0	V	183.0	-0.9
3128.875000	47.25	---	68.20	20.95	100.0	H	165.0	1.6
3539.250000	47.22	---	68.20	20.98	100.0	V	59.0	2.5
3667.875000	---	36.92	54.00	17.08	200.0	V	279.0	3.0
4365.250000	---	38.58	54.00	15.42	100.0	V	6.0	4.8
6701.500000	51.03	---	68.20	17.17	200.0	V	28.0	8.8
7389.250000	---	40.95	54.00	13.05	100.0	V	131.0	9.8

Remark: 1. Correction Factor = Antenna factor+ Insertion loss (cable loss + amplifier gain)

802.11a CH140

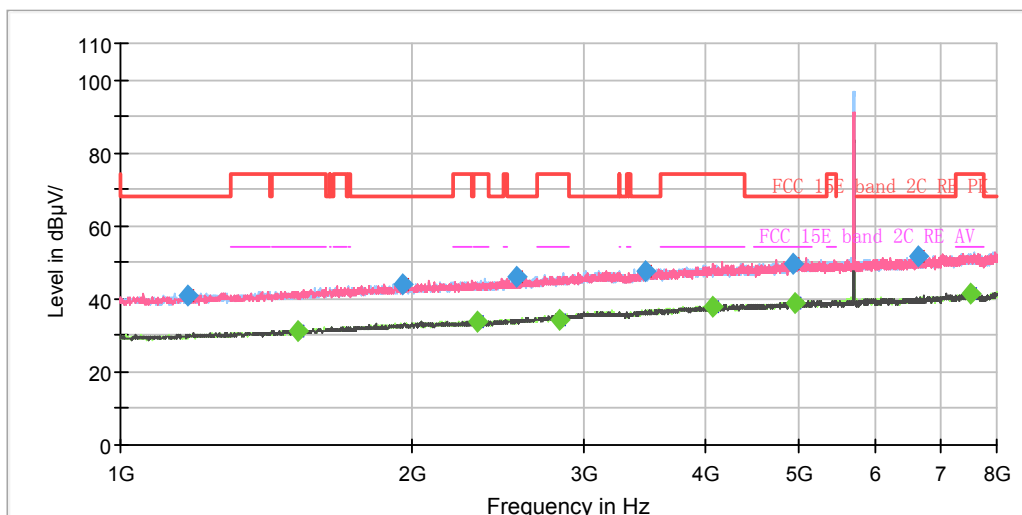

Note: The signal beyond the limit is carrier.  
Radiates Emission from 1GHz to 8GHz

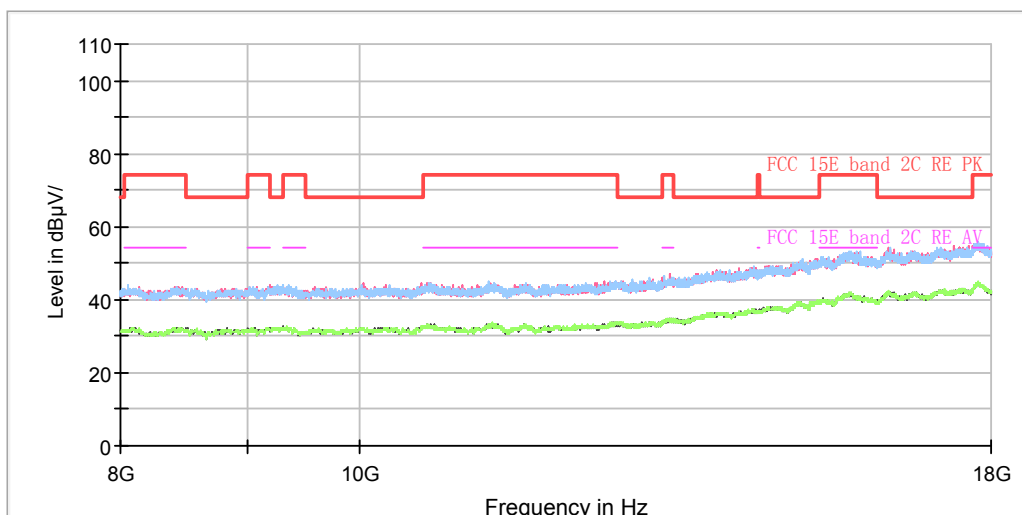

Radiates Emission from 8GHz to 18GHz



Frequency (MHz)	Peak (dBuV/m)	Average (dBuV/m)	Limit (dBuV/m)	Margin (dB)	Height (cm)	Polarization	Azimuth (deg)	Correct Factor (dB)
1172.375000	41.18	---	68.20	27.02	200.0	V	356.0	-8.0
1521.500000	---	31.24	54.00	22.76	100.0	V	69.0	-6.0
1951.125000	43.87	---	68.20	24.33	200.0	V	298.0	-3.6
2330.875000	---	33.72	54.00	20.28	100.0	H	324.0	-2.2
2565.375000	45.84	---	68.20	22.37	200.0	H	0.0	-1.1
2832.250000	---	34.52	54.00	19.48	200.0	V	0.0	0.3
3481.500000	47.54	---	68.20	20.66	100.0	H	0.0	2.2
4070.375000	---	37.77	54.00	16.23	100.0	H	171.0	4.1
4937.500000	49.64	---	68.20	18.56	100.0	H	310.0	6.4
4951.500000	---	39.10	54.00	14.90	200.0	H	100.0	6.5
6652.500000	51.76	---	68.20	16.44	200.0	V	247.0	8.8
7524.000000	---	41.29	54.00	12.71	100.0	H	142.0	9.9

Remark: 1. Correction Factor = Antenna factor+ Insertion loss (cable loss + amplifier gain)

802.11a CH149

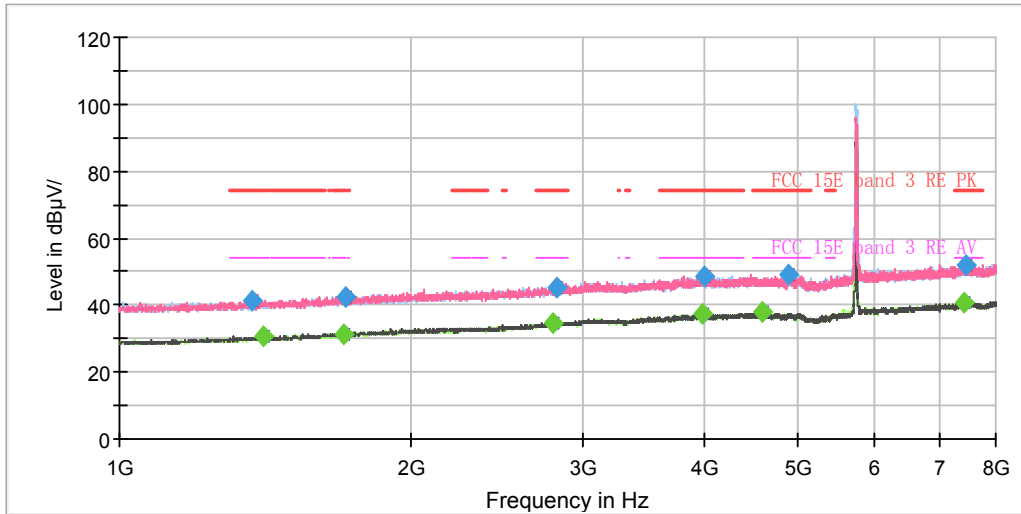

Note: The signal beyond the limit is carrier.  
Radiates Emission from 1GHz to 8GHz

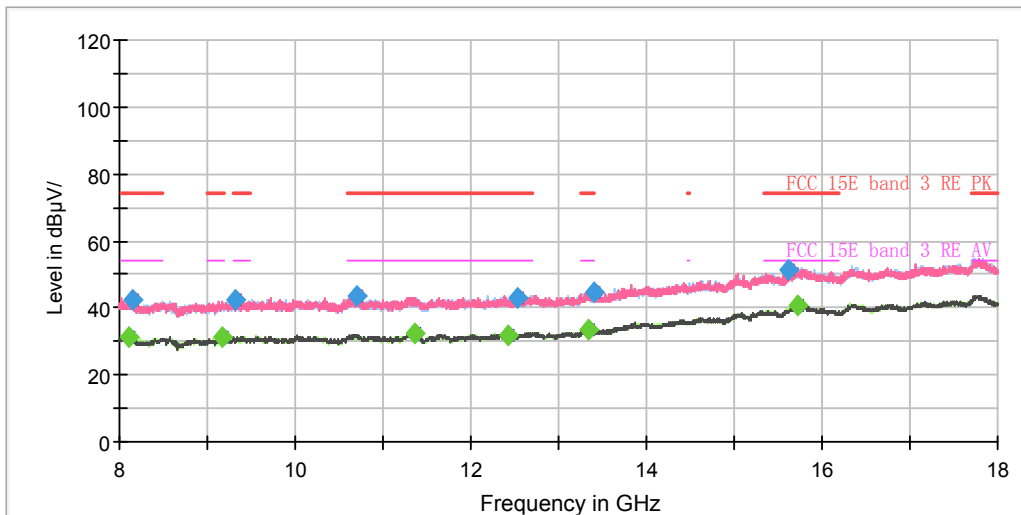

Radiates Emission from 8GHz to 18GHz



Frequency (MHz)	Peak (dBuV/m)	Average (dBuV/m)	Limit (dBuV/m)	Margin (dB)	Height (cm)	Polarization	Azimuth (deg)	Correct Factor (dB)
1371.000000	41.48	---	74.00	32.52	100.0	V	29.0	-6.9
1407.750000	---	30.59	54.00	23.41	100.0	H	157.0	-6.7
1699.125000	---	31.49	54.00	22.51	100.0	V	153.0	-5.0
1708.750000	42.58	---	74.00	31.42	200.0	V	157.0	-5.0
2799.875000	---	34.71	54.00	19.29	200.0	H	149.0	0.1
2827.875000	45.41	---	74.00	28.59	200.0	V	357.0	0.2
3985.500000	---	37.24	54.00	16.76	100.0	H	209.0	4.0
3999.500000	48.63	---	74.00	25.37	100.0	V	311.0	4.0
4596.250000	---	37.72	54.00	16.28	100.0	H	313.0	5.2
4892.875000	48.97	---	74.00	25.03	200.0	H	171.0	6.4
7417.250000	---	40.78	54.00	13.22	100.0	H	164.0	9.8
7440.875000	52.16	---	74.00	21.84	200.0	V	350.0	9.8

Remark: 1. Correction Factor = Antenna factor+ Insertion loss (cable loss + amplifier gain)

802.11a CH157

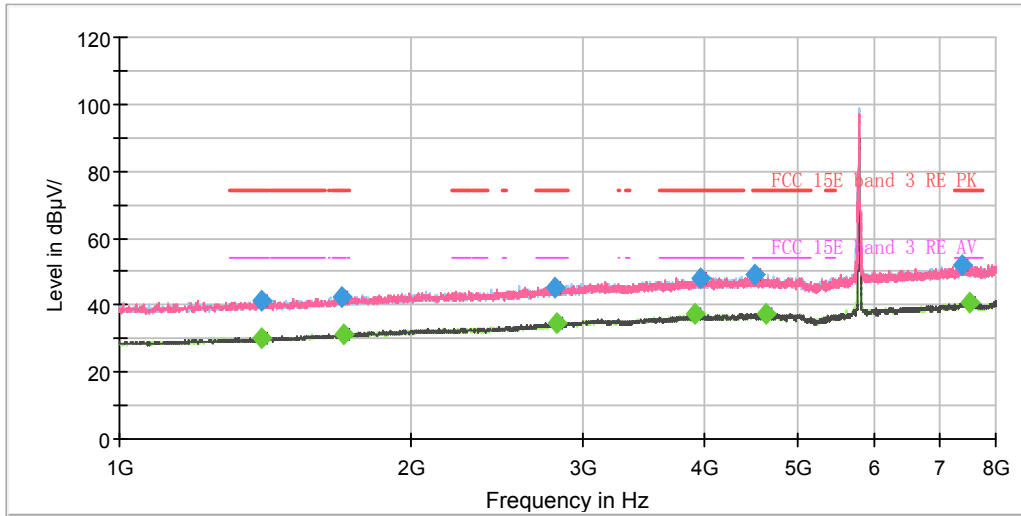

Note: The signal beyond the limit is carrier.  
Radiates Emission from 1GHz to 8GHz

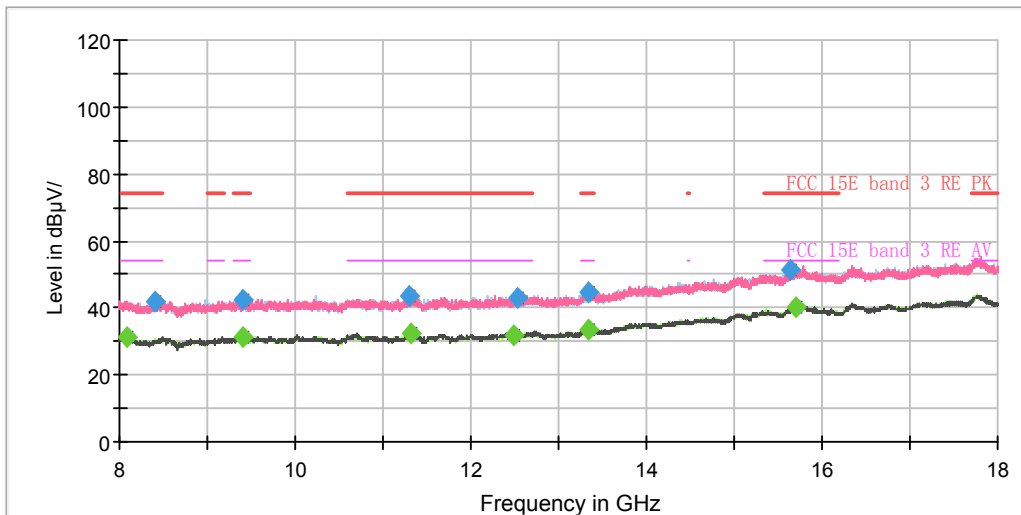

Radiates Emission from 8GHz to 18GHz



Frequency (MHz)	Peak (dBuV/m)	Average (dBuV/m)	Limit (dBuV/m)	Margin (dB)	Height (cm)	Polarization	Azimuth (deg)	Correct Factor (dB)
1400.750000	---	30.22	54.00	23.78	100.0	H	0.0	-6.7
1401.625000	41.23	---	74.00	32.77	200.0	H	50.0	-6.7
1691.250000	42.37	---	74.00	31.63	200.0	H	347.0	-5.1
1704.375000	---	31.42	54.00	22.58	100.0	V	307.0	-5.0
2810.375000	45.46	---	74.00	28.54	200.0	H	208.0	0.1
2827.875000	---	34.47	54.00	19.53	200.0	H	0.0	0.2
3924.250000	---	37.15	54.00	16.85	100.0	V	96.0	3.8
3961.875000	47.99	---	74.00	26.01	100.0	H	127.0	3.9
4521.000000	49.37	---	74.00	24.63	100.0	V	329.0	5.1
4627.750000	---	37.53	54.00	16.47	200.0	H	0.0	5.3
7379.625000	51.90	---	74.00	22.10	200.0	V	284.0	9.8
7517.875000	---	40.83	54.00	13.17	100.0	H	27.0	9.9

Remark: 1. Correction Factor = Antenna factor+ Insertion loss (cable loss + amplifier gain)

802.11a CH165

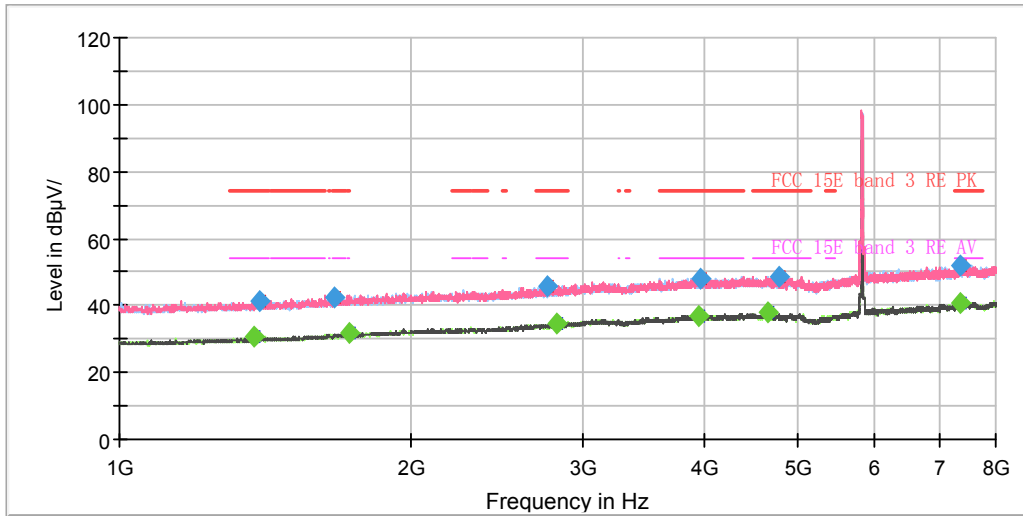

Note: The signal beyond the limit is carrier.  
Radiates Emission from 1GHz to 8GHz

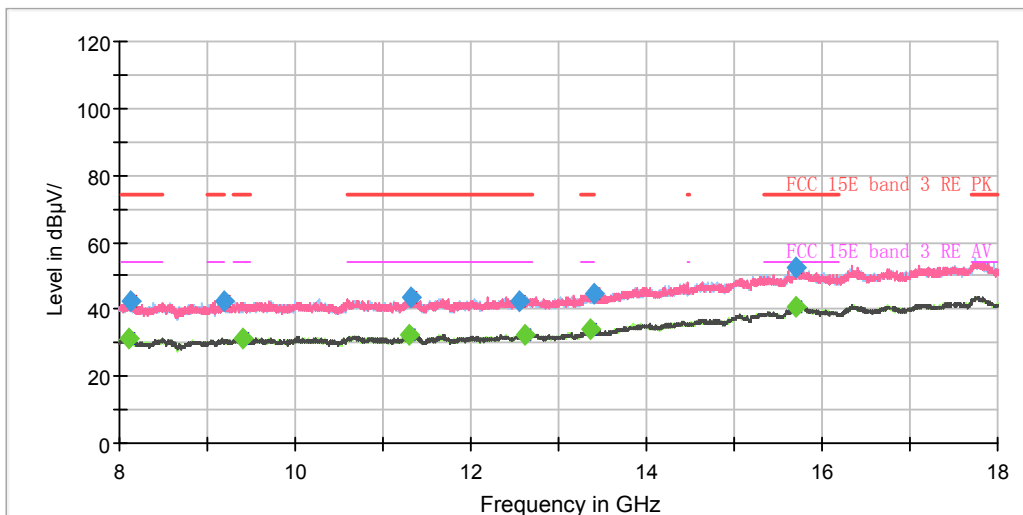

Radiates Emission from 8GHz to 18GHz





Frequency (MHz)	Peak (dBuV/m)	Average (dBuV/m)	Limit (dBuV/m)	Margin (dB)	Height (cm)	Polarization	Azimuth (deg)	Correct Factor (dB)
1377.125000	---	30.49	54.00	23.51	100.0	V	344.0	-6.8
1395.500000	41.14	---	74.00	32.86	200.0	H	350.0	-6.7
1665.000000	42.33	---	74.00	31.67	100.0	V	242.0	-5.2
1721.875000	---	31.56	54.00	22.44	200.0	H	205.0	-4.9
2754.375000	45.78	---	74.00	28.22	100.0	H	169.0	-0.2
2825.250000	---	34.39	54.00	19.61	200.0	V	221.0	0.2
3961.000000	---	37.11	54.00	16.89	100.0	H	111.0	3.9
3975.875000	47.97	---	74.00	26.03	100.0	V	181.0	3.9
4660.125000	---	38.09	54.00	15.91	200.0	H	350.0	5.5
4790.500000	48.71	---	74.00	25.29	200.0	H	67.0	5.8
7345.500000	51.87	---	74.00	22.13	100.0	V	359.0	9.8
7348.125000	---	40.75	54.00	13.25	200.0	V	113.0	9.8

Remark: 1. Correction Factor = Antenna factor+ Insertion loss (cable loss + amplifier gain)

802.11n (HT20) CH36

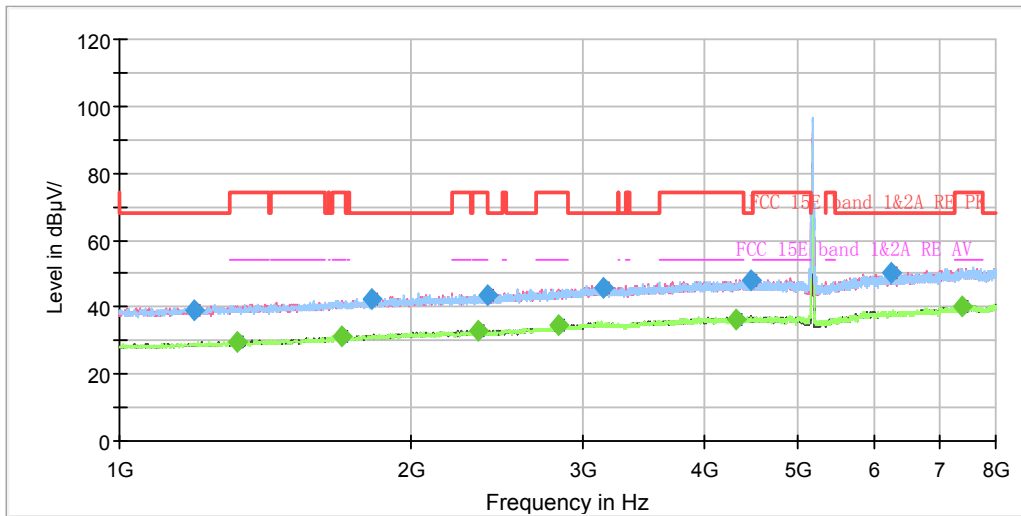

Note: The signal beyond the limit is carrier.  
Radiates Emission from 1GHz to 8GHz

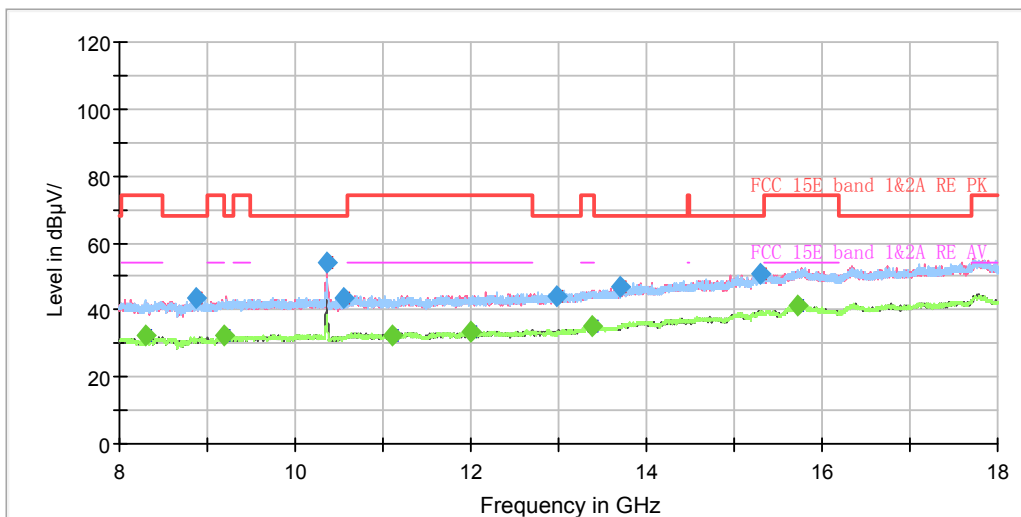

Radiates Emission from 8GHz to 18GHz



Frequency (MHz)	Peak (dBuV/m)	Average (dBuV/m)	Limit (dBuV/m)	Margin (dB)	Height (cm)	Polarization	Azimuth (deg)	Correct Factor (dB)
1193.375000	39.20	---	68.20	29.00	100.0	V	85.0	-7.8
1323.750000	---	29.52	54.00	24.48	200.0	V	17.0	-7.1
1693.875000	---	31.01	54.00	22.99	200.0	V	289.0	-5.1
1821.625000	42.47	---	68.20	25.73	100.0	V	68.0	-4.3
2338.750000	---	32.68	54.00	21.32	100.0	V	226.0	-2.2
2399.125000	43.78	---	68.20	24.42	200.0	V	250.0	-2.0
2839.250000	---	34.39	54.00	19.61	200.0	V	280.0	0.3
3153.375000	45.79	---	68.20	22.41	100.0	V	12.0	1.6
4320.625000	---	36.52	54.00	17.48	100.0	V	68.0	4.6
4469.375000	48.05	---	68.20	20.15	200.0	V	233.0	4.9
6248.250000	50.39	---	68.20	17.81	100.0	V	12.0	8.2
7388.375000	---	40.40	54.00	13.60	200.0	V	72.0	9.8

Remark: 1. Correction Factor = Antenna factor+ Insertion loss (cable loss + amplifier gain)

802.11n (HT20) CH40

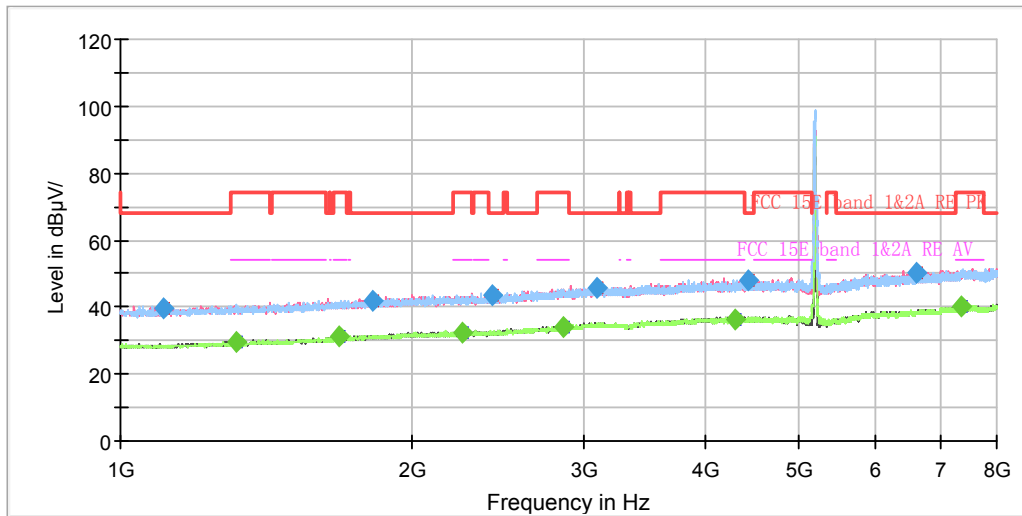

Note: The signal beyond the limit is carrier.  
Radiates Emission from 1GHz to 8GHz

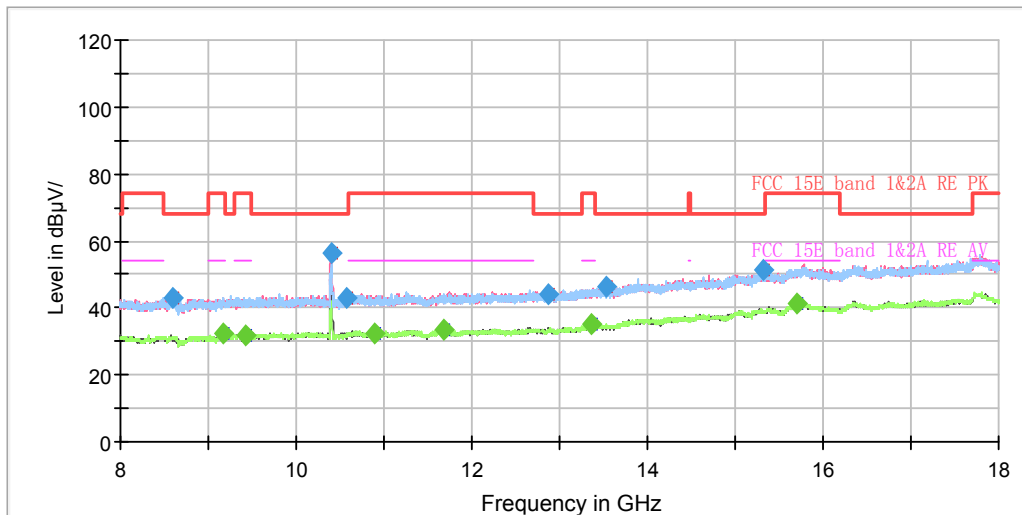

Radiates Emission from 8GHz to 18GHz



Frequency (MHz)	Peak (dBuV/m)	Average (dBuV/m)	Limit (dBuV/m)	Margin (dB)	Height (cm)	Polarization	Azimuth (deg)	Correct Factor (dB)
1105.875000	39.74	---	68.20	28.46	100.0	V	219.0	-8.3
1318.500000	---	29.52	54.00	24.48	100.0	H	208.0	-7.1
1679.875000	---	31.02	54.00	22.98	100.0	H	325.0	-5.1
1816.375000	41.97	---	68.20	26.23	100.0	H	42.0	-4.3
2254.750000	---	32.63	54.00	21.37	200.0	V	199.0	-2.4
2419.250000	43.55	---	68.20	24.65	100.0	V	28.0	-1.9
2860.250000	---	33.80	54.00	20.20	100.0	V	11.0	0.5
3100.875000	45.99	---	68.20	22.21	200.0	V	192.0	1.5
4302.250000	---	36.49	54.00	17.51	200.0	V	231.0	4.5
4429.125000	48.17	---	68.20	20.03	200.0	H	173.0	4.9
6601.750000	50.16	---	68.20	18.04	100.0	H	184.0	8.7
7361.250000	---	40.19	54.00	13.81	100.0	V	301.0	9.8

Remark: 1. Correction Factor = Antenna factor+ Insertion loss (cable loss + amplifier gain)

### 802.11n (HT20) CH48

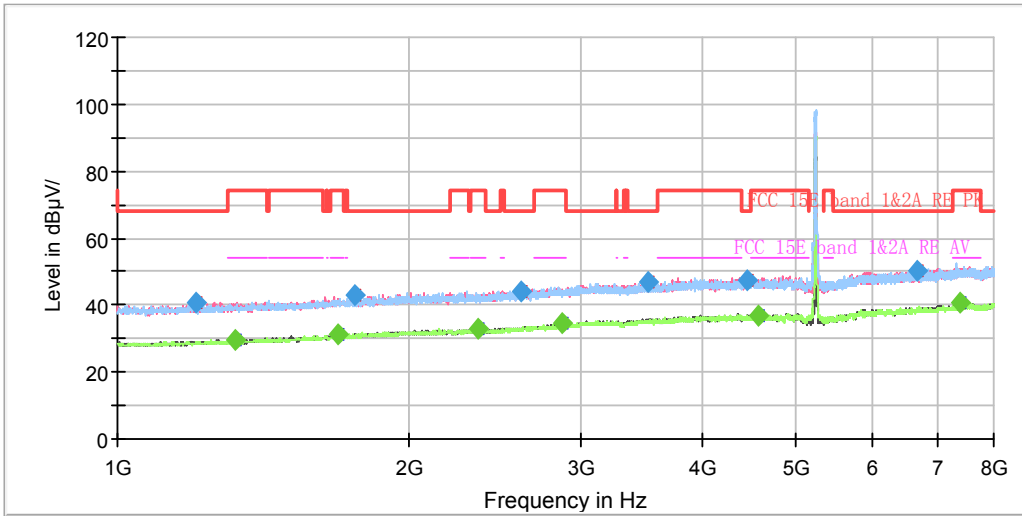

Note: The signal beyond the limit is carrier.  
Radiates Emission from 1GHz to 8GHz

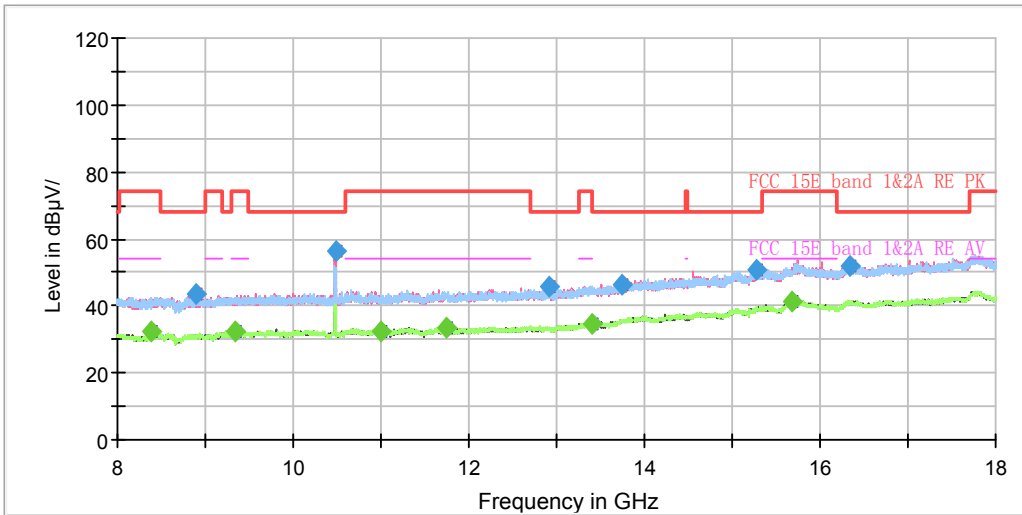

Radiates Emission from 8GHz to 18GHz



Frequency (MHz)	Peak (dBuV/m)	Average (dBuV/m)	Limit (dBuV/m)	Margin (dB)	Height (cm)	Polarization	Azimuth (deg)	Correct Factor (dB)
1206.500000	40.77	---	68.20	27.43	100.0	V	303.0	-7.8
1319.375000	---	29.35	54.00	24.65	200.0	V	231.0	-7.1
1688.625000	---	31.14	54.00	22.86	200.0	V	338.0	-5.1
1758.625000	43.25	---	68.20	24.95	100.0	H	89.0	-4.7
2352.750000	---	32.78	54.00	21.22	100.0	H	269.0	-2.1
2610.000000	44.26	---	68.20	23.94	200.0	H	109.0	-0.9
2866.375000	---	34.51	54.00	19.49	200.0	V	170.0	0.5
3524.375000	47.12	---	68.20	21.08	100.0	V	0.0	2.4
4451.000000	47.43	---	68.20	20.77	200.0	V	215.0	4.9
4571.750000	---	36.62	54.00	17.38	200.0	V	346.0	5.2
6665.625000	50.22	---	68.20	17.98	200.0	V	312.0	8.8
7398.000000	---	40.53	54.00	13.47	100.0	H	204.0	9.8

Remark: 1. Correction Factor = Antenna factor+ Insertion loss (cable loss + amplifier gain)

## 802.11n (HT20) CH52

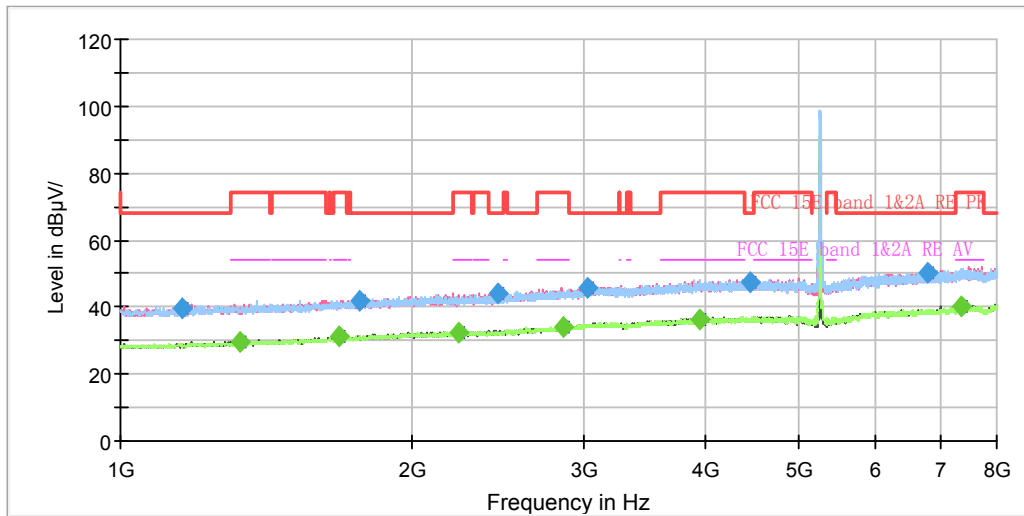

Note: The signal beyond the limit is carrier.  
Radiates Emission from 1GHz to 8GHz

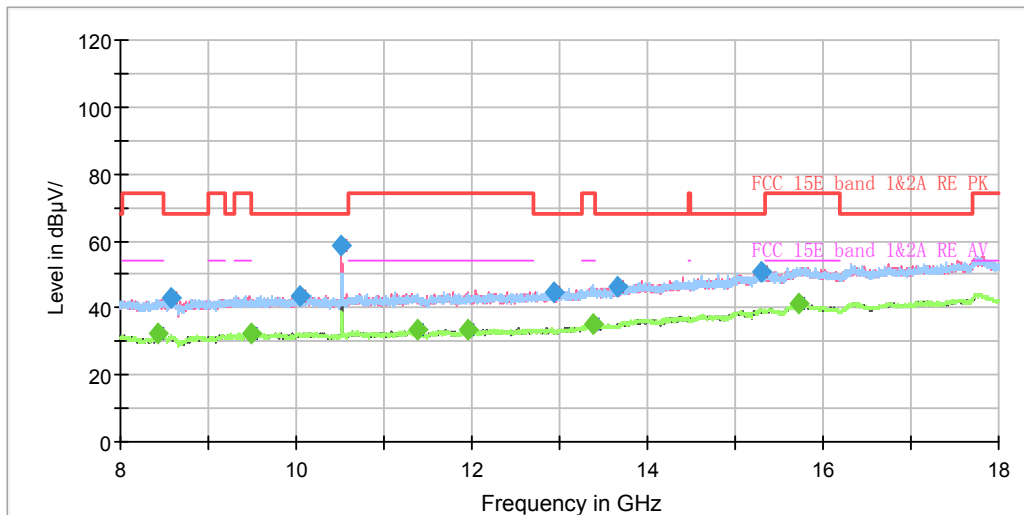

Radiates Emission from 8GHz to 18GHz





Frequency (MHz)	Peak (dBuV/m)	Average (dBuV/m)	Limit (dBuV/m)	Margin (dB)	Height (cm)	Polarization	Azimuth (deg)	Correct Factor (dB)
1156.625000	39.74	---	68.20	28.46	100.0	V	203.0	-8.0
1329.875000	---	29.49	54.00	24.51	200.0	V	79.0	-7.1
1680.750000	---	31.27	54.00	22.73	100.0	V	187.0	-5.1
1767.375000	41.87	---	68.20	26.33	100.0	V	292.0	-4.7
2235.500000	---	32.09	54.00	21.91	200.0	V	347.0	-2.6
2447.250000	44.07	---	68.20	24.13	100.0	V	178.0	-1.7
2865.500000	---	33.95	54.00	20.05	100.0	V	29.0	0.5
3026.500000	45.80	---	68.20	22.40	100.0	H	209.0	1.3
3949.625000	---	36.47	54.00	17.53	200.0	H	41.0	3.9
4450.125000	47.60	---	68.20	20.60	200.0	V	200.0	4.9
6787.250000	50.43	---	68.20	17.77	100.0	V	171.0	9.0
7360.375000	---	40.39	54.00	13.61	100.0	H	275.0	9.8

Remark: 1. Correction Factor = Antenna factor+ Insertion loss (cable loss + amplifier gain)

802.11n (HT20) CH60

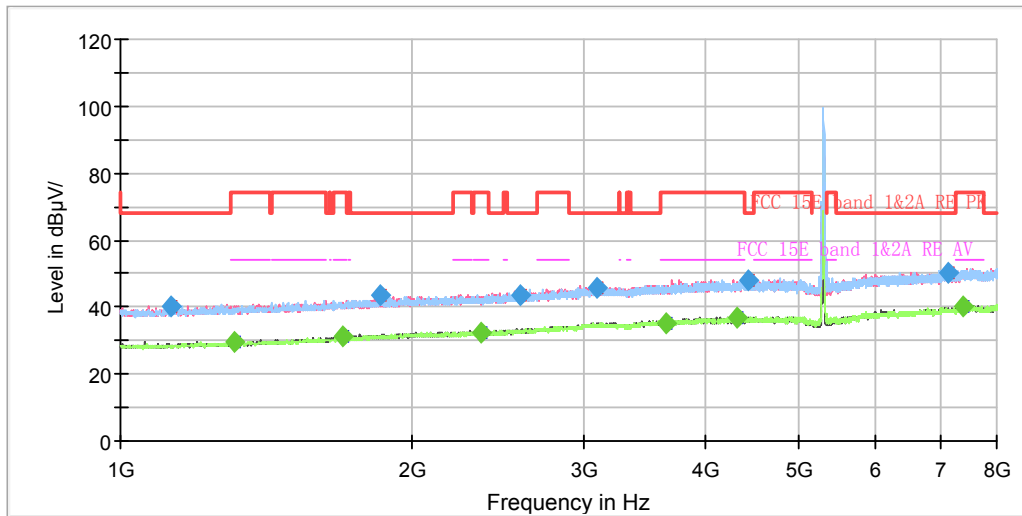

Note: The signal beyond the limit is carrier.  
Radiates Emission from 1GHz to 8GHz

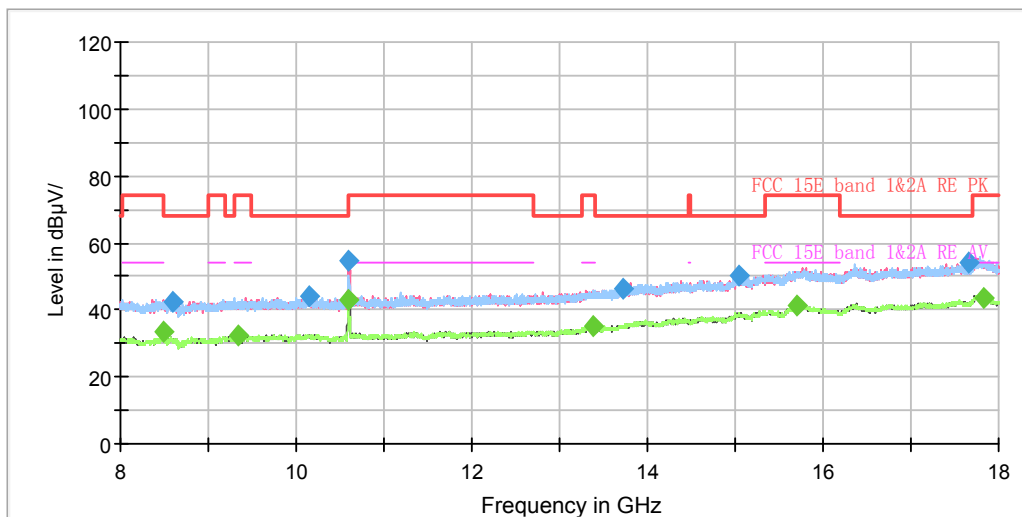

Radiates Emission from 8GHz to 18GHz



Frequency (MHz)	Peak (dBuV/m)	Average (dBuV/m)	Limit (dBuV/m)	Margin (dB)	Height (cm)	Polarization	Azimuth (deg)	Correct Factor (dB)
1126.000000	40.12	---	68.20	28.08	200.0	V	55.0	-8.2
1309.750000	---	29.54	54.00	24.47	100.0	V	0.0	-7.2
1697.375000	---	31.19	54.00	22.81	200.0	H	0.0	-5.0
1855.750000	43.81	---	68.20	24.39	100.0	V	32.0	-4.2
2350.125000	---	32.63	54.00	21.37	100.0	V	339.0	-2.1
2577.625000	43.79	---	68.20	24.41	200.0	H	342.0	-1.1
3097.375000	45.88	---	68.20	22.32	100.0	H	192.0	1.5
3646.000000	---	35.42	54.00	18.58	200.0	V	139.0	2.8
4320.625000	---	36.93	54.00	17.07	100.0	V	194.0	4.6
4439.625000	47.79	---	68.20	20.41	100.0	V	0.0	4.9
7122.375000	50.50	---	68.20	17.70	200.0	V	181.0	9.4
7396.250000	---	40.29	54.00	13.71	100.0	V	105.0	9.8

Remark: 1. Correction Factor = Antenna factor+ Insertion loss (cable loss + amplifier gain)

802.11n (HT20) CH64

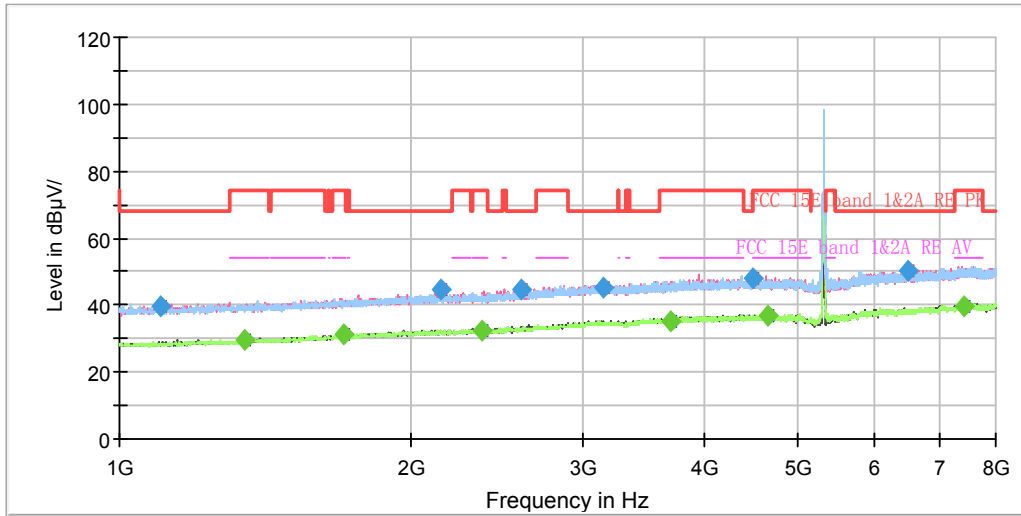

Note: The signal beyond the limit is carrier.  
Radiates Emission from 1GHz to 8GHz

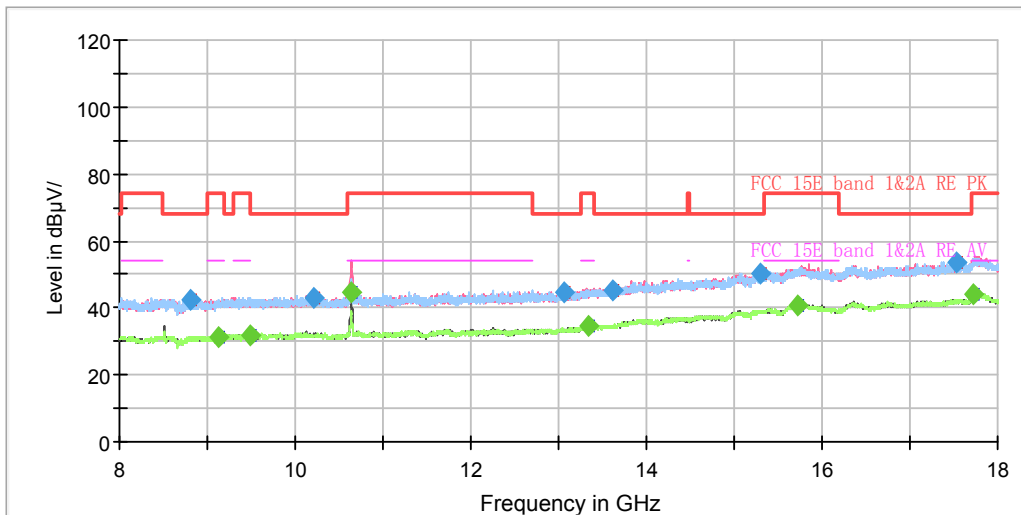

Radiates Emission from 8GHz to 18GHz



Frequency (MHz)	Peak (dBuV/m)	Average (dBuV/m)	Limit (dBuV/m)	Margin (dB)	Height (cm)	Polarization	Azimuth (deg)	Correct Factor (dB)
1101.500000	39.58	---	68.20	28.62	200.0	H	17.0	-8.3
1343.000000	---	29.41	54.00	24.59	100.0	V	126.0	-7.0
1704.375000	---	31.07	54.00	22.93	200.0	V	205.0	-5.0
2143.625000	44.78	---	68.20	23.42	200.0	V	173.0	-2.7
2367.625000	---	32.11	54.00	21.89	200.0	V	0.0	-2.1
2592.500000	44.39	---	68.20	23.81	100.0	H	0.0	-1.0
3151.625000	45.23	---	68.20	22.97	200.0	V	107.0	1.6
3702.875000	---	35.35	54.00	18.65	200.0	V	205.0	3.1
4487.750000	47.97	---	68.20	20.23	100.0	H	145.0	4.9
4654.875000	---	36.70	54.00	17.30	100.0	V	151.0	5.5
6508.125000	50.13	---	68.20	18.07	200.0	V	214.0	8.6
7419.000000	---	39.85	54.00	14.15	200.0	V	2.0	9.8

Remark: 1. Correction Factor = Antenna factor+ Insertion loss (cable loss + amplifier gain)

802.11n (HT20) CH100

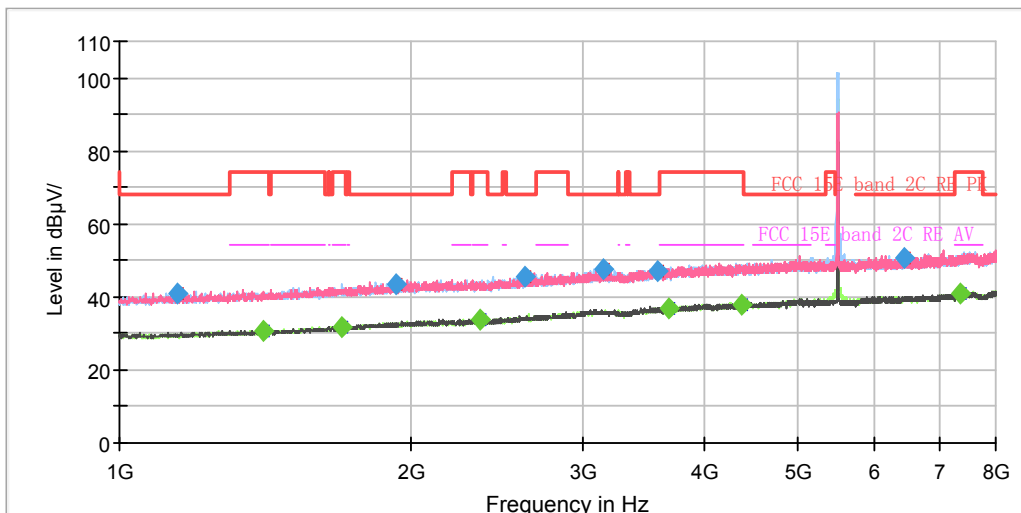

Note: The signal beyond the limit is carrier.  
Radiates Emission from 1GHz to 8GHz

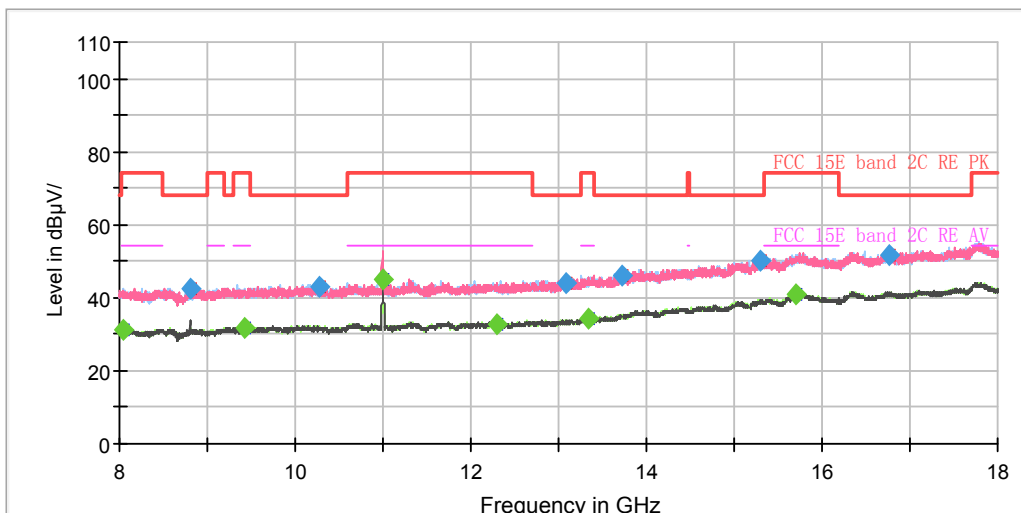

Radiates Emission from 8GHz to 18GHz



Frequency (MHz)	Peak (dBuV/m)	Average (dBuV/m)	Limit (dBuV/m)	Margin (dB)	Height (cm)	Polarization	Azimuth (deg)	Correct Factor (dB)
1148.750000	41.05	---	68.20	27.15	100.0	H	229.0	-8.1
1406.000000	---	30.49	54.00	23.51	200.0	H	192.0	-6.7
1692.125000	---	31.97	54.00	22.03	100.0	H	302.0	-5.1
1926.625000	43.51	---	68.20	24.69	100.0	H	0.0	-3.9
2349.250000	---	33.60	54.00	20.40	200.0	V	137.0	-2.1
2619.625000	45.70	---	68.20	22.50	100.0	H	273.0	-0.9
3156.875000	47.38	---	68.20	20.82	100.0	V	220.0	1.6
3579.500000	47.06	---	68.20	21.14	200.0	H	6.0	2.9
3681.000000	---	36.96	54.00	17.04	100.0	H	0.0	3.0
4383.625000	---	37.82	54.00	16.18	100.0	H	353.0	4.8
6429.375000	50.63	---	68.20	17.57	200.0	H	324.0	8.5
7350.750000	---	40.72	54.00	13.28	100.0	H	309.0	9.8

Remark: 1. Correction Factor = Antenna factor+ Insertion loss (cable loss + amplifier gain)

### 802.11n (HT20) CH116

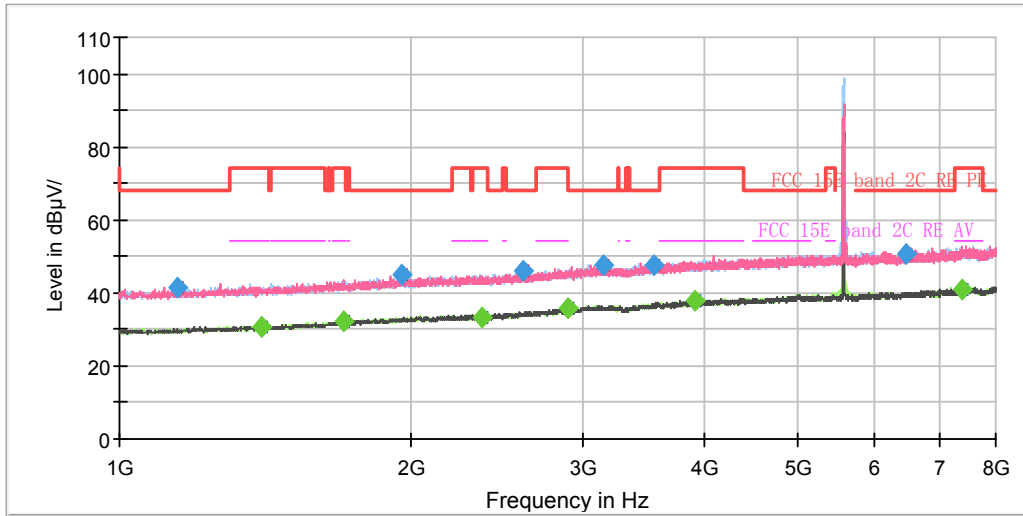

Note: The signal beyond the limit is carrier.  
Radiates Emission from 1GHz to 8GHz

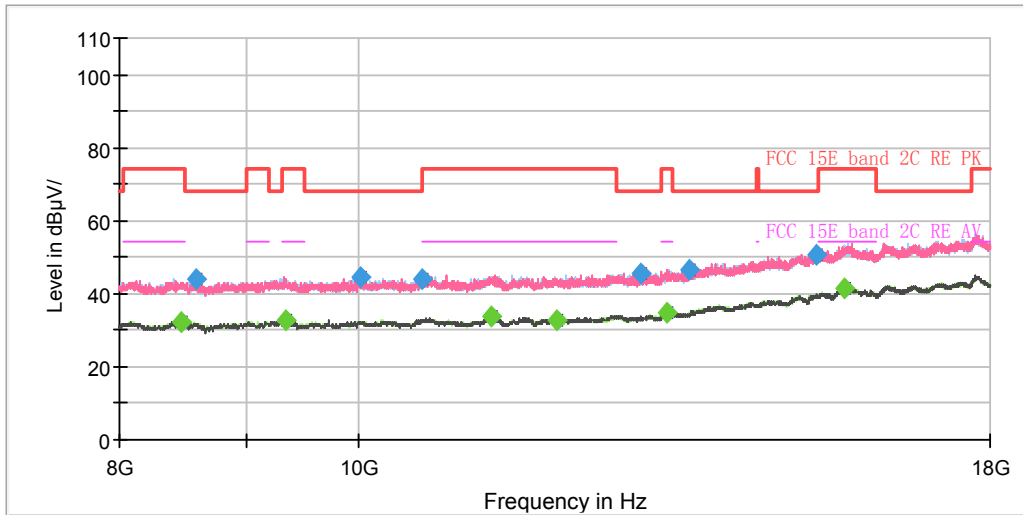

Radiates Emission from 8GHz to 18GHz





Frequency (MHz)	Peak (dBuV/m)	Average (dBuV/m)	Limit (dBuV/m)	Margin (dB)	Height (cm)	Polarization	Azimuth (deg)	Correct Factor (dB)
1148.750000	41.61	---	68.20	26.59	200.0	H	108.0	-8.1
1402.500000	---	30.80	54.00	23.20	100.0	H	273.0	-6.7
1706.125000	---	32.15	54.00	21.85	100.0	H	0.0	-5.0
1955.500000	44.95	---	68.20	23.25	200.0	V	211.0	-3.6
2360.625000	---	33.41	54.00	20.59	200.0	H	0.0	-2.1
2608.250000	46.00	---	68.20	22.20	200.0	H	78.0	-0.9
2893.500000	---	35.68	54.00	18.32	100.0	H	180.0	0.5
3153.375000	47.48	---	68.20	20.72	200.0	V	247.0	1.6
3546.250000	47.48	---	68.20	20.72	100.0	H	9.0	2.6
3920.750000	---	37.67	54.00	16.33	100.0	H	353.0	3.8
6454.750000	50.49	---	68.20	17.71	100.0	V	231.0	8.5
7384.000000	---	41.14	54.00	12.86	100.0	V	102.0	9.8

Remark: 1. Correction Factor = Antenna factor+ Insertion loss (cable loss + amplifier gain)

802.11n (HT20) CH140

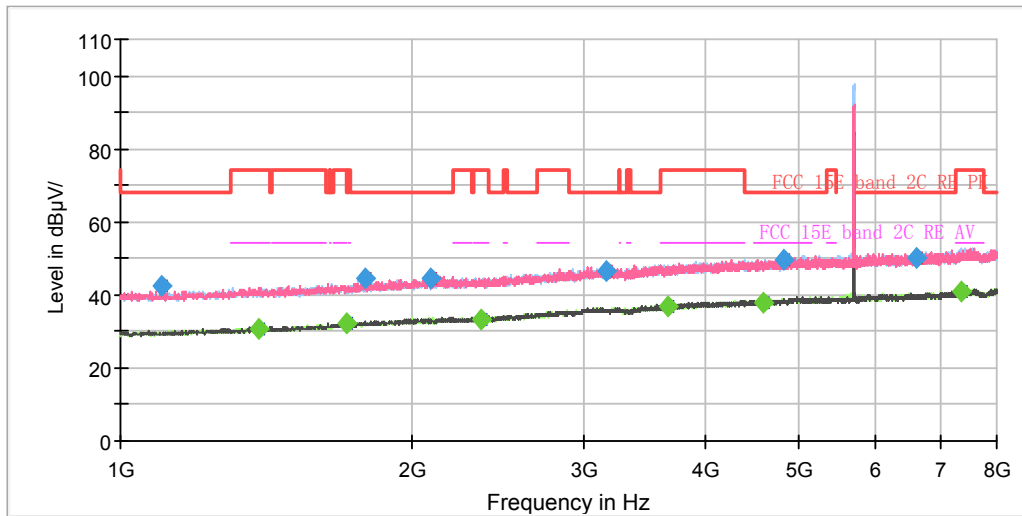

Note: The signal beyond the limit is carrier.  
Radiates Emission from 1GHz to 8GHz

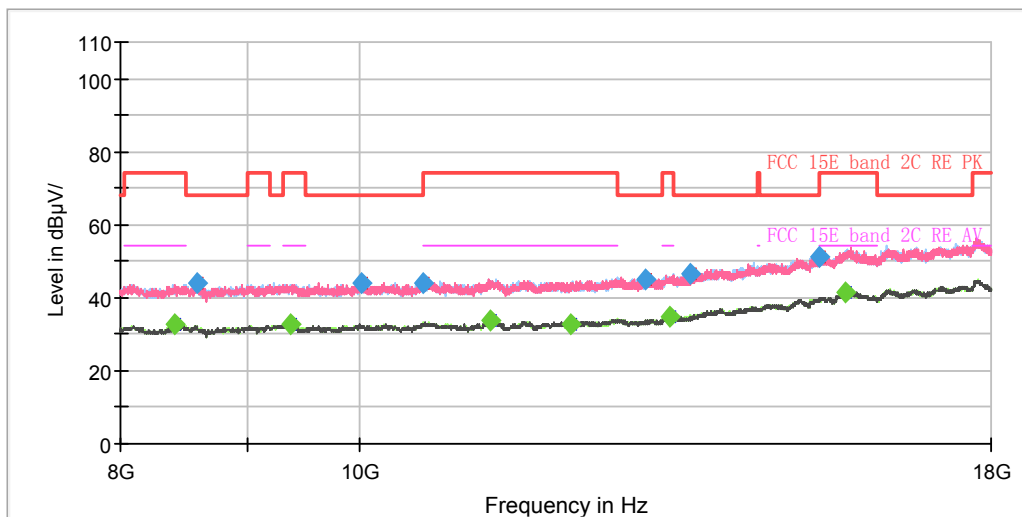

Radiates Emission from 8GHz to 18GHz



Frequency (MHz)	Peak (dBuV/m)	Average (dBuV/m)	Limit (dBuV/m)	Margin (dB)	Height (cm)	Polarization	Azimuth (deg)	Correct Factor (dB)
1102.375000	42.28	---	68.20	25.92	100.0	H	147.0	-8.3
1387.625000	---	30.68	54.00	23.32	200.0	H	183.0	-6.8
1707.875000	---	32.09	54.00	21.91	200.0	H	64.0	-5.0
1791.000000	44.47	---	68.20	23.73	200.0	V	343.0	-4.5
2087.625000	44.58	---	68.20	23.62	200.0	V	343.0	-3.0
2353.625000	---	33.46	54.00	20.54	200.0	H	27.0	-2.1
3160.375000	46.66	---	68.20	21.54	100.0	H	296.0	1.6
3667.875000	---	36.93	54.00	17.07	200.0	H	13.0	3.0
4596.250000	---	38.06	54.00	15.94	100.0	H	200.0	5.2
4819.375000	49.78	---	68.20	18.42	200.0	V	158.0	5.9
6617.500000	50.38	---	68.20	17.82	200.0	H	337.0	8.7
7363.000000	---	41.16	54.00	12.84	100.0	V	175.0	9.8

Remark: 1. Correction Factor = Antenna factor+ Insertion loss (cable loss + amplifier gain)

802.11n (HT20) CH149

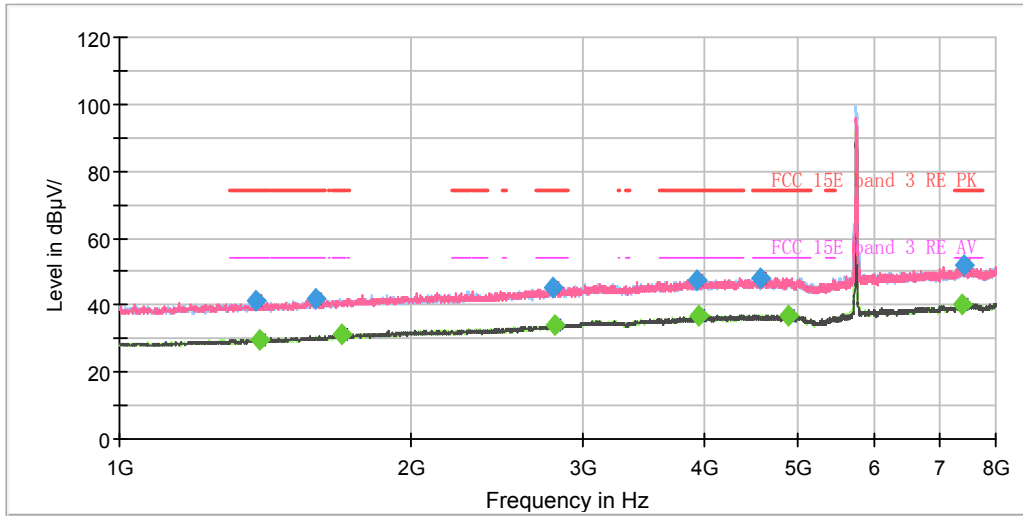

Note: The signal beyond the limit is carrier.  
Radiates Emission from 1GHz to 8GHz

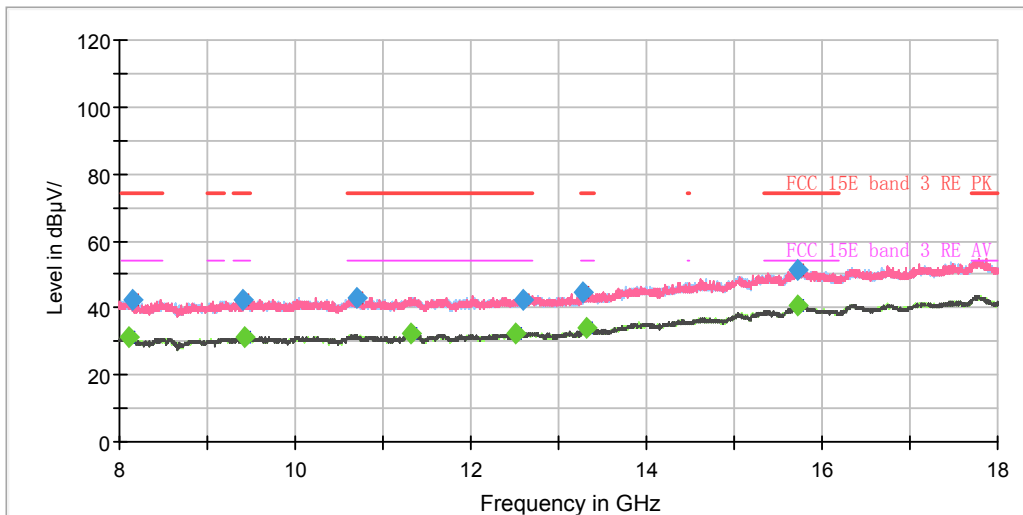

Radiates Emission from 8GHz to 18GHz



Frequency (MHz)	Peak (dBuV/m)	Average (dBuV/m)	Limit (dBuV/m)	Margin (dB)	Height (cm)	Polarization	Azimuth (deg)	Correct Factor (dB)
1385.000000	41.23	---	74.00	32.77	100.0	H	16.0	-6.8
1396.375000	---	29.72	54.00	24.28	200.0	H	323.0	-6.7
1589.750000	41.81	---	74.00	32.19	100.0	V	244.0	-5.6
1691.250000	---	31.06	54.00	22.94	100.0	V	229.0	-5.1
2797.250000	45.29	---	74.00	28.71	100.0	H	88.0	0.1
2813.875000	---	34.15	54.00	19.85	100.0	H	202.0	0.2
3935.625000	47.52	---	74.00	26.48	200.0	V	342.0	3.9
3956.625000	---	36.57	54.00	17.43	100.0	V	337.0	3.9
4579.625000	48.17	---	74.00	25.83	100.0	H	45.0	5.2
4889.375000	---	37.01	54.00	16.99	200.0	V	342.0	6.3
7388.375000	---	40.42	54.00	13.58	200.0	V	1.0	9.8
7421.625000	51.87	---	74.00	22.13	200.0	H	338.0	9.8

Remark: 1. Correction Factor = Antenna factor+ Insertion loss (cable loss + amplifier gain)

802.11n (HT20) CH157

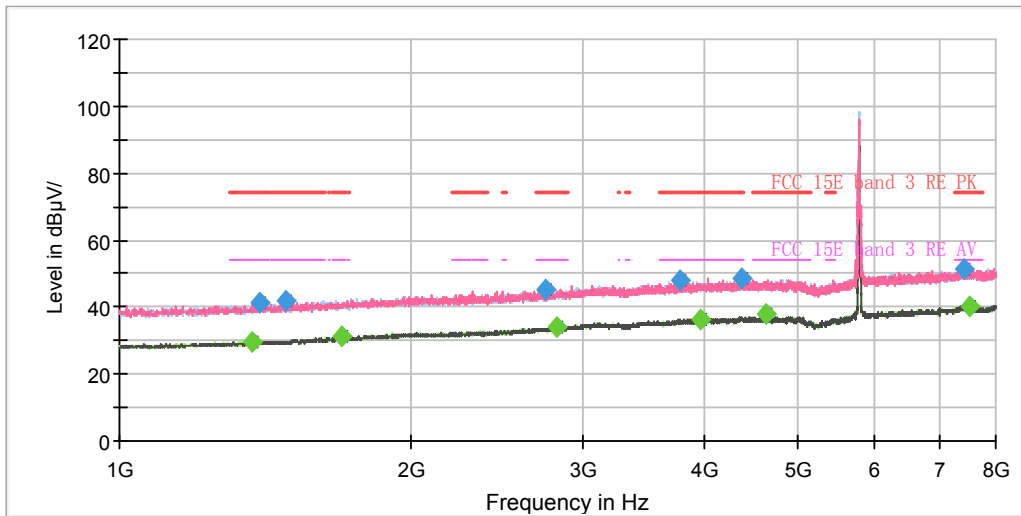

Note: The signal beyond the limit is carrier.  
Radiates Emission from 1GHz to 8GHz

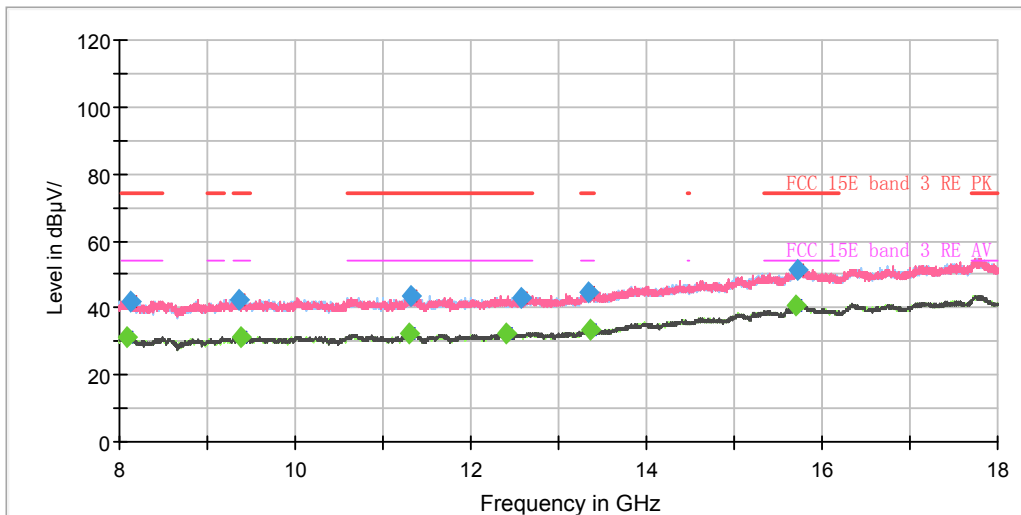

Radiates Emission from 8GHz to 18GHz



Frequency (MHz)	Peak (dBuV/m)	Average (dBuV/m)	Limit (dBuV/m)	Margin (dB)	Height (cm)	Polarization	Azimuth (deg)	Correct Factor (dB)
1367.500000	---	29.84	54.00	24.16	100.0	V	125.0	-6.9
1397.250000	41.42	---	74.00	32.58	200.0	V	334.0	-6.7
1483.000000	42.00	---	74.00	32.00	200.0	H	179.0	-6.2
1691.250000	---	31.09	54.00	22.91	100.0	H	163.0	-5.1
2745.625000	45.09	---	74.00	28.91	100.0	H	206.0	-0.2
2824.375000	---	34.06	54.00	19.94	200.0	V	64.0	0.2
3786.000000	47.74	---	74.00	26.26	100.0	H	111.0	3.5
3965.375000	---	36.54	54.00	17.46	200.0	H	353.0	3.9
4374.000000	48.57	---	74.00	25.43	200.0	H	359.0	4.8
4627.750000	---	37.85	54.00	16.15	100.0	H	0.0	5.3
7404.125000	51.58	---	74.00	22.42	100.0	H	111.0	9.8
7503.000000	---	40.41	54.00	13.59	100.0	V	241.0	9.9

Remark: 1. Correction Factor = Antenna factor+ Insertion loss (cable loss + amplifier gain)



802.11n (HT20) CH165

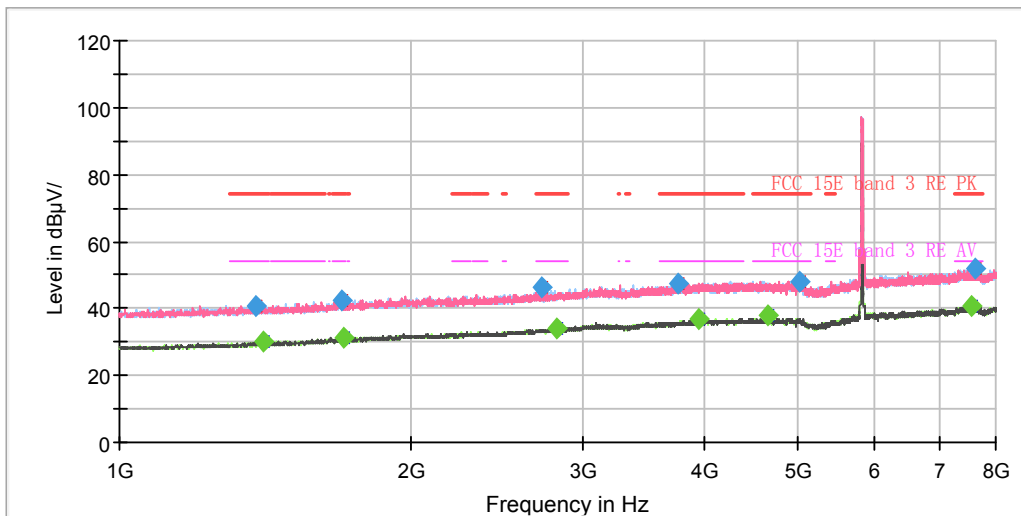

Note: The signal beyond the limit is carrier.  
Radiates Emission from 1GHz to 8GHz

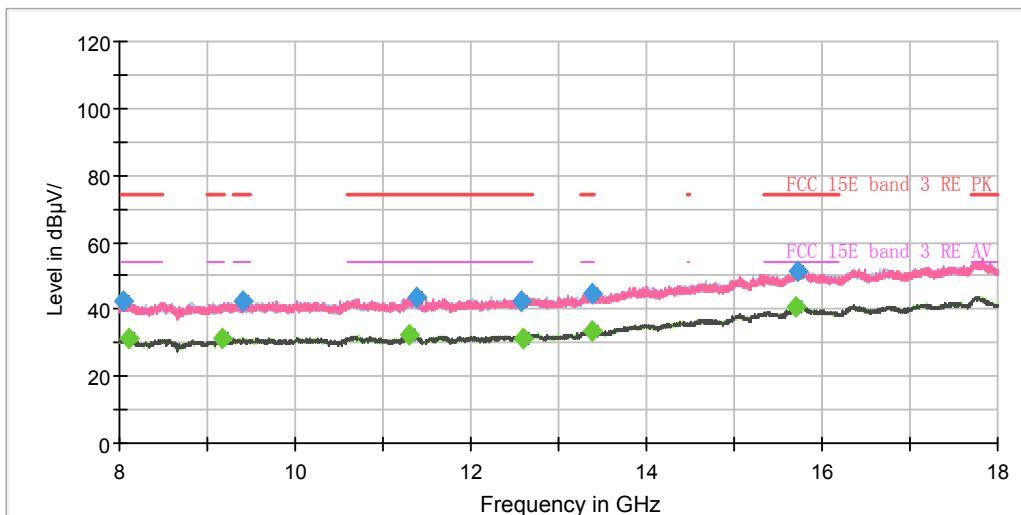

Radiates Emission from 8GHz to 18GHz





Frequency (MHz)	Peak (dBuV/m)	Average (dBuV/m)	Limit (dBuV/m)	Margin (dB)	Height (cm)	Polarization	Azimuth (deg)	Correct Factor (dB)
1383.250000	40.99	---	74.00	33.01	200.0	V	83.0	-6.8
1405.125000	---	30.24	54.00	23.76	100.0	H	33.0	-6.7
1697.375000	42.16	---	74.00	31.84	200.0	H	287.0	-5.0
1700.000000	---	30.98	54.00	23.02	200.0	H	294.0	-5.0
2728.125000	46.34	---	74.00	27.66	200.0	V	54.0	-0.4
2827.875000	---	33.96	54.00	20.04	200.0	H	242.0	0.2
3758.875000	47.35	---	74.00	26.65	100.0	V	106.0	3.3
3946.125000	---	36.78	54.00	17.22	200.0	V	235.0	3.9
4660.125000	---	38.06	54.00	15.94	100.0	H	155.0	5.5
5027.625000	48.14	---	74.00	25.86	200.0	V	54.0	6.6
7564.250000	---	40.54	54.00	13.46	200.0	H	21.0	10.0
7620.250000	51.64	---	74.00	22.36	100.0	V	0.0	10.2

Remark: 1. Correction Factor = Antenna factor+ Insertion loss (cable loss + amplifier gain)

## 802.11n (HT40) CH38

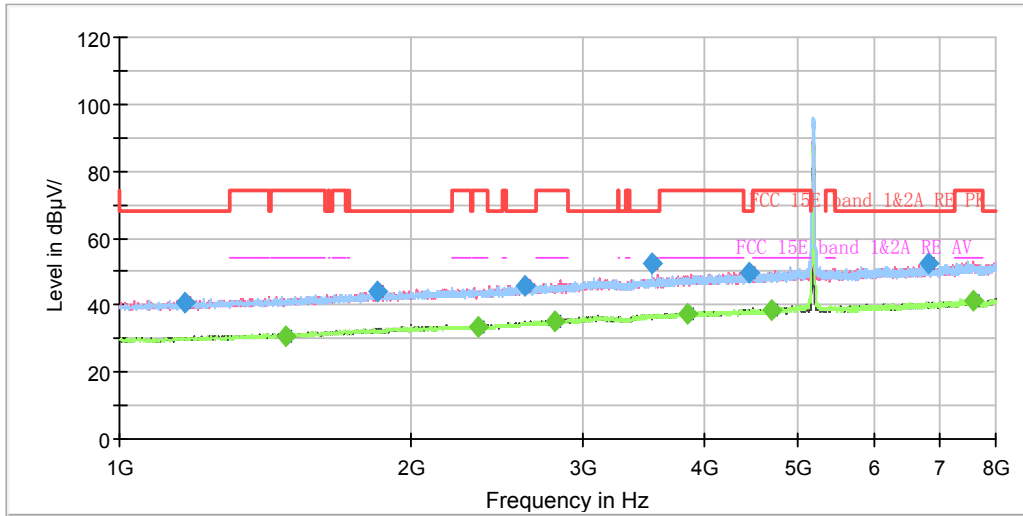

Note: The signal beyond the limit is carrier.  
Radiates Emission from 1GHz to 8GHz

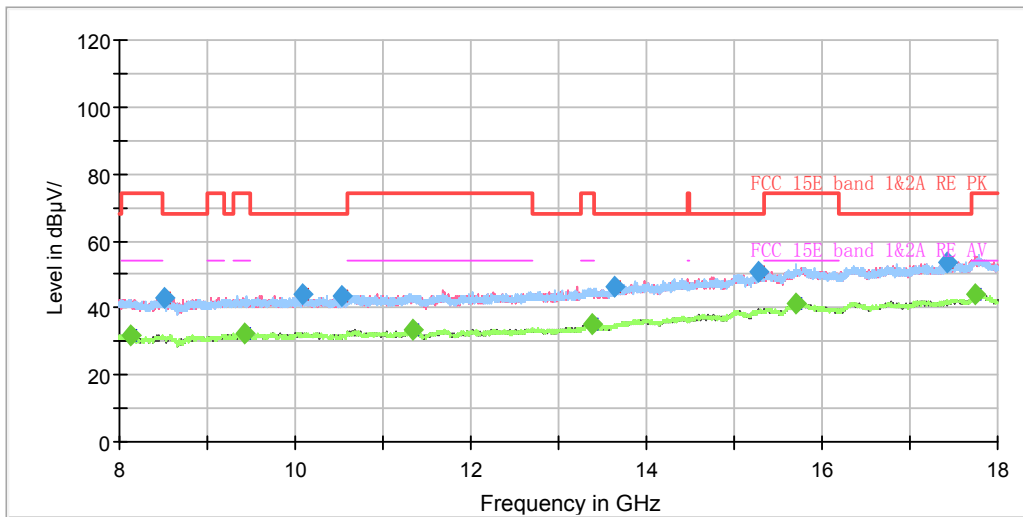

Radiates Emission from 8GHz to 18GHz



Frequency (MHz)	Peak (dBuV/m)	Average (dBuV/m)	Limit (dBuV/m)	Margin (dB)	Height (cm)	Polarization	Azimuth (deg)	Correct Factor (dB)
1167.125000	40.93	---	68.20	27.27	100.0	H	163.0	-8.0
1481.250000	---	30.89	54.00	23.11	100.0	V	123.0	-6.3
1846.125000	43.99	---	68.20	24.21	200.0	H	68.0	-4.3
2342.250000	---	33.47	54.00	20.53	200.0	V	16.0	-2.1
2615.250000	45.55	---	68.20	22.65	100.0	H	256.0	-0.9
2813.875000	---	34.88	54.00	19.12	100.0	V	339.0	0.2
3533.125000	52.63	---	68.20	15.57	200.0	H	176.0	2.5
3848.125000	---	37.51	54.00	16.49	200.0	V	291.0	3.7
4450.125000	49.77	---	68.20	18.43	100.0	H	177.0	4.9
4695.125000	---	38.67	54.00	15.33	200.0	V	159.0	5.6
6816.125000	52.20	---	68.20	16.00	200.0	V	103.0	9.1
7574.750000	---	41.22	54.00	12.78	100.0	V	231.0	10.1

Remark: 1. Correction Factor = Antenna factor+ Insertion loss (cable loss + amplifier gain)

802.11n (HT40) CH46

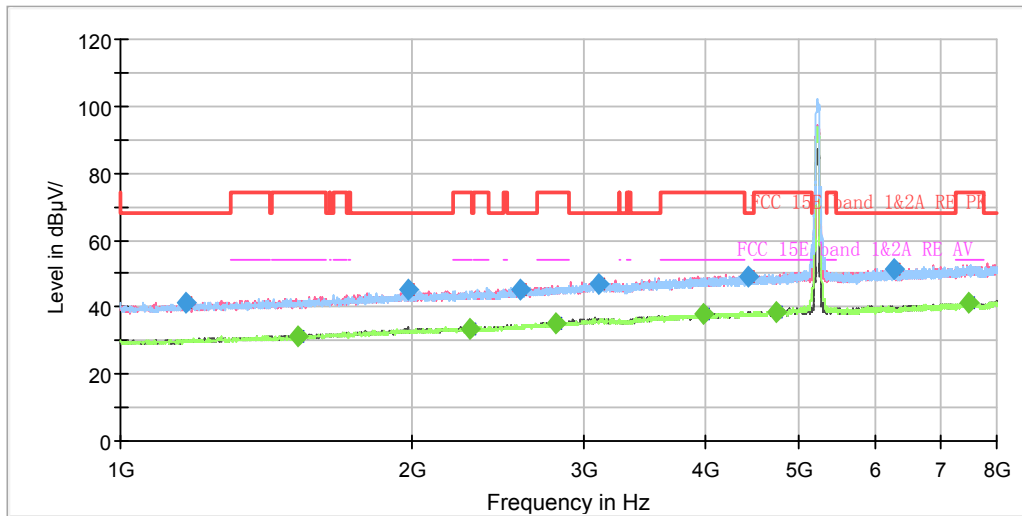

Note: The signal beyond the limit is carrier.  
Radiates Emission from 1GHz to 8GHz

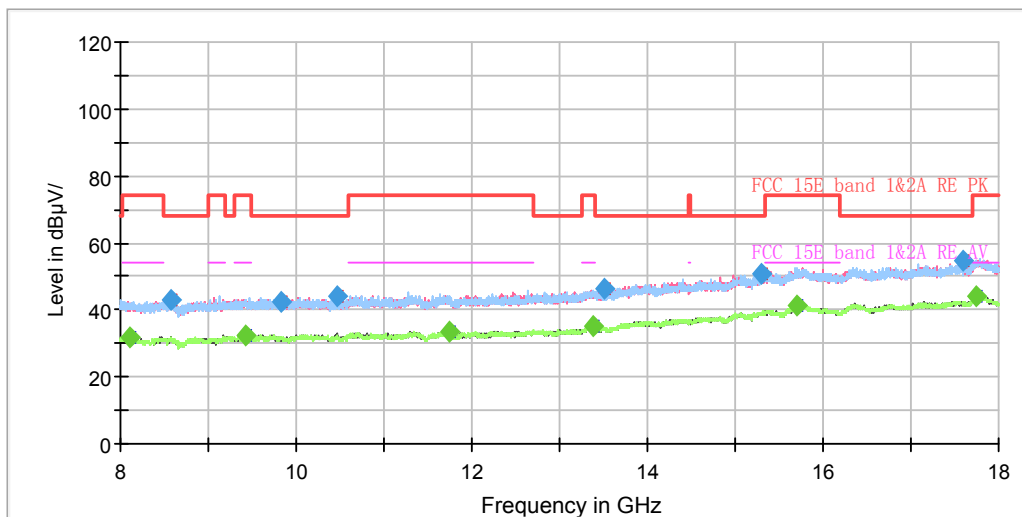

Radiates Emission from 8GHz to 18GHz



Frequency (MHz)	Peak (dBuV/m)	Average (dBuV/m)	Limit (dBuV/m)	Margin (dB)	Height (cm)	Polarization	Azimuth (deg)	Correct Factor (dB)
1169.750000	41.45	---	68.20	26.75	100.0	V	177.0	-8.0
1525.000000	---	31.14	54.00	22.86	200.0	V	50.0	-6.0
1976.500000	44.95	---	68.20	23.25	100.0	H	214.0	-3.5
2294.125000	---	33.42	54.00	20.58	200.0	V	98.0	-2.2
2587.250000	45.39	---	68.20	22.81	200.0	V	241.0	-1.0
2806.875000	---	35.03	54.00	18.97	100.0	V	49.0	0.1
3111.375000	47.10	---	68.20	21.10	100.0	V	350.0	1.6
3995.125000	---	38.00	54.00	16.00	200.0	H	125.0	4.0
4445.750000	49.39	---	68.20	18.81	100.0	H	342.0	4.9
4732.750000	---	38.43	54.00	15.57	100.0	V	21.0	5.7
6263.125000	51.31	---	68.20	16.89	200.0	V	0.0	8.2
7469.750000	---	41.33	54.00	12.67	200.0	V	43.0	9.8

Remark: 1. Correction Factor = Antenna factor+ Insertion loss (cable loss + amplifier gain)

### 802.11n (HT40) CH54

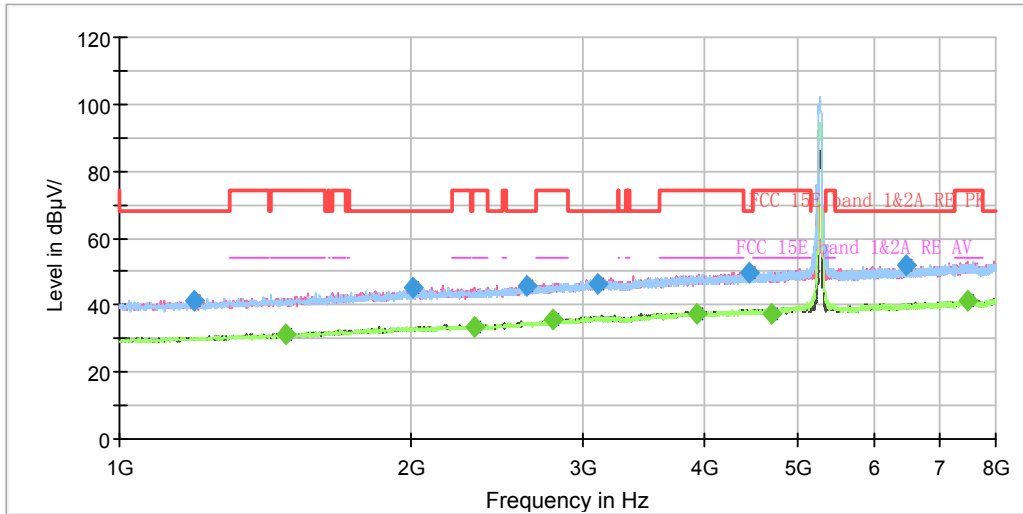

Note: The signal beyond the limit is carrier.  
Radiates Emission from 1GHz to 8GHz

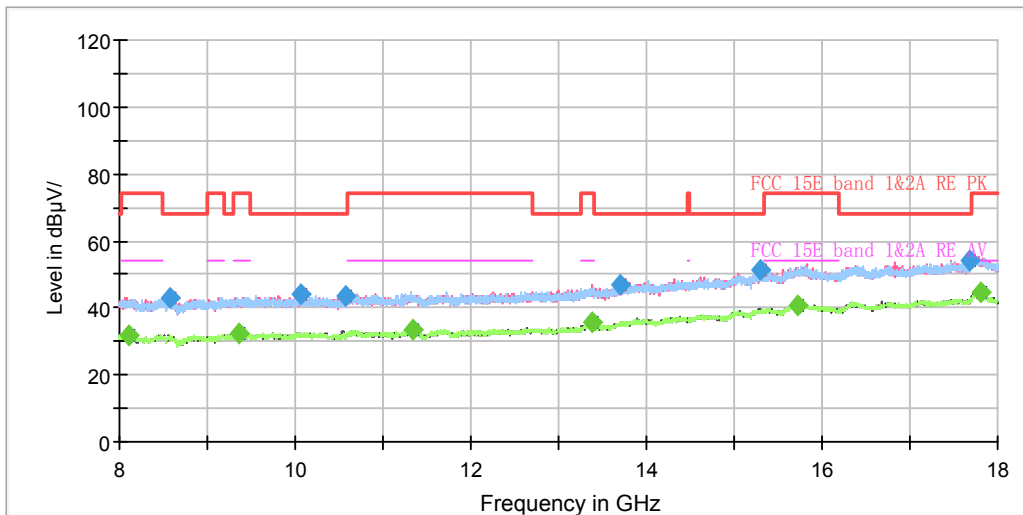

Radiates Emission from 8GHz to 18GHz



Frequency (MHz)	Peak (dBuV/m)	Average (dBuV/m)	Limit (dBuV/m)	Margin (dB)	Height (cm)	Polarization	Azimuth (deg)	Correct Factor (dB)
1192.500000	41.54	---	68.20	26.66	200.0	V	12.0	-7.8
1483.000000	---	31.22	54.00	22.78	200.0	V	171.0	-6.2
2001.875000	45.03	---	68.20	23.17	200.0	V	206.0	-3.4
2318.625000	---	33.45	54.00	20.55	200.0	V	91.0	-2.2
2630.125000	45.56	---	68.20	22.65	200.0	V	12.0	-0.8
2800.750000	---	35.75	54.00	18.25	200.0	V	346.0	0.1
3107.875000	46.15	---	68.20	22.05	100.0	V	297.0	1.6
3933.875000	---	37.59	54.00	16.41	100.0	V	103.0	3.9
4457.125000	49.58	---	68.20	18.62	200.0	V	0.0	4.9
4704.750000	---	37.49	54.00	16.51	100.0	H	82.0	5.6
6467.875000	51.85	---	68.20	16.35	200.0	V	156.0	8.5
7469.750000	---	41.43	54.00	12.57	200.0	V	0.0	9.8

Remark: 1. Correction Factor = Antenna factor+ Insertion loss (cable loss + amplifier gain)

## 802.11n (HT40) CH62

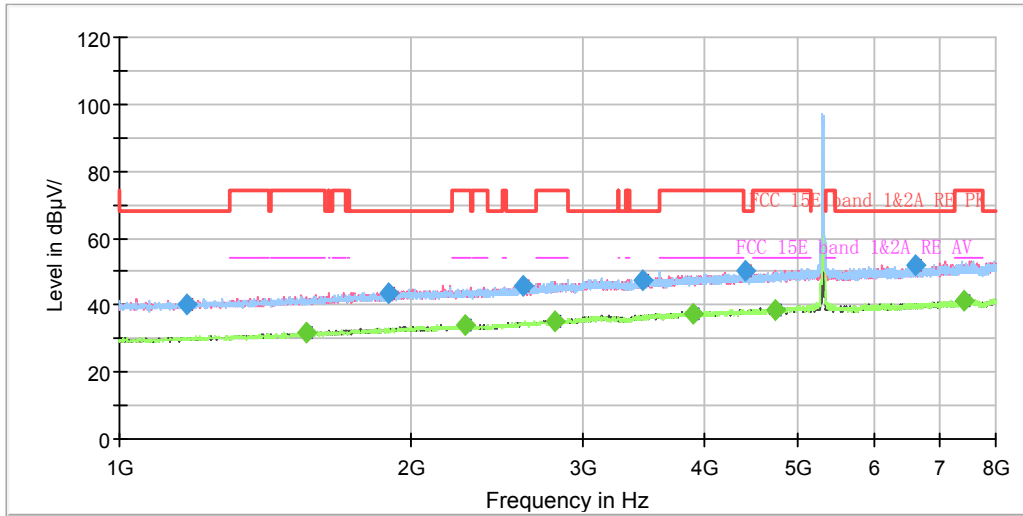

Note: The signal beyond the limit is carrier.  
Radiates Emission from 1GHz to 8GHz

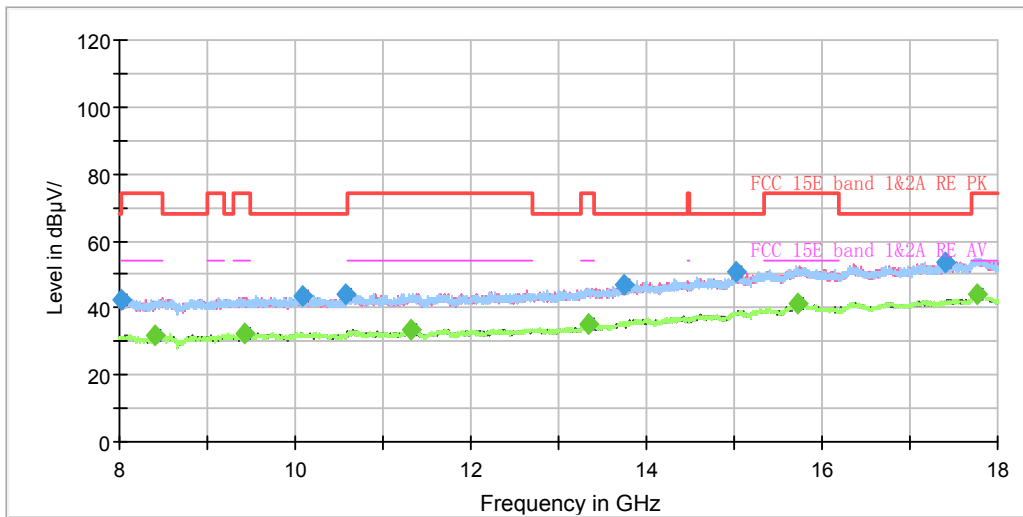

Radiates Emission from 8GHz to 18GHz





Frequency (MHz)	Peak (dBuV/m)	Average (dBuV/m)	Limit (dBuV/m)	Margin (dB)	Height (cm)	Polarization	Azimuth (deg)	Correct Factor (dB)
1173.250000	40.30	---	68.20	27.90	200.0	H	109.0	-8.0
1556.500000	---	31.78	54.00	22.22	100.0	V	147.0	-5.8
1891.625000	43.50	---	68.20	24.70	200.0	H	209.0	-4.0
2275.750000	---	33.89	54.00	20.11	100.0	V	0.0	-2.3
2601.250000	45.83	---	68.20	22.37	200.0	V	17.0	-1.0
2813.000000	---	35.28	54.00	18.72	200.0	V	89.0	0.2
3467.500000	47.70	---	68.20	20.50	200.0	V	60.0	2.2
3893.625000	---	37.53	54.00	16.47	200.0	V	265.0	3.7
4421.250000	50.10	---	68.20	18.10	200.0	V	111.0	4.9
4738.875000	---	38.59	54.00	15.41	200.0	H	109.0	5.7
6600.875000	51.76	---	68.20	16.44	100.0	V	241.0	8.7
7411.125000	---	41.25	54.00	12.75	100.0	V	298.0	9.8

Remark: 1. Correction Factor = Antenna factor+ Insertion loss (cable loss + amplifier gain)

802.11n (HT40) CH102

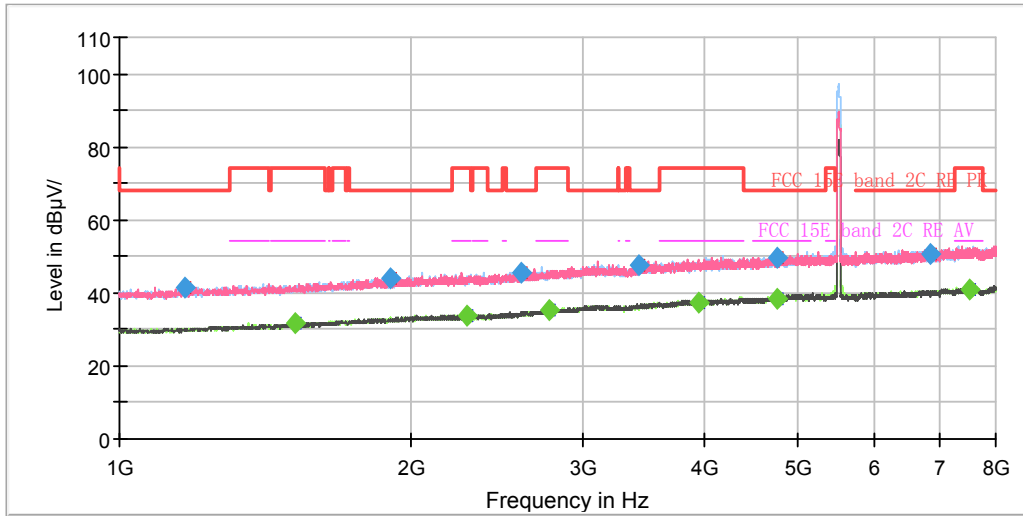

Note: The signal beyond the limit is carrier.  
Radiates Emission from 1GHz to 8GHz

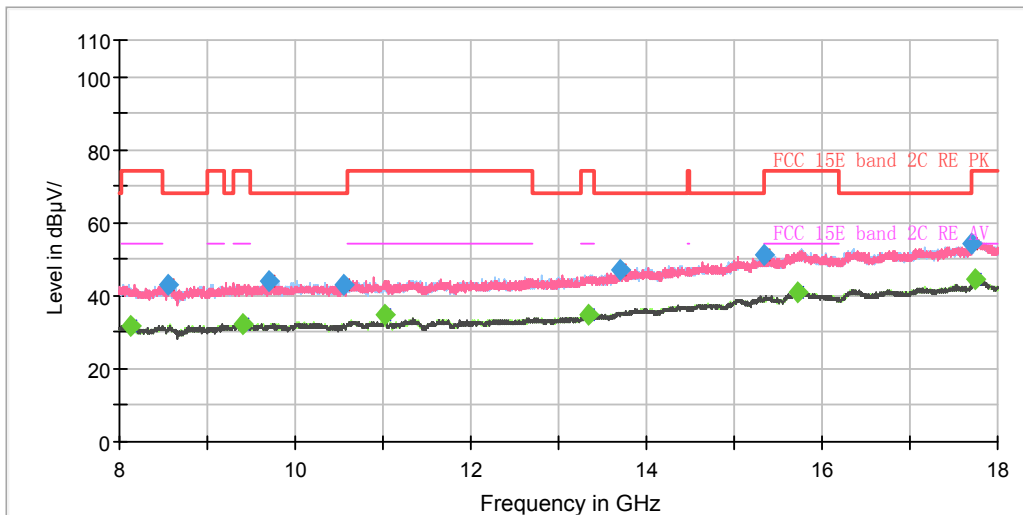

Radiates Emission from 8GHz to 18GHz



Frequency (MHz)	Peak (dBuV/m)	Average (dBuV/m)	Limit (dBuV/m)	Margin (dB)	Height (cm)	Polarization	Azimuth (deg)	Correct Factor (dB)
1168.000000	41.33	---	68.20	26.87	200.0	V	298.0	-8.0
1517.125000	---	31.59	54.00	22.41	200.0	H	70.0	-6.1
1903.875000	44.18	---	68.20	24.02	100.0	H	281.0	-3.9
2282.750000	---	33.57	54.00	20.43	100.0	H	302.0	-2.3
2597.750000	45.69	---	68.20	22.51	200.0	V	198.0	-1.0
2766.625000	---	35.07	54.00	18.93	100.0	H	352.0	-0.1
3427.250000	47.33	---	68.20	20.87	200.0	V	55.0	2.0
3951.375000	---	37.23	54.00	16.77	200.0	H	343.0	3.9
4760.750000	---	38.18	54.00	15.82	200.0	H	192.0	5.8
4766.000000	49.53	---	68.20	18.67	200.0	H	6.0	5.8
6849.375000	50.87	---	68.20	17.33	100.0	H	146.0	9.1
7529.250000	---	41.05	54.00	12.95	200.0	H	229.0	9.9

Remark: 1. Correction Factor = Antenna factor+ Insertion loss (cable loss + amplifier gain)

802.11n (HT40) CH134

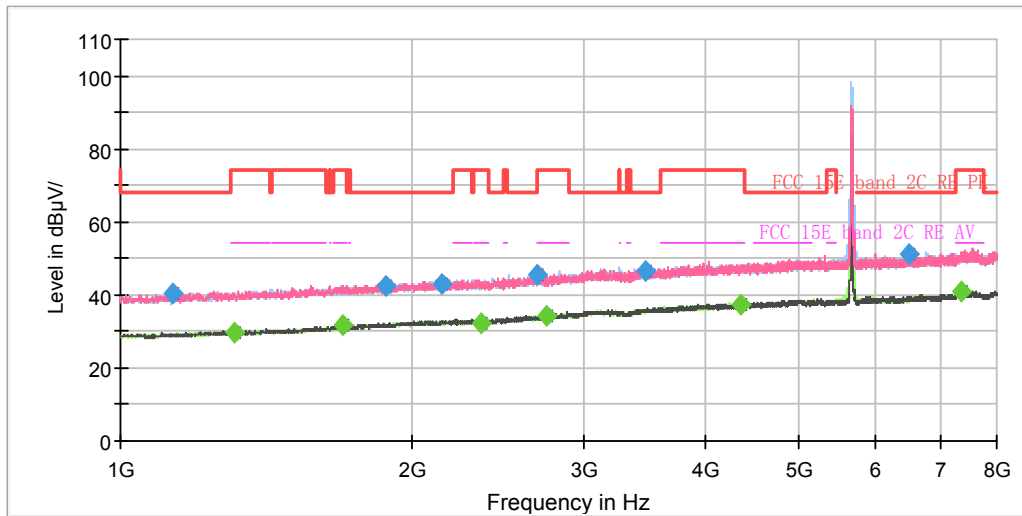

Note: The signal beyond the limit is carrier.  
Radiates Emission from 1GHz to 8GHz

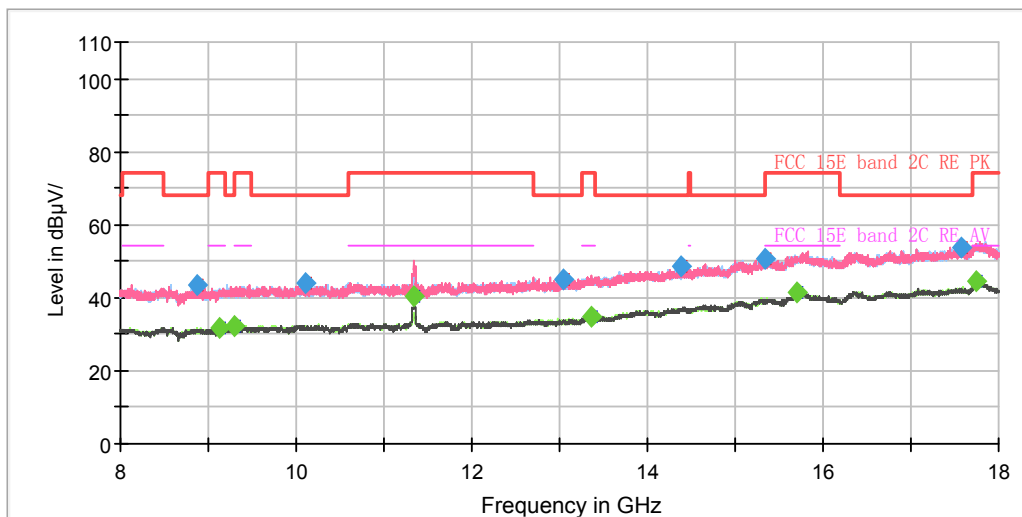

Radiates Emission from 8GHz to 18GHz



Frequency (MHz)	Peak (dBuV/m)	Average (dBuV/m)	Limit (dBuV/m)	Margin (dB)	Height (cm)	Polarization	Azimuth (deg)	Correct Factor (dB)
1133.875000	40.55	---	68.20	27.65	100.0	H	16.0	-8.2
1308.875000	---	29.47	54.00	24.53	200.0	H	23.0	-7.2
1694.750000	---	31.56	54.00	22.44	200.0	V	307.0	-5.1
1876.750000	42.59	---	68.20	25.61	200.0	V	292.0	-4.1
2146.250000	43.14	---	68.20	25.06	200.0	H	54.0	-2.7
2353.625000	---	32.41	54.00	21.59	200.0	H	69.0	-2.1
2682.625000	45.52	---	68.20	22.68	200.0	H	105.0	-0.6
2743.000000	---	34.27	54.00	19.73	200.0	H	9.0	-0.3
3481.500000	46.65	---	68.20	21.55	100.0	V	207.0	2.2
4361.750000	---	37.59	54.00	16.41	200.0	H	105.0	4.8
6500.250000	51.34	---	68.20	16.86	200.0	V	226.0	8.6
7363.000000	---	40.93	54.00	13.07	200.0	H	9.0	9.8

Remark: 1. Correction Factor = Antenna factor+ Insertion loss (cable loss + amplifier gain)

802.11n (HT40) CH151

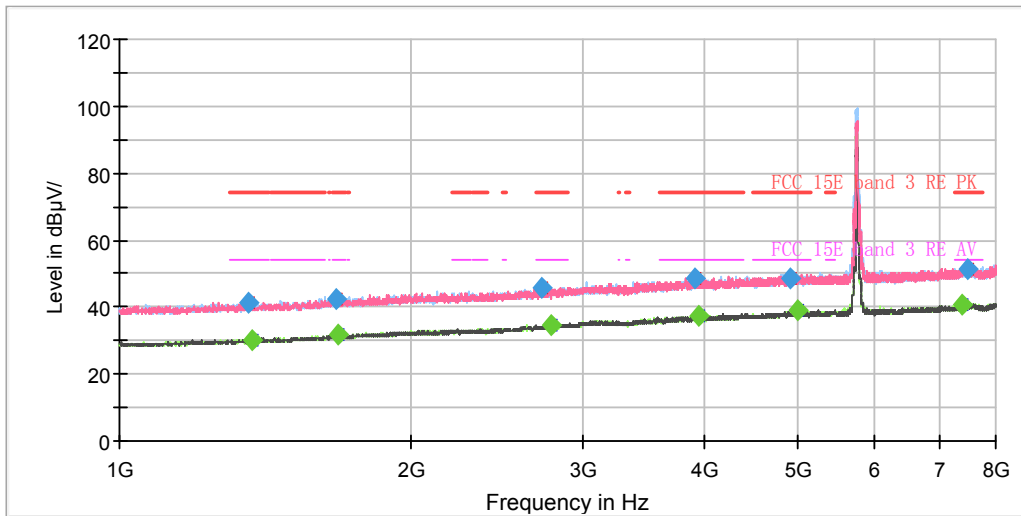

Note: The signal beyond the limit is carrier.  
Radiates Emission from 1GHz to 8GHz

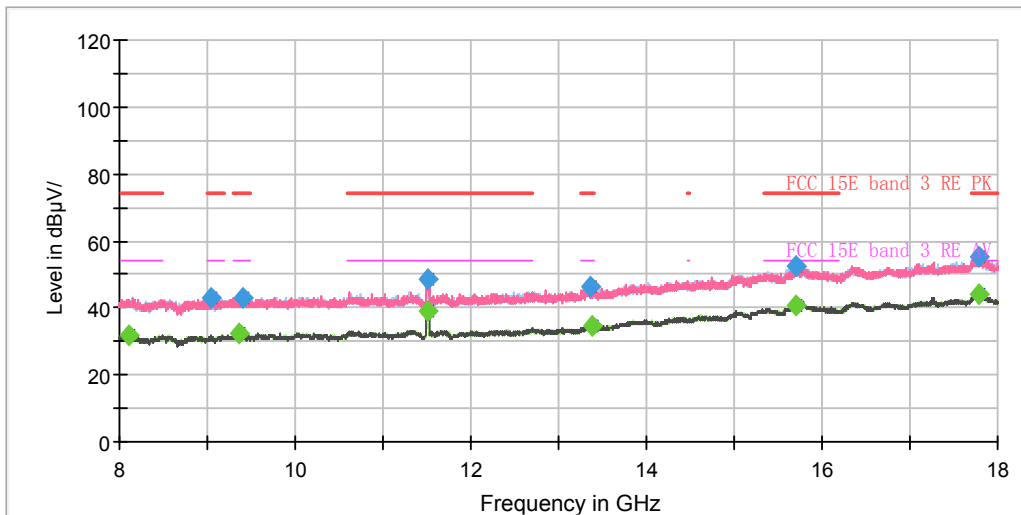

Radiates Emission from 8GHz to 18GHz



Frequency (MHz)	Peak (dBuV/m)	Average (dBuV/m)	Limit (dBuV/m)	Margin (dB)	Height (cm)	Polarization	Azimuth (deg)	Correct Factor (dB)
1355.840000	41.18	---	74.00	32.82	100.0	V	19.0	-7.0
1369.113750	---	30.38	54.00	23.62	200.0	H	0.0	-6.9
1676.027500	42.37	---	74.00	31.63	200.0	V	340.0	-5.1
1680.068750	---	31.81	54.00	22.19	100.0	V	19.0	-5.1
2717.936250	45.56	---	74.00	28.44	100.0	V	85.0	-0.4
2783.928750	---	34.62	54.00	19.38	200.0	V	185.0	0.0
3918.416250	48.77	---	74.00	25.23	100.0	V	157.0	3.8
3954.991250	---	37.45	54.00	16.55	200.0	V	244.0	3.9
4907.427500	48.79	---	74.00	25.21	100.0	V	318.0	6.4
4994.342500	---	38.88	54.00	15.12	200.0	V	0.0	6.6
7389.205000	---	40.95	54.00	13.05	200.0	H	326.0	9.8
7471.908750	51.30	---	74.00	22.70	200.0	H	93.0	9.8

Remark: 1. Correction Factor = Antenna factor+ Insertion loss (cable loss + amplifier gain)

802.11n (HT40) CH159

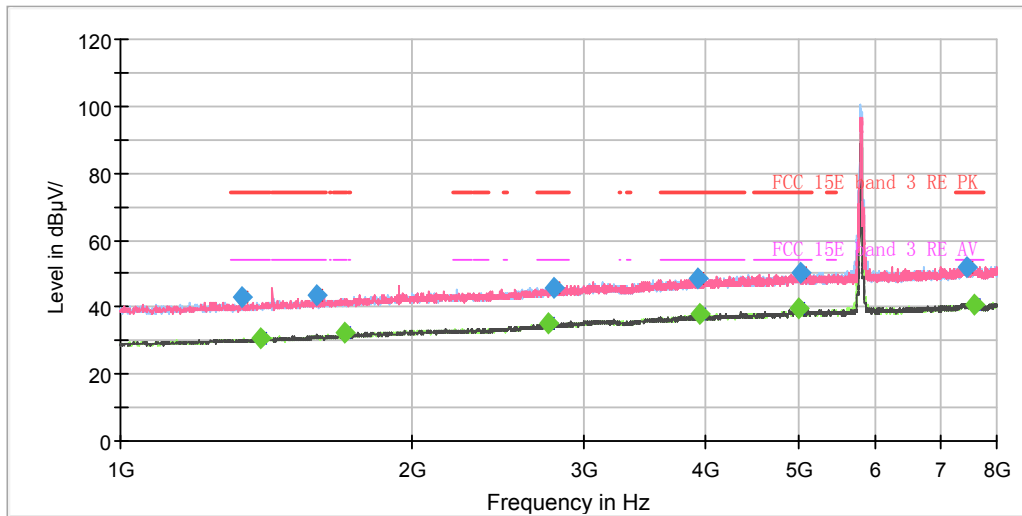

Note: The signal beyond the limit is carrier.  
Radiates Emission from 1GHz to 8GHz

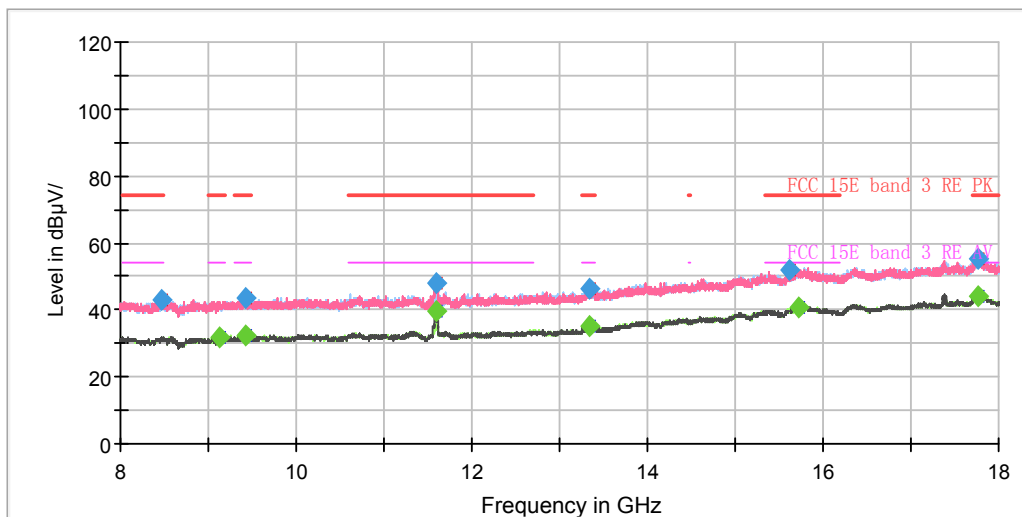

Radiates Emission from 8GHz to 18GHz





Frequency (MHz)	Peak (dBuV/m)	Average (dBuV/m)	Limit (dBuV/m)	Margin (dB)	Height (cm)	Polarization	Azimuth (deg)	Correct Factor (dB)
1332.500000	42.79	---	74.00	31.21	100.0	V	247.0	-7.1
1393.750000	---	30.87	54.00	23.13	200.0	H	84.0	-6.7
1591.500000	43.61	---	74.00	30.39	100.0	H	156.0	-5.6
1700.000000	---	32.18	54.00	21.82	200.0	V	68.0	-5.0
2758.750000	---	35.05	54.00	18.95	100.0	V	269.0	-0.2
2792.000000	46.03	---	74.00	27.97	200.0	H	54.0	0.0
3935.625000	48.40	---	74.00	25.60	100.0	H	353.0	3.9
3956.625000	---	37.80	54.00	16.20	200.0	H	351.0	3.9
5004.000000	---	39.37	54.00	14.63	200.0	V	62.0	6.6
5026.750000	50.19	---	74.00	23.81	200.0	H	0.0	6.6
7447.000000	52.08	---	74.00	21.92	200.0	V	277.0	9.8
7594.000000	---	41.01	54.00	12.99	200.0	V	270.0	10.1

Remark: 1. Correction Factor = Antenna factor+ Insertion loss (cable loss + amplifier gain)

802.11ac (HT80) CH42

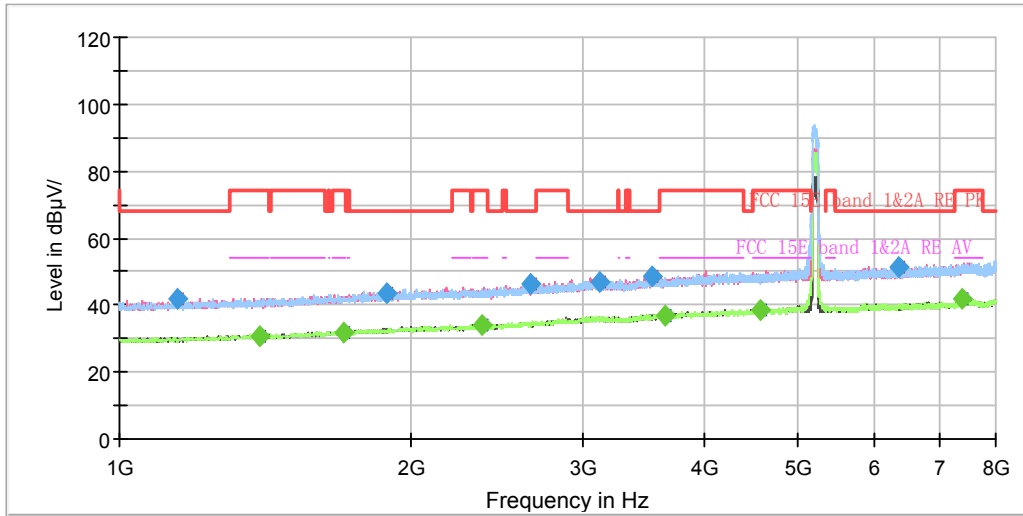

Note: The signal beyond the limit is carrier.  
Radiates Emission from 1GHz to 8GHz

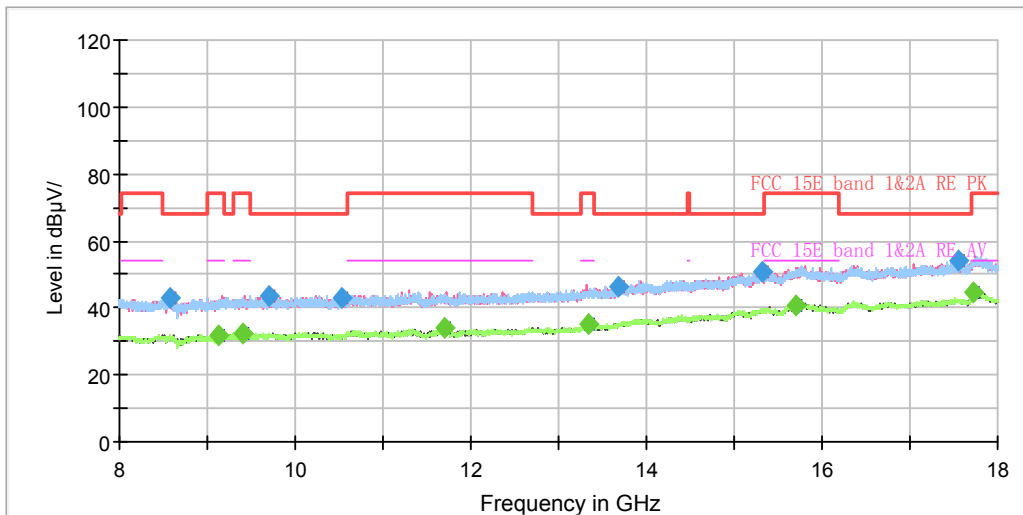

Radiates Emission from 8GHz to 18GHz



Frequency (MHz)	Peak (dBuV/m)	Average (dBuV/m)	Limit (dBuV/m)	Margin (dB)	Height (cm)	Polarization	Azimuth (deg)	Correct Factor (dB)
1149.625000	42.01	---	68.20	26.19	200.0	H	226.0	-8.1
1395.500000	---	30.47	54.00	23.53	200.0	V	128.0	-6.7
1702.625000	---	32.09	54.00	21.91	100.0	V	21.0	-5.0
1882.875000	43.74	---	68.20	24.46	100.0	V	118.0	-4.0
2367.625000	---	33.78	54.00	20.22	200.0	V	342.0	-2.1
2651.125000	46.55	---	68.20	21.65	200.0	V	166.0	-0.8
3128.875000	47.09	---	68.20	21.11	100.0	H	0.0	1.6
3536.625000	48.37	---	68.20	19.83	200.0	V	121.0	2.5
3650.375000	---	37.02	54.00	16.98	100.0	H	65.0	2.8
4582.250000	---	38.69	54.00	15.31	200.0	H	338.0	5.2
6359.375000	51.56	---	68.20	16.64	200.0	V	34.0	8.3
7400.625000	---	41.64	54.00	12.36	200.0	H	14.0	9.8

Remark: 1. Correction Factor = Antenna factor+ Insertion loss (cable loss + amplifier gain)

802.11ac (HT80) CH58

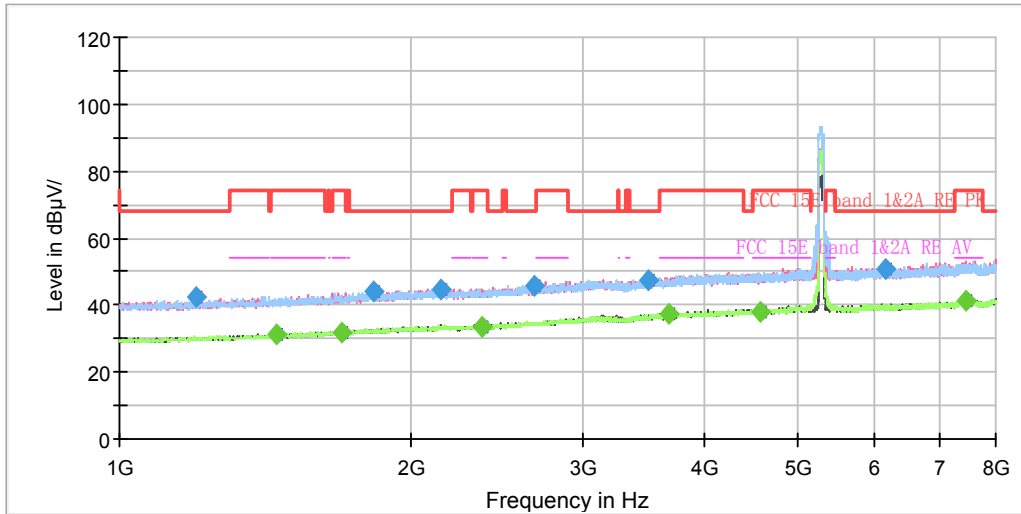

Note: The signal beyond the limit is carrier.  
Radiates Emission from 1GHz to 8GHz

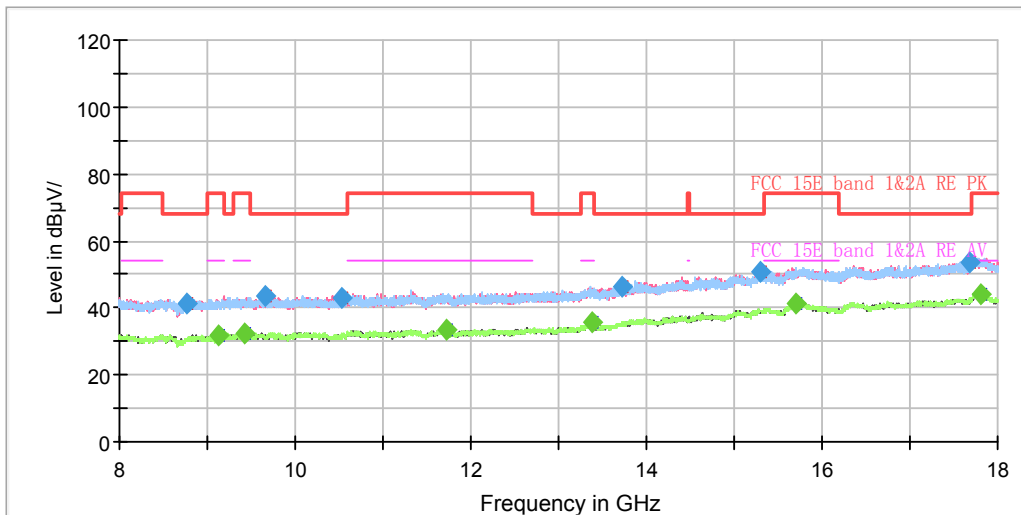

Radiates Emission from 8GHz to 18GHz



Frequency (MHz)	Peak (dBuV/m)	Average (dBuV/m)	Limit (dBuV/m)	Margin (dB)	Height (cm)	Polarization	Azimuth (deg)	Correct Factor (dB)
1201.250000	42.36	---	68.20	25.84	100.0	V	248.0	-7.8
1450.625000	---	31.01	54.00	22.99	100.0	H	11.0	-6.4
1693.875000	---	32.06	54.00	21.94	200.0	V	105.0	-5.1
1825.125000	44.05	---	68.20	24.15	100.0	H	314.0	-4.2
2140.125000	44.47	---	68.20	23.73	200.0	H	195.0	-2.8
2359.750000	---	33.34	54.00	20.66	200.0	V	142.0	-2.1
2678.250000	45.76	---	68.20	22.44	100.0	V	319.0	-0.6
3500.750000	47.57	---	68.20	20.63	100.0	V	340.0	2.3
3676.625000	---	37.16	54.00	16.84	200.0	H	331.0	3.0
4583.125000	---	38.18	54.00	15.82	100.0	V	0.0	5.2
6146.750000	50.75	---	68.20	17.45	200.0	V	280.0	8.1
7456.625000	---	41.43	54.00	12.57	200.0	V	1.0	9.8

Remark: 1. Correction Factor = Antenna factor+ Insertion loss (cable loss + amplifier gain)

802.11ac (HT80) CH106

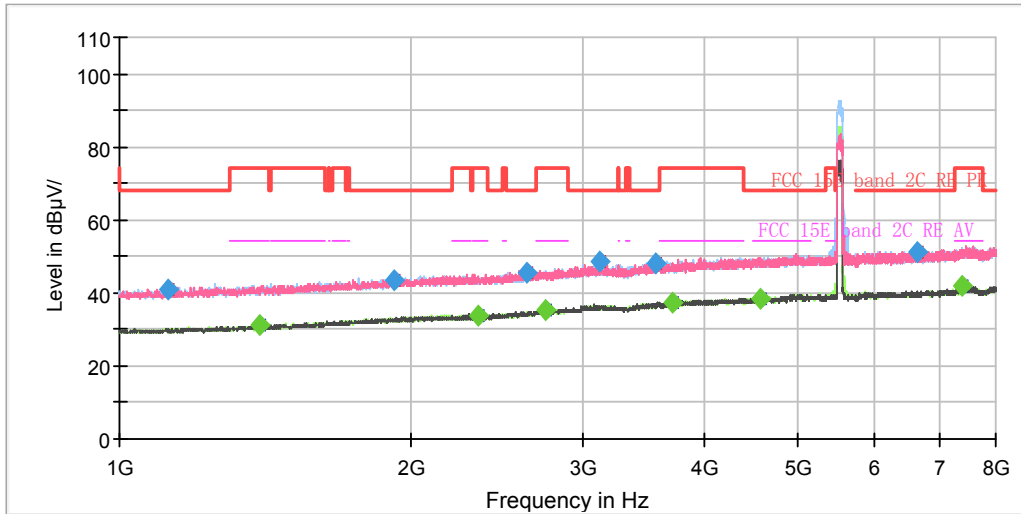

Note: The signal beyond the limit is carrier.  
Radiates Emission from 1GHz to 8GHz

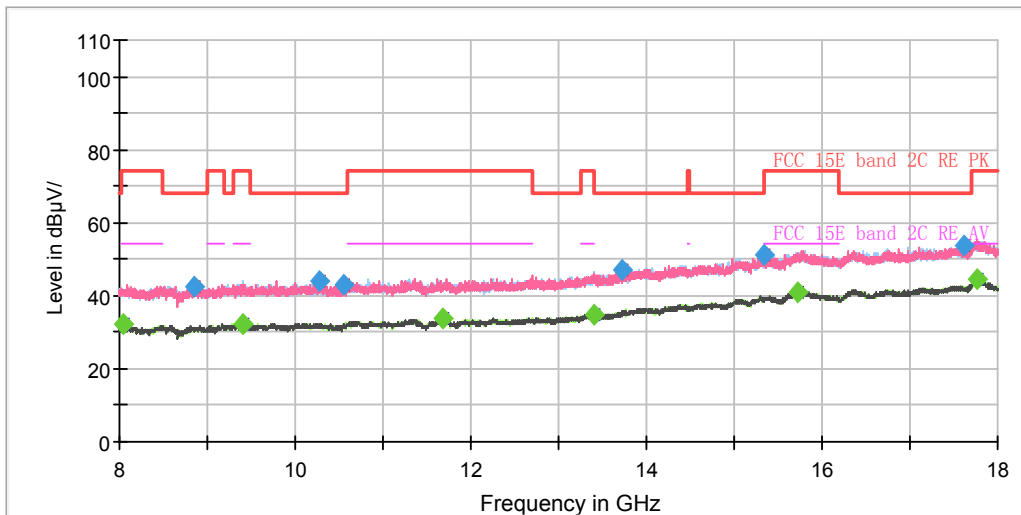

Radiates Emission from 8GHz to 18GHz



Frequency (MHz)	Peak (dBuV/m)	Average (dBuV/m)	Limit (dBuV/m)	Margin (dB)	Height (cm)	Polarization	Azimuth (deg)	Correct Factor (dB)
1124.250000	40.95	---	68.20	27.25	200.0	H	252.0	-8.2
1393.750000	---	30.96	54.00	23.04	100.0	H	107.0	-6.7
1919.625000	43.51	---	68.20	24.69	200.0	V	333.0	-3.9
2342.250000	---	33.73	54.00	20.27	200.0	H	161.0	-2.1
2625.750000	45.66	---	68.20	22.54	100.0	V	90.0	-0.8
2745.625000	---	35.29	54.00	18.71	200.0	H	118.0	-0.2
3124.500000	48.35	---	68.20	19.85	200.0	H	111.0	1.6
3576.000000	48.08	---	68.20	20.12	200.0	V	237.0	2.8
3711.625000	---	37.53	54.00	16.47	200.0	V	61.0	3.1
4579.625000	---	38.49	54.00	15.51	100.0	V	61.0	5.2
6643.750000	51.34	---	68.20	16.86	200.0	H	10.0	8.8
7399.750000	---	41.79	54.00	12.21	200.0	V	301.0	9.8

Remark: 1. Correction Factor = Antenna factor+ Insertion loss (cable loss + amplifier gain)

## 802.11ac (HT80) CH122

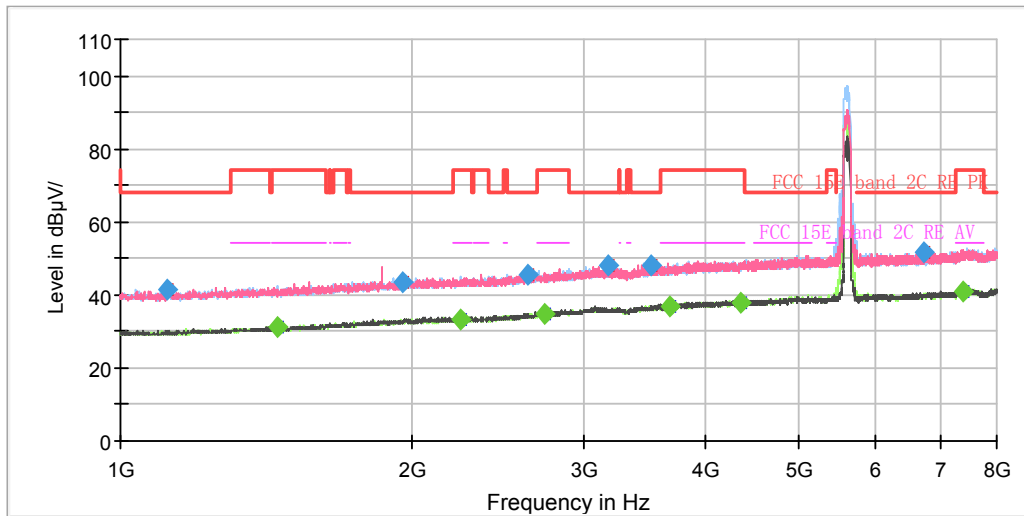

Note: The signal beyond the limit is carrier.  
Radiates Emission from 1GHz to 8GHz

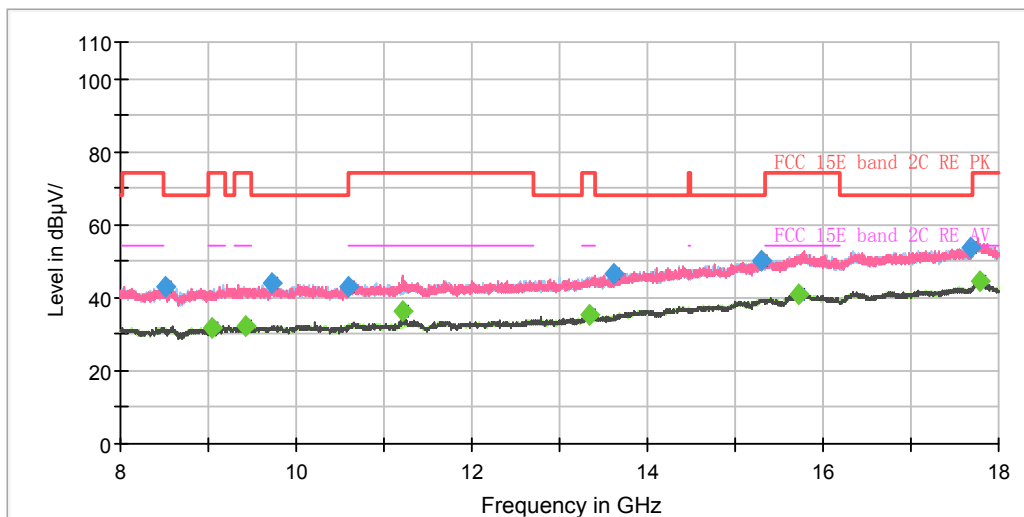

Radiates Emission from 8GHz to 18GHz





Frequency (MHz)	Peak (dBuV/m)	Average (dBuV/m)	Limit (dBuV/m)	Margin (dB)	Height (cm)	Polarization	Azimuth (deg)	Correct Factor (dB)
1116.375000	41.44	---	68.20	26.76	100.0	V	181.0	-8.3
1450.625000	---	31.00	54.00	23.00	200.0	H	172.0	-6.4
1954.625000	43.52	---	68.20	24.68	200.0	H	230.0	-3.6
2236.375000	---	33.45	54.00	20.55	200.0	V	246.0	-2.5
2631.000000	45.65	---	68.20	22.55	100.0	H	0.0	-0.8
2732.500000	---	34.93	54.00	19.07	200.0	H	0.0	-0.3
3177.875000	47.88	---	68.20	20.32	100.0	H	45.0	1.6
3522.625000	48.12	---	68.20	20.08	100.0	V	0.0	2.4
3676.625000	---	36.96	54.00	17.04	200.0	H	207.0	3.0
4360.000000	---	37.96	54.00	16.04	200.0	H	0.0	4.8
6736.500000	51.58	---	68.20	16.62	100.0	H	63.0	8.8
7395.375000	---	40.98	54.00	13.02	200.0	H	84.0	9.8

Remark: 1. Correction Factor = Antenna factor+ Insertion loss (cable loss + amplifier gain)



802.11ac (HT80) CH155

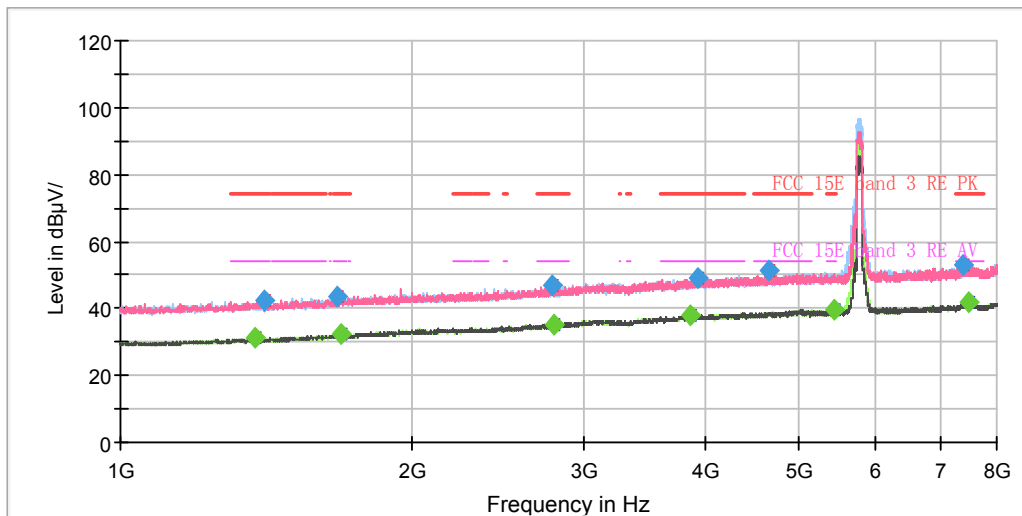

Note: The signal beyond the limit is carrier.  
Radiates Emission from 1GHz to 8GHz

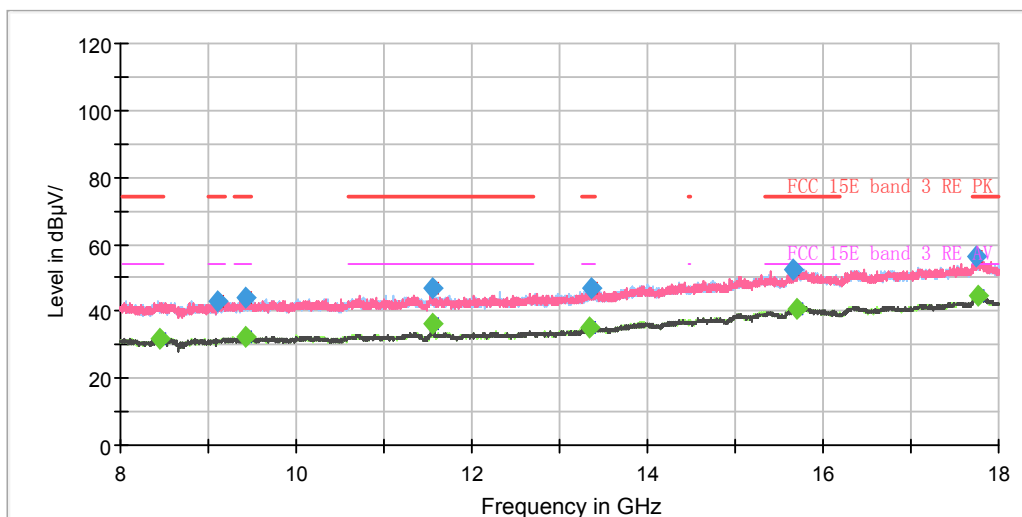

Radiates Emission from 8GHz to 18GHz



Frequency (MHz)	Peak (dBuV/m)	Average (dBuV/m)	Limit (dBuV/m)	Margin (dB)	Height (cm)	Polarization	Azimuth (deg)	Correct Factor (dB)
1374.500000	---	31.01	54.00	22.99	200.0	V	29.0	-6.9
1406.000000	42.35	---	74.00	31.65	200.0	V	334.0	-6.7
1669.375000	43.48	---	74.00	30.52	100.0	V	194.0	-5.2
1687.750000	---	32.29	54.00	21.71	100.0	V	0.0	-5.1
2783.250000	46.67	---	74.00	27.33	200.0	V	319.0	0.0
2793.750000	---	35.30	54.00	18.70	100.0	H	0.0	0.0
3864.750000	---	37.79	54.00	16.21	200.0	V	355.0	3.7
3935.625000	48.93	---	74.00	25.07	200.0	V	254.0	3.9
4666.250000	51.29	---	74.00	22.71	100.0	V	43.0	5.5
5432.750000	---	39.58	54.00	14.42	200.0	H	5.0	7.2
7371.750000	52.96	---	74.00	21.04	200.0	H	55.0	9.8
7475.875000	---	41.87	54.00	12.13	200.0	H	41.0	9.8

Remark: 1. Correction Factor = Antenna factor+ Insertion loss (cable loss + amplifier gain)



During the test, the Radiates Emission from 18GHz to 40GHz was performed in all modes with all channels, 802.11ac (HT80) CH155 are selected as the worst condition. The test data of the worst-case condition was recorded in this report.

RE 18-26.5GHz PK+AV

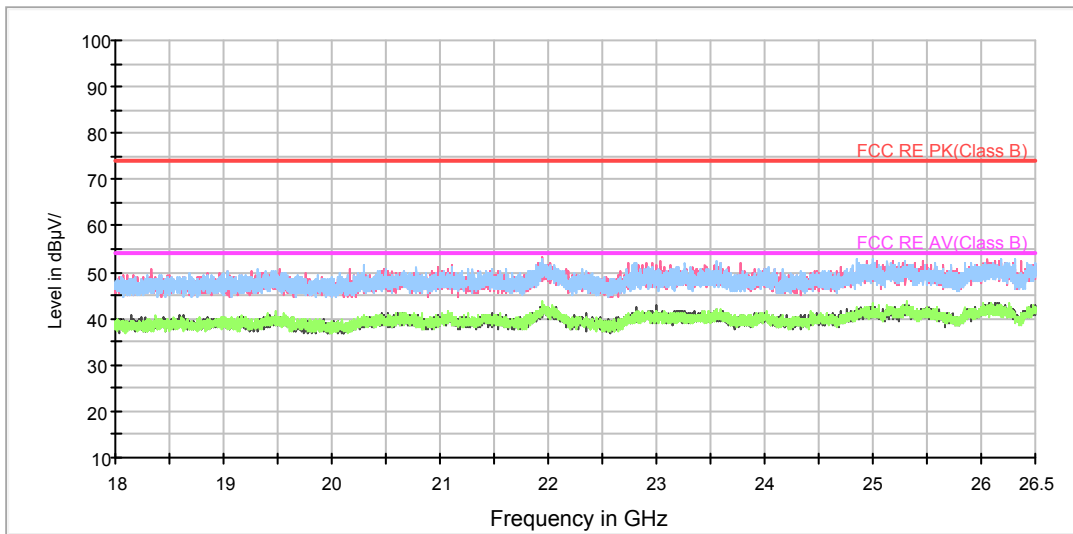

Radiates Emission from 18GHz to 26.5GHz

RE 26.5-40GHz PK+AV

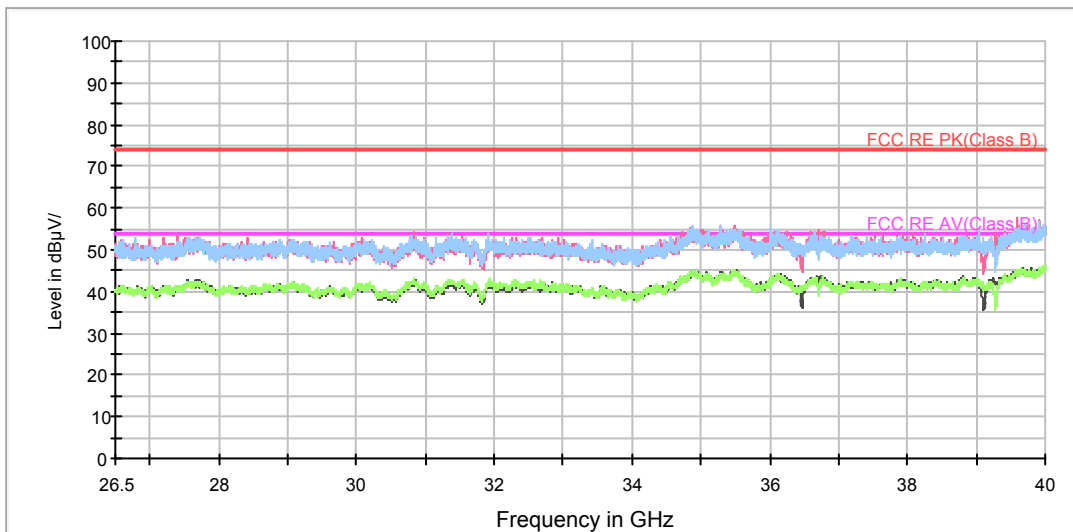

Radiates Emission from 26.5GHz to 40GHz

## 5.6. Conducted Emission

### Ambient condition

Temperature	Relative humidity	Pressure
23°C ~25°C	45%~50%	101.5kPa

### Methods of Measurement

The EUT IS placed on a non-metallic table of 80cm height above the horizontal metal reference ground plane. During the test, the EUT was operating in its typical mode. The test method is according to ANSI C63.10-2013. Connect the AC power line of the EUT to the LISN Use EMI receiver to detect the average and Quasi-peak value. RBW is set to 9kHz, VBW is set to 30kHz The measurement result should include both L line and N line.

The test is in transmitting mode.

### Test Setup

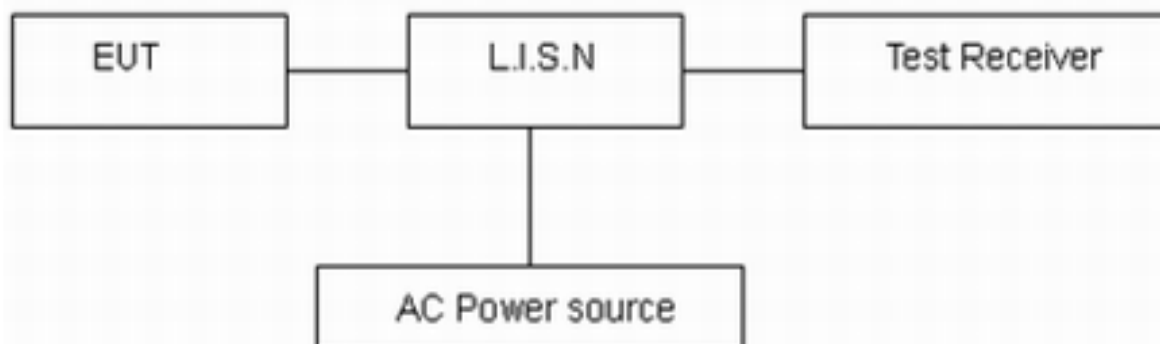

Note: AC Power source is used to change the voltage 110V/60Hz.

### Limits

Frequency (MHz)	Conducted Limits(dBμV)	
	Quasi-peak	Average
0.15 - 0.5	66 to 56 *	56 to 46 *
0.5 - 5	56	46
5 - 30	60	50

\*: Decreases with the logarithm of the frequency.

### Measurement Uncertainty

The assessed measurement uncertainty to ensure 95% confidence level for the normal distribution is with the coverage factor  $k = 1.96$ ,  $U = 2.69$  dB.

**Test Results:**

Following plots, Blue trace uses the peak detection and Green trace uses the average detection. During the test, the Conducted Emission was performed in all modes with all channels, 802.11ac (HT80) CH155 are selected as the worst condition. The test data of the worst-case condition was recorded in this report.

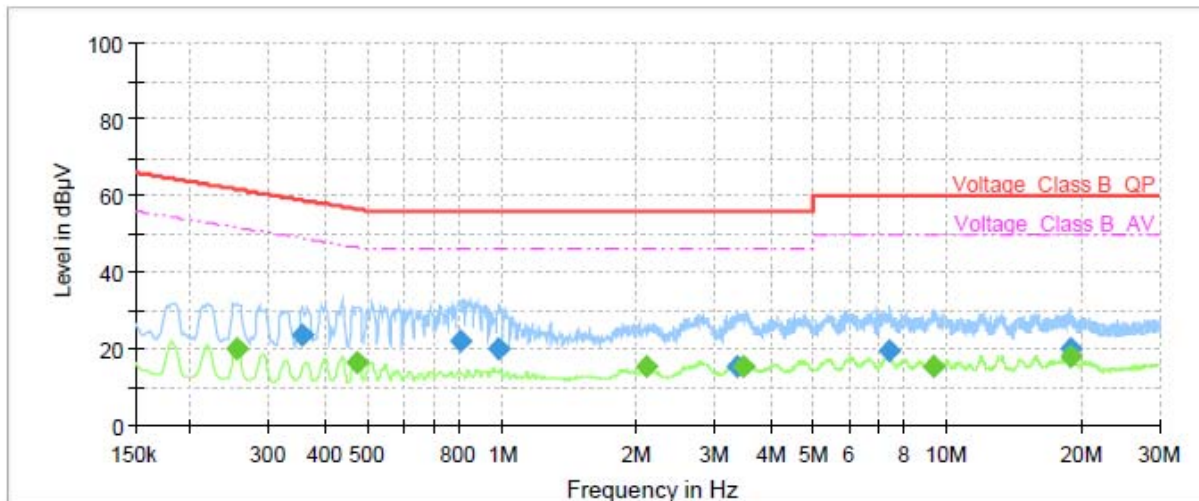

Frequency (MHz)	QuasiPeak (dBµV)	Average (dBµV)	Limit (dBµV)	Margin (dB)	Meas. Time (ms)	Bandwidth (kHz)	Line	Filter	Corr. (dB)
0.25	---	19.77	51.64	31.87	1000.0	9.000	L1	ON	19
0.36	23.72	---	58.80	35.08	1000.0	9.000	L1	ON	19
0.47	---	16.17	46.44	30.27	1000.0	9.000	L1	ON	19
0.80	22.05	---	56.00	33.95	1000.0	9.000	L1	ON	19
0.98	20.04	---	56.00	35.96	1000.0	9.000	L1	ON	19
2.10	---	15.31	46.00	30.69	1000.0	9.000	L1	ON	19
3.38	15.33	---	56.00	40.67	1000.0	9.000	L1	ON	19
3.50	---	15.22	46.00	30.78	1000.0	9.000	L1	ON	19
7.37	19.46	---	60.00	40.54	1000.0	9.000	L1	ON	19
9.33	---	15.48	50.00	34.52	1000.0	9.000	L1	ON	19
18.87	---	17.94	50.00	32.06	1000.0	9.000	L1	ON	20
18.96	20.24	---	60.00	39.76	1000.0	9.000	L1	ON	20

**Remark: Correct factor=cable loss + LISN factor**

L line Conducted Emission from 150 KHz to 30 MHz

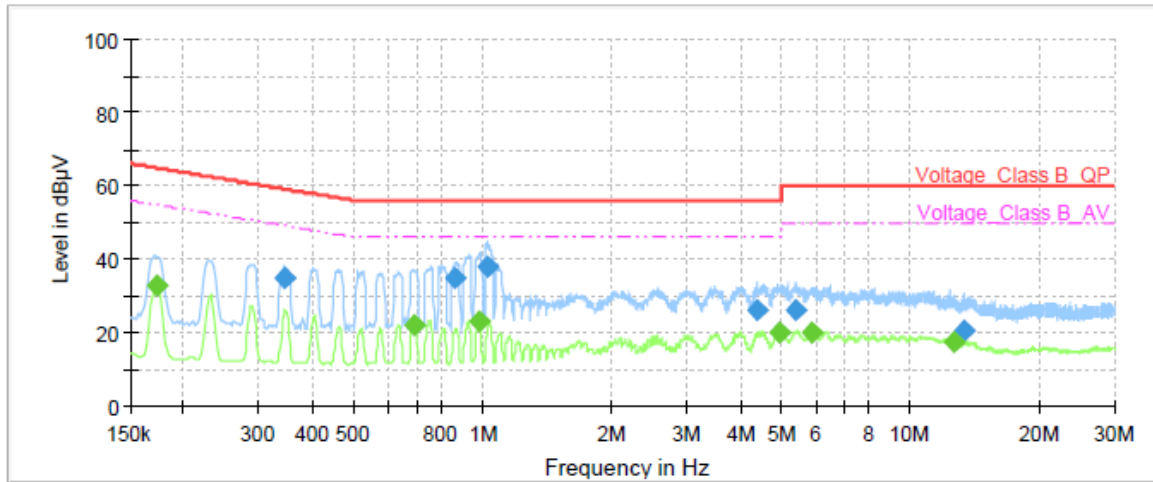

Frequency (MHz)	QuasiPeak (dBµV)	Average (dBµV)	Limit (dBµV)	Margin (dB)	Meas. Time (ms)	Bandwidth (kHz)	Line	Filter	Corr. (dB)
0.17	---	32.77	54.84	22.07	1000.0	9.000	N	ON	19
0.35	34.95	---	59.06	24.12	1000.0	9.000	N	ON	19
0.69	---	22.01	46.00	23.99	1000.0	9.000	N	ON	19
0.87	34.78	---	56.00	21.22	1000.0	9.000	N	ON	19
0.98	---	23.20	46.00	22.80	1000.0	9.000	N	ON	19
1.02	37.73	---	56.00	18.27	1000.0	9.000	N	ON	19
4.40	26.04	---	56.00	29.96	1000.0	9.000	N	ON	19
4.94	---	20.12	46.00	25.88	1000.0	9.000	N	ON	19
5.42	26.38	---	60.00	33.62	1000.0	9.000	N	ON	19
5.88	---	20.22	50.00	29.78	1000.0	9.000	N	ON	19
12.66	---	17.22	50.00	32.78	1000.0	9.000	N	ON	19
13.34	20.67	---	60.00	39.33	1000.0	9.000	N	ON	19

Remark: Correct factor=cable loss + LISN factor

N line Conducted Emission from 150 KHz to 30 MHz



## 6. Main Test Instruments

Name	Manufacturer	Type	Serial Number	Calibration Date	Expiration Date
Spectrum Analyzer	R&S	FSV40	15195-01-00	2020-05-18	2021-05-17
EMI Test Receiver	R&S	ESCI	100948	2020-05-18	2021-05-17
Loop Antenna	SCHWARZBECK	FMZB1519	1519-047	2020-04-02	2023-04-01
TRILOG Broadband Antenna	SCHWARZBECK	VULB 9163	9163-201	2017-11-18	2020-11-17
Horn Antenna	R&S	HF907	102723	2018-08-11	2021-08-10
Horn Antenna	ETS-Lindgren	3160-09	00102643	2018-06-20	2021-06-19
Standard Gain Horn	STEATITE	QSH-SL-26-40 -K-15	16779	2019-12-24	2022-12-23
Broadband Horn Antenna	SCHWARZBECK	BBHA 9120D	430	2018-07-07	2021-07-06
EMI Test Receiver	R&S	ESR	101667	2020-05-18	2021-05-17
LISN	R&S	ENV216	101171	2018-12-15	2021-12-14
Spectrum Analyzer	KEYSIGHT	N9020A	MY54420163	2019-12-15	2020-12-14
RF Cable	Agilent	SMA 15cm	0001	2020-06-12	2020-12-11
TEMPERATURE CHAMBER	WEISS	VT4002	582261194500 10	2019-12-15	2020-12-14
WLAN AP	Cisco	Air-AP1262N- A-K9	LDK102073 (FCC ID)	/	/
Power Meter	R&S	NRP2	104306	2020-05-18	2021-05-17
Power Sensor	R&S	NRP-Z21	104799	2020-05-18	2021-05-17
DC Power Supply	GWINSTEK	GPS-3030D	GEP882653	2020-05-18	2021-05-17
Software	R&S	EMC32	9.26.0	/	/

\*\*\*\*\*END OF REPORT \*\*\*\*\*





## **ANNEX A: The EUT Appearance**

The EUT Appearance are submitted separately.



## **ANNEX B: Test Setup Photos**

The Test Setup Photos are submitted separately.