

# FCC Radio Test Report

## FCC ID: 2AYGCHES-B39

This report concerns: Original Grant

**Project No.** : 2012C009  
**Equipment** : Smart Watch  
**Brand Name** : HONOR  
**Test Model** : HES-B39  
**Series Model** : N/A  
**Applicant** : Honor Device Co., Ltd.  
**Address** : Shum Yip Sky Park, No. 8089, Hongli West Road, Shenzhen, Guangdong, China  
**Manufacturer** : Honor Device Co., Ltd.  
**Address** : Shum Yip Sky Park, No. 8089, Hongli West Road, Shenzhen, Guangdong, China  
**Date of Receipt** : Dec. 03, 2020  
**Date of Test** : Dec. 07, 2020 ~ Dec. 10, 2020  
**Issued Date** : Feb. 10, 2021  
**Report Version** : R01  
**Test Sample** : Engineering Sample No.: DG2020120318 for conducted, DG2020120317 for radiated.  
**Standard(s)** : FCC Part15, Subpart C (15.247)  
ANSI C63.10-2013  
FCC KDB 558074 D01 15.247 Meas Guidance v05r02

The above equipment has been tested and found compliance with the requirement of the relative standards by BTL Inc.



Prepared by : Simon Ling



Approved by : Ethan Ma



Certificate #5123.02

Add: No.3, Jinshagang 1st Road, Shixia, Dalang Town, Dongguan, Guangdong, China.

Tel: +86-769-8318-3000

Web: www.newbtl.com

**Declaration**

**BTL** represents to the client that testing is done in accordance with standard procedures as applicable and that test instruments used has been calibrated with standards traceable to international standard(s) and/or national standard(s).

**BTL's** reports apply only to the specific samples tested under conditions. It is manufacture's responsibility to ensure that additional production units of this model are manufactured with the identical electrical and mechanical components. **BTL** shall have no liability for any declarations, inferences or generalizations drawn by the client or others from **BTL** issued reports.

The report must not be used by the client to claim product certification, approval, or endorsement by NVLAP, NIST, A2LA, or any agency of the U.S. Government.

This report is the confidential property of the client. As a mutual protection to the clients, the public and ourselves, the test report shall not be reproduced, except in full, without our written approval.

**BTL's** laboratory quality assurance procedures are in compliance with the **ISO/IEC 17025** requirements, and accredited by the conformity assessment authorities listed in this test report.

**BTL** is not responsible for the sampling stage, so the results only apply to the sample as received.

The information, data and test plan are provided by manufacturer which may affect the validity of results, so it is manufacturer's responsibility to ensure that the apparatus meets the essential requirements of applied standards and in all the possible configurations as representative of its intended use.

**Limitation**

For the use of the authority's logo is limited unless the Test Standard(s)/Scope(s)/Item(s) mentioned in this test report is (are) included in the conformity assessment authorities acceptance respective.

Please note that the measurement uncertainty is provided for informational purpose only and are not use in determining the Pass/Fail results.

<b>Table of Contents</b>	<b>Page</b>
<b>REPORT ISSUED HISTORY</b>	<b>5</b>
<b>1 . SUMMARY OF TEST RESULTS</b>	<b>6</b>
1.1 TEST FACILITY	7
1.2 MEASUREMENT UNCERTAINTY	7
1.3 TEST ENVIRONMENT CONDITIONS	8
<b>2 . GENERAL INFORMATION</b>	<b>9</b>
2.1 GENERAL DESCRIPTION OF EUT	9
2.2 DESCRIPTION OF TEST MODES	11
2.3 PARAMETERS OF TEST SOFTWARE	11
2.4 BLOCK DIAGRAM SHOWING THE CONFIGURATION OF SYSTEM TESTED	12
2.5 SUPPORT UNITS	13
<b>3 . AC POWER LINE CONDUCTED EMISSIONS TEST</b>	<b>14</b>
3.1 LIMIT	14
3.2 TEST PROCEDURE	14
3.3 DEVIATION FROM TEST STANDARD	14
3.4 TEST SETUP	15
3.5 EUT OPERATING CONDITIONS	15
3.6 TEST RESULTS	15
<b>4 . RADIATED EMISSION TEST</b>	<b>16</b>
4.1 LIMIT	16
4.2 TEST PROCEDURE	17
4.3 DEVIATION FROM TEST STANDARD	17
4.4 TEST SETUP	18
4.5 EUT OPERATING CONDITIONS	20
4.6 TEST RESULT - 9 KHZ TO 30 MHZ	20
4.7 TEST RESULT - 30 MHZ TO 1000 MHZ	20
4.8 TEST RESULT - ABOVE 1000 MHZ	20
<b>5 . BANDWIDTH TEST</b>	<b>21</b>
5.1 LIMIT	21
5.2 TEST PROCEDURE	21
5.3 DEVIATION FROM STANDARD	21
5.4 TEST SETUP	21
5.5 EUT OPERATION CONDITIONS	21

<b>Table of Contents</b>	<b>Page</b>
5.6 TEST RESULTS	21
<b>6 . MAXIMUM OUTPUT POWER</b>	<b>22</b>
6.1 LIMIT	22
6.2 TEST PROCEDURE	22
6.3 DEVIATION FROM STANDARD	22
6.4 TEST SETUP	22
6.5 EUT OPERATION CONDITIONS	22
6.6 TEST RESULTS	22
<b>7 . CONDUCTED SPURIOUS EMISSION</b>	<b>23</b>
7.1 LIMIT	23
7.2 TEST PROCEDURE	23
7.3 DEVIATION FROM STANDARD	23
7.4 TEST SETUP	23
7.5 EUT OPERATION CONDITIONS	23
7.6 TEST RESULTS	23
<b>8 . POWER SPECTRAL DENSITY TEST</b>	<b>24</b>
8.1 LIMIT	24
8.2 TEST PROCEDURE	24
8.3 DEVIATION FROM STANDARD	24
8.4 TEST SETUP	24
8.5 EUT OPERATION CONDITIONS	24
8.6 TEST RESULTS	24
<b>9 . MEASUREMENT INSTRUMENTS LIST</b>	<b>25</b>
<b>APPENDIX A - AC POWER LINE CONDUCTED EMISSIONS</b>	<b>27</b>
<b>APPENDIX B - RADIATED EMISSION - 9 KHZ TO 30 MHZ</b>	<b>30</b>
<b>APPENDIX C - RADIATED EMISSION - 30 MHZ TO 1000 MHZ</b>	<b>35</b>
<b>APPENDIX D - RADIATED EMISSION - ABOVE 1000 MHZ</b>	<b>38</b>
<b>APPENDIX E - BANDWIDTH</b>	<b>63</b>
<b>APPENDIX F - MAXIMUM OUTPUT POWER</b>	<b>65</b>
<b>APPENDIX G - CONDUCTED SPURIOUS EMISSION</b>	<b>67</b>
<b>APPENDIX H - POWER SPECTRAL DENSITY</b>	<b>69</b>

**REPORT ISSUED HISTORY**

Report Version	Description	Issued Date
R00	Original Issue.	Dec. 14, 2020
R01	1. Added FCC ID. 2. Changed applicant and manufacturer information.	Feb. 10, 2021

## 1. SUMMARY OF TEST RESULTS

Test procedures according to the technical standard(s):

FCC Part15, Subpart C (15.247)				
Standard(s) Section	Test Item	Test Result	Judgment	Remark
15.207	AC Power Line Conducted Emissions	APPENDIX A	PASS	-----
15.247(d) 15.205(a) 15.209(a)	Radiated Emissions	APPENDIX B APPENDIX C APPENDIX D	PASS	-----
15.247(a)(2)	Bandwidth	APPENDIX E	PASS	-----
15.247(b)(3)	Maximum Output Power	APPENDIX F	PASS	-----
15.247(d)	Conducted Spurious Emission	APPENDIX G	PASS	-----
15.247(e)	Power Spectral Density	APPENDIX H	PASS	-----
15.203	Antenna Requirement	-----	PASS	Note(2)

Note:

- (1) "N/A" denotes test is not applicable to this device.
- (2) The device what use a permanently attached antenna were considered sufficient to comply with the provisions of 15.203.

## 1.1 TEST FACILITY

The test facilities used to collect the test data in this report is at the location of No.3, Jinshagang 1st Road, Shixia, Dalang Town, Dongguan, Guangdong, China.

BTL's Test Firm Registration Number for FCC: 357015

BTL's Designation Number for FCC: CN1240

## 1.2 MEASUREMENT UNCERTAINTY

ISO/IEC 17025 requires that an estimate of the measurement uncertainties associated with the emissions test results be included in the report. The measurement uncertainties given below are based on a 95% confidence level (based on a coverage factor (k=2))

The BTL measurement uncertainty as below table:

### A. AC power line conducted emissions Measurement:

Test Site	Method	Measurement Frequency Range	U, (dB)
DG-C02	CISPR	150kHz ~ 30MHz	2.68

### B. Radiated emissions Measurement:

Test Site	Method	Measurement Frequency Range	Ant. H / V	U, (dB)
DG-CB03	CISPR	9kHz ~ 30MHz	-	3.02
		30MHz ~ 200MHz	V	4.26
		30MHz ~ 200MHz	H	3.38
		200MHz ~ 1,000MHz	V	3.98
		200MHz ~ 1,000MHz	H	3.94
		1GHz ~ 6GHz	-	3.96
		6GHz ~ 18GHz	-	5.24
		18GHz ~ 26.5GHz	-	3.62
		26.5GHz ~ 40GHz	-	4.00

### C. Other Measurement:

Test Item	Uncertainty
Bandwidth	±3.8 %
Maximum Output Power	±0.95 dB
Conducted Spurious Emission	±2.71 dB
Power Spectral Density	±0.86 dB
Temperature	±0.08 °C
Humidity	±1.5%

Note: Unless specifically mentioned, the uncertainty of measurement has not been taken into account to declare the compliance or non-compliance to the specification.

### 1.3 TEST ENVIRONMENT CONDITIONS

Test Item	Temperature	Humidity	Test Voltage	Tested By
AC Power Line Conducted Emissions	25°C	53%	AC 120V/60Hz	Kwok Guo
Radiated Emissions-9K-30MHz	25°C	60%	AC 120V/60Hz	Kwok Guo
Radiated Emissions-30 MHz to 1GHz	26°C	52%	AC 120V/60Hz	Kwok Guo
Radiated Emissions-Above 1000 MHz	26°C	52%	AC 120V/60Hz	Kwok Guo
Bandwidth	23°C	49%	DC 3.87V	Grani Zhou
Maximum Output Power	23°C	49%	DC 3.87V	Grani Zhou
Conducted Spurious Emission	23°C	49%	DC 3.87V	Grani Zhou
Power Spectral Density	23°C	49%	DC 3.87V	Grani Zhou



## 2. GENERAL INFORMATION

### 2.1 GENERAL DESCRIPTION OF EUT

Equipment	Smart Watch
Brand Name	HONOR
Test Model	HES-B39
Series Model	N/A
Model Difference(s)	N/A
Hardware Version	R1
Software Version	1.0.0.73
Power Source	1# Supplied from battery. 2# Supplied from Charging Dock.
Power Rating	1# DC 3.87V, 180mAh 2# DC 5V
Operation Frequency	2402 MHz ~ 2480 MHz
Modulation Technology	GFSK
Bit Rate of Transmitter	1Mbps
Max. Output Power	3.55 dBm (0.0023 W)

Note:

- For a more detailed features description, please refer to the manufacturer's specifications or the user's manual.

#### 2. Channel List:

Channel	Frequency (MHz)	Channel	Frequency (MHz)
00	2402	20	2442
01	2404	21	2444
02	2406	22	2446
03	2408	23	2448
04	2410	24	2450
05	2412	25	2452
06	2414	26	2454
07	2416	27	2456
08	2418	28	2458
09	2420	29	2460
10	2422	30	2462
11	2424	31	2464
12	2426	32	2466
13	2428	33	2468
14	2430	34	2470
15	2432	35	2472
16	2434	36	2474
17	2436	37	2476
18	2438	38	2478
19	2440	39	2480

#### 3. Table for Filed Antenna:

Ant.	Brand	Model Name	Antenna Type	Connector	Gain (dBi)
1	N/A	N/A	Internal	N/A	-3

Note:

The antenna gain is provided by the manufacturer.

## 4. The EUT contains following accessory devices:

Items	Trademark / Manufacturer / Factory	Model Name	Description
Rechargeable Li-ion Battery	HONOR DEVICE CO., LTD. (Manufacturer: LISHEN / NVT / CosMX)	HB351731EFW	Capacity:180mAh Rated Voltage:3.87V Cutoff Voltage:4.45V Discharge Voltage:3.0V
Charging Dock	/	POWER-CA030	/

## 2.2 DESCRIPTION OF TEST MODES

The test system was pre-tested based on the consideration of all possible combinations of EUT operation mode.

Pretest Mode	Description
Mode 1	TX Mode_1Mbps Channel 00/19/39
Mode 2	TX Mode_1Mbps Channel 00

Following mode(s) was (were) found to be the worst case(s) and selected for the final test.

AC power line conducted emissions test	
Final Test Mode	Description
Mode 2	TX Mode_1Mbps Channel 00

Radiated emissions test - Below 1GHz	
Final Test Mode	Description
Mode 2	TX Mode_1Mbps Channel 00

Radiated emissions test - Above 1GHz	
Final Test Mode	Description
Mode 1	TX Mode_1Mbps Channel 00/19/39

Conducted test	
Final Test Mode	Description
Mode 1	TX Mode_1Mbps Channel 00/19/39

Note:

- (1) For AC power line conducted emissions and radiated emissions below 1 GHz test, the 1Mbps channel 00 is found to be the worst case and recorded.
- (2) For radiated emissions test, three batteries (Manufacturer: LISHEN / NVT / CosMX) are tested, the worst case is NVT and recorded.

## 2.3 PARAMETERS OF TEST SOFTWARE

During testing channel & power controlling software provided by the customer was used to control the operating channel as well as the output power level. The RF output power selection is for the setting of RF output power expected by the customer and is going to be fixed on the firmware of the final end product power parameters of BT LE.

Test Software	sscom5.13.1		
Frequency (MHz)	2402	2440	2480
1Mbps	default	default	default

**2.4 BLOCK DIAGRAM SHOWING THE CONFIGURATION OF SYSTEM TESTED**

For AC power line conducted emissions

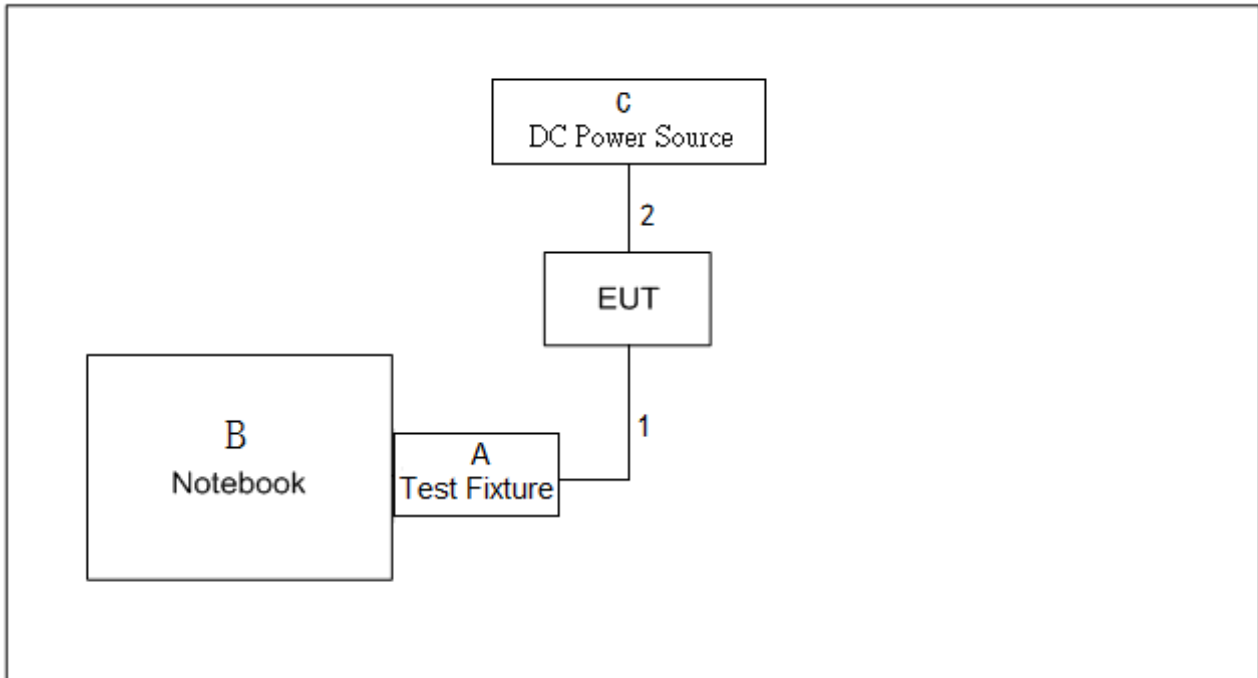

For Radiated Emissions

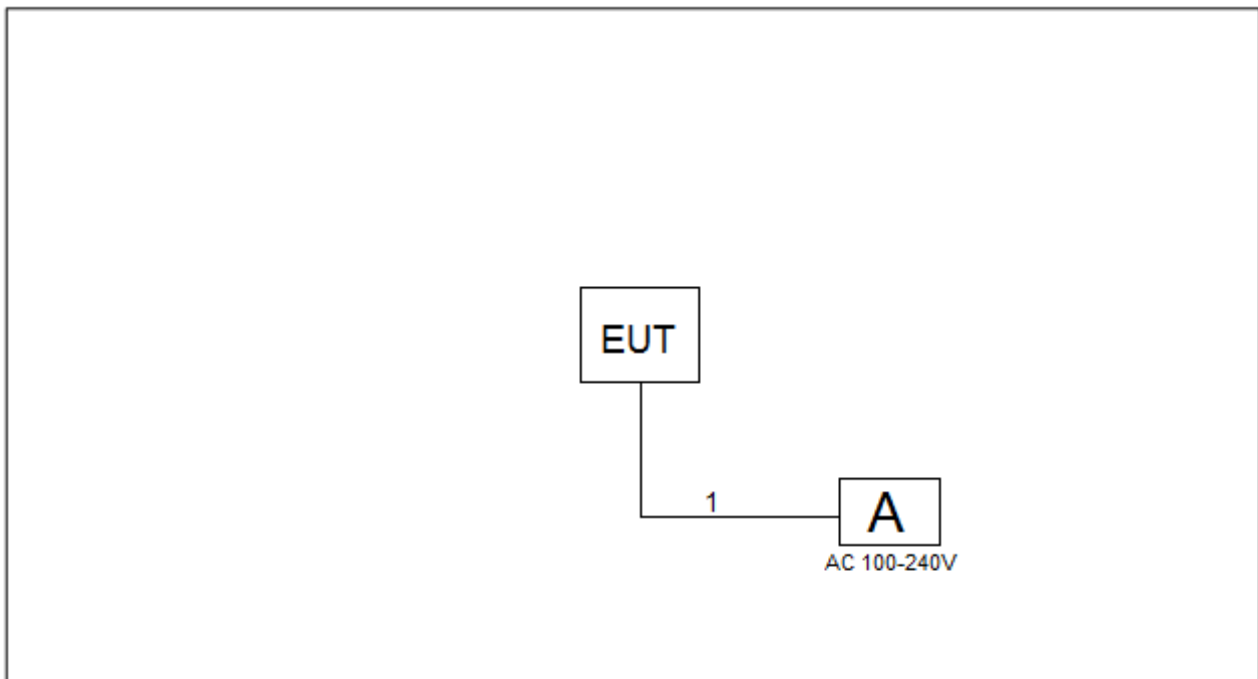

## 2.5 SUPPORT UNITS

### For AC power line conducted emissions

Item	Equipment	Brand	Model No.	Series No.
A	Test Fixture	N/A	N/A	N/A
B	Notebook	Dell	Inspiron 15-7559	N/A
C	DC Power Source	N/A	N/A	N/A

Item	Cable Type	Shielded Type	Ferrite Core	Length
1	Data Cable	NO	NO	0.1m
2	DC Cable	NO	NO	0.3m

### For Radiated Emissions

Item	Equipment	Brand	Model No.	Series No.
A	Adapter	HUAWEI	HW-050100U01	P78001GBP00967

Item	Cable Type	Shielded Type	Ferrite Core	Length
1	USB Cable	NO	NO	0.5m

### 3. AC POWER LINE CONDUCTED EMISSIONS TEST

#### 3.1 LIMIT

Frequency of Emission (MHz)	Limit (dB $\mu$ V)	
	Quasi-peak	Average
0.15 - 0.5	66 to 56*	56 to 46*
0.5 - 5.0	56	46
5.0 - 30.0	60	50

Note:

- (1) The tighter limit applies at the band edges.
- (2) The limit of " \* " marked band means the limitation decreases linearly with the logarithm of the frequency in the range.

The following table is the setting of the receiver

Receiver Parameters	Setting
Attenuation	10 dB
Start Frequency	0.15 MHz
Stop Frequency	30 MHz
IF Bandwidth	9 kHz

#### 3.2 TEST PROCEDURE

- a. The EUT was placed 0.8 meters from the horizontal ground plane with EUT being connected to the power mains through a line impedance stabilization network (LISN). All other support equipment powered from additional LISN(s). The LISN provide 50 Ohm/ 50uH of coupling impedance for the measuring instrument.
- b. Interconnecting cables that hang closer than 40 cm to the ground plane shall be folded back and forth in the center forming a bundle 30 to 40 cm long.
- c. I/O cables that are not connected to a peripheral shall be bundled in the center. The end of the cable may be terminated, if required, using the correct terminating impedance. The overall length shall not exceed 1 m.
- d. LISN at least 80 cm from nearest part of EUT chassis.
- e. For the actual test configuration, please refer to the related Item –EUT Test Photos.

#### 3.3 DEVIATION FROM TEST STANDARD

No deviation

### 3.4 TEST SETUP

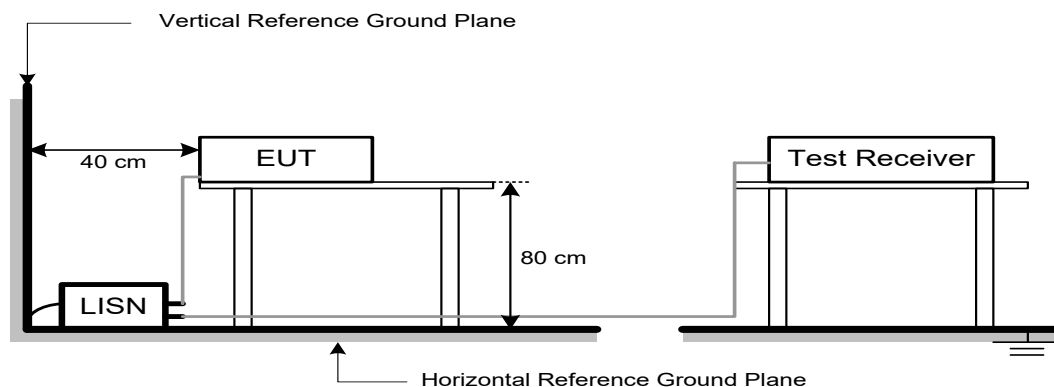

### 3.5 EUT OPERATING CONDITIONS

The EUT was configured for testing in a typical fashion (as a customer would normally use it). The EUT has been programmed to continuously transmit during test. This operating condition was tested and used to collect the included data.

### 3.6 TEST RESULTS

Please refer to the APPENDIX A.

Remark:

- (1) All readings are QP Mode value unless otherwise stated AVG in column of [Note] . If the QP Mode Measured value compliance with the QP Limits and lower than AVG Limits, the EUT shall be deemed to meet both QP & AVG Limits and then only QP Mode was measured, but AVG Mode didn't perform. In this case, a " \* " marked in AVG Mode column of Interference Voltage Measured.
- (2) Measuring frequency range from 150 kHz to 30 MHz.

#### 4. RADIATED EMISSION TEST

##### 4.1 LIMIT

In case the emission fall within the restricted band specified on 15.205(a), then the 15.209(a) limit in the table below has to be followed.

##### LIMITS OF RADIATED EMISSION MEASUREMENT (9 kHz-1000 MHz)

Frequency (MHz)	Field Strength (microvolts/meter)	Measurement Distance (meters)
0.009-0.490	2400/F(kHz)	300
0.490-1.705	24000/F(kHz)	30
1.705-30.0	30	30
30-88	100	3
88-216	150	3
216-960	200	3
Above 960	500	3

##### LIMITS OF RADIATED EMISSION MEASUREMENT (Above 1000 MHz)

Frequency (MHz)	Band edge/ Harmonic at 3m (dB $\mu$ V/m)		Harmonic at 1.5m (dB $\mu$ V/m)	
	Peak	Average	Peak	Average
Above 1000	74	54	80 (Note 4)	60 (Note 4)

Note:

- (1) The limit for radiated test was performed according to FCC PART 15C.
- (2) The tighter limit applies at the band edges.
- (3) Emission level (dB $\mu$ V/m)=20log Emission level (uV/m).
- (4)

$$FS_{\text{limit}} = FS_{\text{max}} - 20\log\left(\frac{d_{\text{limit}}}{d_{\text{measure}}}\right)$$

$$20\log(d_{\text{limit}}/d_{\text{measure}})=20\log(3/1.5)=6\text{ dB.}$$



Spectrum Parameter	Setting
Attenuation	Auto
Start Frequency	1000 MHz
Stop Frequency	10th carrier harmonic
RBW / VBW (Emission in restricted band)	RBW 1 MHz VBW 3 MHz peak detector for Pk value RMS detector for AV value

Receiver Parameter	Setting
Attenuation	Auto
Start ~ Stop Frequency	9 kHz~90 kHz for PK/AVG detector
Start ~ Stop Frequency	90 kHz~110 kHz for QP detector
Start ~ Stop Frequency	110 kHz~490 kHz for PK/AVG detector
Start ~ Stop Frequency	490 kHz~30 MHz for QP detector
Start ~ Stop Frequency	30 MHz~1000 MHz for QP detector

#### 4.2 TEST PROCEDURE

- a. The measuring distance of 3 m shall be used for measurements. The EUT was placed on the top of a rotating table 0.8 meter above the ground at a 3 meter semi-anechoic chamber. The table was rotated 360 degrees to determine the position of the highest radiation.(below 1 GHz)
- b. The measuring distance of 3 m or 1.5m shall be used for measurements. The EUT was placed on the top of a rotating table 1.5 meter above the ground at a 3 meter semi-anechoic chamber. The table was rotated 360 degrees to determine the position of the highest radiation.(above 1GHz)
- c. The height of the equipment or of the substitution antenna shall be 0.8m or 1.5m; the height of the test antenna shall vary between 1 m to 4 m. Both horizontal and vertical polarizations of the antenna are set to make the measurement.
- d. For each suspected emission, the EUT was arranged to its worst case and then the antenna was tuned to heights find the maximum reading (used Bore sight function).
- e. The receiver system was set to peak and average detect function and specified bandwidth with maximum hold mode when the test frequency is above 1 GHz.
- f. The initial step in collecting radiated emission data is a receiver peak detector mode pre-scanning the measurement frequency range. Significant peaks are then marked and then Quasi Peak detector mode re-measured.
- g. All readings are Peak unless otherwise stated QP in column of Note. Peak denotes that the Peak reading compliance with the QP Limits and then QP Mode measurement didn't perform.  
(below 1 GHz)
- h. All readings are Peak Mode value unless otherwise stated AVG in column of Note. If the Peak Mode Measured value compliance with the Peak Limits and lower than AVG Limits, the EUT shall be deemed to meet both Peak & AVG Limits and then only Peak Mode was measured, but AVG Mode didn't perform. (above 1 GHz)
- i. For the actual test configuration, please refer to the related Item – EUT Test Photos.

#### 4.3 DEVIATION FROM TEST STANDARD

No deviation

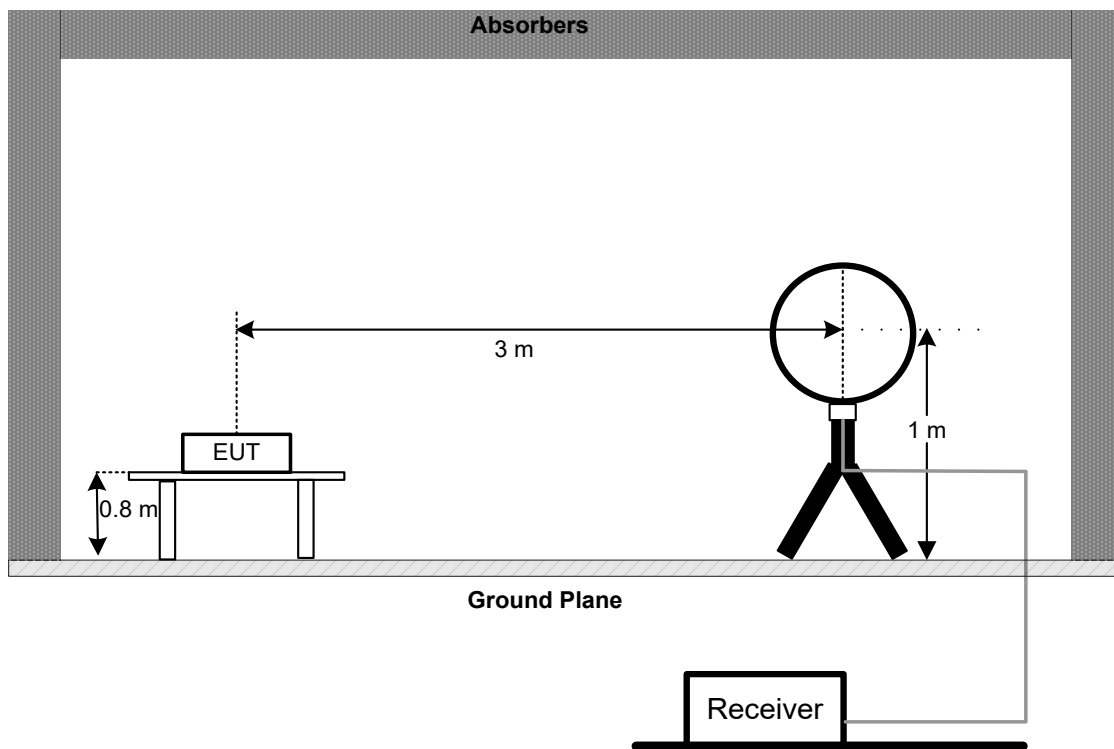
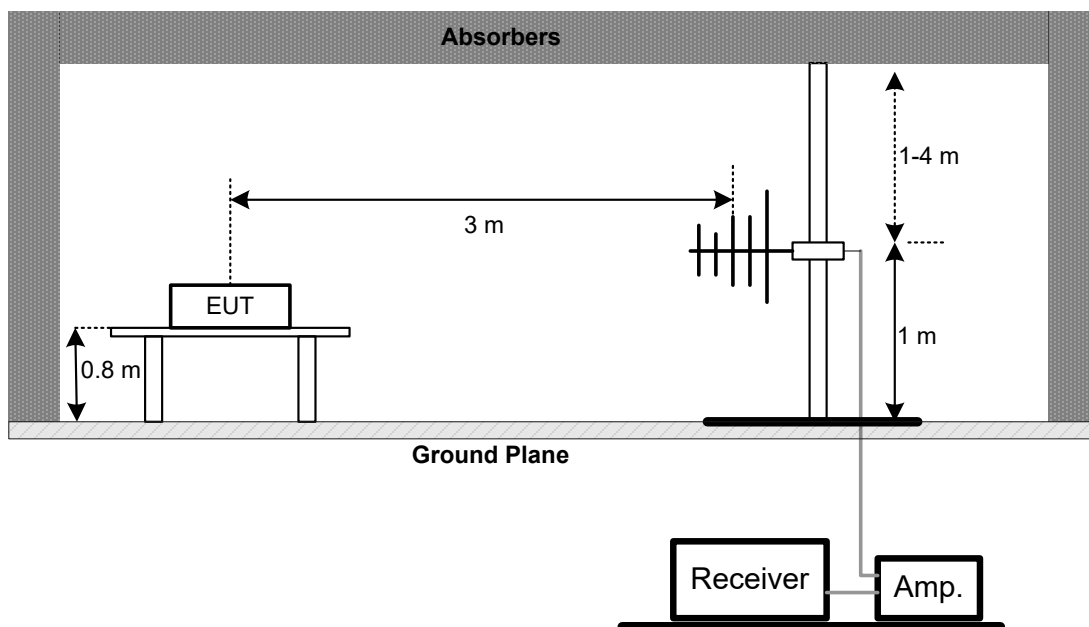
**4.4 TEST SETUP****9 kHz-30 MHz****30 MHz to 1 GHz**

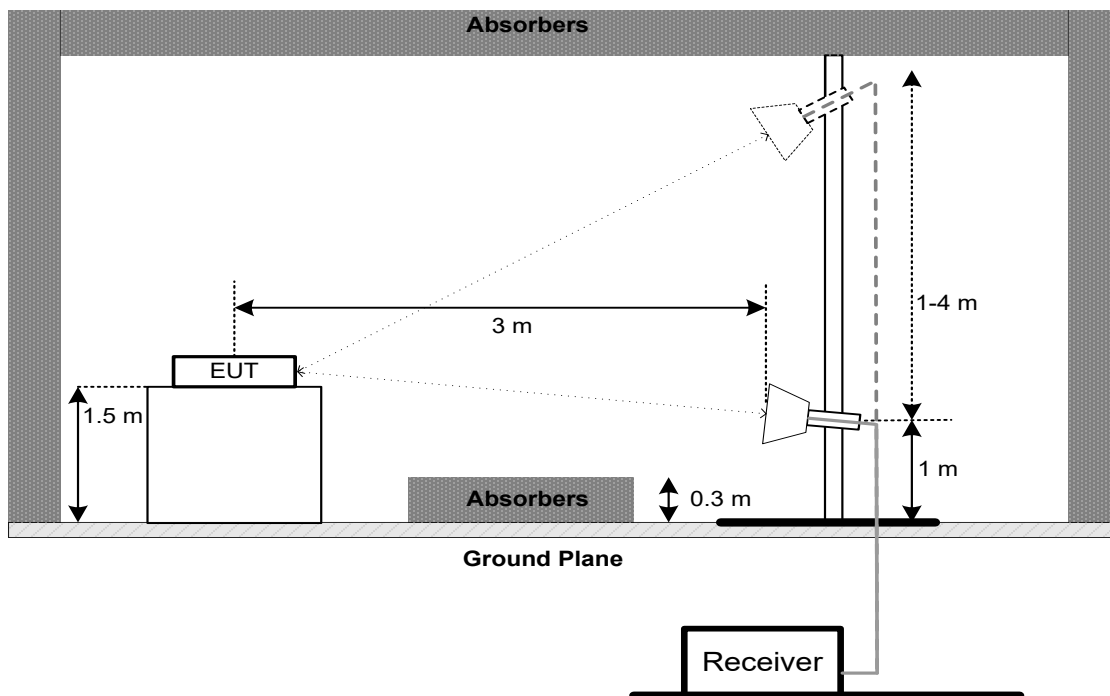
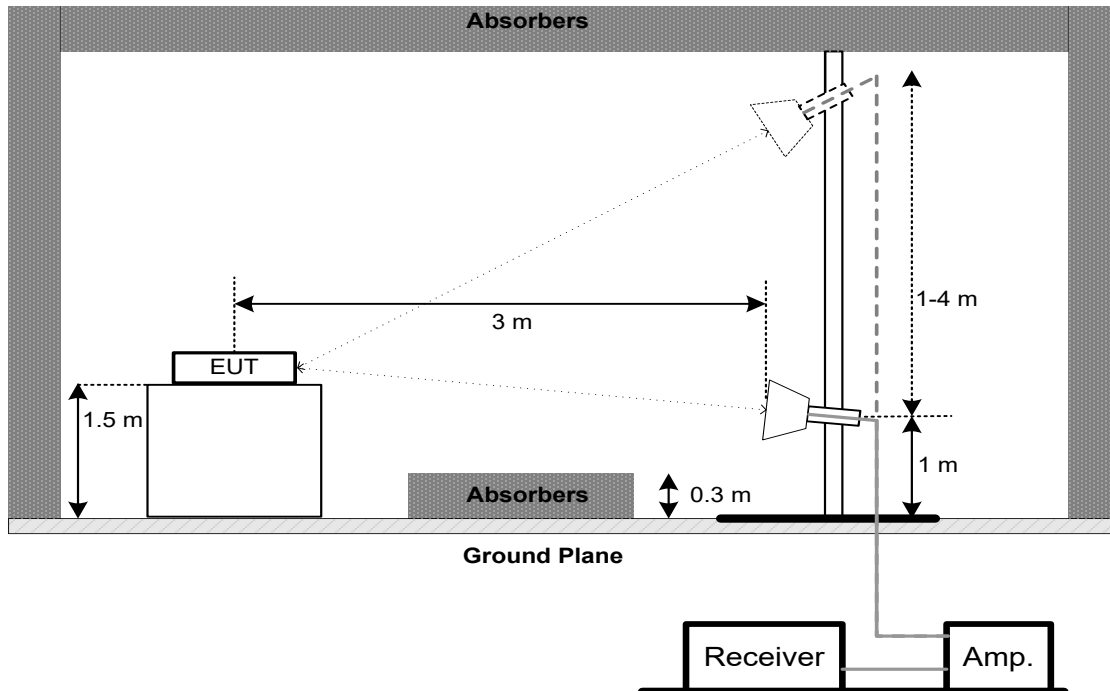
**Above 1 GHz  
Band edge****Harmonic(1 GHz to 18 GHz)**

## Harmonic(Above 18 GHz)

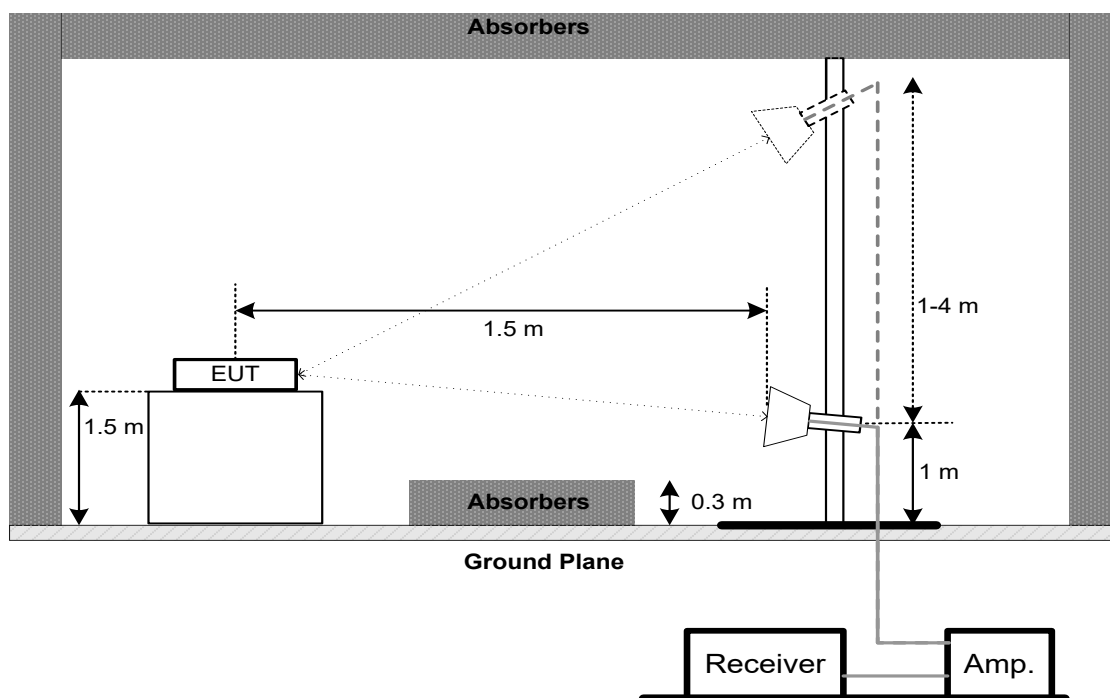

### 4.5 EUT OPERATING CONDITIONS

The EUT was programmed to be in continuously transmitting mode.

### 4.6 TEST RESULT - 9 kHz TO 30 MHz

Please refer to the APPENDIX B

Remark:

- (1) Distance extrapolation factor =  $40 \log(\text{specific distance} / \text{test distance})$  (dB).
- (2) Limit line = specific limits (dBuV) + distance extrapolation factor.

### 4.7 TEST RESULT - 30 MHz TO 1000 MHz

Please refer to the APPENDIX C.

### 4.8 TEST RESULT - ABOVE 1000 MHz

Please refer to the APPENDIX D.

Remark:

- (1) No limit: This is fundamental signal, the judgment is not applicable.  
For fundamental signal judgment was referred to Peak output test.

## 5. BANDWIDTH TEST

### 5.1 LIMIT

FCC Part15, Subpart C (15.247)		
Section	Test Item	Limit
15.247(a)(2)	6 dB Bandwidth	$\geq 500$ kHz
	99% Emission Bandwidth	-

### 5.2 TEST PROCEDURE

- a. The EUT was directly connected to the spectrum analyzer and antenna output port as show in the block diagram below.
- b. Spectrum Setting :
  - For 6 dB Bandwidth: RBW=100 kHz, VBW=300 kHz, Sweep time =Auto.
  - For 99% Emission Bandwidth: RBW=30 kHz, VBW=100 kHz, Sweep time = Auto.

### 5.3 DEVIATION FROM STANDARD

No deviation.

### 5.4 TEST SETUP



### 5.5 EUT OPERATION CONDITIONS

The EUT tested system was configured as the statements of 3.5 unless otherwise a special operating condition is specified in the follows during the testing.

### 5.6 TEST RESULTS

Please refer to the APPENDIX E.

## 6. MAXIMUM OUTPUT POWER

### 6.1 LIMIT

FCC Part15, Subpart C (15.247)		
Section	Test Item	Limit
15.247(b)(3)	Maximum Output Power	1 watt or 30 dBm

### 6.2 TEST PROCEDURE

- The EUT was directly connected to the spectrum analyzer and antenna output port as show in the block diagram below.
- The maximum conducted output power was performed in accordance with method 11.9.1.1 of ANSI C63.10-2013.

### 6.3 DEVIATION FROM STANDARD

No deviation.

### 6.4 TEST SETUP



### 6.5 EUT OPERATION CONDITIONS

The EUT tested system was configured as the statements of 3.5 unless otherwise a special operating condition is specified in the follows during the testing.

### 6.6 TEST RESULTS

Please refer to the APPENDIX F.

## 7. CONDUCTED SPURIOUS EMISSION

### 7.1 LIMIT

In any 100 kHz bandwidth outside the frequency band in which the spread spectrum or digitally modulated intentional radiator is operating, the radio frequency power that is produced by the intentional radiator shall be at least 20 dB below that in the 100 kHz bandwidth within the band that contains the highest level of the desired power, based on either an RF conducted or a radiated measurement, provided the transmitter demonstrates compliance with the peak Output Power limits. If the transmitter complies with the Output Power limits based on the use of RMS averaging over a time interval, as permitted under paragraph (b)(3) of this section, the attenuation required under this paragraph shall be 30 dB instead of 20 dB. Attenuation below the general limits specified in Section 15.209(a) is not required.

### 7.2 TEST PROCEDURE

- a. The EUT was directly connected to the spectrum analyzer and antenna output port as show in the block diagram below.
- b. Spectrum Setting : RBW= 100 kHz, VBW=300 kHz, Sweep time = 10 ms.

### 7.3 DEVIATION FROM STANDARD

No deviation.

### 7.4 TEST SETUP

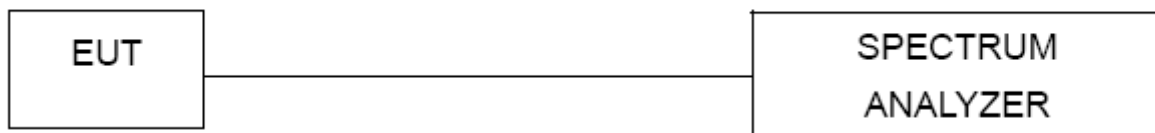

### 7.5 EUT OPERATION CONDITIONS

The EUT tested system was configured as the statements of 3.5 unless otherwise a special operating condition is specified in the follows during the testing.

### 7.6 TEST RESULTS

Please refer to the APPENDIX G.

## 8. POWER SPECTRAL DENSITY TEST

### 8.1 LIMIT

FCC Part15, Subpart C (15.247)		
Section	Test Item	Limit
15.247(e)	Power Spectral Density	8 dBm (in any 3 kHz)

### 8.2 TEST PROCEDURE

- The EUT was directly connected to the spectrum analyzer and antenna output port as show in the block diagram below.
- Spectrum Setting: RBW=3 kHz, VBW=10 kHz, Sweep time = auto.

### 8.3 DEVIATION FROM STANDARD

No deviation.

### 8.4 TEST SETUP

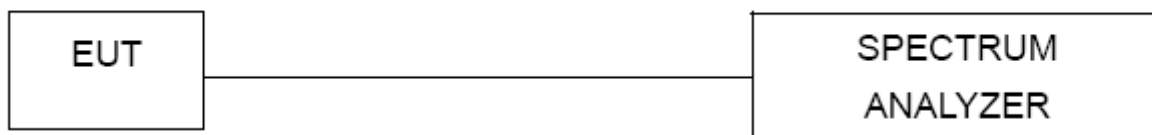

### 8.5 EUT OPERATION CONDITIONS

The EUT tested system was configured as the statements of 3.5 unless otherwise a special operating condition is specified in the follows during the testing.

### 8.6 TEST RESULTS

Please refer to the APPENDIX H.



## 9. MEASUREMENT INSTRUMENTS LIST

AC Power Line Conducted Emissions					
Item	Kind of Equipment	Manufacturer	Type No.	Serial No.	Calibrated until
1	EMI Test Receiver	R&S	ESCI	100382	Feb. 28, 2021
2	LISN	EMCO	3816/2	52765	Mar. 01, 2021
3	TWO-LINE V-NETWORK	R&S	ENV216	101447	Feb. 28, 2021
4	50Ω Terminator	SHX	TF5-3	15041305	Mar. 01, 2021
5	Measurement Software	Farad	EZ-EMC Ver.NB-03A1-01	N/A	N/A
6	Cable	N/A	RG223	12m	Mar. 10, 2021
7	643 Shield Room	ETS	6*4*3m	N/A	N/A

Radiated Emissions - 9 kHz to 30 MHz					
Item	Kind of Equipment	Manufacturer	Type No.	Serial No.	Calibrated until
1	Antenna	EM	EM-6876-1	230	Apr. 16, 2021
2	Cable	N/A	RG 213/U	N/A	May 29, 2021
3	EMI Test Receiver	R&S	ESCI	100895	Feb. 28, 2021
4	Measurement Software	Farad	EZ-EMC Ver.NB-03A1-01	N/A	N/A
5	966 Chambe Room	RM	9*6*6m	N/A	Jul. 25, 2021

Radiated Emissions - 30 MHz to 1 GHz					
Item	Kind of Equipment	Manufacturer	Type No.	Serial No.	Calibrated until
1	Antenna	Schwarzbeck	VULB9160	9160-3232	Mar. 09, 2021
2*	Amplifier	HP	8447D	2944A09673	Aug. 11, 2021
3	Receiver	Agilent	N9038A	MY52130039	Jul. 25, 2021
4	Cable	emci	LMR-400(30MHz-1 GHz)(8m+5m)	N/A	May 22, 2021
5	Controller	CT	SC100	N/A	N/A
6	Controller	MF	MF-7802	MF780208416	N/A
7	Measurement Software	Farad	EZ-EMC Ver.NB-03A1-01	N/A	N/A
8	966 Chambe Room	RM	9*6*6m	N/A	Jul. 25, 2021

Radiated Emissions - Above 1 GHz					
Item	Kind of Equipment	Manufacturer	Type No.	Serial No.	Calibrated until
1	Double Ridged Guide Antenna	ETS	3115	75789	May 12, 2021
2	Broad-Band Horn Antenna	Schwarzbeck	BBHA 9170	9170319	Jul. 07, 2021
3	Amplifier	Agilent	8449B	3008A02333	Mar. 01, 2021
4	Microwave Preamplifier With Adaptor	EMC INSTRUMENT	EMC2654045	980039 & HA01	Mar. 07, 2021
5	Receiver	Agilent	N9038A	MY52130039	Jul. 25, 2021
6	Controller	CT	SC100	N/A	N/A
7	Controller	MF	MF-7802	MF780208416	N/A
8	Cable	N/A	EMC104-SM-SM-6000	N/A	May 09, 2021
9	Measurement Software	Farad	EZ-EMC Ver.NB-03A1-01	N/A	N/A
10	Filter	STI	STI15-9912	N/A	Jul. 25, 2021
11	966 Chambe Room	RM	9*6*6m	N/A	Jul. 25, 2021

<b>Bandwidth &amp; Maximum Output Power &amp; Power Spectral Density &amp; Conducted Spurious Emission</b>					
Item	Kind of Equipment	Manufacturer	Type No.	Serial No.	Calibrated until
1	Spectrum Analyzer	R&S	FSP40	100185	Jul. 25, 2021
2	Attenuator	WOKEN	6SM3502	VAS1214NL	Feb. 11, 2021
3	DC Block	Mini	N/A	N/A	N/A
4	RF Cable	Tongkaichuan	N/A	N/A	N/A

Remark: "N/A" denotes no model name, serial no. or calibration specified.

"\*\*" calibration period of equipment list is three year.

Except \* item, all calibration period of equipment list is one year.

## **APPENDIX A - AC POWER LINE CONDUCTED EMISSIONS**

Test Mode: TX Mode Channel 00\_1Mbps

### Line

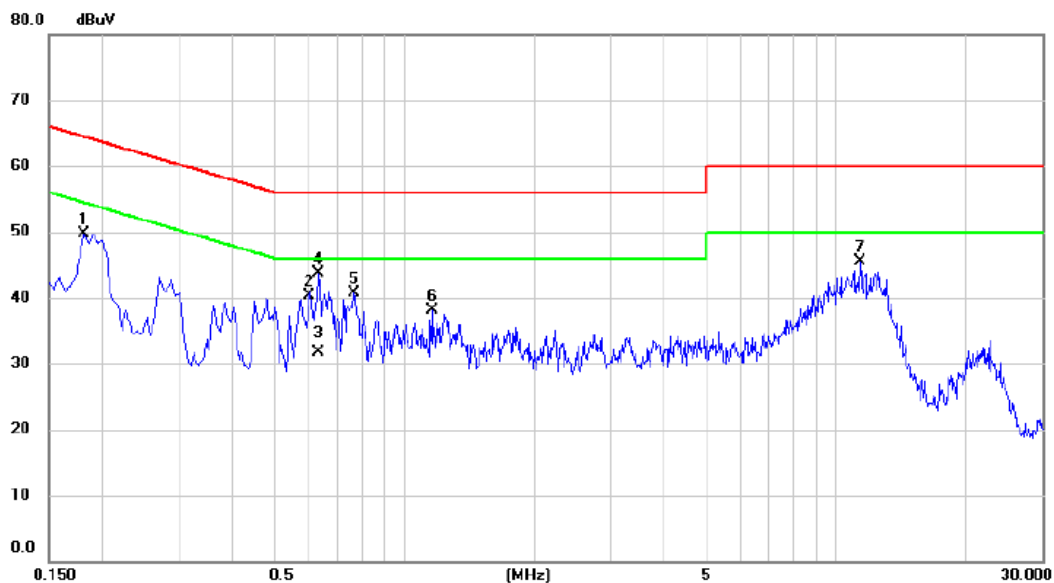

No.	Mk.	Freq. MHz	Reading Level dBuV	Correct Factor dB	Measure- ment dBuV	Limit dBuV	Margin dB	Detector	Comment
1		0.1815	39.94	9.85	49.79	64.42	-14.63	peak	
2		0.6000	30.27	9.96	40.23	56.00	-15.77	peak	
3		0.6314	21.73	9.93	31.66	46.00	-14.34	AVG	
4	*	0.6315	33.84	9.93	43.77	56.00	-12.23	peak	
5		0.7620	30.85	9.94	40.79	56.00	-15.21	peak	
6		1.1580	27.99	10.02	38.01	56.00	-17.99	peak	
7		11.3550	34.79	10.76	45.55	60.00	-14.45	peak	

**REMARKS:**

- (1) Measurement Value = Reading Level + Correct Factor.
- (2) Margin Level = Measurement Value - Limit Value.

Test Mode: TX Mode Channel 00 \_1Mbps

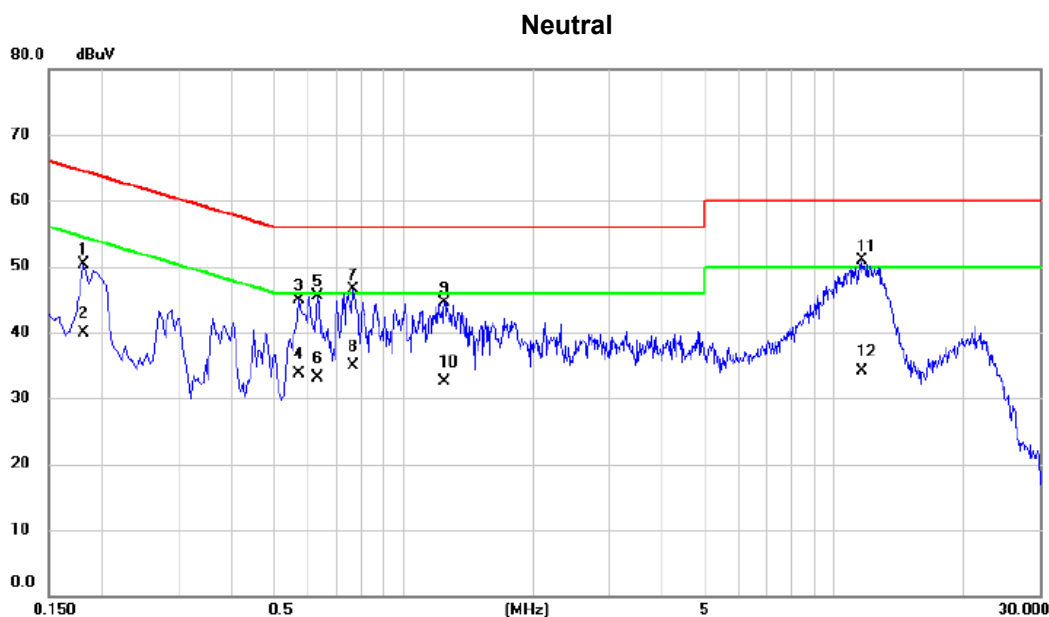

No.	Mk.	Freq. MHz	Reading Level dBuV	Correct Factor dB	Measure- ment dBuV	Limit dBuV	Margin dB	Detector	Comment
1		0.1815	40.40	9.94	50.34	64.42	-14.08	peak	
2		0.1815	29.87	9.94	39.81	54.42	-14.61	AVG	
3		0.5730	34.82	10.18	45.00	56.00	-11.00	peak	
4		0.5730	23.60	10.18	33.78	46.00	-12.22	AVG	
5		0.6315	35.40	10.16	45.56	56.00	-10.44	peak	
6		0.6315	22.90	10.16	33.06	46.00	-12.94	AVG	
7		0.7620	36.22	10.19	46.41	56.00	-9.59	peak	
8		0.7620	24.80	10.19	34.99	46.00	-11.01	AVG	
9		1.2480	34.24	10.33	44.57	56.00	-11.43	peak	
10		1.2480	22.20	10.33	32.53	46.00	-13.47	AVG	
11	*	11.6070	39.83	11.08	50.91	60.00	-9.09	peak	
12		11.6070	23.10	11.08	34.18	50.00	-15.82	AVG	

**REMARKS:**

- (1) Measurement Value = Reading Level + Correct Factor.
- (2) Margin Level = Measurement Value - Limit Value.

**APPENDIX B - RADIATED EMISSION - 9 KHZ TO 30 MHZ**

Test Mode: TX Mode Channel 00\_1Mbps

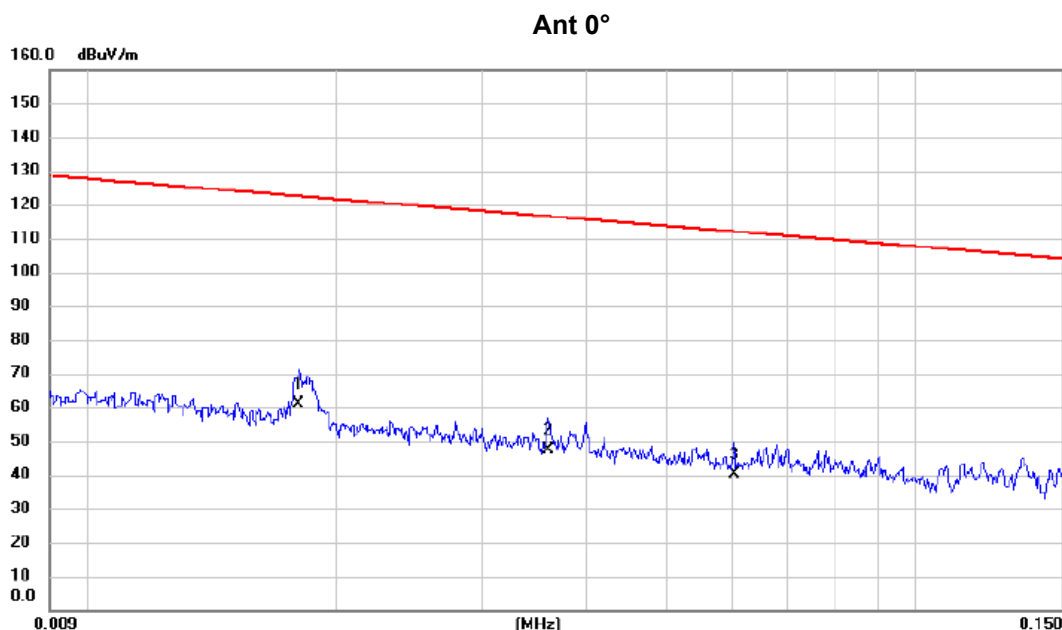

No.	Mk.	Freq.	Reading Level	Correct Factor	Measurement	Limit	Margin		
		MHz	dBuV	dB	dBuV/m	dBuV/m	dB	Detector	Comment
1	*	0.0180	47.20	13.84	61.04	122.50	-61.46	AVG	
2		0.0360	34.68	12.79	47.47	116.48	-69.01	AVG	
3		0.0603	27.89	12.48	40.37	112.00	-71.63	AVG	

**REMARKS:**

- (1) Measurement Value = Reading Level + Correct Factor.
- (2) Margin Level = Measurement Value - Limit Value.

Test Mode: TX Mode Channel 00 \_1Mbps

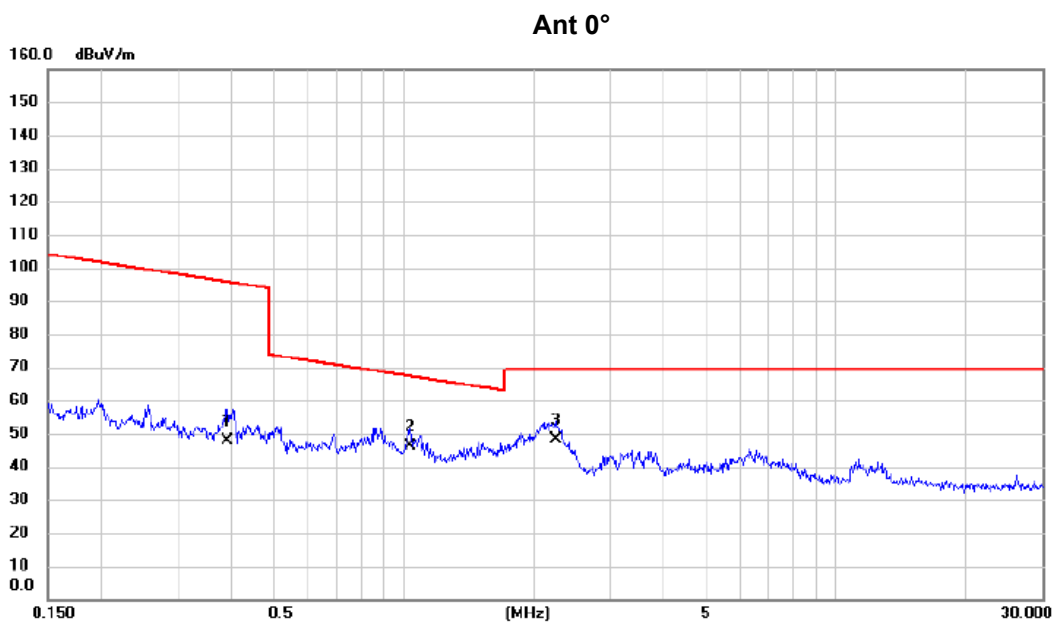

No.	Mk.	Freq. MHz	Reading Level dBuV	Correct Factor dB	Measure- ment dBuV/m	Limit dBuV/m	Margin dB	Detector	Comment
1		0.3893	35.47	12.29	47.76	95.80	-48.04	AVG	
2	*	1.0374	34.52	11.78	46.30	67.29	-20.99	QP	
3		2.2486	37.09	11.18	48.27	69.54	-21.27	QP	

**REMARKS:**

- (1) Measurement Value = Reading Level + Correct Factor.
- (2) Margin Level = Measurement Value - Limit Value.



Test Mode: TX Mode Channel 00 \_1Mbps

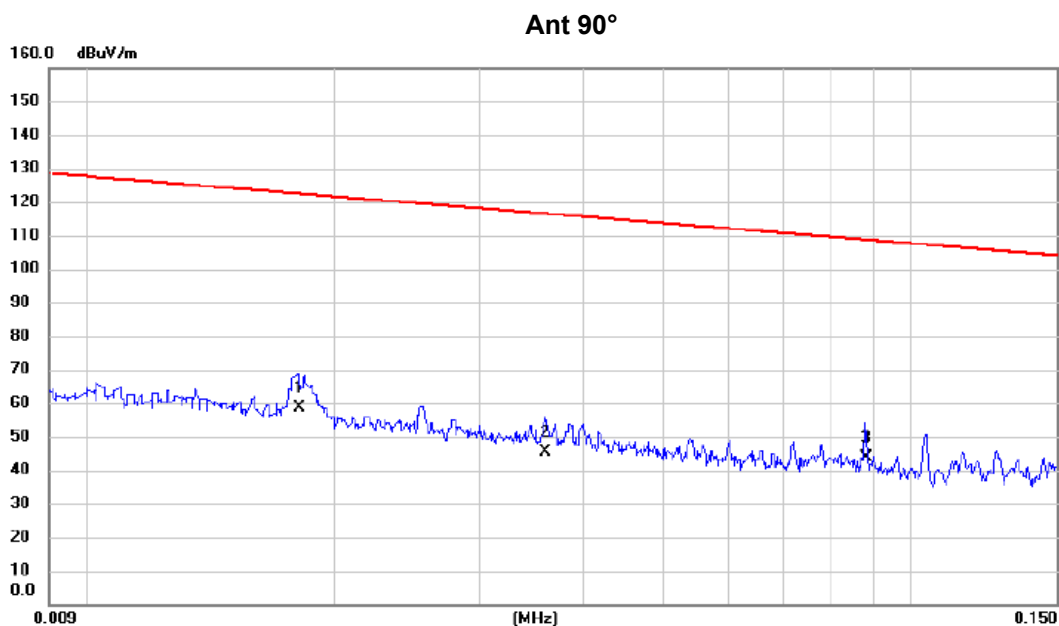

No.	Mk.	Freq.	Reading Level	Correct Factor	Measurement	Limit	Margin	Detector	Comment
		MHz	dBuV	dB	dBuV/m	dBuV/m	dB		
1	*	0.0181	44.67	13.81	58.48	122.45	-63.97	AVG	
2		0.0360	32.49	12.79	45.28	116.48	-71.20	AVG	
3		0.0881	31.20	12.65	43.85	108.71	-64.86	AVG	

**REMARKS:**

- (1) Measurement Value = Reading Level + Correct Factor.
- (2) Margin Level = Measurement Value - Limit Value.

Test Mode: TX Mode Channel 00 \_1Mbps

**Ant 90°**

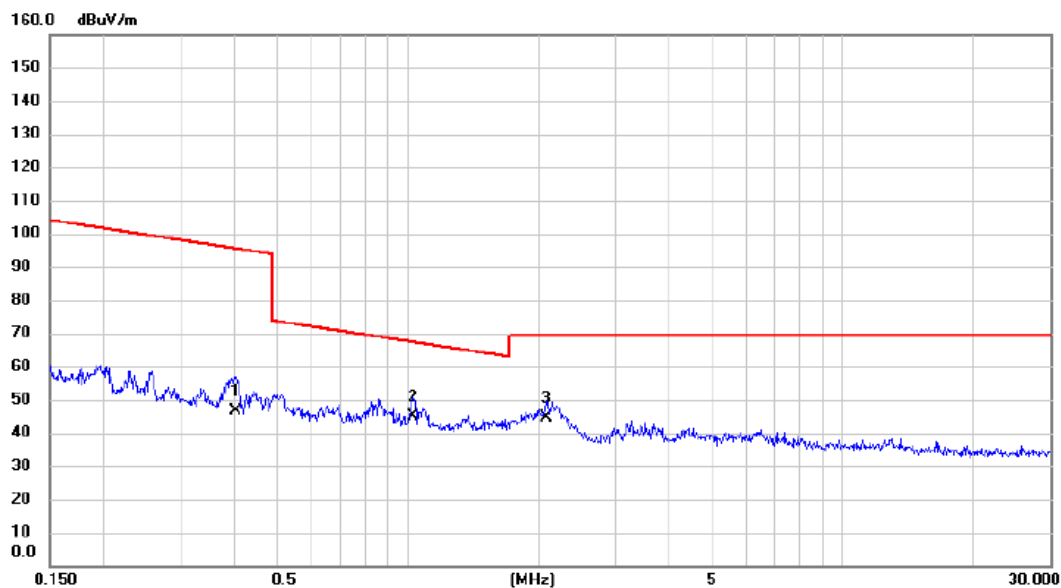

No.	Mk.	Freq. MHz	Reading Level dBuV	Correct Factor dB	Measure- ment dBuV/m	Limit dBuV/m	Margin dB	Detector	Comment
1		0.4020	34.55	12.25	46.80	95.52	-48.72	AVG	
2	*	1.0265	33.24	11.78	45.02	67.38	-22.36	QP	
3		2.0880	33.19	11.26	44.45	69.54	-25.09	QP	

**REMARKS:**

- (1) Measurement Value = Reading Level + Correct Factor.
- (2) Margin Level = Measurement Value - Limit Value.

**APPENDIX C - RADIATED EMISSION - 30 MHZ TO 1000 MHZ**

Test Mode: TX Mode Channel 00 \_1Mbps

### Vertical

80 dBuV/m

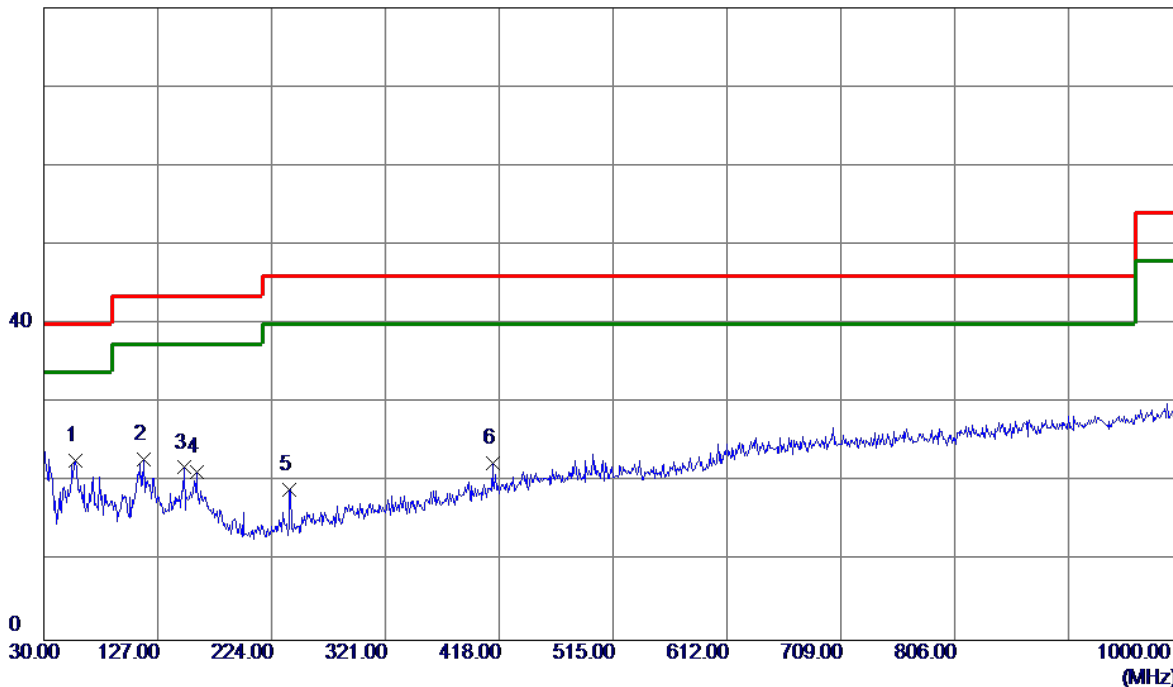

No.	Freq. MHz	Reading Level dBuV/m	Correct Factor dB	Measure ment dBuV/m	Limit dBuV/m	Margin dB	Detector	Comment
1 *	57.1600	36.74	-14.09	22.65	40.00	-17.35	Peak	
2	115.3600	36.31	-13.43	22.88	43.50	-20.62	Peak	
3	149.3100	33.84	-12.00	21.84	43.50	-21.66	Peak	
4	159.9800	31.96	-10.67	21.29	43.50	-22.21	Peak	
5	239.5200	32.65	-13.60	19.05	46.00	-26.95	Peak	
6	412.1800	31.11	-8.67	22.44	46.00	-23.56	Peak	

**REMARKS:**

- (1) Measurement Value = Reading Level + Correct Factor.
- (2) Margin Level = Measurement Value - Limit Value.

Test Mode: TX Mode Channel 00 \_1Mbps

### Horizontal

80 dBuV/m

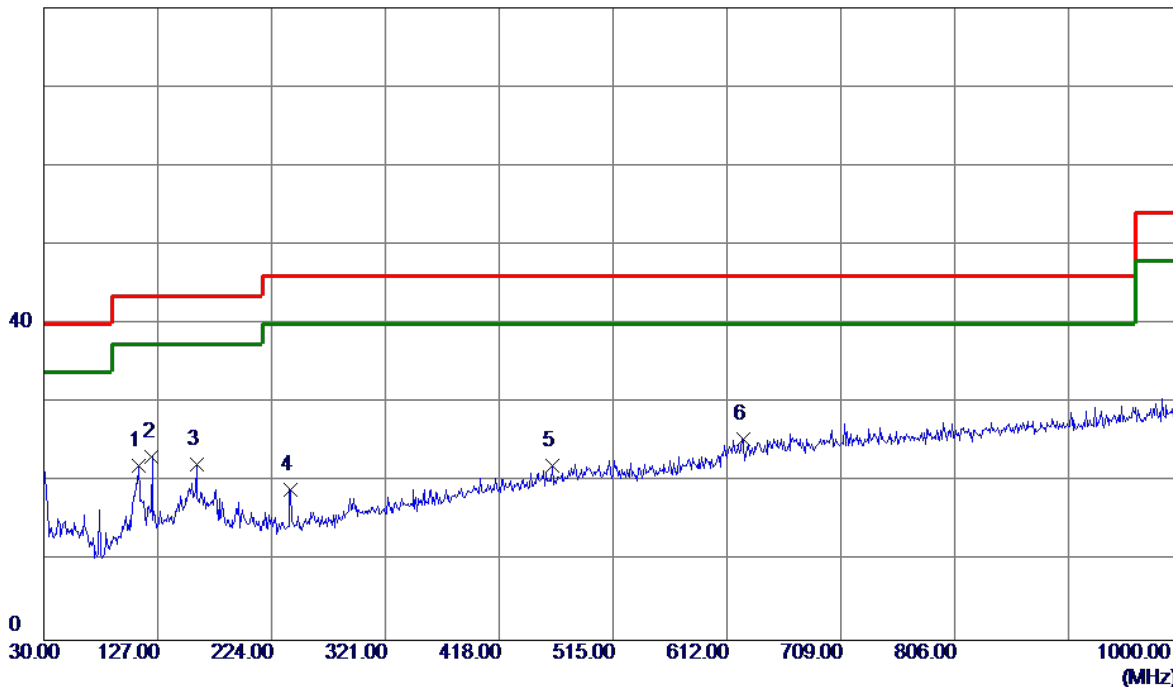

No.	Freq. MHz	Reading Level dBuV/m	Correct Factor dB	Measure ment dBuV/m	Limit dBuV/m	Margin dB	Detector	Comment
1	110.5100	36.28	-14.15	22.13	43.50	-21.37	Peak	
2 *	122.1500	35.91	-12.74	23.17	43.50	-20.33	Peak	
3	159.9800	32.89	-10.67	22.22	43.50	-21.28	Peak	
4	240.4900	32.68	-13.57	19.11	46.00	-26.89	Peak	
5	463.5900	29.55	-7.53	22.02	46.00	-23.98	Peak	
6	625.5800	30.30	-4.79	25.51	46.00	-20.49	Peak	

**REMARKS:**

- (1) Measurement Value = Reading Level + Correct Factor.
- (2) Margin Level = Measurement Value - Limit Value.

**APPENDIX D - RADIATED EMISSION - ABOVE 1000 MHZ**

Test Mode : TX 2402 MHz \_CH00\_1Mbps

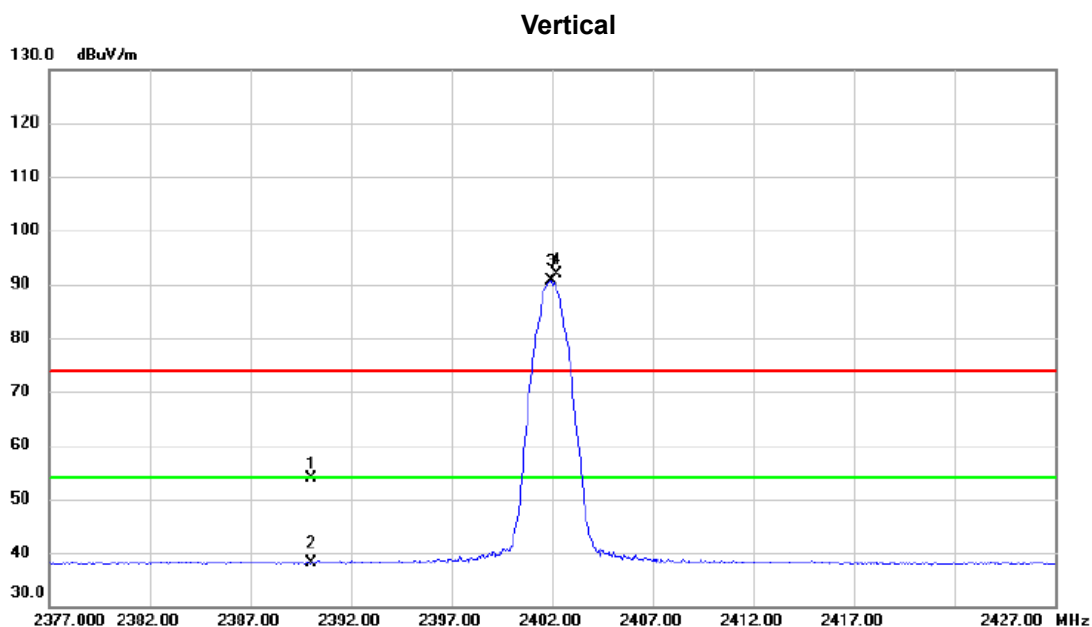

No.	Mk.	Freq. MHz	Reading Level dBuV	Correct Factor dB	Measure- ment dBuV/m	Limit dBuV/m	Margin dB	Detector	Comment
1		2390.000	46.59	7.26	53.85	74.00	-20.15	peak	
2		2390.000	30.95	7.26	38.21	54.00	-15.79	AVG	
3	*	2401.950	83.38	7.26	90.64	54.00	36.64	AVG	No Limit
4	X	2402.250	84.67	7.26	91.93	74.00	17.93	peak	No Limit

**REMARKS:**

(1) Measurement Value = Reading Level + Correct Factor.

(2) Margin Level = Measurement Value - Limit Value.

Test Mode : TX 2402 MHz \_CH00\_1Mbps

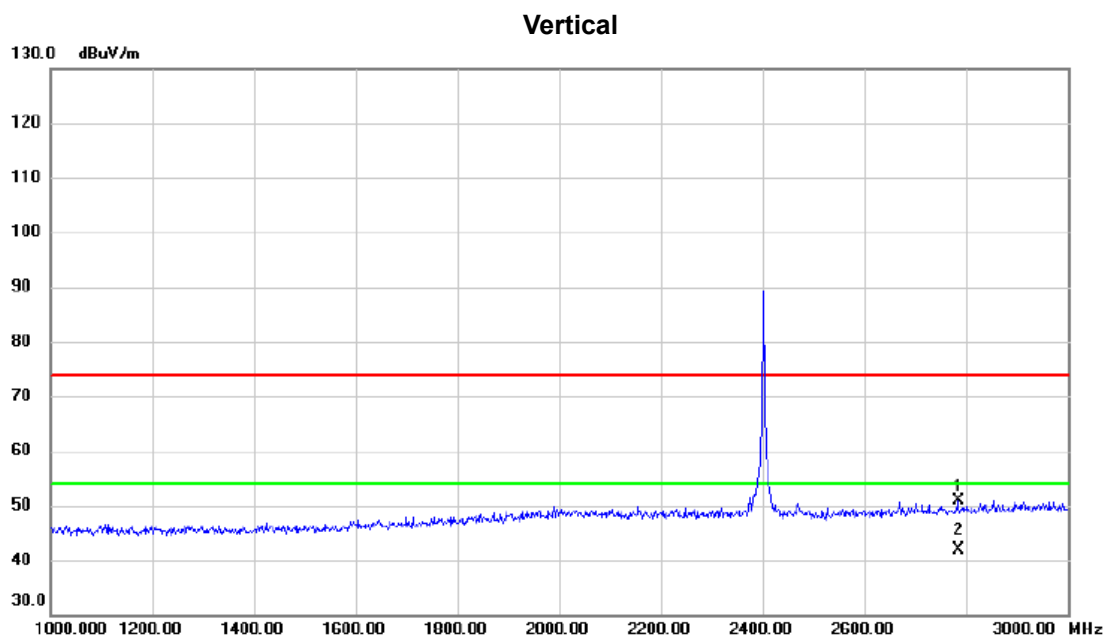

No.	Mk.	Freq. MHz	Reading Level dBuV	Correct Factor dB	Measure- ment dBuV/m	Limit dBuV/m	Margin dB	Detector	Comment
1		2785.000	42.48	8.34	50.82	74.00	-23.18	peak	
2	*	2785.000	33.47	8.34	41.81	54.00	-12.19	AVG	

**REMARKS:**

- (1) Measurement Value = Reading Level + Correct Factor.
- (2) Margin Level = Measurement Value - Limit Value.



Test Mode : TX 2402 MHz \_CH00\_1Mbps

### Vertical

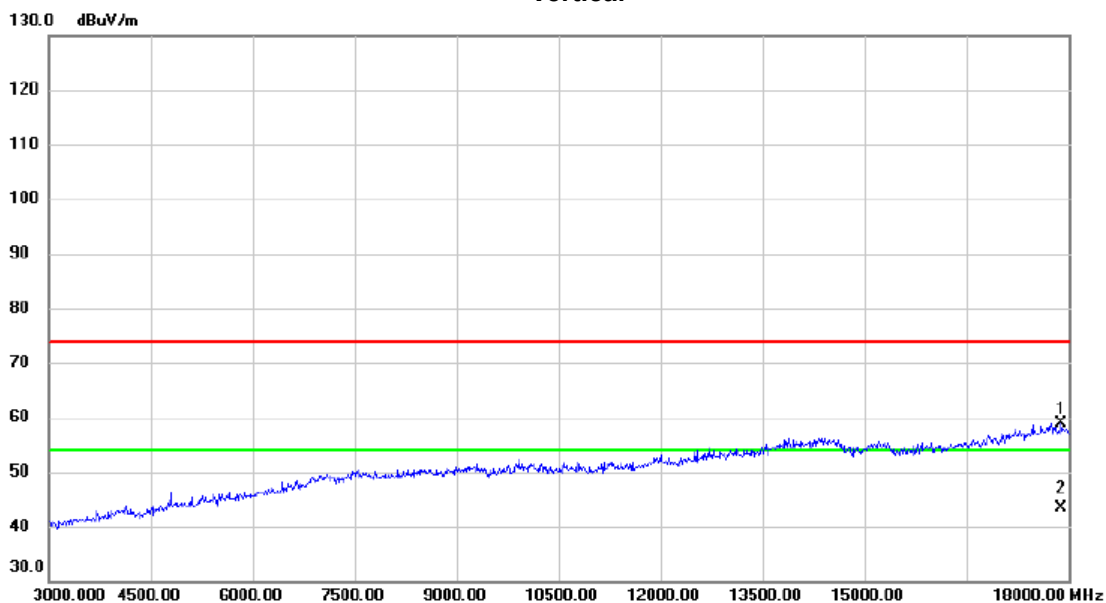

No.	Mk.	Freq. MHz	Reading Level dBuV	Correct Factor dB	Measure- ment dBuV/m	Limit dBuV/m	Margin dB	Detector	Comment
1		17880.000	38.22	20.64	58.86	74.00	-15.14	peak	
2	*	17880.000	22.83	20.64	43.47	54.00	-10.53	AVG	

**REMARKS:**

- (1) Measurement Value = Reading Level + Correct Factor.
- (2) Margin Level = Measurement Value - Limit Value.

Test Mode : TX 2402 MHz \_CH00\_1Mbps

### Vertical

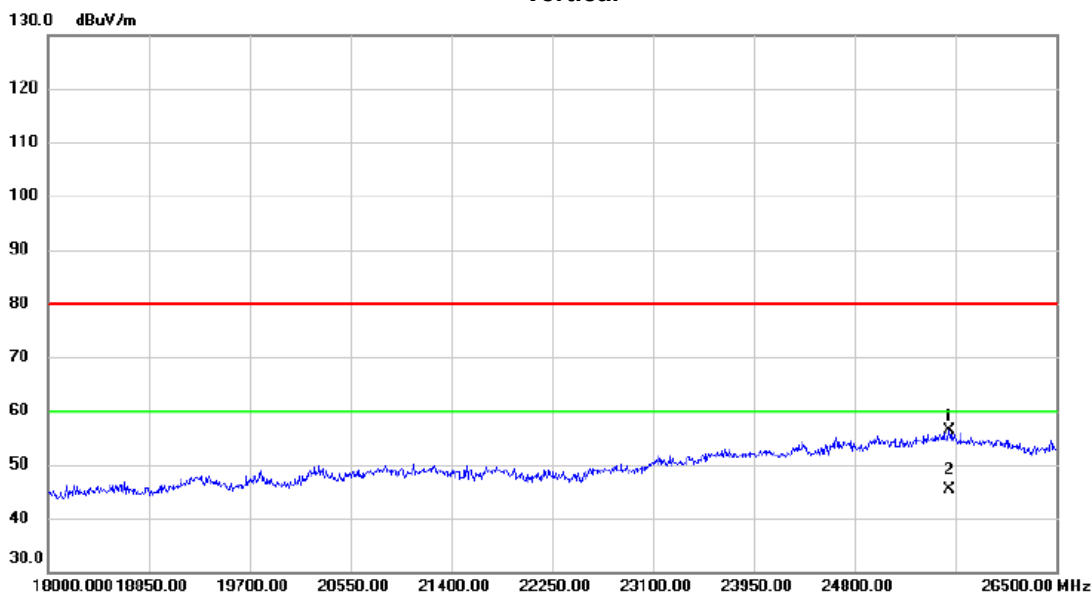

No.	Mk.	Freq. MHz	Reading Level dBuV	Correct Factor dB	Measure- ment dBuV/m	Limit dBuV/m	Margin dB	Detector	Comment
1		25599.000	26.16	30.14	56.30	80.00	-23.70	peak	
2	*	25599.000	15.33	30.14	45.47	60.00	-14.53	AVG	

**REMARKS:**

(1) Measurement Value = Reading Level + Correct Factor.

(2) Margin Level = Measurement Value - Limit Value.

Test Mode : TX 2402 MHz \_CH00\_1Mbps

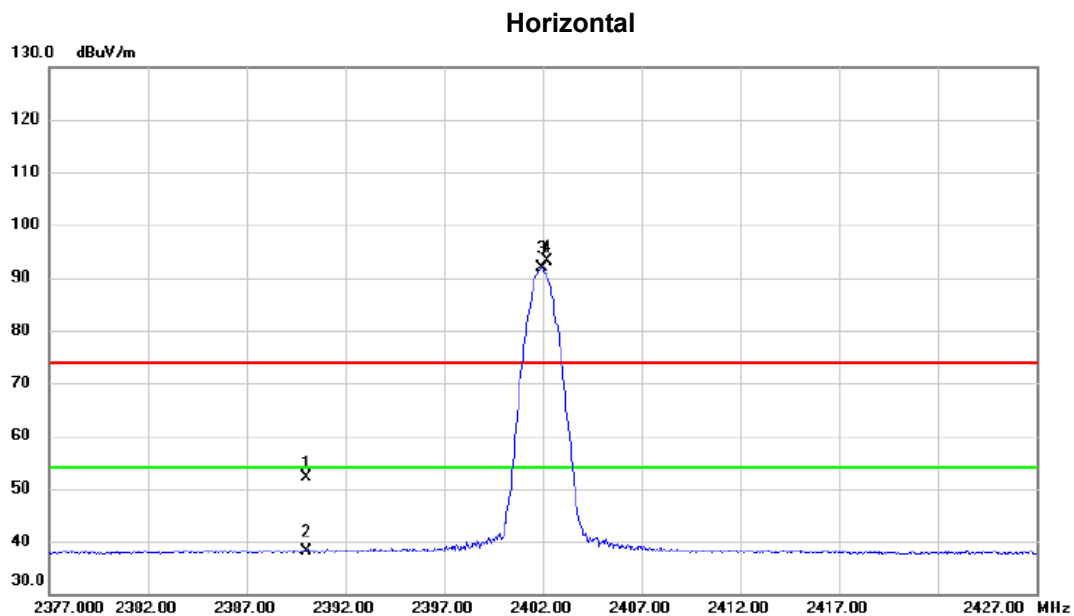

No.	Mk.	Freq. MHz	Reading Level dBuV	Correct Factor dB	Measure- ment dBuV/m	Limit dBuV/m	Margin dB	Detector	Comment
1		2390.000	44.84	7.26	52.10	74.00	-21.90	peak	
2		2390.000	30.81	7.26	38.07	54.00	-15.93	AVG	
3	*	2401.950	84.60	7.26	91.86	54.00	37.86	AVG	No Limit
4	X	2402.250	85.85	7.26	93.11	74.00	19.11	peak	No Limit

**REMARKS:**

- (1) Measurement Value = Reading Level + Correct Factor.
- (2) Margin Level = Measurement Value - Limit Value.

Test Mode : TX 2402 MHz \_CH00\_1Mbps

### Horizontal

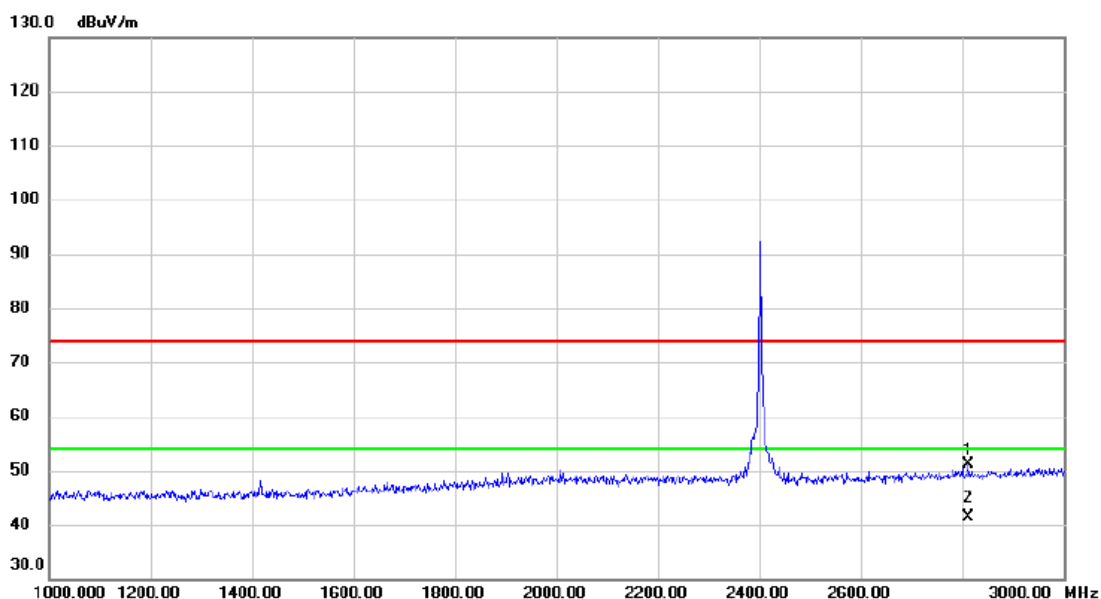

No. Mk.	Freq. MHz	Reading Level dBuV	Correct Factor dB	Measurement dBuV/m	Limit dBuV/m	Margin dB	Detector	Comment
1	2813.000	42.66	8.45	51.11	74.00	-22.89	peak	
2 *	2813.000	32.83	8.45	41.28	54.00	-12.72	AVG	

**REMARKS:**

- (1) Measurement Value = Reading Level + Correct Factor.
- (2) Margin Level = Measurement Value - Limit Value.

Test Mode : TX 2402 MHz \_CH00\_1Mbps

### Horizontal

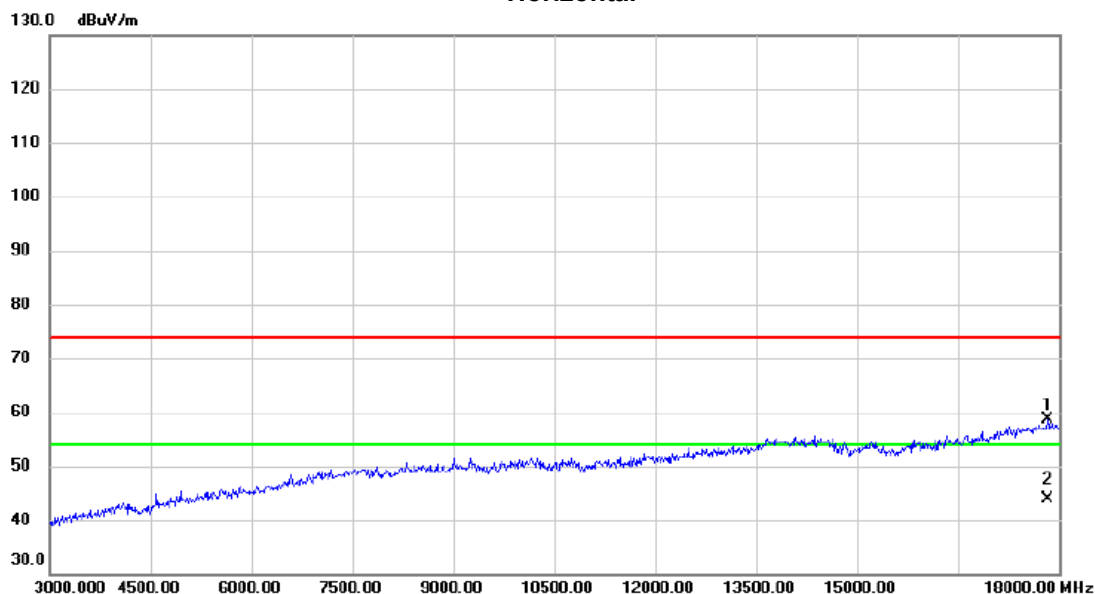

No.	Mk.	Freq. MHz	Reading Level dBuV	Correct Factor dB	Measure- ment dBuV/m	Limit dBuV/m	Margin dB	Detector	Comment
1		17820.000	37.89	20.63	58.52	74.00	-15.48	peak	
2	*	17820.000	23.24	20.63	43.87	54.00	-10.13	AVG	

**REMARKS:**

- (1) Measurement Value = Reading Level + Correct Factor.
- (2) Margin Level = Measurement Value - Limit Value.

Test Mode : TX 2402 MHz \_CH00\_1Mbps

### Horizontal

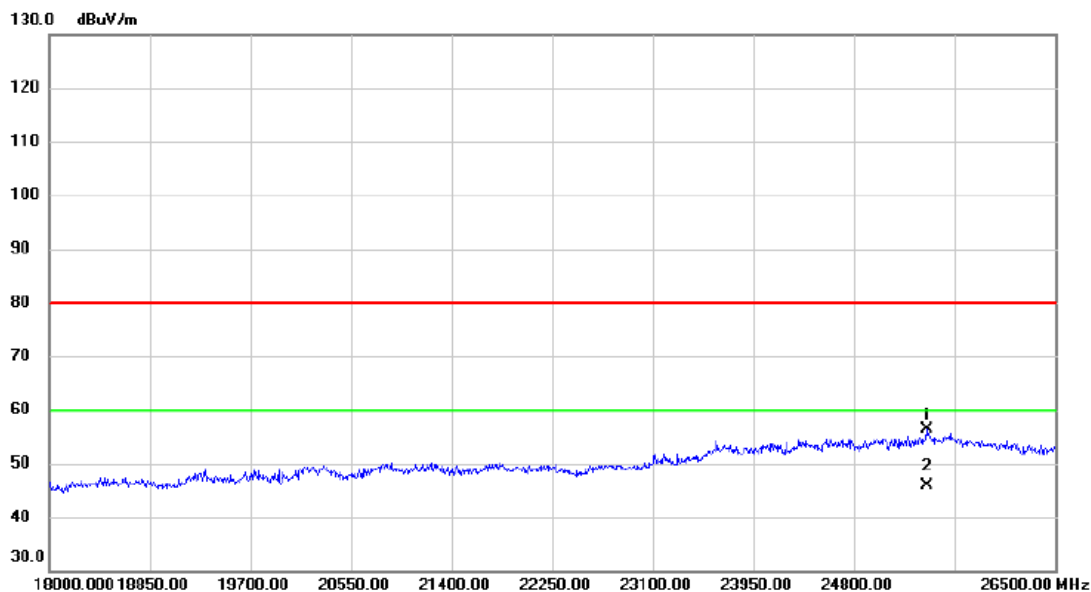

No. Mk.	Freq. MHz	Reading Level dBuV	Correct Factor dB	Measurement dBuV/m	Limit dBuV/m	Margin dB	Detector	Comment
1	25412.000	26.19	30.16	56.35	80.00	-23.65	peak	
2 *	25412.000	15.68	30.16	45.84	60.00	-14.16	AVG	

**REMARKS:**

- (1) Measurement Value = Reading Level + Correct Factor.
- (2) Margin Level = Measurement Value - Limit Value.

Test Mode : TX 2440 MHz \_CH19\_ 1Mbps

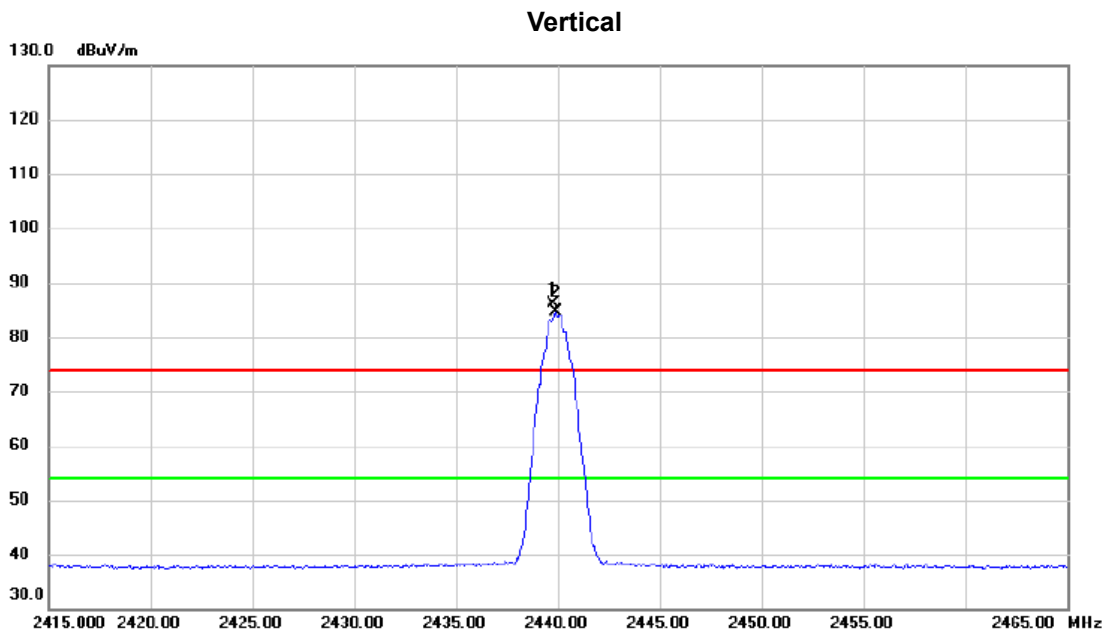

No.	Mk.	Freq. MHz	Reading Level dBuV	Correct Factor dB	Measure- ment dBuV/m	Limit dBuV/m	Margin dB	Detector	Comment
1	X	2439.750	78.80	7.25	86.05	74.00	12.05	peak	No Limit
2	*	2439.900	77.42	7.25	84.67	54.00	30.67	AVG	No Limit

**REMARKS:**

- (1) Measurement Value = Reading Level + Correct Factor.
- (2) Margin Level = Measurement Value - Limit Value.

Test Mode : TX 2440 MHz \_CH19\_ 1Mbps

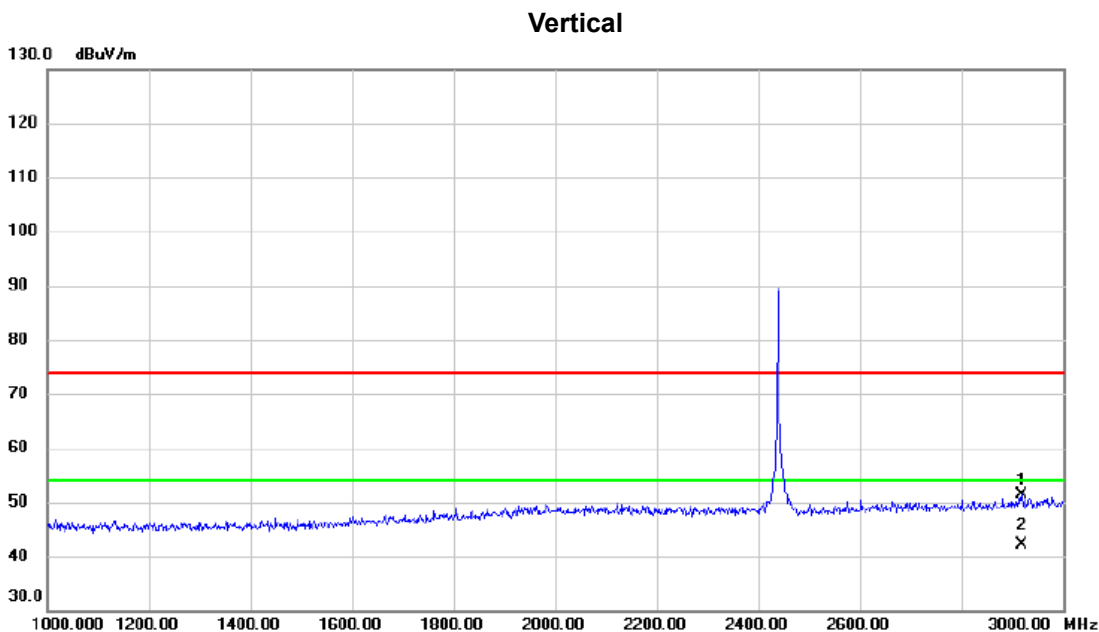

No.	Mk.	Freq. MHz	Reading Level dBuV	Correct Factor dB	Measure- ment dBuV/m	Limit dBuV/m	Margin dB	Detector	Comment
1		2919.000	42.47	8.86	51.33	74.00	-22.67	peak	
2	*	2919.000	33.39	8.86	42.25	54.00	-11.75	AVG	

**REMARKS:**

- (1) Measurement Value = Reading Level + Correct Factor.
- (2) Margin Level = Measurement Value - Limit Value.



Test Mode : TX 2440 MHz \_CH19\_ 1Mbps

### Vertical

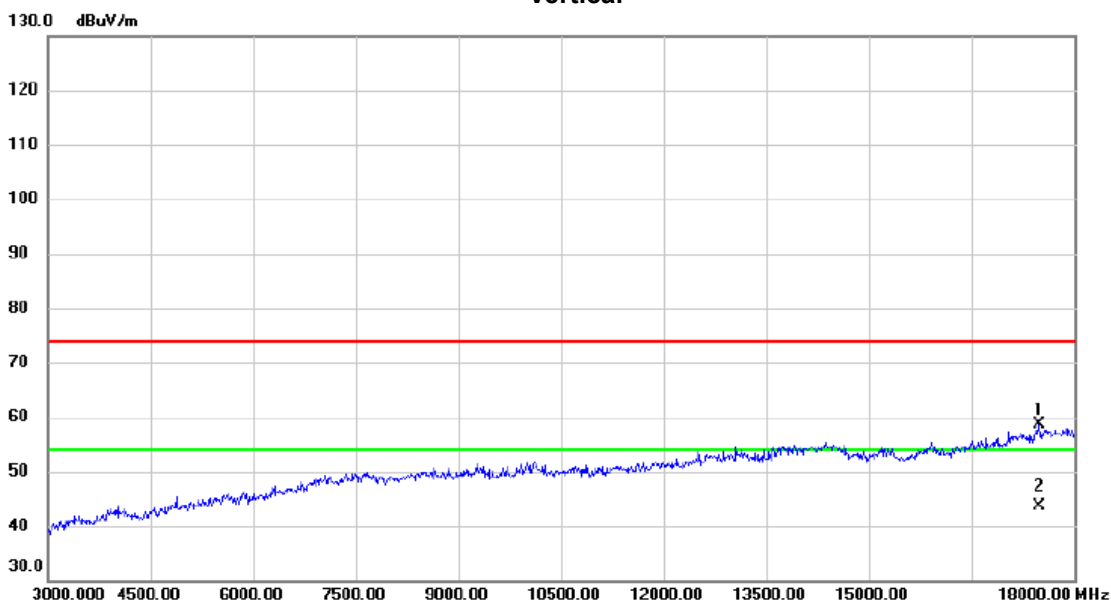

No.	Mk.	Freq. MHz	Reading Level dBuV	Correct Factor dB	Measure- ment dBuV/m	Limit dBuV/m	Margin dB	Detector	Comment
1		17490.000	37.98	20.56	58.54	74.00	-15.46	peak	
2	*	17490.000	23.12	20.56	43.68	54.00	-10.32	AVG	

**REMARKS:**

- (1) Measurement Value = Reading Level + Correct Factor.
- (2) Margin Level = Measurement Value - Limit Value.

Test Mode : TX 2440 MHz \_CH19\_ 1Mbps

### Vertical

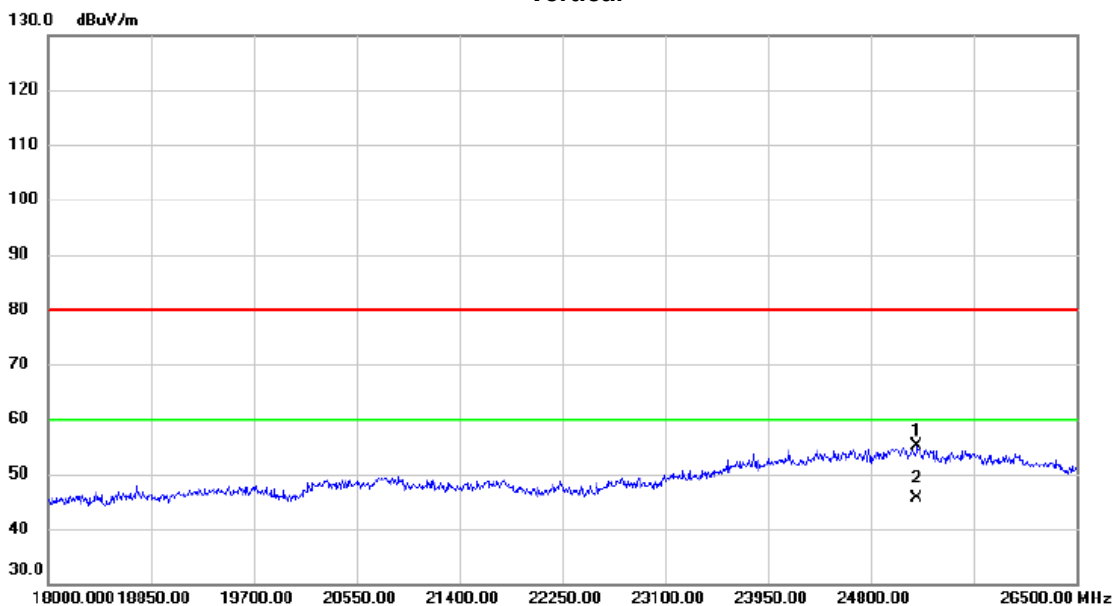

No.	Mk.	Freq. MHz	Reading Level dBuV	Correct Factor dB	Measure- ment dBuV/m	Limit dBuV/m	Margin dB	Detector	Comment
1		25182.500	24.82	30.36	55.18	80.00	-24.82	peak	
2	*	25182.500	15.23	30.36	45.59	60.00	-14.41	AVG	

**REMARKS:**

- (1) Measurement Value = Reading Level + Correct Factor.
- (2) Margin Level = Measurement Value - Limit Value.

Test Mode : TX 2440 MHz \_CH19\_1Mbps

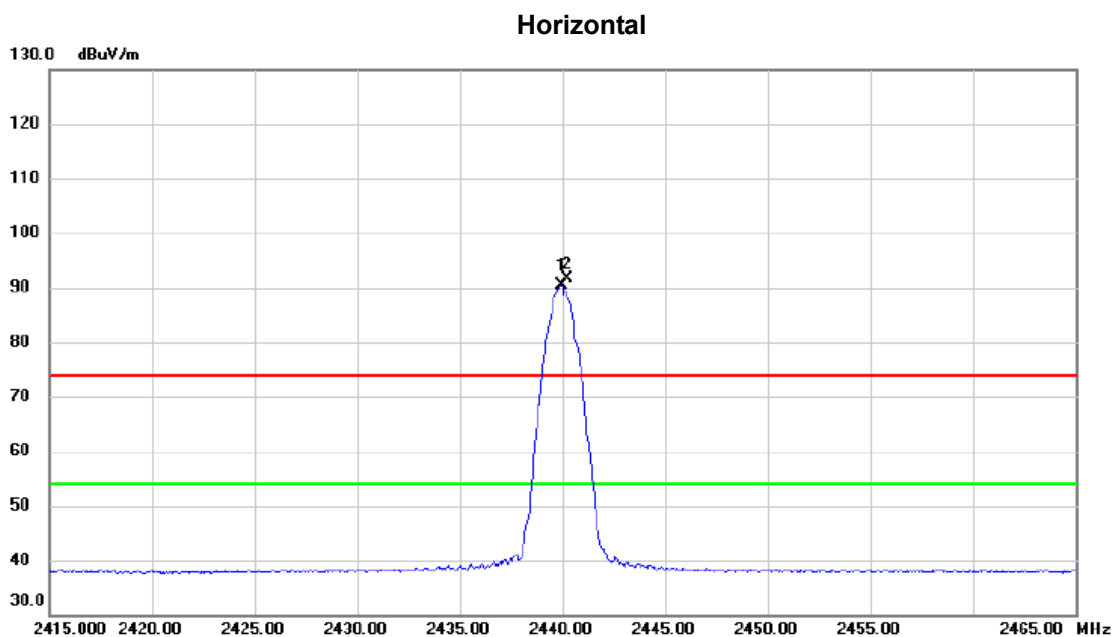

No.	Mk.	Freq. MHz	Reading Level dBuV	Correct Factor dB	Measure- ment dBuV/m	Limit dBuV/m	Margin dB	Detector	Comment
1	*	2439.950	83.11	7.25	90.36	54.00	36.36	AVG	No Limit
2	X	2440.250	84.36	7.25	91.61	74.00	17.61	peak	No Limit

**REMARKS:**

- (1) Measurement Value = Reading Level + Correct Factor.
- (2) Margin Level = Measurement Value - Limit Value.

Test Mode : TX 2440 MHz \_CH19\_ 1Mbps

### Horizontal

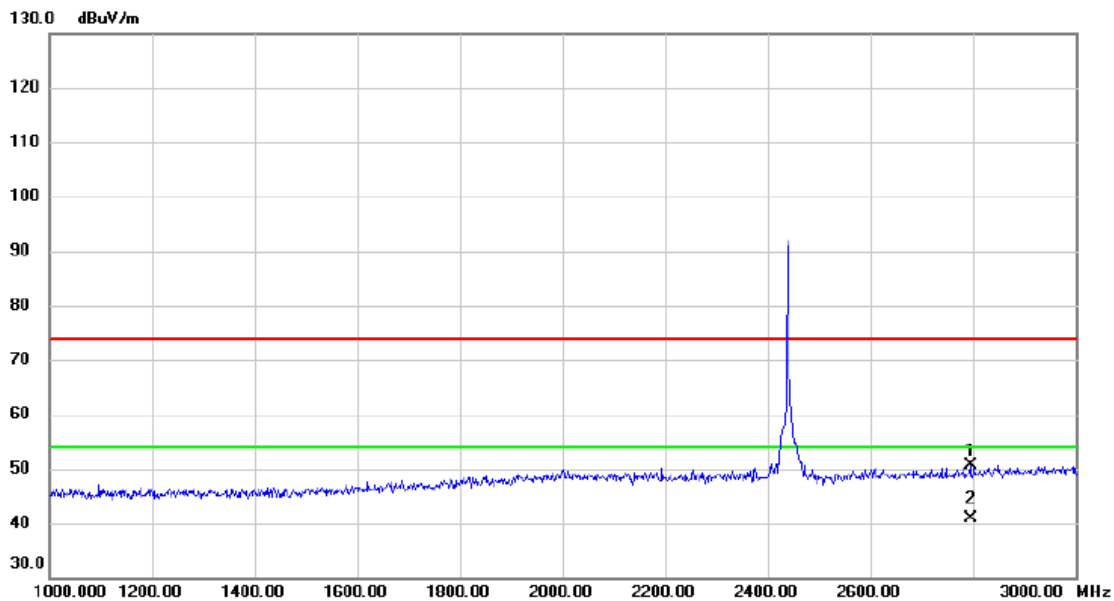

No.	Mk.	Freq. MHz	Reading Level dBuV	Correct Factor dB	Measure- ment dBuV/m	Limit dBuV/m	Margin dB	Detector	Comment
1		2795.000	42.32	8.39	50.71	74.00	-23.29	peak	
2	*	2795.000	32.58	8.39	40.97	54.00	-13.03	AVG	

**REMARKS:**

- (1) Measurement Value = Reading Level + Correct Factor.
- (2) Margin Level = Measurement Value - Limit Value.

Test Mode : TX 2440 MHz \_CH19\_1Mbps

### Horizontal

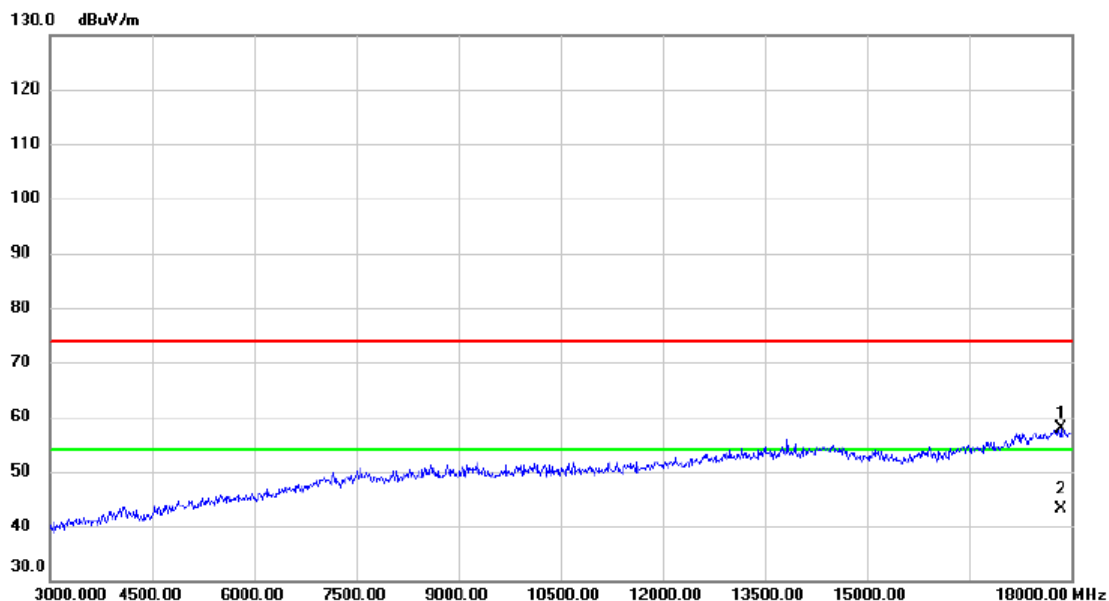

No.	Mk.	Freq. MHz	Reading Level dBuV	Correct Factor dB	Measure- ment dBuV/m	Limit dBuV/m	Margin dB	Detector	Comment
1		17842.500	37.23	20.63	57.86	74.00	-16.14	peak	
2	*	17842.500	22.43	20.63	43.06	54.00	-10.94	AVG	

**REMARKS:**

- (1) Measurement Value = Reading Level + Correct Factor.
- (2) Margin Level = Measurement Value - Limit Value.

Test Mode : TX 2440 MHz \_CH19\_1Mbps

### Horizontal

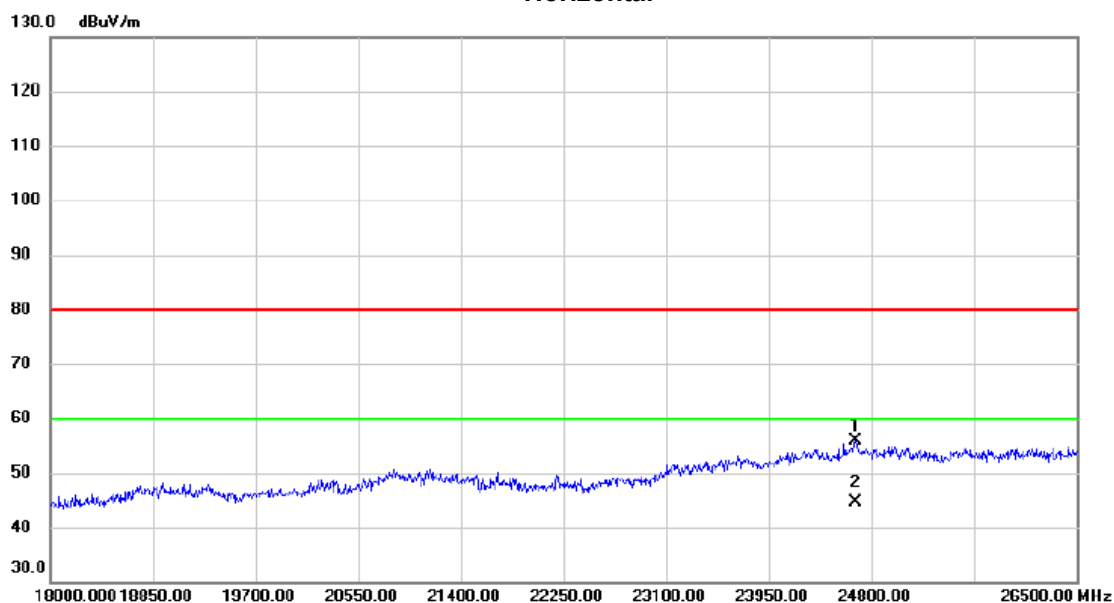

No. Mk.	Freq. MHz	Reading Level dBuV	Correct Factor dB	Measure- ment dBuV/m	Limit dBuV/m	Margin dB	Detector	Comment
1	24672.500	25.88	30.07	55.95	80.00	-24.05	peak	
2 *	24672.500	14.68	30.07	44.75	60.00	-15.25	AVG	

**REMARKS:**

- (1) Measurement Value = Reading Level + Correct Factor.
- (2) Margin Level = Measurement Value - Limit Value.

Test Mode : TX 2480 MHz \_CH39\_1Mbps

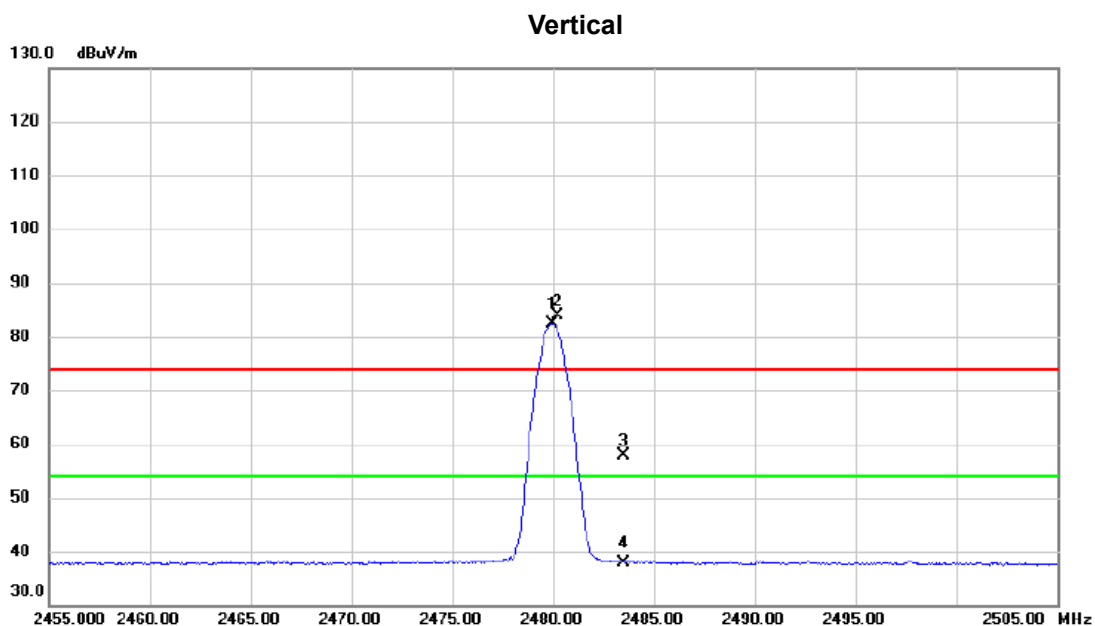

No.	Mk.	Freq. MHz	Reading Level dBuV	Correct Factor dB	Measure- ment dBuV/m	Limit dBuV/m	Margin dB	Detector	Comment
1	*	2479.950	75.22	7.25	82.47	54.00	28.47	AVG	No Limit
2	X	2480.250	76.59	7.25	83.84	74.00	9.84	peak	No Limit
3		2483.500	50.60	7.25	57.85	74.00	-16.15	peak	
4		2483.500	30.75	7.25	38.00	54.00	-16.00	AVG	

**REMARKS:**

- (1) Measurement Value = Reading Level + Correct Factor.
- (2) Margin Level = Measurement Value - Limit Value.

Test Mode : TX 2480 MHz \_CH39\_1Mbps

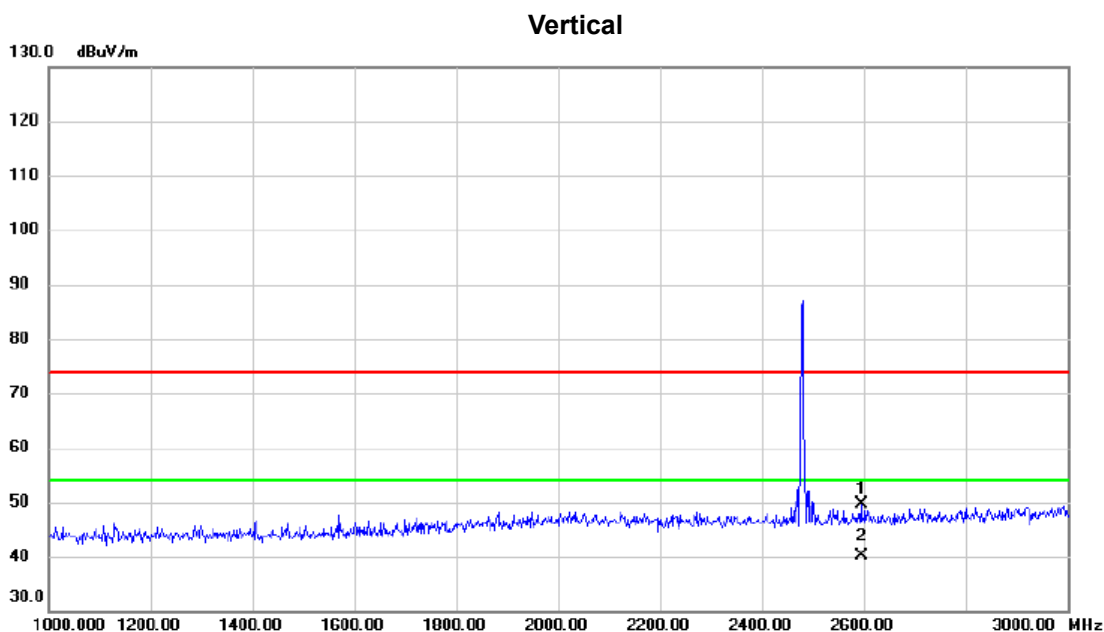

No.	Mk.	Freq. MHz	Reading Level dBuV	Correct Factor dB	Measure- ment dBuV/m	Limit dBuV/m	Margin dB	Detector	Comment
1		2595.000	42.10	7.62	49.72	74.00	-24.28	peak	
2	*	2595.000	32.53	7.62	40.15	54.00	-13.85	AVG	

**REMARKS:**

- (1) Measurement Value = Reading Level + Correct Factor.
- (2) Margin Level = Measurement Value - Limit Value.



Test Mode : TX 2480 MHz \_CH39\_1Mbps

### Vertical

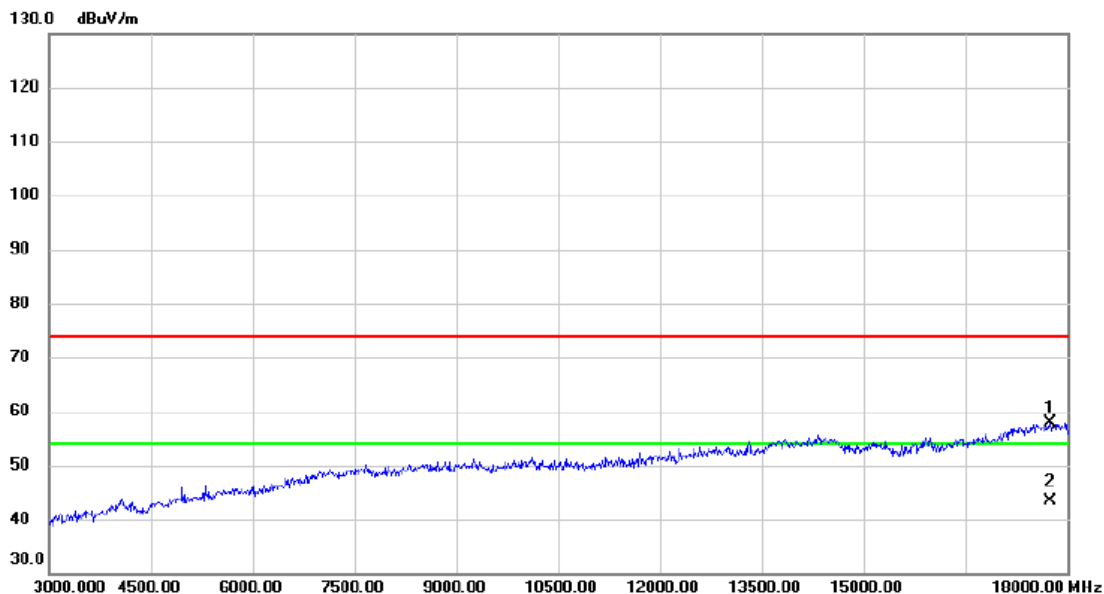

No.	Mk.	Freq. MHz	Reading Level dBuV	Correct Factor dB	Measure- ment dBuV/m	Limit dBuV/m	Margin dB	Detector	Comment
1		17752.500	37.31	20.63	57.94	74.00	-16.06	peak	
2	*	17752.500	22.85	20.63	43.48	54.00	-10.52	AVG	

**REMARKS:**

- (1) Measurement Value = Reading Level + Correct Factor.
- (2) Margin Level = Measurement Value - Limit Value.

Test Mode : TX 2480 MHz \_CH39\_1Mbps

### Vertical

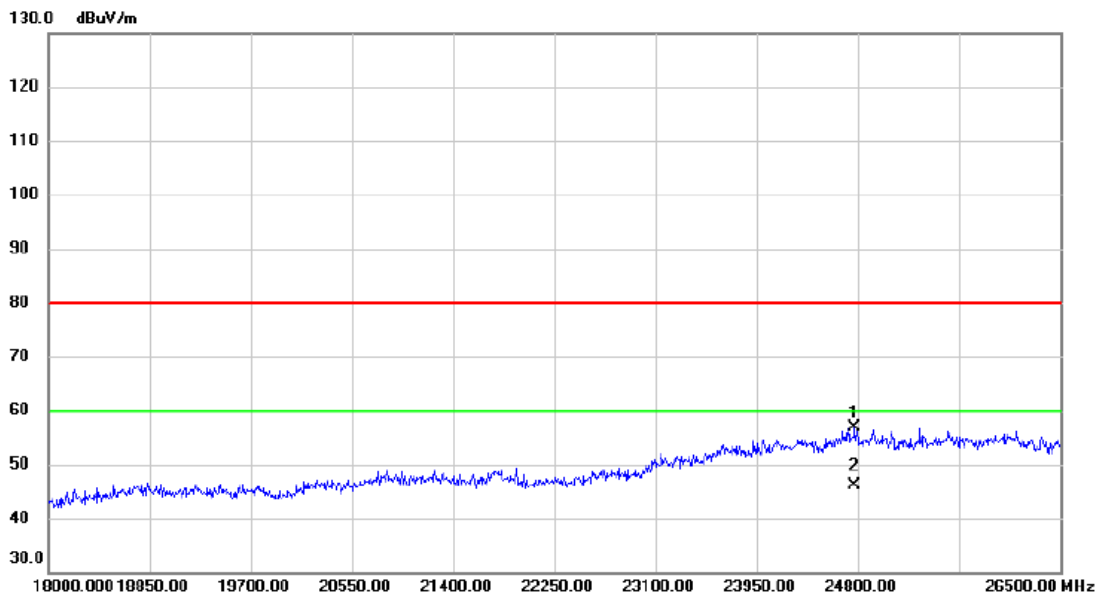

No.	Mk.	Freq. MHz	Reading Level dBuV	Correct Factor dB	Measure- ment dBuV/m	Limit dBuV/m	Margin dB	Detector	Comment
1		24774.500	26.63	30.22	56.85	80.00	-23.15	peak	
2	*	24774.500	15.98	30.22	46.20	60.00	-13.80	AVG	

**REMARKS:**

(1) Measurement Value = Reading Level + Correct Factor.

(2) Margin Level = Measurement Value - Limit Value.

Test Mode : TX 2480 MHz \_CH39\_1Mbps

### Horizontal

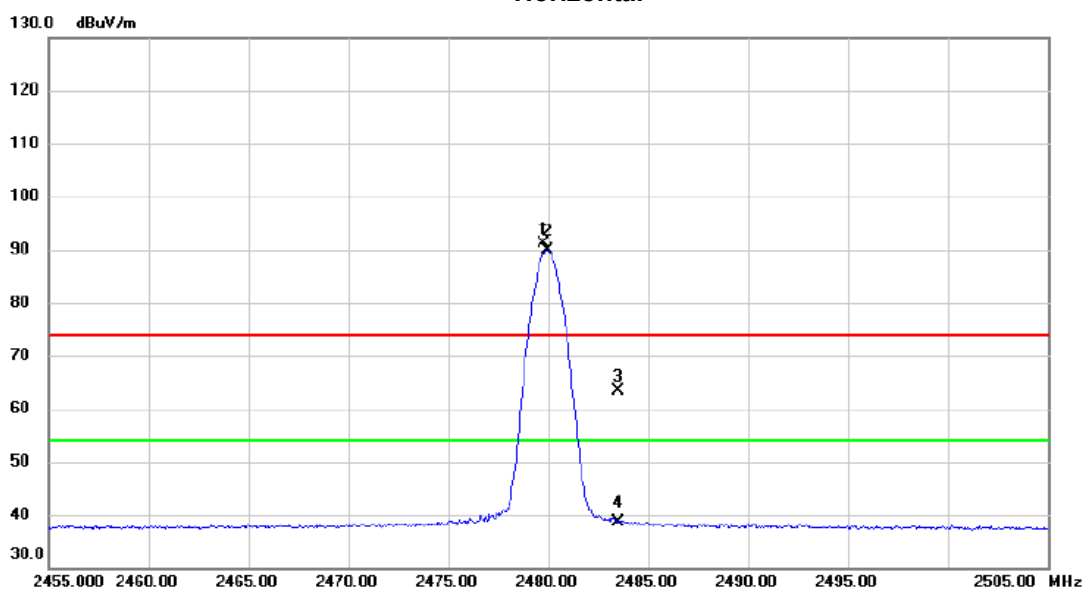

No.	Mk.	Freq. MHz	Reading Level dBuV	Correct Factor dB	Measure- ment dBuV/m	Limit dBuV/m	Margin dB	Detector	Comment
1	X	2479.750	83.98	7.25	91.23	74.00	17.23	peak	No Limit
2	*	2479.950	82.67	7.25	89.92	54.00	35.92	AVG	No Limit
3		2483.500	56.22	7.25	63.47	74.00	-10.53	peak	
4		2483.500	31.28	7.25	38.53	54.00	-15.47	AVG	

**REMARKS:**

- (1) Measurement Value = Reading Level + Correct Factor.
- (2) Margin Level = Measurement Value - Limit Value.

Test Mode : TX 2480 MHz \_CH39\_1Mbps

### Horizontal

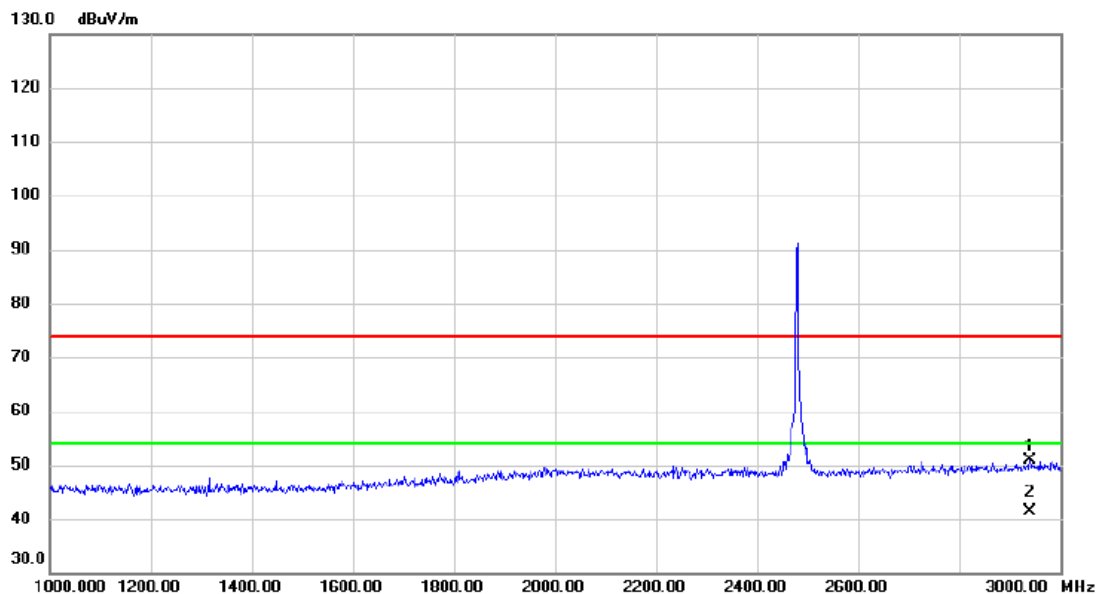

No.	Mk.	Freq. MHz	Reading Level dBuV	Correct Factor dB	Measure- ment dBuV/m	Limit dBuV/m	Margin dB	Detector	Comment
1		2941.000	41.83	8.94	50.77	74.00	-23.23	peak	
2	*	2941.000	32.43	8.94	41.37	54.00	-12.63	AVG	

**REMARKS:**

- (1) Measurement Value = Reading Level + Correct Factor.
- (2) Margin Level = Measurement Value - Limit Value.

Test Mode : TX 2480 MHz \_CH39\_1Mbps

### Horizontal

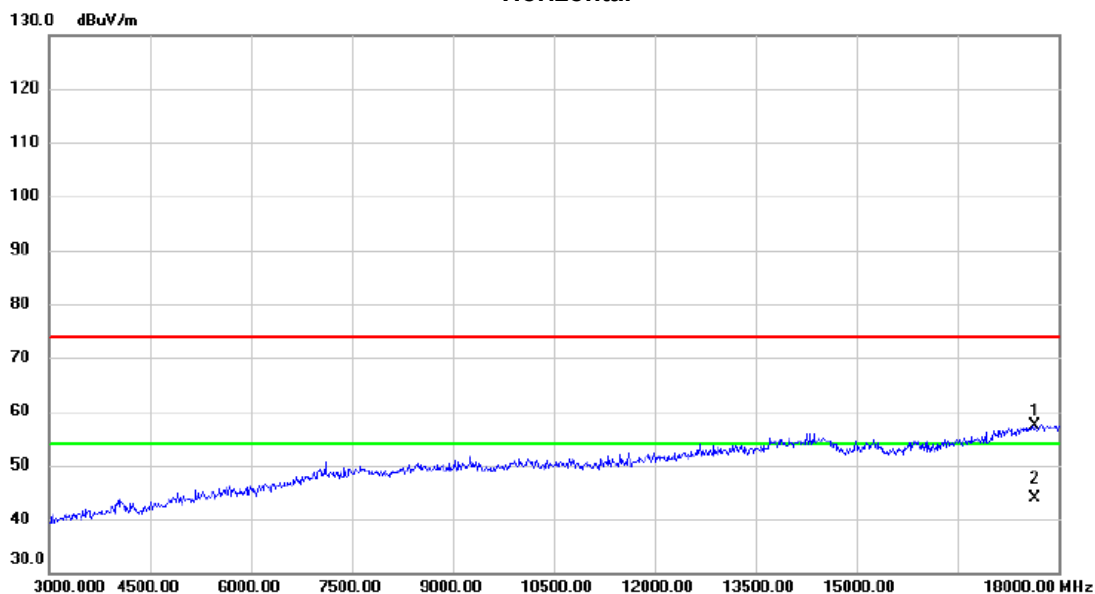

No.	Mk.	Freq. MHz	Reading Level dBuV	Correct Factor dB	Measure- ment dBuV/m	Limit dBuV/m	Margin dB	Detector	Comment
1		17647.500	36.79	20.61	57.40	74.00	-16.60	peak	
2	*	17647.500	23.15	20.61	43.76	54.00	-10.24	AVG	

**REMARKS:**

- (1) Measurement Value = Reading Level + Correct Factor.
- (2) Margin Level = Measurement Value - Limit Value.

Test Mode : TX 2480 MHz \_CH39\_1Mbps

### Horizontal

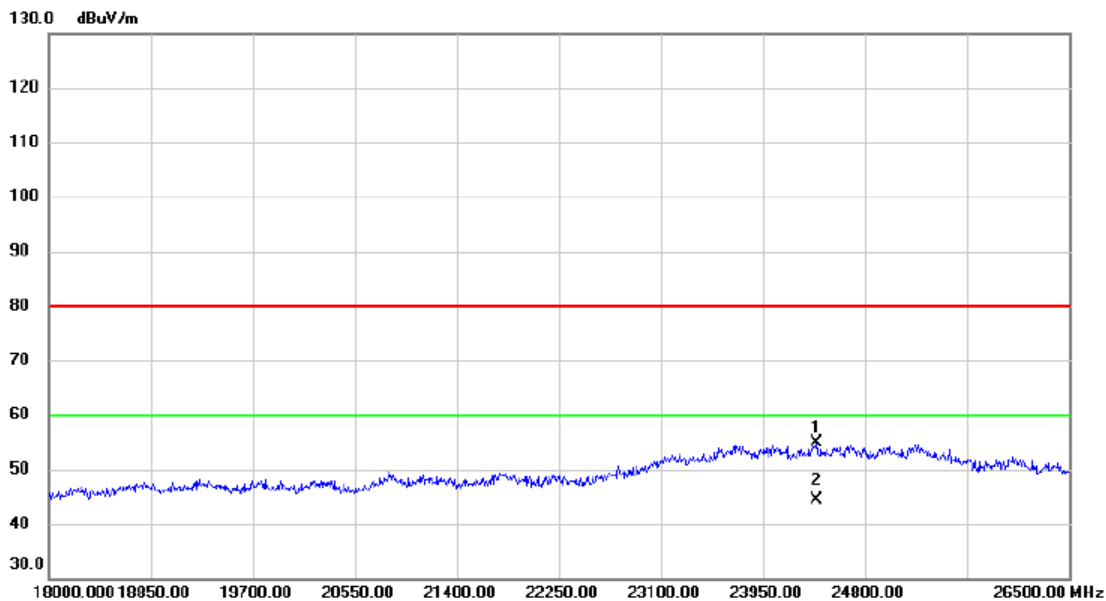

No.	Mk.	Freq. MHz	Reading Level dBuV	Correct Factor dB	Measure- ment dBuV/m	Limit dBuV/m	Margin dB	Detector	Comment
1		24400.500	25.18	29.69	54.87	80.00	-25.13	peak	
2	*	24400.500	14.75	29.69	44.44	60.00	-15.56	AVG	

**REMARKS:**

- (1) Measurement Value = Reading Level + Correct Factor.
- (2) Margin Level = Measurement Value - Limit Value.

## APPENDIX E - BANDWIDTH

Test Mode: CH00, CH19, CH39 - 1Mbps

Channel	Frequency (MHz)	6 dB Bandwidth (MHz)	99 % Emission Bandwidth (MHz)	6 dB Bandwidth Min. Limit (MHz)	Test Result
00	2402	0.664	1.036	0.5	Pass
19	2440	0.670	1.048	0.5	Pass
39	2480	0.702	1.060	0.5	Pass

### CH00

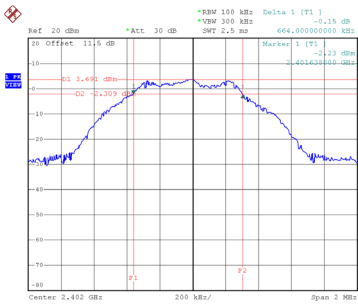

Date: 8.DEC.2020 08:52:16

### CH19

#### 6 dB Bandwidth

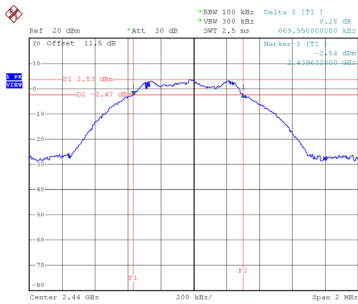

Date: 8.DEC.2020 08:54:15

### CH39

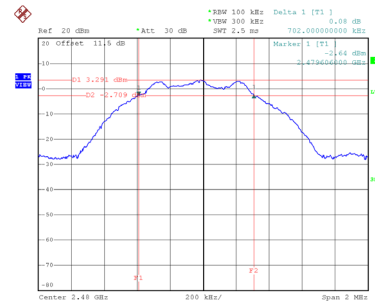

Date: 8.DEC.2020 08:56:33

### 99 % Emission Bandwidth

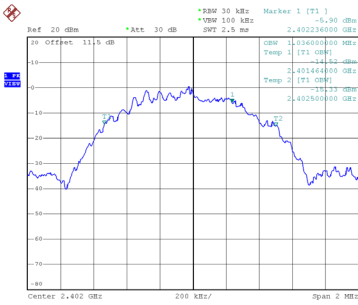

Date: 8.DEC.2020 08:51:46

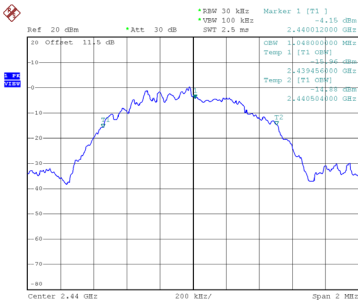

Date: 8.DEC.2020 08:54:22

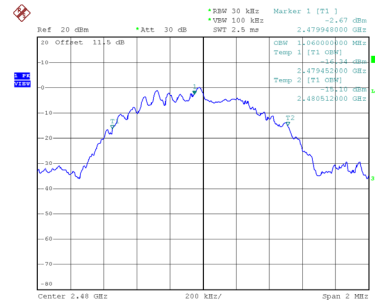

Date: 8.DEC.2020 08:56:39



## **APPENDIX F - MAXIMUM OUTPUT POWER**

Test Mode : CH00, CH19 , CH39 - 1Mbps

Frequency (MHz)	Output Power (dBm)	Output Power (W)	Max. Limit (dBm)	Max. Limit (W)	Test Result
2402	3.55	0.0023	30.00	1.00	Pass
2440	3.38	0.0022	30.00	1.00	Pass
2480	3.12	0.0021	30.00	1.00	Pass

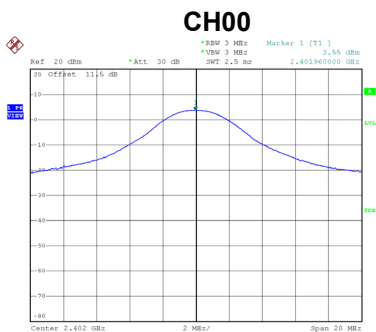

Date: 7.DEC.2020 10:03:47

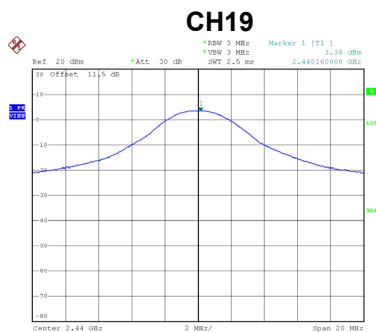

Date: 7.DEC.2020 10:04:21

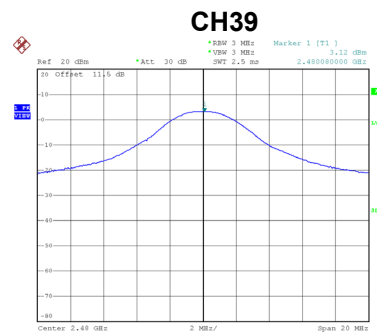

Date: 7.DEC.2020 10:04:51

**APPENDIX G - CONDUCTED SPURIOUS EMISSION**

Test Mode : CH00, CH19 , CH39 - 1Mbps

### Bandedge CH00 (Lower)

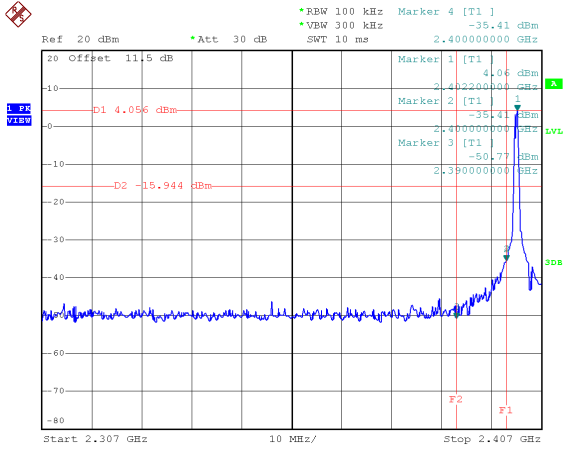

### Bandedge CH39 (Upper)

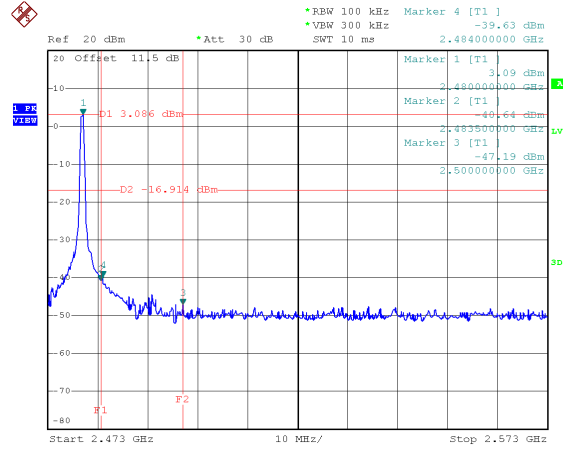

Date: 8.DEC.2020 08:52:24

Date: 8.DEC.2020 08:56:47

### CH00 – 10th Harmonic of the fundamental frequency

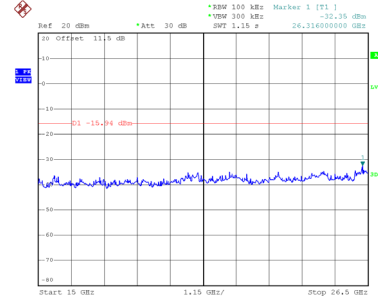
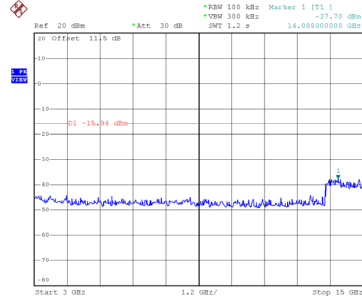
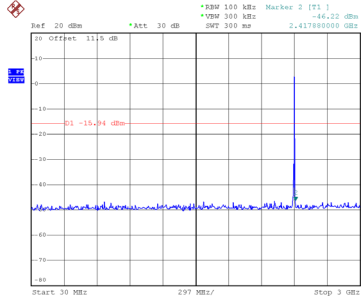

Date: 8.DEC.2020 08:52:38

Date: 8.DEC.2020 08:52:46

Date: 8.DEC.2020 08:52:54

### CH19 – 10th Harmonic of the fundamental frequency

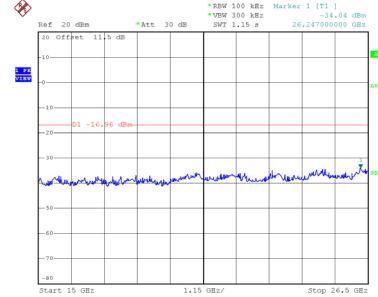
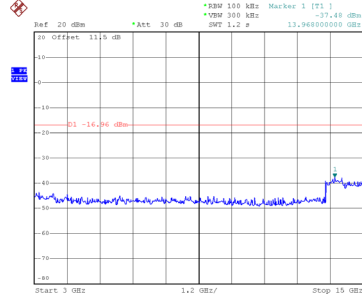
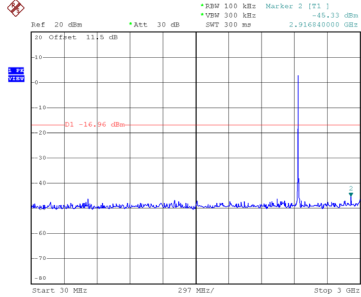

Date: 8.DEC.2020 08:54:44

Date: 8.DEC.2020 08:54:52

Date: 8.DEC.2020 08:55:00

### CH39 – 10th Harmonic of the fundamental frequency

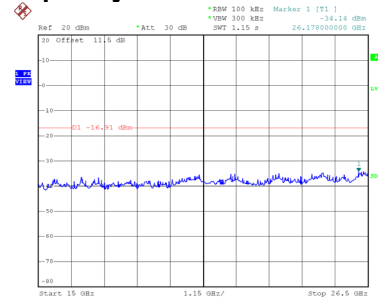
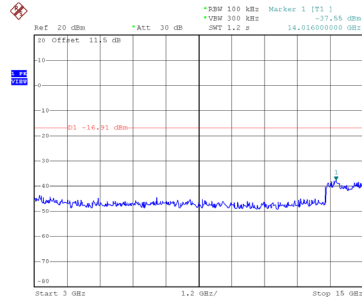
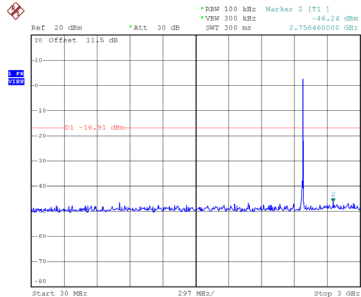

Date: 8.DEC.2020 08:57:01

Date: 8.DEC.2020 08:57:09

Date: 8.DEC.2020 08:57:17

## **APPENDIX H - POWER SPECTRAL DENSITY**

Test Mode: CH00, CH19 , CH39 - 1Mbps

Channel	Frequency (MHz)	Power Spectral Density (dBm/3 kHz)	Max. Limit (dBm/3 kHz)	Test Result
00	2402	-11.55	8.00	Pass
19	2440	-12.10	8.00	Pass
39	2480	-12.40	8.00	Pass

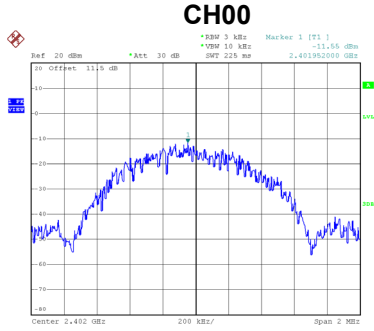

Date: 8.DEC.2020 08:53:00

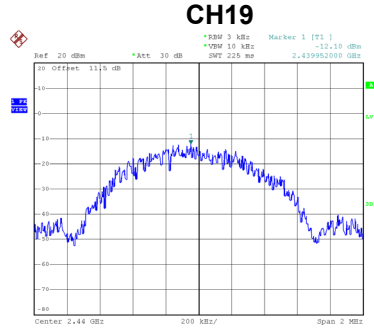

Date: 8.DEC.2020 08:55:06

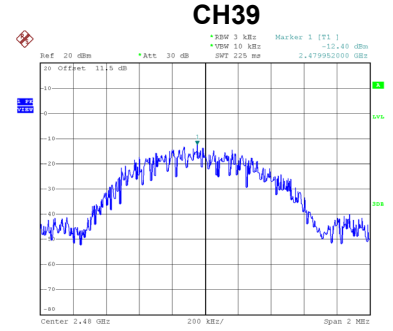

Date: 8.DEC.2020 08:57:23

End of Test Report