

# FCC Radio Test Report

## FCC ID: 2AYGCCHL-LX3

This report concerns: **Original Grant**

**Project No.** : 2012C016  
**Equipment** : Smart Phone  
**Brand Name** : HONOR  
**Test Model** : CHL-LX3  
**Series Model** : N/A  
**Applicant** : Honor Device Co., Ltd.  
**Address** : Suite 3401, Unit A, Building 6, Shum Yip Sky Park, No. 8089, Hongli West Road, Xiangmihu Street, Futian District, Shenzhen, Guangdong 518040, People's Republic of China  
**Manufacturer** : Honor Device Co., Ltd.  
**Address** : Suite 3401, Unit A, Building 6, Shum Yip Sky Park, No. 8089, Hongli West Road, Xiangmihu Street, Futian District, Shenzhen, Guangdong 518040, People's Republic of China  
**Date of Receipt** : Dec. 04, 2020  
**Date of Test** : Dec. 04, 2020 ~ Feb. 05, 2021  
**Issued Date** : Mar. 01, 2021  
**Report Version** : R00  
**Test Sample** : Engineering Sample No.: DG20201210169 for radiated, DG20201210167 for conducted.  
**Standard(s)** : FCC Part15, Subpart C (15.247)  
ANSI C63.10-2013  
FCC KDB 558074 D01 15.247 Meas Guidance v05r02

The above equipment has been tested and found compliance with the requirement of the relative standards by BTL Inc.

*Trey Chen*

Prepared by : Trey Chen

*Steven Lu*

Approved by : Steven Lu

Add: No.3, Jinshagang 1st Road, Shixia, Dalang Town, Dongguan, Guangdong, China.

Tel: +86-769-8318-3000

Web: www.newbtl.com



Certificate #5123.02

**Declaration**

**BTL** represents to the client that testing is done in accordance with standard procedures as applicable and that test instruments used has been calibrated with standards traceable to international standard(s) and/or national standard(s).

**BTL's** reports apply only to the specific samples tested under conditions. It is manufacture's responsibility to ensure that additional production units of this model are manufactured with the identical electrical and mechanical components. **BTL** shall have no liability for any declarations, inferences or generalizations drawn by the client or others from **BTL** issued reports.

The report must not be used by the client to claim product certification, approval, or endorsement by NVLAP, NIST, A2LA, or any agency of the U.S. Government.

This report is the confidential property of the client. As a mutual protection to the clients, the public and ourselves, the test report shall not be reproduced, except in full, without our written approval.

**BTL's** laboratory quality assurance procedures are in compliance with the **ISO/IEC 17025** requirements, and accredited by the conformity assessment authorities listed in this test report.

**BTL** is not responsible for the sampling stage, so the results only apply to the sample as received.

The information, data and test plan are provided by manufacturer which may affect the validity of results, so it is manufacturer's responsibility to ensure that the apparatus meets the essential requirements of applied standards and in all the possible configurations as representative of its intended use.

**Limitation**

For the use of the authority's logo is limited unless the Test Standard(s)/Scope(s)/Item(s) mentioned in this test report is (are) included in the conformity assessment authorities acceptance respective.

Please note that the measurement uncertainty is provided for informational purpose only and are not use in determining the Pass/Fail results.

<b>Table of Contents</b>	<b>Page</b>
<b>REPORT ISSUED HISTORY</b>	<b>5</b>
<b>1 . SUMMARY OF TEST RESULTS</b>	<b>6</b>
1.1 TEST FACILITY	7
1.2 MEASUREMENT UNCERTAINTY	7
1.3 TEST ENVIRONMENT CONDITIONS	8
<b>2 . GENERAL INFORMATION</b>	<b>9</b>
2.1 GENERAL DESCRIPTION OF EUT	9
2.2 DESCRIPTION OF TEST MODES	12
2.3 PARAMETERS OF TEST SOFTWARE	13
2.4 BLOCK DIAGRAM SHOWING THE CONFIGURATION OF SYSTEM TESTED	14
2.5 SUPPORT UNITS	14
<b>3 . AC POWER LINE CONDUCTED EMISSIONS TEST</b>	<b>15</b>
3.1 LIMIT	15
3.2 TEST PROCEDURE	15
3.3 DEVIATION FROM TEST STANDARD	15
3.4 TEST SETUP	16
3.5 EUT OPERATING CONDITIONS	16
3.6 TEST RESULTS	16
<b>4 . RADIATED EMISSION TEST</b>	<b>17</b>
4.1 LIMIT	17
4.2 TEST PROCEDURE	18
4.3 DEVIATION FROM TEST STANDARD	18
4.4 TEST SETUP	19
4.5 EUT OPERATING CONDITIONS	20
4.6 TEST RESULT - 9 KHZ TO 30 MHZ	20
4.7 TEST RESULT - 30 MHZ TO 1000 MHZ	20
4.8 TEST RESULT - ABOVE 1000 MHZ	20
<b>5 . BANDWIDTH TEST</b>	<b>21</b>
5.1 LIMIT	21
5.2 TEST PROCEDURE	21
5.3 DEVIATION FROM STANDARD	21
5.4 TEST SETUP	21
5.5 EUT OPERATION CONDITIONS	21

<b>Table of Contents</b>	<b>Page</b>
5.6 TEST RESULTS	21
<b>6 . MAXIMUM OUTPUT POWER</b>	<b>22</b>
6.1 LIMIT	22
6.2 TEST PROCEDURE	22
6.3 DEVIATION FROM STANDARD	22
6.4 TEST SETUP	22
6.5 EUT OPERATION CONDITIONS	22
6.6 TEST RESULTS	22
<b>7 . CONDUCTED SPURIOUS EMISSION</b>	<b>23</b>
7.1 LIMIT	23
7.2 TEST PROCEDURE	23
7.3 DEVIATION FROM STANDARD	23
7.4 TEST SETUP	23
7.5 EUT OPERATION CONDITIONS	23
7.6 TEST RESULTS	23
<b>8 . POWER SPECTRAL DENSITY TEST</b>	<b>24</b>
8.1 LIMIT	24
8.2 TEST PROCEDURE	24
8.3 DEVIATION FROM STANDARD	24
8.4 TEST SETUP	24
8.5 EUT OPERATION CONDITIONS	24
8.6 TEST RESULTS	24
<b>9 . MEASUREMENT INSTRUMENTS LIST</b>	<b>25</b>
<b>APPENDIX A - AC POWER LINE CONDUCTED EMISSIONS</b>	<b>27</b>
<b>APPENDIX B - RADIATED EMISSION - 9 KHZ TO 30 MHZ</b>	<b>30</b>
<b>APPENDIX C - RADIATED EMISSION - 30 MHZ TO 1000 MHZ</b>	<b>35</b>
<b>APPENDIX D - RADIATED EMISSION - ABOVE 1000 MHZ</b>	<b>38</b>
<b>APPENDIX E - BANDWIDTH</b>	<b>87</b>
<b>APPENDIX F - MAXIMUM OUTPUT POWER</b>	<b>90</b>
<b>APPENDIX G - CONDUCTED SPURIOUS EMISSION</b>	<b>92</b>
<b>APPENDIX H - POWER SPECTRAL DENSITY</b>	<b>95</b>

**REPORT ISSUED HISTORY**

Report Version	Description	Issued Date
R00	Original Issue.	Mar. 01, 2021

**1. SUMMARY OF TEST RESULTS**

Test procedures according to the technical standard(s):

FCC Part15, Subpart C (15.247)				
Standard(s) Section	Test Item	Test Result	Judgment	Remark
15.207	AC Power Line Conducted Emissions	APPENDIX A	PASS	-----
15.247(d) 15.205(a) 15.209(a)	Radiated Emissions	APPENDIX B APPENDIX C APPENDIX D	PASS	-----
15.247(a)(2)	Bandwidth	APPENDIX E	PASS	-----
15.247(b)(3)	Maximum Output Power	APPENDIX F	PASS	-----
15.247(d)	Conducted Spurious Emission	APPENDIX G	PASS	-----
15.247(e)	Power Spectral Density	APPENDIX H	PASS	-----
15.203	Antenna Requirement	-----	PASS	Note(2)

Note:

- (1) "N/A" denotes test is not applicable to this device.
- (2) The device what use a permanently attached antenna were considered sufficient to comply with the provisions of 15.203.

## 1.1 TEST FACILITY

The test facilities used to collect the test data in this report is at the location of No.3, Jinshagang 1st Road, Shixia, Dalang Town, Dongguan, Guangdong, China.

BTL's Test Firm Registration Number for FCC: 357015

BTL's Designation Number for FCC: CN1240

## 1.2 MEASUREMENT UNCERTAINTY

ISO/IEC 17025 requires that an estimate of the measurement uncertainties associated with the emissions test results be included in the report. The measurement uncertainties given below are based on a 95% confidence level (based on a coverage factor (k=2))

The BTL measurement uncertainty as below table:

### A. AC power line conducted emissions Measurement:

Test Site	Method	Measurement Frequency Range	U, (dB)
DG-C02	CISPR	150kHz ~ 30MHz	2.68

### B. Radiated emissions Measurement:

Test Site	Method	Measurement Frequency Range	Ant. H / V	U, (dB)
DG-CB03	CISPR	9kHz ~ 30MHz	-	3.02
		30MHz ~ 200MHz	V	4.26
		30MHz ~ 200MHz	H	3.38
		200MHz ~ 1,000MHz	V	3.98
		200MHz ~ 1,000MHz	H	3.94
		1GHz ~ 6GHz	-	3.96
		6GHz ~ 18GHz	-	5.24
		18GHz ~ 26.5GHz	-	3.62
		26.5GHz ~ 40GHz	-	4.00

### C. Other Measurement:

Test Item	Uncertainty
Bandwidth	±3.8 %
Maximum Output Power	±0.95 dB
Conducted Spurious Emission	±2.71 dB
Power Spectral Density	±0.86 dB
Temperature	±0.08 °C
Humidity	±1.5%

Note: Unless specifically mentioned, the uncertainty of measurement has not been taken into account to declare the compliance or non-compliance to the specification.on.

**1.3 TEST ENVIRONMENT CONDITIONS**

Test Item	Temperature	Humidity	Test Voltage	Tested By
AC Power Line Conducted Emissions	25°C	53%	AC 120V/60Hz	Gerry Zhao
Radiated Emissions-9K-30MHz	25°C	60%	AC 120V/60Hz	Grani Zhou
Radiated Emissions-30 MHz to 1GHz	26°C	52%	AC 120V/60Hz	Grani Zhou
Radiated Emissions-Above 1000 MHz	26°C	52%	AC 120V/60Hz	Grani Zhou
Bandwidth	23.5°C	46%	DC 3.87V	Jesse Wang
Maximum Output Power	23.5°C	46%	DC 3.87V	Silly Zheng
Conducted Spurious Emission	23.5°C	46%	DC 3.87V	Jesse Wang
Power Spectral Density	23.5°C	46%	DC 3.87V	Jesse Wang



## 2. GENERAL INFORMATION

### 2.1 GENERAL DESCRIPTION OF EUT

Equipment	Smart Phone
Brand Name	HONOR
Test Model	CHL-LX3
Series Model	N/A
Model Difference(s)	N/A
Hardware Version	HL3CHLM
Software Version	5.0.0.80(C900E76R1P4)
Power Source	1# DC voltage supplied from AC adapter. 2# Supplied from battery. 3# Supplied from USB port.
Power Rating	1# (1) I/P: 100-240V ~ 50/60Hz, 1.2A O/P: 5V === 2A OR 9V === 2V OR 10V === 4A (2) I/P: 100-240V ~ 50/60Hz, 0.75A O/P: 5V === 2A OR 9V === 2V OR 10V === 2.25A 2# DC 3.87V, 3900mAh 3# DC 5V
Operation Frequency	2402 MHz ~ 2480 MHz
Modulation Technology	GFSK
Bit Rate of Transmitter	1Mbps, 2Mbps
Max. Output Power	1Mbps :6.55 dBm (0.0045 W) 2Mbps :7.13 dBm (0.0052 W)

Note:

1. For a more detailed features description, please refer to the manufacturer's specifications or the user's manual.

## 2. Channel List:

Channel	Frequency (MHz)	Channel	Frequency (MHz)
00	2402	20	2442
01	2404	21	2444
02	2406	22	2446
03	2408	23	2448
04	2410	24	2450
05	2412	25	2452
06	2414	26	2454
07	2416	27	2456
08	2418	28	2458
09	2420	29	2460
10	2422	30	2462
11	2424	31	2464
12	2426	32	2466
13	2428	33	2468
14	2430	34	2470
15	2432	35	2472
16	2434	36	2474
17	2436	37	2476
18	2438	38	2478
19	2440	39	2480

## 3. Table for Filed Antenna:

Ant.	Brand	Model Name	Antenna Type	Connector	Gain (dBi)
1	N/A	N/A	Internal	N/A	-2

Note: The antenna gain is provided by the manufacturer.

## 4. The EUT contains following accessory devices:

Items	Trademark / Manufacturer / Factory	Model Name	Description
Adapter	Honor Device Co., Ltd.	HW-100400E01 HW-100400U01 HW-100400B01 HW-100400A01	I/P: 100-240V ~50/60Hz, 1.2A O/P: 5V $\equiv$ 2A OR 9V $\equiv$ 2V OR 10V $\equiv$ 4A
		HW-100400E02 HW-100400U02 HW-100400B02 HW-100400A02	
	Honor Device Co., Ltd. (Manufacturer: BYD / Huntkey / Phitek)	HW-100225E00	I/P: 100-240V ~50/60Hz, 0.75A O/P: 5V $\equiv$ 2A OR 9V $\equiv$ 2V OR 10V $\equiv$ 2.25A
Rechargeable Li-ion Battery	Honor Device Co., Ltd. (Manufacturer: Sunwoda / Desay / SCUD)	HB446589EFW	DC 3.87V, 3900mAh
	Honor Device Co., Ltd. (Manufacturer: Sunwoda / Desay / SCUD / NVT)	HB446588EFW	
Earphone/ Headset	Jiangxi Lianchuang Hongsheng Electronic Co., LTD.	MEND1532B528A11	/
	BOLUO COUNTY QUANCHENG ELECTRONIC CO.,LTD.	1293-3283-3.5mm-339	
	FOXCONN INTERCONNECT TECHNOLOGY LIMITED	EPAB542-2WH05-DH	
Data Cable	NingBo Broad Telecommunication Co., Ltd.	WA0046	/
	Freeport Resources Enterprises Corp.	AU2-CHO006HF	
	MING JI ELECTRONICS CO., LTD.	213-00989-0	
	LUXSHARE PRECISION INDUSTRY CO., LTD.	L99UC138-CS-H	
	Freeport Resources Enterprises(JIANGXI) CO., LTD	18-93C2CHO-001HF	
	NingBo Broad Telecommunication Co., Ltd.	WA0020	
	LUXSHARE PRECISION INDUSTRY CO., LTD.	L99UC131-CS-H	
	MING JI ELECTRONICS CO., LTD.	203-1572-0	
	FUYU ELECTRONICAL TECHNOLOGY(HUAIAN)CO., LTD.	CUDU01B-HC295-EH	

\*Adapter HW-100400E01, HW-100400U01, HW-100400B01 and HW-100400A01 have same board.  
Adapter HW-100400E02, HW-100400U02, HW-100400B02 and HW-100400A02 have same board.

## 2.2 DESCRIPTION OF TEST MODES

The test system was pre-tested based on the consideration of all possible combinations of EUT operation mode.

Pretest Mode	Description
Mode 1	TX Mode <b>NOTE (1)</b>
Mode 2	TX Mode Channel 19 _2Mbps

Following mode(s) was (were) found to be the worst case(s) and selected for the final test.

AC power line conducted emissions test	
Final Test Mode	Description
Mode 2	TX Mode Channel 19 _2Mbps

Radiated emissions test - Below 1GHz	
Final Test Mode	Description
Mode 2	TX Mode Channel 19 _2Mbps

Radiated emissions test - Above 1GHz	
Final Test Mode	Description
Mode 1	TX Mode <b>NOTE (1)</b>

Conducted test	
Final Test Mode	Description
Mode 1	TX Mode <b>NOTE (1)</b>

Note:

- (1) The measurements for Output Power were tested during 1Mbps, 2Mbps and 3Mbps, the worst case were 1Mbps and 3Mbps, only worst case were documented for other test items.
- (2) For radiated emission above 1 GHz test, 1GHz~26.5GHz have been pre-tested and in this report only recorded the worst case. The remaining spurious points are all below the limit value of 20dB.
- (3) For AC power line conducted emissions and radiated emissions below 1 GHz test, all adapters had been pre-tested and in this report only recorded the worst case.
- (4) For AC power line conducted emissions and radiated spurious emissions below 1 GHz test, the 2Mbps channel 19 is found to be the worst case and recorded.

### 2.3 PARAMETERS OF TEST SOFTWARE

During testing channel & power controlling software provided by the customer was used to control the operating channel as well as the output power level.

Test Software	adb CMD		
Frequency (MHz)	2402	2440	2480
Parameters(1Mbps)	N/A	N/A	N/A
Parameters(2Mbps)	N/A	N/A	N/A

## 2.4 BLOCK DIAGRAM SHOWING THE CONFIGURATION OF SYSTEM TESTED

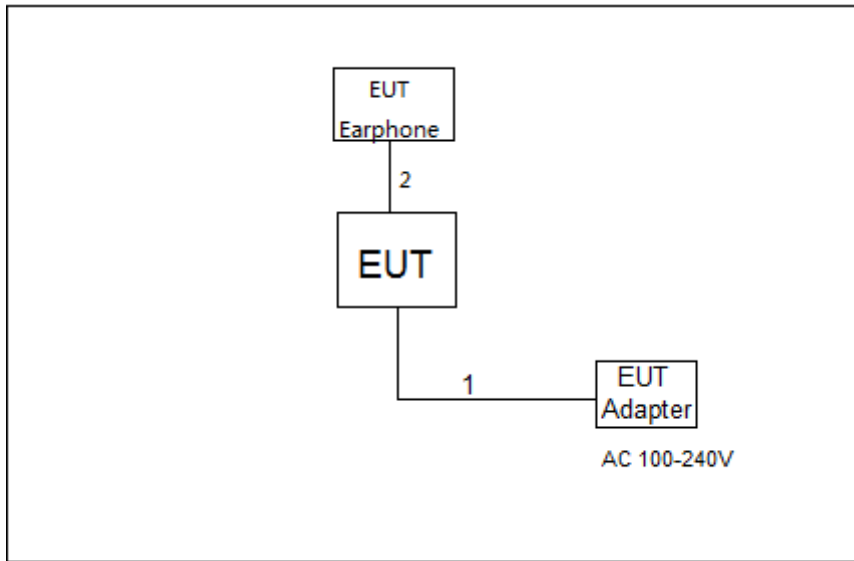

## 2.5 SUPPORT UNITS

Item	Equipment	Brand	Model No.	Series No.
-	-	-	-	-

Item	Cable Type	Shielded Type	Ferrite Core	Length
1	USB Cable	YES	NO	1m
2	Audio Cable	NO	NO	1.1m

### 3. AC POWER LINE CONDUCTED EMISSIONS TEST

#### 3.1 LIMIT

Frequency of Emission (MHz)	Limit (dB $\mu$ V)	
	Quasi-peak	Average
0.15 - 0.5	66 to 56*	56 to 46*
0.5 - 5.0	56	46
5.0 - 30.0	60	50

Note:

- (1) The tighter limit applies at the band edges.
- (2) The limit of " \* " marked band means the limitation decreases linearly with the logarithm of the frequency in the range.

The following table is the setting of the receiver

Receiver Parameters	Setting
Attenuation	10 dB
Start Frequency	0.15 MHz
Stop Frequency	30 MHz
IF Bandwidth	9 kHz

#### 3.2 TEST PROCEDURE

- a. The EUT was placed 0.8 meters from the horizontal ground plane with EUT being connected to the power mains through a line impedance stabilization network (LISN). All other support equipment powered from additional LISN(s). The LISN provide 50 Ohm/ 50uH of coupling impedance for the measuring instrument.
- b. Interconnecting cables that hang closer than 40 cm to the ground plane shall be folded back and forth in the center forming a bundle 30 to 40 cm long.
- c. I/O cables that are not connected to a peripheral shall be bundled in the center. The end of the cable may be terminated, if required, using the correct terminating impedance. The overall length shall not exceed 1 m.
- d. LISN at least 80 cm from nearest part of EUT chassis.
- e. For the actual test configuration, please refer to the related Item –EUT Test Photos.

#### 3.3 DEVIATION FROM TEST STANDARD

No deviation

### 3.4 TEST SETUP

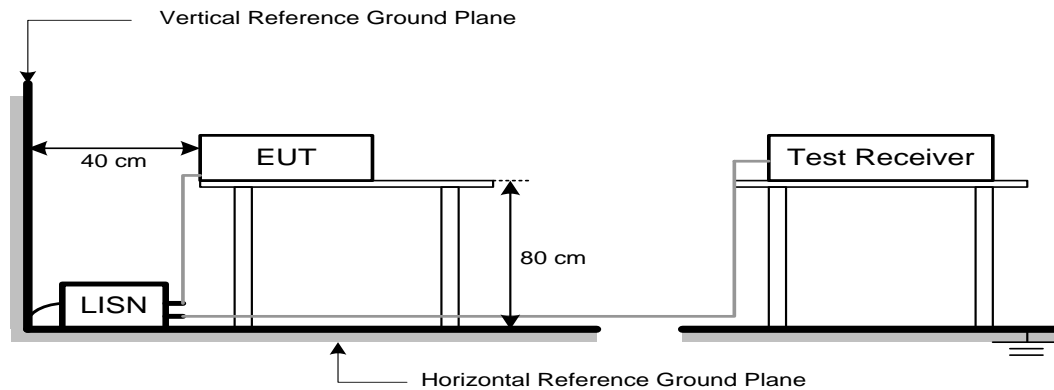

### 3.5 EUT OPERATING CONDITIONS

The EUT was configured for testing in a typical fashion (as a customer would normally use it). The EUT has been programmed to continuously transmit during test. This operating condition was tested and used to collect the included data.

### 3.6 TEST RESULTS

Please refer to the APPENDIX A.

Remark:

- (1) All readings are QP Mode value unless otherwise stated AVG in column of 『Note』 . If the QP Mode Measured value compliance with the QP Limits and lower than AVG Limits, the EUT shall be deemed to meet both QP & AVG Limits and then only QP Mode was measured, but AVG Mode didn't perform. In this case, a “ \* ” marked in AVG Mode column of Interference Voltage Measured.
- (2) Measuring frequency range from 150 kHz to 30 MHz.



#### 4. RADIATED EMISSION TEST

##### 4.1 LIMIT

In case the emission fall within the restricted band specified on 15.205(a), then the 15.209(a) limit in the table below has to be followed.

##### LIMITS OF RADIATED EMISSION MEASUREMENT (9 kHz-1000 MHz)

Frequency (MHz)	Field Strength (microvolts/meter)	Measurement Distance (meters)
0.009-0.490	2400/F(kHz)	300
0.490-1.705	24000/F(kHz)	30
1.705-30.0	30	30
30-88	100	3
88-216	150	3
216-960	200	3
Above 960	500	3

##### LIMITS OF RADIATED EMISSION MEASUREMENT (Above 1000 MHz)

Frequency (MHz)	(dBuV/m at 3 m)	
	Peak	Average
Above 1000	74	54

Note:

- (1) The limit for radiated test was performed according to FCC PART 15C.
- (2) The tighter limit applies at the band edges.
- (3) Emission level (dBuV/m)=20log Emission level (uV/m).

Spectrum Parameter	Setting
Attenuation	Auto
Start Frequency	1000 MHz
Stop Frequency	10th carrier harmonic
RBW / VBW (Emission in restricted band)	RBW 1 MHz VBW 3 MHz peak detector for Pk value RMS detector for AV value

Receiver Parameter	Setting
Attenuation	Auto
Start ~ Stop Frequency	9 kHz~90 kHz for PK/AVG detector
Start ~ Stop Frequency	90 kHz~110 kHz for QP detector
Start ~ Stop Frequency	110 kHz~490 kHz for PK/AVG detector
Start ~ Stop Frequency	490 kHz~30 MHz for QP detector
Start ~ Stop Frequency	30 MHz~1000 MHz for QP detector

#### 4.2 TEST PROCEDURE

- a. The measuring distance of 3 m shall be used for measurements. The EUT was placed on the top of a rotating table 0.8 meter above the ground at a 3 meter semi-anechoic chamber. The table was rotated 360 degrees to determine the position of the highest radiation.(below 1 GHz)
- b. The measuring distance of 3 m or 1.5m shall be used for measurements. The EUT was placed on the top of a rotating table 1.5 meter above the ground at a 3 meter semi-anechoic chamber. The table was rotated 360 degrees to determine the position of the highest radiation.(above 1GHz)
- c. The height of the equipment or of the substitution antenna shall be 0.8m or 1.5m; the height of the test antenna shall vary between 1 m to 4 m. Both horizontal and vertical polarizations of the antenna are set to make the measurement.
- d. For each suspected emission, the EUT was arranged to its worst case and then the antenna was tuned to heights find the maximum reading (used Bore sight function).
- e. The receiver system was set to peak and average detect function and specified bandwidth with maximum hold mode when the test frequency is above 1 GHz.
- f. The initial step in collecting radiated emission data is a receiver peak detector mode pre-scanning the measurement frequency range. Significant peaks are then marked and then Quasi Peak detector mode re-measured.
- g. All readings are Peak unless otherwise stated QP in column of Note. Peak denotes that the Peak reading compliance with the QP Limits and then QP Mode measurement didn't perform.  
(below 1 GHz)
- h. All readings are Peak Mode value unless otherwise stated AVG in column of Note. If the Peak Mode Measured value compliance with the Peak Limits and lower than AVG Limits, the EUT shall be deemed to meet both Peak & AVG Limits and then only Peak Mode was measured, but AVG Mode didn't perform. (above 1 GHz)
- i. For the actual test configuration, please refer to the related Item –EUT Test Photos.

#### 4.3 DEVIATION FROM TEST STANDARD

No deviation

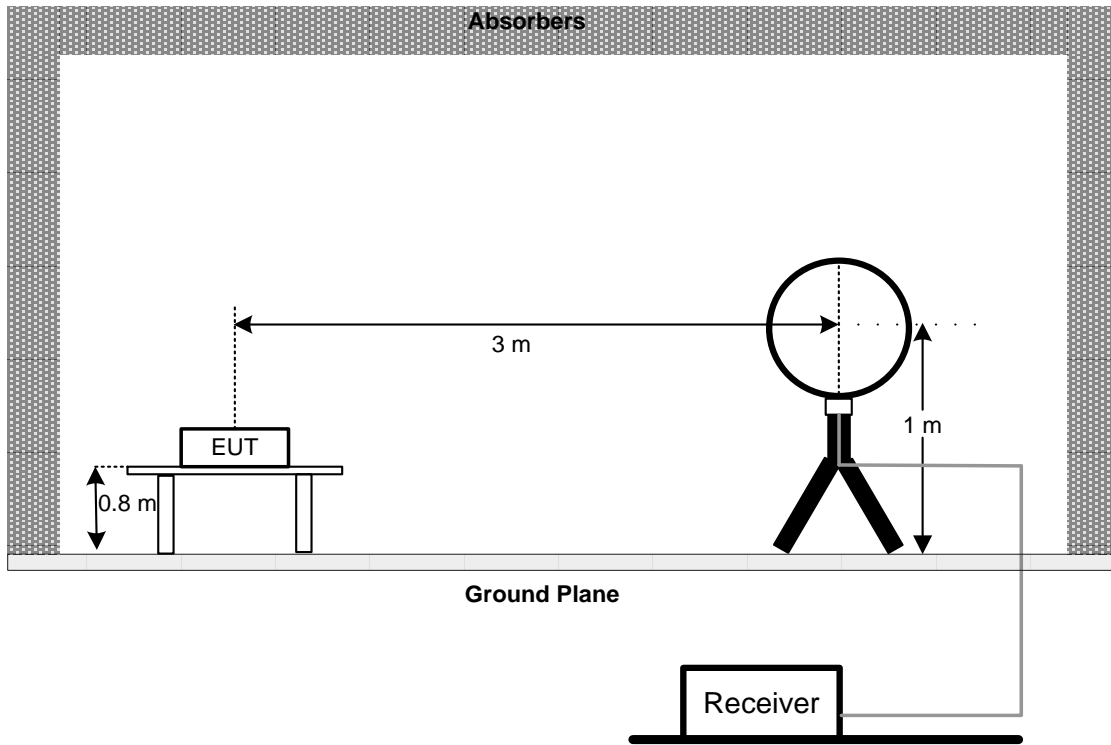
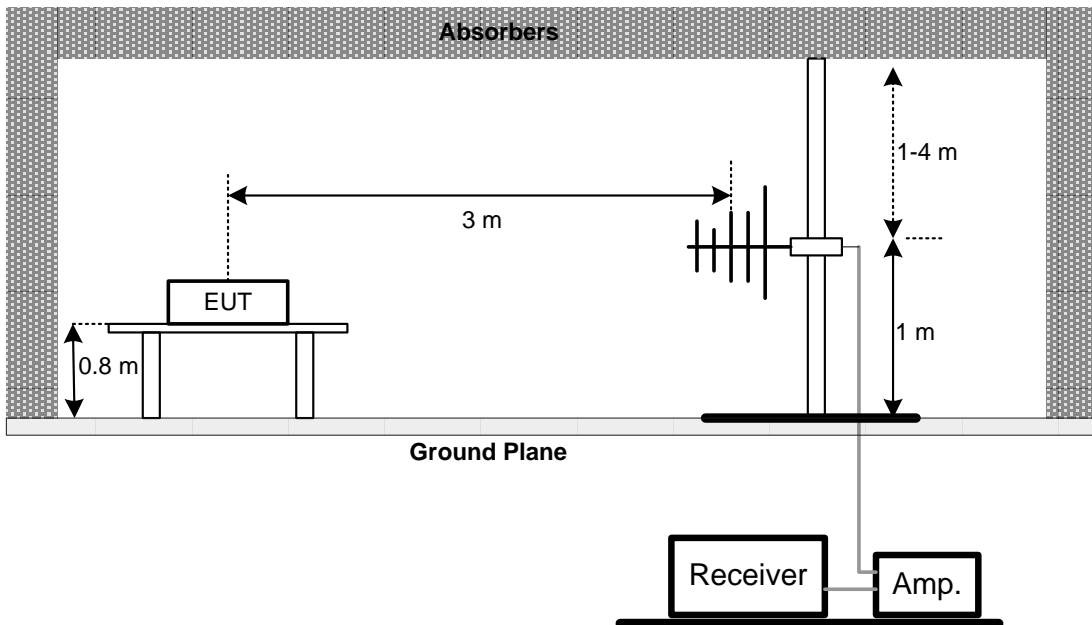
**4.4 TEST SETUP****9 kHz-30 MHz****30 MHz to 1 GHz**

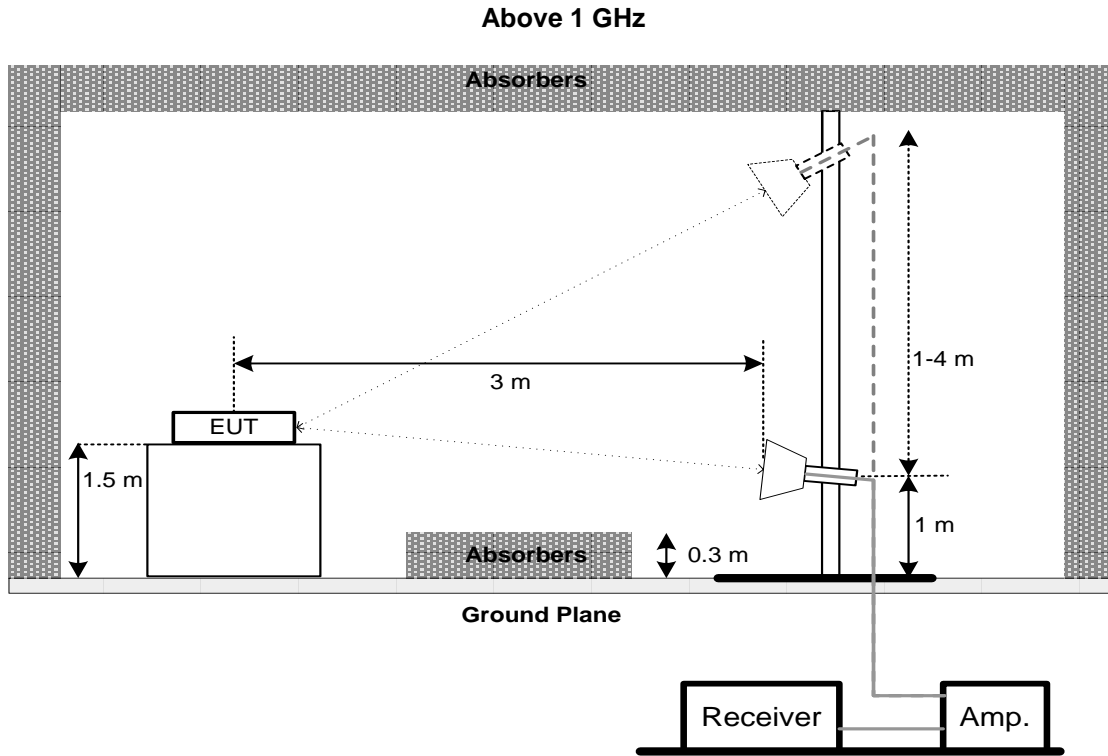

**4.5 EUT OPERATING CONDITIONS**

The EUT was programmed to be in continuously transmitting mode.

**4.6 TEST RESULT - 9 kHz TO 30 MHz**

Please refer to the APPENDIX B

Remark:

- (1) Distance extrapolation factor =  $40 \log(\text{specific distance} / \text{test distance})$  (dB).
- (2) Limit line = specific limits (dBuV) + distance extrapolation factor.

**4.7 TEST RESULT - 30 MHz TO 1000 MHz**

Please refer to the APPENDIX C.

**4.8 TEST RESULT - ABOVE 1000 MHz**

Please refer to the APPENDIX D.

Remark:

- (1) No limit: This is fundamental signal, the judgment is not applicable. For fundamental signal judgment was referred to Peak output test.

**5. BANDWIDTH TEST**

**5.1 LIMIT**

FCC Part15, Subpart C (15.247)		
Section	Test Item	Limit
15.247(a)(2)	Bandwidth	>= 500 kHz (6 dB bandwidth)
	99% Emission Bandwidth	-

**5.2 TEST PROCEDURE**

- a. The EUT was directly connected to the spectrum analyzer and antenna output port as show in the block diagram below.
- b. Spectrum Setting:  
 For 6 dB Bandwidth: RBW= 100 kHz, VBW=300 kHz, Sweep time = 2.5 ms  
 For 99 % Emission Bandwidth: RBW= 30 kHz, VBW=100 kHz, Sweep time = 2.5 ms.

**5.3 DEVIATION FROM STANDARD**

No deviation.

**5.4 TEST SETUP**



**5.5 EUT OPERATION CONDITIONS**

The EUT tested system was configured as the statements of 3.5 unless otherwise a special operating condition is specified in the follows during the testing.

**5.6 TEST RESULTS**

Please refer to the APPENDIX E.

**6. MAXIMUM OUTPUT POWER****6.1 LIMIT**

FCC Part15, Subpart C (15.247)		
Section	Test Item	Limit
15.247(b)(3)	Maximum Output Power	1 watt or 30 dBm

**6.2 TEST PROCEDURE**

- The EUT was directly connected to the spectrum analyzer and antenna output port as show in the block diagram below.
- The maximum conducted output power was performed in accordance with method 11.9.2.2 of ANSI C63.10-2013.

**6.3 DEVIATION FROM STANDARD**

No deviation.

**6.4 TEST SETUP****6.5 EUT OPERATION CONDITIONS**

The EUT tested system was configured as the statements of 3.5 unless otherwise a special operating condition is specified in the follows during the testing.

**6.6 TEST RESULTS**

Please refer to the APPENDIX F.

## 7. CONDUCTED SPURIOUS EMISSION

### 7.1 LIMIT

In any 100 kHz bandwidth outside the frequency band in which the spread spectrum or digitally modulated intentional radiator is operating, the radio frequency power that is produced by the intentional radiator shall be at least 20 dB below that in the 100 kHz bandwidth within the band that contains the highest level of the desired power, based on either an RF conducted or a radiated measurement, provided the transmitter demonstrates compliance with the peak Output Power limits. If the transmitter complies with the Output Power limits based on the use of RMS averaging over a time interval, as permitted under paragraph (b)(3) of this section, the attenuation required under this paragraph shall be 30 dB instead of 20 dB. Attenuation below the general limits specified in Section 15.209(a) is not required.

### 7.2 TEST PROCEDURE

- a. The EUT was directly connected to the spectrum analyzer and antenna output port as show in the block diagram below.
- b. Spectrum Setting : RBW= 100 kHz, VBW=300 kHz, Sweep time = 10 ms.

### 7.3 DEVIATION FROM STANDARD

No deviation.

### 7.4 TEST SETUP

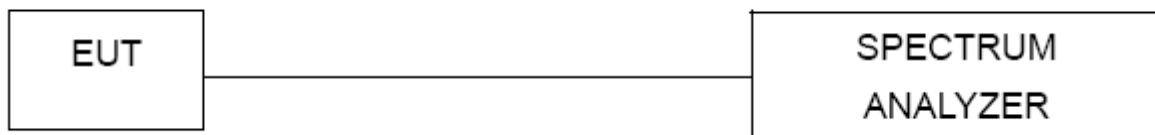

### 7.5 EUT OPERATION CONDITIONS

The EUT tested system was configured as the statements of 3.5 unless otherwise a special operating condition is specified in the follows during the testing.

### 7.6 TEST RESULTS

Please refer to the APPENDIX G.

## 8. POWER SPECTRAL DENSITY TEST

### 8.1 LIMIT

FCC Part15, Subpart C (15.247)		
Section	Test Item	Limit
15.247(e)	Power Spectral Density	8 dBm (in any 3 kHz)

### 8.2 TEST PROCEDURE

- The EUT was directly connected to the spectrum analyzer and antenna output port as show in the block diagram below.
- Spectrum Setting: RBW=3 kHz, VBW=10 kHz, Sweep time = auto.

### 8.3 DEVIATION FROM STANDARD

No deviation.

### 8.4 TEST SETUP



### 8.5 EUT OPERATION CONDITIONS

The EUT tested system was configured as the statements of 3.5 unless otherwise a special operating condition is specified in the follows during the testing.

### 8.6 TEST RESULTS

Please refer to the APPENDIX H.



**9. MEASUREMENT INSTRUMENTS LIST**

AC Power Line Conducted Emissions					
Item	Kind of Equipment	Manufacturer	Type No.	Serial No.	Calibrated until
1	EMI Test Receiver	R&S	ESCI	100382	Feb. 27, 2022
2	LISN	EMCO	3816/2	52765	Feb. 28, 2022
3	TWO-LINE V-NETWORK	R&S	ENV216	101447	Feb. 27, 2022
4	50Ω Terminator	SHX	TF5-3	15041305	Feb. 28, 2022
5	Measurement Software	Farad	EZ-EMC Ver.NB-03A1-01	N/A	N/A
6	Cable	N/A	RG223	12m	Mar. 10, 2021
7	643 Shield Room	ETS	6*4*3m	N/A	N/A

Radiated Emissions - 9 kHz to 30 MHz					
Item	Kind of Equipment	Manufacturer	Type No.	Serial No.	Calibrated until
1	Loop Antenna	EM	EM-6876-1	230	Apr. 16, 2021
2	Cable	N/A	RG 213/U	C-102	May 29, 2021
3	EMI Test Receiver	R&S	ESCI	100895	Feb. 27, 2022
4	Measurement Software	Farad	EZ-EMC Ver.NB-03A1-01	N/A	N/A
5	966 Chambe Room	RM	9*6*6m	N/A	Jul. 25, 2021

Radiated Emissions - 30 MHz to 1 GHz					
Item	Kind of Equipment	Manufacturer	Type No.	Serial No.	Calibrated until
1	Antenna	Schwarzbeck	VULB9160	9160-3232	Mar. 09, 2021
2*	Amplifier*	HP	8447D	2944A09673	Aug. 11, 2021
3	Receiver	Agilent	N9038A	MY52130039	Jul. 25, 2021
4	Cable	emci	LMR-400(30MHz-1 GHz)(8m+5m)	N/A	May 22, 2021
5	Controller	CT	SC100	N/A	N/A
6	Controller	MF	MF-7802	MF780208416	N/A
7	Measurement Software	Farad	EZ-EMC Ver.NB-03A1-01	N/A	N/A
8	966 Chambe Room	RM	9*6*6m	N/A	Jul. 25, 2021

Radiated Emissions - Above 1 GHz					
Item	Kind of Equipment	Manufacturer	Type No.	Serial No.	Calibrated until
1	Double Ridged Guide Antenna	ETS	3115	75789	May 12, 2021
2	Broad-Band Horn Antenna	Schwarzbeck	BBHA 9170	9170319	Jul. 07, 2021
3	Amplifier	Agilent	8449B	3008A02333	Feb. 28, 2022
4	Microwave Preamplifier With Adaptor	EMC INSTRUMENT	EMC2654045	980039 & HA01	Mar. 07, 2021
5	Receiver	Agilent	N9038A	MY52130039	Jul. 25, 2021
6	Controller	CT	SC100	N/A	N/A
7	Controller	MF	MF-7802	MF780208416	N/A
8	Cable	mitron	B10-01-01-12M	18072744	May 09, 2021
9	Measurement Software	Farad	EZ-EMC Ver.NB-03A1-01	N/A	N/A
10	Filter	STI	STI15-9912	N/A	Jul. 25, 2021
11	966 Chambe Room	RM	9*6*6m	N/A	Jul. 25, 2021

**Bandwidth &  
Conducted Output Power &  
Power Spectral Density &  
Conducted Spurious Emission**

Item	Kind of Equipment	Manufacturer	Type No.	Serial No.	Calibrated until
1	Spectrum Analyzer	R&S	FSP40	100185	Jul. 25, 2021
2	Attenuator	WOKEN	6SM3502	VAS1214NL	Feb. 07, 2022
3	DC Block	Mini	N/A	N/A	N/A
4	RF Cable	Tongkaichuan	N/A	N/A	N/A

Remark: "N/A" denotes no model name, serial no. or calibration specified.

"\*\*" calibration period of equipment list is three year.

Except \* item, all calibration period of equipment list is one year.

**APPENDIX A - AC POWER LINE CONDUCTED EMISSIONS**

Test Mode: TX Mode Channel 19 \_2Mbps

Line

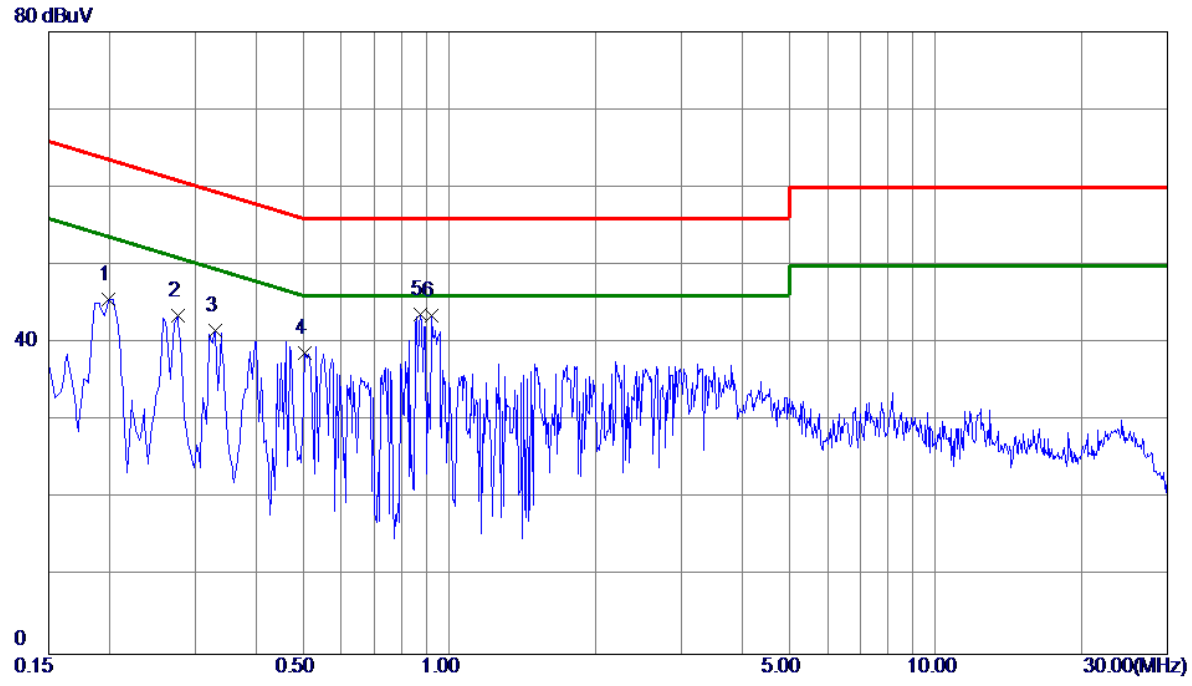

No.	Freq. MHz	Reading Level dBuV	Correct Factor dB	Measure ment dBuV	Limit dBuV	Margin dB	Detector	Comment
1	0.1995	35.66	9.91	45.57	63.63	-18.06	Peak	
2	0.2760	33.64	9.88	43.52	60.94	-17.42	Peak	
3	0.3300	31.76	9.90	41.66	59.45	-17.79	Peak	
4	0.5055	28.73	9.95	38.68	56.00	-17.32	Peak	
5 *	0.8745	33.68	9.99	43.67	56.00	-12.33	Peak	
6	0.9195	33.55	10.00	43.55	56.00	-12.45	Peak	

REMARKS:  
 (1) Measurement Value = Reading Level + Correct Factor.  
 (2) Margin Level = Measurement Value - Limit Value.

Test Mode: TX Mode Channel 19 \_2Mbps

**Neutral**

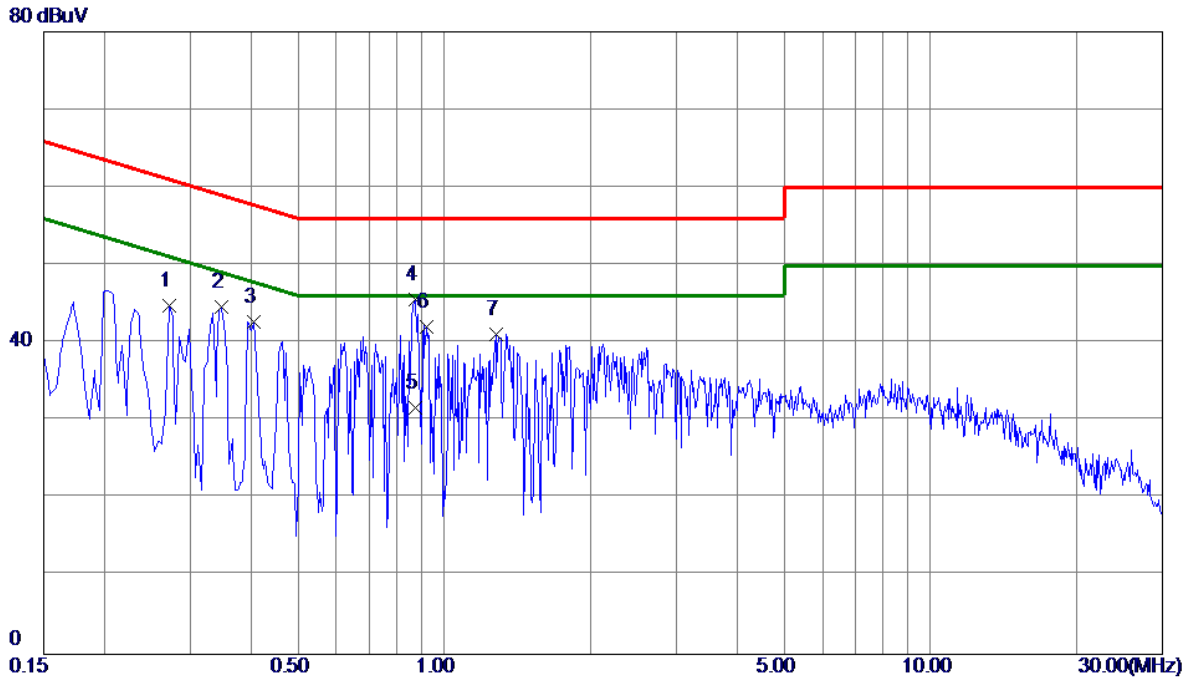

No.	Freq. MHz	Reading Level dBuV	Correct Factor dB	Measure ment dBuV	Limit dBuV	Margin dB	Detector	Comment
1	0.2714	34.76	9.99	44.75	61.07	-16.32	Peak	
2	0.3480	34.58	10.05	44.63	59.01	-14.38	Peak	
3	0.4065	32.70	10.09	42.79	57.72	-14.93	Peak	
4 *	0.8745	35.37	10.26	45.63	56.00	-10.37	Peak	
5	0.8745	21.40	10.26	31.66	46.00	-14.34	AVG	
6	0.9195	31.76	10.28	42.04	56.00	-13.96	Peak	
7	1.2750	30.82	10.33	41.15	56.00	-14.85	Peak	

**REMARKS:**

- (1) Measurement Value = Reading Level + Correct Factor.
- (2) Margin Level = Measurement Value - Limit Value.

**APPENDIX B - RADIATED EMISSION - 9 KHZ TO 30 MHZ**

Test Mode: TX Mode Channel 19\_2Mbps

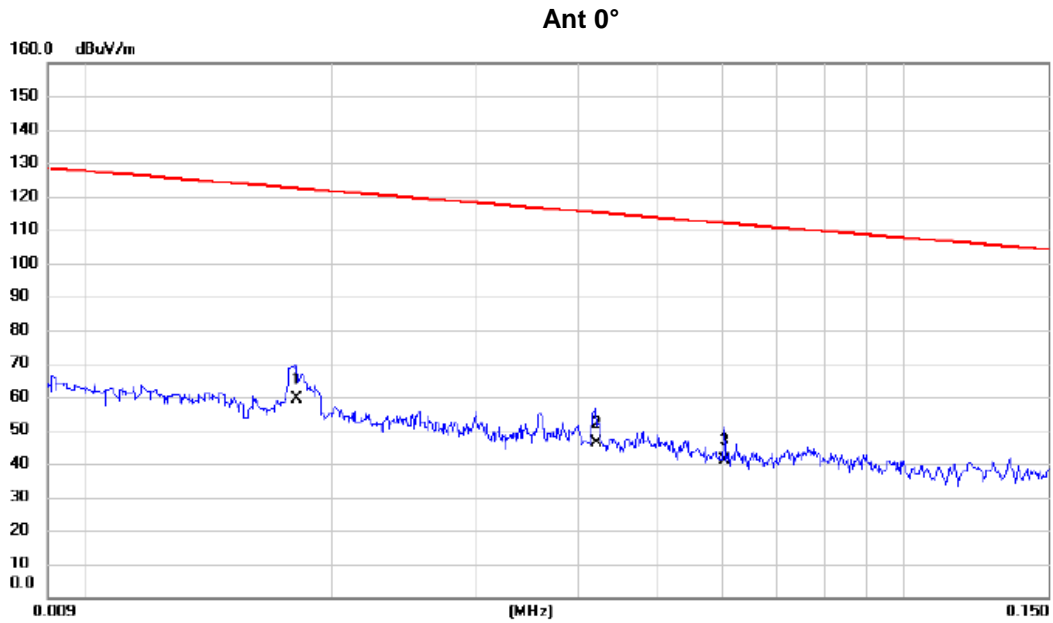

No.	Mk.	Freq. MHz	Reading Level dBuV	Correct Factor dB	Measure- ment dBuV/m	Limit dBuV/m	Margin dB	Detector	Comment
1	*	0.018	45.61	13.81	59.42	122.45	-63.03	AVG	
2		0.042	33.67	12.63	46.30	115.12	-68.82	AVG	
3		0.060	28.54	12.48	41.02	112.00	-70.98	AVG	

**REMARKS:**

- (1) Measurement Value = Reading Level + Correct Factor.
- (2) Margin Level = Measurement Value - Limit Value.

Test Mode: TX Mode Channel 19\_2Mbps

Ant 0°

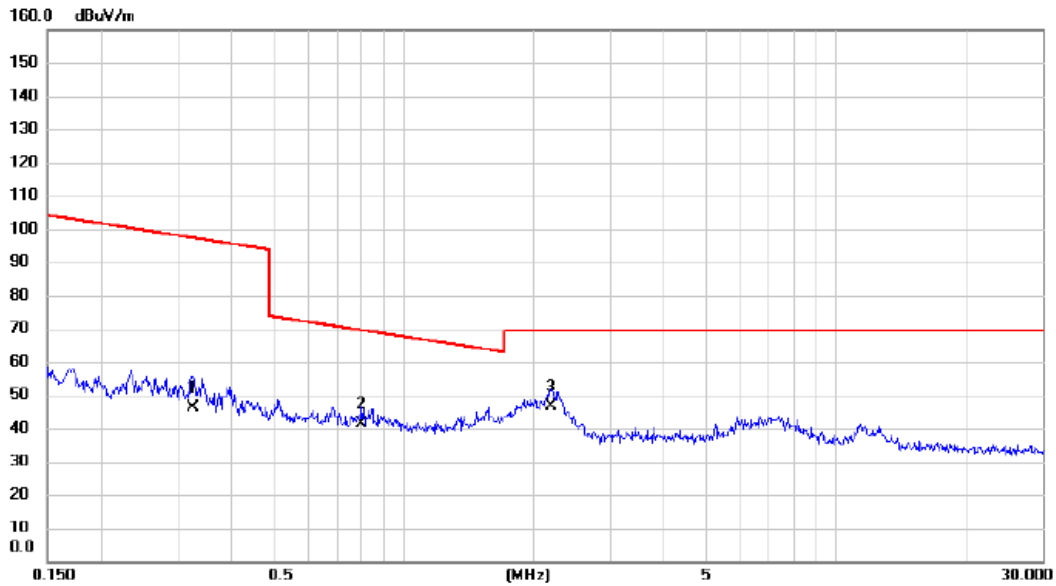

No.	Mk.	Freq. MHz	Reading Level dBuV	Correct Factor dB	Measure- ment dBuV/m	Limit dBuV/m	Margin dB	Detector	Comment
1		0.325	33.67	12.45	46.12	97.36	-51.24	AVG	
2		0.800	29.37	11.88	41.25	69.54	-28.29	QP	
3	*	2.190	35.47	11.21	46.68	69.54	-22.86	QP	

REMARKS:

- (1) Measurement Value = Reading Level + Correct Factor.
- (2) Margin Level = Measurement Value - Limit Value.



Test Mode: TX Mode Channel 19\_2Mbps

Ant 90°

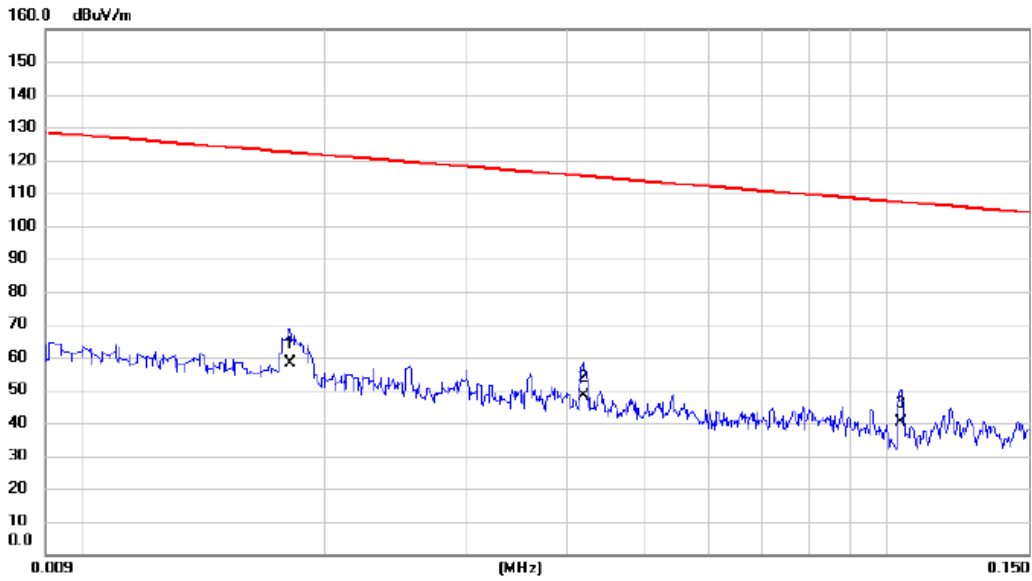

No. Mk.	Freq. MHz	Reading Level dBuV	Correct Factor dB	Measure- ment dBuV/m	Limit dBuV/m	Margin dB	Detector	Comment
1 *	0.018	44.32	13.81	58.13	122.45	-64.32	AVG	
2	0.042	35.69	12.63	48.32	115.14	-66.82	AVG	
3	0.104	27.49	12.72	40.21	107.26	-67.05	AVG	

**REMARKS:**

(1) Measurement Value = Reading Level + Correct Factor.

(2) Margin Level = Measurement Value - Limit Value.

Test Mode: TX Mode Channel 19\_2Mbps

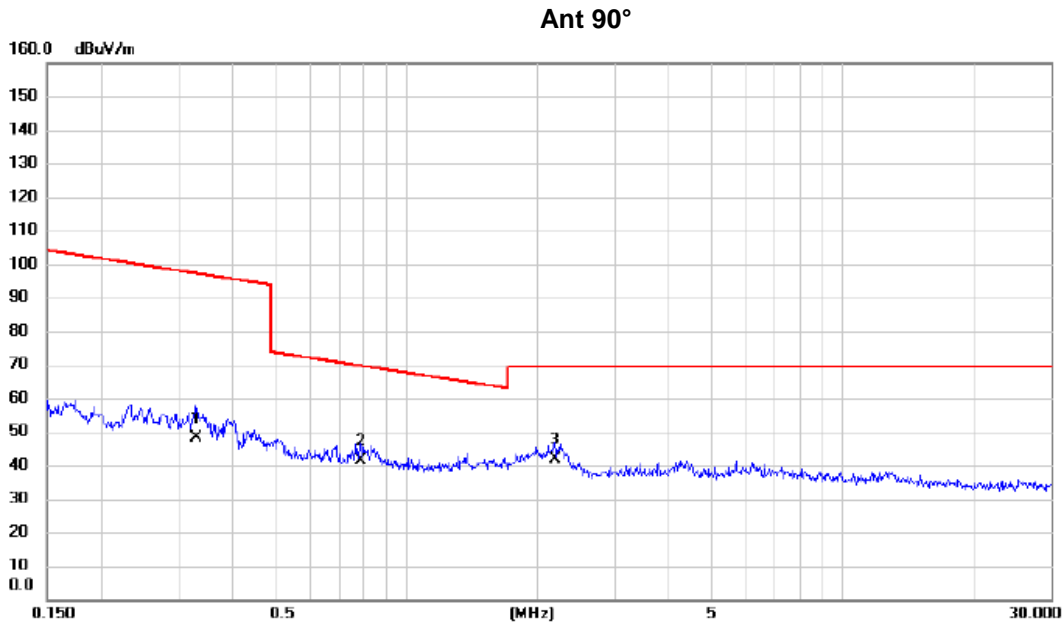

No.	Mk.	Freq. MHz	Reading Level dBuV	Correct Factor dB	Measure- ment dBuV/m	Limit dBuV/m	Margin dB	Detector	Comment
1		0.329	35.64	12.44	48.08	97.27	-49.19	AVG	
2		0.783	29.55	11.89	41.44	69.72	-28.28	QP	
3	*	2.190	30.74	11.21	41.95	69.54	-27.59	QP	

**REMARKS:**

- (1) Measurement Value = Reading Level + Correct Factor.
- (2) Margin Level = Measurement Value - Limit Value.

**APPENDIX C - RADIATED EMISSION - 30 MHZ TO 1000 MHZ**

Test Mode: TX Mode Channel 19\_2Mbps

**Vertical**

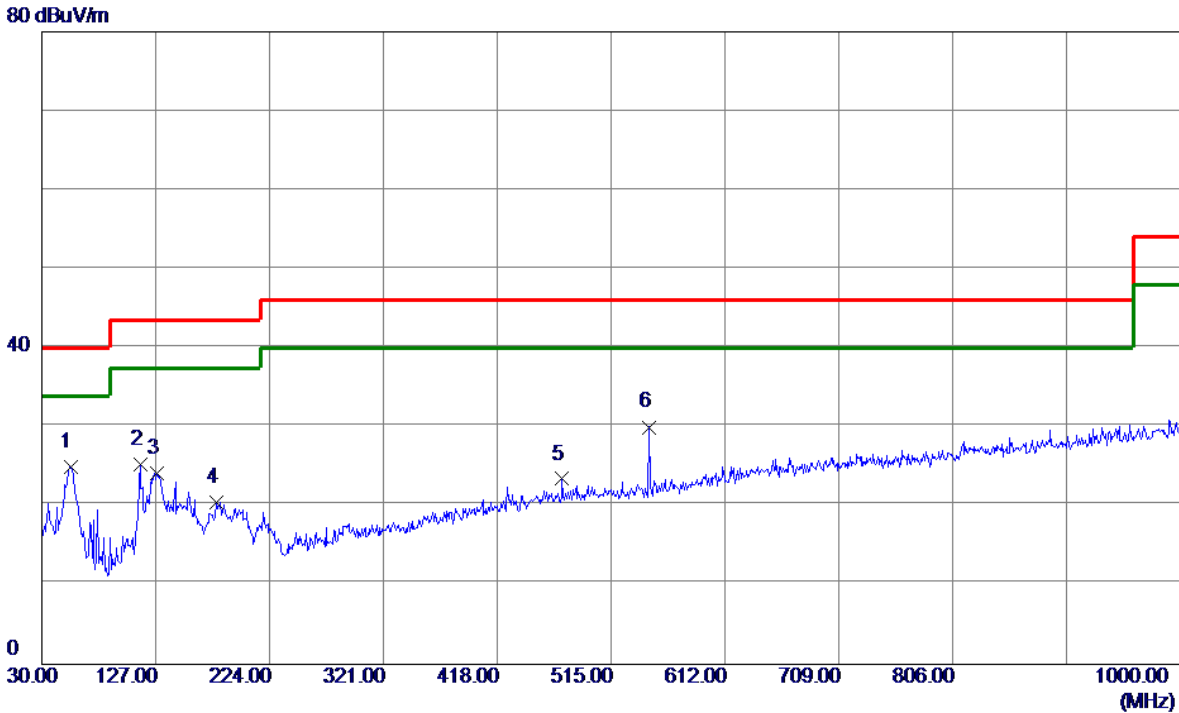

No.	Freq. MHz	Reading Level dBuV/m	Correct Factor dB	Measure ment dBuV/m	Limit dBuV/m	Margin dB	Detector	Comment
1 *	54.2500	38.62	-13.60	25.02	40.00	-14.98	Peak	
2	113.9050	38.86	-13.65	25.21	43.50	-18.29	Peak	
3	128.4550	36.97	-12.74	24.23	43.50	-19.27	Peak	
4	178.8950	33.21	-12.71	20.50	43.50	-23.00	Peak	
5	473.2900	30.90	-7.46	23.44	46.00	-22.56	Peak	
6	547.4950	36.83	-6.83	30.00	46.00	-16.00	Peak	

**REMARKS:**

- (1) Measurement Value = Reading Level + Correct Factor.
- (2) Margin Level = Measurement Value - Limit Value.

Test Mode: TX Mode Channel 19\_2Mbps

### Horizontal

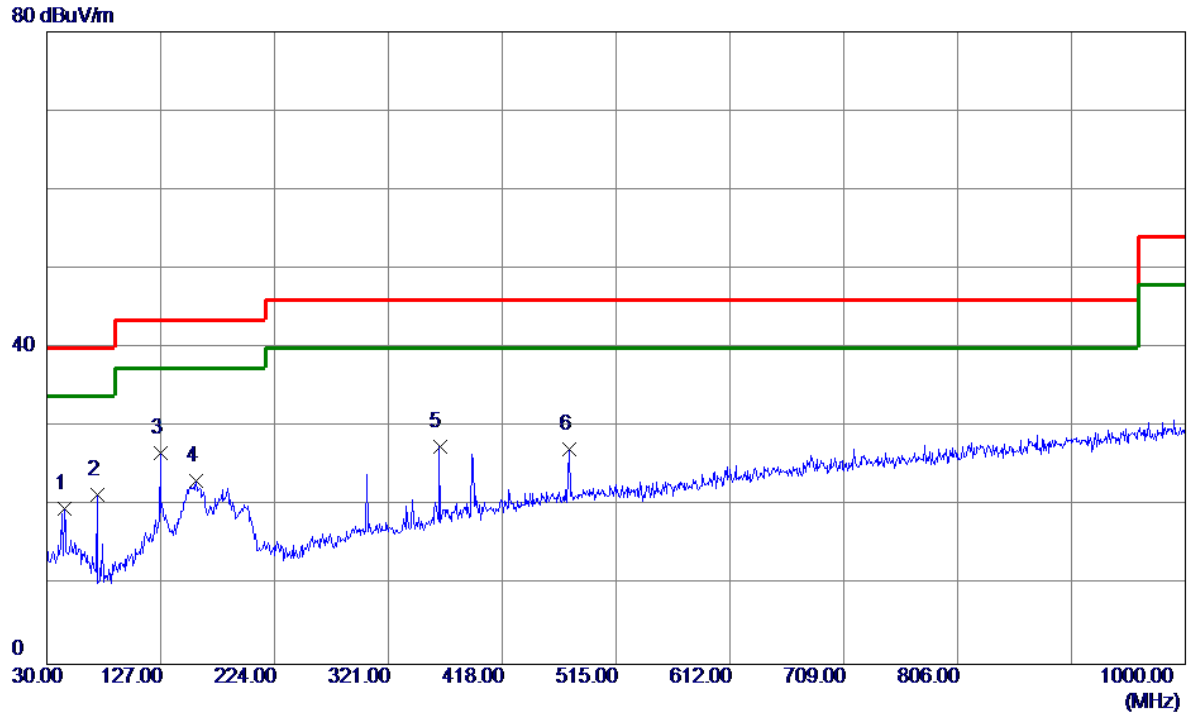

No.	Freq. MHz	Reading Level dBuV/m	Correct Factor dB	Measure ment dBuV/m	Limit dBuV/m	Margin dB	Detector	Comment
1	45.0350	33.87	-14.13	19.74	40.00	-20.26	Peak	
2	72.6800	37.82	-16.41	21.41	40.00	-18.59	Peak	
3 *	126.5150	39.42	-12.74	26.68	43.50	-16.82	Peak	
4	157.0700	34.20	-11.05	23.15	43.50	-20.35	Peak	
5	364.6500	37.40	-9.85	27.55	46.00	-18.45	Peak	
6	474.7450	34.63	-7.45	27.18	46.00	-18.82	Peak	

REMARKS:  
 (1) Measurement Value = Reading Level + Correct Factor.  
 (2) Margin Level = Measurement Value - Limit Value.

**APPENDIX D - RADIATED EMISSION - ABOVE 1000 MHZ**

Test Mode : TX 2402 MHz \_CH00\_1Mbps

**Vertical**

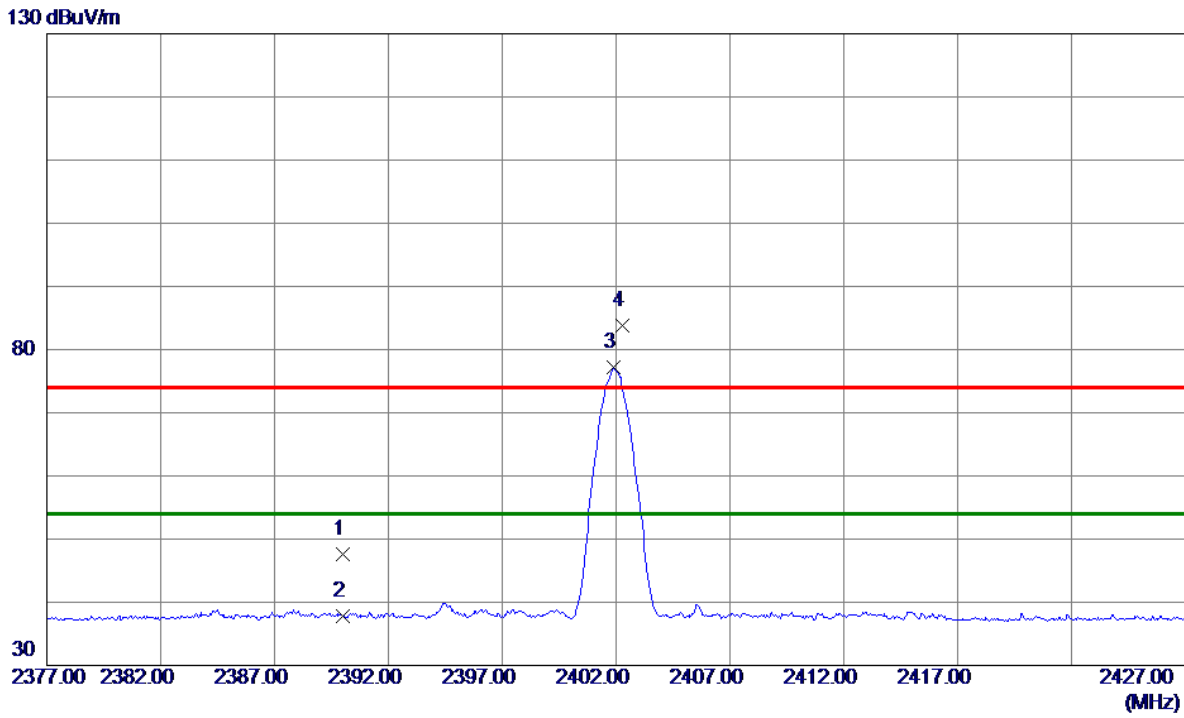

No.	Freq. MHz	Reading Level dBuV/m	Correct Factor dB	Measurement dBuV/m	Limit dBuV/m	Margin dB	Detector	Comment
1	2390.0000	40.33	7.26	47.59	74.00	-26.41	Peak	
2	2390.0000	30.47	7.26	37.73	54.00	-16.27	AVG	
3 *	2401.9000	69.92	7.26	77.18	54.00	23.18	AVG	No Limit
4	2402.3000	76.46	7.26	83.72	74.00	9.72	Peak	No Limit

REMARKS:  
 (1) Measurement Value = Reading Level + Correct Factor.  
 (2) Margin Level = Measurement Value - Limit Value.

Test Mode : TX 2402 MHz \_CH00\_1Mbps

**Vertical**

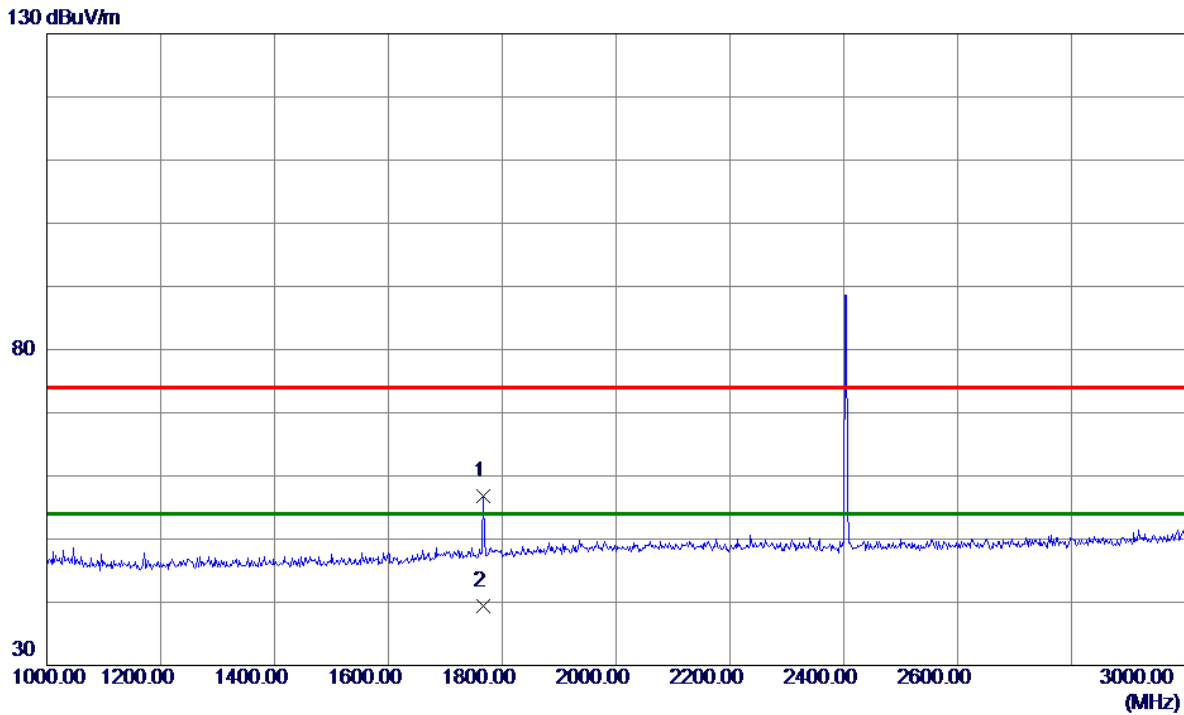

No.	Freq. MHz	Reading Level dBuV/m	Correct Factor dB	Measure ment dBuV/m	Limit dBuV/m	Margin dB	Detector	Comment
1	1767.5350	51.14	5.66	56.80	74.00	-17.20	Peak	
2 *	1767.5350	33.71	5.66	39.37	54.00	-14.63	AVG	

**REMARKS:**

- (1) Measurement Value = Reading Level + Correct Factor.
- (2) Margin Level = Measurement Value - Limit Value.



Test Mode : TX 2402 MHz \_CH00\_1Mbps

**Vertical**

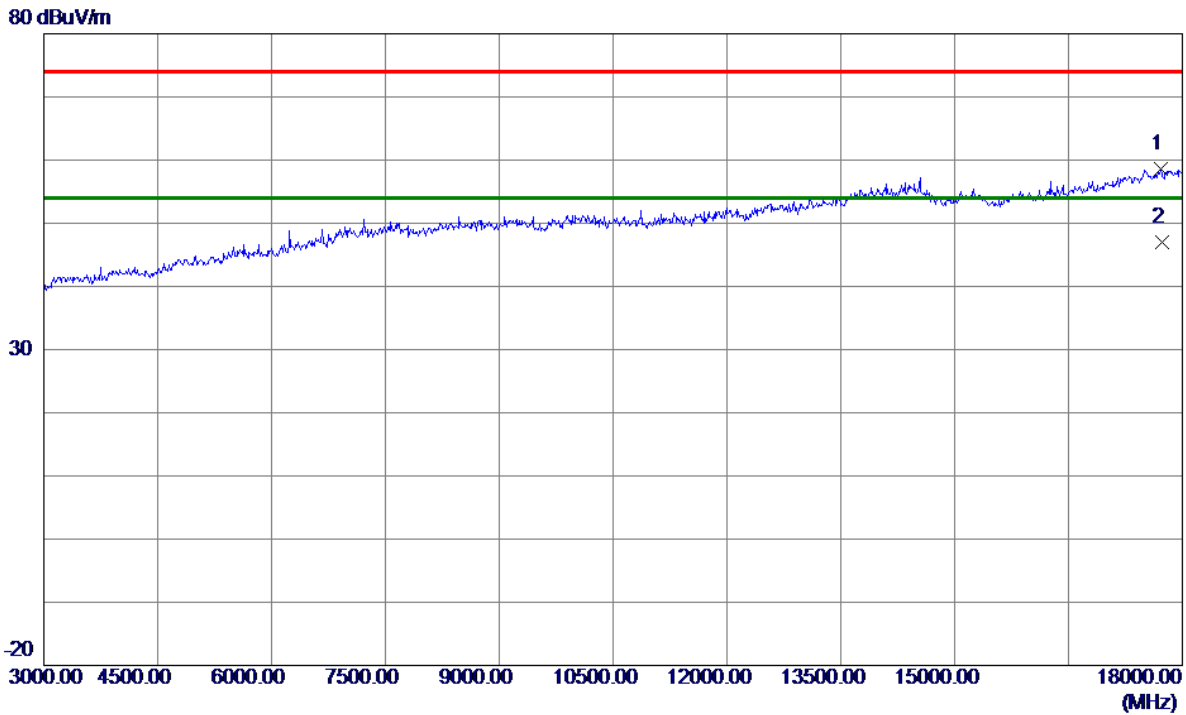

No.	Freq. MHz	Reading Level dBuV/m	Correct Factor dB	Measure ment dBuV/m	Limit dBuV/m	Margin dB	Detector	Comment
1	17722.5000	37.97	20.62	58.59	74.00	-15.41	Peak	
2 *	17735.3030	26.41	20.62	47.03	54.00	-6.97	AVG	

**REMARKS:**

- (1) Measurement Value = Reading Level + Correct Factor.
- (2) Margin Level = Measurement Value - Limit Value.

Test Mode : TX 2402 MHz \_CH00\_1Mbps

**Vertical**

130 dBuV/m

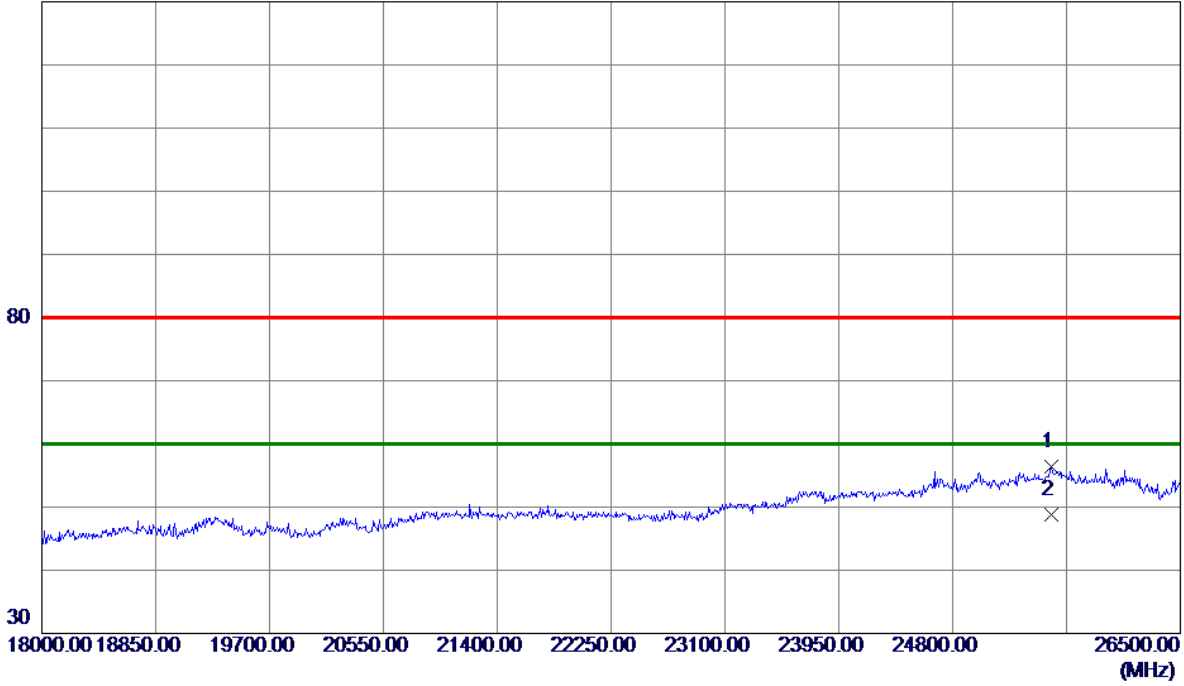

No.	Freq. MHz	Reading Level dBuV/m	Correct Factor dB	Measure ment dBuV/m	Limit dBuV/m	Margin dB	Detector	Comment
1	25539.5000	26.35	30.10	56.45	80.00	-23.55	Peak	
2 *	25539.5000	18.66	30.10	48.76	60.00	-11.24	AVG	

**REMARKS:**

- (1) Measurement Value = Reading Level + Correct Factor.
- (2) Margin Level = Measurement Value - Limit Value.

Test Mode : TX 2402 MHz \_CH00\_1Mbps

### Horizontal

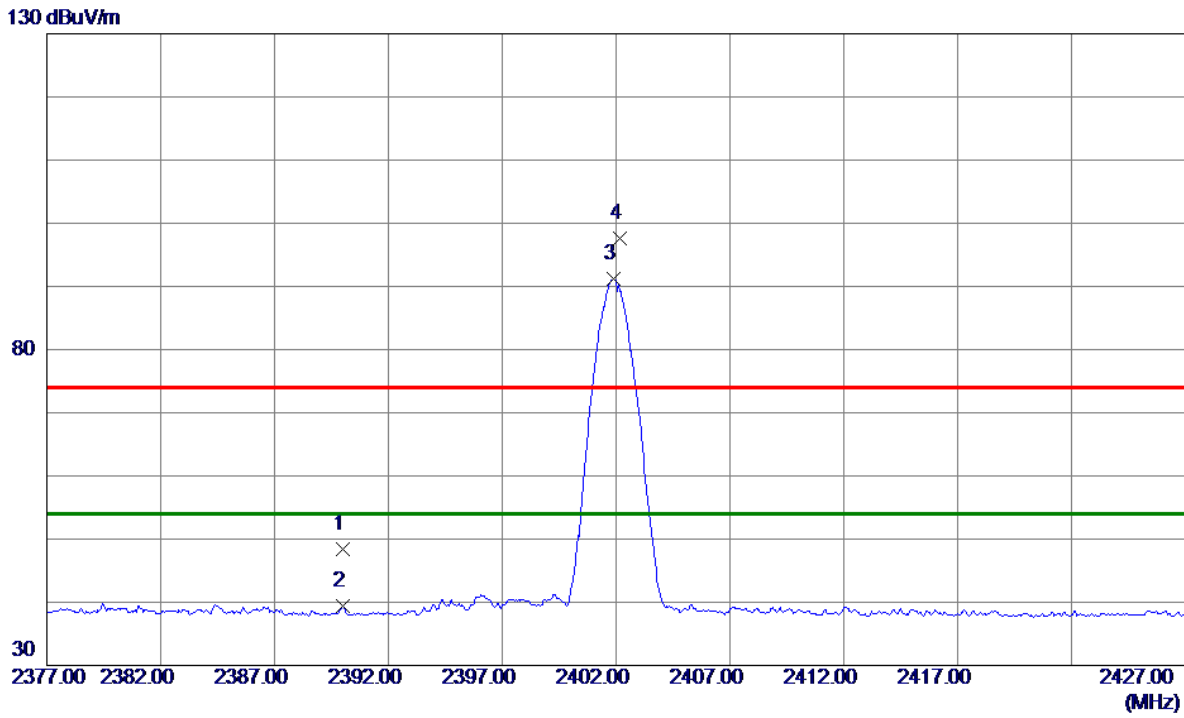

No.	Freq. MHz	Reading Level dBuV/m	Correct Factor dB	Measure ment dBuV/m	Limit dBuV/m	Margin dB	Detector	Comment
1	2390.0000	41.06	7.26	48.32	74.00	-25.68	Peak	
2	2390.0000	32.05	7.26	39.31	54.00	-14.69	AVG	
3 *	2401.9000	83.88	7.26	91.14	54.00	37.14	AVG	No Limit
4	2402.1500	90.37	7.26	97.63	74.00	23.63	Peak	No Limit

**REMARKS:**

- (1) Measurement Value = Reading Level + Correct Factor.
- (2) Margin Level = Measurement Value - Limit Value.

Test Mode : TX 2402 MHz \_CH00\_1Mbps

### Horizontal

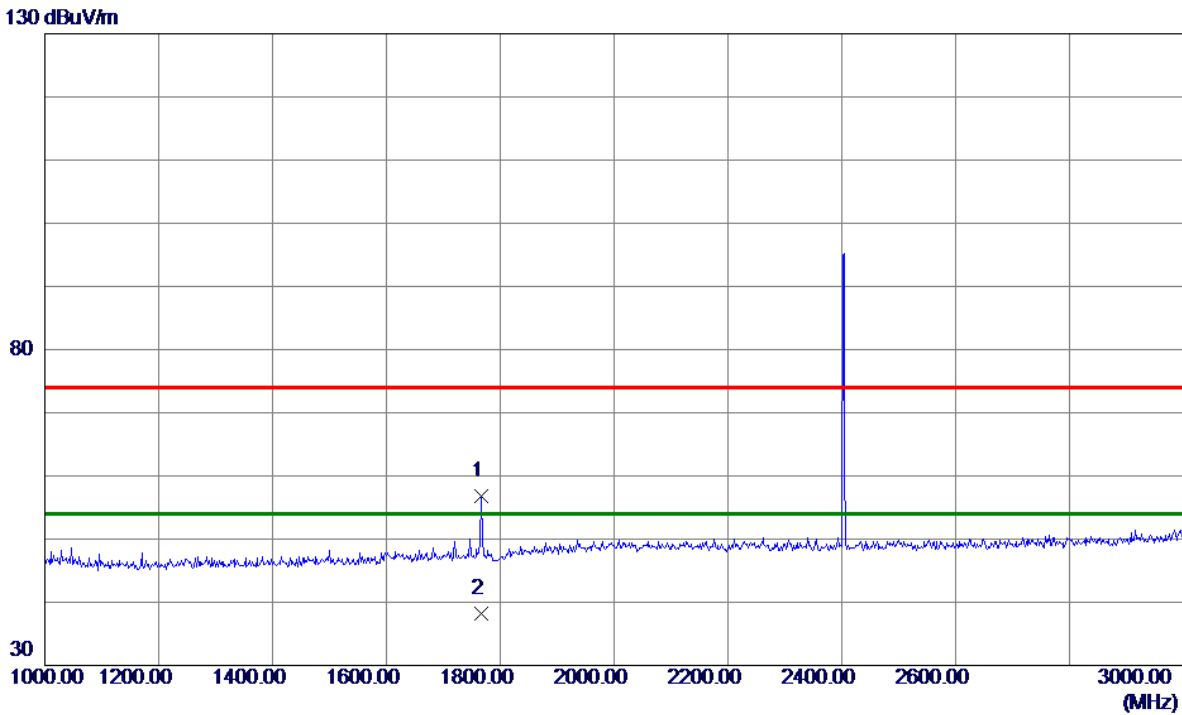

No.	Freq. MHz	Reading Level dBuV/m	Correct Factor dB	Measure ment dBuV/m	Limit dBuV/m	Margin dB	Detector	Comment
1	1766.7670	51.13	5.65	56.78	74.00	-17.22	Peak	
2 *	1766.7670	32.59	5.65	38.24	54.00	-15.76	AVG	

**REMARKS:**

- (1) Measurement Value = Reading Level + Correct Factor.
- (2) Margin Level = Measurement Value - Limit Value.

Test Mode : TX 2402 MHz \_CH00\_1Mbps

### Horizontal

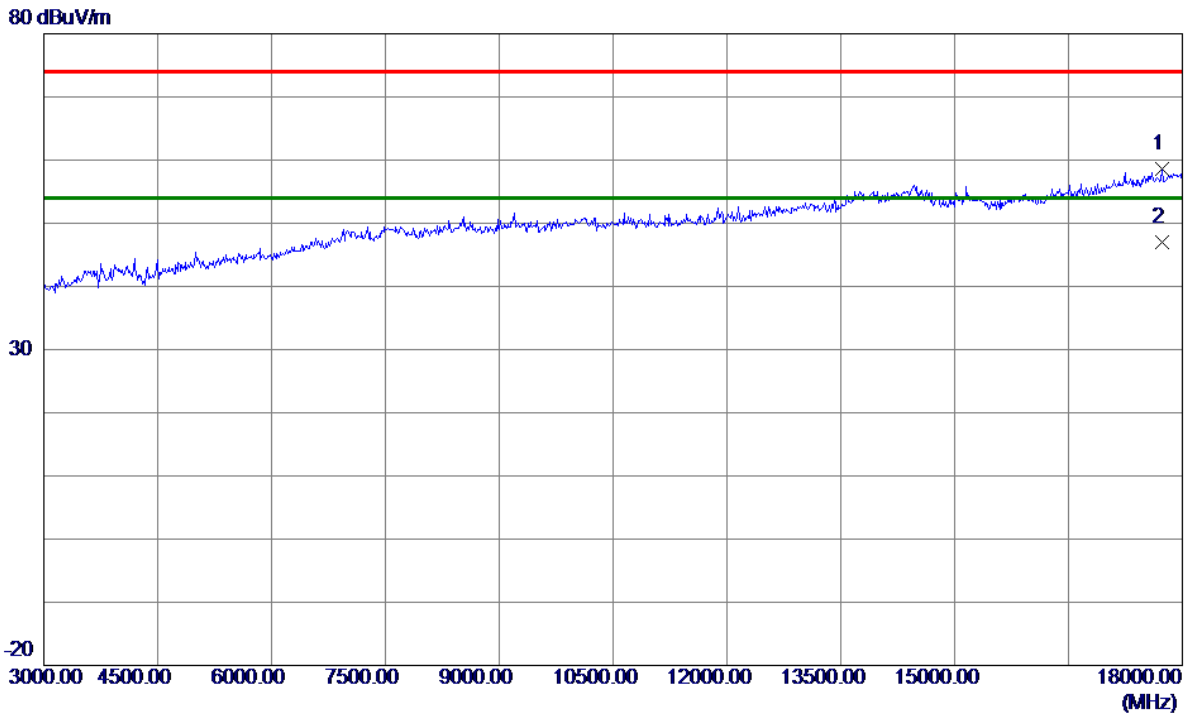

No.	Freq. MHz	Reading Level dBuV/m	Correct Factor dB	Measure ment dBuV/m	Limit dBuV/m	Margin dB	Detector	Comment
1	17730.0000	37.94	20.62	58.56	74.00	-15.44	Peak	
2 *	17731.8420	26.36	20.62	46.98	54.00	-7.02	AVG	

**REMARKS:**

- (1) Measurement Value = Reading Level + Correct Factor.
- (2) Margin Level = Measurement Value - Limit Value.

Test Mode : TX 2402 MHz \_CH00\_1Mbps

### Horizontal

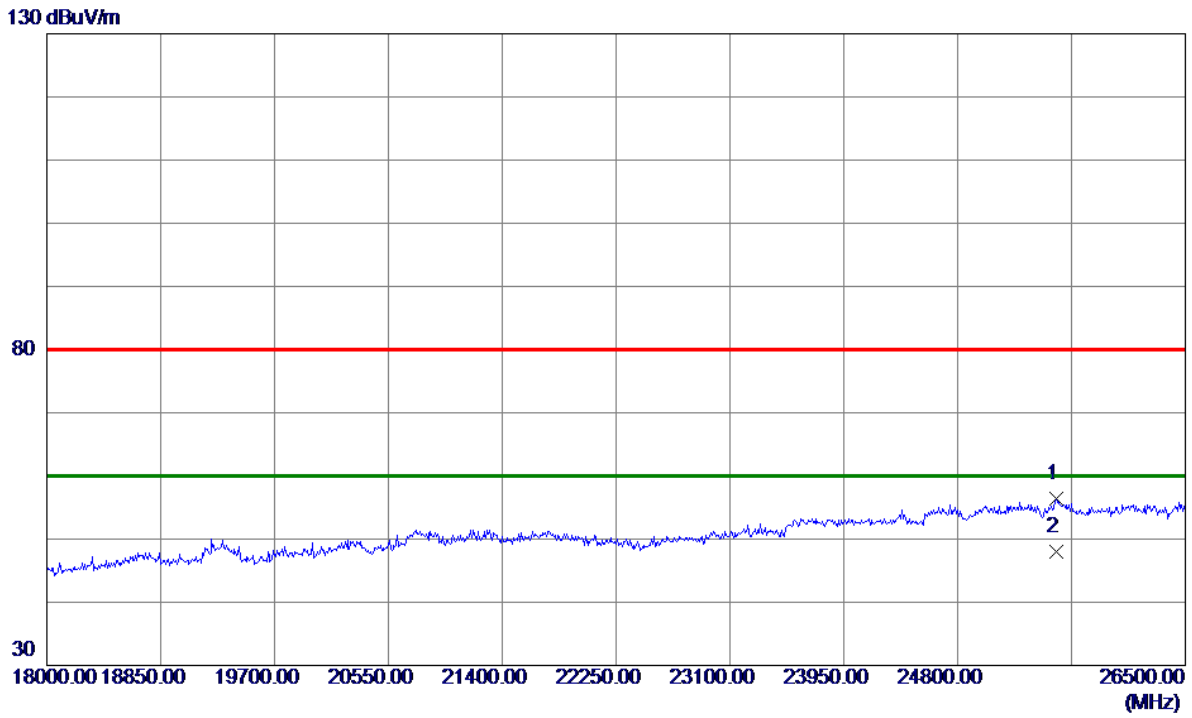

No.	Freq. MHz	Reading Level dBuV/m	Correct Factor dB	Measure ment dBuV/m	Limit dBuV/m	Margin dB	Detector	Comment
1	25539.5000	26.38	30.10	56.48	80.00	-23.52	Peak	
2 *	25539.5000	17.99	30.10	48.09	60.00	-11.91	AVG	

**REMARKS:**

- (1) Measurement Value = Reading Level + Correct Factor.
- (2) Margin Level = Measurement Value - Limit Value.

Test Mode : TX 2440 MHz \_CH19\_1Mbps

**Vertical**

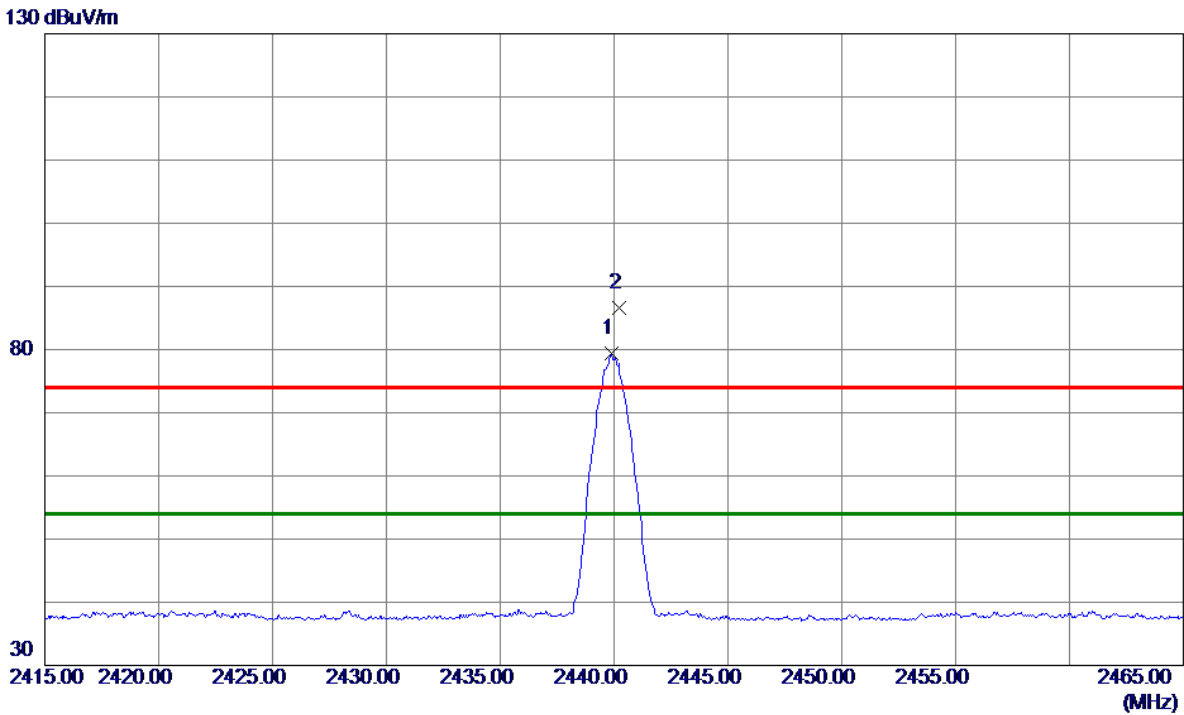

No.	Freq. MHz	Reading Level dBuV/m	Correct Factor dB	Measure ment dBuV/m	Limit dBuV/m	Margin dB	Detector	Comment
1 *	2439.9000	72.19	7.25	79.44	54.00	25.44	AVG	No Limit
2	2440.2000	79.44	7.25	86.69	74.00	12.69	Peak	No Limit

**REMARKS:**

- (1) Measurement Value = Reading Level + Correct Factor.
- (2) Margin Level = Measurement Value - Limit Value.

Test Mode : TX 2440 MHz \_CH19\_1Mbps

**Vertical**

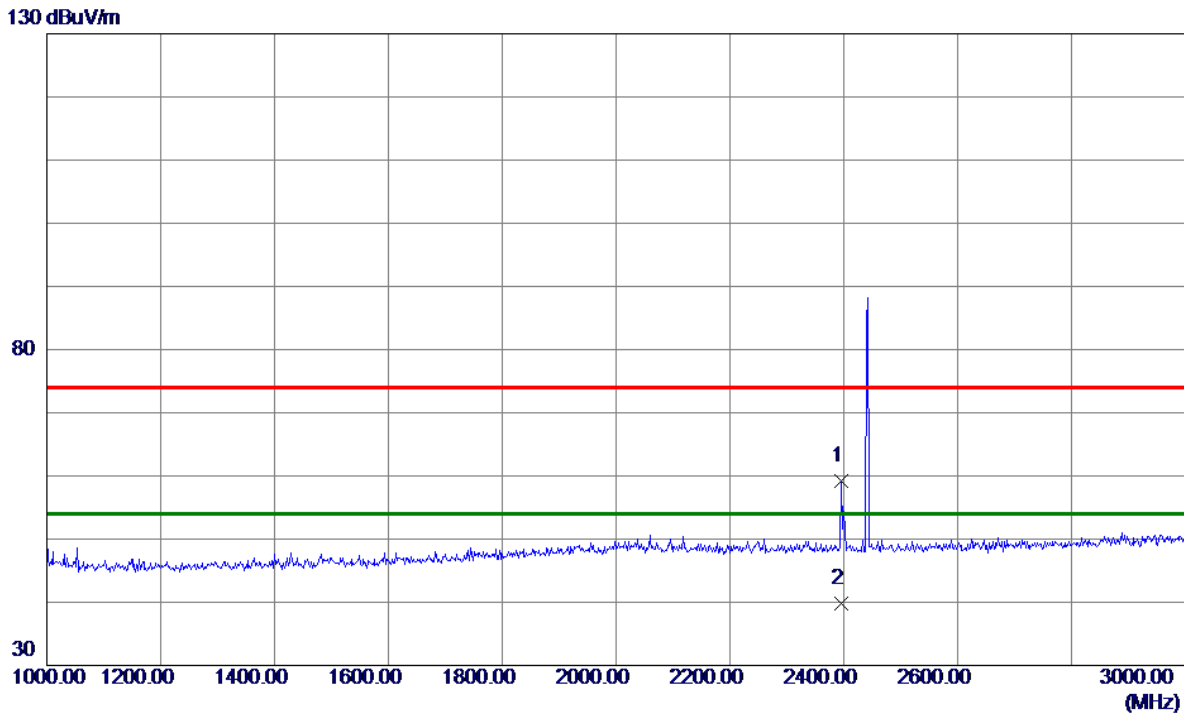

No.	Freq. MHz	Reading Level dBuV/m	Correct Factor dB	Measure ment dBuV/m	Limit dBuV/m	Margin dB	Detector	Comment
1	2395.3950	52.01	7.26	59.27	74.00	-14.73	Peak	
2 *	2395.3950	32.57	7.26	39.83	54.00	-14.17	AVG	

**REMARKS:**

- (1) Measurement Value = Reading Level + Correct Factor.
- (2) Margin Level = Measurement Value - Limit Value.



Test Mode : TX 2440 MHz \_CH19\_1Mbps

**Vertical**

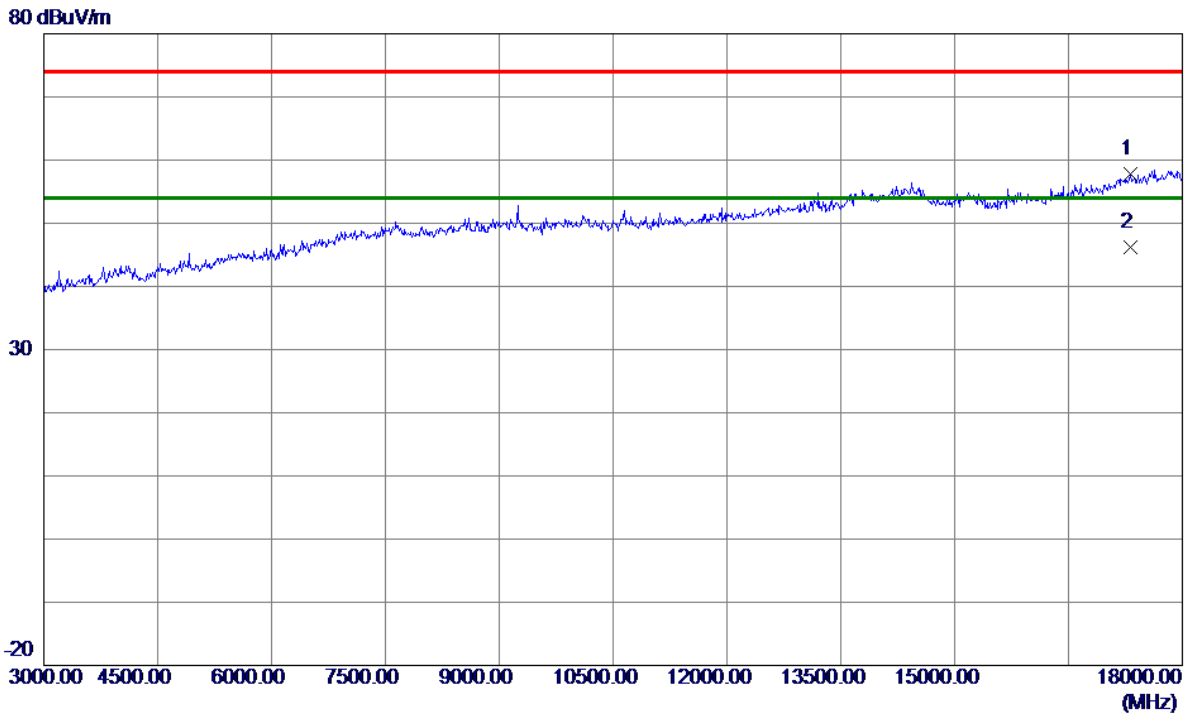

No.	Freq. MHz	Reading Level dBuV/m	Correct Factor dB	Measure ment dBuV/m	Limit dBuV/m	Margin dB	Detector	Comment
1	17317.5000	37.83	19.90	57.73	74.00	-16.27	Peak	
2 *	17318.4200	26.25	19.90	46.15	54.00	-7.85	AVG	

**REMARKS:**

- (1) Measurement Value = Reading Level + Correct Factor.
- (2) Margin Level = Measurement Value - Limit Value.

Test Mode : TX 2440 MHz \_CH19\_1Mbps

**Vertical**

130 dBuV/m

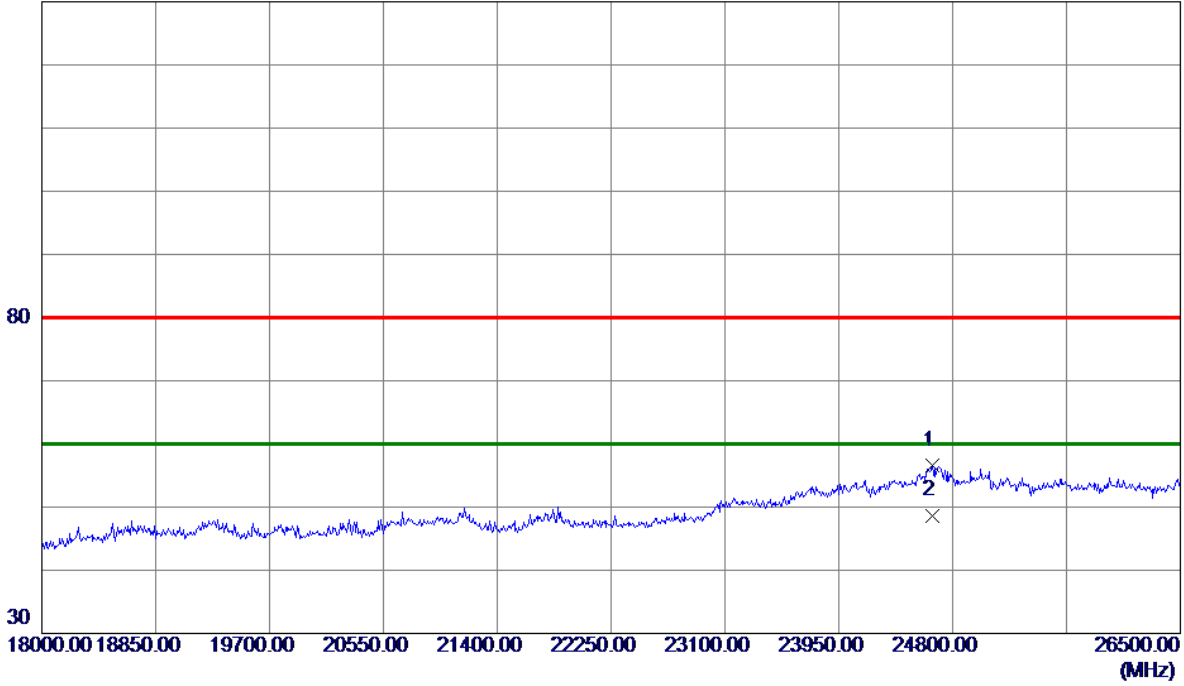

No.	Freq. MHz	Reading Level dBuV/m	Correct Factor dB	Measure ment dBuV/m	Limit dBuV/m	Margin dB	Detector	Comment
1	24647.0000	26.64	30.05	56.69	80.00	-23.31	Peak	
2 *	24647.0000	18.65	30.05	48.70	60.00	-11.30	AVG	

REMARKS:

- (1) Measurement Value = Reading Level + Correct Factor.
- (2) Margin Level = Measurement Value - Limit Value.

Test Mode : TX 2440 MHz \_CH19\_1Mbps

### Horizontal

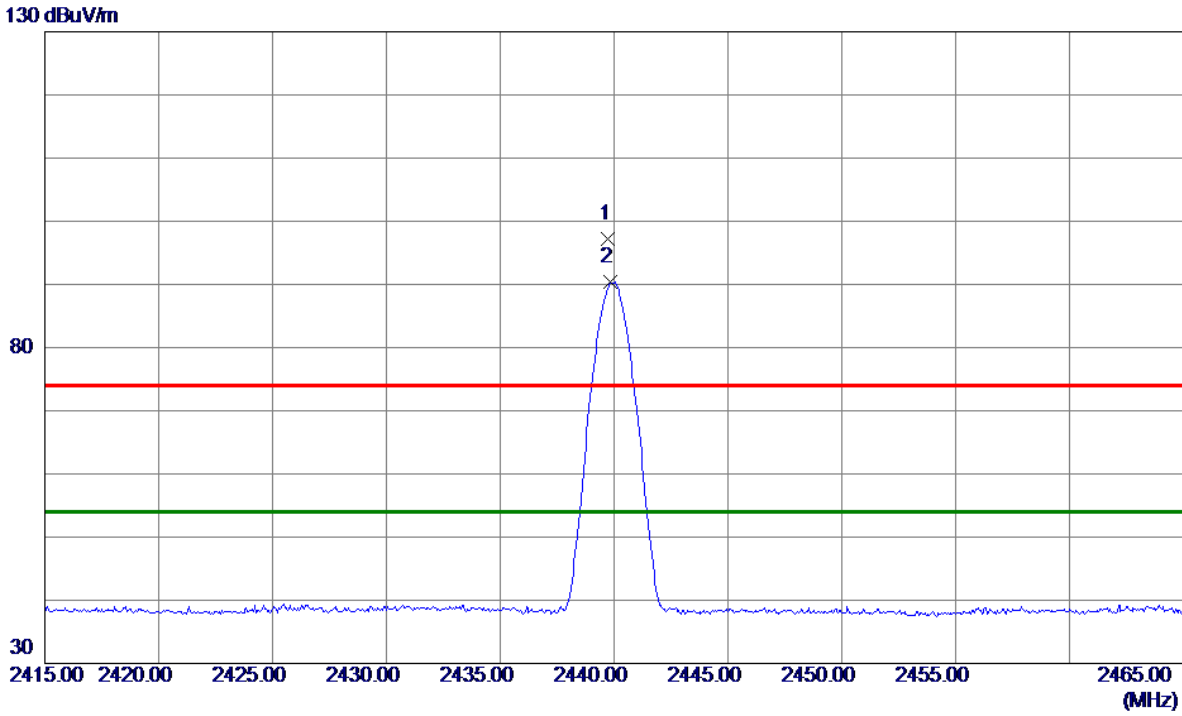

No.	Freq. MHz	Reading Level dBuV/m	Correct Factor dB	Measure ment dBuV/m	Limit dBuV/m	Margin dB	Detector	Comment
1	2439.7500	89.99	7.25	97.24	74.00	23.24	Peak	No Limit
2 *	2439.8500	83.20	7.25	90.45	54.00	36.45	AVG	No Limit

**REMARKS:**

- (1) Measurement Value = Reading Level + Correct Factor.
- (2) Margin Level = Measurement Value - Limit Value.

Test Mode : TX 2440 MHz \_CH19\_1Mbps

### Horizontal

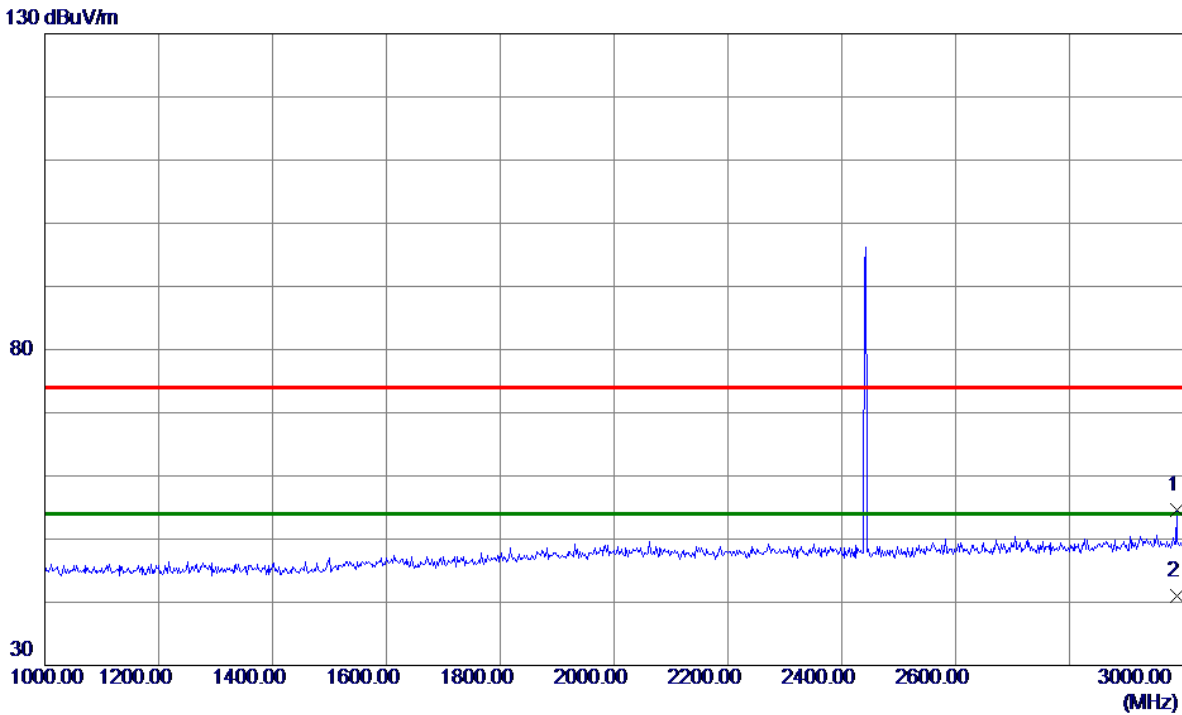

No.	Freq. MHz	Reading Level dBuV/m	Correct Factor dB	Measure ment dBuV/m	Limit dBuV/m	Margin dB	Detector	Comment
1	2987.9880	45.54	9.12	54.66	74.00	-19.34	Peak	
2 *	2987.9880	31.84	9.12	40.96	54.00	-13.04	AVG	

**REMARKS:**

- (1) Measurement Value = Reading Level + Correct Factor.
- (2) Margin Level = Measurement Value - Limit Value.

Test Mode : TX 2440 MHz \_CH19\_1Mbps

### Horizontal

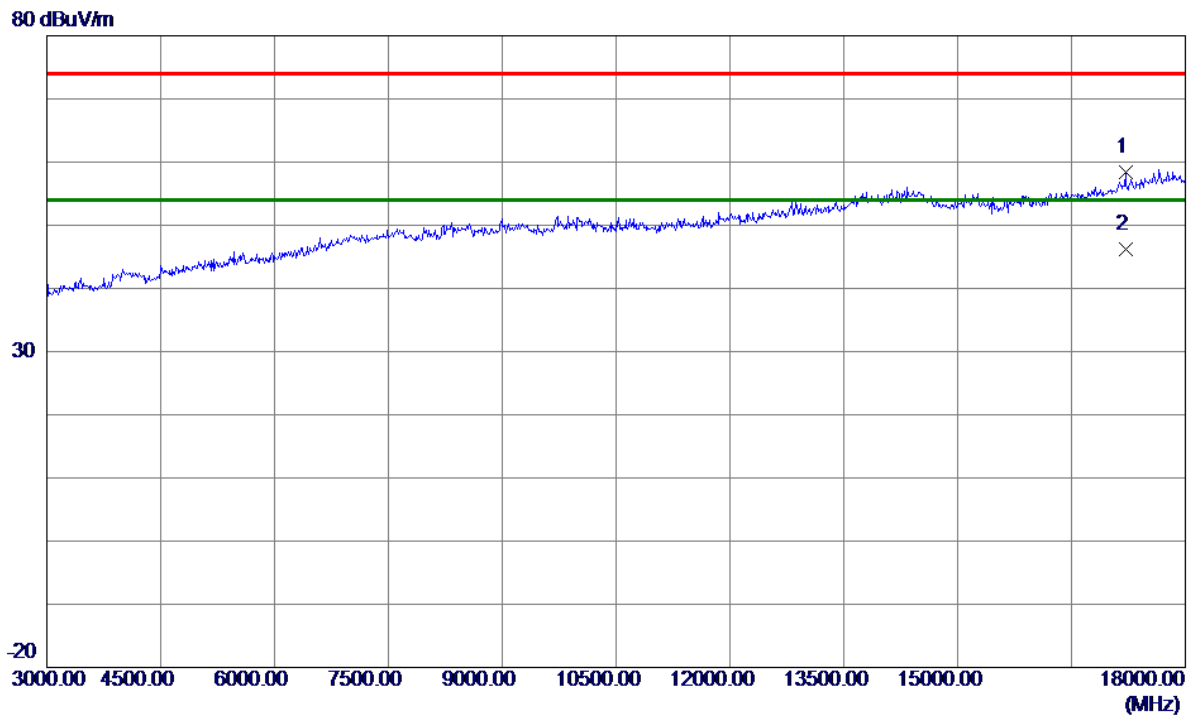

No.	Freq. MHz	Reading Level dBuV/m	Correct Factor dB	Measure ment dBuV/m	Limit dBuV/m	Margin dB	Detector	Comment
1	17212.5000	38.95	19.49	58.44	74.00	-15.56	Peak	
2 *	17213.3350	26.70	19.49	46.19	54.00	-7.81	AVG	

REMARKS:

- (1) Measurement Value = Reading Level + Correct Factor.
- (2) Margin Level = Measurement Value - Limit Value.

Test Mode : TX 2440 MHz \_CH19\_1Mbps

### Horizontal

130 dBuV/m

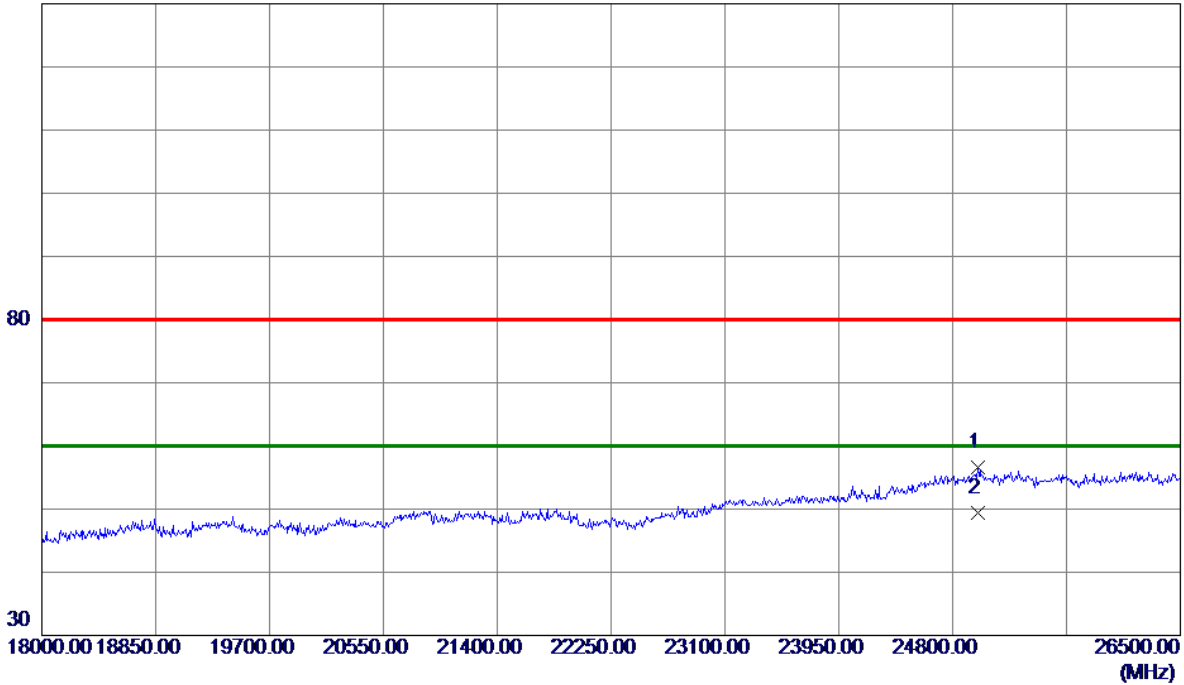

No.	Freq. MHz	Reading Level dBuV/m	Correct Factor dB	Measure ment dBuV/m	Limit dBuV/m	Margin dB	Detector	Comment
1	24987.0000	26.08	30.51	56.59	80.00	-23.41	Peak	
2 *	24987.0000	18.95	30.51	49.46	60.00	-10.54	AVG	

REMARKS:

- (1) Measurement Value = Reading Level + Correct Factor.
- (2) Margin Level = Measurement Value - Limit Value.

Test Mode : TX 2480 MHz \_CH39\_1Mbps

**Vertical**

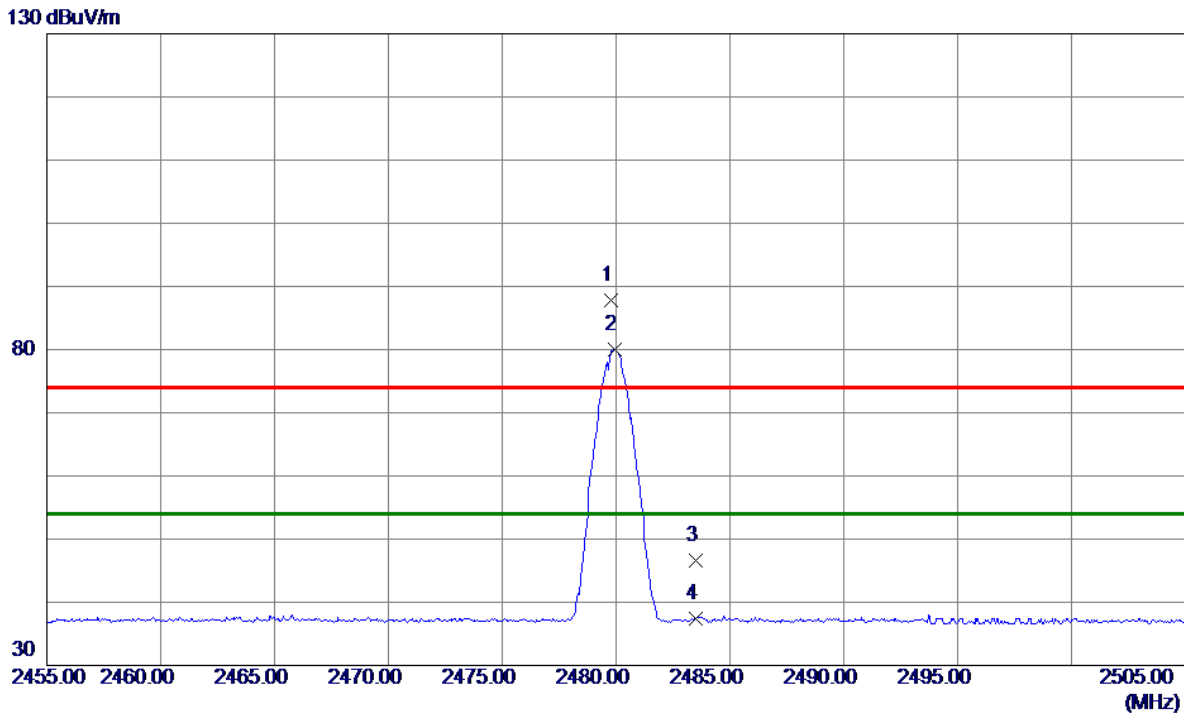

No.	Freq. MHz	Reading Level dBuV/m	Correct Factor dB	Measure ment dBuV/m	Limit dBuV/m	Margin dB	Detector	Comment
1	2479.8000	80.47	7.25	87.72	74.00	13.72	Peak	No Limit
2 *	2479.9500	72.71	7.25	79.96	54.00	25.96	AVG	No Limit
3	2483.5000	39.42	7.25	46.67	74.00	-27.33	Peak	
4	2483.5000	30.24	7.25	37.49	54.00	-16.51	AVG	

**REMARKS:**

- (1) Measurement Value = Reading Level + Correct Factor.
- (2) Margin Level = Measurement Value - Limit Value.

Test Mode : TX 2480 MHz \_CH39\_1Mbps

**Vertical**

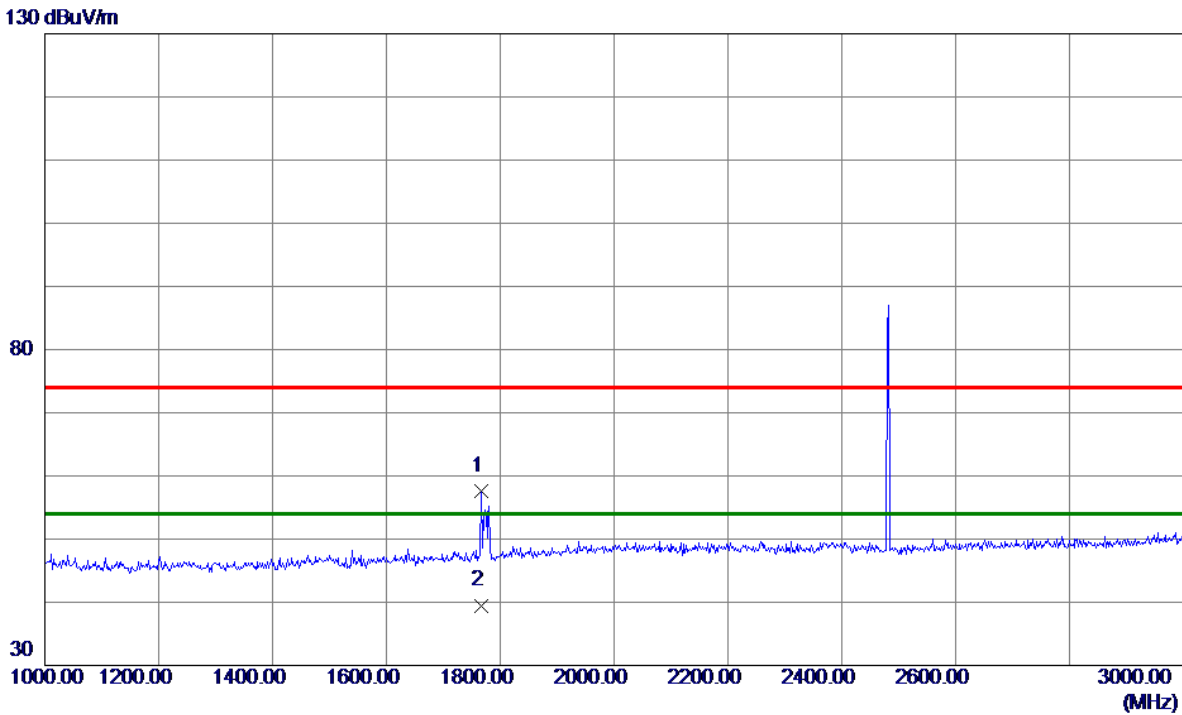

No.	Freq. MHz	Reading Level dBuV/m	Correct Factor dB	Measure ment dBuV/m	Limit dBuV/m	Margin dB	Detector	Comment
1	1766.7670	51.87	5.65	57.52	74.00	-16.48	Peak	
2 *	1766.7670	33.85	5.65	39.50	54.00	-14.50	AVG	

**REMARKS:**

- (1) Measurement Value = Reading Level + Correct Factor.
- (2) Margin Level = Measurement Value - Limit Value.



Test Mode : TX 2480 MHz \_CH39\_1Mbps

**Vertical**

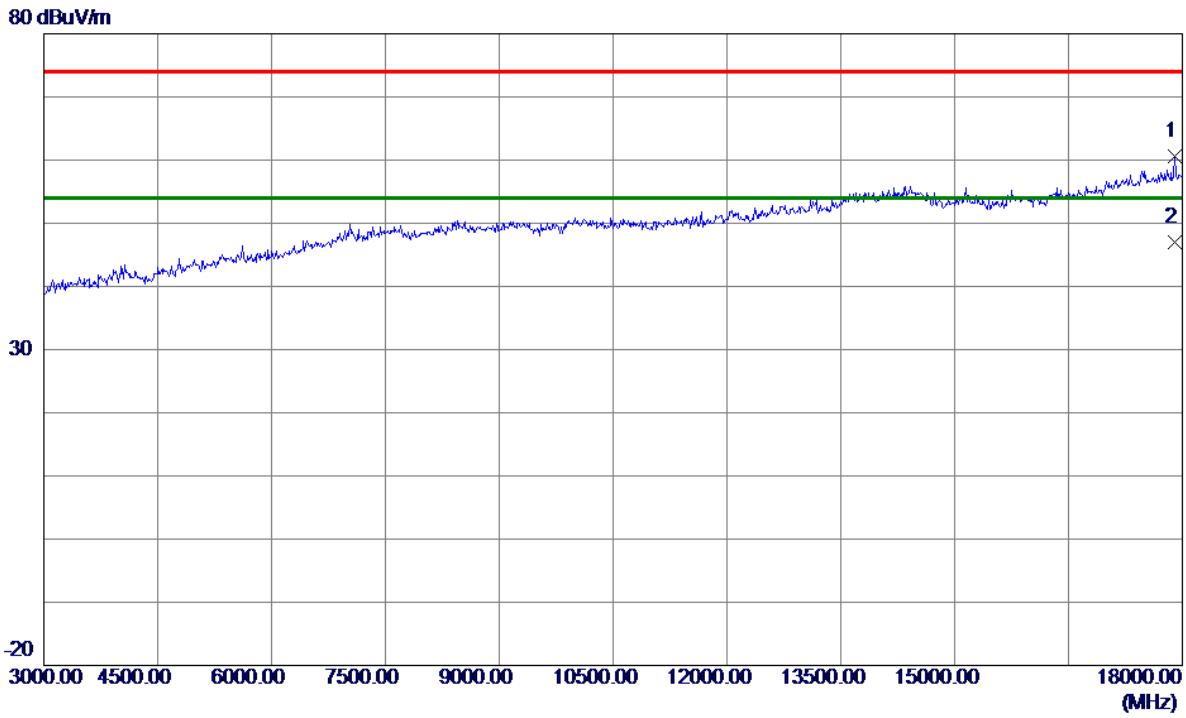

No.	Freq. MHz	Reading Level dBuV/m	Correct Factor dB	Measure ment dBuV/m	Limit dBuV/m	Margin dB	Detector	Comment
1	17895.0000	39.89	20.64	60.53	74.00	-13.47	Peak	
2 *	17896.5480	26.41	20.64	47.05	54.00	-6.95	AVG	

**REMARKS:**

- (1) Measurement Value = Reading Level + Correct Factor.
- (2) Margin Level = Measurement Value - Limit Value.

Test Mode : TX 2480 MHz \_CH39\_1Mbps

**Vertical**

130 dBuV/m

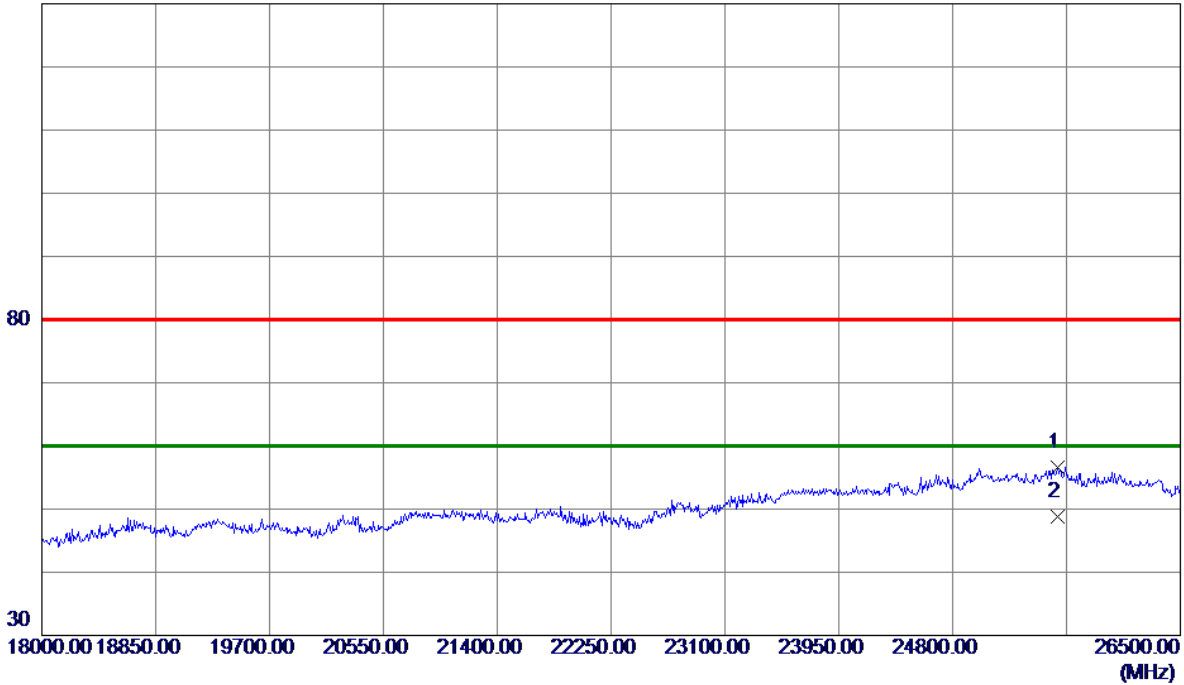

No.	Freq. MHz	Reading Level dBuV/m	Correct Factor dB	Measure ment dBuV/m	Limit dBuV/m	Margin dB	Detector	Comment
1	25582.0000	26.46	30.13	56.59	80.00	-23.41	Peak	
2 *	25582.0000	18.65	30.13	48.78	60.00	-11.22	AVG	

**REMARKS:**

- (1) Measurement Value = Reading Level + Correct Factor.
- (2) Margin Level = Measurement Value - Limit Value.

Test Mode : TX 2480 MHz \_CH39\_1Mbps

### Horizontal

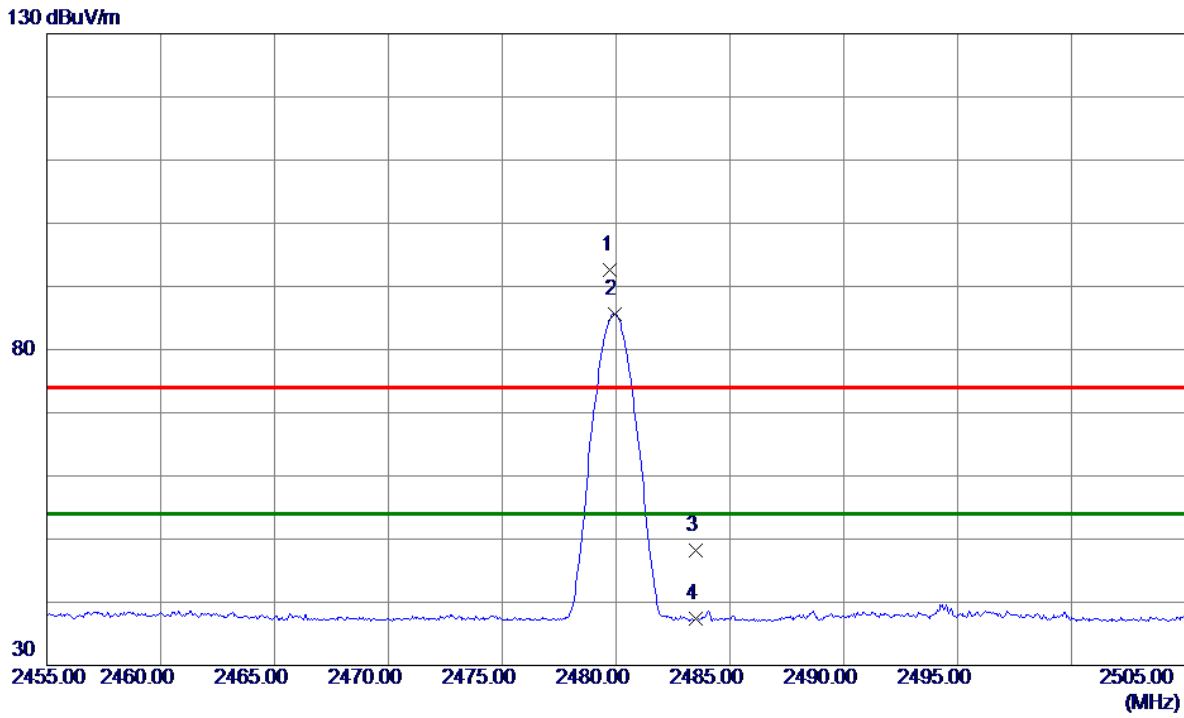

No.	Freq. MHz	Reading Level dBuV/m	Correct Factor dB	Measure ment dBuV/m	Limit dBuV/m	Margin dB	Detector	Comment
1	2479.7500	85.29	7.25	92.54	74.00	18.54	Peak	No Limit
2 *	2479.9500	78.41	7.25	85.66	54.00	31.66	AVG	No Limit
3	2483.5000	41.02	7.25	48.27	74.00	-25.73	Peak	
4	2483.5000	30.10	7.25	37.35	54.00	-16.65	AVG	

REMARKS:  
 (1) Measurement Value = Reading Level + Correct Factor.  
 (2) Margin Level = Measurement Value - Limit Value.

Test Mode : TX 2480 MHz \_CH39\_1Mbps

### Horizontal

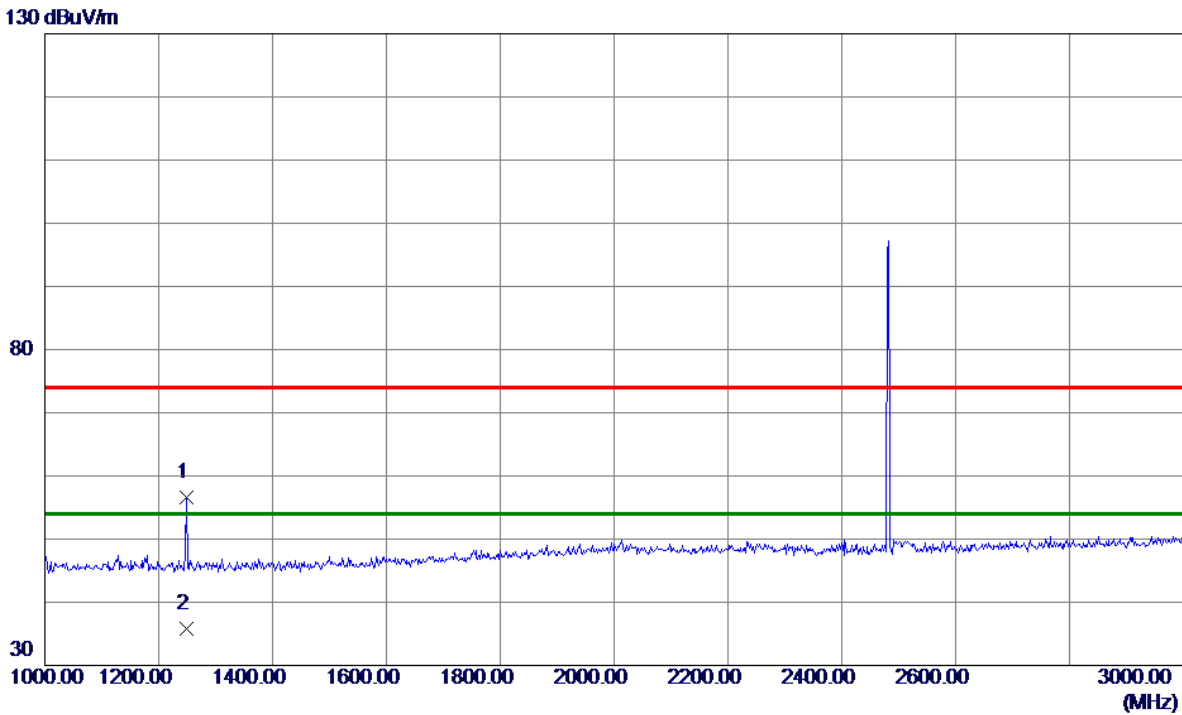

No.	Freq. MHz	Reading Level dBuV/m	Correct Factor dB	Measure ment dBuV/m	Limit dBuV/m	Margin dB	Detector	Comment
1 *	1248.2480	53.66	2.98	56.64	74.00	-17.36	Peak	
2	1248.2480	32.75	2.98	35.73	54.00	-18.27	AVG	

**REMARKS:**

- (1) Measurement Value = Reading Level + Correct Factor.
- (2) Margin Level = Measurement Value - Limit Value.

Test Mode : TX 2480 MHz \_CH39\_1Mbps

### Horizontal

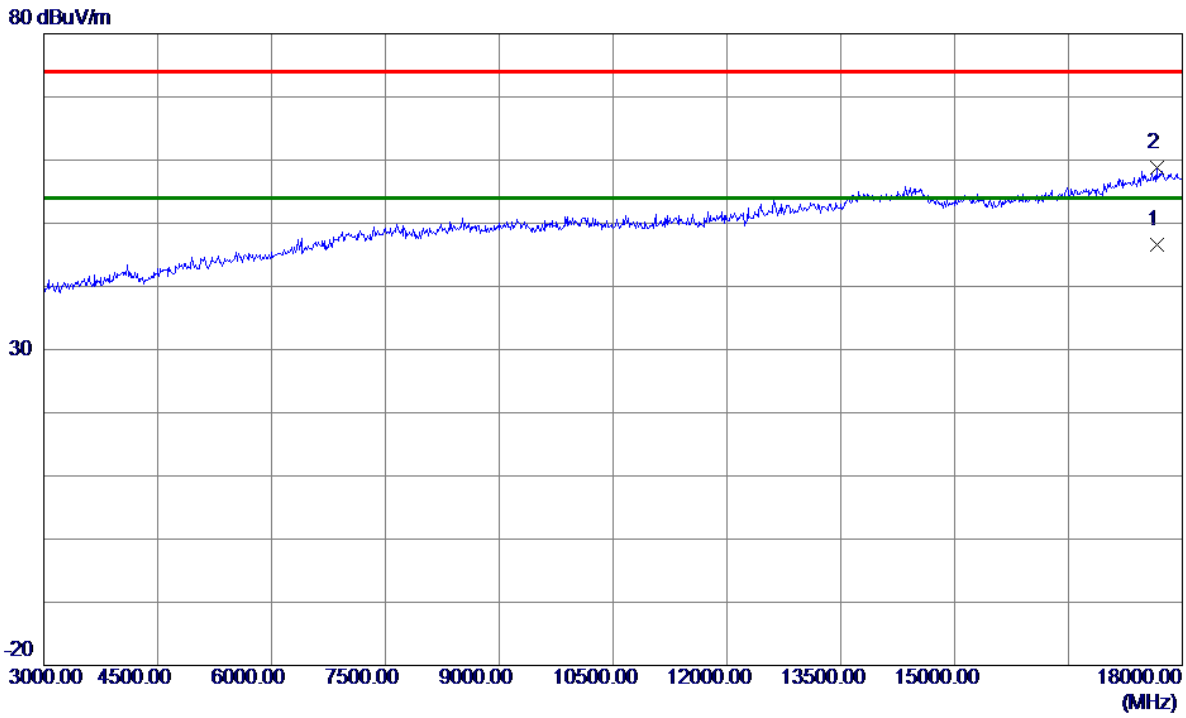

No.	Freq. MHz	Reading Level dBuV/m	Correct Factor dB	Measure ment dBuV/m	Limit dBuV/m	Margin dB	Detector	Comment
1 *	17660.5879	25.92	20.62	46.54	54.00	-7.46	AVG	
2	17662.5000	38.09	20.62	58.71	74.00	-15.29	Peak	

**REMARKS:**

- (1) Measurement Value = Reading Level + Correct Factor.
- (2) Margin Level = Measurement Value - Limit Value.

Test Mode : TX 2480 MHz \_CH39\_1Mbps

### Horizontal

130 dBuV/m

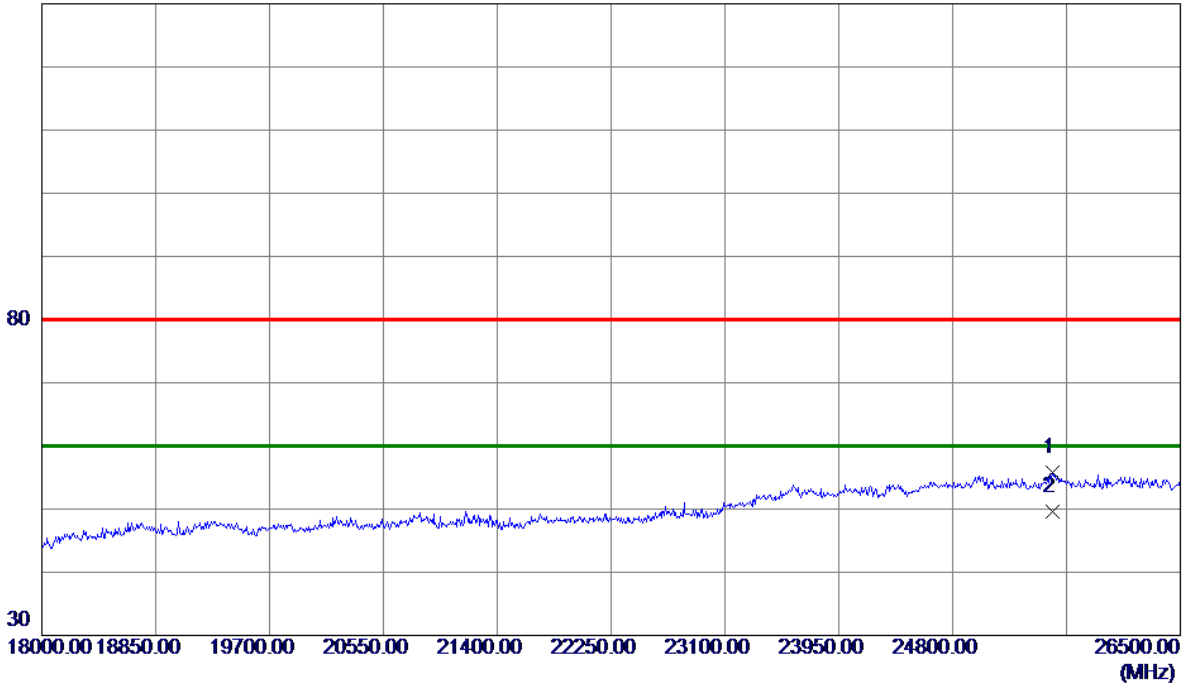

No.	Freq. MHz	Reading Level dBuV/m	Correct Factor dB	Measure ment dBuV/m	Limit dBuV/m	Margin dB	Detector	Comment
1	25548.0000	25.72	30.11	55.83	80.00	-24.17	Peak	
2 *	25548.0000	19.53	30.11	49.64	60.00	-10.36	AVG	

REMARKS:

- (1) Measurement Value = Reading Level + Correct Factor.
- (2) Margin Level = Measurement Value - Limit Value.

Test Mode : TX 2402 MHz \_CH00\_2Mbps

**Vertical**

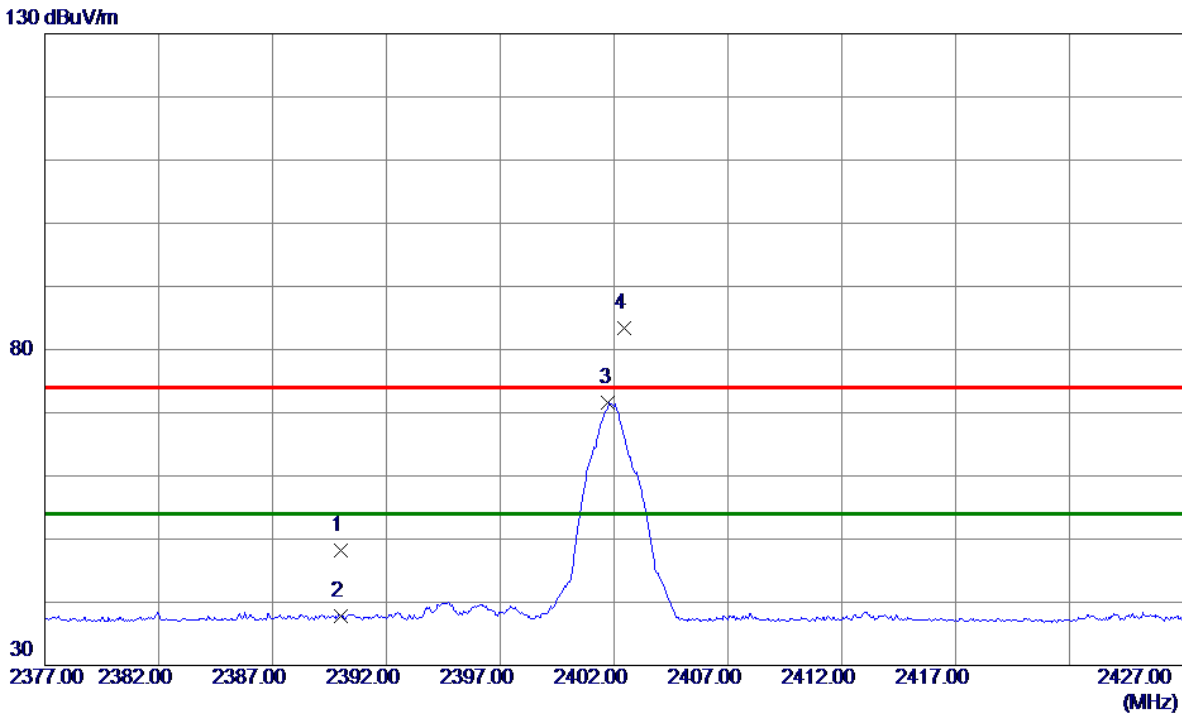

No.	Freq. MHz	Reading Level dBuV/m	Correct Factor dB	Measure ment dBuV/m	Limit dBuV/m	Margin dB	Detector	Comment
1	2390.0000	40.88	7.26	48.14	74.00	-25.86	Peak	
2	2390.0000	30.53	7.26	37.79	54.00	-16.21	AVG	
3 *	2401.7500	64.36	7.26	71.62	54.00	17.62	AVG	No Limit
4	2402.4500	76.06	7.26	83.32	74.00	9.32	Peak	No Limit

**REMARKS:**

- (1) Measurement Value = Reading Level + Correct Factor.
- (2) Margin Level = Measurement Value - Limit Value.

Test Mode : TX 2402 MHz \_CH00\_2Mbps

**Vertical**

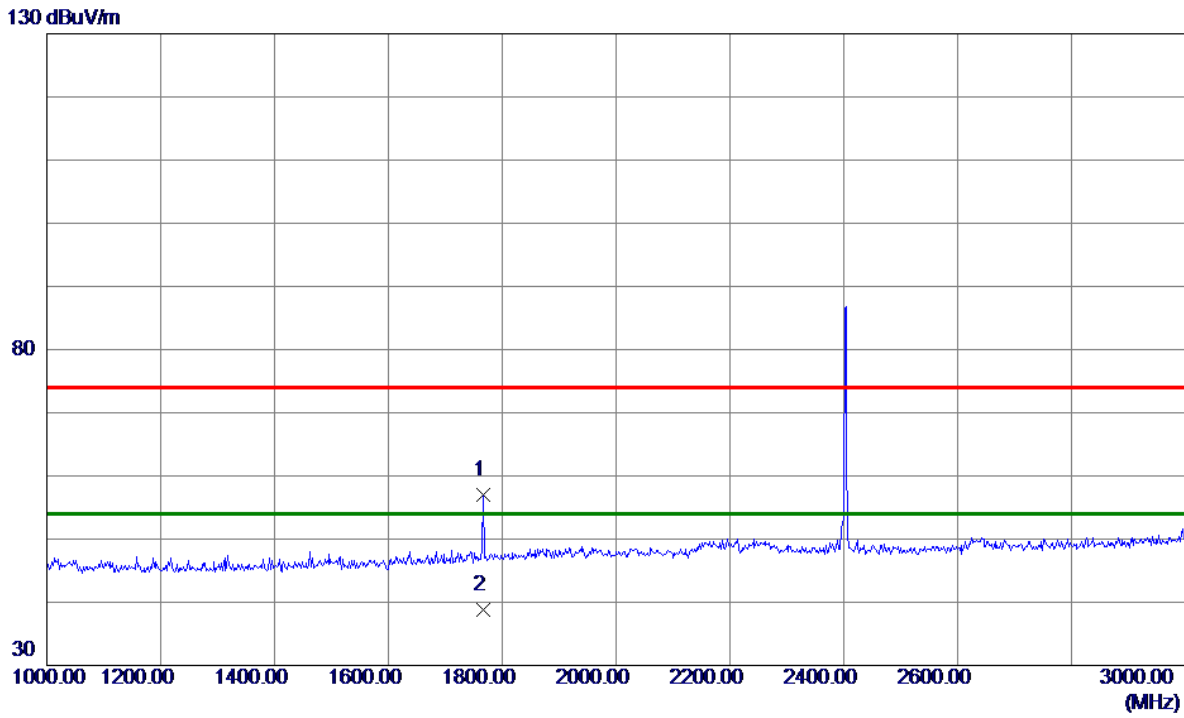

No.	Freq. MHz	Reading Level dBuV/m	Correct Factor dB	Measure ment dBuV/m	Limit dBuV/m	Margin dB	Detector	Comment
1	1766.7670	51.40	5.65	57.05	74.00	-16.95	Peak	
2 *	1766.7670	33.13	5.65	38.78	54.00	-15.22	AVG	

**REMARKS:**

- (1) Measurement Value = Reading Level + Correct Factor.
- (2) Margin Level = Measurement Value - Limit Value.



Test Mode : TX 2402 MHz \_CH00\_2Mbps

**Vertical**

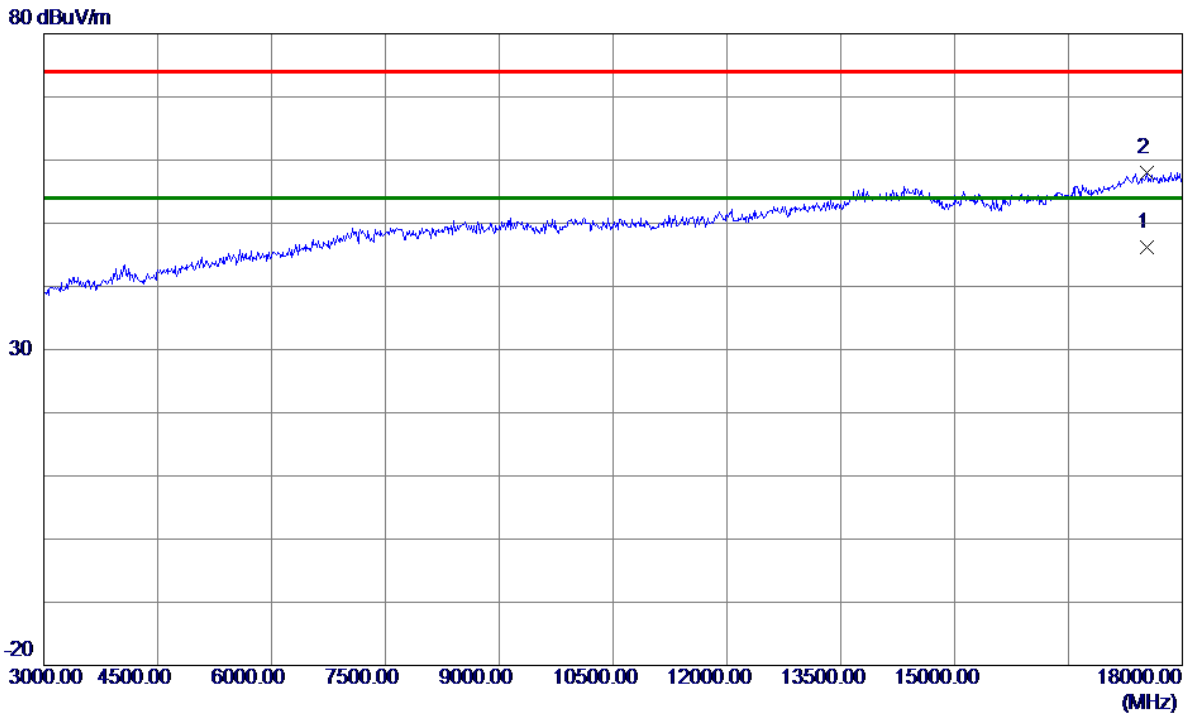

No.	Freq. MHz	Reading Level dBuV/m	Correct Factor dB	Measure ment dBuV/m	Limit dBuV/m	Margin dB	Detector	Comment
1 *	17533.9050	25.52	20.60	46.12	54.00	-7.88	AVG	
2	17535.0000	37.49	20.60	58.09	74.00	-15.91	Peak	

**REMARKS:**

- (1) Measurement Value = Reading Level + Correct Factor.
- (2) Margin Level = Measurement Value - Limit Value.

Test Mode : TX 2402 MHz \_CH00\_2Mbps

**Vertical**

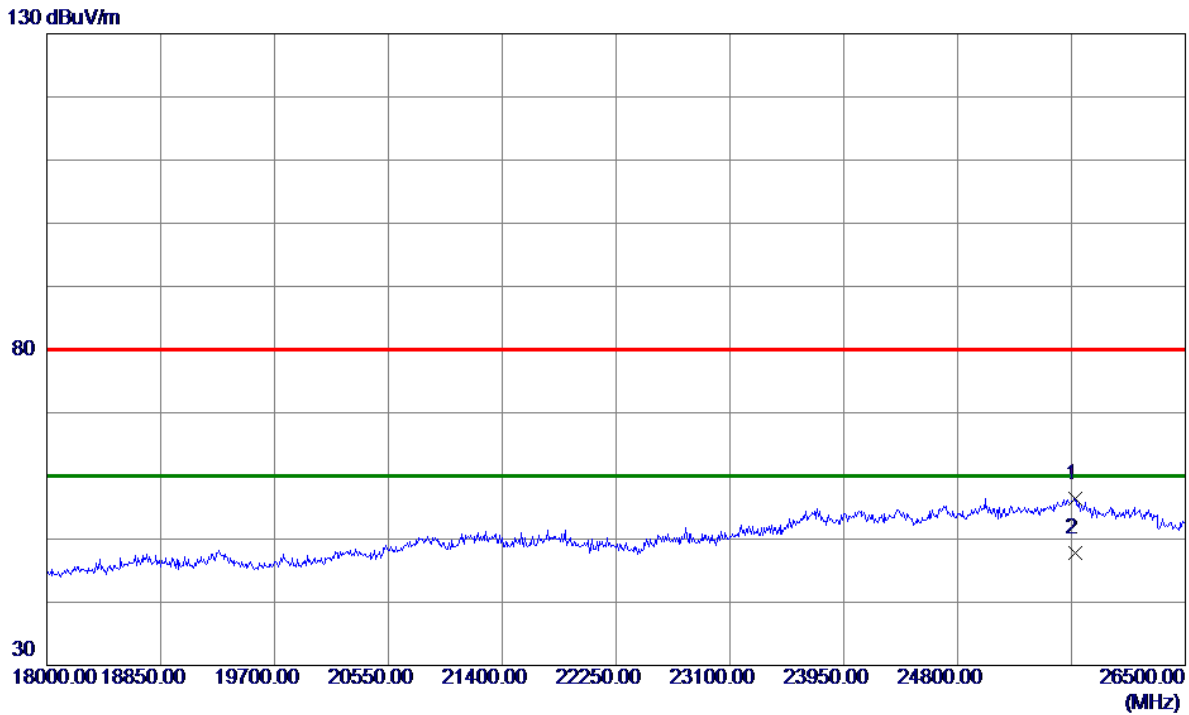

No.	Freq. MHz	Reading Level dBuV/m	Correct Factor dB	Measure ment dBuV/m	Limit dBuV/m	Margin dB	Detector	Comment
1	25675.5000	26.29	30.19	56.48	80.00	-23.52	Peak	
2 *	25675.5000	17.65	30.19	47.84	60.00	-12.16	AVG	

**REMARKS:**

- (1) Measurement Value = Reading Level + Correct Factor.
- (2) Margin Level = Measurement Value - Limit Value.

Test Mode : TX 2402 MHz \_CH00\_2Mbps

### Horizontal

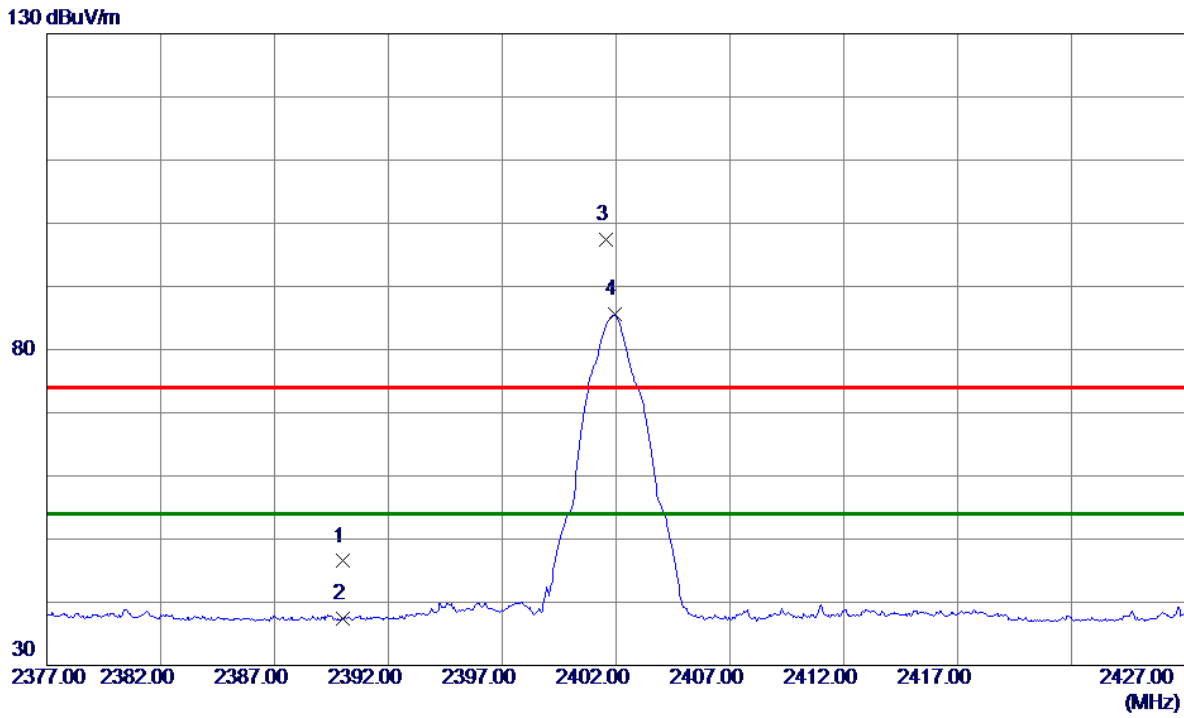

No.	Freq. MHz	Reading Level dBuV/m	Correct Factor dB	Measure ment dBuV/m	Limit dBuV/m	Margin dB	Detector	Comment
1	2390.0000	39.24	7.26	46.50	74.00	-27.50	Peak	
2	2390.0000	30.17	7.26	37.43	54.00	-16.57	AVG	
3	2401.5500	90.10	7.26	97.36	74.00	23.36	Peak	No Limit
4 *	2401.9500	78.32	7.26	85.58	54.00	31.58	AVG	No Limit

**REMARKS:**

- (1) Measurement Value = Reading Level + Correct Factor.
- (2) Margin Level = Measurement Value - Limit Value.

Test Mode : TX 2402 MHz \_CH00\_2Mbps

### Horizontal

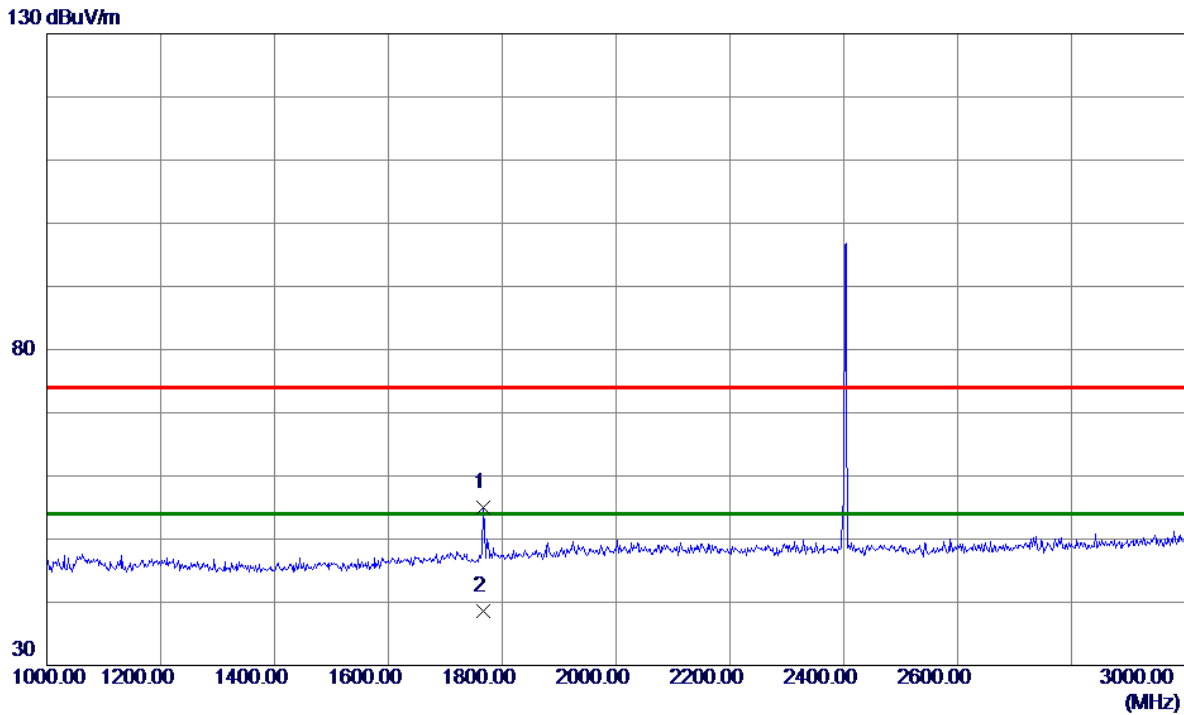

No.	Freq. MHz	Reading Level dBuV/m	Correct Factor dB	Measure ment dBuV/m	Limit dBuV/m	Margin dB	Detector	Comment
1	1766.7670	49.38	5.65	55.03	74.00	-18.97	Peak	
2 *	1766.7670	32.98	5.65	38.63	54.00	-15.37	AVG	

**REMARKS:**

- (1) Measurement Value = Reading Level + Correct Factor.
- (2) Margin Level = Measurement Value - Limit Value.

Test Mode : TX 2402 MHz \_CH00\_2Mbps

### Horizontal

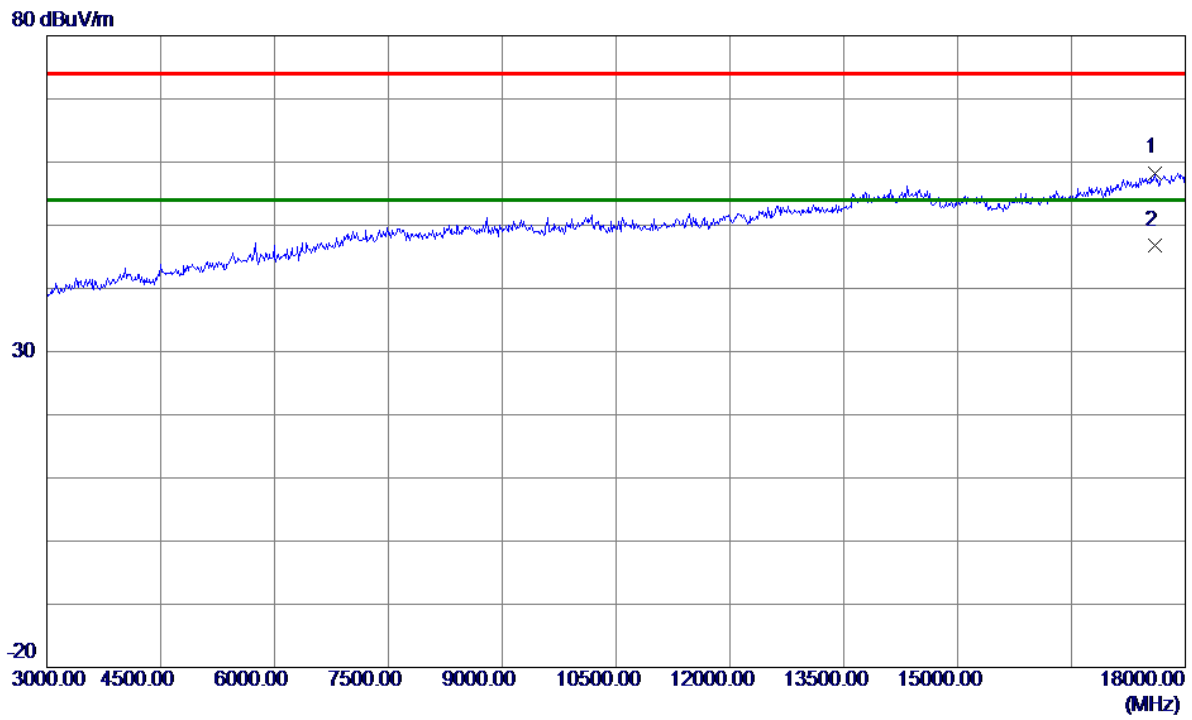

No.	Freq. MHz	Reading Level dBuV/m	Correct Factor dB	Measure ment dBuV/m	Limit dBuV/m	Margin dB	Detector	Comment
1	17595.0000	37.69	20.61	58.30	74.00	-15.70	Peak	
2 *	17596.6850	26.26	20.61	46.87	54.00	-7.13	AVG	

**REMARKS:**

- (1) Measurement Value = Reading Level + Correct Factor.
- (2) Margin Level = Measurement Value - Limit Value.

Test Mode : TX 2402 MHz \_CH00\_2Mbps

### Horizontal

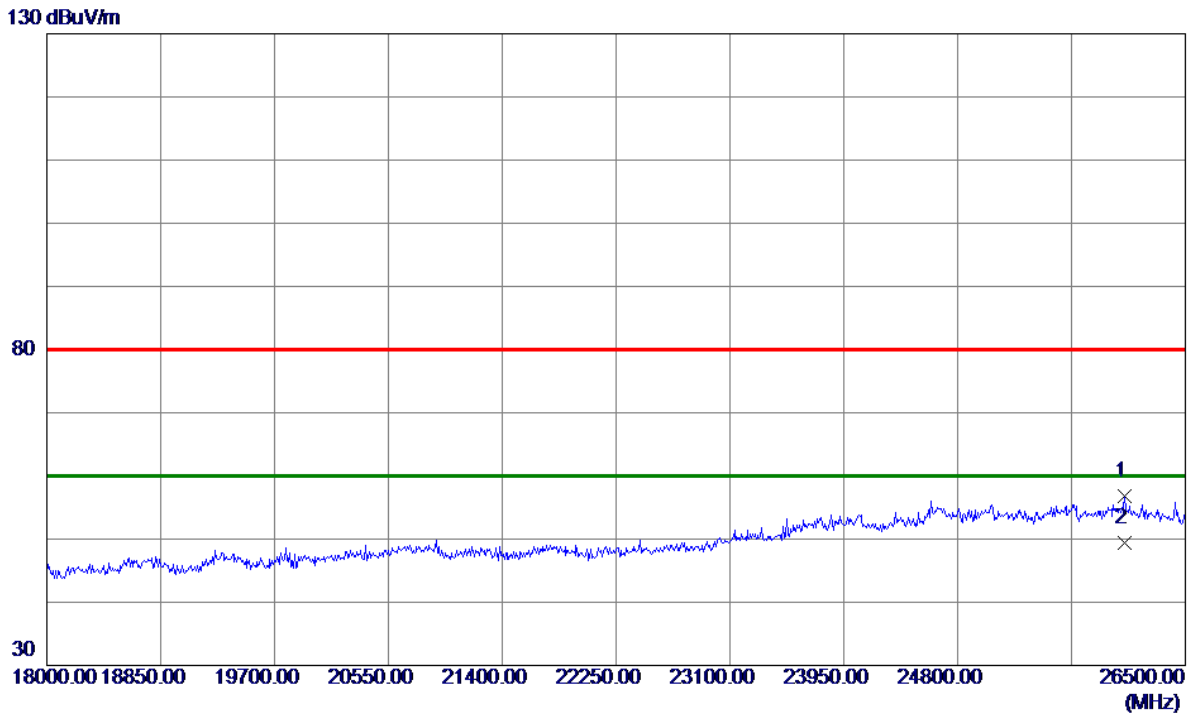

No.	Freq. MHz	Reading Level dBuV/m	Correct Factor dB	Measure ment dBuV/m	Limit dBuV/m	Margin dB	Detector	Comment
1	26049.5000	26.19	30.59	56.78	80.00	-23.22	Peak	
2 *	26049.5000	18.84	30.59	49.43	60.00	-10.57	AVG	

**REMARKS:**

- (1) Measurement Value = Reading Level + Correct Factor.
- (2) Margin Level = Measurement Value - Limit Value.

Test Mode : TX 2440 MHz \_CH19\_2Mbps

**Vertical**

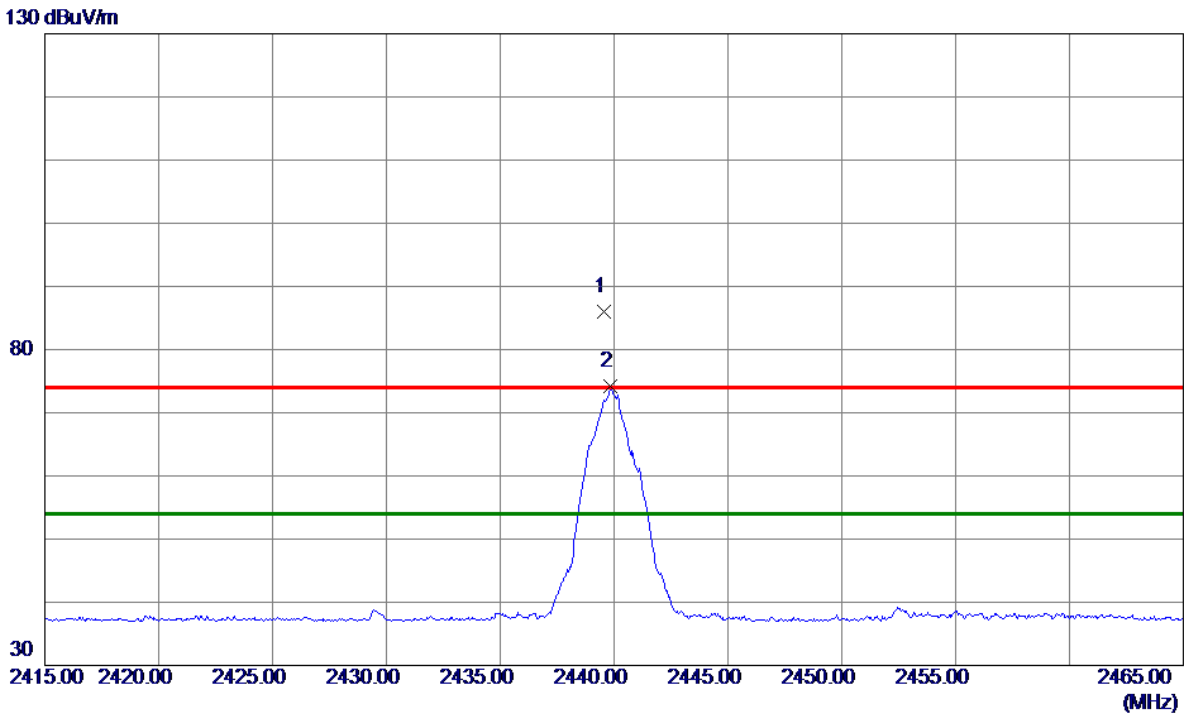

No.	Freq. MHz	Reading Level dBuV/m	Correct Factor dB	Measure ment dBuV/m	Limit dBuV/m	Margin dB	Detector	Comment
1	2439.5500	78.75	7.25	86.00	74.00	12.00	Peak	No Limit
2 *	2439.8500	67.00	7.25	74.25	54.00	20.25	AVG	No Limit

**REMARKS:**

- (1) Measurement Value = Reading Level + Correct Factor.
- (2) Margin Level = Measurement Value - Limit Value.

Test Mode : TX 2440 MHz \_CH19\_2Mbps

**Vertical**

130 dBuV/m

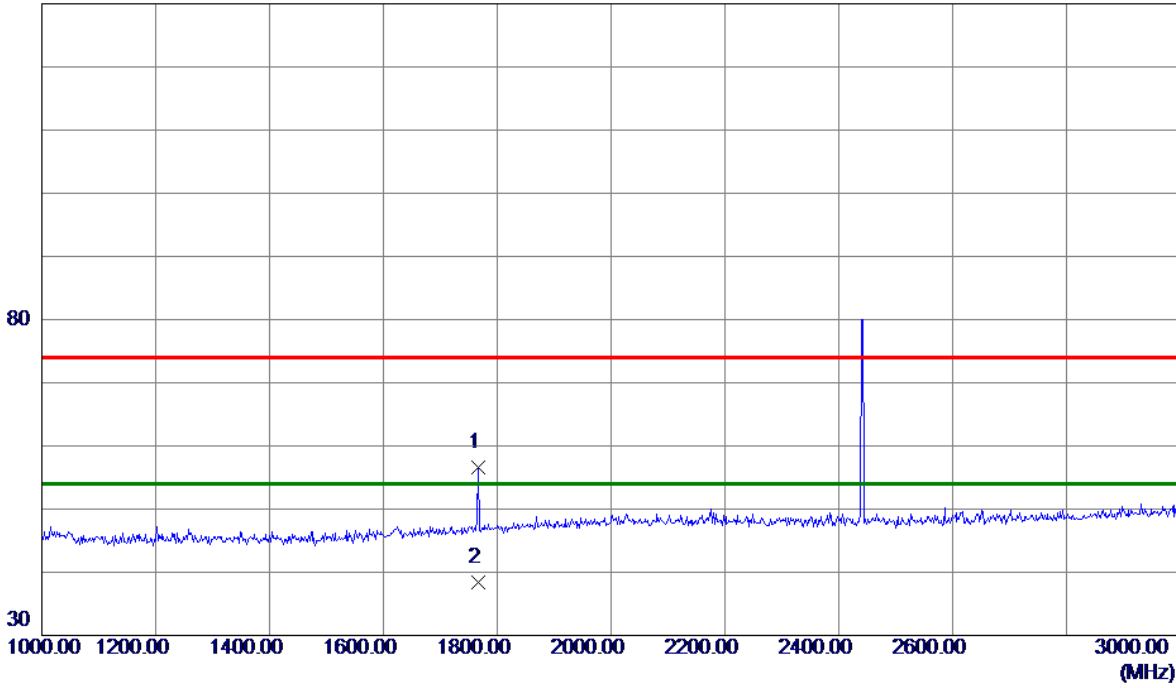

No.	Freq. MHz	Reading Level dBuV/m	Correct Factor dB	Measure ment dBuV/m	Limit dBuV/m	Margin dB	Detector	Comment
1	1766.7670	51.00	5.65	56.65	74.00	-17.35	Peak	
2 *	1766.7670	32.68	5.65	38.33	54.00	-15.67	AVG	

REMARKS:

- (1) Measurement Value = Reading Level + Correct Factor.
- (2) Margin Level = Measurement Value - Limit Value.



Test Mode : TX 2440 MHz \_CH19\_2Mbps

**Vertical**

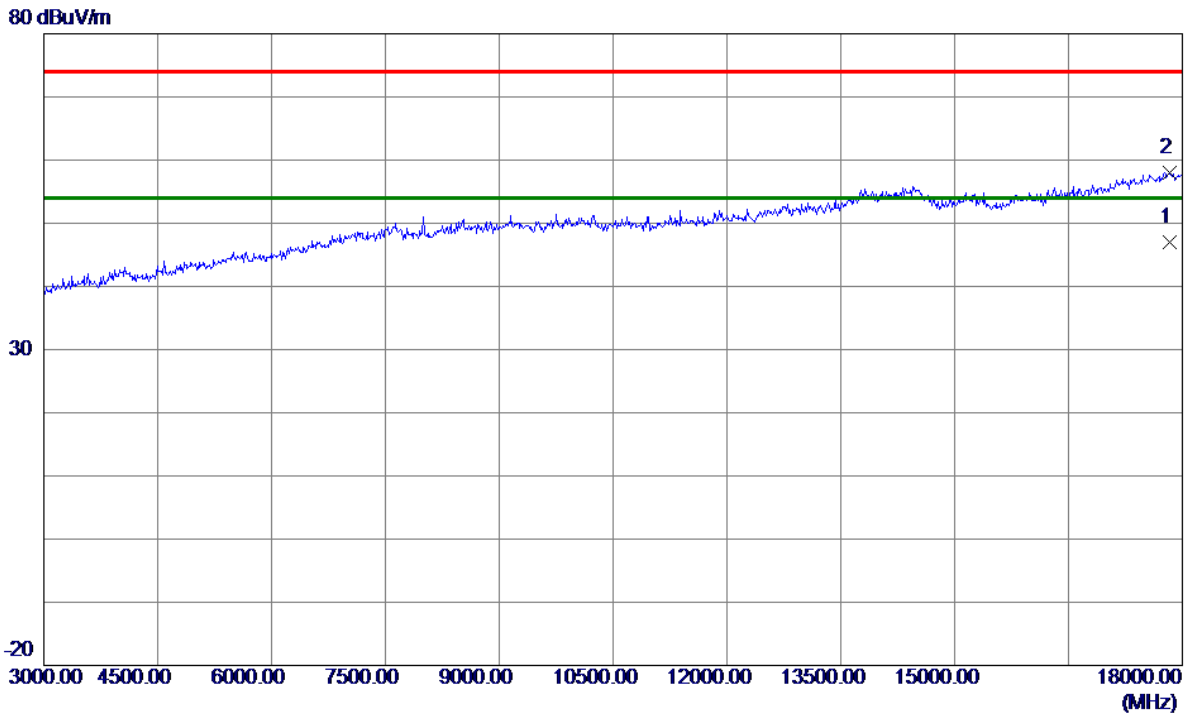

No.	Freq. MHz	Reading Level dBuV/m	Correct Factor dB	Measure ment dBuV/m	Limit dBuV/m	Margin dB	Detector	Comment
1 *	17826.5700	26.28	20.63	46.91	54.00	-7.09	AVG	
2	17827.5000	37.38	20.63	58.01	74.00	-15.99	Peak	

**REMARKS:**

- (1) Measurement Value = Reading Level + Correct Factor.
- (2) Margin Level = Measurement Value - Limit Value.

Test Mode : TX 2440 MHz \_CH19\_2Mbps

**Vertical**

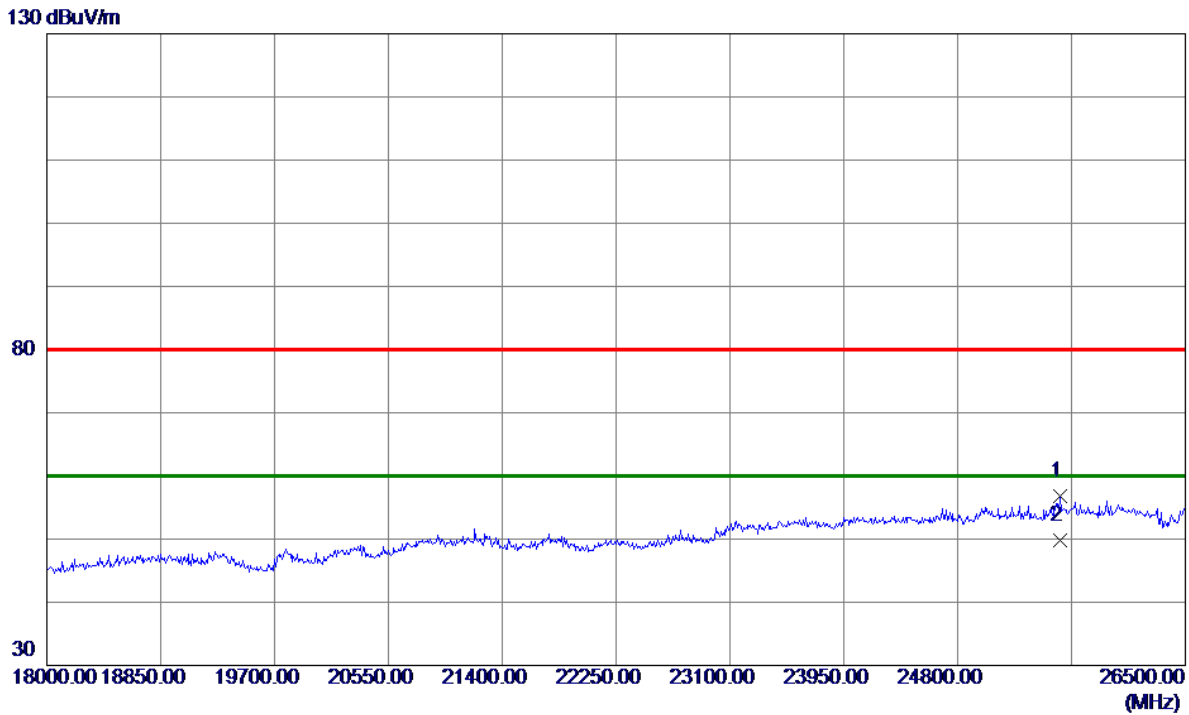

No.	Freq. MHz	Reading Level dBuV/m	Correct Factor dB	Measure ment dBuV/m	Limit dBuV/m	Margin dB	Detector	Comment
1	25565.0000	26.64	30.12	56.76	80.00	-23.24	Peak	
2 *	25565.0000	19.65	30.12	49.77	60.00	-10.23	AVG	

**REMARKS:**

- (1) Measurement Value = Reading Level + Correct Factor.
- (2) Margin Level = Measurement Value - Limit Value.

Test Mode : TX 2440 MHz \_CH19\_2Mbps

### Horizontal

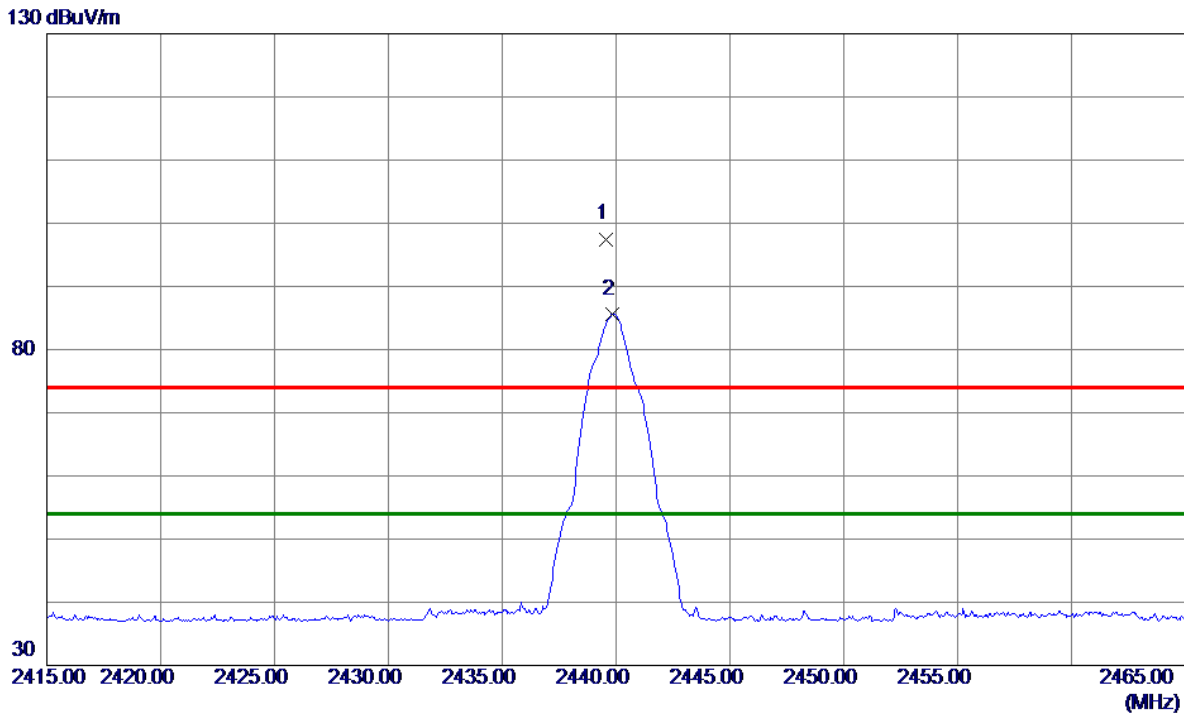

No.	Freq. MHz	Reading Level dBuV/m	Correct Factor dB	Measure ment dBuV/m	Limit dBuV/m	Margin dB	Detector	Comment
1	2439.5500	90.25	7.25	97.50	74.00	23.50	Peak	No Limit
2 *	2439.8500	78.43	7.25	85.68	54.00	31.68	AVG	No Limit

**REMARKS:**

- (1) Measurement Value = Reading Level + Correct Factor.
- (2) Margin Level = Measurement Value - Limit Value.

Test Mode : TX 2440 MHz \_CH19\_2Mbps

### Horizontal

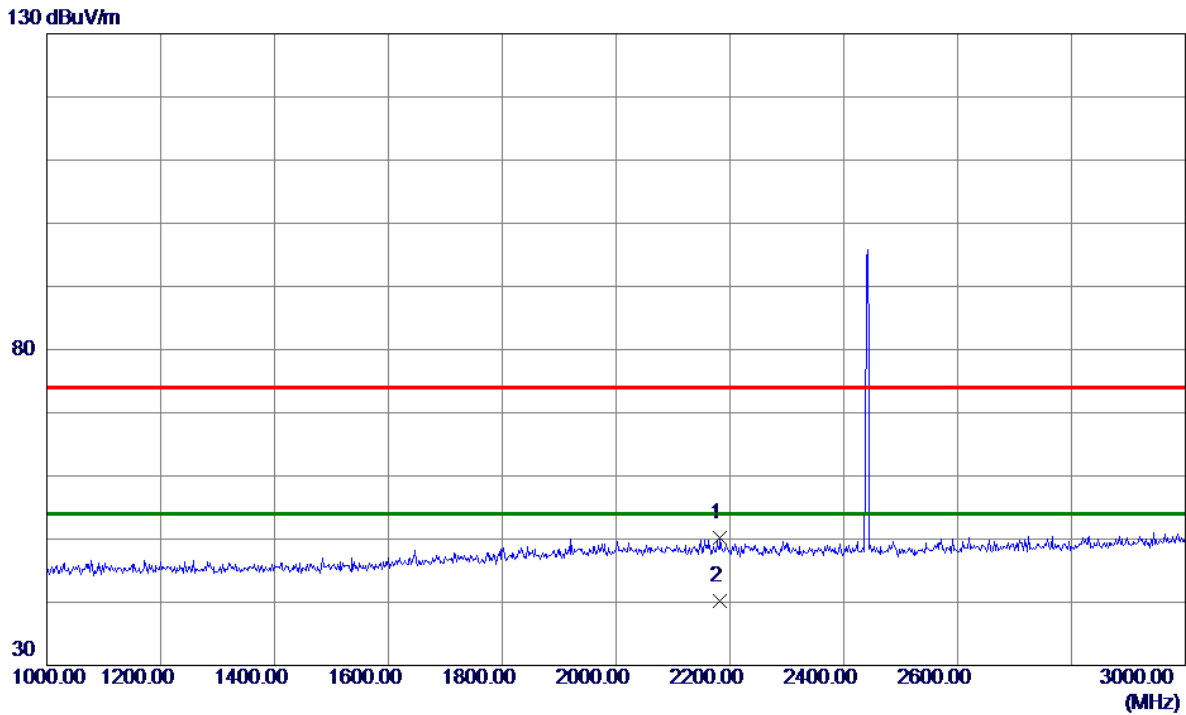

No.	Freq. MHz	Reading Level dBuV/m	Correct Factor dB	Measure ment dBuV/m	Limit dBuV/m	Margin dB	Detector	Comment
1	2183.1830	42.97	7.29	50.26	74.00	-23.74	Peak	
2 *	2183.1830	32.82	7.29	40.11	54.00	-13.89	AVG	

**REMARKS:**

- (1) Measurement Value = Reading Level + Correct Factor.
- (2) Margin Level = Measurement Value - Limit Value.

Test Mode : TX 2440 MHz \_CH19\_2Mbps

### Horizontal

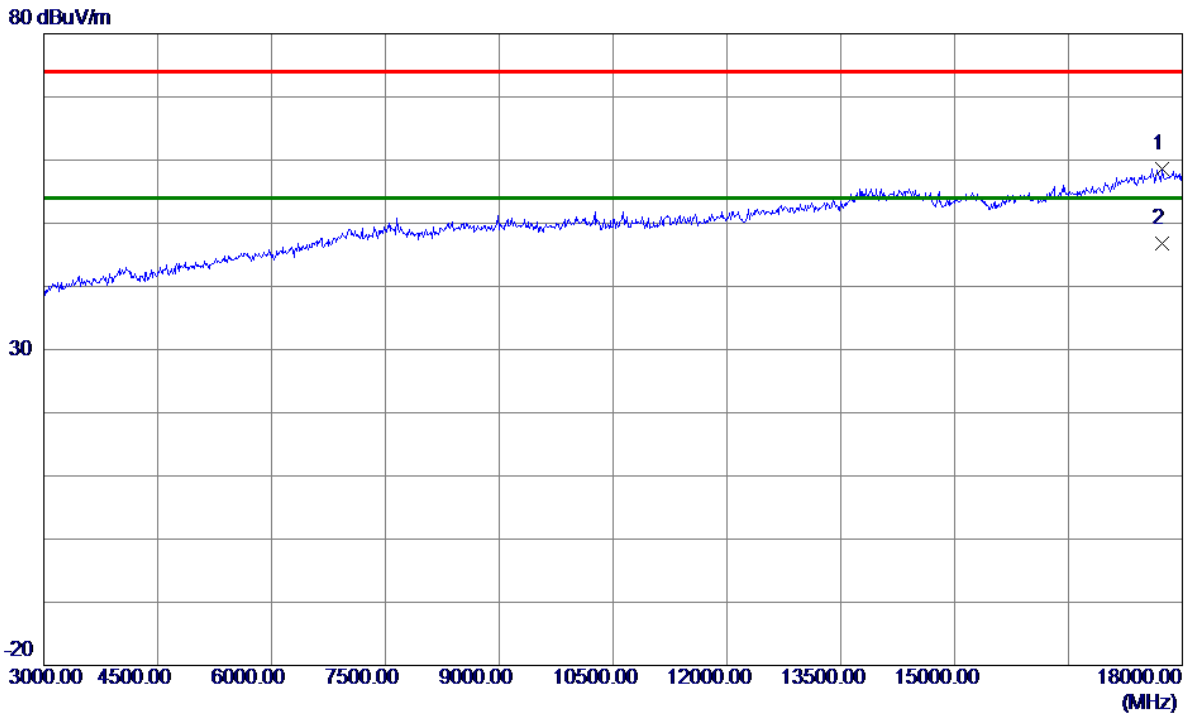

No.	Freq. MHz	Reading Level dBuV/m	Correct Factor dB	Measure ment dBuV/m	Limit dBuV/m	Margin dB	Detector	Comment
1	17737.5000	37.94	20.62	58.56	74.00	-15.44	Peak	
2 *	17737.9800	26.19	20.62	46.81	54.00	-7.19	AVG	

REMARKS:

- (1) Measurement Value = Reading Level + Correct Factor.
- (2) Margin Level = Measurement Value - Limit Value.

Test Mode : TX 2440 MHz \_CH19\_2Mbps

### Horizontal

130 dBuV/m

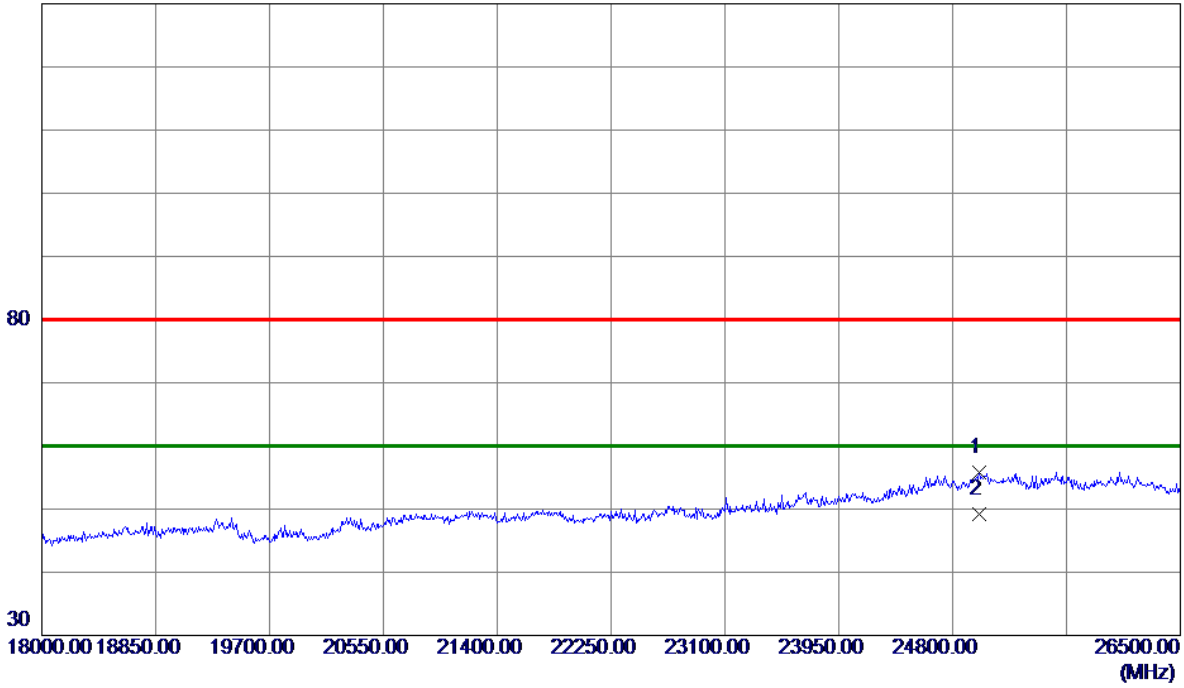

No.	Freq. MHz	Reading Level dBuV/m	Correct Factor dB	Measure ment dBuV/m	Limit dBuV/m	Margin dB	Detector	Comment
1	24995.5000	25.29	30.52	55.81	80.00	-24.19	Peak	
2 *	24995.5000	18.66	30.52	49.18	60.00	-10.82	AVG	

REMARKS:

- (1) Measurement Value = Reading Level + Correct Factor.
- (2) Margin Level = Measurement Value - Limit Value.

Test Mode : TX 2480 MHz \_CH39\_2Mbps

**Vertical**

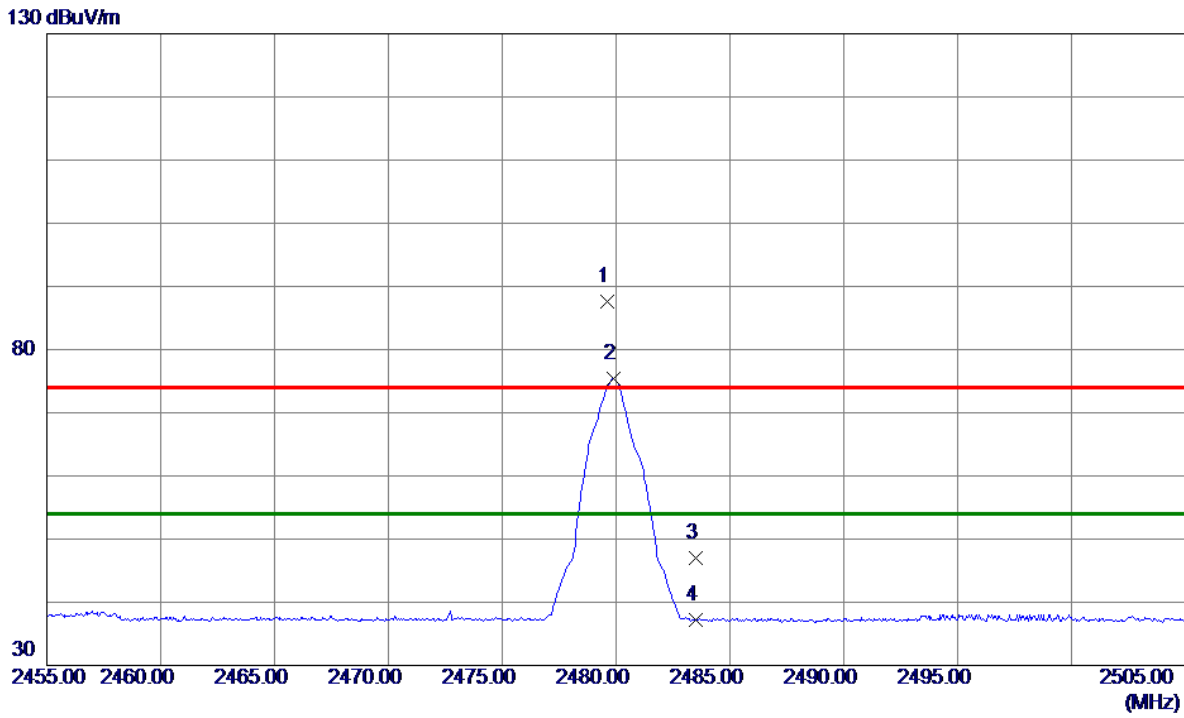

No.	Freq. MHz	Reading Level dBuV/m	Correct Factor dB	Measure ment dBuV/m	Limit dBuV/m	Margin dB	Detector	Comment
1	2479.6000	80.40	7.25	87.65	74.00	13.65	Peak	No Limit
2 *	2479.9000	68.09	7.25	75.34	54.00	21.34	AVG	No Limit
3	2483.5000	39.73	7.25	46.98	74.00	-27.02	Peak	
4	2483.5000	30.03	7.25	37.28	54.00	-16.72	AVG	

REMARKS:  
 (1) Measurement Value = Reading Level + Correct Factor.  
 (2) Margin Level = Measurement Value - Limit Value.

Test Mode : TX 2480 MHz \_CH39\_2Mbps

**Vertical**

130 dBuV/m

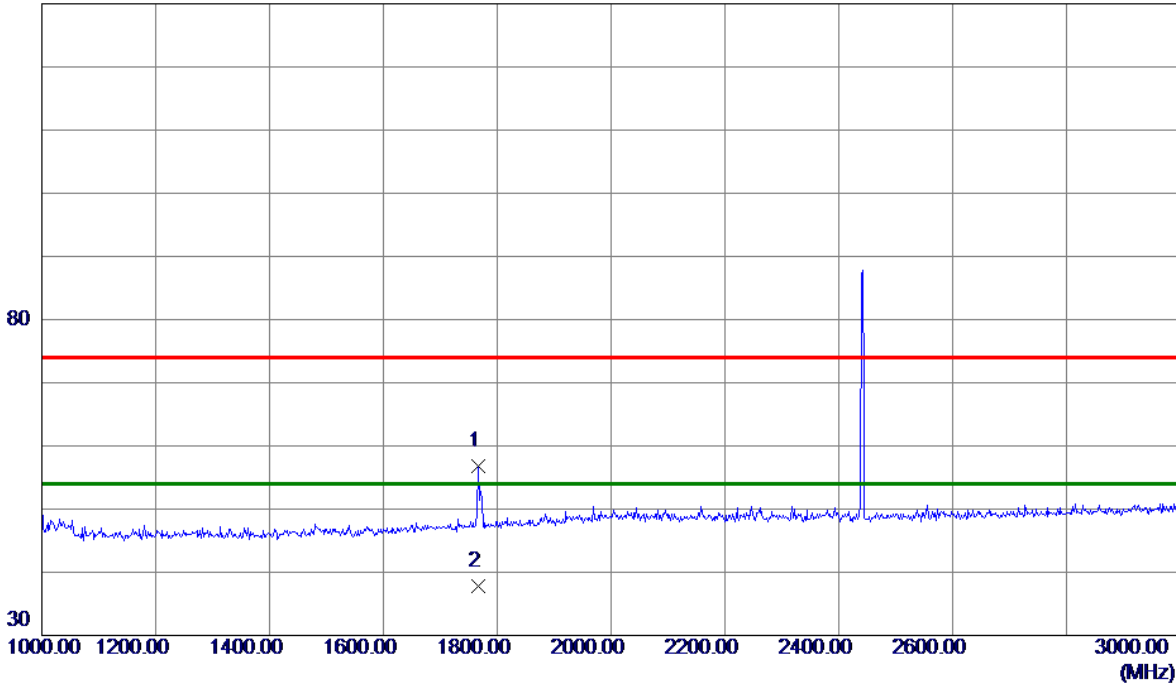

No.	Freq. MHz	Reading Level dBuV/m	Correct Factor dB	Measure ment dBuV/m	Limit dBuV/m	Margin dB	Detector	Comment
1	1766.7670	51.11	5.65	56.76	74.00	-17.24	Peak	
2 *	1766.7670	32.17	5.65	37.82	54.00	-16.18	AVG	

**REMARKS:**

- (1) Measurement Value = Reading Level + Correct Factor.
- (2) Margin Level = Measurement Value - Limit Value.



Test Mode : TX 2480 MHz \_CH39\_2Mbps

**Vertical**

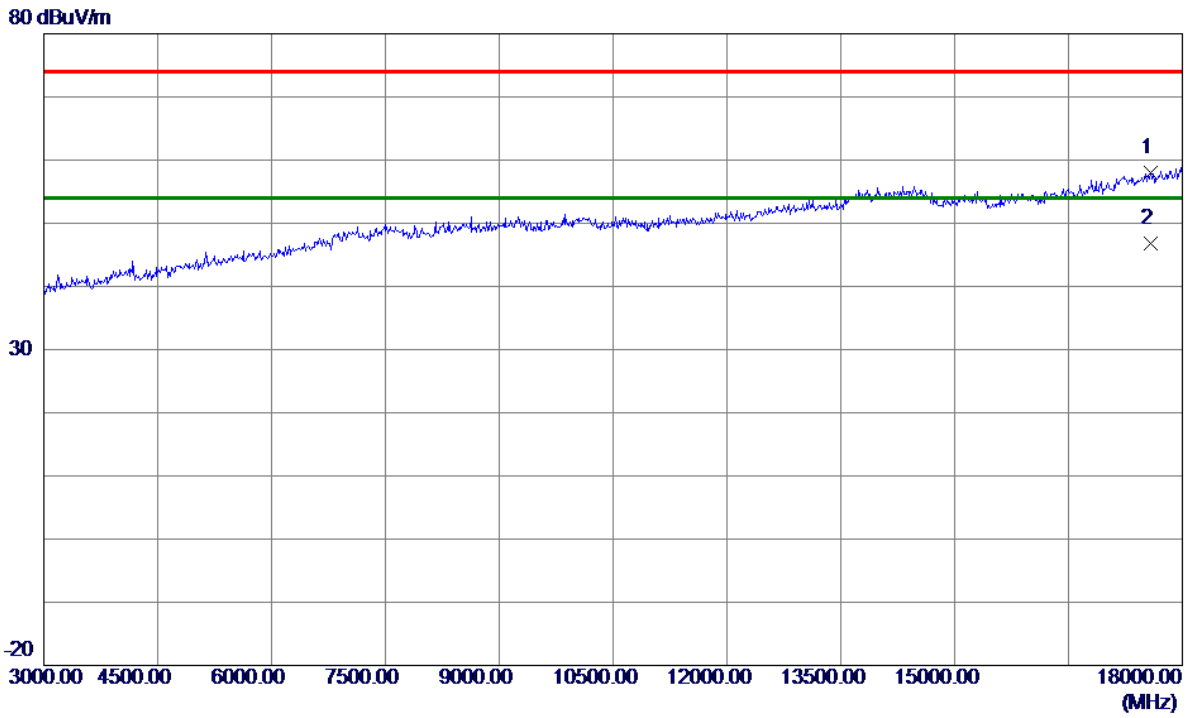

No.	Freq. MHz	Reading Level dBuV/m	Correct Factor dB	Measure ment dBuV/m	Limit dBuV/m	Margin dB	Detector	Comment
1	17587.5000	37.30	20.61	57.91	74.00	-16.09	Peak	
2 *	17588.9650	26.19	20.61	46.80	54.00	-7.20	AVG	

**REMARKS:**

- (1) Measurement Value = Reading Level + Correct Factor.
- (2) Margin Level = Measurement Value - Limit Value.

Test Mode : TX 2480 MHz \_CH39\_2Mbps

**Vertical**

130 dBuV/m

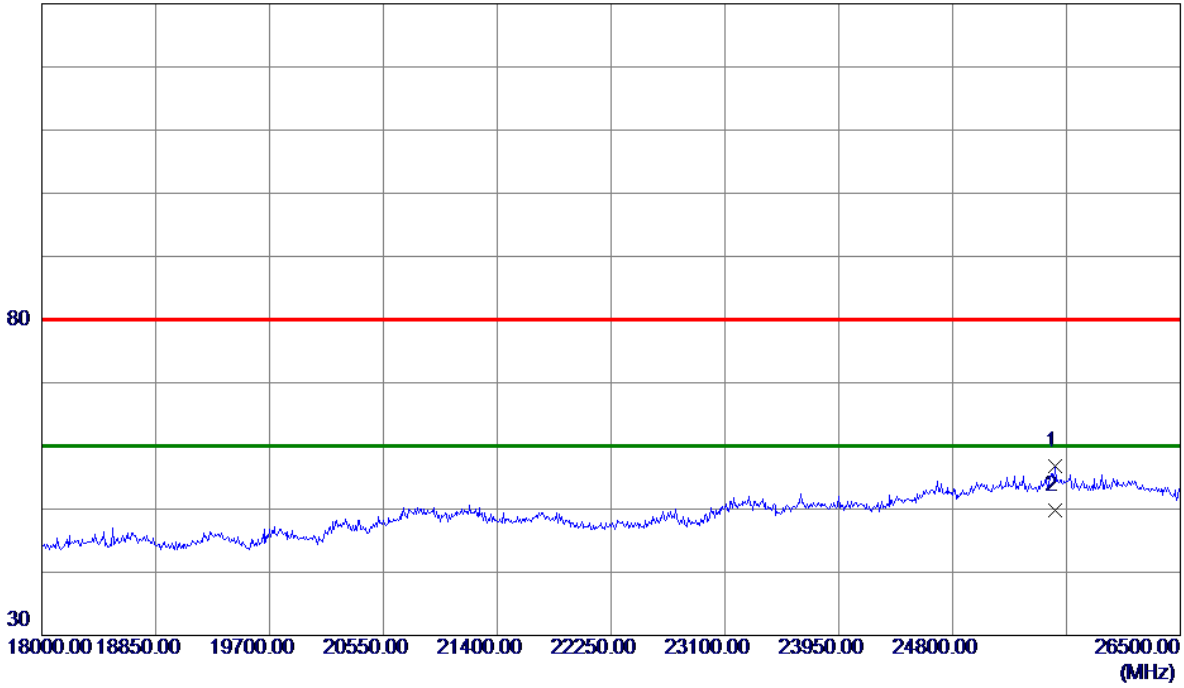

No.	Freq. MHz	Reading Level dBuV/m	Correct Factor dB	Measure ment dBuV/m	Limit dBuV/m	Margin dB	Detector	Comment
1	25565.0000	26.64	30.12	56.76	80.00	-23.24	Peak	
2 *	25565.0000	19.65	30.12	49.77	60.00	-10.23	AVG	

**REMARKS:**

- (1) Measurement Value = Reading Level + Correct Factor.
- (2) Margin Level = Measurement Value - Limit Value.

Test Mode : TX 2480 MHz \_CH39\_2Mbps

### Horizontal

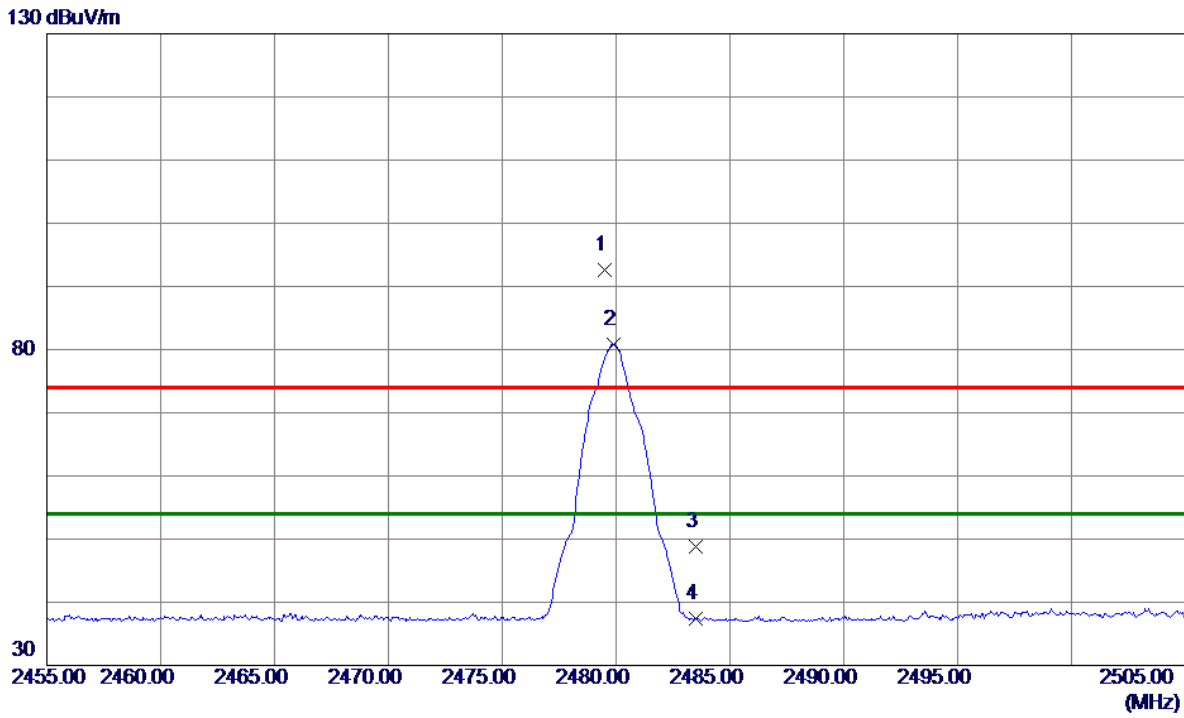

No.	Freq. MHz	Reading Level dBuV/m	Correct Factor dB	Measure ment dBuV/m	Limit dBuV/m	Margin dB	Detector	Comment
1	2479.5000	85.44	7.25	92.69	74.00	18.69	Peak	No Limit
2 *	2479.9000	73.62	7.25	80.87	54.00	26.87	AVG	No Limit
3	2483.5000	41.58	7.25	48.83	74.00	-25.17	Peak	
4	2483.5000	30.15	7.25	37.40	54.00	-16.60	AVG	

**REMARKS:**

- (1) Measurement Value = Reading Level + Correct Factor.
- (2) Margin Level = Measurement Value - Limit Value.

Test Mode : TX 2480 MHz \_CH39\_2Mbps

### Horizontal

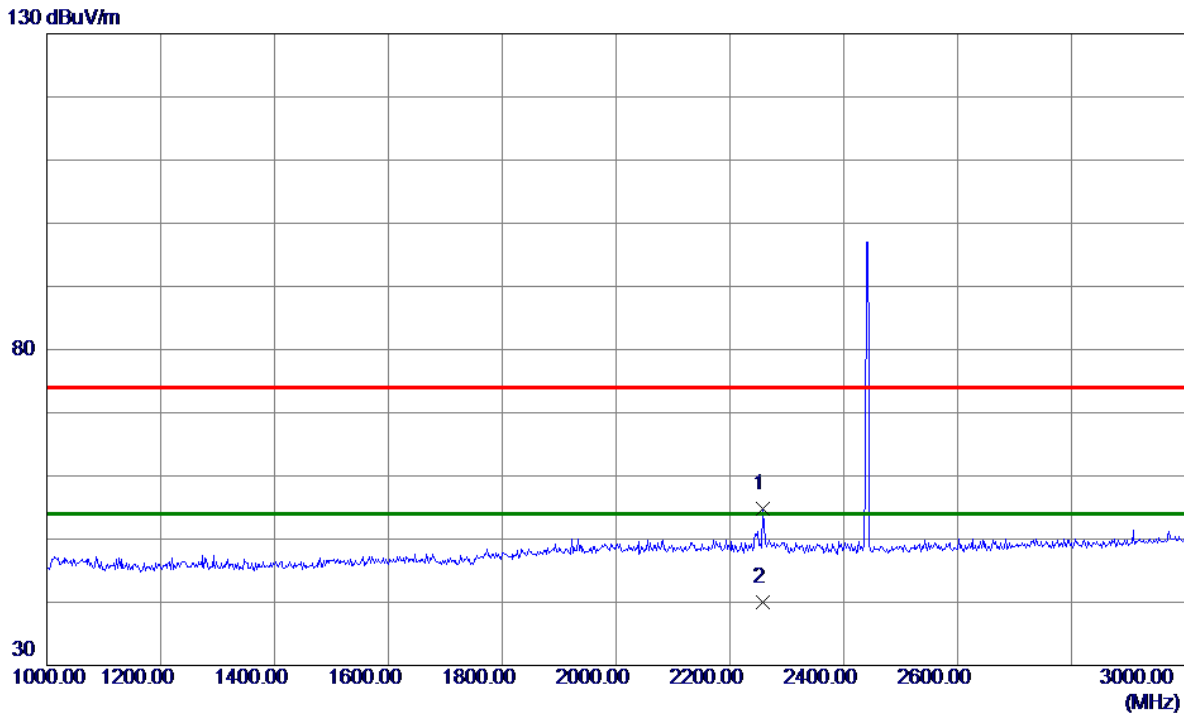

No.	Freq. MHz	Reading Level dBuV/m	Correct Factor dB	Measure ment dBuV/m	Limit dBuV/m	Margin dB	Detector	Comment
1	2257.2569	47.57	7.28	54.85	74.00	-19.15	Peak	
2 *	2257.2569	32.81	7.28	40.09	54.00	-13.91	AVG	

**REMARKS:**

- (1) Measurement Value = Reading Level + Correct Factor.
- (2) Margin Level = Measurement Value - Limit Value.

Test Mode : TX 2480 MHz \_CH39\_2Mbps

### Horizontal

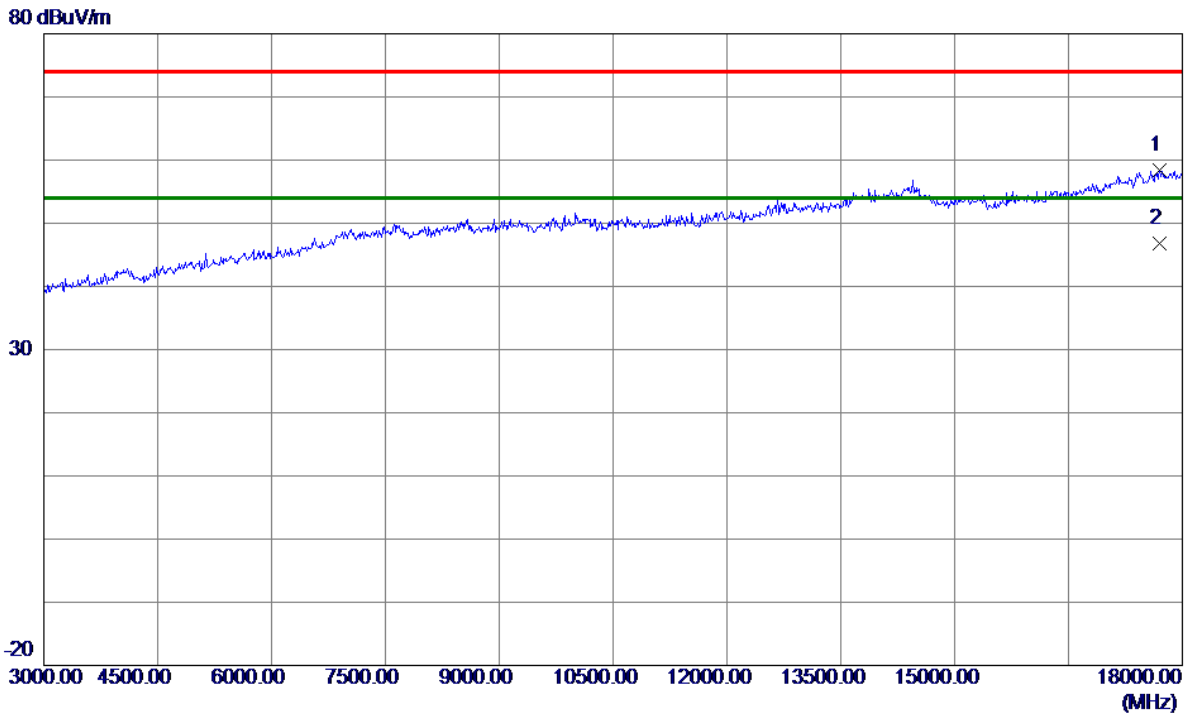

No.	Freq. MHz	Reading Level dBuV/m	Correct Factor dB	Measure ment dBuV/m	Limit dBuV/m	Margin dB	Detector	Comment
1	17707.5000	37.78	20.62	58.40	74.00	-15.60	Peak	
2 *	17708.0070	26.25	20.62	46.87	54.00	-7.13	AVG	

REMARKS:

- (1) Measurement Value = Reading Level + Correct Factor.
- (2) Margin Level = Measurement Value - Limit Value.

Test Mode : TX 2480 MHz \_CH39\_2Mbps

### Horizontal

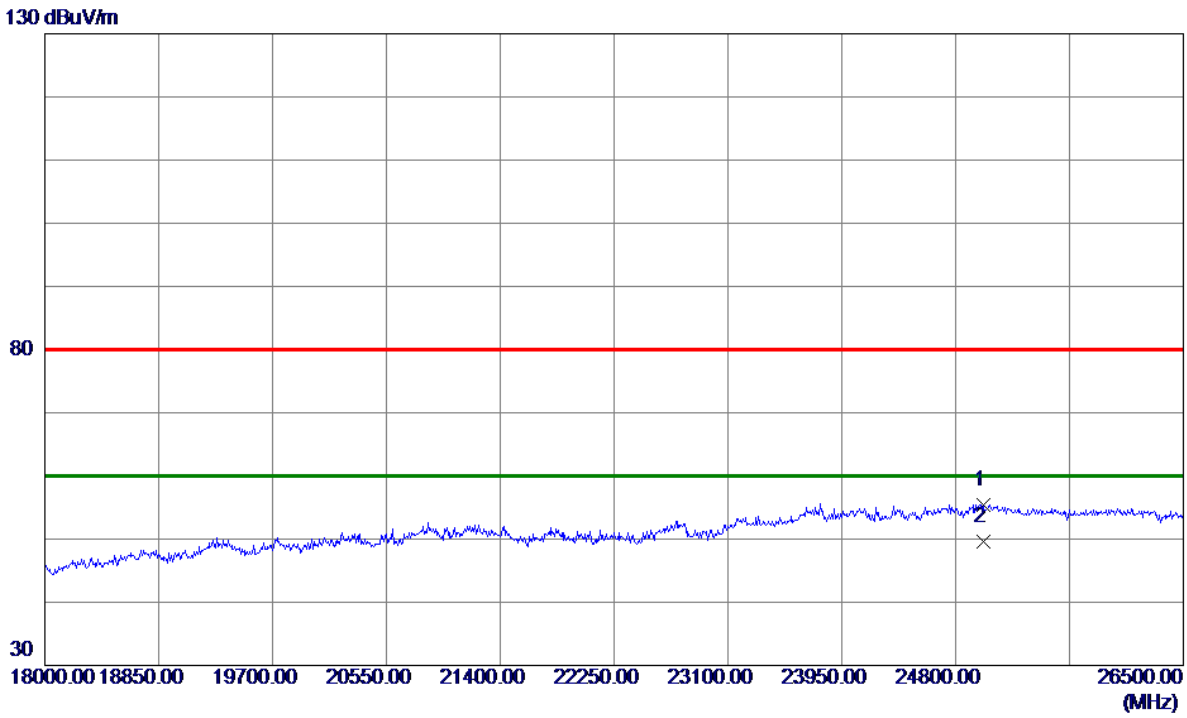

No.	Freq. MHz	Reading Level dBuV/m	Correct Factor dB	Measure ment dBuV/m	Limit dBuV/m	Margin dB	Detector	Comment
1	25004.0000	24.87	30.53	55.40	80.00	-24.60	Peak	
2 *	25004.0000	18.98	30.53	49.51	60.00	-10.49	AVG	

**REMARKS:**

- (1) Measurement Value = Reading Level + Correct Factor.
- (2) Margin Level = Measurement Value - Limit Value.

**APPENDIX E - BANDWIDTH**

Test Mode: CH00, CH19 , CH39 - 1Mbps

Channel	Frequency (MHz)	6 dB Bandwidth (MHz)	99 % Emission Bandwidth (MHz)	6 dB Bandwidth Min. Limit (kHz)	Test Result
00	2402	0.584	1.052	500	Pass
19	2440	0.586	1.048	500	Pass
39	2480	0.580	1.052	500	Pass

**CH00**

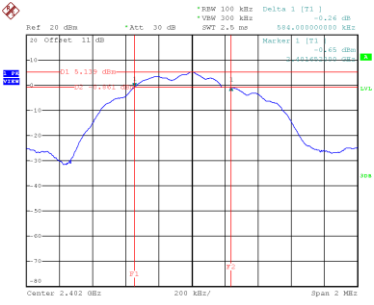

Date: 19\_DEC.2020 18:35:40

**CH19**

**6 dB Bandwidth**

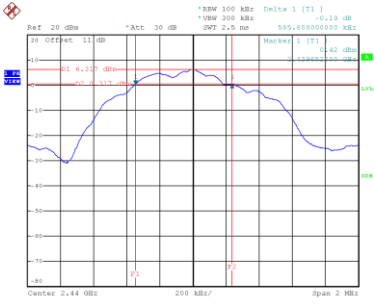

Date: 19\_DEC.2020 18:39:05

**CH39**

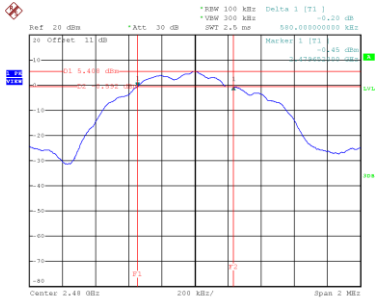

Date: 19\_DEC.2020 18:47:08

**99 % Emission Bandwidth**

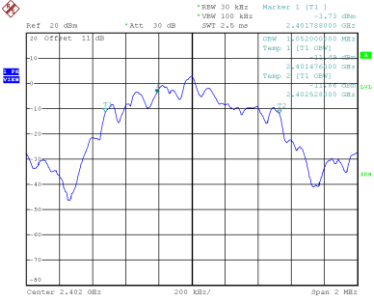

Date: 19\_DEC.2020 18:35:05

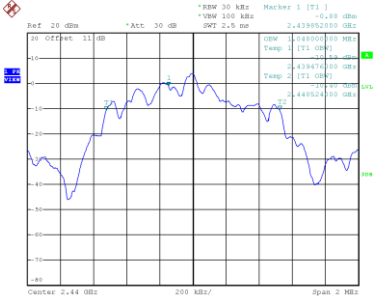

Date: 19\_DEC.2020 18:39:20

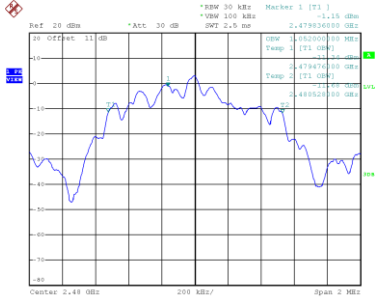

Date: 19\_DEC.2020 18:47:24



Test Mode: CH00, CH19 , CH39 - 2Mbps

Channel	Frequency (MHz)	6 dB Bandwidth (MHz)	99 % Emission Bandwidth (MHz)	6 dB Bandwidth Min. Limit (kHz)	Test Result
00	2402	0.703	2.080	500	Pass
19	2440	0.704	2.080	500	Pass
39	2480	0.922	2.080	500	Pass

**CH00**

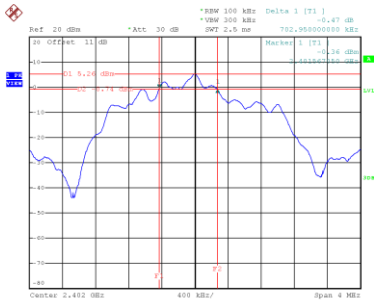

Date: 29\_DEC.2020 09:19:52

**CH19**  
6 dB Bandwidth

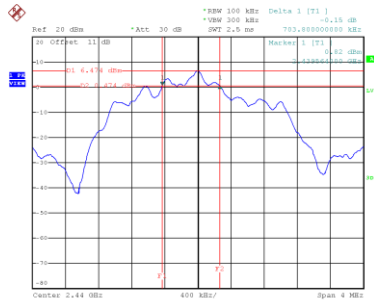

Date: 29\_DEC.2020 09:12:104

**CH39**

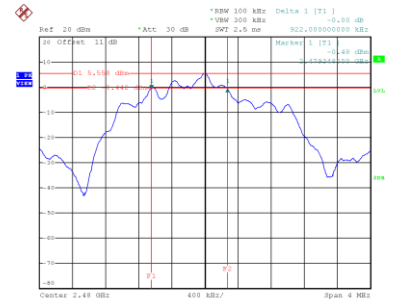

Date: 29\_DEC.2020 09:12:6154

**99 % Emission Bandwidth**

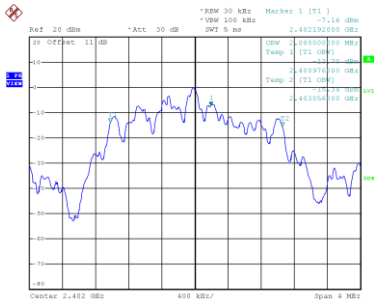

Date: 29\_DEC.2020 09:19:15

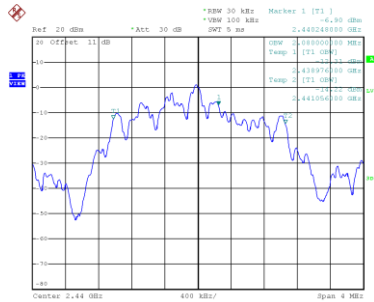

Date: 29\_DEC.2020 09:12:420

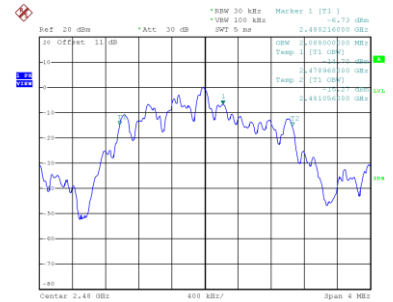

Date: 29\_DEC.2020 09:12:7110

**APPENDIX F - MAXIMUM OUTPUT POWER**

Test Mode : CH00, CH19 , CH39 - 1Mbps

Frequency (MHz)	Output Power (dBm)	Output Power (W)	Max. Limit (dBm)	Max. Limit (W)	Test Result
2402	5.39	0.0035	30.00	1.00	Pass
2440	6.55	0.0045	30.00	1.00	Pass
2480	5.67	0.0037	30.00	1.00	Pass

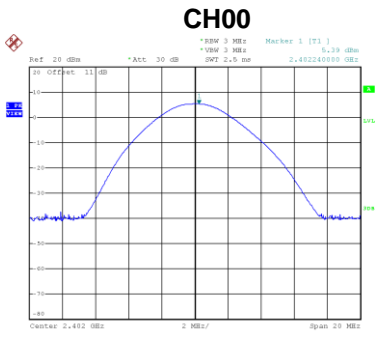

Date: 19\_DEC.2020 18:36:25

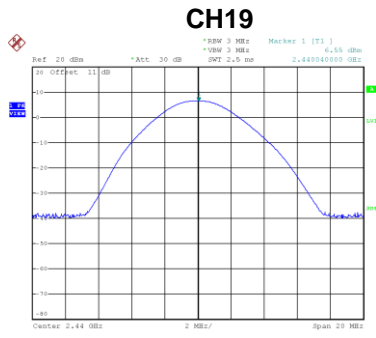

Date: 19\_DEC.2020 18:40:15

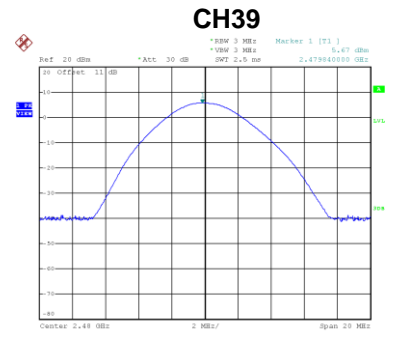

Date: 19\_DEC.2020 18:48:18

Test Mode : CH00, CH19 , CH39 - 2Mbps

Frequency (MHz)	Output Power (dBm)	Output Power (W)	Max. Limit (dBm)	Max. Limit (W)	Test Result
2402	5.94	0.0039	30.00	1.00	Pass
2440	7.13	0.0052	30.00	1.00	Pass
2480	6.19	0.0042	30.00	1.00	Pass

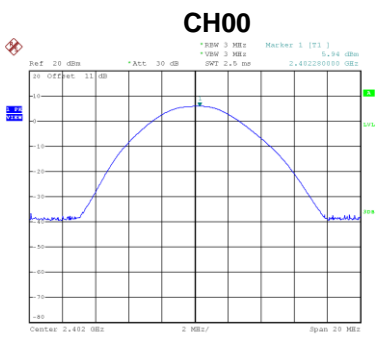

Date: 29\_DEC.2020 09:22:00

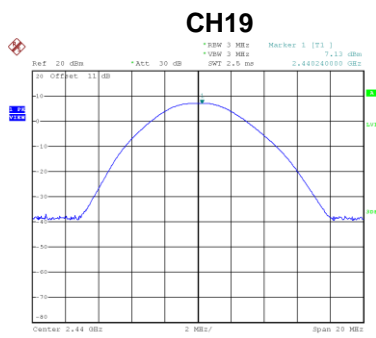

Date: 29\_DEC.2020 09:25:57

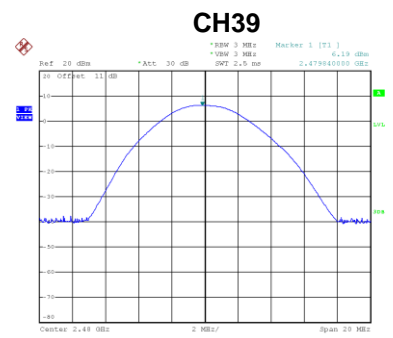

Date: 29\_DEC.2020 09:27:54

**APPENDIX G - CONDUCTED SPURIOUS EMISSION**

Test Mode : CH00, CH19 , CH39 - 1Mbps

### Bandedge CH00 (Lower)

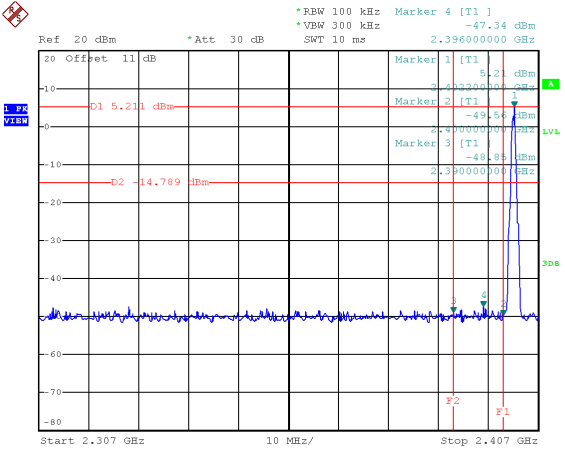

Date: 19.DEC.2020 18:35:47

### Bandedge CH39 (Upper)

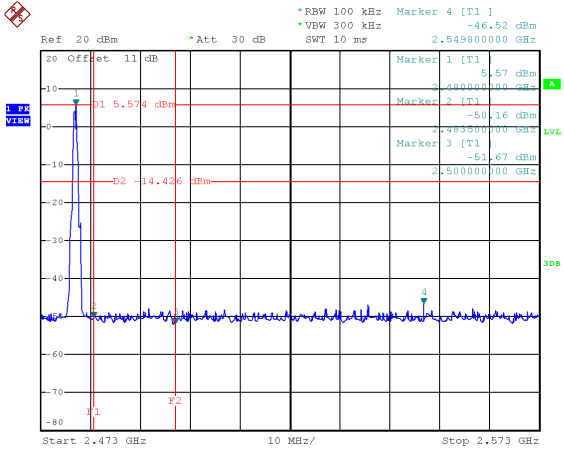

Date: 19.DEC.2020 18:47:31

### CH00 – 10th Harmonic of the fundamental frequency

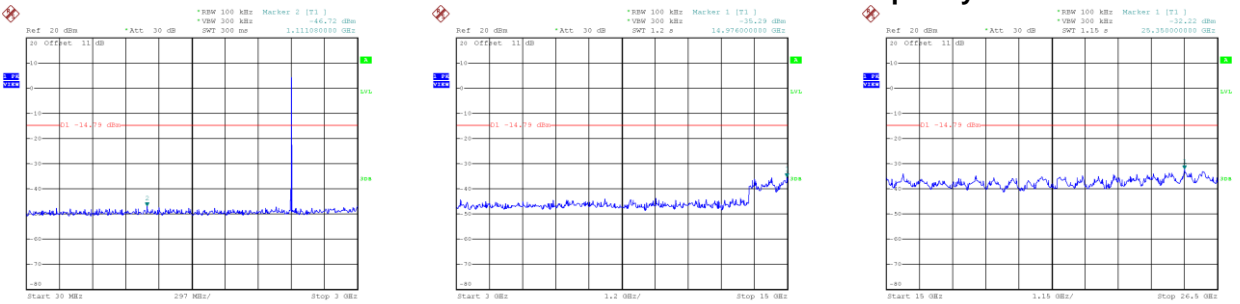

Date: 19.DEC.2020 18:35:59

Date: 19.DEC.2020 18:36:07

Date: 19.DEC.2020 18:36:13

### CH19 – 10th Harmonic of the fundamental frequency

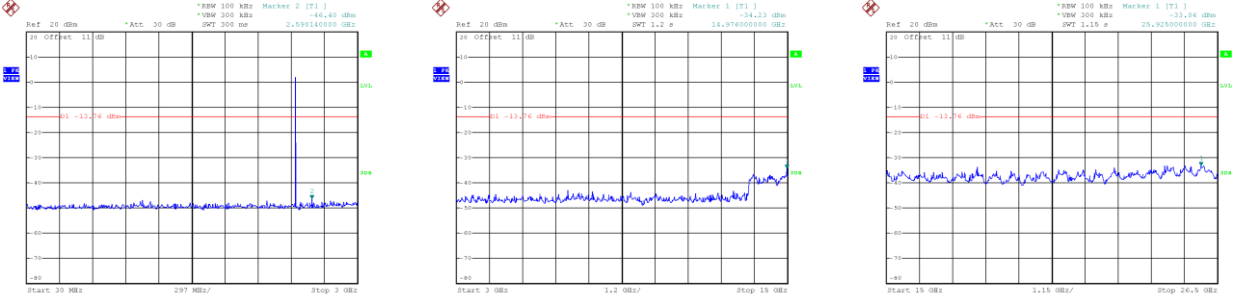

Date: 19.DEC.2020 18:39:40

Date: 19.DEC.2020 18:39:47

Date: 19.DEC.2020 18:39:54

### CH39 – 10th Harmonic of the fundamental frequency

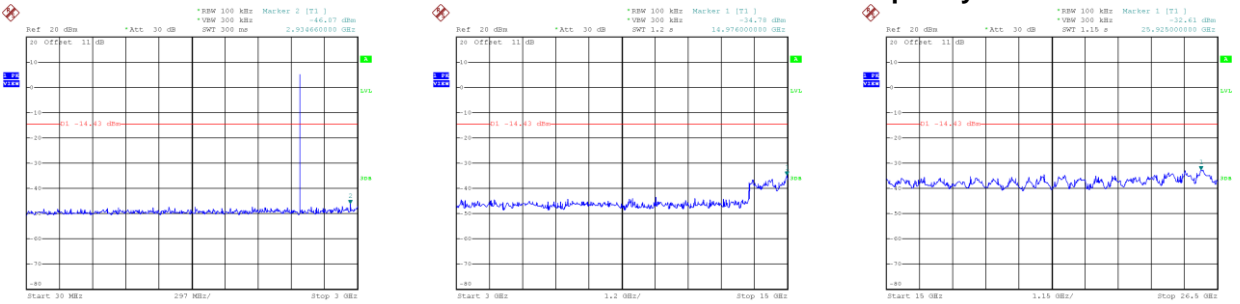

Date: 19.DEC.2020 18:47:43

Date: 19.DEC.2020 18:47:50

Date: 19.DEC.2020 18:47:57

Test Mode : CH00, CH19 , CH39 - 2Mbps

### Bandedge CH00 (Lower)

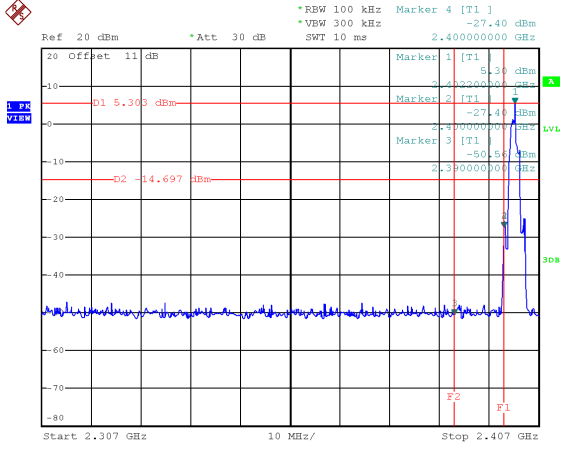

### Bandedge CH39 (Upper)

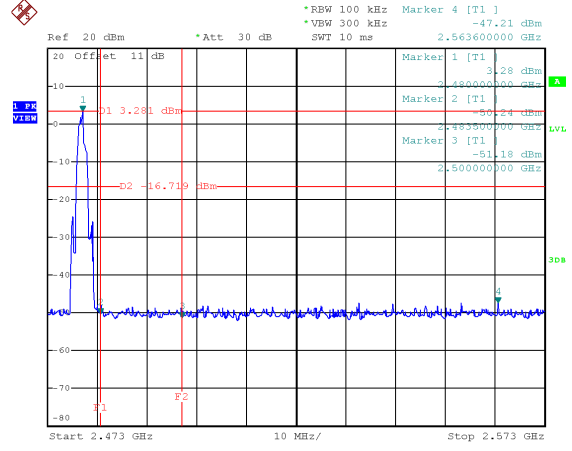

Date: 29.DEC.2020 09:20:41

Date: 29.DEC.2020 09:27:17

### CH00 – 10th Harmonic of the fundamental frequency

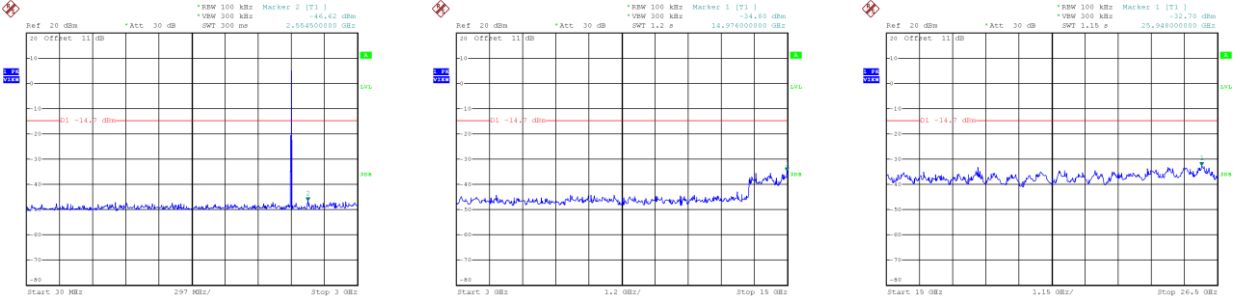

Date: 29.DEC.2020 09:20:58

Date: 29.DEC.2020 09:21:05

Date: 29.DEC.2020 09:21:12

### CH19 – 10th Harmonic of the fundamental frequency

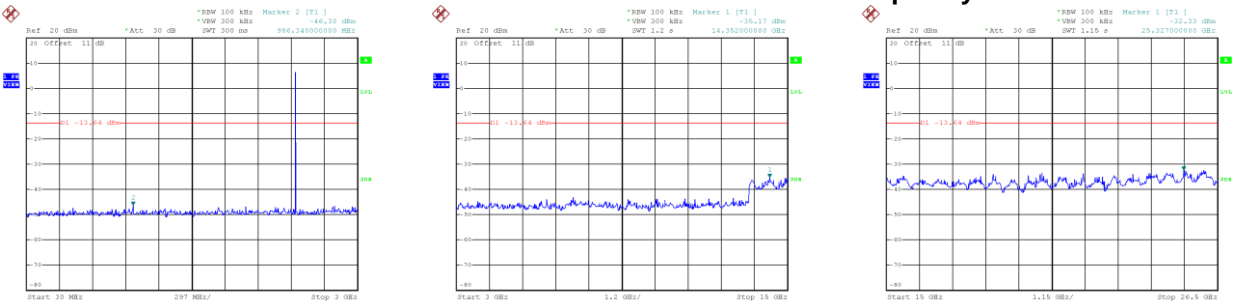

Date: 29.DEC.2020 09:24:39

Date: 29.DEC.2020 09:24:46

Date: 29.DEC.2020 09:24:53

### CH39 – 10th Harmonic of the fundamental frequency

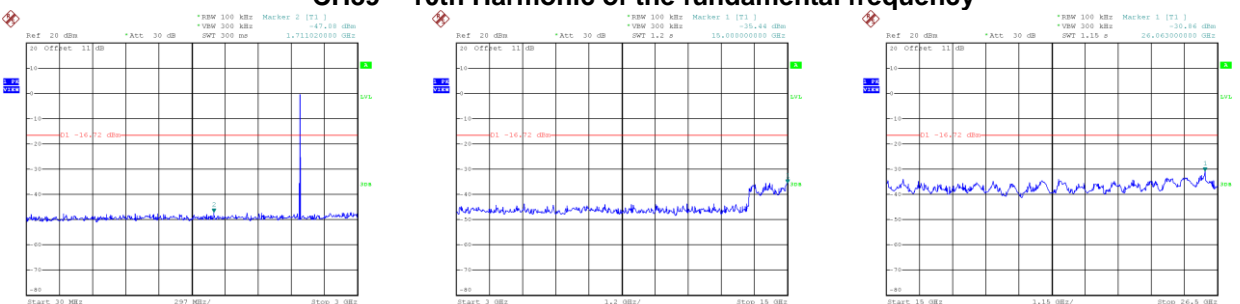

Date: 29.DEC.2020 09:27:29

Date: 29.DEC.2020 09:27:36

Date: 29.DEC.2020 09:27:43

## APPENDIX H - POWER SPECTRAL DENSITY

Test Mode: CH00, CH19 , CH39 - 1Mbps

Channel	Frequency (MHz)	Power Spectral Density (dBm/3 kHz)	Max. Limit (dBm/3 kHz)	Test Result
00	2402	-11.63	8.00	Pass
19	2440	-10.41	8.00	Pass
39	2480	-11.26	8.00	Pass

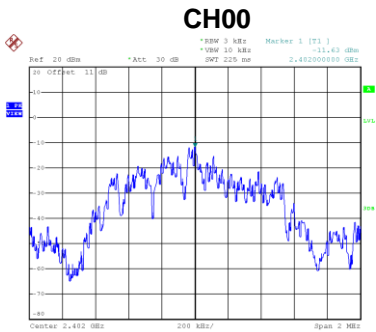

Date: 19\_DEC.2020 18:36:19

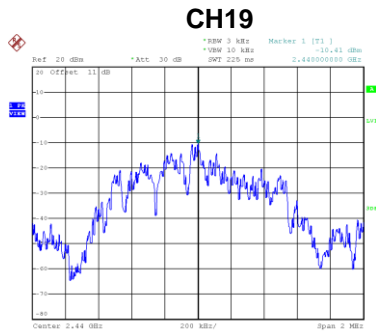

Date: 19\_DEC.2020 18:39:59

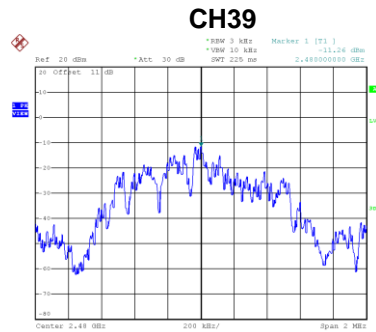

Date: 19\_DEC.2020 18:49:10

Test Mode: CH00, CH19 , CH39 - 2Mbps

Channel	Frequency (MHz)	Power Spectral Density (dBm/3 kHz)	Max. Limit (dBm/3 kHz)	Test Result
00	2402	-14.79	8.00	Pass
19	2440	-13.58	8.00	Pass
39	2480	-14.52	8.00	Pass

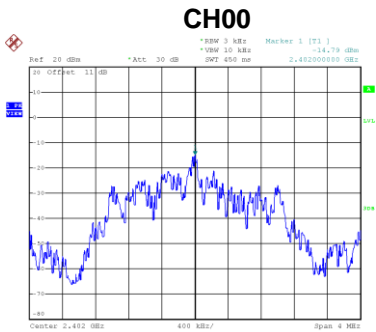

Date: 29\_DEC.2020 09:21:45

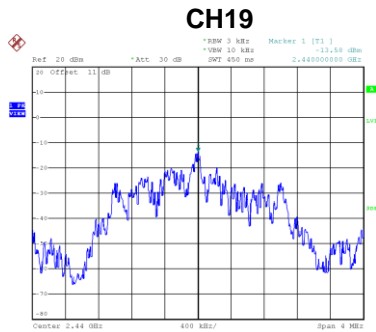

Date: 29\_DEC.2020 09:25:42

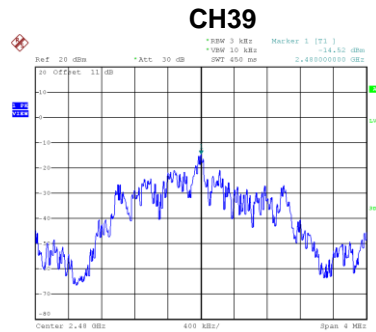

Date: 29\_DEC.2020 09:28:12

End of Test Report