

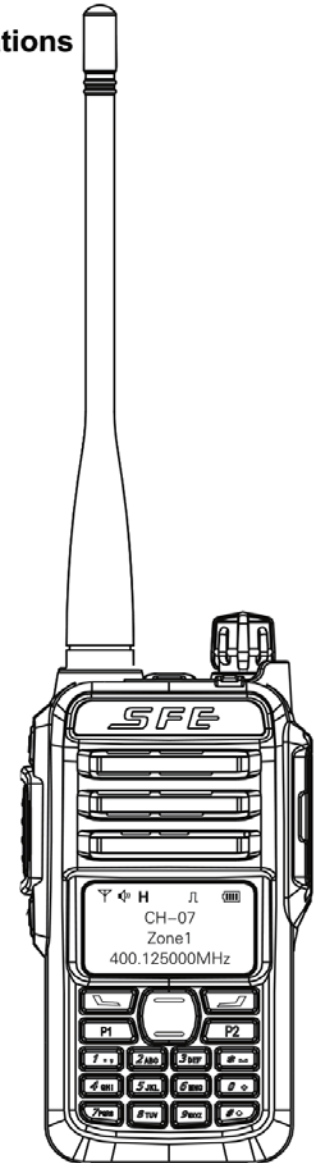

—Rugged-reliable Two-way Communications



SD850

Digital Portable Radio

USER MANUAL

Quanzhou SFE Electronic Technology Co.,Ltd

Add: No.35,Yangming Street,Shuangyang,Luojiang District,
Quanzhou City,Fujian Province 362012,China

Web: www.sfecom.cn

Introduction

Thank you for purchasing this SFE two-way radio, a truly versatile, professional and durable radio that will provide reliable, high quality communication, even under harsh and demanding conditions. Before operation and to obtain the best performance, please read this manual carefully to become familiar with the radio's features and uses.



Contents

1. Safety Information	1
2. Supplied Accessories	2
3. Battery Information	3
■ Caution	3
■ Battery Charging	3
4. Accessories Installation	4-6
■ Installing and Removing the Battery Pack	4
■ Installing and Removing the Antenna	5
■ Installing the Earpiece	6
■ Installing/Removing the Belt Clip	6
5. Getting Acquainted	7-8
■ Radio Diagram	7
■ LCD Display	8
6. Key Assignment	9-11
■ Side Key Setting	9-11
7. Function and Operation	11-16
■ Basic Settings	11-15
● Radio ID	11
● Language Selection	11
● SQ(Squelch Level)	11
● Battery Save	11
● Time Out Timer(TOT)	11
● VOX Function	12
● Alert Tone Settings	12
● Channel Information	12
● Digital Contact	15

Contents

● RX Group List	15
● Scan List	15
■ Basic Operation	16
● Power ON/OFF	16
● Adjusting the Volume	16
● Manual Dialing	16
■ Menu Operation	16-29
● SMS(Message)	17-21
● Digital Contacts	22
◆ Place a Temporary Call	22
◆ Check Contacts Details	22
◆ Add Contacts	22-23
◆ Edit Contacts	23
◆ Send SMS to Existing Contacts	23-24
◆ Setup Default Contacts	24
◆ Call Log	24
◆ Scan Settings	25
◆ Zone Select	25
● Settings	25
◆ Power Output	25-26
◆ Squelch Level	26
◆ Battery Save Mode	26
◆ TOT(Time-out-timer)	26
◆ VOX Level	27
◆ VOX Delay	27
◆ Alert Tone Set	27

◆ Backlight Level	27-28
◆ Backlight Delay	28
◆ Keypad Lock	28
◆ Language Set	28
◆ Slot Set	28-29
● Own Info(My Radio Information)	29
8. Troubleshooting and Maintenance	30
● Troubleshooting	30
● Maintenance and Cleaning	30
9. Specifications	31
10. Sub-tone Tables	32
11. Warranty and Service	33

Please read the following information carefully to become familiar with your new SFE two-way radio:

- ◆ Do not attempt to repair, disassemble or re-assemble the radio. Repair should only be carried out by a qualified Radio Engineer.
- ◆ In order to avoid electromagnetic interference, please turn off the radio in any areas where radio transmissions are not permitted e.g. Hospitals, Aircraft, etc.
- ◆ Do not place a radio in any area over, or in the deployment area of an Air Bag within a vehicle.
- ◆ Never operate the radio in potentially flammable and explosive atmospheres.
- ◆ Never replace or charge batteries in potentially flammable and explosive atmospheres.
- ◆ Do not operate the radio if its antenna is damaged.
- ◆ Do not expose the radio to long periods of direct sunlight, for example on the dashboard of a vehicle or close to heating appliances.
- ◆ When using your radio, try to keep it vertical and at a distance of 5~10cm from your mouth.
- ◆ Keep a distance of at least 2.5cm between the antenna and your head and body when transmitting.

Supplied Accessories

Please open the box carefully and check that the following items are included. If you find any items are missing or have been damaged during shipment, please contact your SFE dealer immediately.

Equipment and Accessories Supplied:

ITEM	QUANTITY
Two-way Radio Body	x1
Li-Ion Battery	x1
AC Adaptor	x1
Intelligent Charger Pod	x1
Antenna	x1
Wrist Strap	x1
Belt Clip	x1
User Manual	x1

Battery information

Caution

In order to avoid damage to the battery, only use the charger provided. The supplied charger is an 'intelligent' charger and has automatic and over-protect functions built in. Do not short-circuit the battery pack or dispose of in fire. The optimal charging temperature is between 10°C and 35°C. When charging in temperatures below 10°C there may be a leakage of electrolyte which will damage the battery. If charging above 35°C, battery performance will be reduced.

Battery Charging

Connect the AC adaptor to the charger. The red LED will light up. Place the battery or the radio with battery attached into the charger (check that the battery is properly in place). The red light will begin to flash - indicating that charging is in progress. The LED will turn green when the battery is fully charged. (see illustration 1)

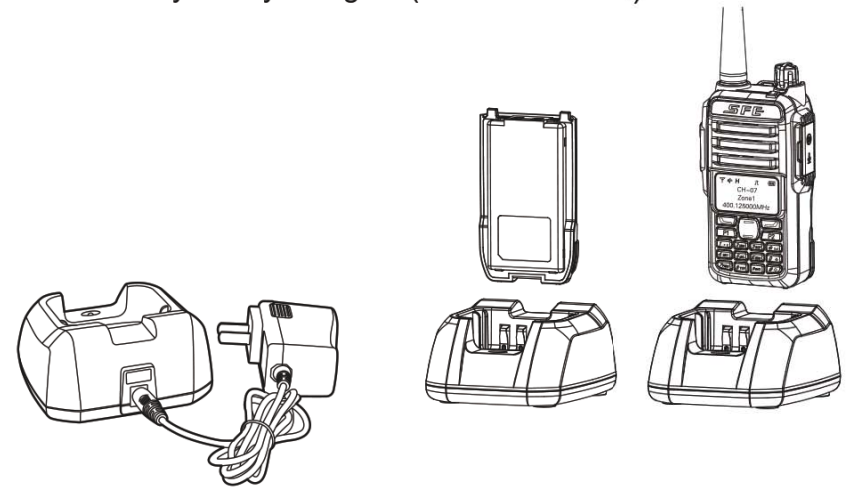

Illustration 1

Accessories Installation

Installing and Removing the Battery Pack

Place the rechargeable battery pack onto the back of the radio, it will only fit in one way. Snap the battery release clip until it clicks. Be sure the battery pack fits tightly against the body of the radio.

(See illustration 2)

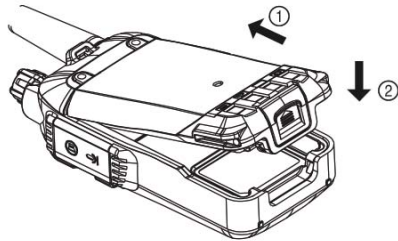

Illustration 2

To remove the battery pack, snap the battery release clip out and remove the battery pack from the body of the radio. (See illustration 3)

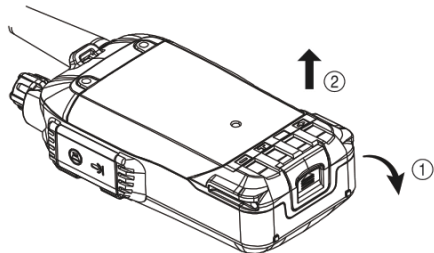

Illustration 3

Accessories Installation

Installing/Removing the Antenna

Screw the antenna into the connector on the top of the transceiver by holding the antenna at its base and turning it clockwise until secure.

(See illustration 4)

To remove the antenna, hold the antenna at its base and turning it counter-clockwise until it be released. (See illustration 5)

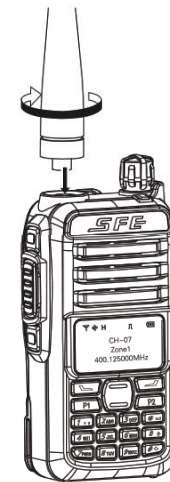

Illustration 4

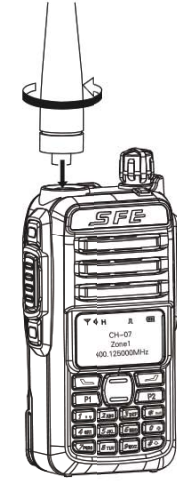

Illustration 5

Accessories Installation

Installing the Earpiece

First release the Speak/microphone cover then insert the speaker/microphone plugs into the SP/MIC jacks.

(See illustration 6)

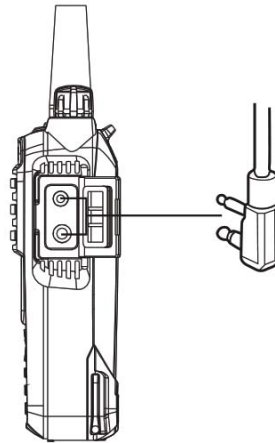

Illustration 6

Installing/Removing the Belt Clip

Attach the belt clip using the two supplied screws. (See illustration 7)

To remove the beltclip, release the screws on the belt clip.

(See illustration 8)

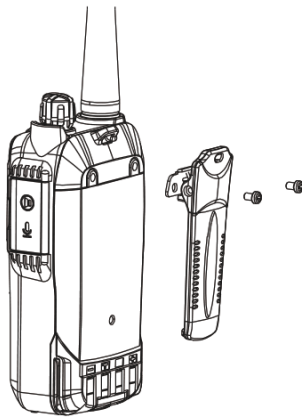

Illustration 7

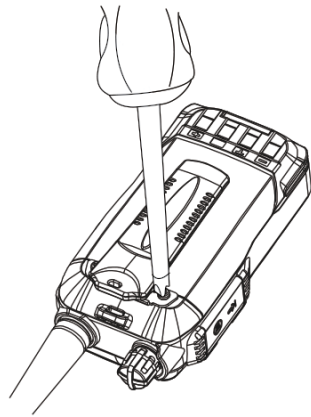
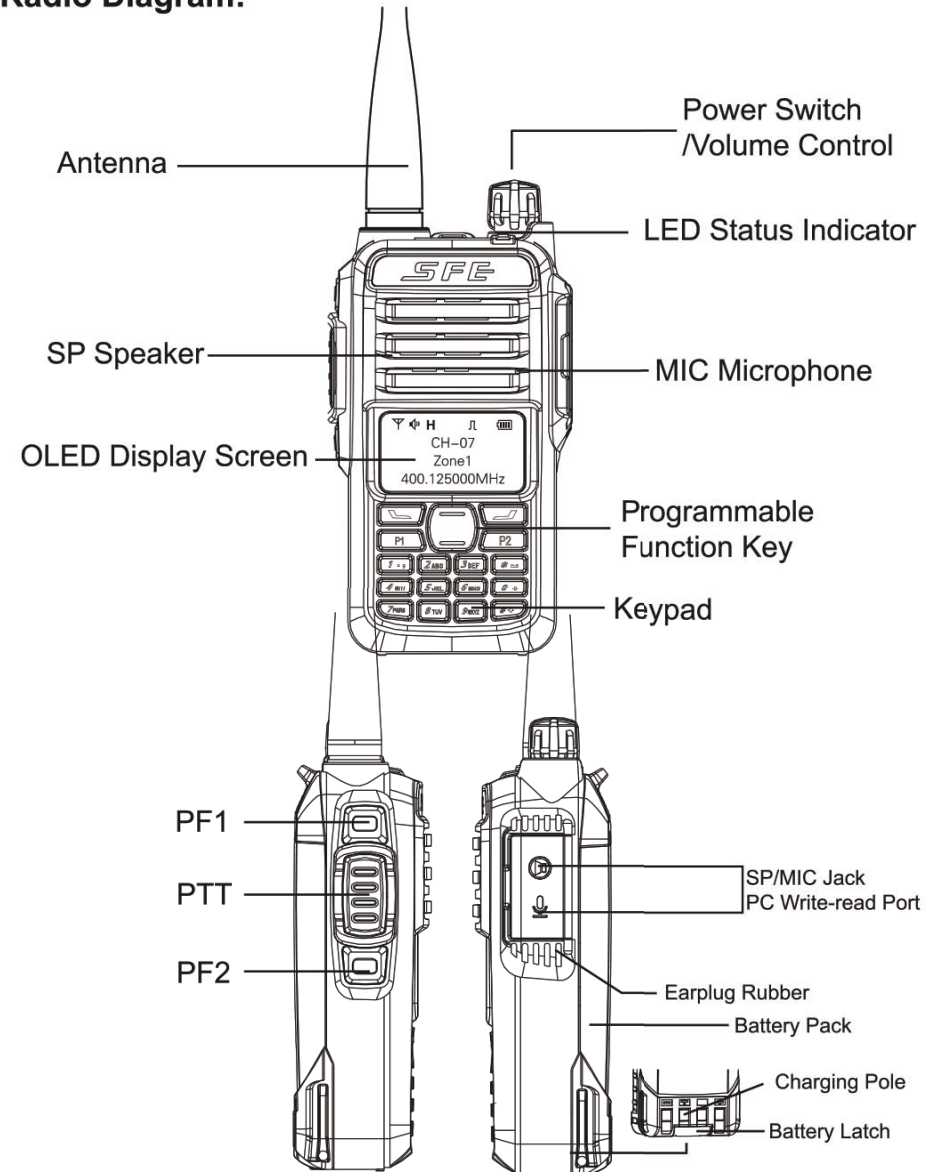

Illustration 8

Getting Acquainted

Radio Diagram:



LCD Display

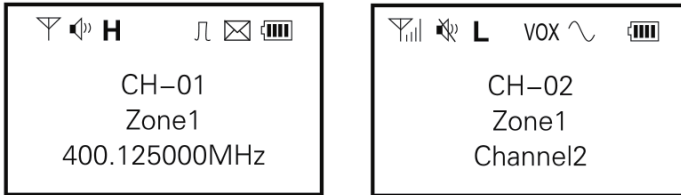

	RX Signal Strength Indicator
	Beep Tone ON/OFF
H	High Power
VOX	VOX ON
	Channel Mode (Digital/Analog)
	Unread SMS
	Remaining Battery
CH-01/CH-02	Channel Number
Zone1/Zone2	Zone Name
Channel1	Channel Name
400.025000MHz	Channel Frequency

Side Key Setting

The [PF1] and [PF2] can be re-assigned to any of the following functions by programming, and customers can select “short press” or “long press” (with long press duration 0.5-3s, default on 1s) as per your request.

- None
- Zone Up
- Zone Down
- Power Adjustment
- Squelch OFF
- Monitor
- Talk Around
- Scan ON/OFF
- VOX ON/OFF
- Local Alarm
- Remote Alarm
- Remote Monitor
- Remote Stun
- Remote Kill
- Remote Activation

Note: [PF1] and [PF2] can have the same key assignments.

None: No functions

Zone Up: Switch to the previous zone (Range: Zone 1 – Zone 64)

Zone Down: Switch to the next zone (Range: Zone 1 – Zone 64)

Power Adjustment: Switch between HIGH/LOW power output.

Squelch OFF: In analog mode, squelch will be ON after press **【PF1】** or **【PF2】**, press again to exit.

Note: This function is invalid in digital mode.

Monitor: In analog mode, press pre-programmed monitor key to open signaling squelch so that audio conversation can be heard when the signal is weak.

Note: this function is invalid in digital mode.

Talk Around: Press this programmed key, the RX frequency will be used in place of the TX frequency when transmitting.

Note: After Talk Around function is activated, both receiving frequency and receiving signaling will be used in place of the transmitting frequency and signaling when transmitting.

Scan ON/OFF: Press the programmed Scan key to initiate radio scanning from the current channel, and scanning ascends through

Key Assignment

the channel numbers in scan list. The green/blue LED flashes when scanning proceeds, and solidly glows when a signal is received with signaling match on a channel. Press the scan key again to exit radio scanning. The scan status will not be memorized after the radio being restart.

VOX ON/OFF: After inserted with earpiece, press the programmed VOX ON/OFF key to activate or disable VOX function.

Note: This function is invalid without being inserted with an earpiece.

Local Alarm: Press the programmed key to activate/disable local alarm function, radio will emit on-site alarm tone after activated, this function is helpful for emergency rescue.

Remote Alarm: Press the programmed key to activate remote alarm function in the pre-defined radio, once remote alarm function activated successfully the calling radio will receive acknowledgement message sent from the pre-defined radio. Note: This function is valid only in digital mode.

Remote Monitor: Press the programmed key to activate remote monitor function in the pre-defined radio, once remote monitor function activated successfully the calling radio will be able to monitor the conversation in the pre-defined radio.

Note: This function is valid only in digital mode.

Remote Stun: Press the programmed key to remote stun the pre-defined radio by sending remote stun code. Only receiving is allowed for a stunned radio(Transmitting is prohibited).

Note: This function is valid only in digital mode.

Remote Kill: Press the programmed key to remote kill the pre-defined radio by sending remote kill code. Transmitting and receiving are prohibited for a killed radio, and can be revived only by PC software

Key Assignment/ Function and Operation

programming with revived code.

Note: This function is valid only in digital mode.

Remote Activation: Press the programmed key to remote revive the pre-defined radio having been stunned by sending remote revive code.

Note: This function is valid only in digital mode.

Basic Setting

Radio ID

Each radio can be assigned with an ID number, which is useful and can be identified by other users to place an individual call/group call or to send text info etc. ID Range: 1-16776415.

Noted: This function is valid only in digital mode.

Language Selection

Users can select English or Chinese as display language and voice prompt language.

SQ (Squelch Level)

Squelch level can be programmed from level 0 to level 9, receiving sensitivity is the lowest when set in level 9.

Battery Save

If this function is programmed by your dealer, the transceiver will automatically switch to battery save mode when there is no receiving and no operation for more than 10 seconds. When the transceiver receives an incoming signal or is used to transmit, the battery save mode switch off automatically. Battery Save can be programmed ON/OFF by PC software programming.

Time-out Timer (TOT)

The purpose of the Time-out-Timer is to prevent any caller from using

Function and Operation

a channel for an extended period and avoid any damage caused by long time transmission. Once a continuous transmission exceeds the preset time(programmable by dealer), the transceiver will automatically stop transmitting and emit a warning tone until the PTT is released.

Time-out Timer range: 30-600s, steps: 30s, default: 180s

VOX Function

VOX can be programmed ON/OFF by PC software programming or activated/disabled by pre-programmed key, VOX ON allow users to place a voice-activated hands-free call on the pre-programmed channels. Whenever microphone detect voice, the transceiver will automatically transmit and stop transmitting when voice disappear, or pre-programmed TOT time expires.

VOX Level Range: 0-9

VOX Delay Time: 1-4s

Alert Tone Settings

1. Power ON Tone: ON/OFF selective, transceiver will emit tone "Deng Deng Deng.." when switched ON/OFF;
2. Lower Battery Alert Tone: ON/OFF selective, transceiver will emit alert tone "Deng Di Deng .." if the power is lower than preset value, users should charge the battery or replace with a new battery in time, or the transceiver will stop transmitting if users continue using it.
3. Keypad Tone: ON/OFF selective.
4. Digital Calling Tone: ON/OFF selective, in digital mode transceiver will emit an alert tone "Deng" automatically once after PTT pressed, this is used to alert its in digital mode and also transmitting is ongoing.
5. Channel Voice Prompt Tone: ON/OFF selective.

Function and Operation

Channel Information

1. Zone Name

Users can input new name for zone 1 and zone 2, the name can be programmed as number, symbol, English letter and Chinese character up to 9 digits.

Users can press the corresponding button to add zone, delete zone and switch between zones.

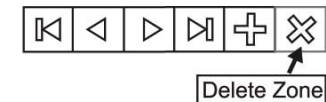
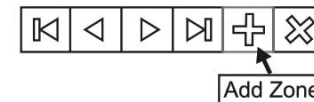

2. Channel Name

Users can input new name for each channel, the name can be programmed as number, symbol, English letter and Chinese character up to 9 digits.

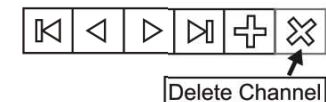
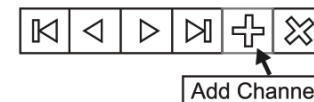

3. General Part

RX/TX Frequency: Users is able to input/change RX/TX frequency for each channel, and the frequency must be consistent with the frequency step rule and within frequency range.

Working Mode: Digital/analog mode is selective for each channel.

Output Power: High/Low power selective for each channel.

Transmitting Limit

Always Allow: Transmitting is always allowed.

Channel Free: Transmitting is allowed only when current channel is free.

CC(color code) Match: Transmitting is allowed only when color code of

Function and Operation

the incoming call is matched with the transceiver.

Bandwidth: 12.5KHz for digital channels, 25KHz/25KHz selective for analog channels.

Only RX: Only receiving is allowed for the current channel, transmitting is prohibited.

4. Digital Part

RX CC(Receiving color code): Transceiver will receive incoming call when receiving color code matched, RX CC is 0-15 selective by PC software programming.

TX CC(Transmitting color code): TX CC is 0-15 selective by PC software programming.

TX Contact(Transmitting Contact)

There are maximum 128 transmitting contacts for users to select, each transmitting contact can be programmed as individual call, group call or all call.

Dual Capacity Direct Mode (DCDM)

Dual Capacity Direct Mode (DCDM) feature supports two simultaneous subscriber transmissions within a 12.5 kHz channel bandwidth for Direct Mode transmissions. The radios within the same group must use the same timeslot so that the group using timeslot 1 does not interfere with the group using timeslot. When a 12.5 kHz RF channel is configured for dual capacity direct mode, both timeslots are available for independent and simultaneous radio call conversations.

RX Group List: This option is to configure receiving channel list to the current channel. When matched calling group ID from the list detected, the receiving transceiver will open the speaker to receive audio.

Noted: This function is valid only in digital mode.

Function and Operation

Voice Encryption: This function allows user to program voice encryption code to the current channel, conversation is allowed between radios only when same encryption code are programmed.

Code range: OFF, 0 – 65535.

Time Slot Selection: This function is used for dual capacity direct mode(DCDM) and working through repeater, each digital channel can be configure with time slot 1 or time slot 2.

5. Analog Part

RX Sub-tone Type/TX Sub-tone Type: None/CTCSS/DCS/Reverse DCS selective

Digital Contact (Valid only for digital channel)

Individual call/Group call/All call are available for selection, the transceiver supports maximum 128 digital contacts.

This allows user to add digital contacts and input Alias containing numbers, symbols, letters and Chinese characters up to 9 bits. Range of numbers: 1-16776415.

RX Group List (Valid only for digital channel)

This allows user to create/delete receiving group list by adding/deleting members(contacts), group list name can be changed to an Alias (up to 13 bits containing numbers, symbols, letters and Chinese characters). The transceiver supports maximum 32 receiving group lists and maximum 10 members to each group call list.

Scan List

This function allows user to create/delete scan list by adding/deleting channels to be monitored, scan list name can be changed to an Alias (up to 11 bits containing numbers, symbols, letters and Chinese characters). The transceiver supports maximum 8 scan lists and maximum 16 channels to each scan list.

Function and Operation

Basic Operation

Power ON/OFF

Turn the On/Off/Volume knob clockwise to switch the radio ON. Turn the On/Off/Volume knob counter-clockwise to switch the radio OFF.

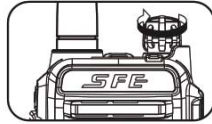

Adjusting the Volume

Rotate the On/Off/volume control clockwise or anti-clockwise to adjust the volume as required. Clockwise increases the volume and anti-clockwise decreases it.

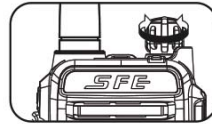





Manual Dialing

In digital channel, press the desired calling ID via keypad, the radio will make individual call after pressing PTT.

ID range: 1-16776415.

Note: If ID number is out of the range, transceiver will emit an alert tone to warn that transmitting is prohibited.

Menu Operation

Operation Steps: Press  to enter menu setting, press  up /down to choose desired item menu, press  to confirm or press  to go back to previous menu or exit menu setting.

In digital channel, the menu includes SMS(message), Contacts, Call Log, Scan Settings, Zone Select and settings.





In analog channel, the menu includes Scan Settings, Zone Select and Settings.

Function and Operation

SMS(Message)







In digital channel, the transceiver is able to send and receive message. The transceiver will display "Rec SMS" and emit an alert tone when message received, users can look the message or go back, message icon will display on the up side of the screen if there is an unread message.

Message Edition Instructions:





- Icon for message edition: "ab" represents lowercase letter, "AB" represents capital letter and "12" represents numeric for keypad input.
- Keypad input definition: Press  to choose/change input method, press  to move the cursor to the left/right(each press move the cursor by one position), press  to enter punctuation selection, press  to confirm and press  to delete characters.

Inbox(Max 20 SMS store capacity)

SMS Check:

- In digital channel, press  to enter menu, press  to choose SMS, press  to confirm.
- Press  to choose Inbox and press  to enter Inbox.
- Press  to choose desired SMS.
- Press  to confirm and read the message.

SMS Reply:

- In digital channel, press  to enter menu, press  to choose SMS, press  to confirm.
- Press  to choose Inbox and press  to enter Inbox.