



Report No.: EA22010093F00101

1 of 21

**ELECTROMAGNETIC EMISSIONS COMPLIANCE
REPORT UNINTENTIONAL RADIATORS CERTIFICATION TO
FCC PART 15 SUBPART B REQUIREMENT**

for

LED Ceiling Light

Model No.: PLU01R-1528T-YX, 15FLPR-SPX-XXXXXX
(‘XY’, ‘XXXXXX’ are variables, please refer to page 6 for specific meanings)

Trademark:  

FCC ID: 2AYFP-PLU01R-15

Report No.: EA22010093F00101

Issue Date: Jan. 10, 2022

Prepared for

ARTIKA FOR LIVING INC

1756 50th avenue, Lachine, Quebec, Canada, H8T 2V5

Prepared by

Dong Guan Anci Electronic Technology Co., Ltd.

**1-2 Floor, Building A, No.11, Headquarters 2 Road, Songshan, Lake Hi-tech
Industrial Development Zone, Dongguan City, Guangdong Pr., China.**

**This report shall not be reproduced, except in full, without the written approval of
Dong Guan Anci Electronic Technology Co., Ltd.**



TABLE OF CONTENT

Test Report Description	Page
1. SUMMARY OF TEST RESULTS.....	5
2. GENERAL INFORMATION	6
2.1. Description of Device (EUT)	6
2.2. Input / Output Ports	6
2.3. Independent Operation Modes	7
2.4. Test Manner	7
2.5. Description of Test Facility	8
2.6. Test Software	8
2.7. Description of Support Device	8
2.8. Measurement Uncertainty	8
3. MEASURING DEVICE AND TEST EQUIPMENT	9
3.1. For Power Line Conducted Emission Measurement	9
3.2. For Radiated Emission Measurement	9
4. POWER LINE CONDUCTED EMISSION MEASUREMENT	10
4.1. Block Diagram of Test Setup.....	10
4.2. Limits.....	10
4.3. Test Procedure	10
4.4. Measuring Results	11
5. RADIATED EMISSION MEASUREMENT (UP TO 1GHZ)	14
5.1. Block Diagram of Test Setup.....	14
5.2. Radiated Limit	14
5.3. Test Procedure	14
5.4. Measuring Results	15
6. PHOTOGRAPHS.....	18
6.1. Photos of Conducted Emission Measurement.....	18
6.2. Photos of Radiation Emission Measurement.....	18
 APPENDIX A: Photos of EUT (10 Pages)	

TEST REPORT DESCRIPTION

Applicant : ARTIKA FOR LIVING INC
Manufacturer : ZHEJIANG TWINSEL ELECTRONIC TECHNOLOGY CO.,LTD
Factory : ZHEJIANG SHUANGYU ELECTRONIC TECHNOLOGY CO.,LTD
Trade Mark : 
EUT : LED Ceiling Light
Model No. : PLU01R-1528T-YX, 15FLPR-SPX-XXXXXX
(‘XY’, ‘XXXXXX’ are variables, please refer to page 6 for specific meanings)
Power Supply : AC 120V/60Hz

Measurement Procedure Used:

CFR 47, FCC Part 15 Subpart B
ANSI C63.4-2014

The device described above is tested by Dong Guan Anci Electronic Technology Co., Ltd. to determine the maximum emission levels emanating from the device and the severe levels of the device can endure and its performance criterion. The measurement results are contained in this test report and Dong Guan Anci Electronic Technology Co., Ltd. is assumed full of responsibility for the accuracy and completeness of these measurements. Also, this report shows that the EUT (Equipment Under Test) is technically compliant with the FCC requirements.

This report applies to above tested sample only and shall not be reproduced in part without written approval of Dong Guan Anci Electronic Technology Co., Ltd.

Date of Test : Jan. 07, 2022 to Jan. 08, 2022

Prepared by : 
Tomas Yang/Supervisor

Approved & Authorized Signer : 
Alan He/Manager

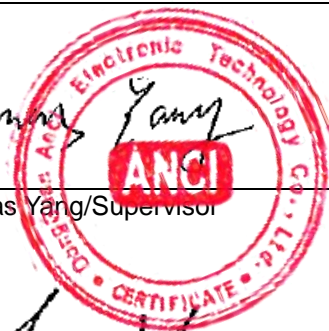



Modified Information

Version	Report No.	Revision Data	Summary
Ver.1.0	EA20010093F00101	/	Original Version

1. SUMMARY OF TEST RESULTS

EMISSION		
Description of Test Item	Standard & Limits	Results
Conducted Emission at Mains Terminals	FCC Part 15, Subpart B, Class B ANSI C63.4-2014	Pass
Radiated Emission	FCC Part 15, Subpart B, Class B ANSI C63.4-2014	Pass

2. GENERAL INFORMATION

2.1. Description of Device (EUT)

EUT : LED Ceiling Light

Model Number : PLU01R-1528T-YX, 15FLPR-SPX-XXXXXX
Please refer to the following model difference table

Test Model : PLU01R-1528T-850

Test Voltage : AC 120V/60Hz

Applicant : ARTIKA FOR LIVING INC

Address : 1756 50th avenue, Lachine, Quebec, Canada, H8T 2V5

Manufacturer : ZHEJIANG TWINSEL ELECTRONIC TECHNOLOGY CO.,LTD

Address : Tashan Industry Zone, Meilin Street, Ninghai County, Ningbo City, 315609, Zhejiang, P.R.China

Date of Received : Jan. 07, 2022

Date of Test : Jan. 07, 2022 to Jan. 08, 2022

Model difference table:

Size	Model	Customer model	Number of lamp beads	Input	Power	PCB Model	CCT
15 inch	PLU01R-1528T-YX	15FLPR-SPX-XXXXXX	85	120/60Hz, 215mA	24W	SY-2016008-F-REV 8	3000K/3500K/4000K/5000K

Note 1 : YX in the model designation could be any numbers, where each Y could be one number to indicate Color Rendering Index (like 8 represents CRI 80, 9 represents CRI 90), each X could be two numbers or two number ranges to indicate color temperature (like 30 represents 3000K, 50 represents 5000K).

Note 2: XXXXXX in the model designation could be any numbers or letters, which indicates customer code.

Note 3: all models have the same circuit principle, except that the secondary components of the circuit are different. We choose to test the maximum color temperature model.

2.2. Input / Output Ports

Port #	Name	Type*	Cable Max. >3m	Cable Shielded	Comments
0	Enclosure	N/E	--	--	None
1	AC Input port	AC	--	--	1 Port
2	USB Port	I/O	--	--	None
3	Aux Port	I/O	--	--	None
4	Earphone	I/O	--	--	None

* Note: Use abbreviations:
AC= AC Power Port

DC= DC Power Port
N/E= Non-Electrical
I/O= Signal Input or Output Port (Not Involved in Process Control)
TP= Telecommunication Ports

2.3. Independent Operation Modes

- A. On
- B. Off

2.4. Test Manner

Test Items	Test Voltage	Operation Modes	Worst case
Conducted Emission	AC 120V/60Hz	Mode A	On
Radiated Emission	AC 120V/60Hz	Mode A	On

2.5. Description of Test Facility

Site Description EMC Lab.	: Accredited by CNAS, 2017.06.26 The certificate is valid until 2022.10.28 The Laboratory has been assessed and proved to be in compliance with CNAS-CL01:2006 (identical to ISO/IEC 17025:2005) The Certificate Registration Number is L0468.
	Accredited by A2LA, 2018.03.15 The Certificate Number is 4422.01.
Name of Firm	: Dong Guan Anci Electronic Technology Co., Ltd.
Site Location	: Bldg 69, Majialong Industry Zone, Nanshan District, Shenzhen, Guangdong, China.

2.6. Test Software

Item	Software
Conducted Emission	: EZ-EMC Ver:ANCI-3A1

Radiated Emission : EZ-EMC Ver:ANCI-3A1

2.7. Description of Support Device

N/A

2.8. Measurement Uncertainty

Test Item	Uncertainty
Conducted Emission Uncertainty	: 2.96dB(9k~150kHz Conduction 1#) 2.74dB(150k-30MHz Conduction 1#)
Radiated Emission Uncertainty (3m Chamber)	: 3.78dB (30M~1GHz Polarize: H) 4.27dB (30M~1GHz Polarize: V)

3. MEASURING DEVICE AND TEST EQUIPMENT

3.1. For Power Line Conducted Emission Measurement

Item	EQUIPMENT TYPE	MFR	MODEL NUMBER	SERIAL NUMBER	Calibrated until
1.	L.I.S.N	SCHWARZBECK	NSLK 8127	8127-669	2022-05-22
2.	10 db attenuator	JFW	50FP-010-H4	4360846-427-1	2022-05-22
3.	RF Cable	N/A	N/A	2#	2022-05-22
4.	EMI Test Receiver	ROHDE&SCHWARZ	ESCI	101358	2022-05-22

3.2. For Radiated Emission Measurement

Item	Equipment	Manufacturer	Model No.	Serial No.	Calibrated until
5.	EMI Test Receiver	Rohde & Schwarz	ESPI	100502	2022-11-19
6.	Pre-Amplifier	HP	8447D	2727A06172	2022-05-22
7.	Bilog Antenna	Schwarzbeck	VULB9163	VULB9163-588	2022-05-22
8.	Loop Antenna	Schwarzbeck	FMZB 1516	1516-141	2022-05-22
9.	RF Cable	Gigalink Microwave	ZT40-2.92J-2.92 J-2m	N/A	2022-05-22
10.	RF Cable	Gigalink Microwave	ZT40-2.92J-2.92 J-0.3m	N/A	2022-05-22
11.	RF Cable	N/A	N/A	6#	2022-05-22
12.	3m Semi-anechoic Chamber	chengyu	9m*6m*6m	N/A	2022-05-22
13.	Test Software	Farad	EZ-EMC Ver:ANCI-3A1	N/A	N/A

4. POWER LINE CONDUCTED EMISSION MEASUREMENT

4.1. Block Diagram of Test Setup

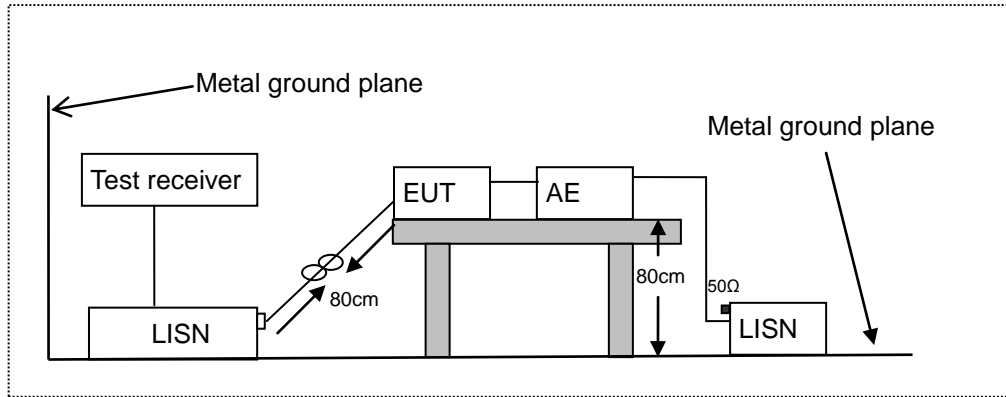

LISN: Line Impedance Stabilization Network
 AE: Associated equipment
 EUT: Equipment under test

4.2. Limits

FCC Part 15, Subpart B, Class B

Frequency (MHz)	Limit (dB μ V)	
	Quasi-peak Level	Average Level
0.15 ~ 0.50	66.0 ~ 56.0 *	56.0 ~ 46.0 *
0.50 ~ 5.00	56.0	46.0
5.00 ~ 30.00	60.0	50.0

NOTE1-The lower limit shall apply at the transition frequencies.
 NOTE2-The limit decreases linearly with the logarithm of the frequency in the range 0.15MHz to 0.50MHz.

4.3. Test Procedure

The EUT was placed on a desk 0.8 m height from the metal ground plane and 0.4 m from the conducting wall of the shielding room and it was kept at least 0.8 m from any other grounded conducting surface. The size of the table will nominally be 1.5 m x1.0 m.

The rear of the arrangement shall be flush with the back of the supporting tabletop unless that would not be possible or typical of normal use.

All units of equipment forming the system under test (includes the EUT as well as connected peripherals and associated equipment or devices) shall be arranged such that a nominal 0.1 m separation is achieved between the neighboring units.

Connect EUT to the power mains through a line impedance stabilization network (LISN). Where the mains cable supplied by the manufacturer is longer than 1 m, the excess should be folded at the centre into a bundle no longer than 0.4 m, so that its length is shortened to 1 m.

All the support units are connecting to the other LISN.

The LISN provides 50 ohm coupling impedance for the measuring instrument.

Both sides of AC line were checked for maximum conducted interference.

The frequency range from 150 kHz to 30 MHz was sweep.

Set the test-receiver system to quasi peak detect function and average detect function, and to

measure the conducted emissions values.

Test results were obtained from the following equation:

Emission Level (dB μ V) = LISN Factor (dB) + Cable Loss (dB) + Reading (dB μ V)

Margin (dB) = Emission Level (dB μ V) - Limit (dB μ V)

4.4. Measuring Results

PASS.

Please refer to following pages.

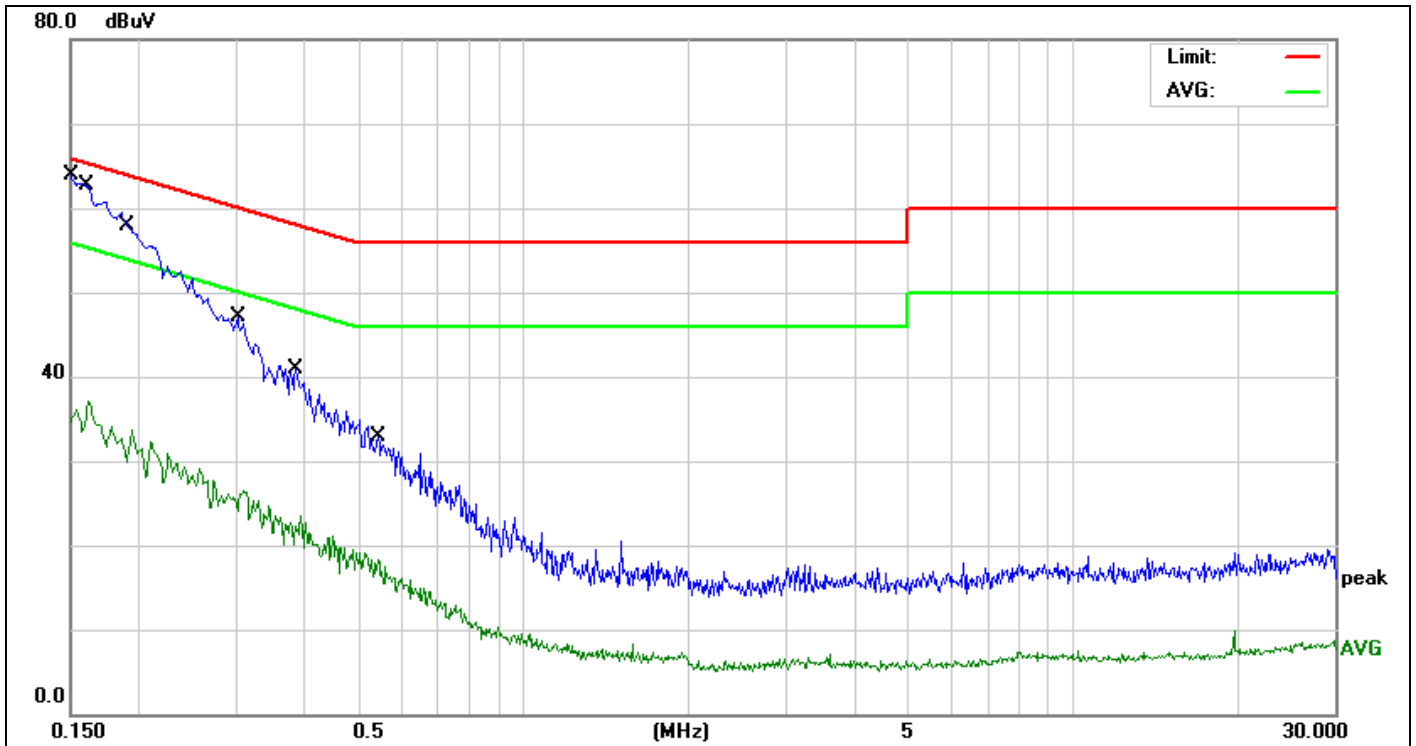

Site:	843	Phase:	L1	Temperature(C):	26(C)
Limit:	FCC PART 15B Conduction(QP)	Test Time:	2022-01-08	Humidity(%):	60%
EUT:	LED Ceiling Light	Power Rating:	AC 120V/60Hz	Test Engineer:	Jack
M/N.:	PLU01R-1528T-850	Note:			
Mode:	ON				

No.	Frequency (MHz)	Reading Level(dBuV)	Factor (dB)	Measurement(dBuV)	Limit (dBuV)	Over (dB)	Detector	Comment
1 *	0.1500	46.93	10.30	57.23	65.99	-8.76	QP	
2	0.1500	25.05	10.30	35.35	55.99	-20.64	AVG	
3	0.1620	45.04	10.30	55.34	65.36	-10.02	QP	
4	0.1620	23.86	10.30	34.16	55.36	-21.20	AVG	
5	0.1924	40.27	10.30	50.57	63.93	-13.36	QP	
6	0.1924	21.05	10.30	31.35	53.93	-22.58	AVG	
7	0.3020	28.22	10.33	38.55	60.19	-21.64	QP	
8	0.3020	14.28	10.33	24.61	50.19	-25.58	AVG	
9	0.3860	22.59	10.29	32.88	58.15	-25.27	QP	
10	0.3860	10.68	10.29	20.97	48.15	-27.18	AVG	
11	0.5460	16.47	10.35	26.82	56.00	-29.18	QP	
12	0.5460	5.85	10.35	16.20	46.00	-29.80	AVG	

*:Maximum data x:Over limit !:over margin

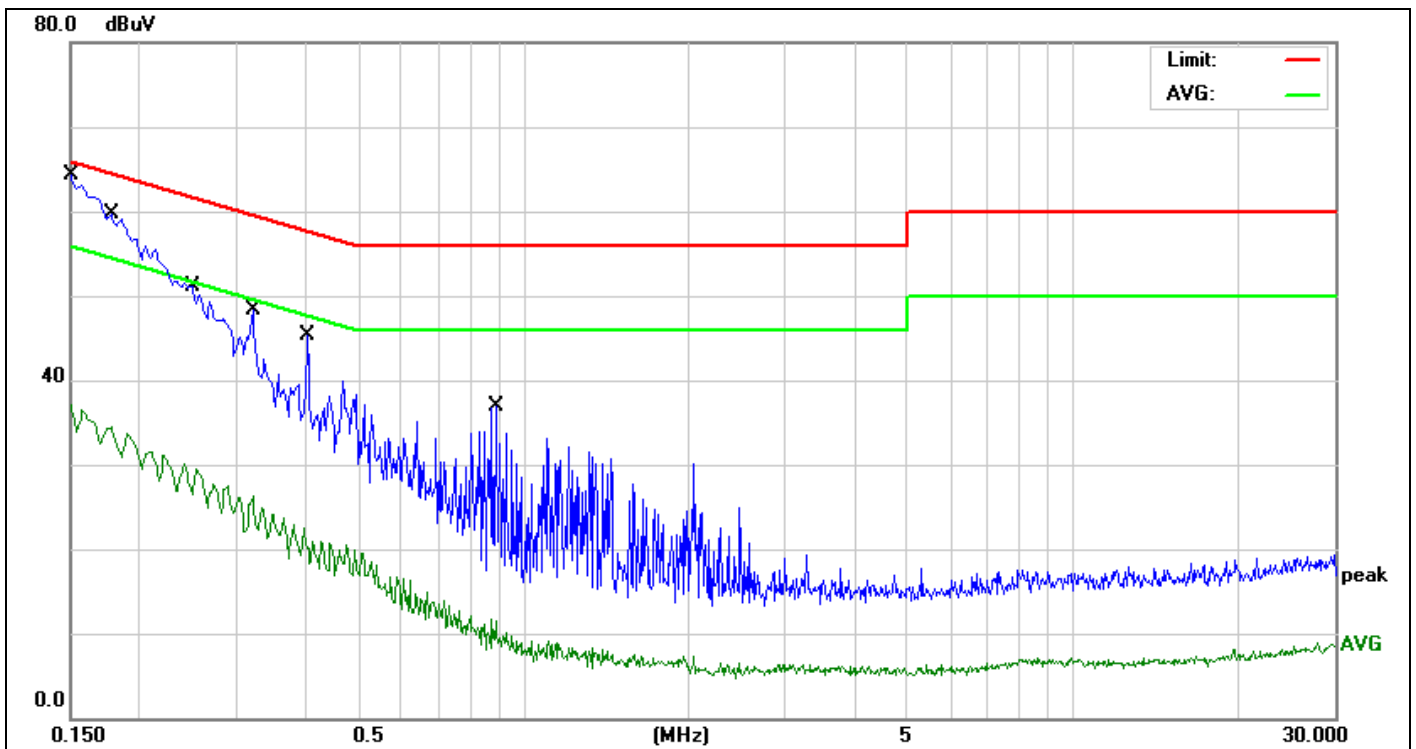

Site:	843	Phase:	N	Temperature(C):	26(C)
Limit:	FCC PART 15B Conduction(QP)	Test Time:	2022-01-08	Humidity(%):	60%
EUT:	LED Ceiling Light	Power Rating:	AC 120V/60Hz	Test Engineer:	Jack
M/N.:	PLU01R-1528T-850	Note:			
Mode:	ON				

No.	Frequency (MHz)	Reading Level(dBuV)	Factor (dB)	Measurement(dBuV)	Limit (dBuV)	Over (dB)	Detector	Comment
1 *	0.1500	46.76	10.30	57.06	65.99	-8.93	QP	
2	0.1500	25.12	10.30	35.42	55.99	-20.57	AVG	
3	0.1780	42.18	10.30	52.48	64.57	-12.09	QP	
4	0.1780	22.06	10.30	32.36	54.57	-22.21	AVG	
5	0.2500	33.08	10.31	43.39	61.75	-18.36	QP	
6	0.2500	17.30	10.31	27.61	51.75	-24.14	AVG	
7	0.3220	26.46	10.32	36.78	59.65	-22.87	QP	
8	0.3220	13.69	10.32	24.01	49.65	-25.64	AVG	
9	0.4060	21.77	10.28	32.05	57.73	-25.68	QP	
10	0.4060	9.97	10.28	20.25	47.73	-27.48	AVG	
11	0.8940	8.91	10.41	19.32	56.00	-36.68	QP	
12	0.8940	-0.94	10.41	9.47	46.00	-36.53	AVG	

*:Maximum data x:Over limit !:over margin

5. RADIATED EMISSION MEASUREMENT (UP TO 1GHz)

5.1. Block Diagram of Test Setup

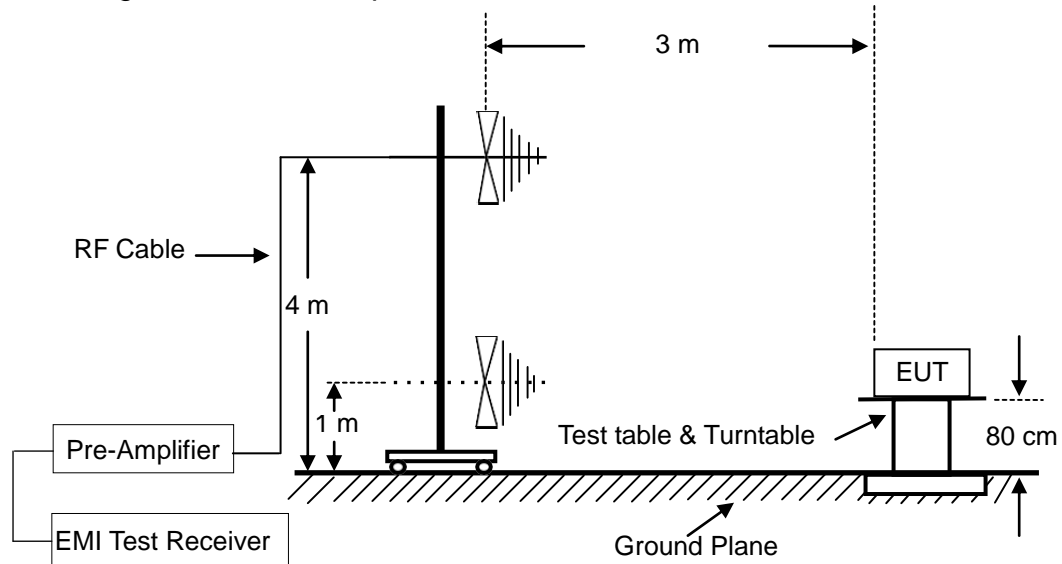

5.2. Radiated Limit

FCC Part 15, Subpart B, Class B

Frequency MHz	Distance Meters	Field Strengths Limit	
		$\mu\text{V}/\text{m}$	$\text{dB}(\mu\text{V})/\text{m}$
30 ~ 88	3	100	40.0
88 ~ 216	3	150	43.5
216 ~ 960	3	200	46.0
960 ~ 1000	3	500	54.0

5.3. Test Procedure

The EUT was placed on a non-conductive table whose total height equaled 80cm. All units of equipment forming the system under test (includes the EUT as well as connected peripherals and associated equipment or devices) shall be arranged such that a nominal 0.1 m separation is achieved between the neighboring units. Where the mains cable supplied by the manufacturer is longer than 1 m, the excess should be folded at the centre into a bundle no longer than 0.4 m, so that its length is shortened to 1 m.

The EUT was set 3 meters away from the receiving antenna that was mounted on a non-conductive mast. The antenna can move up and down between 1 to 4 meters to find out the maximum emission level.

The turntable can rotate 360 degree to determine the position of the maximum emission level.

The initial testing identified the frequency that has the highest disturbance relative to the limit while operating the EUT in typical modes of operation and cable positions in a test setup representative of typical system configuration.

The identification of the frequency of highest emission with respect to the limit was found by investigating emissions at a number of significant frequencies. The probable frequency of maximum emission had been found and that the associated cable and EUT configuration and mode of operation had been identified.

The bandwidth of the Receiver is set at 120 kHz.



Test results were obtained from the following equation:
Emission level (dB μ V/m) = Antenna Factor - Amp Factor + Cable Loss + Reading
Margin (dB) = Emission Level (dB μ V/m) - Limit (dB μ V/m)

5.4. Measuring Results

PASS.

Please refer to following pages.

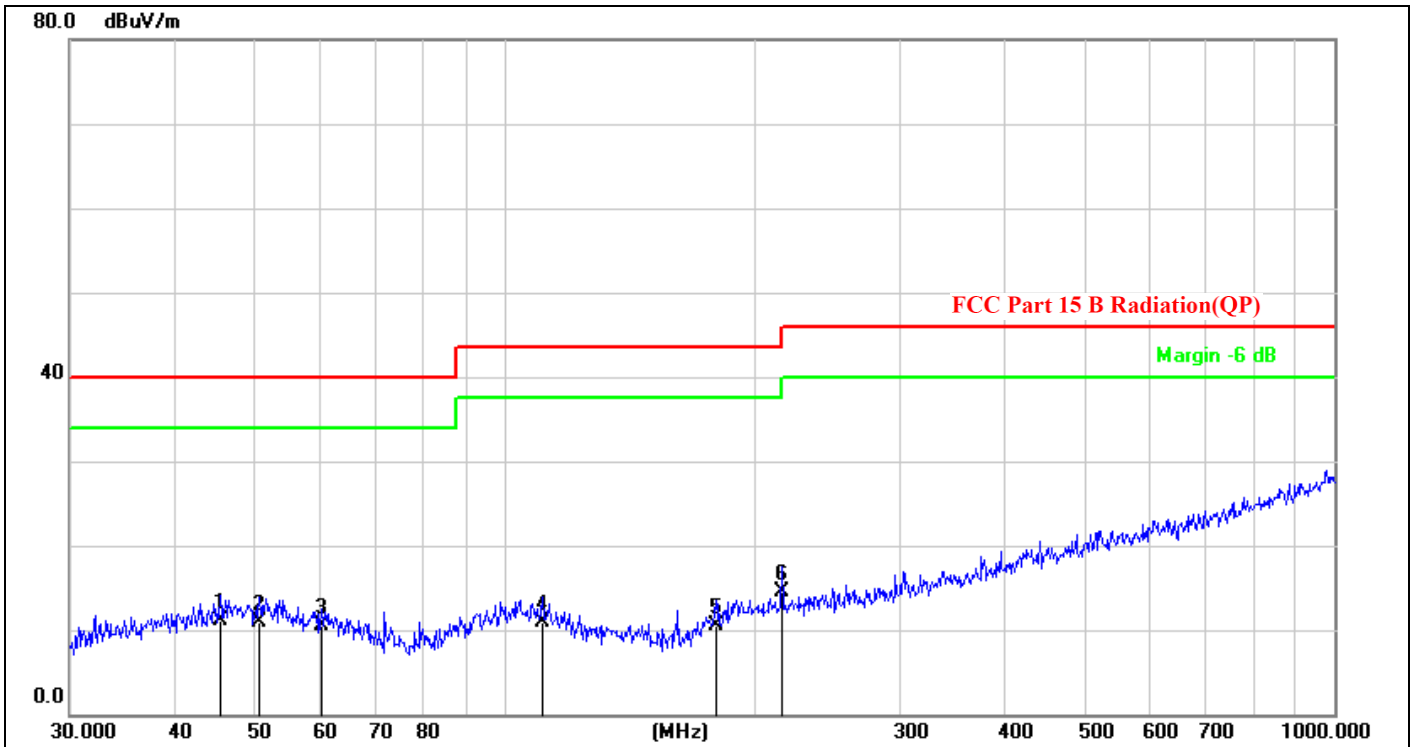

Site:	843.3	Antenna::Horizontal	Temperature(C):26(C)
Limit:	FCC Part 15 B Radiation(QP)		Humidity(%):60%
EUT:	LED Ceiling Light	Test Time:	2022-01-08
M/N.:	PLU01R-1528T-850	Power Rating:	AC 120V/60Hz
Mode:	ON	Test Engineer:	Bast
Note:			

No.	Frequency (MHz)	Reading Level(dBuV)	Factor (dB)	Measurement(dBuV)	Limit (dBuV)	Over (dB)	Detector	Comment
1 *	45.5348	23.41	-12.31	11.10	40.00	-28.90	QP	
2	50.7637	22.67	-11.76	10.91	40.00	-29.09	QP	
3	60.2801	23.58	-13.17	10.41	40.00	-29.59	QP	
4	111.3468	22.84	-11.97	10.87	43.50	-32.63	QP	
5	180.0165	22.82	-12.25	10.57	43.50	-32.93	QP	
6	216.0240	25.22	-10.70	14.52	46.00	-31.48	QP	

*:Maximum data x:Over limit !:over margin

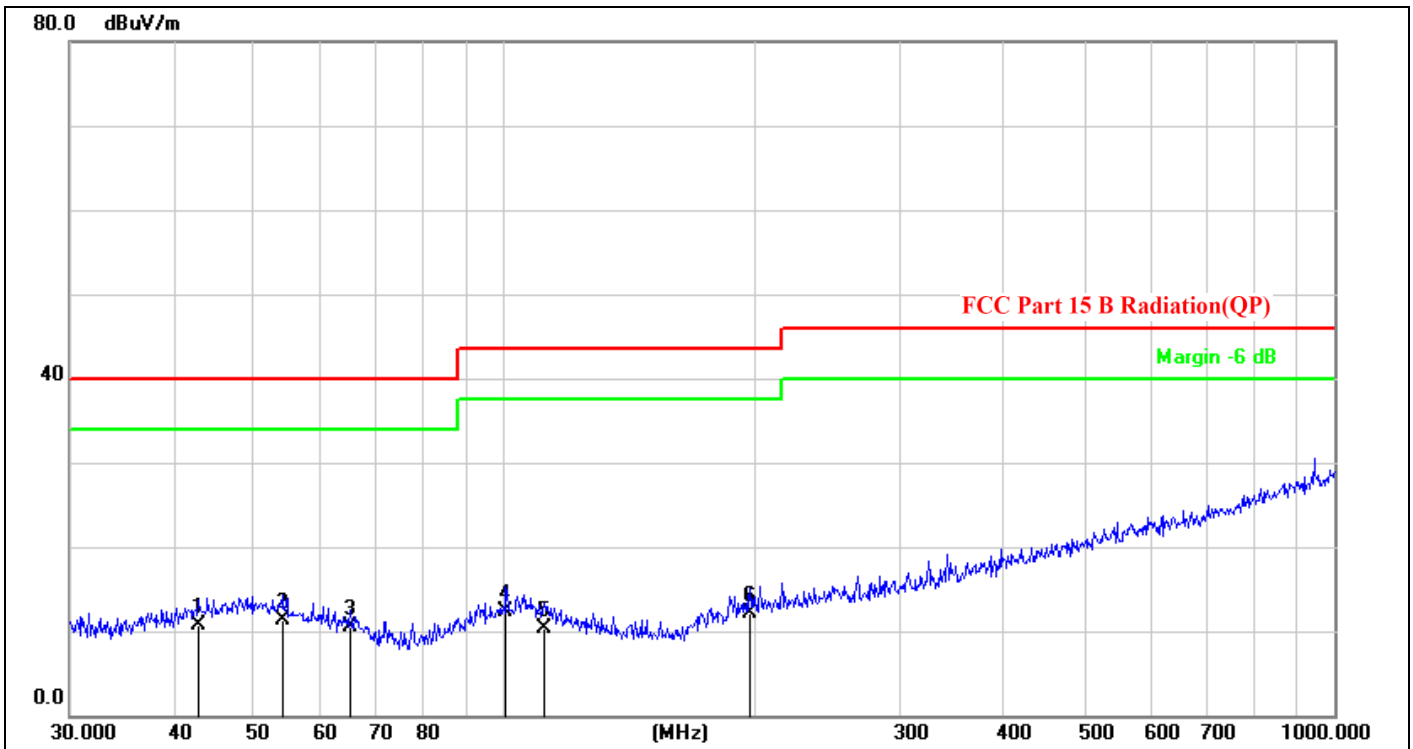

Site:	843.3	Antenna::Vertical	Temperature(C):26(C)
Limit:	FCC Part 15 B Radiation(QP)		Humidity(%):60%
EUT:	LED Ceiling Light	Test Time:	2022-01-08
M/N.:	PLU01R-1528T-850	Power Rating:	AC 120V/60Hz
Mode:	ON	Test Engineer:	Bast
Note:			

No.	Frequency (MHz)	Reading Level(dBuV)	Factor (dB)	Measurement(dBuV)	Limit (dBuV)	Over (dB)	Detector	Comment
1	42.8998	23.33	-12.70	10.63	40.00	-29.37	QP	
2	54.0711	23.50	-12.25	11.25	40.00	-28.75	QP	
3	65.3432	24.69	-14.11	10.58	40.00	-29.42	QP	
4 *	100.5806	24.05	-11.77	12.28	43.50	-31.22	QP	
5	111.7380	22.40	-12.04	10.36	43.50	-33.14	QP	
6	197.8928	23.16	-11.09	12.07	43.50	-31.43	QP	

*:Maximum data x:Over limit !:over margin

6. PHOTOGRAPHS

6.1. Photos of Conducted Emission Measurement

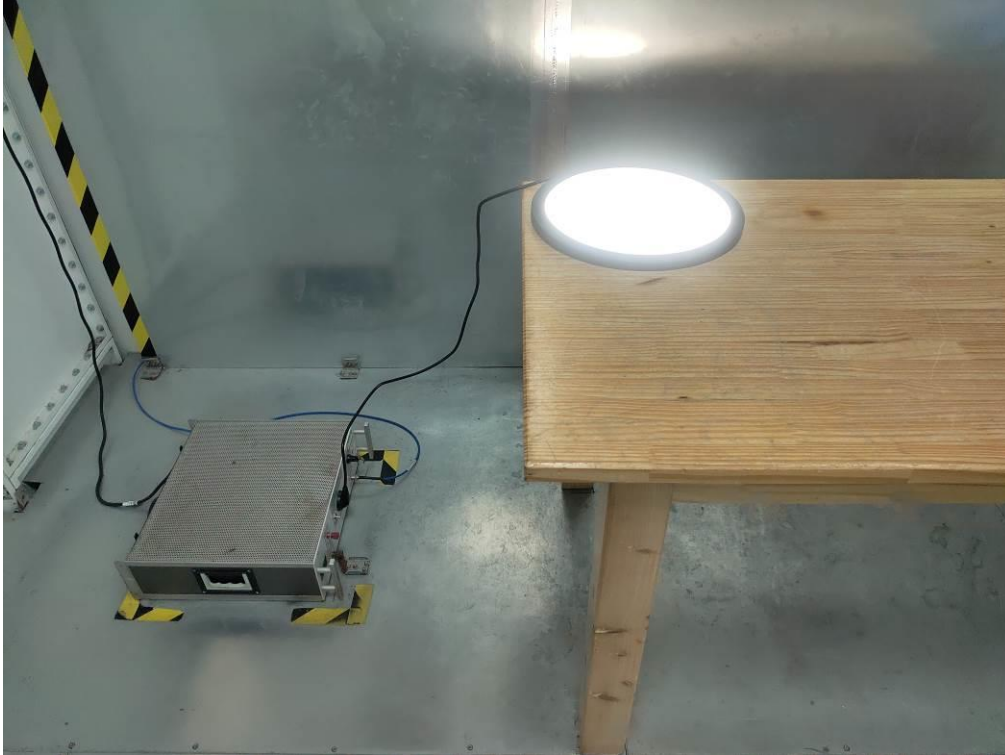

6.2. Photos of Radiation Emission Measurement

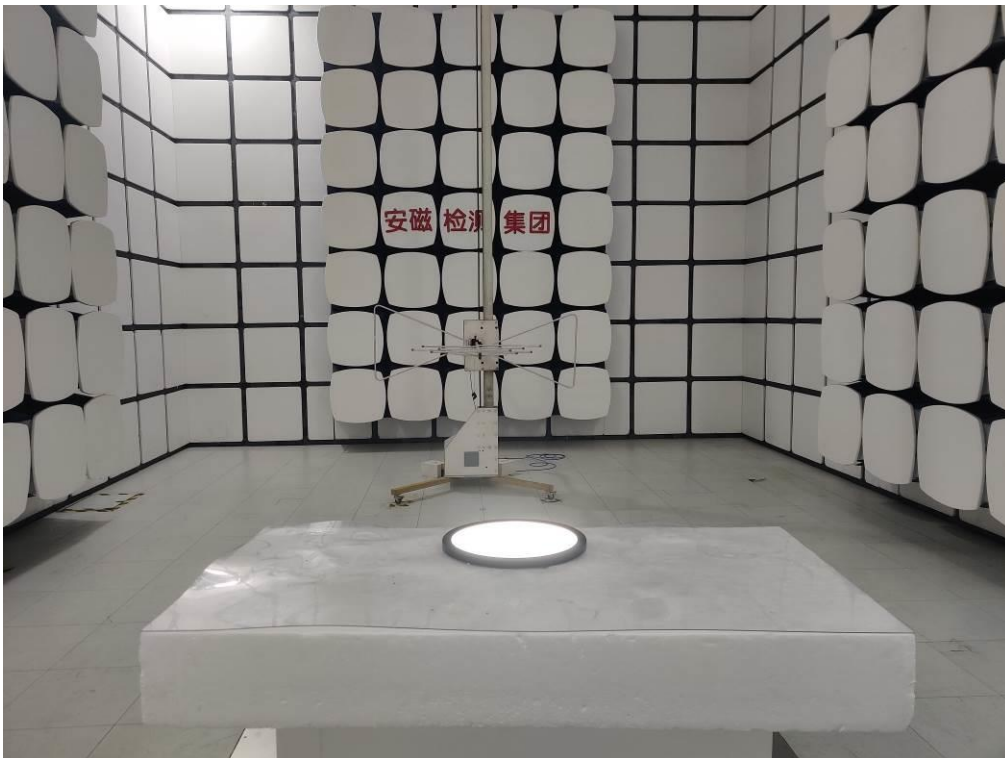

APPENDIX A: Photos of EUT

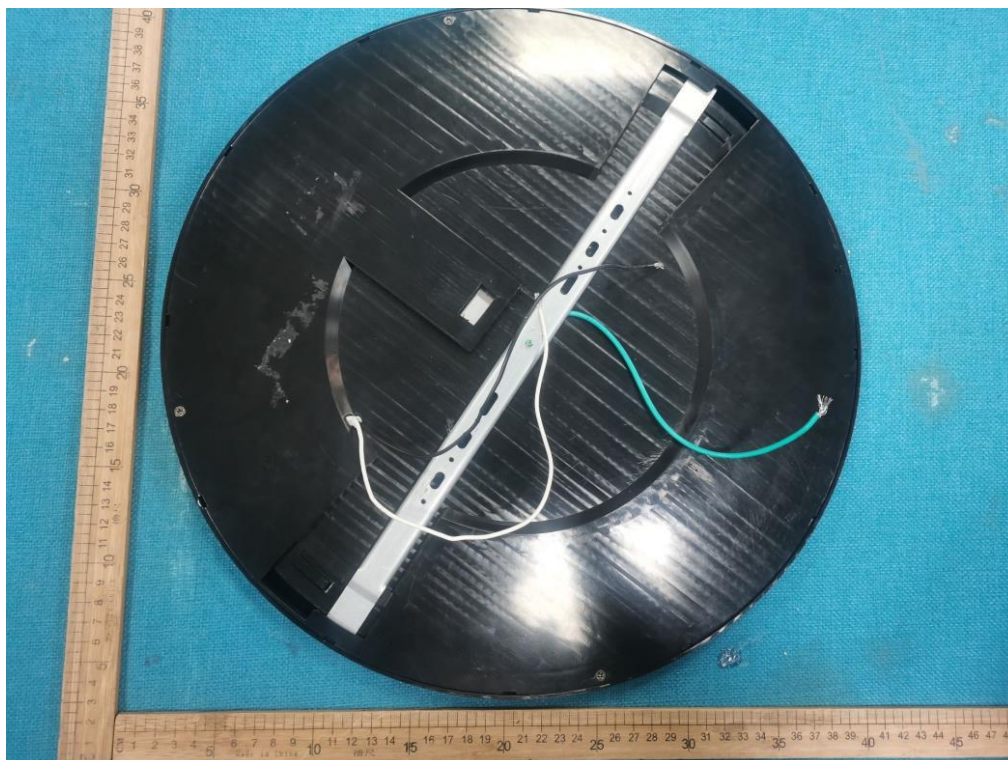
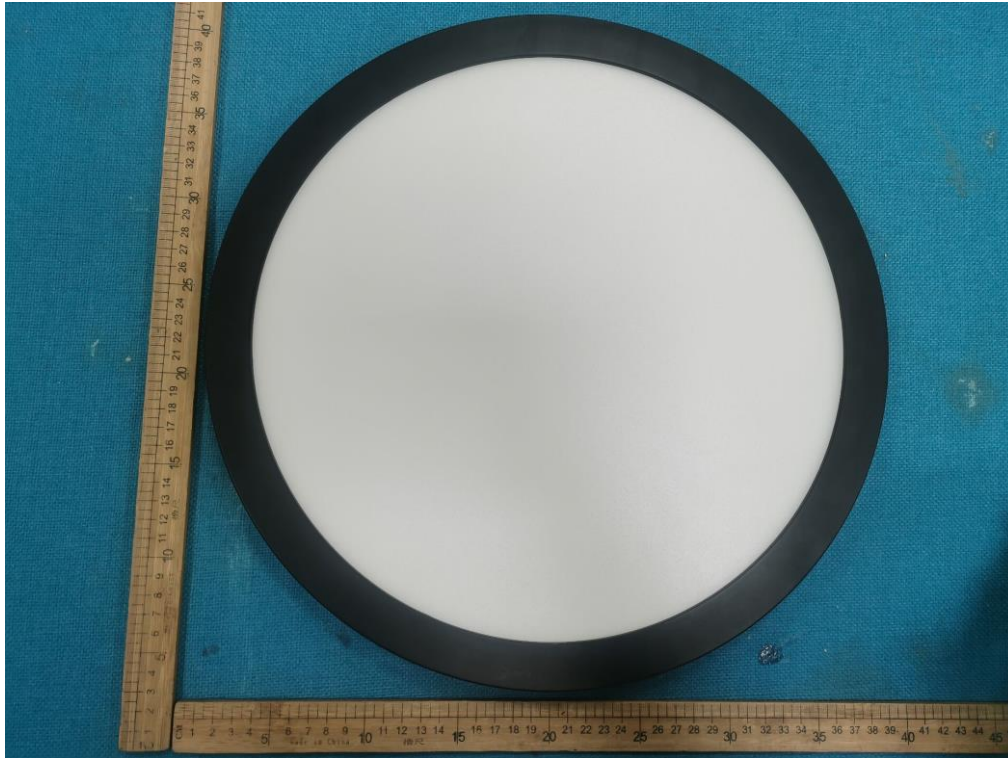

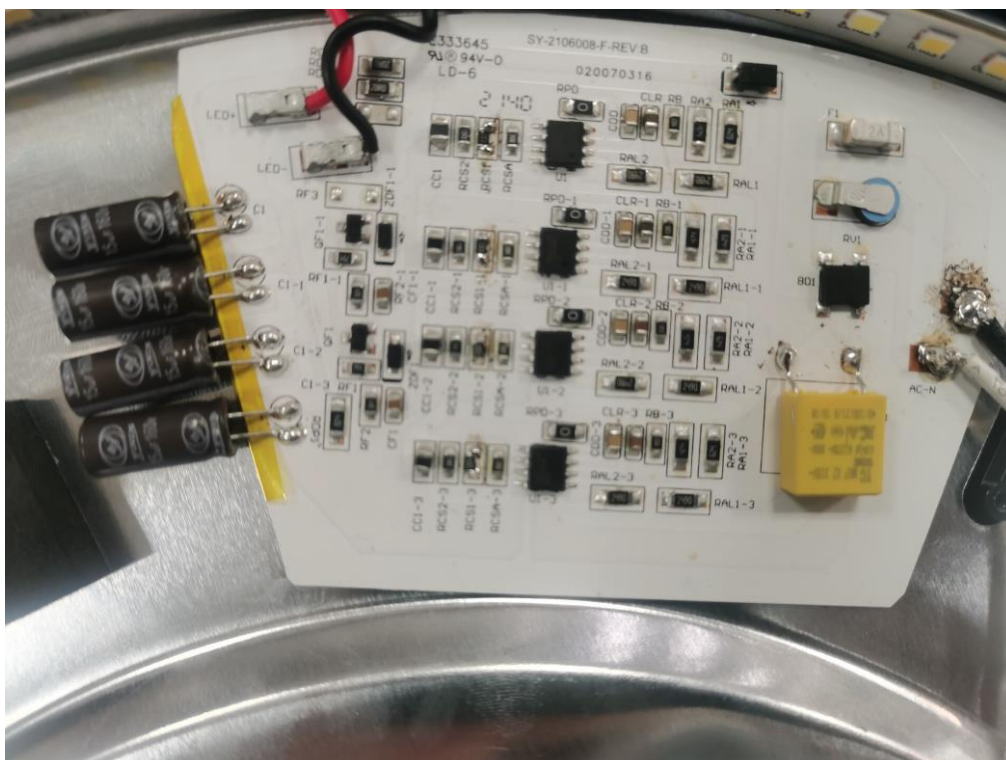
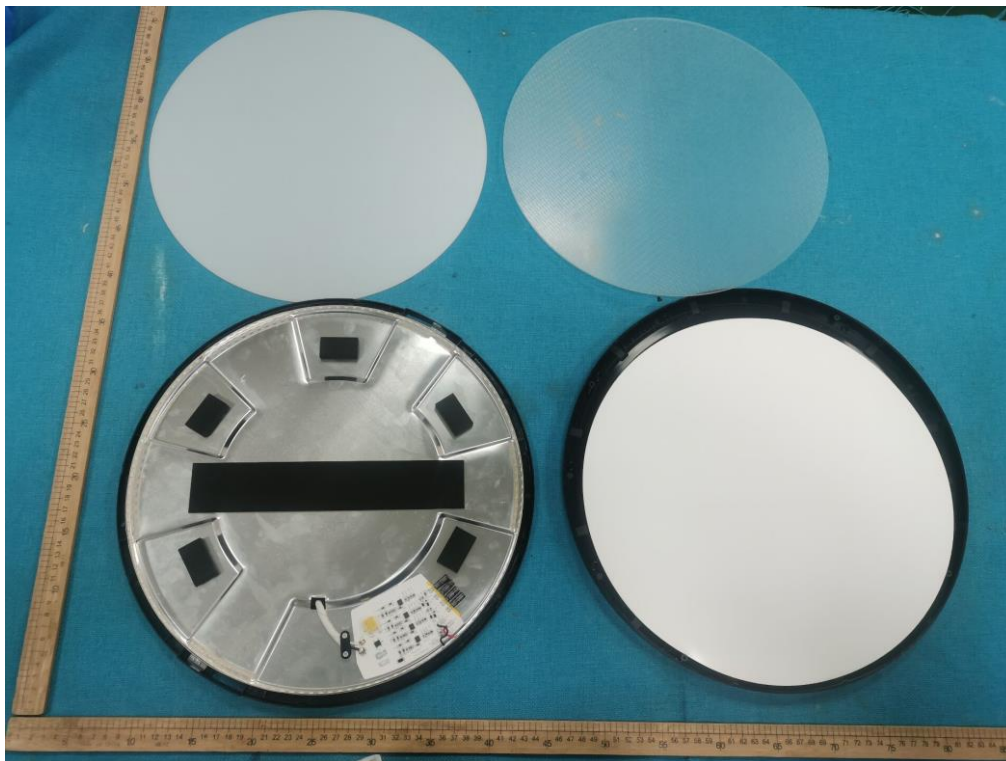



-----The end-----