

FCC Test Report (2.4GHz WLAN)

Report No.: RFBHQC-WTW-P20110715-1

FCC ID: 2AYDXSCMAA1

Test Model: SCMAA1

Series Model: SCMBA1

Received Date: Nov. 23, 2020

Test Date: Dec. 12, 2020 to Jan. 4, 2021

Issued Date: Jan. 6, 2021

Applicant: Merlyn Mind, Inc.

Address: 405 Lexington Avenue, Suite 3504, New York, NY 10174, USA

Issued By: Bureau Veritas Consumer Products Services (H.K.) Ltd., Taoyuan Branch
Lin Kou Laboratories

Lab Address: No. 47-2, 14th Ling, Chia Pau Vil., Lin Kou Dist., New Taipei City, Taiwan

**FCC Registration /
Designation Number:** 198487 / TW2021



This report is for your exclusive use. Any copying or replication of this report to or for any other person or entity, or use of our name or trademark, is permitted only with our prior written permission. This report sets forth our findings solely with respect to the test samples identified herein. The results set forth in this report are not indicative or representative of the quality or characteristics of the lot from which a test sample was taken or any similar or identical product unless specifically and expressly noted. Our report includes all of the tests requested by you and the results thereof based upon the information that you provided to us. You have 60 days from date of issuance of this report to notify us of any material error or omission caused by our negligence, provided, however, that such notice shall be in writing and shall specifically address the issue you wish to raise. A failure to raise such issue within the prescribed time shall constitute your unqualified acceptance of the completeness of this report, the tests conducted and the correctness of the report contents. Unless specifically mentioned, the uncertainty of measurement has been explicitly taken into account to declare the compliance or non-compliance to the specification.

Table of Contents

Release Control Record	4
1 Certificate of Conformity	5
2 Summary of Test Results	6
2.1 Measurement Uncertainty.....	6
2.2 Modification Record.....	6
3 General Information	7
3.1 General Description of EUT.....	7
3.2 Description of Test Modes.....	8
3.2.1 Test Mode Applicability and Tested Channel Detail.....	9
3.3 Duty Cycle of Test Signal.....	11
3.4 Description of Support Units.....	12
3.4.1 Configuration of System under Test.....	12
3.5 General Description of Applied Standards and References.....	13
4 Test Types and Results	14
4.1 Radiated Emission and Bandedge Measurement.....	14
4.1.1 Limits of Radiated Emission and Bandedge Measurement.....	14
4.1.2 Test Instruments.....	15
4.1.3 Test Procedures.....	16
4.1.4 Deviation from Test Standard.....	16
4.1.5 Test Setup.....	17
4.1.6 EUT Operating Conditions.....	18
4.1.7 Test Results.....	19
4.2 Conducted Emission Measurement.....	33
4.2.1 Limits of Conducted Emission Measurement.....	33
4.2.2 Test Instruments.....	33
4.2.3 Test Procedures.....	34
4.2.4 Deviation from Test Standard.....	34
4.2.5 Test Setup.....	34
4.2.6 EUT Operating Conditions.....	34
4.2.7 Test Results.....	35
4.3 6dB Bandwidth Measurement.....	37
4.3.1 Limits of 6dB Bandwidth Measurement.....	37
4.3.2 Test Setup.....	37
4.3.3 Test Instruments.....	37
4.3.4 Test Procedure.....	37
4.3.5 Deviation from Test Standard.....	37
4.3.6 EUT Operating Conditions.....	37
4.3.7 Test Result.....	38
4.4 Conducted Output Power Measurement.....	40
4.4.1 Limits of Conducted Output Power Measurement.....	40
4.4.2 Test Setup.....	40
4.4.3 Test Instruments.....	40
4.4.4 Test Procedures.....	40
4.4.5 Deviation from Test Standard.....	40
4.4.6 EUT Operating Conditions.....	40
4.4.7 Test Results.....	41
4.5 Power Spectral Density Measurement.....	43
4.5.1 Limits of Power Spectral Density Measurement.....	43
4.5.2 Test Setup.....	43
4.5.3 Test Instruments.....	43
4.5.4 Test Procedure.....	43
4.5.5 Deviation from Test Standard.....	43

4.5.6 EUT Operating Condition	43
4.5.7 Test Results	44
4.6 Conducted Out of Band Emission Measurement	46
4.6.1 Limits of Conducted Out of Band Emission Measurement	46
4.6.2 Test Setup	46
4.6.3 Test Instruments	46
4.6.4 Test Procedure	46
4.6.5 Deviation from Test Standard	46
4.6.6 EUT Operating Condition	46
4.6.7 Test Results	46
5 Pictures of Test Arrangements	55
Annex A- Band Edge Measurement	56
Appendix – Information of the Testing Laboratories	60

Release Control Record

Issue No.	Description	Date Issued
RFBHQC-WTW-P20110715-1	Original release	Jan. 6, 2021

1 Certificate of Conformity

Product: Symphony Classroom AI Enabled Classroom Hub

Brand: Symphony Classroom™

Test Model: SCMAA1

Series Model: SCMBA1

Sample Status: Engineering sample

Applicant: Merlyn Mind, Inc.

Test Date: Dec. 12, 2020 to Jan. 4, 2021

Standards: 47 CFR FCC Part 15, Subpart C (Section 15.247)
ANSI C63.10:2013

The above equipment has been tested by **Bureau Veritas Consumer Products Services (H.K.) Ltd., Taoyuan Branch**, and found compliance with the requirement of the above standards. The test record, data evaluation & Equipment Under Test (EUT) configurations represented herein are true and accurate accounts of the measurements of the sample's RF characteristics under the conditions specified in this report.

Prepared by :

Annie Chang

Date: Jan. 6, 2021

Annie Chang / Senior Specialist

Approved by :

Rex Lai

Date: Jan. 6, 2021

Rex Lai / Associate Technical Manager

2 Summary of Test Results

47 CFR FCC Part 15, Subpart C (Section 15.247)			
FCC Clause	Test Item	Result	Remarks
15.207	AC Power Conducted Emission	Pass	Meet the requirement of limit. Minimum passing margin is -10.16dB at 0.43906MHz.
15.205 / 15.209 / 15.247(d)	Radiated Emissions and Band Edge Measurement	Pass	Meet the requirement of limit. Minimum passing margin is -1.14dB at 2483.50MHz.
15.247(d)	Antenna Port Emission	Pass	Meet the requirement of limit.
15.247(a)(2)	6dB bandwidth	Pass	Meet the requirement of limit.
15.247(b)	Conducted power	Pass	Meet the requirement of limit.
15.247(e)	Power Spectral Density	Pass	Meet the requirement of limit.
15.203	Antenna Requirement	Pass	Antenna connector is i-pex(MHF) not a standard connector.

Note:

- For 2.4G band compliance with rule 15.247(d) of the band-edge items, the test plots were recorded in Annex A. Test Procedures refer to report 4.1.3.
- Determining compliance based on the results of the compliance measurement, not taking into account measurement instrumentation uncertainty.

2.1 Measurement Uncertainty

Where relevant, the following measurement uncertainty levels have been estimated for tests performed on the EUT as specified in CISPR 16-4-2:

Measurement	Frequency	Expanded Uncertainty (k=2) (\pm)
Conducted Emissions at mains ports	150kHz ~ 30MHz	3.00 dB
Conducted Emissions	9kHz ~ 40GHz	2.63 dB
Radiated Emissions up to 1 GHz	9kHz ~ 30MHz	2.61 dB
	30MHz ~ 1GHz	5.43 dB
Radiated Emissions above 1 GHz	Above 1GHz	5.42 dB

2.2 Modification Record

There were no modifications required for compliance.

3 General Information

3.1 General Description of EUT

Product	Symphony Classroom AI Enabled Classroom Hub
Brand	Symphony Classroom™
Test Model	SCMAA1
Series Model	SCMBA1
Model Difference	Marketing purpose
Sample Status	Engineering sample
Power Supply Rating	19Vdc from Adapter
Modulation Type	CCK, DQPSK, DBPSK for DSSS 64QAM, 16QAM, QPSK, BPSK for OFDM
Modulation Technology	DSSS, OFDM
Transfer Rate	802.11b: 11/5.5/2/1Mbps 802.11g: 54/48/36/24/18/12/9/6Mbps 802.11n: up to 300Mbps
Operating Frequency	2412~2462MHz
Number of Channel	802.11b, 802.11g, 802.11n (20MHz): 11 802.11n (40MHz): 7
Output Power	921.708mW
Antenna Type	Chian 0: PCB antenna with 2.83dBi gain Chian 1: PCB antenna with 3.46dBi gain
Antenna Connector	i-pex(MHF)
Accessory Device	Adapter, Remote controller, Mounting kit
Cable Supplied	Shielded HDMI cable (1.8m)

Note:

1. The EUT provides 2 completed transmitter and 2 receiver.

Modulation Mode	TX Function
802.11b	2TX
802.11g	2TX
802.11n (20MHz)	2TX
802.11n (40MHz)	2TX

2. The EUT consumes power from the following adapter.

Brand	NetBit
Model	NBS60E190342M2
Input Power	100-240V, 1.5A, 50-60Hz
Output Power	19.0V, 3.42A
Power Line	Non-shielded DC cable (1.8m)

3. All RF characteristics can't transmit simultaneously.

4. The above Antenna information is declared by manufacturer and for more detailed features description, please refer to the manufacturer's specifications, the laboratory shall not be held responsible.

5. The above EUT information is declared by manufacturer and for more detailed features description, please refer to the manufacturer's specifications or user's manual.

3.2 Description of Test Modes

11 channels are provided for 802.11b, 802.11g and 802.11n (20MHz):

Channel	Frequency	Channel	Frequency
1	2412MHz	7	2442MHz
2	2417MHz	8	2447MHz
3	2422MHz	9	2452MHz
4	2427MHz	10	2457MHz
5	2432MHz	11	2462MHz
6	2437MHz		

7 channels are provided for 802.11n (40MHz):

Channel	Frequency	Channel	Frequency
3	2422MHz	7	2442MHz
4	2427MHz	8	2447MHz
5	2432MHz	9	2452MHz
6	2437MHz		

3.2.1 Test Mode Applicability and Tested Channel Detail

EUT Configure Mode	Applicable to				Description
	RE \geq 1G	RE<1G	PLC	APCM	
-	√	√	√	√	-

Where RE \geq 1G: Radiated Emission above 1GHz & Bandedge Measurement
 RE<1G: Radiated Emission below 1GHz
 PLC: Power Line Conducted Emission
 APCM: Antenna Port Conducted Measurement

Radiated Emission Test (Above 1GHz):

- Pre-Scan has been conducted to determine the worst-case mode from all possible combinations between available modulations, data rates and antenna ports (if EUT with antenna diversity architecture).
- Following channel(s) was (were) selected for the final test as listed below.

EUT Configure Mode	Mode	Available Channel	Tested Channel	Modulation Technology	Modulation Type	Data Rate (Mbps)
-	802.11b	1 to 11	1, 6, 11	DSSS	DBPSK	1
	802.11g	1 to 11	1, 6, 11	OFDM	BPSK	6
	802.11n (20MHz)	1 to 11	1, 6, 11	OFDM	BPSK	6.5
	802.11n (40MHz)	3 to 9	3, 6, 9	OFDM	BPSK	13.5

Radiated Emission Test (Below 1GHz):

- Pre-Scan has been conducted to determine the worst-case mode from all possible combinations between available modulations, data rates and antenna ports (if EUT with antenna diversity architecture).
- Following channel(s) was (were) selected for the final test as listed below.

EUT Configure Mode	Mode	Available Channel	Tested Channel	Modulation Technology	Modulation Type	Data Rate (Mbps)
-	802.11g	1 to 11	6	OFDM	BPSK	6

Power Line Conducted Emission Test:

- Pre-Scan has been conducted to determine the worst-case mode from all possible combinations between available modulations, data rates and antenna ports (if EUT with antenna diversity architecture).
- Following channel(s) was (were) selected for the final test as listed below.

EUT Configure Mode	Mode	Available Channel	Tested Channel	Modulation Technology	Modulation Type	Data Rate (Mbps)
-	802.11g	1 to 11	6	OFDM	BPSK	6

Antenna Port Conducted Measurement:

- This item includes all test value of each mode, but only includes spectrum plot of worst value of each mode.
- Pre-Scan has been conducted to determine the worst-case mode from all possible combinations between available modulations, data rates and antenna ports (if EUT with antenna diversity architecture).
- Following channel(s) was (were) selected for the final test as listed below.

EUT Configure Mode	Mode	Available Channel	Tested Channel	Modulation Technology	Modulation Type	Data Rate (Mbps)
-	802.11b	1 to 11	1, 6, 11	DSSS	DBPSK	1
	802.11g	1 to 11	1, 6, 11	OFDM	BPSK	6
	802.11n (20MHz)	1 to 11	1, 6, 11	OFDM	BPSK	6.5
	802.11n (40MHz)	3 to 9	3, 6, 9	OFDM	BPSK	13.5

Test Condition:

Applicable to	Environmental Conditions	Input Power	Tested by
RE \geq 1G	15deg. C, 74%RH	120Vac, 60Hz	Dalen Dai
RE<1G	22deg. C, 74%RH	120Vac, 60Hz	Dalen Dai
PLC	25deg. C, 75%RH	120Vac, 60Hz	Ian Chang
APCM	25deg. C, 76%RH	120Vac, 60Hz	Saxon Lee

3.3 Duty Cycle of Test Signal

Duty cycle of test signal is $\geq 98\%$, duty factor is not required.

802.11b: Duty cycle = 100%

802.11g: Duty cycle = $2.035/2.05 = 0.993$

802.11n (20MHz): Duty cycle = $1.9/1.91 = 0.995$

802.11n (40MHz): Duty cycle = $0.936/0.954 = 0.981$

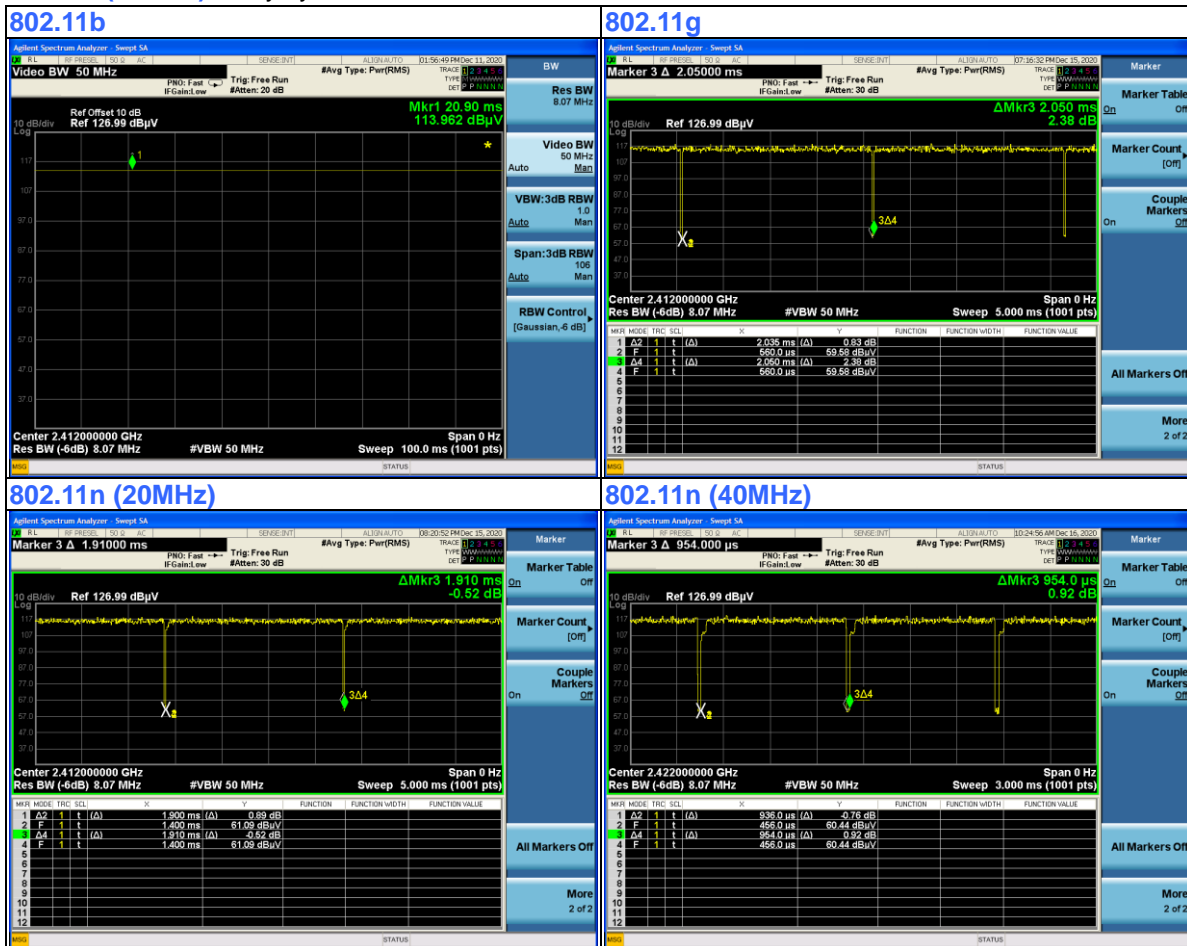

3.4 Description of Support Units

The EUT has been tested as an independent unit together with other necessary accessories or support units. The following support units or accessories were used to form a representative test configuration during the tests.

ID	Product	Brand	Model No.	Serial No.	FCC ID	Remarks
A.	PHONE	SAMSUNG	SM-A505GN/DS	R58M74MNP1P	NA	Provided by Lab
B.	Notebook PC	Lenove	81LG	PHNGBDP	NA	Provided by Lab
C.	DVD Player *3	SONY	BDP-S7200	NA	NA	Provided by Lab
D.	LCD Monitor	Dell	S2817Q	CN-0GD45P-74445-724-116M	NA	Provided by Lab
E.	USB Flash *3	SanDisk	SanDisk Ultra	NA	NA	Provided by Lab
F.	USB Flash	SanDisk	SanDisk Ultra	NA	NA	Provided by Lab
G.	EARPHONE	PHILIPS	SBC HL150	H2010147	NA	Provided by Lab

Note:

1. All power cords of the above support units are non-shielded (1.8m).
2. Item B acted as communication partners to transfer data.

ID	Cable Descriptions	Qty.	Length (m)	Shielding (Yes/ No)	Cores (Qty.)	Remarks
1.	LAN cable	1	10	N	0	Provided by Lab (RJ45, Cat.5e)
2.	HDMI cable	3	1.8	Y	0	Provided by Lab
3.	HDMI cable	1	1.8	Y	0	Supplied by client
4.	Audio cable	1	1.8	N	0	Provided by Lab
5.	Audio cable	1	1.2	N	0	Provided by Lab
6.	DC cable	1	1.8	N	0	Supplied by client

Note: The core(s) is(are) originally attached to the cable(s).

3.4.1 Configuration of System under Test

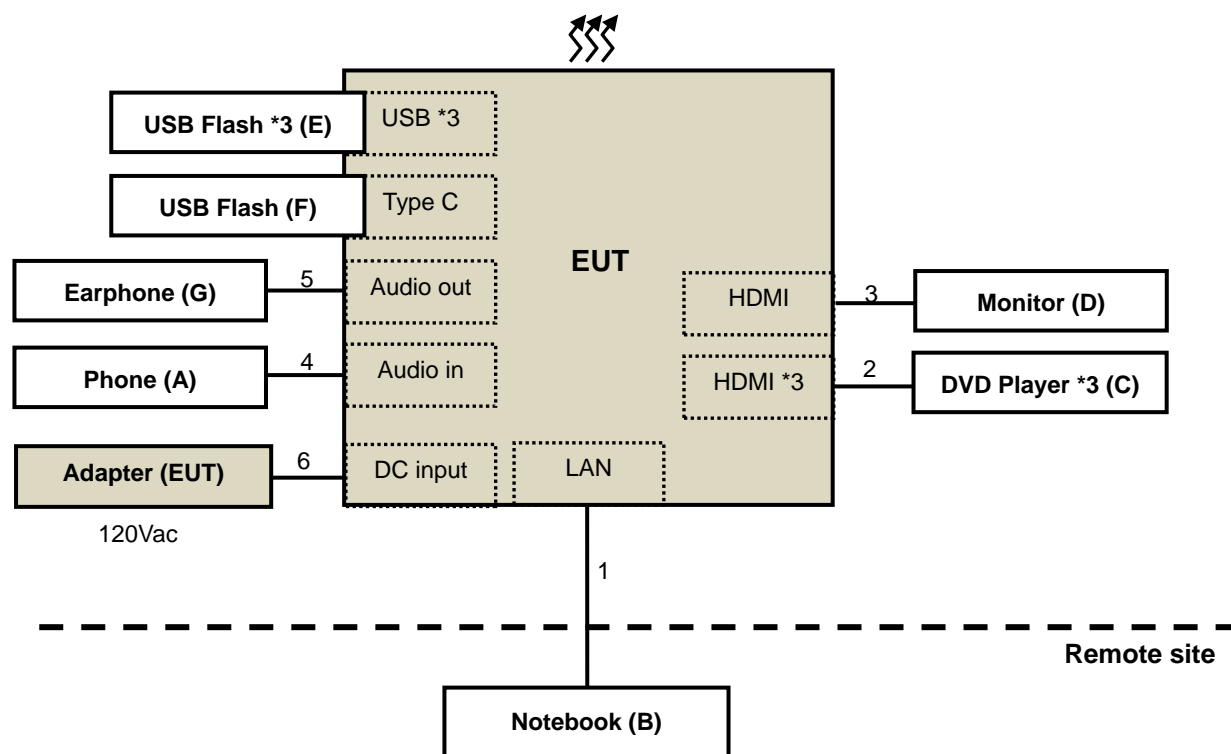

3.5 General Description of Applied Standards and References

The EUT is a RF Product. According to the specifications of the manufacturer, it must comply with the requirements of the following standards and References:

Test standard:

FCC Part 15, Subpart C (15.247)

ANSI C63.10-2013

All test items have been performed and recorded as per the above standards.

References Test Guidance:

KDB 558074 D01 15.247 Meas Guidance v05r02

KDB 662911 D01 Multiple Transmitter Output v02r01

All test items have been performed as a reference to the above KDB test guidance.

4 Test Types and Results

4.1 Radiated Emission and Bandedge Measurement

4.1.1 Limits of Radiated Emission and Bandedge Measurement

Radiated emissions which fall in the restricted bands must comply with the radiated emission limits specified as below table. Other emissions shall be at least 20dB below the highest level of the desired power:

Frequencies (MHz)	Field Strength (microvolts/meter)	Measurement Distance (meters)
0.009 ~ 0.490	2400/F(kHz)	300
0.490 ~ 1.705	24000/F(kHz)	30
1.705 ~ 30.0	30	30
30 ~ 88	100	3
88 ~ 216	150	3
216 ~ 960	200	3
Above 960	500	3

Note:

1. The lower limit shall apply at the transition frequencies.
2. Emission level (dBuV/m) = 20 log Emission level (uV/m).
3. For frequencies above 1000MHz, the field strength limits are based on average detector, however, the peak field strength of any emission shall not exceed the maximum permitted average limits, specified above by more than 20dB under any condition of modulation.

4.1.2 Test Instruments

DESCRIPTION & MANUFACTURER	MODEL NO.	SERIAL NO.	CALIBRATED DATE	CALIBRATED UNTIL
HP Preamplifier	8447D	2432A03504	Feb. 19, 2020	Feb. 18, 2021
HP Preamplifier	8449B	3008A01201	Feb. 20, 2020	Feb. 19, 2021
MITEQ Preamplifier	AMF-6F-260400-33-8P	892164	Feb. 19, 2020	Feb. 18, 2021
Agilent TEST RECEIVER	N9038A	MY51210129	Mar. 18, 2020	Mar. 17, 2021
Schwarzbeck Antenna	VULB 9168	139	Nov. 6, 2020	Nov. 5, 2021
Schwarzbeck Antenna	VHBA 9123	480	Jun. 3, 2019	Jun. 2, 2021
Schwarzbeck Horn Antenna	BBHA-9170	212	Nov. 22, 2020	Nov. 21, 2021
EMCO Horn Antenna	3115	00027024	Nov. 22, 2020	Nov.21, 2021
ADT. Turn Table	TT100	0306	NA	NA
ADT. Tower	AT100	0306	NA	NA
Software	Radiated_V7.6.15.9.5	NA	NA	NA
SUHNER RF cable With 4dB PAD	SF102	Cable-CH6-01	Jul. 9, 2020	Jul. 8, 2021
EMEC RF cable With 3/4dB PAD	EM102-KMKM	01	Aug. 21, 2020	Aug. 20, 2021
KEYSIGHT MIMO Powermeasurement Test set	U2021XA	U2021XA-001	Jun. 16, 2020	Jun. 15, 2021
KEYSIGHT Spectrum Analyzer	N9030A	MY54490260	Jul. 22, 2020	Jul. 21, 2021
Loop Antenna EMCI	LPA600	270	Aug. 23, 2019	Aug. 22, 2021
EMCO Horn Antenna	3115	00028257	Nov. 22, 2020	Nov. 21, 2021
Highpass filter Wainwright Instruments	WHK 3.1/18G-10SS	SN 8	NA	NA
ROHDE & SCHWARZ Spectrum Analyzer	FSV40	101042	Sep. 8, 2020	Sep. 7, 2021
Anritsu Power Sensor	MA2411B	0738404	Apr. 13, 2020	Apr. 12, 2021
Anritsu Power Meter	ML2495A	0842014	Apr. 13, 2020	Apr. 12, 2021

- NOTE:** 1. The calibration interval of the above test instruments is 12/24 months. And the calibrations are traceable to NML/ROC and NIST/USA.
2. The horn antenna and HP preamplifier (model: 8449B) are used only for the measurement of emission frequency above 1GHz if tested.
3. The test was performed in Chamber No. 6.

4.1.3 Test Procedures

For Radiated emission below 30MHz

- a. The EUT was placed on the top of a rotating table 0.8 meters above the ground at a 3 meter chamber room. The table was rotated 360 degrees to determine the position of the highest radiation.
- b. The EUT was set 3 meters away from the interference-receiving antenna, which was mounted on the top of a variable-height antenna tower.
- c. Parallel, perpendicular, and ground-parallel orientations of the antenna are set to make the measurement.
- d. For each suspected emission, the EUT was arranged to its worst case and the rotatable table was turned from 0 degrees to 360 degrees to find the maximum reading.
- e. The test-receiver system was set to Quasi-Peak Detect Function and Specified Bandwidth with Maximum Hold Mode.

Note:

1. The resolution bandwidth and video bandwidth of test receiver/spectrum analyzer is 9kHz at frequency below 30MHz.

For Radiated emission above 30MHz

- a. The EUT was placed on the top of a rotating table 0.8 meters (for 30MHz ~ 1GHz) / 1.5 meters (for above 1GHz) above the ground at 3 meter chamber room for test. The table was rotated 360 degrees to determine the position of the highest radiation.
- b. The EUT was set 3 meters away from the interference-receiving antenna, which was mounted on the top of a variable-height antenna tower.
- c. The height of antenna is varied from one meter to four meters above the ground to determine the maximum value of the field strength. Both horizontal and vertical polarizations of the antenna are set to make the measurement.
- d. For each suspected emission, the EUT was arranged to its worst case and then the antenna was tuned to heights from 1 meter to 4 meters and the rotatable table was turned from 0 degrees to 360 degrees to find the maximum reading.
- e. The test-receiver system was set to quasi-peak detect function and specified bandwidth with maximum hold mode when the test frequency is below 1 GHz.
- f. The test-receiver system was set to peak and average detect function and specified bandwidth with maximum hold mode when the test frequency is above 1 GHz. If the peak reading value also meets average limit, measurement with the average detector is unnecessary.

Note:

1. The resolution bandwidth and video bandwidth of test receiver/spectrum analyzer is 120kHz for Quasi-peak detection (QP) at frequency below 1GHz.
2. The resolution bandwidth of test receiver/spectrum analyzer is 1 MHz and the video bandwidth is 3 MHz for Peak detection (PK) at frequency above 1GHz.
3. The resolution bandwidth of test receiver/spectrum analyzer is 1MHz and the video bandwidth is $\geq 1/T$ (Duty cycle < 98%) or 10Hz (Duty cycle $\geq 98\%$) for Average detection (AV) at frequency above 1GHz. (802.11b, 802.11g, 802.11n (20MHz), 802.11n (40MHz): RBW = 1MHz, VBW = 10Hz)
4. All modes of operation were investigated and the worst-case emissions are reported.

4.1.4 Deviation from Test Standard

No deviation.

4.1.5 Test Setup

For Radiated emission below 30MHz

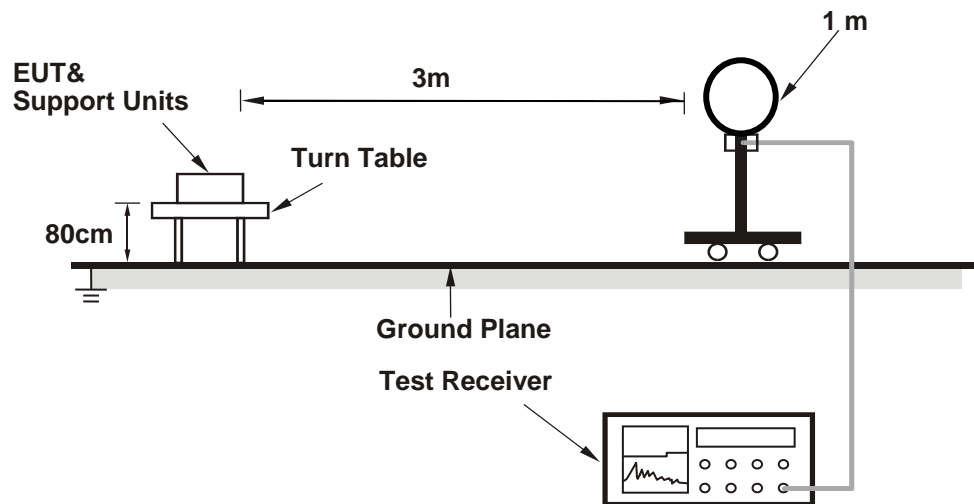

For Radiated emission 30MHz to 1GHz

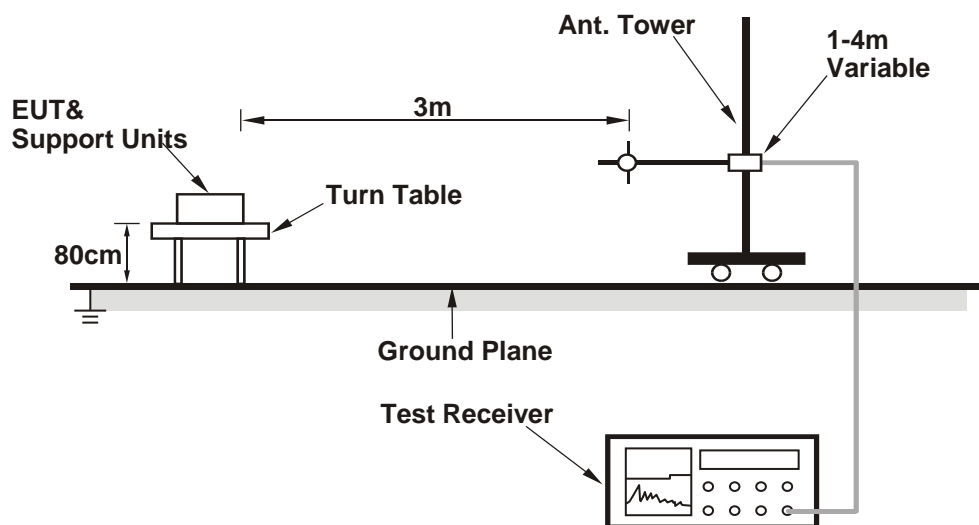

For Radiated emission above 1GHz

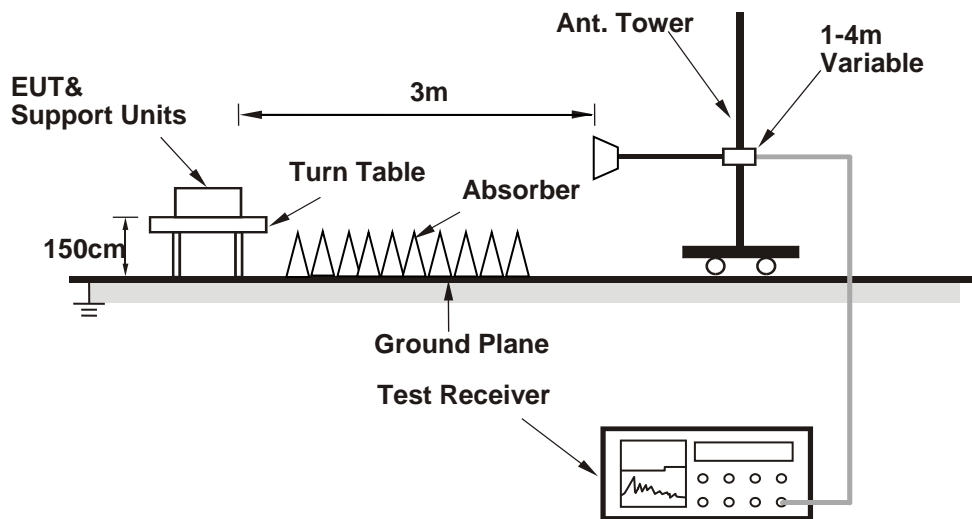

For the actual test configuration, please refer to the attached file (Test Setup Photo).

4.1.6 EUT Operating Conditions

- a. Placed the EUT on the testing table.
- b. Prepared notebook to act as communication partner and placed it outside of testing area.
- c. The communication partner connected with EUT via a RJ45 cable and ran a test program (provided by manufacturer) to enable EUT under transmission condition continuously at specific channel frequency.
- d. The necessary accessories enable the system in full functions.

4.1.7 Test Results

ABOVE 1GHz DATA

RF Mode	TX 802.11b	Channel	CH 1 : 2412 MHz
Frequency Range	1GHz ~ 25GHz	Detector Function	Peak (PK) Average (AV)

Antenna Polarity & Test Distance : Horizontal at 3 m								
No	Frequency (MHz)	Emission Level (dBuV/m)	Limit (dBuV/m)	Margin (dB)	Antenna Height (m)	Table Angle (Degree)	Raw Value (dBuV)	Correction Factor (dB/m)
1	2386.00	58.34 PK	74.00	-15.66	1.21 H	4	57.02	1.32
2	2386.00	52.75 AV	54.00	-1.25	1.21 H	4	51.43	1.32
3	*2412.00	109.10 PK			1.21 H	4	107.65	1.45
4	*2412.00	107.33 AV			1.21 H	4	105.88	1.45
5	4824.00	51.29 PK	74.00	-22.71	1.46 H	6	41.87	9.42
6	4824.00	42.19 AV	54.00	-11.81	1.46 H	6	32.77	9.42
Antenna Polarity & Test Distance : Vertical at 3 m								
No	Frequency (MHz)	Emission Level (dBuV/m)	Limit (dBuV/m)	Margin (dB)	Antenna Height (m)	Table Angle (Degree)	Raw Value (dBuV)	Correction Factor (dB/m)
1	2386.00	55.38 PK	74.00	-18.62	1.87 V	58	54.06	1.32
2	2386.00	47.19 AV	54.00	-6.81	1.87 V	58	45.87	1.32
3	*2412.00	106.46 PK			1.87 V	58	105.01	1.45
4	*2412.00	104.43 AV			1.87 V	58	102.98	1.45
5	4824.00	50.39 PK	74.00	-23.61	1.73 V	254	40.97	9.42
6	4824.00	39.31 AV	54.00	-14.69	1.73 V	254	29.89	9.42

Remarks:

1. Emission Level(dBuV/m) = Raw Value(dBuV) + Correction Factor(dB/m)
2. Correction Factor(dB/m) = Antenna Factor(dB/m) + Cable Factor(dB) – Pre-Amplifier Factor(dB)
3. Margin value = Emission Level – Limit value
4. The other emission levels were very low against the limit.
5. " * ": Fundamental frequency.

RF Mode	TX 802.11b	Channel	CH 6 : 2437 MHz
Frequency Range	1GHz ~ 25GHz	Detector Function	Peak (PK) Average (AV)

Antenna Polarity & Test Distance : Horizontal at 3 m

No	Frequency (MHz)	Emission Level (dBuV/m)	Limit (dBuV/m)	Margin (dB)	Antenna Height (m)	Table Angle (Degree)	Raw Value (dBuV)	Correction Factor (dB/m)
1	2390.00	59.22 PK	74.00	-14.78	1.33 H	22	57.87	1.35
2	2390.00	52.65 AV	54.00	-1.35	1.33 H	22	51.30	1.35
3	*2437.00	115.71 PK			1.33 H	22	114.18	1.53
4	*2437.00	113.64 AV			1.33 H	22	112.11	1.53
5	4874.00	54.35 PK	74.00	-19.65	1.76 H	359	44.84	9.51
6	4874.00	48.02 AV	54.00	-5.98	1.76 H	359	38.51	9.51

Antenna Polarity & Test Distance : Vertical at 3 m

No	Frequency (MHz)	Emission Level (dBuV/m)	Limit (dBuV/m)	Margin (dB)	Antenna Height (m)	Table Angle (Degree)	Raw Value (dBuV)	Correction Factor (dB/m)
1	2390.00	55.98 PK	74.00	-18.02	1.92 V	61	54.63	1.35
2	2390.00	50.09 AV	54.00	-3.91	1.92 V	61	48.74	1.35
3	*2437.00	113.12 PK			1.92 V	61	111.59	1.53
4	*2437.00	110.98 AV			1.92 V	61	109.45	1.53
5	4874.00	52.02 PK	74.00	-21.98	1.67 V	250	42.51	9.51
6	4874.00	45.14 AV	54.00	-8.86	1.67 V	250	35.63	9.51

Remarks:

1. Emission Level(dBuV/m) = Raw Value(dBuV) + Correction Factor(dB/m)
2. Correction Factor(dB/m) = Antenna Factor(dB/m) + Cable Factor(dB) – Pre-Amplifier Factor(dB)
3. Margin value = Emission Level – Limit value
4. The other emission levels were very low against the limit.
5. " * ": Fundamental frequency.

RF Mode	TX 802.11b	Channel	CH 11 : 2462 MHz
Frequency Range	1GHz ~ 25GHz	Detector Function	Peak (PK) Average (AV)

Antenna Polarity & Test Distance : Horizontal at 3 m

No	Frequency (MHz)	Emission Level (dBuV/m)	Limit (dBuV/m)	Margin (dB)	Antenna Height (m)	Table Angle (Degree)	Raw Value (dBuV)	Correction Factor (dB/m)
1	*2462.00	111.43 PK			1.61 H	19	109.75	1.68
2	*2462.00	109.49 AV			1.61 H	19	107.81	1.68
3	2483.50	59.10 PK	74.00	-14.90	1.61 H	19	57.27	1.83
4	2483.50	52.86 AV	54.00	-1.14	1.61 H	19	51.03	1.83
5	4924.00	52.18 PK	74.00	-21.82	1.79 H	2	42.63	9.55
6	4924.00	43.19 AV	54.00	-10.81	1.79 H	2	33.64	9.55

Antenna Polarity & Test Distance : Vertical at 3 m

No	Frequency (MHz)	Emission Level (dBuV/m)	Limit (dBuV/m)	Margin (dB)	Antenna Height (m)	Table Angle (Degree)	Raw Value (dBuV)	Correction Factor (dB/m)
1	*2462.00	109.15 PK			1.85 V	57	107.47	1.68
2	*2462.00	107.06 AV			1.85 V	57	105.38	1.68
3	2483.50	56.73 PK	74.00	-17.27	1.85 V	57	54.90	1.83
4	2483.50	50.04 AV	54.00	-3.96	1.85 V	57	48.21	1.83
5	4924.00	50.45 PK	74.00	-23.55	1.69 V	257	40.90	9.55
6	4924.00	39.38 AV	54.00	-14.62	1.69 V	257	29.83	9.55

Remarks:

1. Emission Level(dBuV/m) = Raw Value(dBuV) + Correction Factor(dB/m)
2. Correction Factor(dB/m) = Antenna Factor(dB/m) + Cable Factor(dB) – Pre-Amplifier Factor(dB)
3. Margin value = Emission Level – Limit value
4. The other emission levels were very low against the limit.
5. " * ": Fundamental frequency.

RF Mode	TX 802.11g	Channel	CH 1 : 2412 MHz
Frequency Range	1GHz ~ 25GHz	Detector Function	Peak (PK) Average (AV)

Antenna Polarity & Test Distance : Horizontal at 3 m

No	Frequency (MHz)	Emission Level (dBuV/m)	Limit (dBuV/m)	Margin (dB)	Antenna Height (m)	Table Angle (Degree)	Raw Value (dBuV)	Correction Factor (dB/m)
1	2390.00	68.66 PK	74.00	-5.34	1.18 H	9	67.31	1.35
2	2390.00	52.41 AV	54.00	-1.59	1.18 H	9	51.06	1.35
3	*2412.00	110.74 PK			1.18 H	9	109.29	1.45
4	*2412.00	102.90 AV			1.18 H	9	101.45	1.45
5	4824.00	50.76 PK	74.00	-23.24	1.53 H	7	41.34	9.42
6	4824.00	40.80 AV	54.00	-13.20	1.53 H	7	31.38	9.42

Antenna Polarity & Test Distance : Vertical at 3 m

No	Frequency (MHz)	Emission Level (dBuV/m)	Limit (dBuV/m)	Margin (dB)	Antenna Height (m)	Table Angle (Degree)	Raw Value (dBuV)	Correction Factor (dB/m)
1	2390.00	61.52 PK	74.00	-12.48	2.10 V	57	60.17	1.35
2	2390.00	47.35 AV	54.00	-6.65	2.10 V	57	46.00	1.35
3	*2412.00	106.91 PK			2.10 V	57	105.46	1.45
4	*2412.00	99.20 AV			2.10 V	57	97.75	1.45
5	4824.00	50.18 PK	74.00	-23.82	1.77 V	249	40.76	9.42
6	4824.00	39.24 AV	54.00	-14.76	1.77 V	249	29.82	9.42

Remarks:

1. Emission Level(dBuV/m) = Raw Value(dBuV) + Correction Factor(dB/m)
2. Correction Factor(dB/m) = Antenna Factor(dB/m) + Cable Factor(dB) – Pre-Amplifier Factor(dB)
3. Margin value = Emission Level – Limit value
4. The other emission levels were very low against the limit.
5. " * ": Fundamental frequency.

RF Mode	TX 802.11g	Channel	CH 6 : 2437 MHz
Frequency Range	1GHz ~ 25GHz	Detector Function	Peak (PK) Average (AV)

Antenna Polarity & Test Distance : Horizontal at 3 m

No	Frequency (MHz)	Emission Level (dBuV/m)	Limit (dBuV/m)	Margin (dB)	Antenna Height (m)	Table Angle (Degree)	Raw Value (dBuV)	Correction Factor (dB/m)
1	2390.00	68.58 PK	74.00	-5.42	1.48 H	16	67.23	1.35
2	2390.00	52.69 AV	54.00	-1.31	1.48 H	16	51.34	1.35
3	*2437.00	118.53 PK			1.48 H	16	117.00	1.53
4	*2437.00	110.88 AV			1.48 H	16	109.35	1.53
5	4874.00	53.12 PK	74.00	-20.88	1.79 H	357	43.61	9.51
6	4874.00	45.95 AV	54.00	-8.05	1.79 H	357	36.44	9.51

Antenna Polarity & Test Distance : Vertical at 3 m

No	Frequency (MHz)	Emission Level (dBuV/m)	Limit (dBuV/m)	Margin (dB)	Antenna Height (m)	Table Angle (Degree)	Raw Value (dBuV)	Correction Factor (dB/m)
1	2390.00	62.37 PK	74.00	-11.63	1.96 V	65	61.02	1.35
2	2390.00	48.08 AV	54.00	-5.92	1.96 V	65	46.73	1.35
3	*2437.00	114.81 PK			1.96 V	65	113.28	1.53
4	*2437.00	107.29 AV			1.96 V	65	105.76	1.53
5	4874.00	50.74 PK	74.00	-23.26	1.71 V	256	41.23	9.51
6	4874.00	43.62 AV	54.00	-10.38	1.71 V	256	34.11	9.51

Remarks:

1. Emission Level(dBuV/m) = Raw Value(dBuV) + Correction Factor(dB/m)
2. Correction Factor(dB/m) = Antenna Factor(dB/m) + Cable Factor(dB) – Pre-Amplifier Factor(dB)
3. Margin value = Emission Level – Limit value
4. The other emission levels were very low against the limit.
5. " * ": Fundamental frequency.

RF Mode	TX 802.11g	Channel	CH 11 : 2462 MHz
Frequency Range	1GHz ~ 25GHz	Detector Function	Peak (PK) Average (AV)

Antenna Polarity & Test Distance : Horizontal at 3 m

No	Frequency (MHz)	Emission Level (dBuV/m)	Limit (dBuV/m)	Margin (dB)	Antenna Height (m)	Table Angle (Degree)	Raw Value (dBuV)	Correction Factor (dB/m)
1	*2462.00	111.38 PK			1.47 H	27	109.70	1.68
2	*2462.00	103.87 AV			1.47 H	27	102.19	1.68
3	2483.50	70.61 PK	74.00	-3.39	1.47 H	27	68.78	1.83
4	2483.50	52.81 AV	54.00	-1.19	1.47 H	27	50.98	1.83
5	4924.00	50.85 PK	74.00	-23.15	1.78 H	4	41.30	9.55
6	4924.00	40.94 AV	54.00	-13.06	1.78 H	4	31.39	9.55

Antenna Polarity & Test Distance : Vertical at 3 m

No	Frequency (MHz)	Emission Level (dBuV/m)	Limit (dBuV/m)	Margin (dB)	Antenna Height (m)	Table Angle (Degree)	Raw Value (dBuV)	Correction Factor (dB/m)
1	*2462.00	107.73 PK			2.06 V	61	106.05	1.68
2	*2462.00	100.27 AV			2.06 V	61	98.59	1.68
3	2483.50	64.54 PK	74.00	-9.46	2.06 V	61	62.71	1.83
4	2483.50	48.19 AV	54.00	-5.81	2.06 V	61	46.36	1.83
5	4924.00	50.31 PK	74.00	-23.69	2.06 V	260	40.76	9.55
6	4924.00	40.51 AV	54.00	-13.49	2.06 V	260	30.96	9.55

Remarks:

1. Emission Level(dBuV/m) = Raw Value(dBuV) + Correction Factor(dB/m)
2. Correction Factor(dB/m) = Antenna Factor(dB/m) + Cable Factor(dB) – Pre-Amplifier Factor(dB)
3. Margin value = Emission Level – Limit value
4. The other emission levels were very low against the limit.
5. " * ": Fundamental frequency.

RF Mode	TX 802.11n (20MHz)	Channel	CH 1 : 2412 MHz
Frequency Range	1GHz ~ 25GHz	Detector Function	Peak (PK) Average (AV)

Antenna Polarity & Test Distance : Horizontal at 3 m

No	Frequency (MHz)	Emission Level (dBuV/m)	Limit (dBuV/m)	Margin (dB)	Antenna Height (m)	Table Angle (Degree)	Raw Value (dBuV)	Correction Factor (dB/m)
1	2390.00	68.70 PK	74.00	-5.30	1.06 H	16	67.35	1.35
2	2390.00	52.64 AV	54.00	-1.36	1.06 H	16	51.29	1.35
3	*2412.00	110.76 PK			1.06 H	16	109.31	1.45
4	*2412.00	103.15 AV			1.06 H	16	101.70	1.45
5	4824.00	50.55 PK	74.00	-23.45	1.55 H	3	41.13	9.42
6	4824.00	40.67 AV	54.00	-13.33	1.55 H	3	31.25	9.42

Antenna Polarity & Test Distance : Vertical at 3 m

No	Frequency (MHz)	Emission Level (dBuV/m)	Limit (dBuV/m)	Margin (dB)	Antenna Height (m)	Table Angle (Degree)	Raw Value (dBuV)	Correction Factor (dB/m)
1	2390.00	61.38 PK	74.00	-12.62	2.08 V	59	60.03	1.35
2	2390.00	47.42 AV	54.00	-6.58	2.08 V	59	46.07	1.35
3	*2412.00	106.93 PK			2.08 V	59	105.48	1.45
4	*2412.00	99.39 AV			2.08 V	59	97.94	1.45
5	4824.00	50.22 PK	74.00	-23.78	1.75 V	253	40.80	9.42
6	4824.00	39.31 AV	54.00	-14.69	1.75 V	253	29.89	9.42

Remarks:

1. Emission Level(dBuV/m) = Raw Value(dBuV) + Correction Factor(dB/m)
2. Correction Factor(dB/m) = Antenna Factor(dB/m) + Cable Factor(dB) – Pre-Amplifier Factor(dB)
3. Margin value = Emission Level – Limit value
4. The other emission levels were very low against the limit.
5. " * ": Fundamental frequency.

RF Mode	TX 802.11n (20MHz)	Channel	CH 6 : 2437 MHz
Frequency Range	1GHz ~ 25GHz	Detector Function	Peak (PK) Average (AV)

Antenna Polarity & Test Distance : Horizontal at 3 m

No	Frequency (MHz)	Emission Level (dBuV/m)	Limit (dBuV/m)	Margin (dB)	Antenna Height (m)	Table Angle (Degree)	Raw Value (dBuV)	Correction Factor (dB/m)
1	2390.00	66.58 PK	74.00	-7.42	1.18 H	43	65.23	1.35
2	2390.00	52.55 AV	54.00	-1.45	1.18 H	43	51.20	1.35
3	*2437.00	117.39 PK			1.18 H	43	115.86	1.53
4	*2437.00	110.25 AV			1.18 H	43	108.72	1.53
5	4874.00	52.91 PK	74.00	-21.09	1.74 H	355	43.40	9.51
6	4874.00	45.82 AV	54.00	-8.18	1.74 H	355	36.31	9.51

Antenna Polarity & Test Distance : Vertical at 3 m

No	Frequency (MHz)	Emission Level (dBuV/m)	Limit (dBuV/m)	Margin (dB)	Antenna Height (m)	Table Angle (Degree)	Raw Value (dBuV)	Correction Factor (dB/m)
1	2390.00	61.49 PK	74.00	-12.51	2.11 V	63	60.14	1.35
2	2390.00	47.76 AV	54.00	-6.24	2.11 V	63	46.41	1.35
3	*2437.00	113.53 PK			2.11 V	63	112.00	1.53
4	*2437.00	106.22 AV			2.11 V	63	104.69	1.53
5	4874.00	50.61 PK	74.00	-23.39	1.77 V	248	41.10	9.51
6	4874.00	43.54 AV	54.00	-10.46	1.77 V	248	34.03	9.51

Remarks:

1. Emission Level(dBuV/m) = Raw Value(dBuV) + Correction Factor(dB/m)
2. Correction Factor(dB/m) = Antenna Factor(dB/m) + Cable Factor(dB) – Pre-Amplifier Factor(dB)
3. Margin value = Emission Level – Limit value
4. The other emission levels were very low against the limit.
5. " * ": Fundamental frequency.

RF Mode	TX 802.11n (20MHz)	Channel	CH 11 : 2462 MHz
Frequency Range	1GHz ~ 25GHz	Detector Function	Peak (PK) Average (AV)

Antenna Polarity & Test Distance : Horizontal at 3 m

No	Frequency (MHz)	Emission Level (dBuV/m)	Limit (dBuV/m)	Margin (dB)	Antenna Height (m)	Table Angle (Degree)	Raw Value (dBuV)	Correction Factor (dB/m)
1	*2462.00	110.68 PK			1.48 H	25	109.00	1.68
2	*2462.00	103.53 AV			1.48 H	25	101.85	1.68
3	2483.50	68.24 PK	74.00	-5.76	1.48 H	25	66.41	1.83
4	2483.50	52.73 AV	54.00	-1.27	1.48 H	25	50.90	1.83
5	4924.00	50.93 PK	74.00	-23.07	1.72 H	5	41.38	9.55
6	4924.00	41.05 AV	54.00	-12.95	1.72 H	5	31.50	9.55

Antenna Polarity & Test Distance : Vertical at 3 m

No	Frequency (MHz)	Emission Level (dBuV/m)	Limit (dBuV/m)	Margin (dB)	Antenna Height (m)	Table Angle (Degree)	Raw Value (dBuV)	Correction Factor (dB/m)
1	*2462.00	107.25 PK			1.94 V	56	105.57	1.68
2	*2462.00	99.71 AV			1.94 V	56	98.03	1.68
3	2483.50	62.93 PK	74.00	-11.07	1.94 V	56	61.10	1.83
4	2483.50	47.51 AV	54.00	-6.49	1.94 V	56	45.68	1.83
5	4924.00	50.37 PK	74.00	-23.63	1.82 V	252	40.82	9.55
6	4924.00	40.61 AV	54.00	-13.39	1.82 V	252	31.06	9.55

Remarks:

1. Emission Level(dBuV/m) = Raw Value(dBuV) + Correction Factor(dB/m)
2. Correction Factor(dB/m) = Antenna Factor(dB/m) + Cable Factor(dB) – Pre-Amplifier Factor(dB)
3. Margin value = Emission Level – Limit value
4. The other emission levels were very low against the limit.
5. " * ": Fundamental frequency.

RF Mode	TX 802.11n (40MHz)	Channel	CH 3 : 2422 MHz
Frequency Range	1GHz ~ 25GHz	Detector Function	Peak (PK) Average (AV)

Antenna Polarity & Test Distance : Horizontal at 3 m

No	Frequency (MHz)	Emission Level (dBuV/m)	Limit (dBuV/m)	Margin (dB)	Antenna Height (m)	Table Angle (Degree)	Raw Value (dBuV)	Correction Factor (dB/m)
1	2390.00	69.52 PK	74.00	-4.48	1.20 H	10	68.17	1.35
2	2390.00	52.84 AV	54.00	-1.16	1.20 H	10	51.49	1.35
3	*2422.00	107.36 PK			1.20 H	10	105.87	1.49
4	*2422.00	99.64 AV			1.20 H	10	98.15	1.49
5	4844.00	50.28 PK	74.00	-23.72	1.58 H	4	40.82	9.46
6	4844.00	40.52 AV	54.00	-13.48	1.58 H	4	31.06	9.46

Antenna Polarity & Test Distance : Vertical at 3 m

No	Frequency (MHz)	Emission Level (dBuV/m)	Limit (dBuV/m)	Margin (dB)	Antenna Height (m)	Table Angle (Degree)	Raw Value (dBuV)	Correction Factor (dB/m)
1	2390.00	63.98 PK	74.00	-10.02	2.09 V	59	62.63	1.35
2	2390.00	47.97 AV	54.00	-6.03	2.09 V	59	46.62	1.35
3	*2422.00	103.89 PK			2.09 V	59	102.40	1.49
4	*2422.00	96.41 AV			2.09 V	59	94.92	1.49
5	4844.00	50.05 PK	74.00	-23.95	1.78 V	256	40.59	9.46
6	4844.00	40.31 AV	54.00	-13.69	1.78 V	256	30.85	9.46

Remarks:

1. Emission Level(dBuV/m) = Raw Value(dBuV) + Correction Factor(dB/m)
2. Correction Factor(dB/m) = Antenna Factor(dB/m) + Cable Factor(dB) – Pre-Amplifier Factor(dB)
3. Margin value = Emission Level – Limit value
4. The other emission levels were very low against the limit.
5. " * ": Fundamental frequency.

RF Mode	TX 802.11n (40MHz)	Channel	CH 6 : 2437 MHz
Frequency Range	1GHz ~ 25GHz	Detector Function	Peak (PK) Average (AV)

Antenna Polarity & Test Distance : Horizontal at 3 m

No	Frequency (MHz)	Emission Level (dBuV/m)	Limit (dBuV/m)	Margin (dB)	Antenna Height (m)	Table Angle (Degree)	Raw Value (dBuV)	Correction Factor (dB/m)
1	2390.00	65.66 PK	74.00	-8.34	1.21 H	18	64.31	1.35
2	2390.00	52.72 AV	54.00	-1.28	1.21 H	18	51.37	1.35
3	*2437.00	109.17 PK			1.21 H	18	107.64	1.53
4	*2437.00	101.46 AV			1.21 H	18	99.93	1.53
5	4874.00	50.91 PK	74.00	-23.09	1.62 H	358	41.40	9.51
6	4874.00	41.06 AV	54.00	-12.94	1.62 H	358	31.55	9.51

Antenna Polarity & Test Distance : Vertical at 3 m

No	Frequency (MHz)	Emission Level (dBuV/m)	Limit (dBuV/m)	Margin (dB)	Antenna Height (m)	Table Angle (Degree)	Raw Value (dBuV)	Correction Factor (dB/m)
1	2390.00	59.74 PK	74.00	-14.26	2.03 V	62	58.39	1.35
2	2390.00	47.23 AV	54.00	-6.77	2.03 V	62	45.88	1.35
3	*2437.00	105.82 PK			2.03 V	62	104.29	1.53
4	*2437.00	98.19 AV			2.03 V	62	96.66	1.53
5	4874.00	50.39 PK	74.00	-23.61	1.82 V	250	40.88	9.51
6	4874.00	40.53 AV	54.00	-13.47	1.82 V	250	31.02	9.51

Remarks:

1. Emission Level(dBuV/m) = Raw Value(dBuV) + Correction Factor(dB/m)
2. Correction Factor(dB/m) = Antenna Factor(dB/m) + Cable Factor(dB) – Pre-Amplifier Factor(dB)
3. Margin value = Emission Level – Limit value
4. The other emission levels were very low against the limit.
5. " * ": Fundamental frequency.

RF Mode	TX 802.11n (40MHz)	Channel	CH 9 : 2452 MHz
Frequency Range	1GHz ~ 25GHz	Detector Function	Peak (PK) Average (AV)

Antenna Polarity & Test Distance : Horizontal at 3 m

No	Frequency (MHz)	Emission Level (dBuV/m)	Limit (dBuV/m)	Margin (dB)	Antenna Height (m)	Table Angle (Degree)	Raw Value (dBuV)	Correction Factor (dB/m)
1	*2452.00	107.16 PK			1.19 H	43	105.55	1.61
2	*2452.00	99.42 AV			1.19 H	43	97.81	1.61
3	2483.50	66.16 PK	74.00	-7.84	1.19 H	43	64.33	1.83
4	2483.50	52.57 AV	54.00	-1.43	1.19 H	43	50.74	1.83
5	4904.00	50.36 PK	74.00	-23.64	1.53 H	12	40.81	9.55
6	4904.00	40.57 AV	54.00	-13.43	1.53 H	12	31.02	9.55

Antenna Polarity & Test Distance : Vertical at 3 m

No	Frequency (MHz)	Emission Level (dBuV/m)	Limit (dBuV/m)	Margin (dB)	Antenna Height (m)	Table Angle (Degree)	Raw Value (dBuV)	Correction Factor (dB/m)
1	*2452.00	103.42 PK			2.13 V	56	101.81	1.61
2	*2452.00	95.68 AV			2.13 V	56	94.07	1.61
3	2483.50	61.03 PK	74.00	-12.97	2.13 V	56	59.20	1.83
4	2483.50	47.59 AV	54.00	-6.41	2.13 V	56	45.76	1.83
5	4904.00	50.13 PK	74.00	-23.87	1.77 V	259	40.58	9.55
6	4904.00	40.37 AV	54.00	-13.63	1.77 V	259	30.82	9.55

Remarks:

1. Emission Level(dBuV/m) = Raw Value(dBuV) + Correction Factor(dB/m)
2. Correction Factor(dB/m) = Antenna Factor(dB/m) + Cable Factor(dB) – Pre-Amplifier Factor(dB)
3. Margin value = Emission Level – Limit value
4. The other emission levels were very low against the limit.
5. " * ": Fundamental frequency.

BELOW 1GHz WORST-CASE DATA

RF Mode	TX 802.11g	Channel	CH 6 : 2437 MHz
Frequency Range	9kHz ~ 1GHz	Detector Function	Quasi-Peak (QP)

Antenna Polarity & Test Distance : Horizontal at 3 m								
No	Frequency (MHz)	Emission Level (dBuV/m)	Limit (dBuV/m)	Margin (dB)	Antenna Height (m)	Table Angle (Degree)	Raw Value (dBuV)	Correction Factor (dB/m)
1	80.73	33.58 QP	40.00	-6.42	1.27 H	290	45.48	-11.90
2	169.63	31.14 QP	43.50	-12.36	1.50 H	12	37.83	-6.69
3	250.00	27.60 QP	46.00	-18.40	1.46 H	233	34.20	-6.60
4	375.03	33.44 QP	46.00	-12.56	1.85 H	60	36.11	-2.67
5	500.01	30.07 QP	46.00	-15.93	2.14 H	326	30.14	-0.07
6	637.12	31.10 QP	46.00	-14.90	1.91 H	123	28.04	3.06

Remarks:

1. Emission Level(dBuV/m) = Raw Value(dBuV) + Correction Factor(dB/m)
2. Correction Factor(dB/m) = Antenna Factor(dB/m) + Cable Factor(dB) – Pre-Amplifier Factor(dB)
3. Margin value = Emission Level – Limit value
4. The other emission levels were very low against the limit of frequency range 30MHz~1000MHz.
5. The emission levels were very low against the limit of frequency range 9kHz~30MHz: the amplitude of spurious emissions attenuated more than 20 dB below the permissible value to be report.

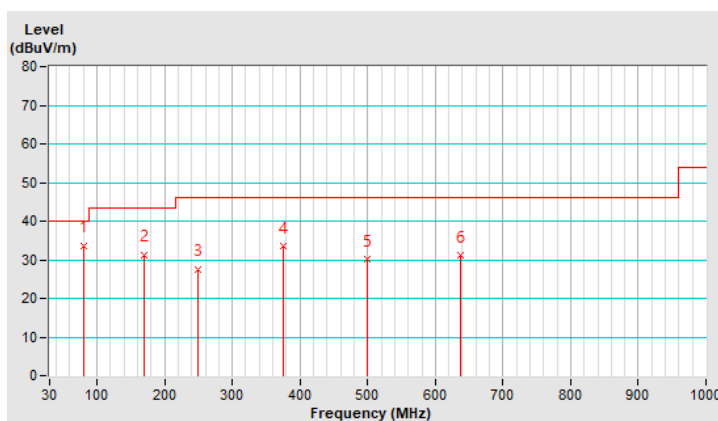

RF Mode	TX 802.11g	Channel	CH 6 : 2437 MHz
Frequency Range	9kHz ~ 1GHz	Detector Function	Quasi-Peak (QP)

Antenna Polarity & Test Distance : Vertical at 3 m								
No	Frequency (MHz)	Emission Level (dBuV/m)	Limit (dBuV/m)	Margin (dB)	Antenna Height (m)	Table Angle (Degree)	Raw Value (dBuV)	Correction Factor (dB/m)
1	42.90	32.64 QP	40.00	-7.36	1.63 V	22	40.16	-7.52
2	137.57	29.92 QP	43.50	-13.58	1.27 V	166	37.24	-7.32
3	168.13	30.23 QP	43.50	-13.27	1.58 V	267	36.92	-6.69
4	250.00	30.28 QP	46.00	-15.72	1.89 V	77	36.88	-6.60
5	374.98	35.83 QP	46.00	-10.17	2.10 V	309	38.50	-2.67
6	625.00	31.86 QP	46.00	-14.14	1.73 V	349	29.01	2.85

Remarks:

1. Emission Level(dBuV/m) = Raw Value(dBuV) + Correction Factor(dB/m)
2. Correction Factor(dB/m) = Antenna Factor(dB/m) + Cable Factor(dB) – Pre-Amplifier Factor(dB)
3. Margin value = Emission Level – Limit value
4. The other emission levels were very low against the limit of frequency range 30MHz~1000MHz.
5. The emission levels were very low against the limit of frequency range 9kHz~30MHz: the amplitude of spurious emissions attenuated more than 20 dB below the permissible value to be report.

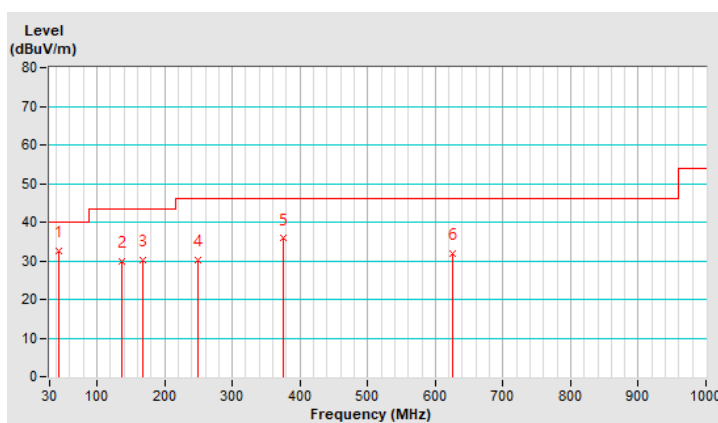

4.2 Conducted Emission Measurement

4.2.1 Limits of Conducted Emission Measurement

Frequency (MHz)	Conducted Limit (dBuV)	
	Quasi-peak	Average
0.15 - 0.5	66 - 56	56 - 46
0.50 - 5.0	56	46
5.0 - 30.0	60	50

- Note:** 1. The lower limit shall apply at the transition frequencies.
 2. The limit decreases in line with the logarithm of the frequency in the range of 0.15 to 0.50MHz.

4.2.2 Test Instruments

Description & Manufacturer	Model No.	Serial No.	Cal. Date	Cal. Due
ROHDE & SCHWARZ TEST RECEIVER	ESCS30	100276	Apr. 16, 2020	Apr. 15, 2021
SCHWARZBECK Artificial Mains Network (for EUT)	NSLK 8128	8128-244	Nov. 19, 2020	Nov. 18, 2021
LISN With Adapter (for EUT)	AD10	C05Ada-001	Nov. 19, 2020	Nov. 18, 2021
R&S Artificial Mains Network (for peripheral)	ESH3-Z5	100220	Dec. 1, 2020	Nov. 30, 2021
Software	Cond_V7.3.7.4	NA	NA	NA
RF cable (JYEBAO) With 10dB PAD	5D-FB	Cable-C05.01	Jan. 30, 2020	Jan. 29, 2021
LYNICS Terminator (For R&S LISN)	0900510	E1-01-305	Feb. 17, 2020	Feb. 16, 2021

- Note:** 1. The calibration interval of the above test instruments is 12 months and the calibrations are traceable to NML/ROC and NIST/USA.
 2. The test was performed in Shielded Room No. 5. (Conduction 5)
 3. The VCCI Site Registration No. C-11093.

4.2.3 Test Procedures

- The EUT was placed 0.4 meters from the conducting wall of the shielded room with EUT being connected to the power mains through a line impedance stabilization network (LISN). Other support units were connected to the power mains through another LISN. The two LISNs provide 50 ohm/ 50uH of coupling impedance for the measuring instrument.
- Both lines of the power mains connected to the EUT were checked for maximum conducted interference.
- The frequency range from 150kHz to 30MHz was searched. Emission levels under (Limit - 20dB) was not recorded.

Note: The resolution bandwidth and video bandwidth of test receiver is 9kHz for quasi-peak detection (QP) and average detection (AV) at frequency 0.15MHz-30MHz.

4.2.4 Deviation from Test Standard

No deviation.

4.2.5 Test Setup

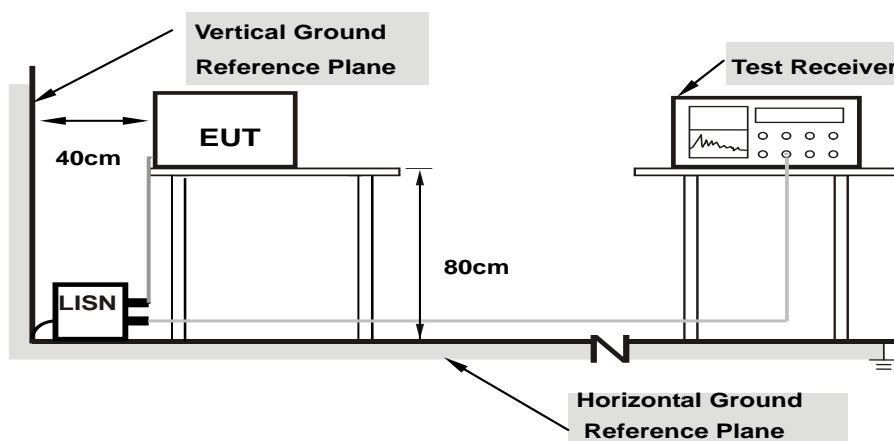

Note: 1.Support units were connected to second LISN.

For the actual test configuration, please refer to the attached file (Test Setup Photo).

4.2.6 EUT Operating Conditions

Same as 4.1.6.

4.2.7 Test Results

802.11g

Phase	Line (L)	Detector Function	Quasi-Peak (QP) / Average (AV)
-------	----------	-------------------	--------------------------------

No	Frequency (MHz)	Correction Factor (dB)	Reading Value (dBuV)		Emission Level (dBuV)		Limit (dBuV)		Margin (dB)	
			Q.P.	AV.	Q.P.	AV.	Q.P.	AV.	Q.P.	AV.
1	0.15781	9.86	35.49	20.75	45.35	30.61	65.58	55.58	-20.23	-24.97
2	0.43906	9.88	29.97	27.03	39.85	36.91	57.08	47.08	-17.23	-10.17
3	0.82969	9.90	17.58	12.90	27.48	22.80	56.00	46.00	-28.52	-23.20
4	3.38281	9.98	18.13	7.52	28.11	17.50	56.00	46.00	-27.89	-28.50
5	9.92188	10.17	13.90	4.54	24.07	14.71	60.00	50.00	-35.93	-35.29
6	19.65234	10.41	11.94	5.35	22.35	15.76	60.00	50.00	-37.65	-34.24

Remarks:

1. Q.P. and AV. are abbreviations of quasi-peak and average individually.
2. The emission levels of other frequencies were very low against the limit.
3. Margin value = Emission level – Limit value
4. Correction factor = Insertion loss + Cable loss
5. Emission Level = Correction Factor + Reading Value

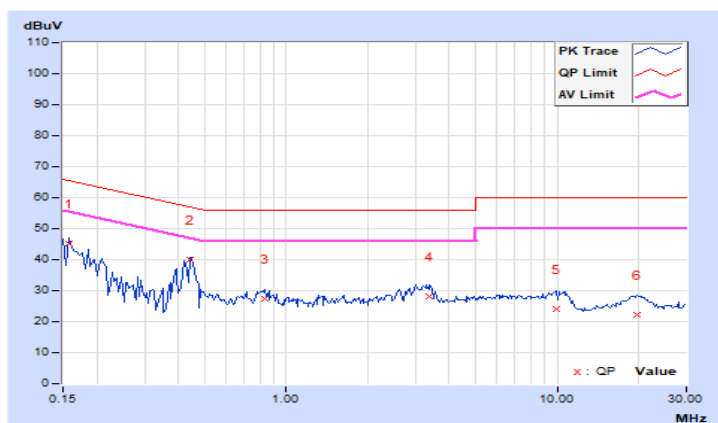

Phase	Neutral (N)	Detector Function	Quasi-Peak (QP) / Average (AV)
-------	-------------	-------------------	--------------------------------

No	Frequency (MHz)	Correction Factor (dB)	Reading Value (dBuV)		Emission Level (dBuV)		Limit (dBuV)		Margin (dB)	
			Q.P.	AV.	Q.P.	AV.	Q.P.	AV.	Q.P.	AV.
1	0.15781	9.87	35.19	20.08	45.06	29.95	65.58	55.58	-20.52	-25.63
2	0.43906	9.89	29.89	27.03	39.78	36.92	57.08	47.08	-17.30	-10.16
3	0.86094	9.91	16.76	10.27	26.67	20.18	56.00	46.00	-29.33	-25.82
4	3.05078	9.98	17.25	6.47	27.23	16.45	56.00	46.00	-28.77	-29.55
5	10.61328	10.20	16.54	5.99	26.74	16.19	60.00	50.00	-33.26	-33.81
6	19.87891	10.45	11.26	4.79	21.71	15.24	60.00	50.00	-38.29	-34.76

Remarks:

1. Q.P. and AV. are abbreviations of quasi-peak and average individually.
2. The emission levels of other frequencies were very low against the limit.
3. Margin value = Emission level – Limit value
4. Correction factor = Insertion loss + Cable loss
5. Emission Level = Correction Factor + Reading Value

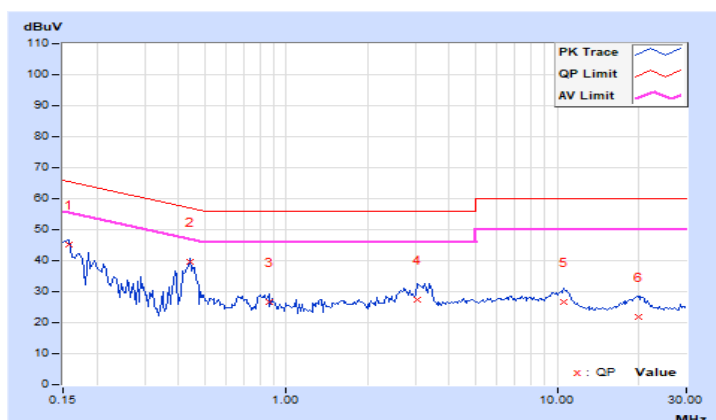

4.3 6dB Bandwidth Measurement

4.3.1 Limits of 6dB Bandwidth Measurement

The minimum of 6dB Bandwidth Measurement is 0.5 MHz.

4.3.2 Test Setup

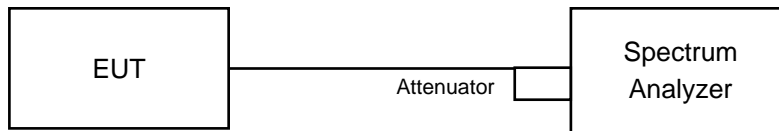

4.3.3 Test Instruments

Refer to section 4.1.2 to get information of above instrument.

4.3.4 Test Procedure

- Set resolution bandwidth (RBW) = 100kHz.
- Set the video bandwidth (VBW) $\geq 3 \times$ RBW, Detector = peak.
- Trace mode = max hold.
- Sweep = auto couple.
- Measure the maximum width of the emission that is constrained by the frequencies associated with the two amplitude points (upper and lower) that are attenuated by 6 dB relative to the maximum level measured in the fundamental emission.

4.3.5 Deviation from Test Standard

No deviation.

4.3.6 EUT Operating Conditions

The software provided by client to enable the EUT under transmission condition continuously at lowest, middle and highest channel frequencies individually.

4.3.7 Test Result

802.11b

Channel	Frequency (MHz)	6dB Bandwidth (MHz)		Minimum Limit (MHz)	Pass / Fail
		Chain 0	Chain 1		
1	2412	10.13	10.14	0.5	Pass
6	2437	10.14	10.13	0.5	Pass
11	2462	10.13	10.14	0.5	Pass

802.11g

Channel	Frequency (MHz)	6dB Bandwidth (MHz)		Minimum Limit (MHz)	Pass / Fail
		Chain 0	Chain 1		
1	2412	15.85	16.33	0.5	Pass
6	2437	15.72	15.96	0.5	Pass
11	2462	15.85	16.10	0.5	Pass

802.11n (20MHz)

Channel	Frequency (MHz)	6dB Bandwidth (MHz)		Minimum Limit (MHz)	Pass / Fail
		Chain 0	Chain 1		
1	2412	16.57	16.69	0.5	Pass
6	2437	16.34	16.34	0.5	Pass
11	2462	16.57	16.68	0.5	Pass

802.11n (40MHz)

Channel	Frequency (MHz)	6dB Bandwidth (MHz)		Minimum Limit (MHz)	Pass / Fail
		Chain 0	Chain 1		
3	2422	35.27	35.25	0.5	Pass
6	2437	35.27	35.54	0.5	Pass
9	2452	35.27	35.26	0.5	Pass

Spectrum Plot of Worst Value

802.11b

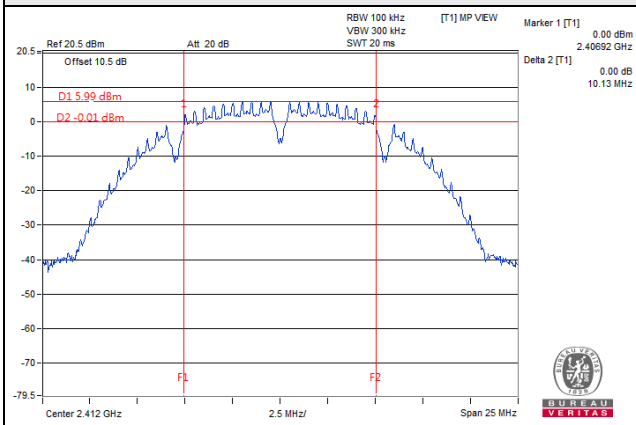

802.11g

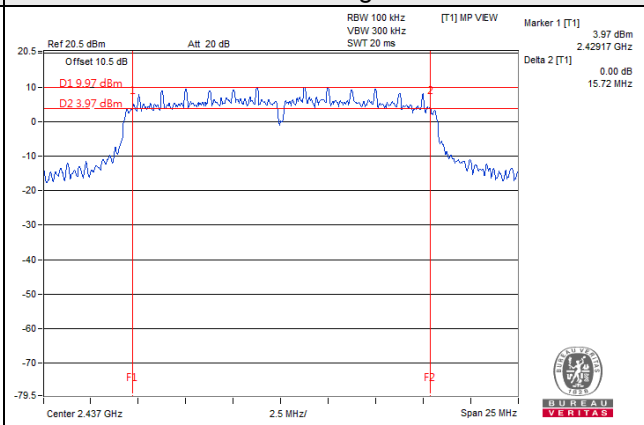

802.11n (20MHz)

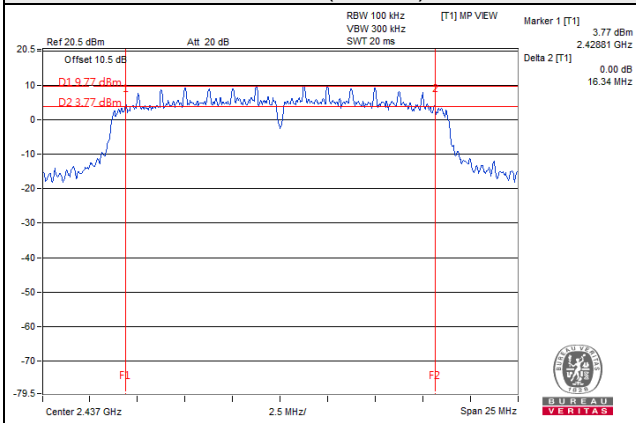

802.11n (40MHz)

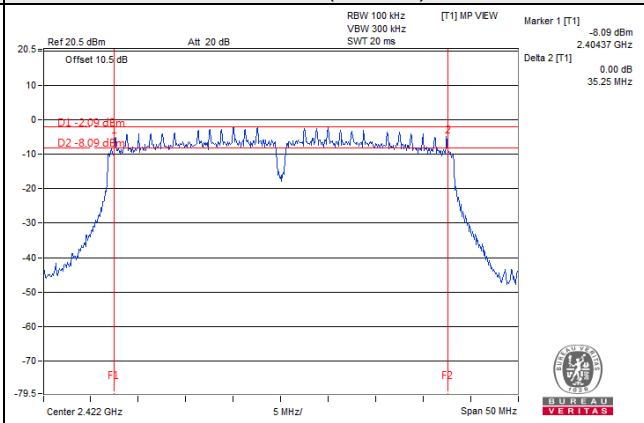

4.4 Conducted Output Power Measurement

4.4.1 Limits of Conducted Output Power Measurement

For systems using digital modulation in the 2400–2483.5 MHz bands: 1 Watt (30dBm)

Per KDB 662911 D01 Multiple Transmitter Output Method of conducted output power measurement on IEEE 802.11 devices,

Array Gain = 0 dB (i.e., no array gain) for $N_{ANT} \leq 4$;

Array Gain = 0 dB (i.e., no array gain) for channel widths ≥ 40 MHz for any N_{ANT} ;

Array Gain = $5 \log(N_{ANT}/N_{SS})$ dB or 3 dB, whichever is less for 20-MHz channel widths with $N_{ANT} \geq 5$.

For power measurements on all other devices: Array Gain = $10 \log(N_{ANT}/N_{SS})$ dB.

4.4.2 Test Setup

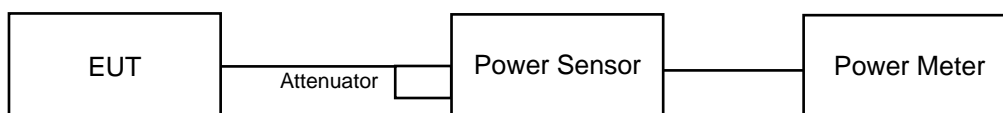

4.4.3 Test Instruments

Refer to section 4.1.2 to get information of above instrument.

4.4.4 Test Procedures

A peak power sensor was used on the output port of the EUT. A power meter was used to read the response of the peak power sensor. Record the power level.

Average power sensor was used to perform output power measurement, trigger and gating function of wide band power meter is enabled to measure max output power of TX on burst. Duty factor is not added to measured value.

4.4.5 Deviation from Test Standard

No deviation.

4.4.6 EUT Operating Conditions

Same as item 4.3.6.

4.4.7 Test Results

FOR PEAK POWER

802.11b

Chan.	Chan. Freq. (MHz)	Peak Power (dBm)		Total Power (mW)	Total Power (dBm)	Limit (dBm)	Pass / Fail
		Chain 0	Chain 1				
1	2412	18.61	18.65	145.893	21.64	30	Pass
6	2437	24.17	24.06	515.899	27.13	30	Pass
11	2462	19.63	19.73	185.806	22.69	30	Pass

802.11g

Chan.	Chan. Freq. (MHz)	Peak Power (dBm)		Total Power (mW)	Total Power (dBm)	Limit (dBm)	Pass / Fail
		Chain 0	Chain 1				
1	2412	23.38	23.48	440.614	26.44	30	Pass
6	2437	27.19	26.00	921.708	29.65	30	Pass
11	2462	23.70	23.22	444.317	26.48	30	Pass

802.11n (20MHz)

Chan.	Chan. Freq. (MHz)	Peak Power (dBm)		Total Power (mW)	Total Power (dBm)	Limit (dBm)	Pass / Fail
		Chain 0	Chain 1				
1	2412	23.64	23.58	459.241	26.62	30	Pass
6	2437	26.85	25.74	859.145	29.34	30	Pass
11	2462	24.53	22.82	475.217	26.77	30	Pass

802.11n (40MHz)

Chan.	Chan. Freq. (MHz)	Peak Power (dBm)		Total Power (mW)	Total Power (dBm)	Limit (dBm)	Pass / Fail
		Chain 0	Chain 1				
3	2422	22.55	21.77	330.201	25.19	30	Pass
6	2437	23.16	23.42	426.800	26.30	30	Pass
9	2452	21.86	22.65	337.539	25.28	30	Pass

FOR AVERAGE POWER

802.11b

Chan.	Frequency (MHz)	Avg. Power (dBm)		Total Avg.Power (mW)	Total Avg.Power (dBm)
		Chain 0	Chain 1		
1	2412	16.54	16.68	91.640	19.62
6	2437	22.33	22.50	348.829	25.43
11	2462	17.64	17.74	117.506	20.70

802.11g

Chan.	Frequency (MHz)	Avg. Power (dBm)		Total Avg.Power (mW)	Total Avg.Power (dBm)
		Chain 0	Chain 1		
1	2412	14.64	14.63	58.147	17.65
6	2437	21.72	21.79	299.602	24.77
11	2462	15.35	15.47	69.514	18.42

802.11n (20MHz)

Chan.	Frequency (MHz)	Avg. Power (dBm)		Total Avg.Power (mW)	Total Avg.Power (dBm)
		Chain 0	Chain 1		
1	2412	13.97	13.96	49.835	16.98
6	2437	21.50	21.51	282.833	24.52
11	2462	14.70	14.76	59.435	17.74

802.11n (40MHz)

Chan.	Frequency (MHz)	Avg. Power (dBm)		Total Avg.Power (mW)	Total Avg.Power (dBm)
		Chain 0	Chain 1		
3	2422	13.02	12.99	39.951	16.02
6	2437	14.67	14.63	58.349	17.66
9	2452	13.23	13.38	42.815	16.32

4.5 Power Spectral Density Measurement

4.5.1 Limits of Power Spectral Density Measurement

The Maximum of Power Spectral Density Measurement is 8dBm/3kHz.

4.5.2 Test Setup

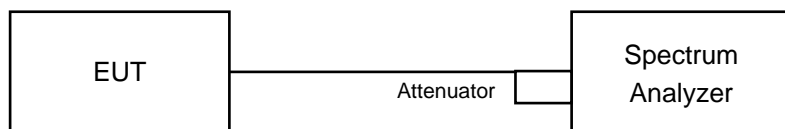

4.5.3 Test Instruments

Refer to section 4.1.2 to get information of above instrument.

4.5.4 Test Procedure

- Set analyzer center frequency to DTS channel center frequency.
- Set the span to 1.5 times the DTS bandwidth.
- Set the RBW to: $3 \text{ kHz} \leq \text{RBW} \leq 100 \text{ kHz}$.
- Set the VBW $\geq 3 \times \text{RBW}$.
- Detector = peak.
- Sweep time = auto couple.
- Trace mode = max hold.
- Allow trace to fully stabilize.
- Use the peak marker function to determine the maximum amplitude level within the RBW.

4.5.5 Deviation from Test Standard

No deviation.

4.5.6 EUT Operating Condition

Same as item 4.3.6.

4.5.7 Test Results

802.11b

Chan.	Freq. (MHz)	PSD (dBm/3kHz)		Total PSD (dBm/3kHz)	Limit (dBm/3kHz)	Pass / Fail
		Chain 0	Chain 1			
1	2412	-7.55	-7.71	-4.62	7.84	Pass
6	2437	-2.02	-1.96	1.02	7.84	Pass
11	2462	-7.01	-6.92	-3.95	7.84	Pass

Note:

- Method E) 2) c) of power density measurement of KDB 662911 is using for calculating total power density.
- Directional gain = $10 \log[(10^{G1/10} + 10^{G2/10} + \dots + 10^{GN/10})/N_{ANT}] = 6.16 \text{dBi} > 6 \text{dBi}$, so the power density limit shall be reduced to $8 - (6.16 - 6) = 7.84 \text{dBm}$.

802.11g

Chan.	Freq. (MHz)	PSD (dBm/3kHz)		Total PSD (dBm/3kHz)	Limit (dBm/3kHz)	Pass / Fail
		Chain 0	Chain 1			
1	2412	-11.84	-12.40	-9.10	7.84	Pass
6	2437	-4.67	-4.84	-1.74	7.84	Pass
11	2462	-11.18	-11.33	-8.24	7.84	Pass

Note:

- Method E) 2) c) of power density measurement of KDB 662911 is using for calculating total power density.
- Directional gain = $10 \log[(10^{G1/10} + 10^{G2/10} + \dots + 10^{GN/10})/N_{ANT}] = 6.16 \text{dBi} > 6 \text{dBi}$, so the power density limit shall be reduced to $8 - (6.16 - 6) = 7.84 \text{dBm}$.

802.11n (20MHz)

Chan.	Freq. (MHz)	PSD (dBm/3kHz)		Total PSD (dBm/3kHz)	Limit (dBm/3kHz)	Pass / Fail
		Chain 0	Chain 1			
1	2412	-12.01	-12.10	-9.04	7.84	Pass
6	2437	-5.11	-5.34	-2.21	7.84	Pass
11	2462	-11.72	-11.83	-8.76	7.84	Pass

Note:

- Method E) 2) c) of power density measurement of KDB 662911 is using for calculating total power density.
- Directional gain = $10 \log[(10^{G1/10} + 10^{G2/10} + \dots + 10^{GN/10})/N_{ANT}] = 6.16 \text{dBi} > 6 \text{dBi}$, so the power density limit shall be reduced to $8 - (6.16 - 6) = 7.84 \text{dBm}$.

802.11n (40MHz)

Chan.	Freq. (MHz)	PSD (dBm/3kHz)		Total PSD (dBm/3kHz)	Limit (dBm/3kHz)	Pass / Fail
		Chain 0	Chain 1			
3	2422	-16.42	-17.26	-13.81	7.84	Pass
6	2437	-15.06	-15.14	-12.09	7.84	Pass
9	2452	-16.25	-16.83	-13.52	7.84	Pass

Note:

- Method E) 2) c) of power density measurement of KDB 662911 is using for calculating total power density.
- Directional gain = $10 \log[(10^{G1/10} + 10^{G2/10} + \dots + 10^{GN/10})/N_{ANT}] = 6.16 \text{dBi} > 6 \text{dBi}$, so the power density limit shall be reduced to $8 - (6.16 - 6) = 7.84 \text{dBm}$.

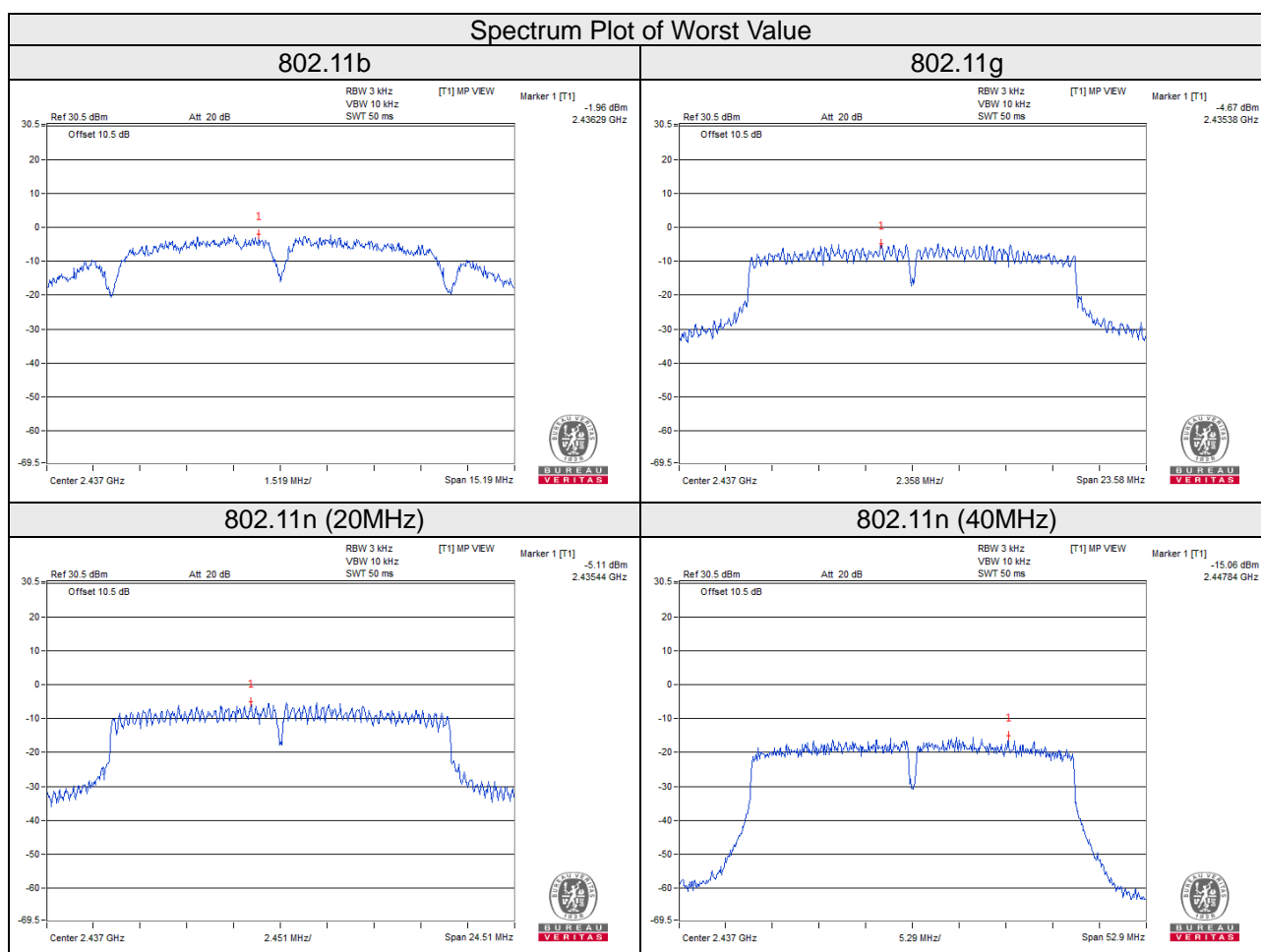

4.6 Conducted Out of Band Emission Measurement

4.6.1 Limits of Conducted Out of Band Emission Measurement

Below -20dB of the highest emission level of operating band (in 100kHz Resolution Bandwidth).

4.6.2 Test Setup

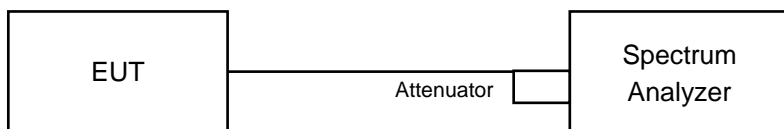

4.6.3 Test Instruments

Refer to section 4.1.2 to get information of above instrument.

4.6.4 Test Procedure

MEASUREMENT PROCEDURE REF

1. Set the RBW = 100 kHz.
2. Set the VBW \geq 300 kHz.
3. Detector = peak.
4. Sweep time = auto couple.
5. Trace mode = max hold.
6. Allow trace to fully stabilize.
7. Use the peak marker function to determine the maximum power level in any 100 kHz band segment within the fundamental EBW.

MEASUREMENT PROCEDURE OOB

1. Set RBW = 100 kHz.
2. Set VBW \geq 300 kHz.
3. Detector = peak.
4. Sweep = auto couple.
5. Trace Mode = max hold.
6. Allow trace to fully stabilize.
7. Use the peak marker function to determine the maximum amplitude level.

4.6.5 Deviation from Test Standard

No deviation.

4.6.6 EUT Operating Condition

Same as item 4.3.6.

4.6.7 Test Results

The conducted emission test is performed on each TX port of operating mode without summing or adding $10\log(N)$ since the limit is relative emission limit.

The spectrum plots are attached on the following pages. D1 line indicates the highest level, and D2 line indicates the 20dB offset below D1. It shows compliance with the requirement.

802.11b_Chain 0

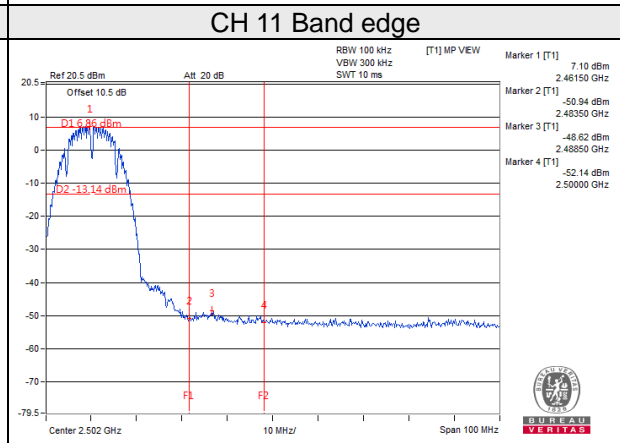
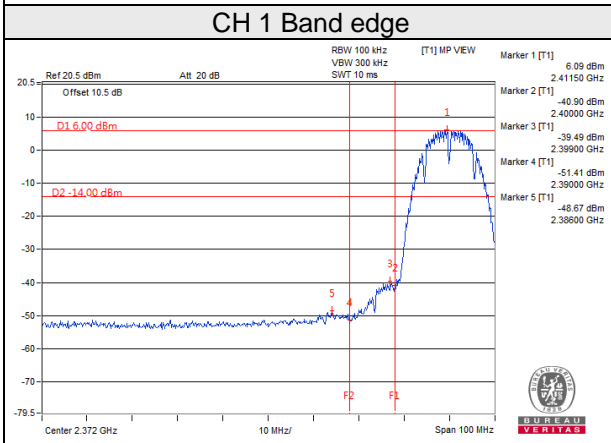
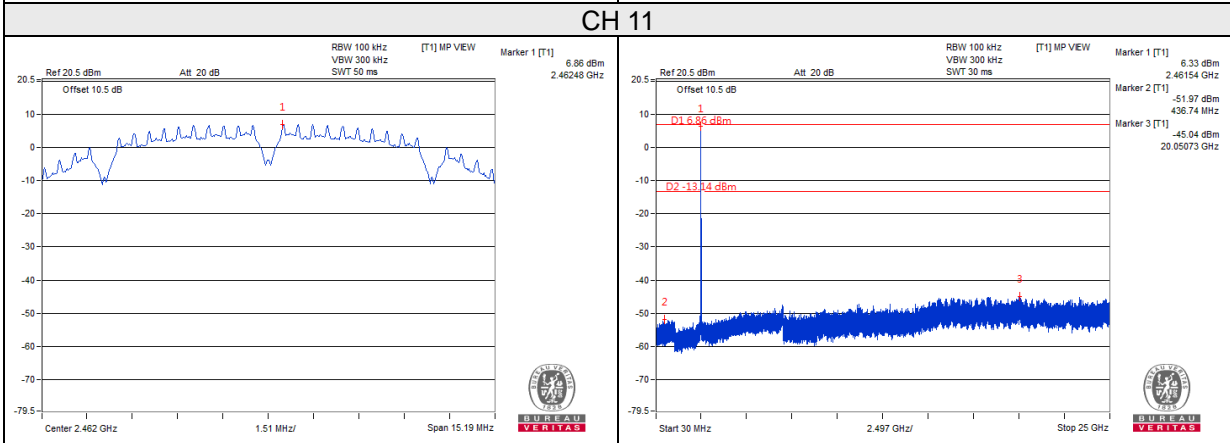
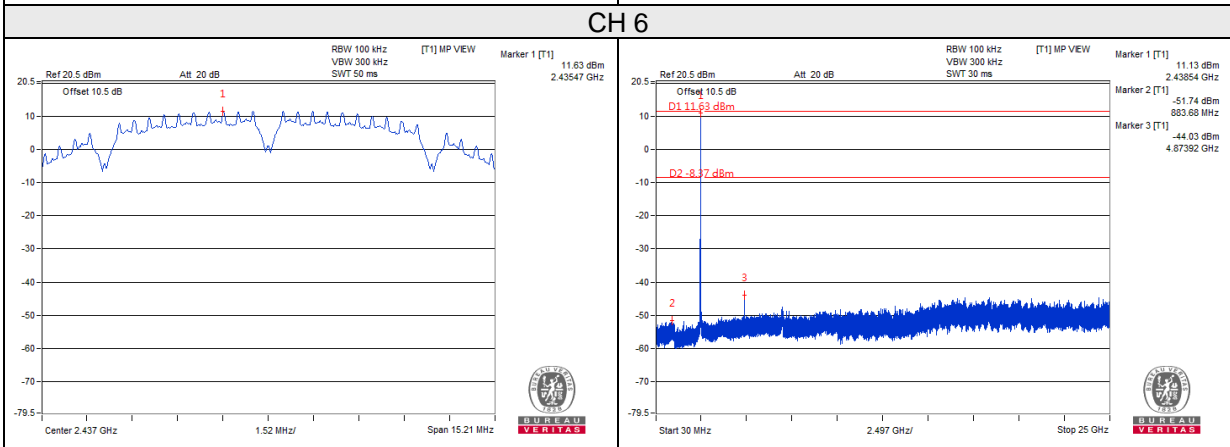
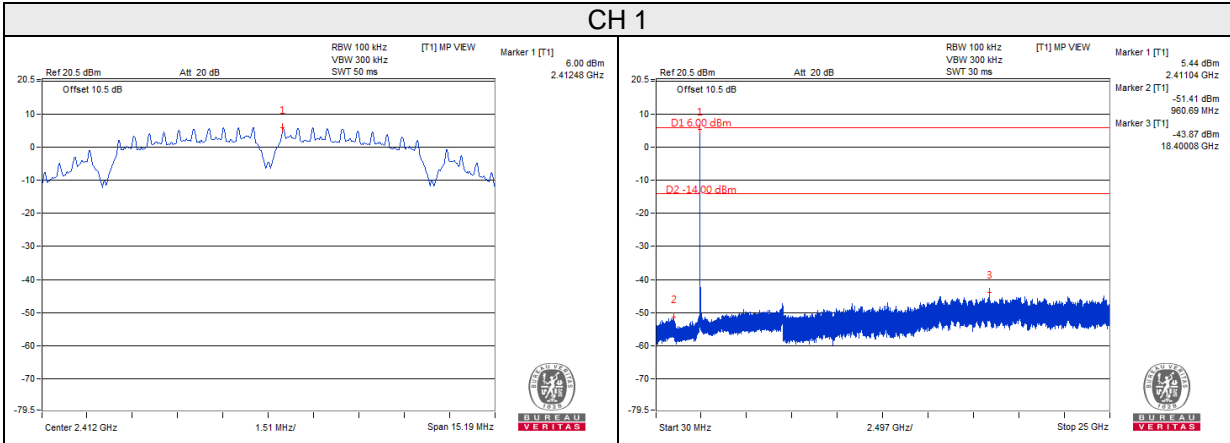

802.11b_Chain 1

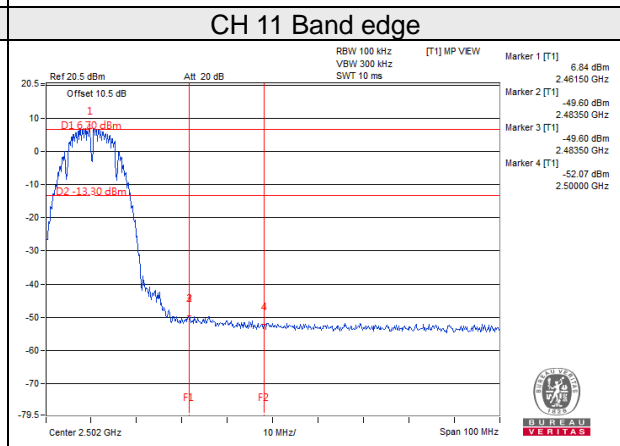
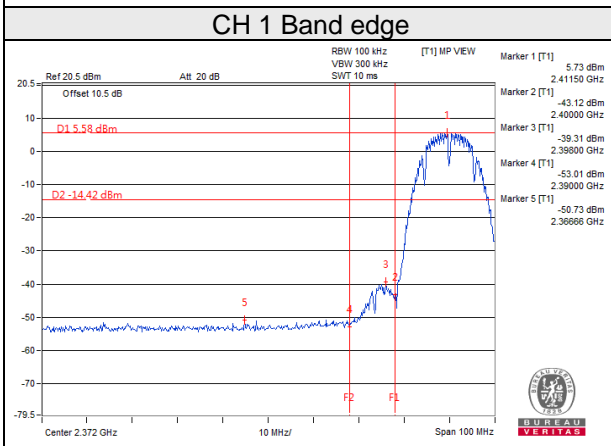
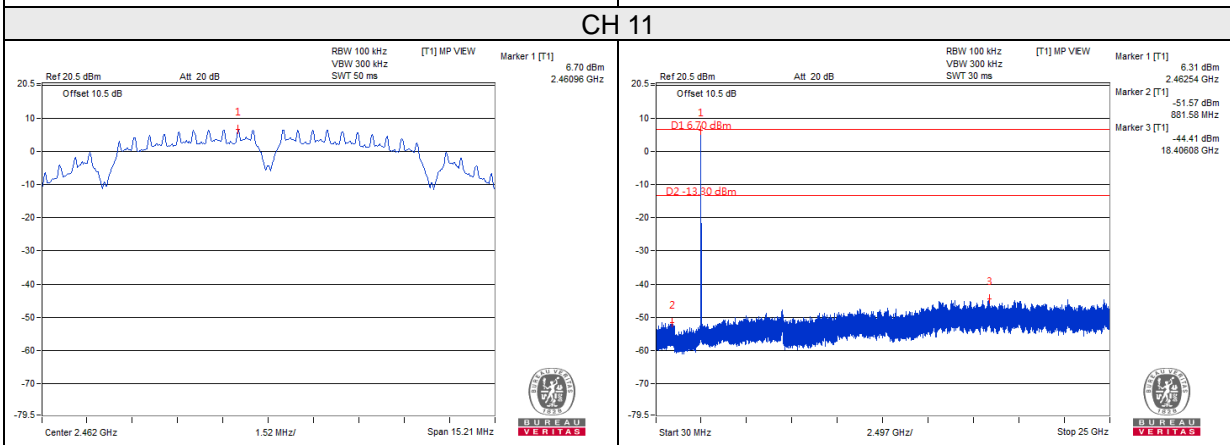
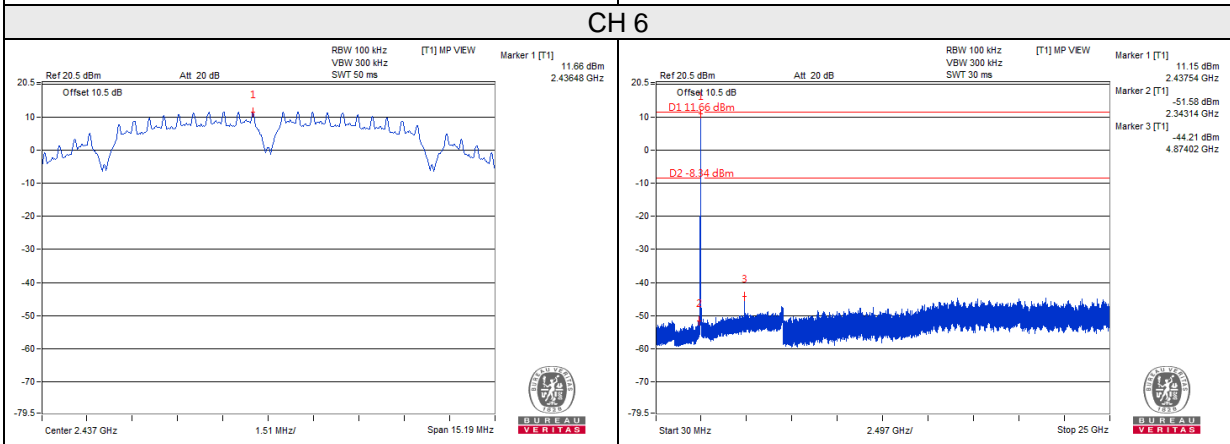
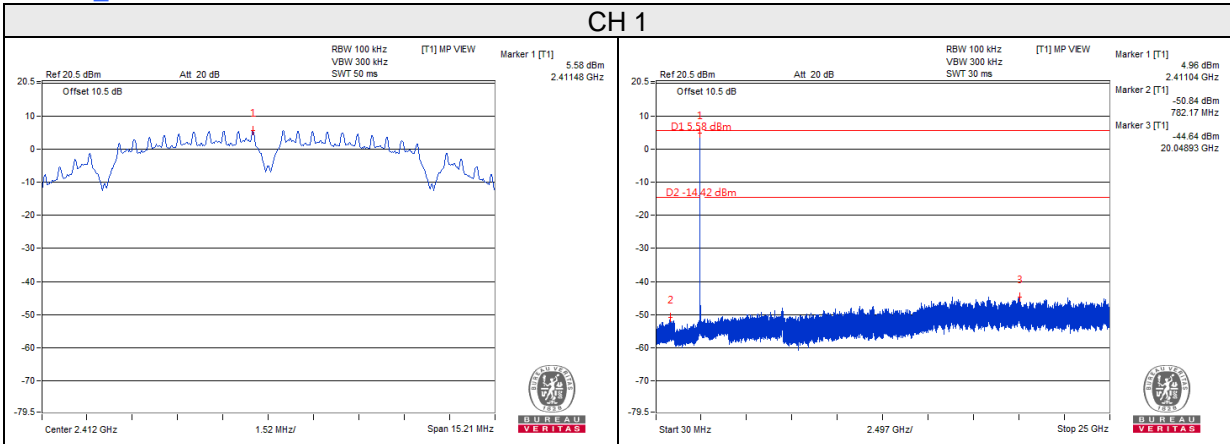



BUREAU VERITAS

802.11g_Chain 0

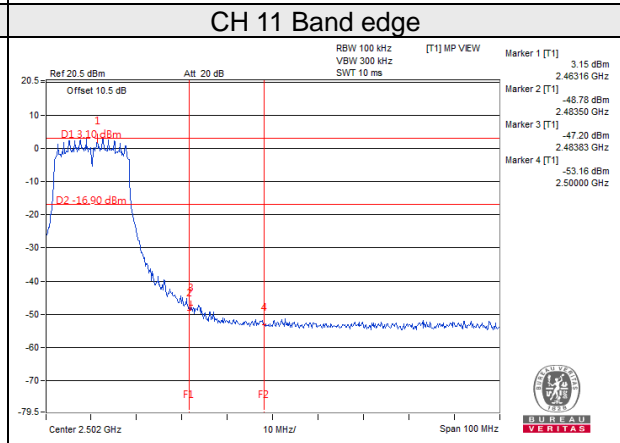
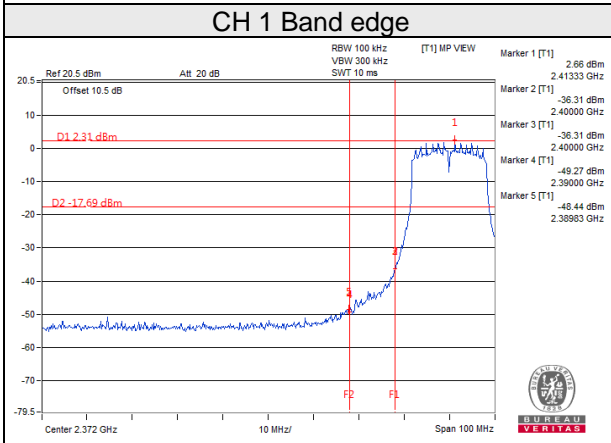
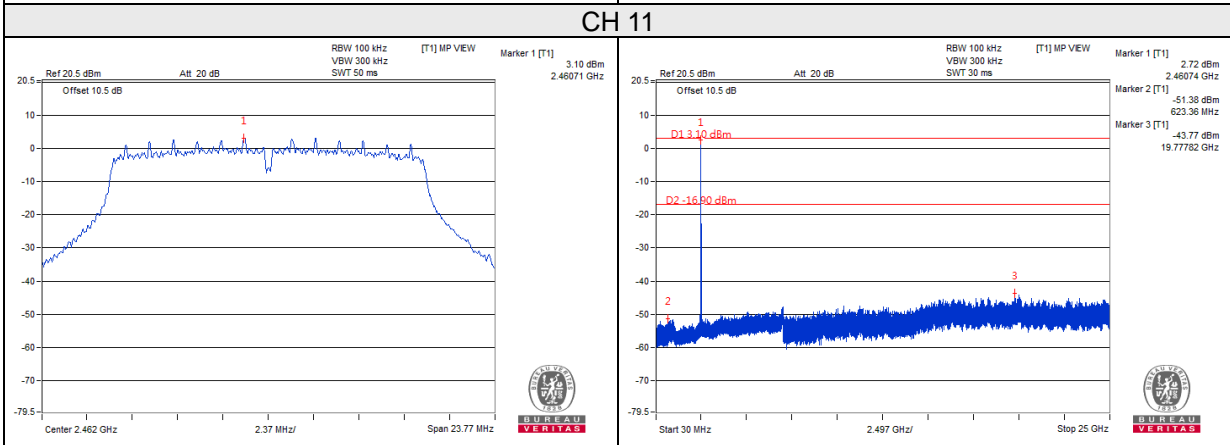
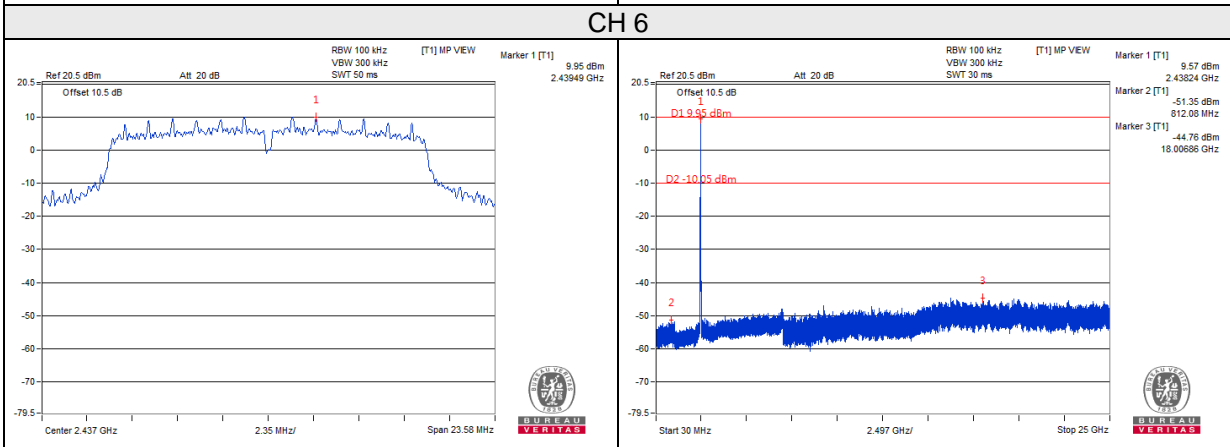
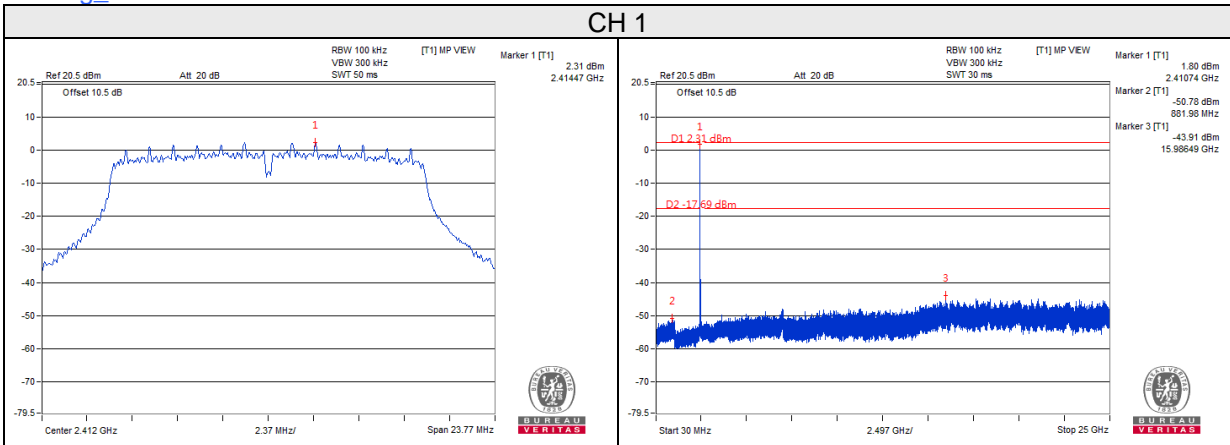



BUREAU VERITAS

802.11g_Chain 1

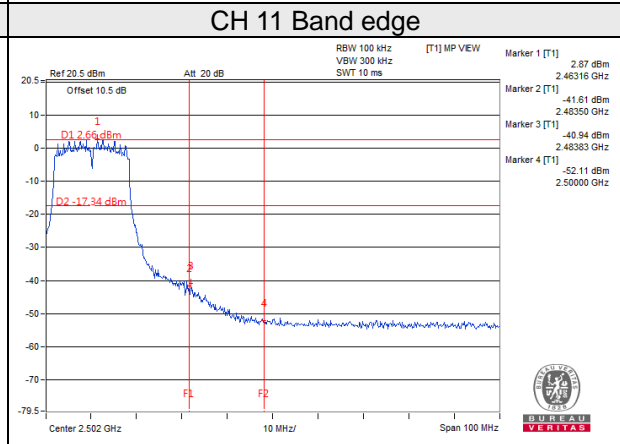
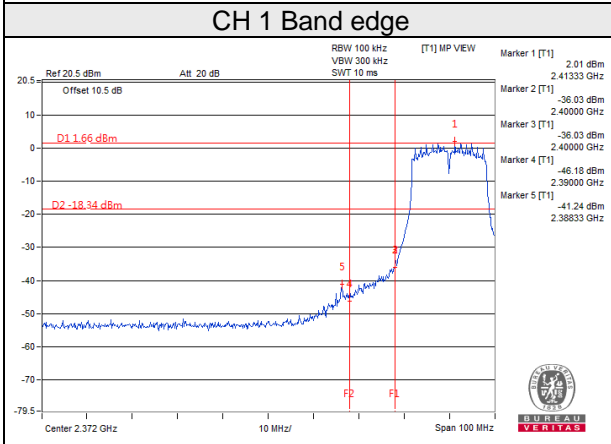
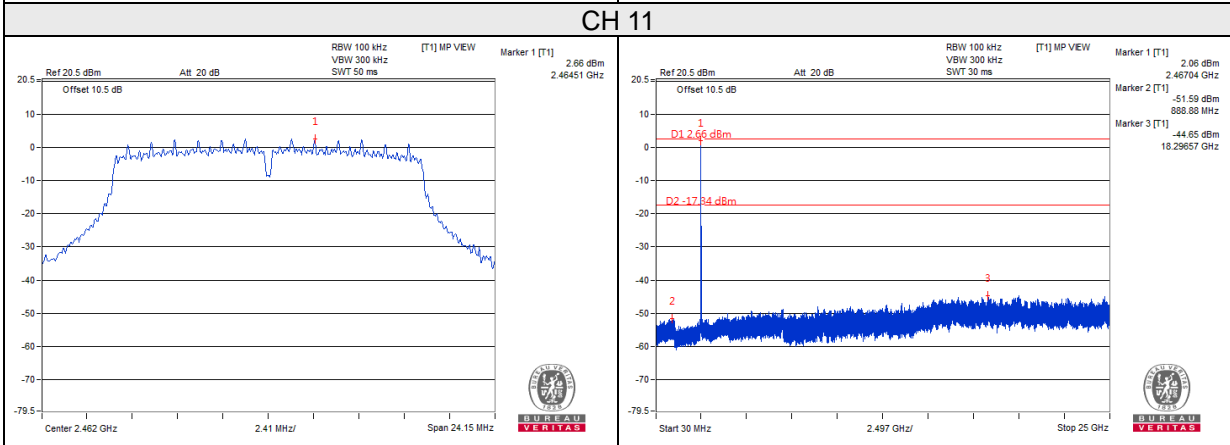
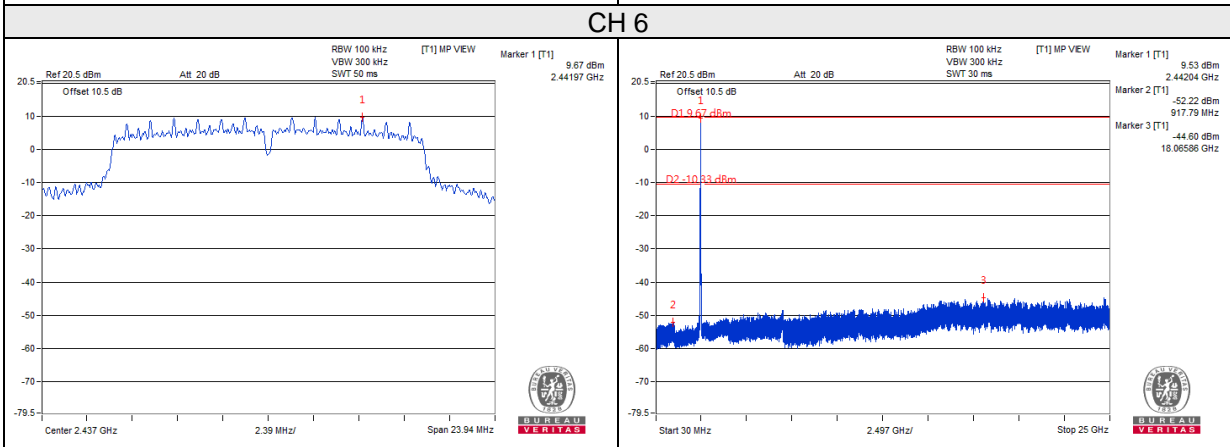
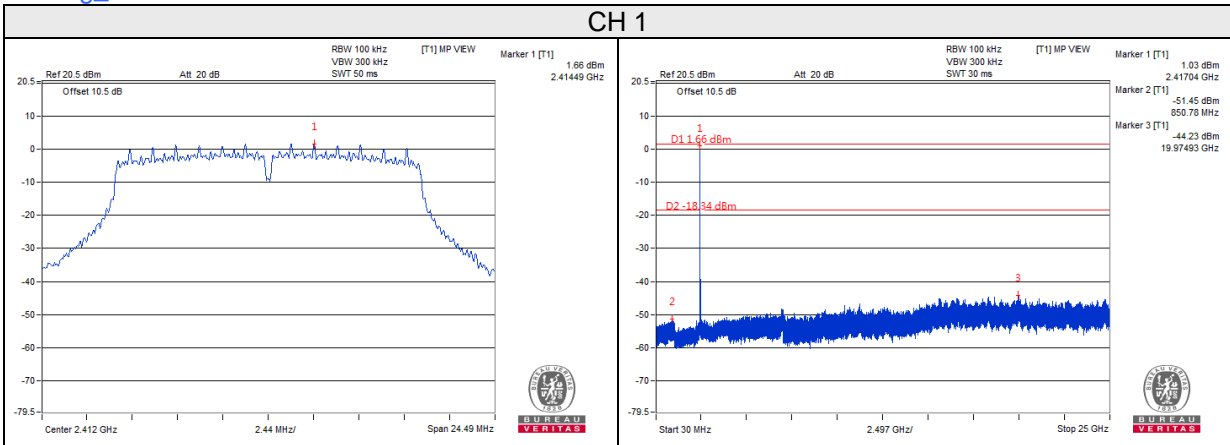

802.11n (20MHz)_Chain 0

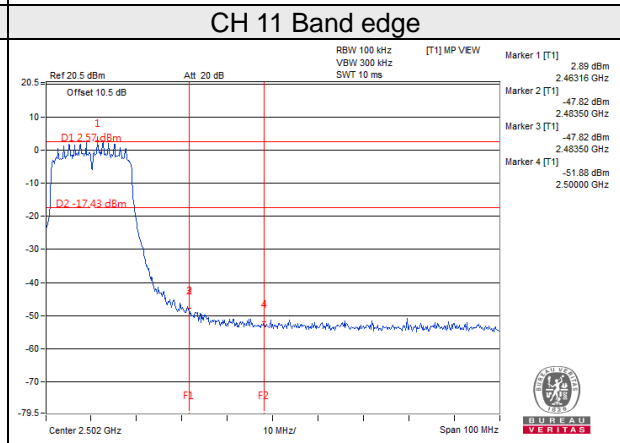
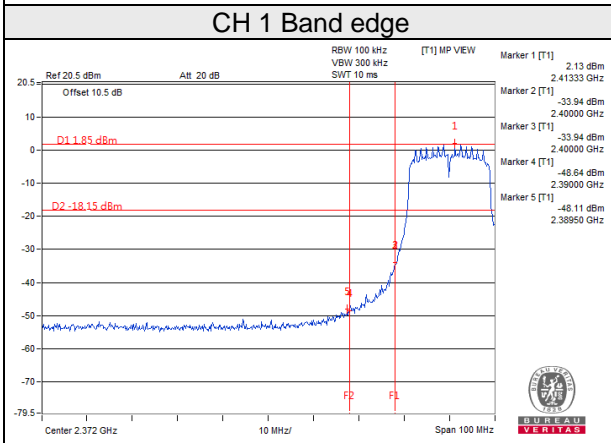
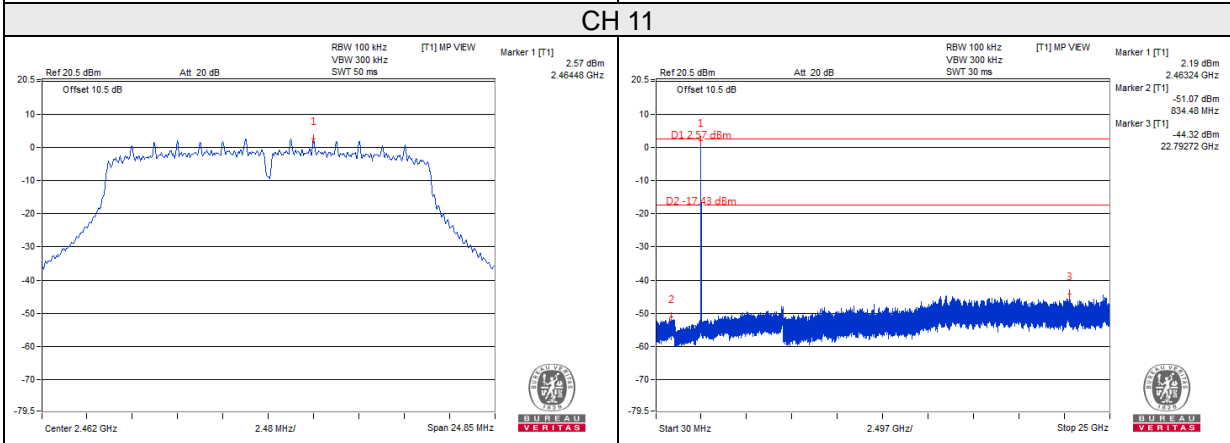
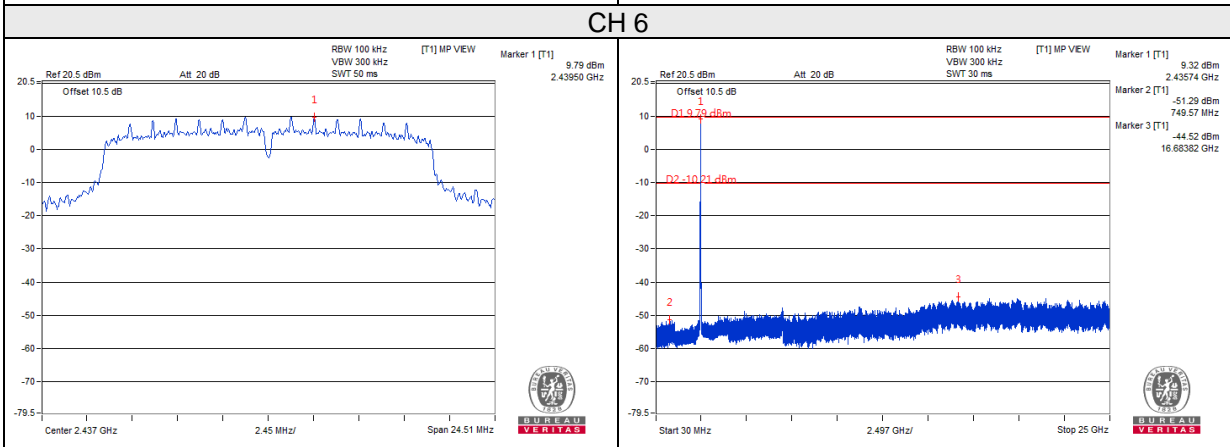
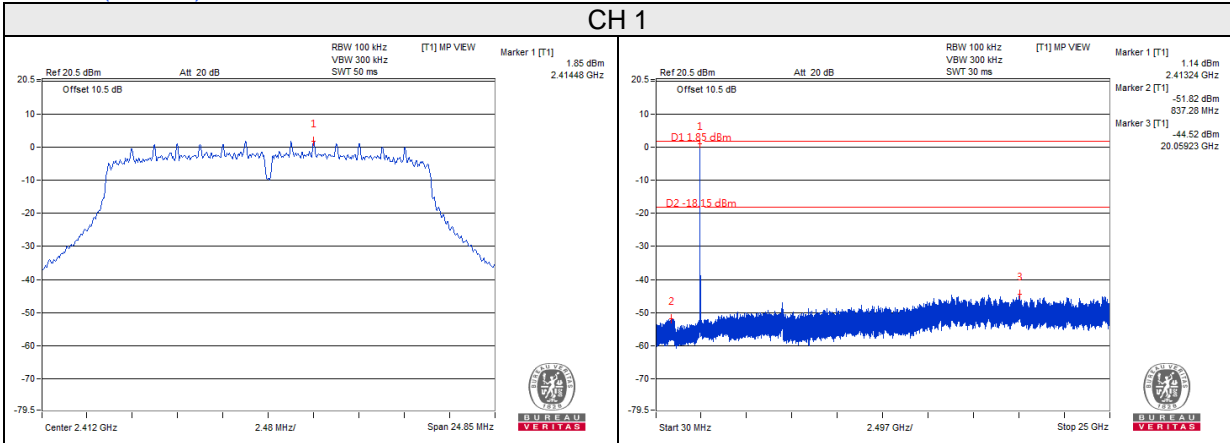

802.11n (20MHz)_Chain 1

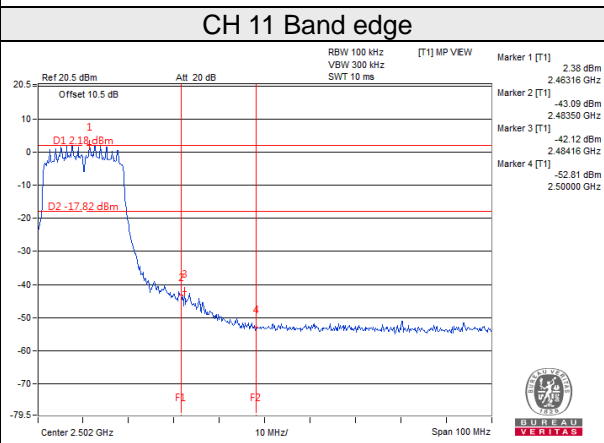
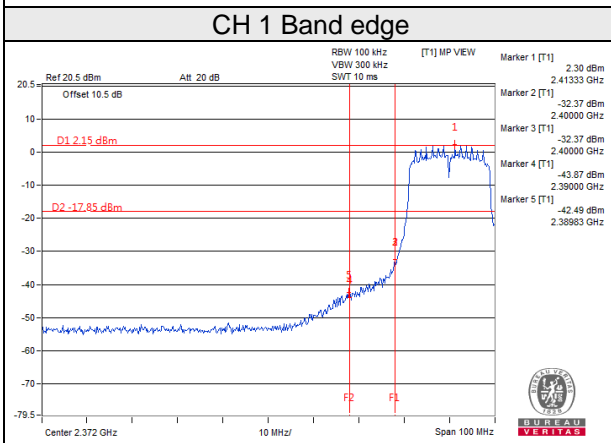
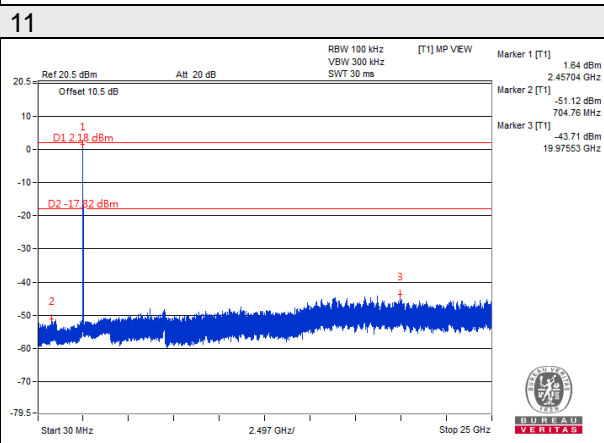
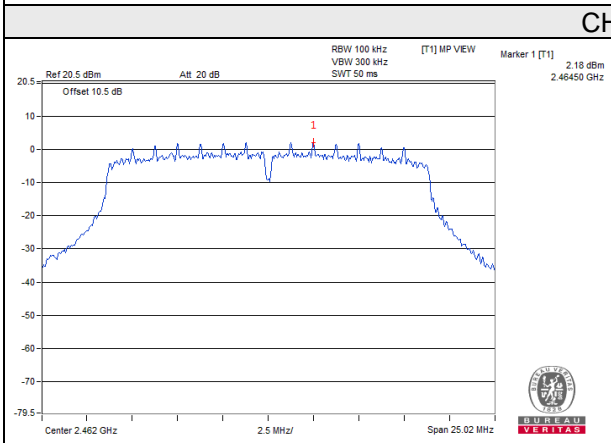
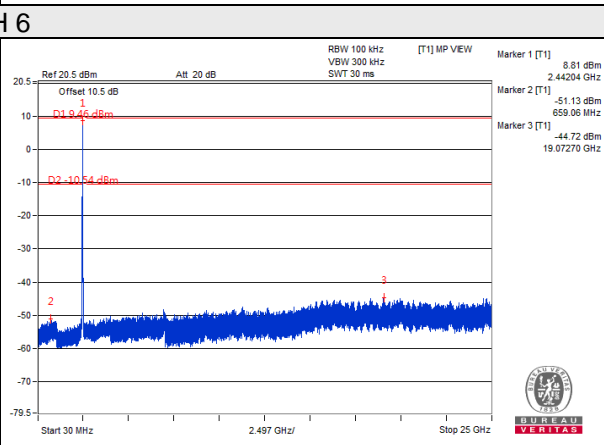
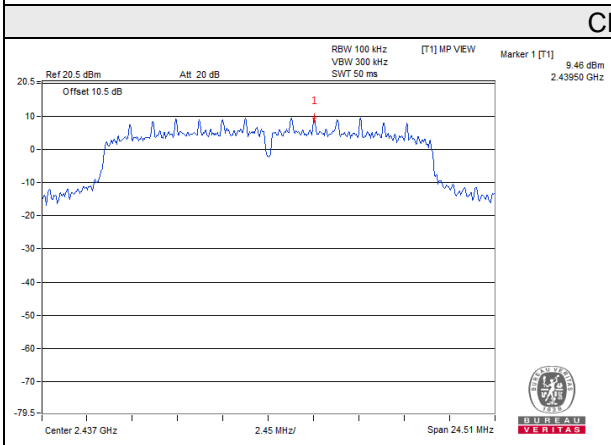
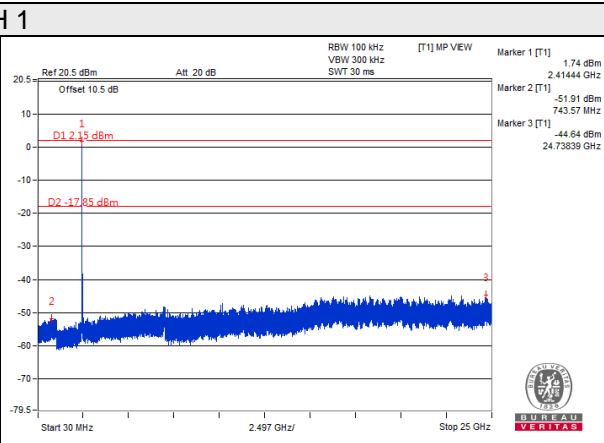
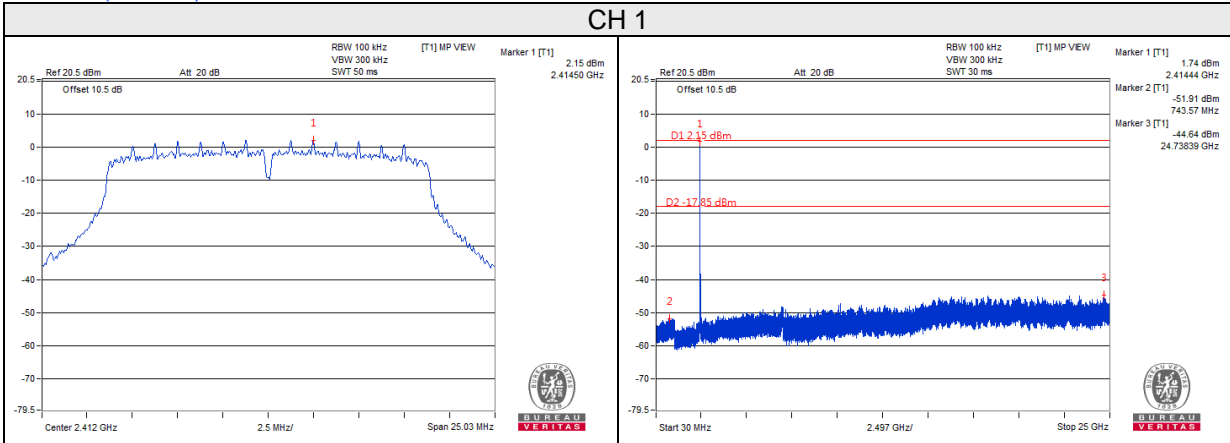

802.11n (40MHz)_Chain 0

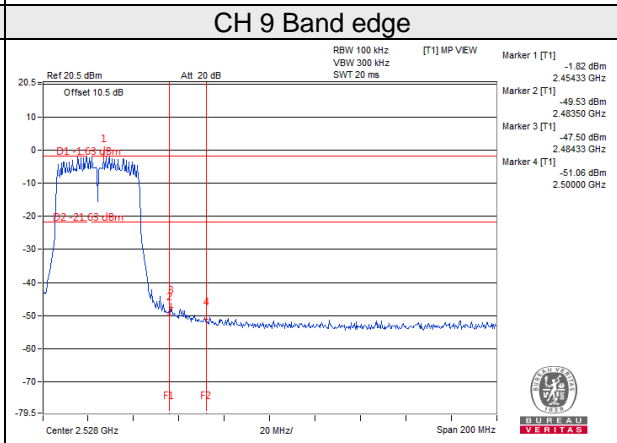
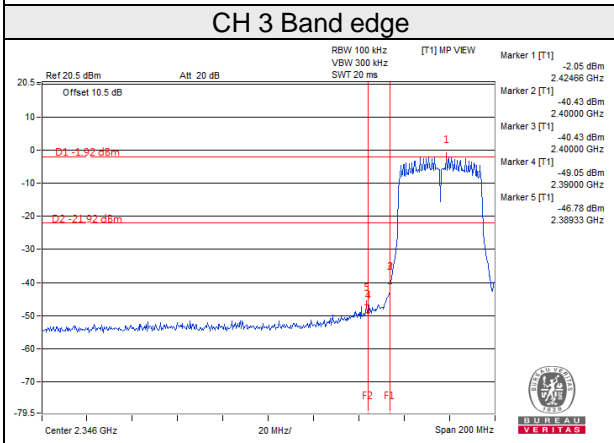
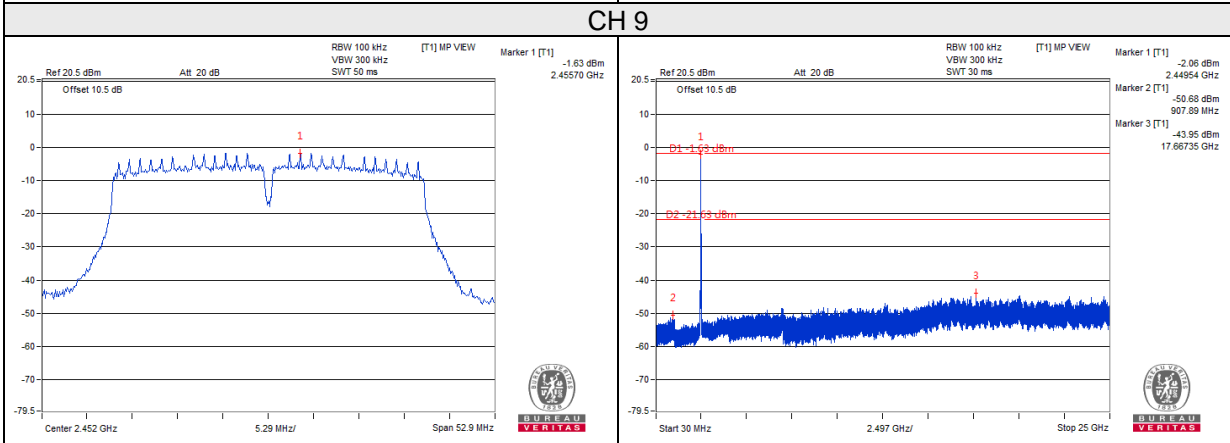
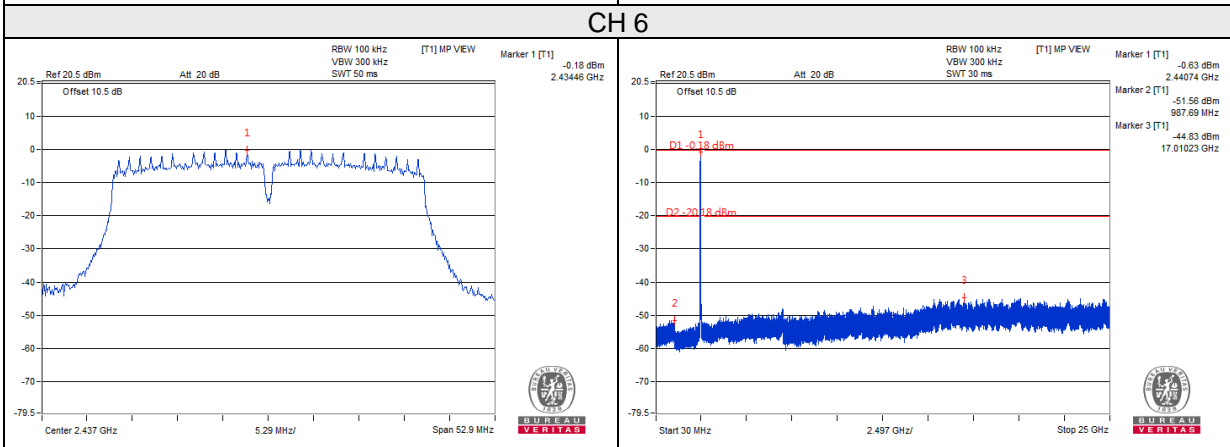
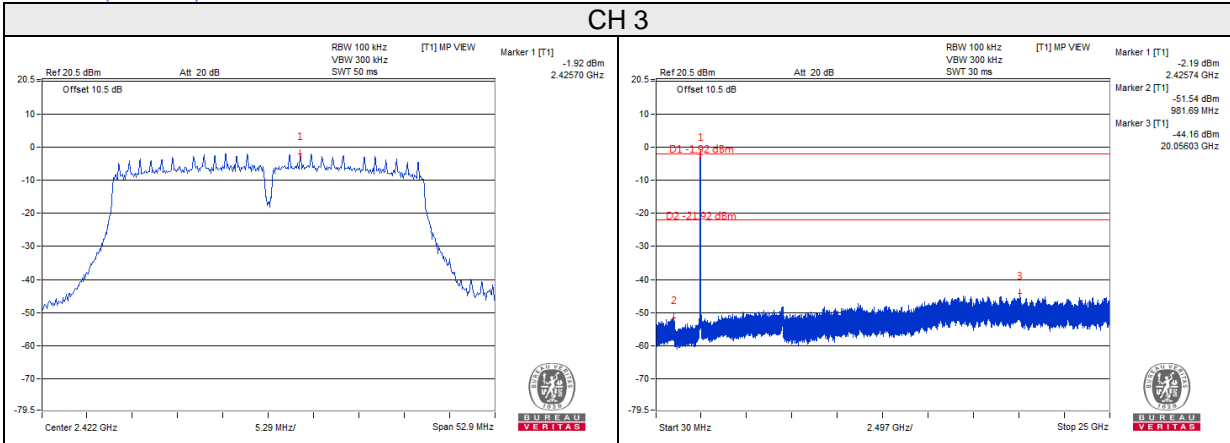

802.11n (40MHz)_Chain 1

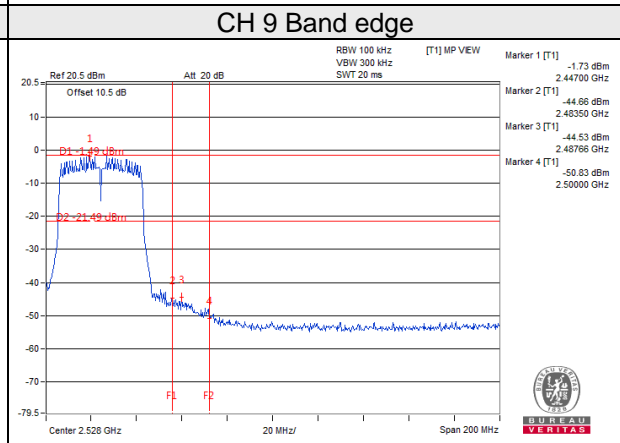
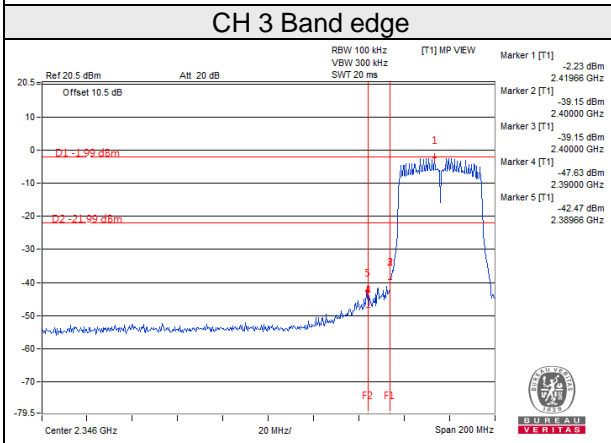
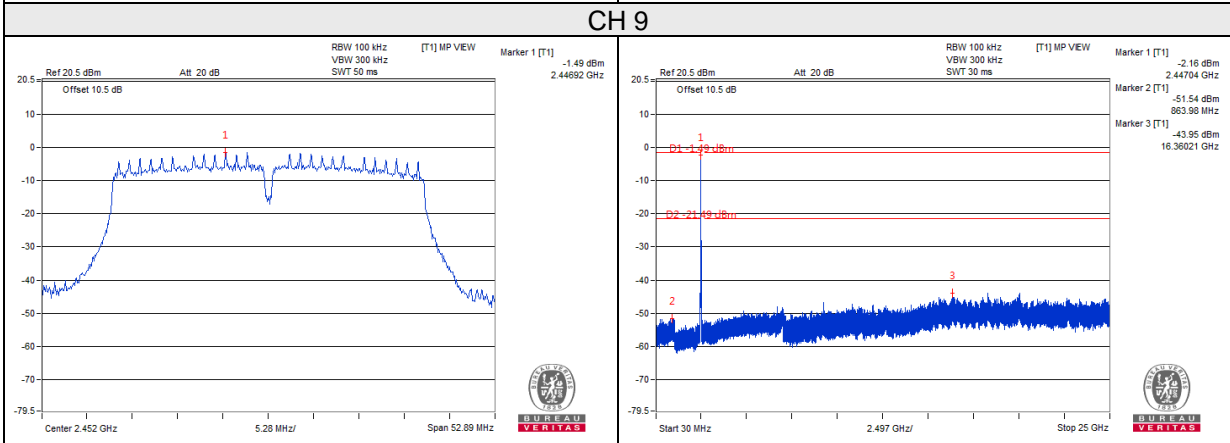
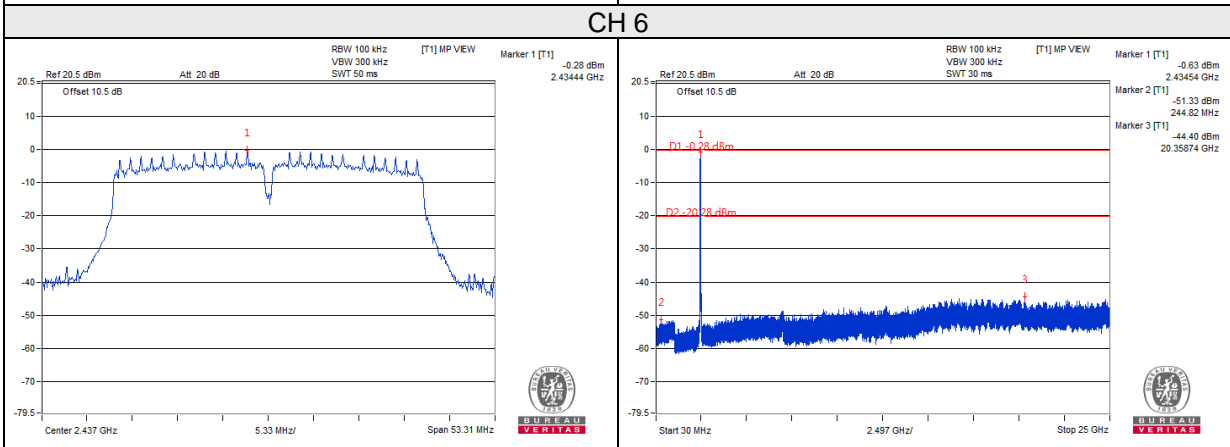
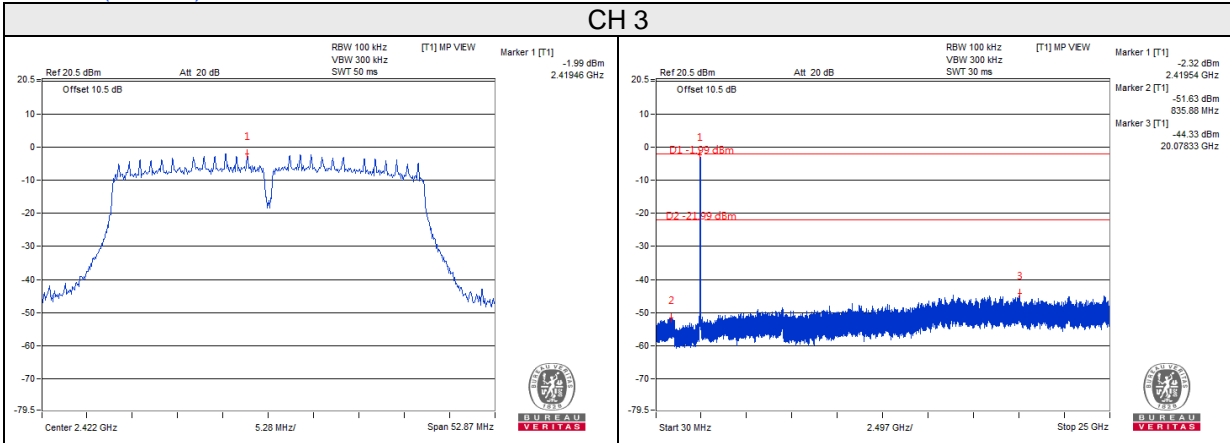

5 Pictures of Test Arrangements

Please refer to the attached file (Test Setup Photo).

Annex A- Band Edge Measurement

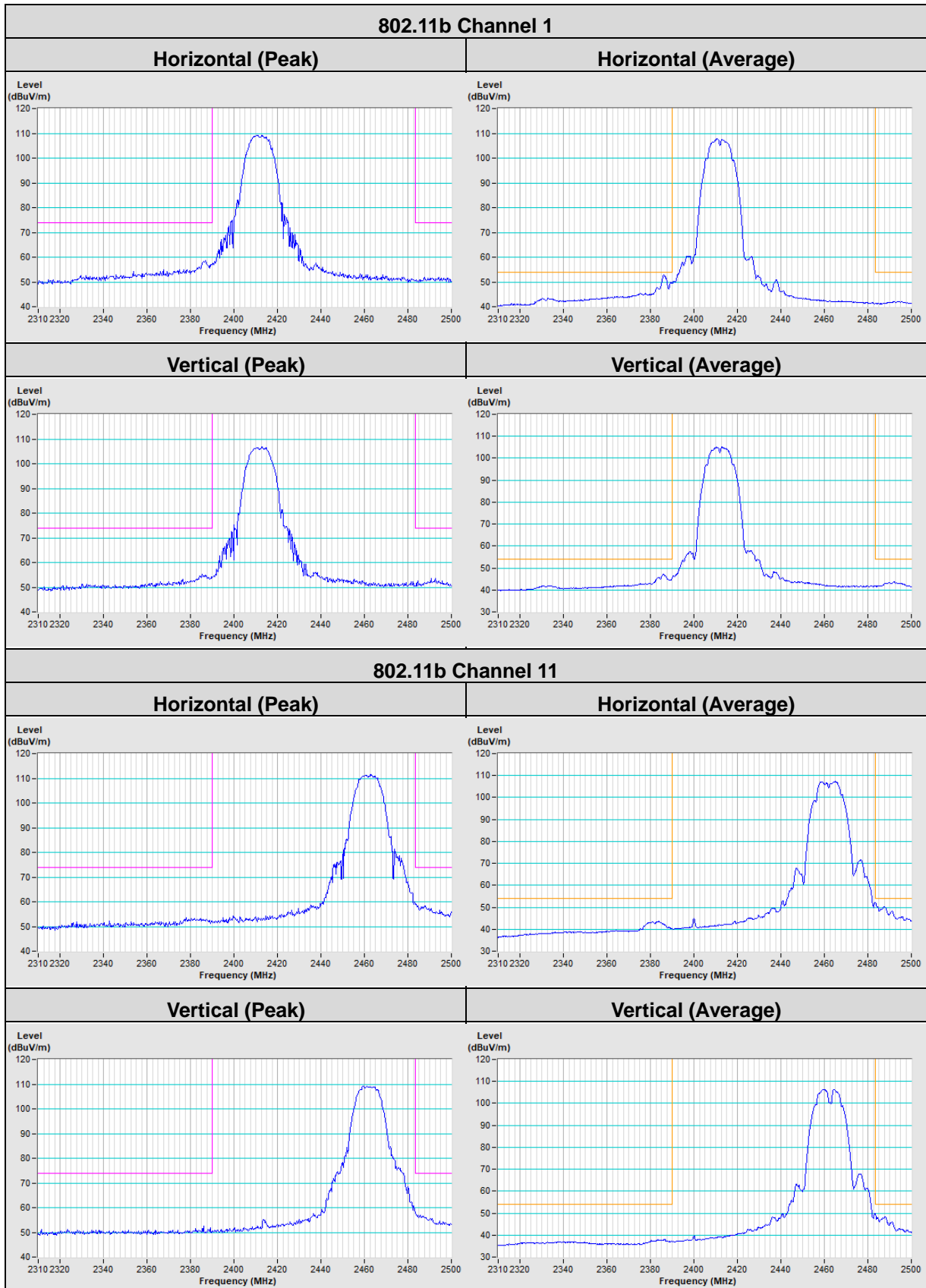

802.11g Channel 1

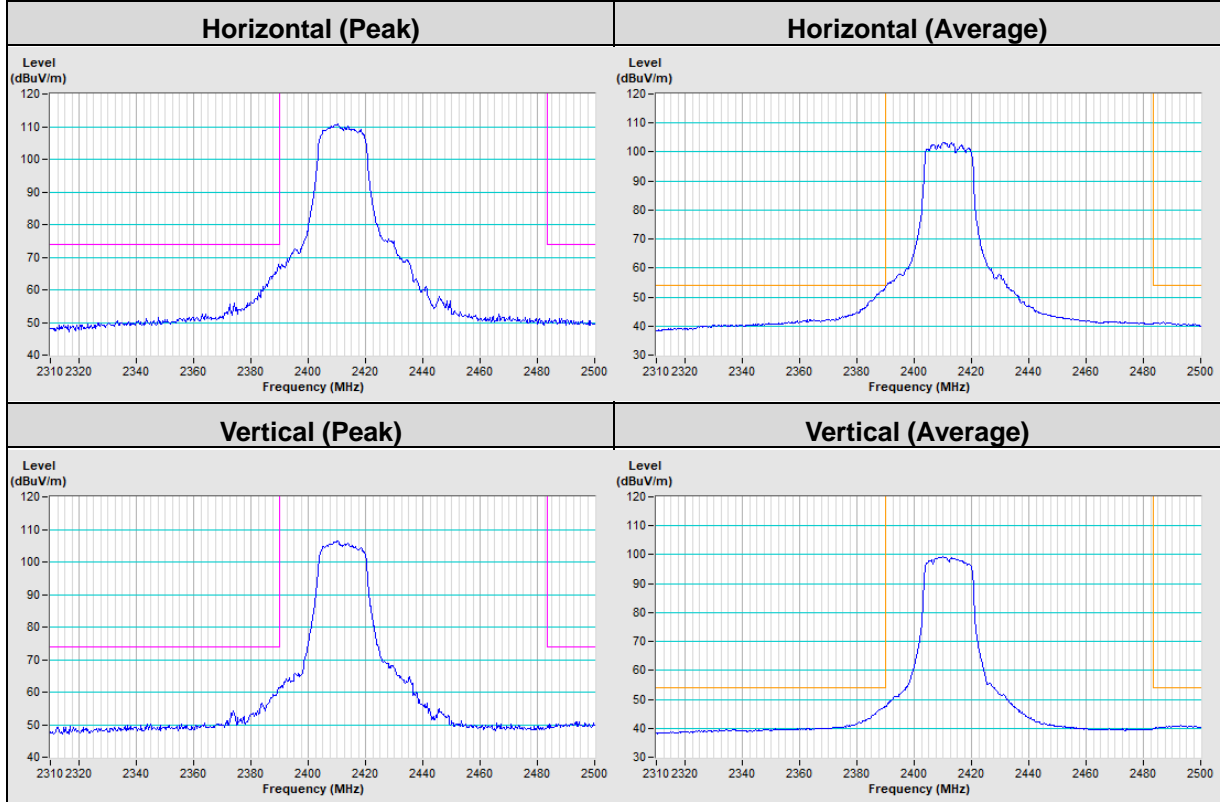

802.11g Channel 11

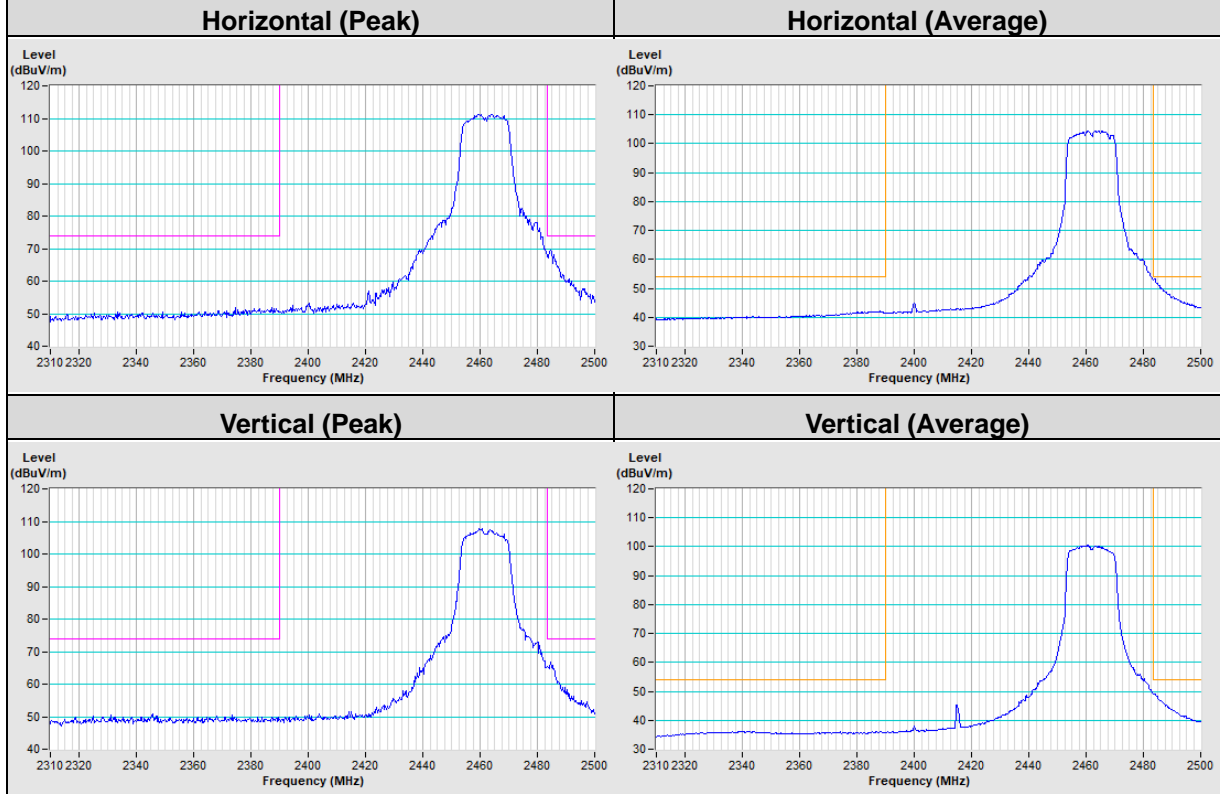

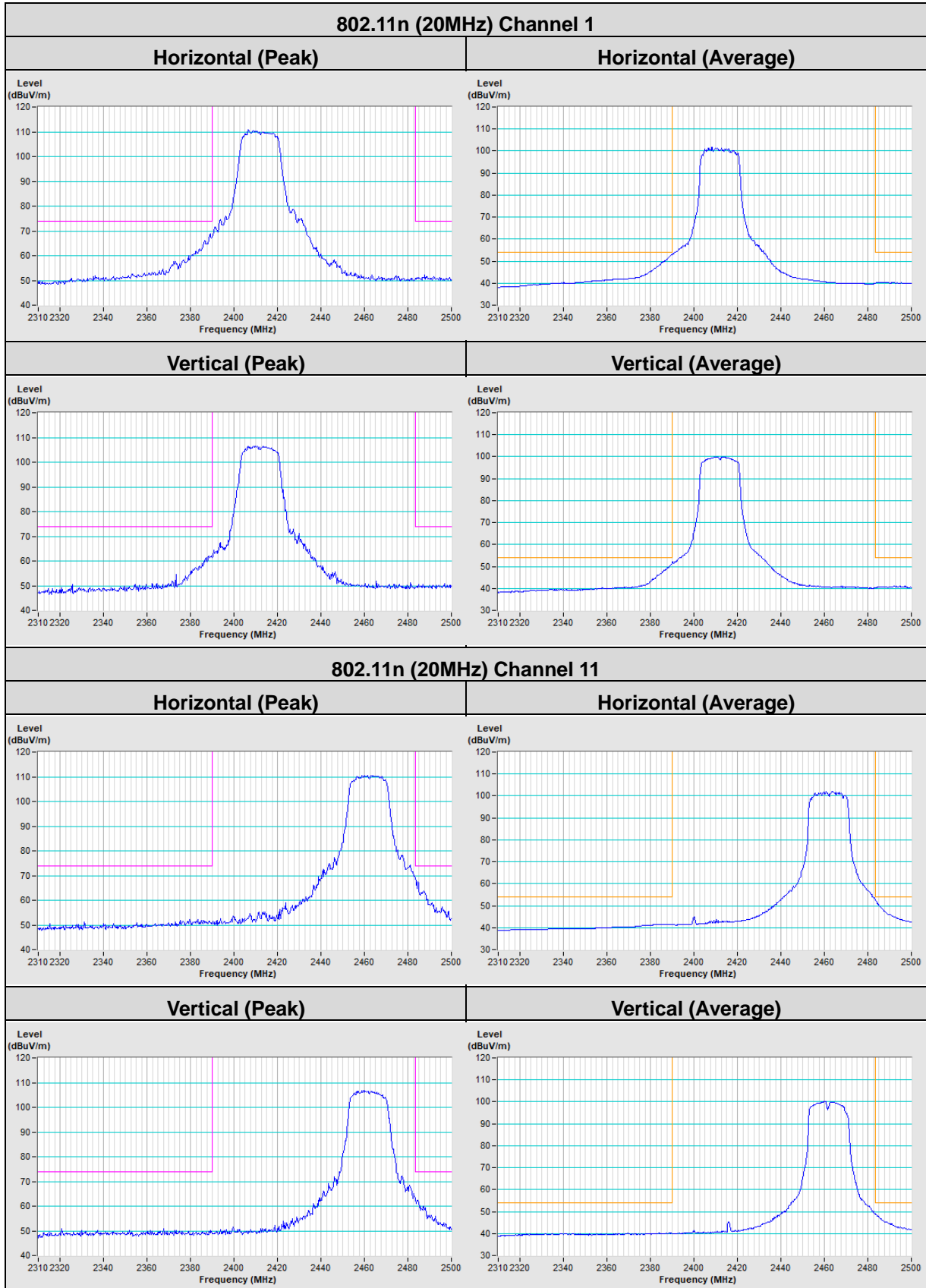

802.11n (40MHz) Channel 3

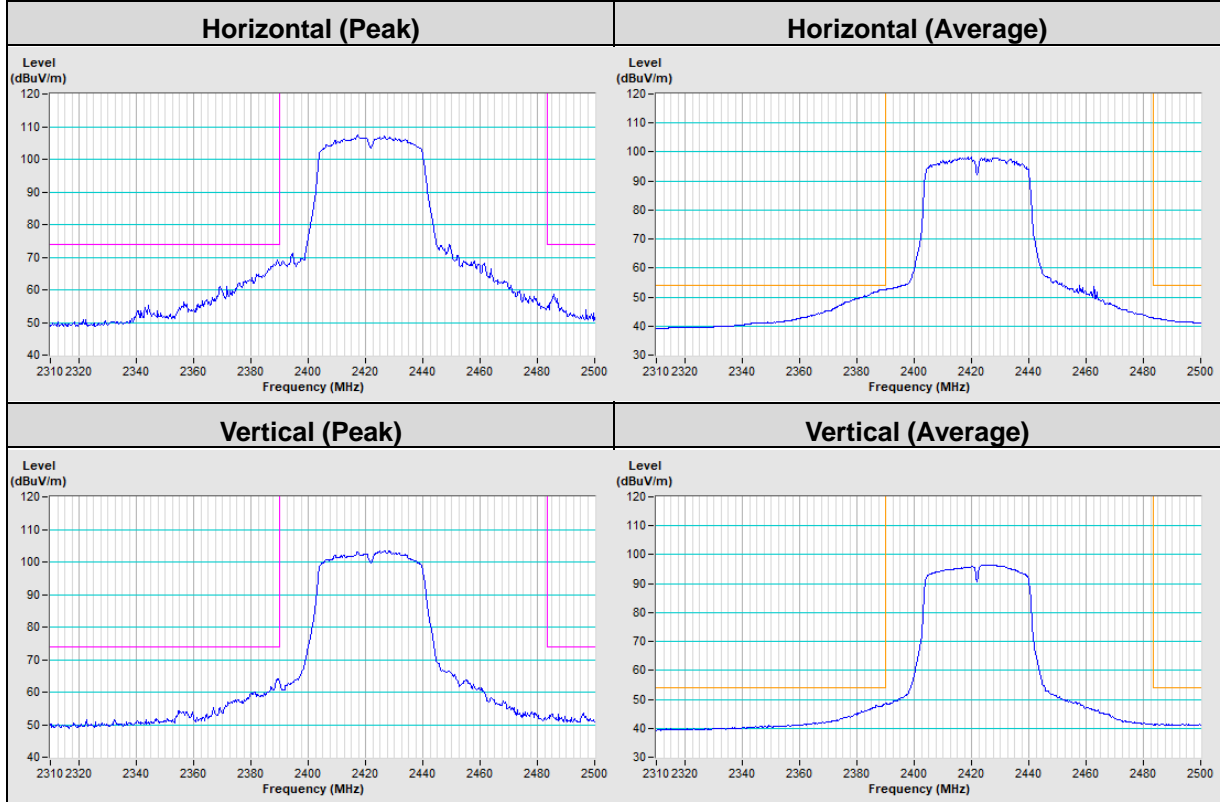

802.11n (40MHz) Channel 9

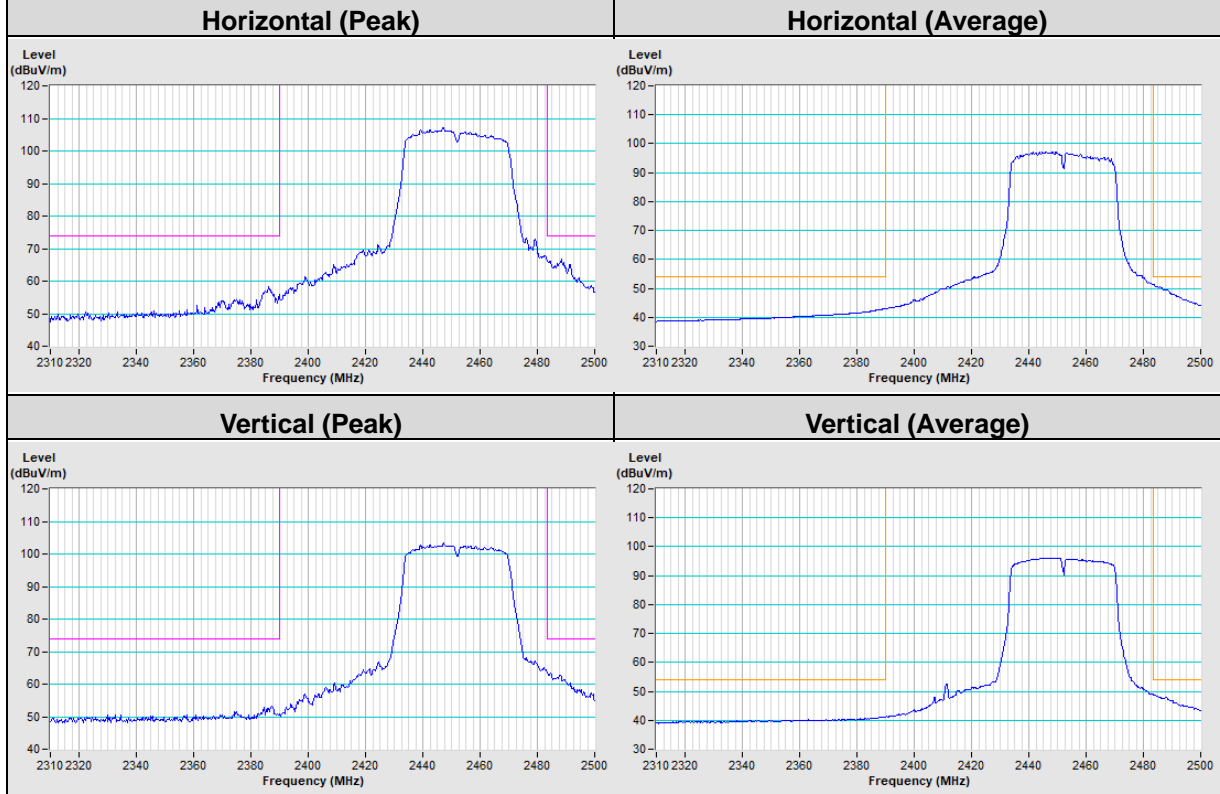

Appendix – Information of the Testing Laboratories

We, Bureau Veritas Consumer Products Services (H.K.) Ltd., Taoyuan Branch, were founded in 1988 to provide our best service in EMC, Radio, Telecom and Safety consultation. Our laboratories are FCC recognized accredited test firms and accredited and approved according to ISO/IEC 17025.

If you have any comments, please feel free to contact us at the following:

Lin Kou EMC/RF Lab

Tel: 886-2-26052180

Fax: 886-2-26051924

Hsin Chu EMC/RF/Telecom Lab

Tel: 886-3-6668565

Fax: 886-3-6668323

Hwa Ya EMC/RF/Safety Lab

Tel: 886-3-3183232

Fax: 886-3-3270892

Email: service.adt@tw.bureauveritas.com

Web Site: www.bureauveritas-adt.com

The address and road map of all our labs can be found in our web site also.

--- END ---