



**TEST REPORT**  
**FCC Part 27**

**Report Reference No.**.....: HK2011193870-8E  
**FCC ID**.....: **2AYD7-INB1**  
Compiled by  
( position+printed name+signature)..: File administrators Gary Qian  
  
Supervised by  
( position+printed name+signature)..: Technique principal Eden Hu  
  
Approved by  
( position+printed name+signature)..: Manager Jason Zhou  
  
Date of issue.....: Dec. 24, 2020

*Gary Qian*

*Eden Hu*

*Jason Zhou*

**Testing Laboratory Name** .....: **Shenzhen HUAKE Testing Technology Co., Ltd.**  
Address .....: 1F, B2 Building, Junfeng Zhongcheng Zhizao Innovation  
Park,Heping Community, Fuhai Street, Bao'an District, Shenzhen,  
China

**Applicant's name**.....: **igloocompany Pte. Ltd.**  
Address .....: 67 Ayer Rajah Crescent #06-14/21, Singapore 139950

**Test specification** .....:  
Standard .....: **FCC CFR Title 47 Part 2, Part 27**  
TRF Originator.....: Shenzhen HUAKE Testing Technology Co., Ltd.

**Shenzhen HUAKE Testing Technology Co., Ltd. All rights reserved.**

This publication may be reproduced in whole or in part for non-commercial purposes as long as the Shenzhen HUAKE Testing Technology Co., Ltd. as copyright owner and source of the material. Shenzhen HUAKE Testing Technology Co., Ltd. takes no responsibility for and will not assume liability for damages resulting from the reader's interpretation of the reproduced material due to its placement and context.

**Test item description** .....: Smart IoT Deadbolt  
Trade Mark .....: N/A  
**Manufacturer**.....: igloocompany Pte. Ltd.  
Model/Type reference.....: INB1  
Listed Models .....: N/A  
Modulation Type .....: BPSK, QPSK  
Rating .....: DC 6V From Battery  
Hardware version .....: V1.06  
Software version .....: V1.06  
Result.....: **PASS**

**TEST REPORT**

<b>Test Report No. :</b>	<b>HK2011193870-8E</b>	Dec. 24, 2020
		Date of issue

Equipment under Test : Smart IoT Deadbolt

Model /Type : INB1

Listed Models : N/A

**Applicant** : **igloocompany Pte. Ltd.**

Address : 67 Ayer Rajah Crescent #06-14/21, Singapore 139950

**Manufacturer** : **igloocompany Pte. Ltd.**

Address : 67 Ayer Rajah Crescent #06-14/21, Singapore 139950

<b>Test result</b>	<b>Pass</b>
--------------------	-------------

The test report merely corresponds to the test sample.  
It is not permitted to copy extracts of these test result without the written permission of the test laboratory.



### Revision History

Revision	Issue Date	Revisions	Revised By
V1.0	Dec. 24, 2020	Initial Issue	Jasou Zhou



## Contents

<b>1</b>	<b><u>SUMMARY</u></b>	<b>5</b>
1.1	TEST STANDARDS	5
1.2	Test Description	5
1.3	Test Facility	6
1.4	Statement of the measurement uncertainty	6
<b>2</b>	<b><u>GENERAL INFORMATION</u></b>	<b>7</b>
2.1	Environmental conditions	7
2.2	Description of Test Modes	7
2.3	Test frequency list	7
2.4	Equipments Used during the Test	8
2.5	Related Submittal(s) / Grant (s)	8
2.6	Modifications	8
<b>3</b>	<b><u>TEST CONDITIONS AND RESULTS</u></b>	<b>9</b>
3.1	Output Power	9
3.3	Peak-to-Average Ratio (PAR)	12
3.4	Occupied Bandwidth and Emission Bandwidth	14
3.5	Band Edge compliance	18
3.6	Spurious Emission	23
3.7	Frequency Stability under Temperature & Voltage Variations	35
<b>4</b>	<b><u>TEST SETUP PHOTOS OF THE EUT</u></b>	<b>37</b>



# 1 SUMMARY

## 1.1 TEST STANDARDS

The tests were performed according to following standards:

[FCC Part 27](#) : MISCELLANEOUS WIRELESS COMMUNICATIONS SERVICES

[TIA/EIA 603 D June 2010](#):Land Mobile FM or PM Communications Equipment Measurement and Performance Standards.

47 CFR FCC Part 15 Subpart B: - Unintentional Radiators

[FCC Part 2](#): FREQUENCY ALLOCATIONS AND RADIO TREATY MATTERS; GENERAL RULES AND REGULATIONS

[KDB971168 D01: v02r02](#) MEASUREMENT GUIDANCE FOR CERTIFICATION OF LICENSED DIGITAL TRANSMITTERS

[FCC KDB 971168D01 v03r01](#) Power Meas License Digital Systems

## 1.2 Test Description

Test Item	Section in CFR 47	Result
RF Output Power	Part 2.1046 Part 27.50(d)(4)	Pass
Peak-to-Average Ratio	Part 27.50(d)(4)	Pass
99% & -26 dB Occupied Bandwidth	Part 2.1049 Part 27.53(h)	Pass
Spurious Emissions at Antenna Terminal	Part 2.1051 Part 27.53(h)	Pass
Field Strength of Spurious Radiation	Part 2.1053 Part 27.53(h)	Pass
Out of band emission, Band Edge	Part 2.1051 Part 27.53(h)	Pass
Frequency stability	Part 2.1055 Part 27.54	Pass



## 1.3 Test Facility

### 1.3.1 Address of the test laboratory

#### **Shenzhen HUAKE Testing Technology Co., Ltd.**

1F, B2 Building, Junfeng Zhongcheng Zhizao Innovation Park, Heping Community, Fuhai Street, Bao'an District, Shenzhen, China

## 1.4 Statement of the measurement uncertainty

The data and results referenced in this document are true and accurate. The reader is cautioned that there may be errors within the calibration limits of the equipment and facilities. The measurement uncertainty was calculated for all measurements listed in this test report acc. to CISPR 16 - 4 „Specification for radio disturbance and immunity measuring apparatus and methods – Part 4: Uncertainty in EMC Measurements“ and is documented in the Shenzhen HUAKE Testing Technology Co., Ltd. quality system acc. to DIN EN ISO/IEC 17025. Furthermore, component and process variability of devices similar to that tested may result in additional deviation. The manufacturer has the sole responsibility of continued compliance of the device.

Hereafter the best measurement capability for Shenzhen HUAKE Testing Technology Co., Ltd. is reported:

<b>Test</b>	<b>Range</b>	<b>Measurement Uncertainty</b>	<b>Notes</b>
Radiated Emission	30~1000MHz	4.10dB	(1)
Radiated Emission	Above 1GHz	4.32dB	(1)
Conducted Disturbance	0.15~30MHz	3.20dB	(1)

(1) This uncertainty represents an expanded uncertainty expressed at approximately the 95% confidence level using a coverage factor of k=2.



## 2 GENERAL INFORMATION

### 2.1 Environmental conditions

During the measurement the environmental conditions were within the listed ranges:

Normal Temperature:	25°C
Relative Humidity:	55 %
Air Pressure:	101 kPa

### 2.2 Description of Test Modes

The EUT has been tested under typical operating condition. The CMW500 used to control the EUT staying in continuous transmitting and receiving mode for testing. Regards to the frequency band operation: the lowest, middle and highest frequency of channel were selected to perform the test, then shown on this report.

Note:

1. For the ERP/EIRP and radiated emission test, every axis (X, Y, Z) was verified, and show the worst result on this report.
2. Test method and refer to 3GPP TS136521.

### 2.3 Test frequency list

Sub-carrier Space	Frequency (MHz)	channel
3.75KHz	1710.1	19951
	1732.5	20175
	1754.3	20399
15KHz	1711.5	19951
	1732.5	20175
	1754.9	20399



## 2.4 Equipments Used during the Test

Test Equipment	Manufacturer	Model No.	Serial No.	Calibration Date	Calibration Due Date
LISN	ENV216	R&S	HKE-059	Jun. 18, 2020	Jun. 17, 2021
LISN	R&S	ENV216	HKE-002	Jun. 18, 2020	Jun. 17, 2021
Broadband antenna	Schwarzbeck	VULB 9163	HKE-012	Jun. 18, 2020	Jun. 17, 2021
Receiver	R&S	ESCI 7	HKE-010	Jun. 18, 2020	Jun. 17, 2021
Spectrum analyzer	Agilent	N9020A	HKE-048	Jun. 18, 2020	Jun. 17, 2021
RF automatic control unit	Tonscend	JS0806-2	HKE-060	Jun. 18, 2020	Jun. 17, 2021
Horn antenna	Schwarzbeck	9120D	HKE-013	Jun. 18, 2020	Jun. 17, 2021
Loop antenna	Schwarzbeck	FMZB 1519 B	HKE-014	Jun. 18, 2020	Jun. 17, 2021
Preamplifier	EMCI	EMC051845SE	HKE-015	Jun. 18, 2020	Jun. 17, 2021
Preamplifier	Agilent	83051A	HKE-016	Jun. 18, 2020	Jun. 17, 2021
Temperature and humidity meter	Boyang	HTC-1	HKE-075	Jun. 18, 2020	Jun. 17, 2021
High pass filter unit	Tonscend	JS0806-F	HKE-055	Jun. 18, 2020	Jun. 17, 2021
RF cable	Times	1-40G	HKE-034	Jun. 18, 2020	Jun. 17, 2021
Power meter	Agilent	E4419B	HKE-085	Jun. 18, 2020	Jun. 17, 2021
Power Sensor	Agilent	E9300A	HKE-086	Jun. 18, 2020	Jun. 17, 2021
Wireless Communication Test Set	R&S	CMW500	HKE-026	Jun. 18, 2020	Jun. 17, 2021
Wireless Communication Test Set	R&S	CMU200	HKE-029	Jun. 18, 2020	Jun. 17, 2021
High gain antenna	Schwarzbeck	LB-180400KF	HKE-054	Jun. 18, 2020	Jun. 17, 2021

## 2.5 Related Submittal(s) / Grant (s)

This submittal(s) (test report) is intended for FCC ID: 2AYD7-INB1 filing to comply with of the FCC Part 27 Rules.

## 2.6 Modifications

No modifications were implemented to meet testing criteria.



### 3 TEST CONDITIONS AND RESULTS

#### 3.1 Output Power

##### LIMIT

According to §27.50 (d) (4): Fixed, mobile, and portable (hand-held) stations operating in the 1710–1755 MHz band are limited to 1 watt EIRP.

##### TEST CONFIGURATION

###### Conducted Power Measurement

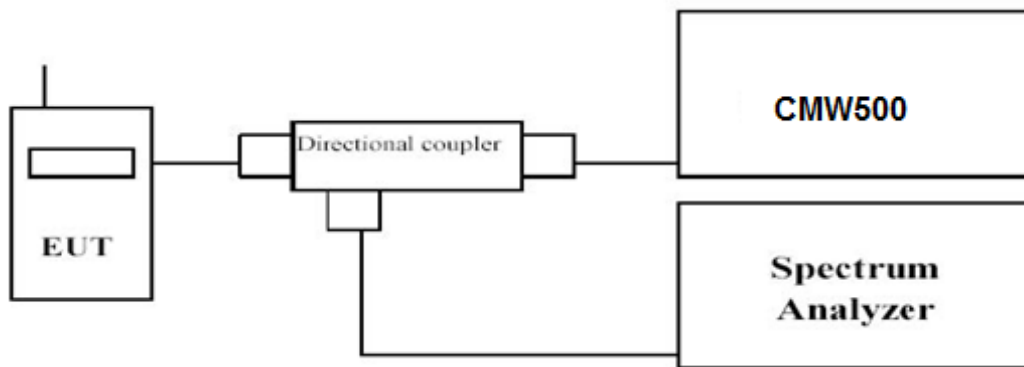

###### Radiated Power Measurement:

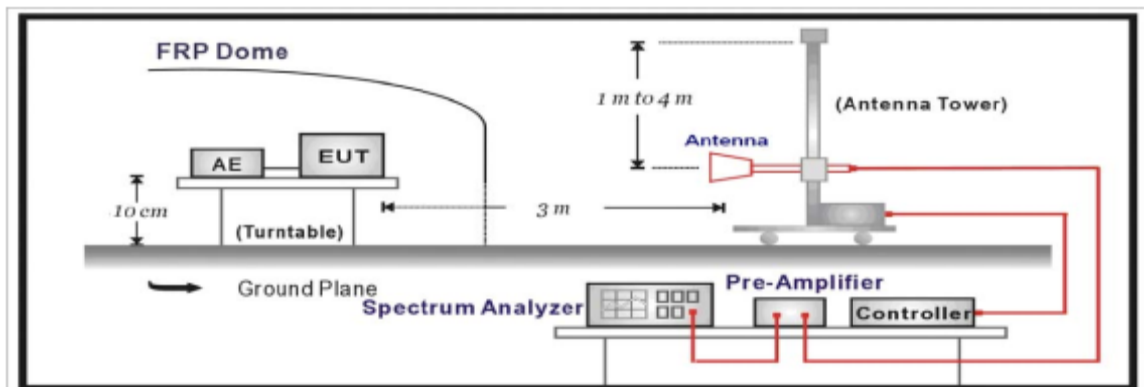

##### TEST PROCEDURE

The EUT was setup according to EIA/TIA 603D

###### **Conducted Power Measurement:**

- Place the EUT on a bench and set it in transmitting mode.
- Connect a low loss RF cable from the antenna port to a spectrum analyzer and CMW500 by a Directional Couple.
- EUT Communicate with CMW500, then select a channel for testing.
- Add a correction factor to the display of spectrum, and then test.

###### **Radiated Power Measurement:**

- The EUT shall be placed at the specified height on a support, and in the position closest to normal use as declared by provider.
- The test antenna shall be oriented initially for vertical polarization and shall be chosen to correspond to the frequency of the transmitter
- The output of the test antenna shall be connected to the measuring receiver.
- The transmitter shall be switched on and the measuring receiver shall be tuned to the frequency of the transmitter under test.
- The test antenna shall be raised and lowered through the specified range of height until a maximum signal level is detected by the measuring receiver.
- The transmitter shall then be rotated through 360° in the horizontal plane, until the maximum signal level is detected by the measuring receiver.



- g. The test antenna shall be raised and lowered again through the specified range of height until a maximum signal level is detected by the measuring receiver.
- h. The maximum signal level detected by the measuring receiver shall be noted.
- i. The transmitter shall be replaced by a substitution antenna.
- j. The substitution antenna shall be orientated for vertical polarization and the length of the substitution antenna shall be adjusted to correspond to the frequency of the transmitter.
- k. The substitution antenna shall be connected to a calibrated signal generator.
- l. If necessary, the input attenuator setting of the measuring receiver shall be adjusted in order to increase the sensitivity of the measuring receiver.
- m. The test antenna shall be raised and lowered through the specified range of height to ensure that the maximum signal is received.
- n. The input signal to the substitution antenna shall be adjusted to the level that produces a level detected by the measuring receiver, that is equal to the level noted while the transmitter radiated power was measured, corrected for the change of input attenuator setting of the measuring receiver.
- o. The measurement shall be repeated with the test antenna and the substitution antenna orientated for horizontal polarization.
- p. The measure of the effective radiated power is the larger of the two levels recorded at the input to the substitution antenna, corrected for gain of the substitution antenna if necessary.
- q. Test site anechoic chamber refer to ANSI C63.4.

**TEST RESULTS**

**Conducted Measurement:**

<i>LTE FDD Band 4</i>				
Sub-carrier Space	RB Size/Offset	Frequency (MHz)	Average Power [dBm]	
			BPSK	QPSK
3.75KHz	1@0	1710.1	22.76	21.94
		1732.5	23.01	21.71
		1754.3	22.88	21.75
	1@47	1710.1	22.70	21.89
		1732.5	22.79	21.83
		1754.3	22.63	21.67
15KHz	1@0	1710.1	22.79	21.92
		1732.5	22.92	21.69
		1754.3	22.66	21.80
	1@11	1710.1	22.98	21.68
		1732.5	22.99	21.58
		1754.3	22.80	21.87
	3@3	1710.1	22.72	21.92
		1732.5	22.79	21.74
		1754.3	22.73	21.65

**Radiated Measurement:**

Remark:

1. We were tested all RB Configuration refer 3GPP TS136 521 for each Channel Bandwidth of LTE FDD Band 4; recorded worst case for each Channel Bandwidth of LTE FDD Band 4.
2.  $EIRP = P_{Mea}(dBm) - P_{cl}(dB) + P_{Ag}(dB) + G_a(dBi)$

**LTE FDD Band 4\_Sub-carrier Space 3.75kHz\_BPSK**

Frequency (MHz)	P <sub>Mea</sub> (dBm)	P <sub>cl</sub> (dB)	G <sub>a</sub> Antenna Gain(dB)	P <sub>Ag</sub> (dB)	EIRP (dBm)	Limit (dBm)	Margin (dB)	Polarization
1710.1	-15.92	3.06	9.68	34.80	25.50	30.00	4.50	V
1732.5	-16.67	3.17	9.68	34.80	24.64	30.00	5.36	V
1754.3	-18.3	3.22	9.75	34.80	23.03	30.00	6.97	V
1710.1	-16.47	3.06	9.68	34.80	24.95	30.00	5.05	H
1732.5	-17.02	3.17	9.68	34.80	24.29	30.00	5.71	H
1754.3	-18.18	3.22	9.75	34.80	23.15	30.00	6.85	H

**LTE FDD Band 4\_Sub-carrier Space 15kHz\_BPSK**

Frequency (MHz)	P <sub>Mea</sub> (dBm)	P <sub>cl</sub> (dB)	G <sub>a</sub> Antenna Gain(dB)	P <sub>Ag</sub> (dB)	EIRP (dBm)	Limit (dBm)	Margin (dB)	Polarization
1710.1	-17.39	3.06	9.68	34.80	24.03	30.00	5.97	V
1732.5	-18.27	3.17	9.68	34.80	23.04	30.00	6.96	V
1754.3	-15.39	3.22	9.75	34.80	25.94	30.00	4.06	V
1710.1	-16.93	3.06	9.68	34.80	24.49	30.00	5.51	H
1732.5	-16.77	3.17	9.68	34.80	24.54	30.00	5.46	H
1754.3	-17.89	3.22	9.75	34.80	23.44	30.00	6.56	H

**LTE FDD Band 4\_Sub-carrier Space 3.75kHz\_QPSK**

Frequency (MHz)	P <sub>Mea</sub> (dBm)	P <sub>cl</sub> (dB)	G <sub>a</sub> Antenna Gain(dB)	P <sub>Ag</sub> (dB)	EIRP (dBm)	Limit (dBm)	Margin (dB)	Polarization
1710.1	-17.03	3.06	9.68	34.80	24.39	30.00	5.61	V
1732.5	-17.01	3.17	9.68	34.80	24.30	30.00	5.70	V
1754.3	-17.8	3.22	9.75	34.80	23.53	30.00	6.47	V
1710.1	-15.57	3.06	9.68	34.80	25.85	30.00	4.15	H
1732.5	-17.47	3.17	9.68	34.80	23.84	30.00	6.16	H
1754.3	-17.88	3.22	9.75	34.80	23.45	30.00	6.55	H

**LTE FDD Band 4\_Sub-carrier Space 15kHz\_QPSK**

Frequency (MHz)	P <sub>Mea</sub> (dBm)	P <sub>cl</sub> (dB)	G <sub>a</sub> Antenna Gain(dB)	P <sub>Ag</sub> (dB)	EIRP (dBm)	Limit (dBm)	Margin (dB)	Polarization
1710.1	-18.46	3.06	9.68	34.80	22.96	30.00	7.04	V
1732.5	-15.84	3.17	9.68	34.80	25.47	30.00	4.53	V
1754.3	-16.53	3.22	9.75	34.80	24.80	30.00	5.20	V
1710.1	-15.92	3.06	9.68	34.80	25.50	30.00	4.50	H
1732.5	-15.1	3.17	9.68	34.80	26.21	30.00	3.79	H
1754.3	-16.51	3.22	9.75	34.80	24.82	30.00	5.18	H



### 3.3 Peak-to-Average Ratio (PAR)

#### LIMIT

The Peak-to-Average Ratio (PAR) of the transmission may not exceed 13 dB.

#### TEST CONFIGURATION

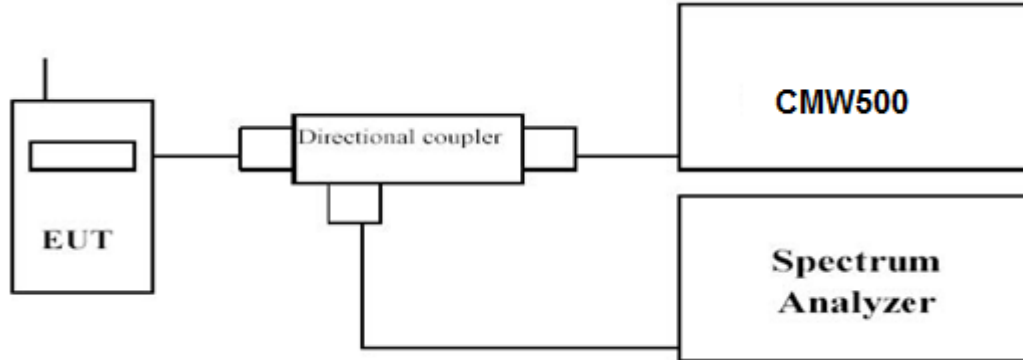

#### TEST PROCEDURE

1. Refer to instrument's analyzer instruction manual for details on how to use the power statistics/CCDF function;
2. Set resolution/measurement bandwidth  $\geq$  signal's occupied bandwidth;
3. Set the number of counts to a value that stabilizes the measured CCDF curve;
4. Set the measurement interval as follows:
  - 1). for continuous transmissions, set to 1 ms,
  - 2). for burst transmissions, employ an external trigger that is synchronized with the EUT burst timing sequence, or use the internal burst trigger with a trigger level that allows the burst to stabilize and set the measurement interval to a time that is less than or equal to the burst duration.
5. Record the maximum PAPR level associated with a probability of 0.1%.

#### TEST RESULTS

Remark:

1. We were tested all RB Configuration refer 3GPP TS136 521 for each Channel Bandwidth of LTE FDD Band 4; recorded worst case for each Channel Bandwidth of LTE FDD Band 4.

LTE FDD Band 4				
Sub-carrier Space	RB Size/Offset	Frequency (MHz)	PAPR (dB)	
			BPSK	QPSK
3.75KHz	1@0	1732.5	4.63	5.13
15KHz	1@0	1732.5	9.99	7.96



LTE FDD Band 4-3.75kHz Sub-carrier SpacePAPR

BPSK

QPSK

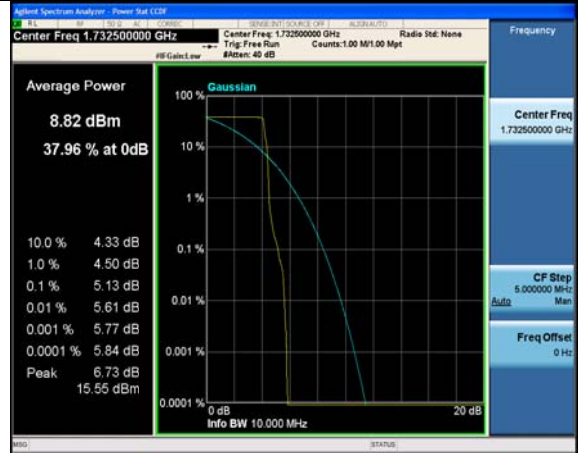
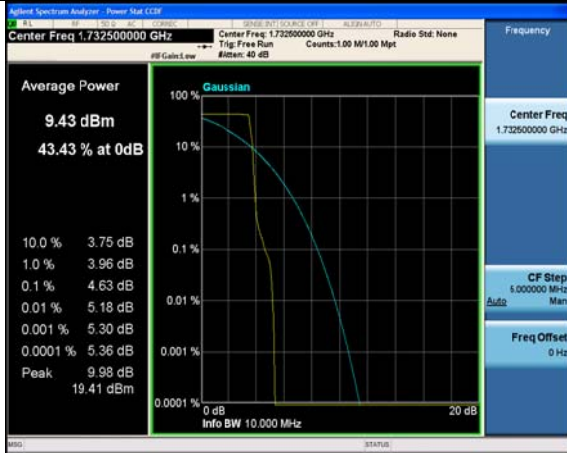

1@0

1@0

Middle Channel

LTE FDD Band 4-15kHz Sub-carrier SpacePAPR

BPSK

QPSK

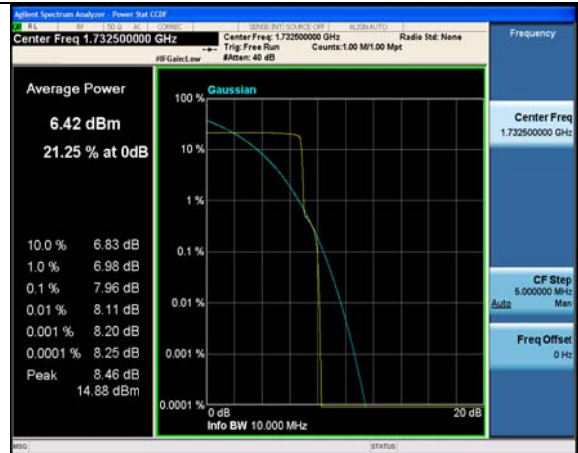
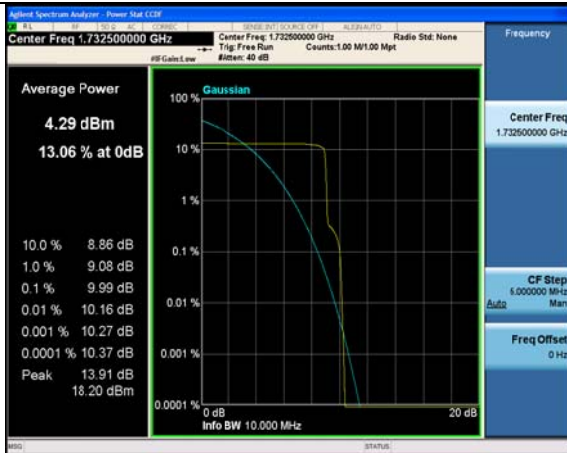

1@0

1@0

Middle Channel



### 3.4 Occupied Bandwidth and Emission Bandwidth

#### LIMIT

N/A

#### TEST CONFIGURATION

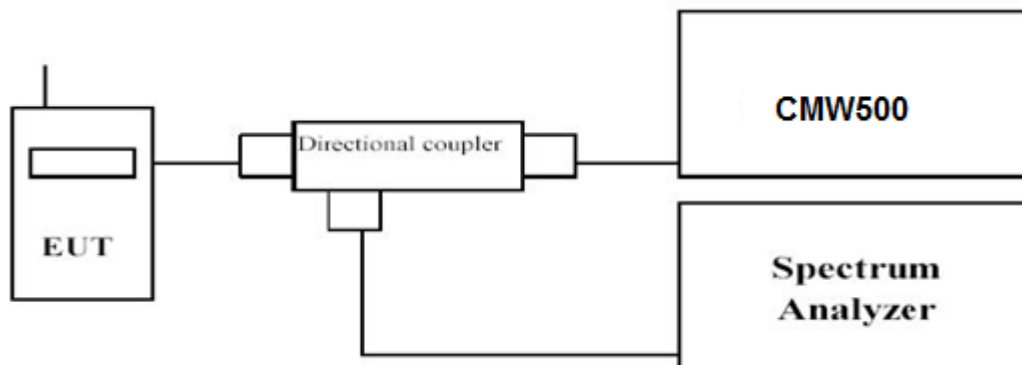

#### TEST PROCEDURE

The transmitter output was connected to a calibrated coaxial cable and coupler, the other end of which was connected to a spectrum analyzer. The occupied bandwidth was measured with the spectrum analyzer at low, middle and high channel in each band. The -26dBc Emission bandwidth was also measured and recorded. Set RBW was set to about 1% of emission BW, VBW≥3 times RBW. -26dBc display line was placed on the screen (or 99% bandwidth), the occupied bandwidth is the delta frequency between the two points where the display line intersects the signal trace.

#### TEST RESULTS

Remark:

1. We were tested all RB Configuration refer 3GPP TS136 521 for each Channel Bandwidth of LTE FDD Band 4; recorded worst case for each Channel Bandwidth of LTE FDD Band 4.

LTE FDD Band 4						
Sub-carrier Space	RB Size/Offset	Frequency (MHz)	-26dBc Emission bandwidth (MHz)		99% Occupied bandwidth (MHz)	
			BPSK	QPSK	BPSK	QPSK
3.75KHz	1@0	1710.1	0.04399	0.04712	0.067879	0.080138
		1732.5	0.04314	0.05033	0.066265	0.081143
		1754.3	0.04384	0.4776	0.067275	0.080640
15KHz	1@0	1710.1	0.1054	0.1163	0.12160	0.12385
		1732.5	0.1047	0.1295	0.12099	0.12317
		1754.3	0.1056	0.1303	0.11994	0.12345
	12@0	1710.1	0.2464	0.2488	0.18456	0.18925
		1732.5	0.2494	0.2461	0.19021	0.18880
		1754.3	0.2578	0.2445	0.18790	0.18619



LTE FDD Band 4-3.75kHz Sub-carrier Space

BPSK



1@0

QPSK



1@0

Low Channel



1@0



1@0

Middle Channel

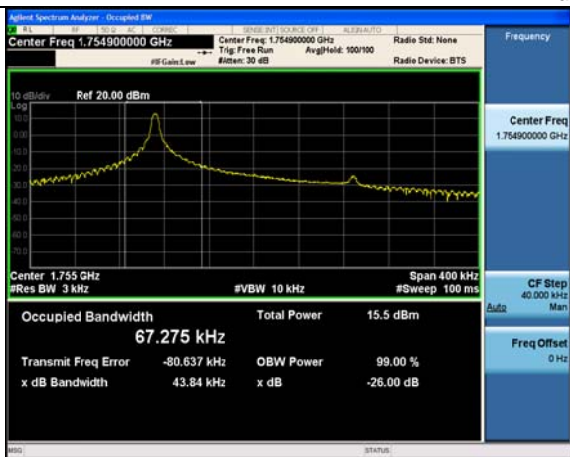

1@0



1@0

High Channel



LTE FDD Band 4-15kHz Sub-carrier Space

BPSK

QPSK



1@0

1@0

Low Channel

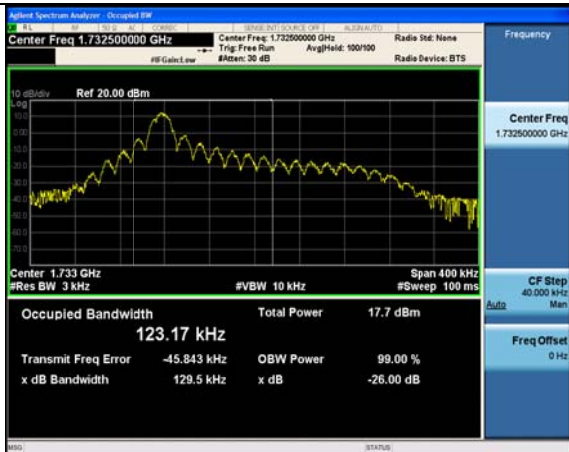

1@0

1@0

Middle Channel



1@0

1@0

High Channel





LTE FDD Band 4-15kHz Sub-carrier Space

BPSK

QPSK

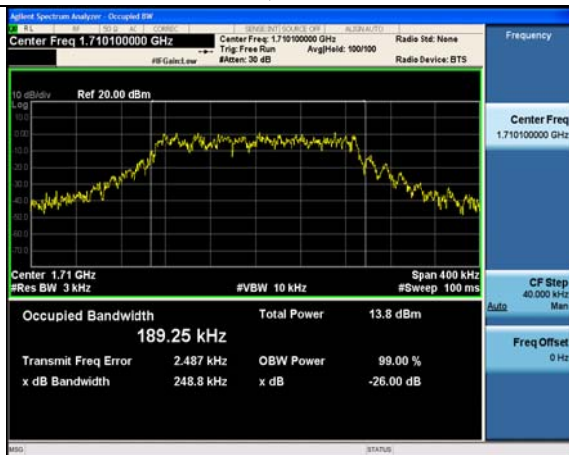

12@0

12@0

Low Channel

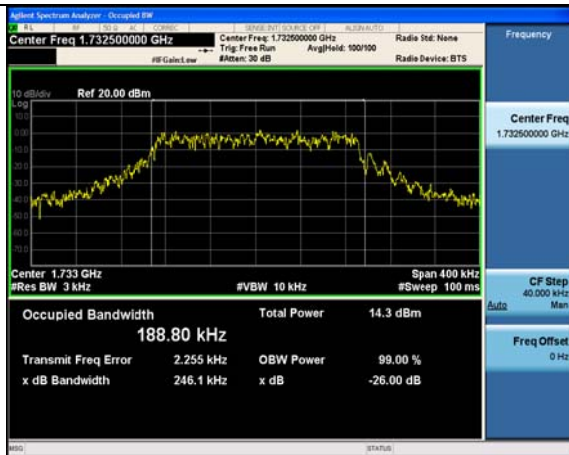

12@0

12@0

Middle Channel

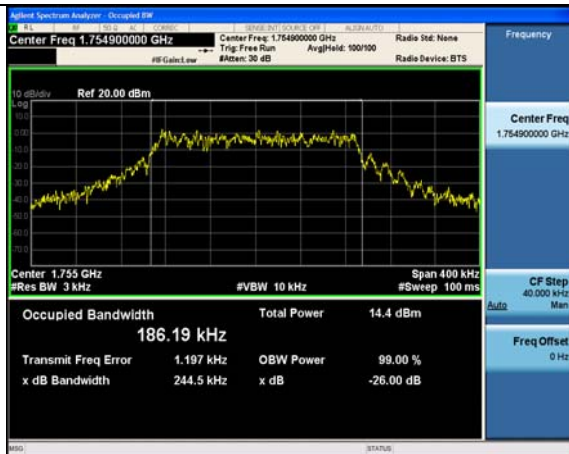

12@0

12@0

High Channel



### 3.5 Band Edge compliance

#### LIMIT

According to §27.53 (h): For operations in the 1710–1755 MHz and 2110–2155 MHz bands, the power of any emission outside a licensee's frequency block shall be attenuated below the transmitter power (P) by at least  $43 + 10 \log_{10}(P)$  dB.

#### TEST CONFIGURATION

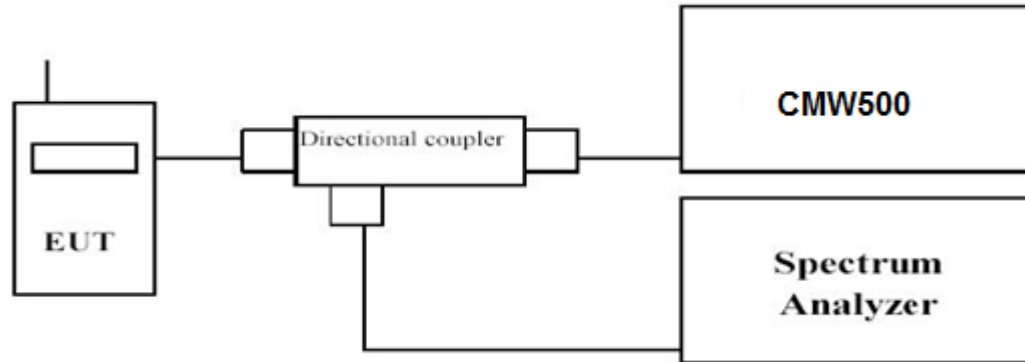

#### TEST PROCEDURE

1. The transmitter output port was connected to base station.
2. The RF output of EUT was connected to the power meter by RF cable and attenuator, the path loss was compensated to the results for each measurement.
3. Set EUT at maximum power through base station.
4. Select lowest and highest channels for each band and different modulation.
5. Measure Band edge using RMS (Average) detector by spectrum

#### TEST RESULTS

*Remark:*

1. We were tested all RB Configuration refer 3GPP TS136 521 for each Channel Bandwidth of LTE FDD Band 4; recorded worst case for each Channel Bandwidth of LTE FDD Band 4.



LTE FDD Band 4-3.75kHz Sub-carrier Space Band Edge Compliance  
BPSK QPSK



1@0

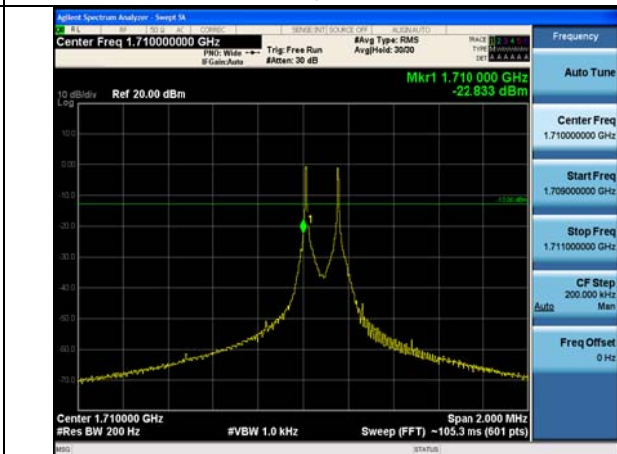

1@0

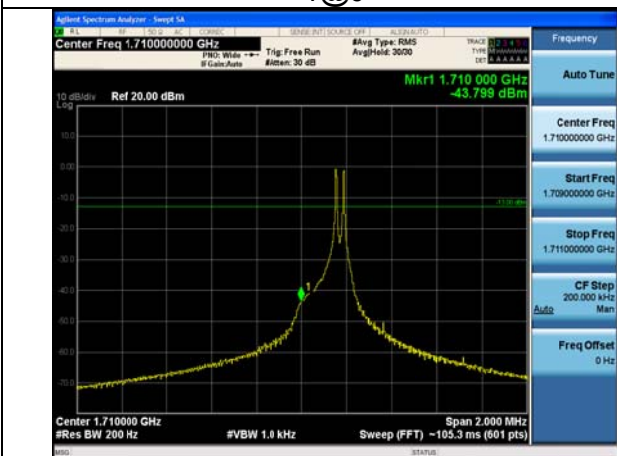

1@47

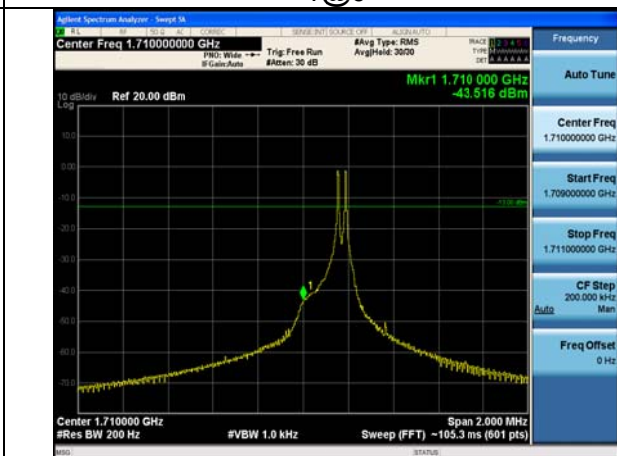

1@47

Low Channel

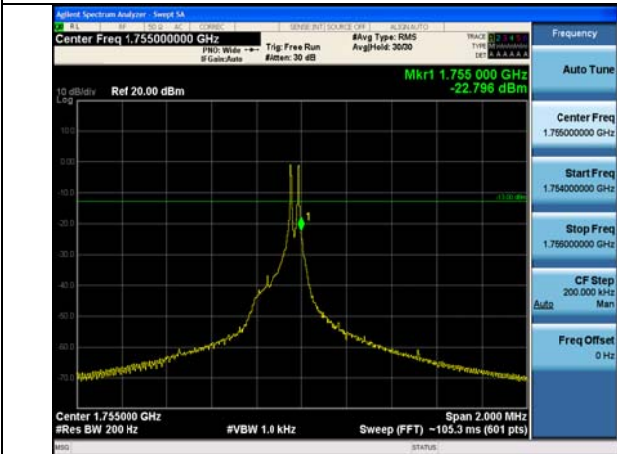

1@0

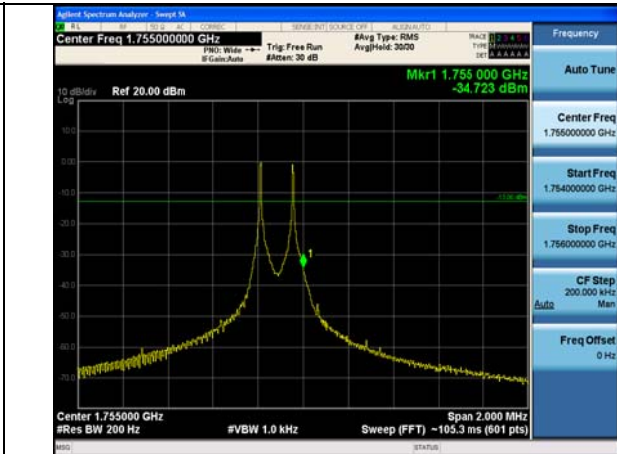

1@0

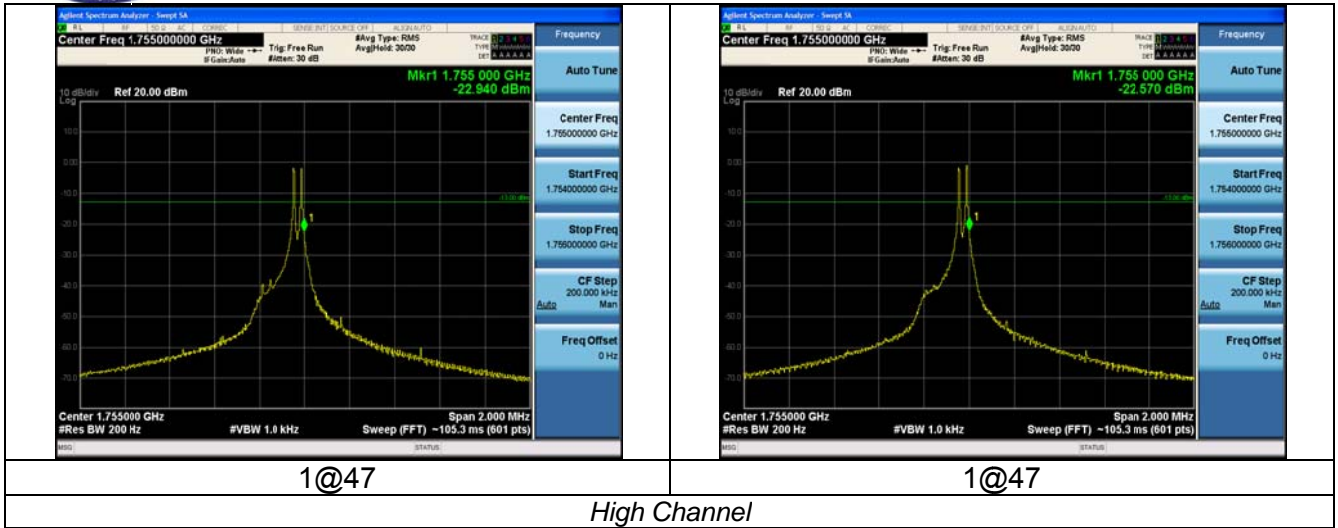

LTE FDD Band 4-15kHz Sub-carrier Space Band Edge Compliance

BPSK

QPSK

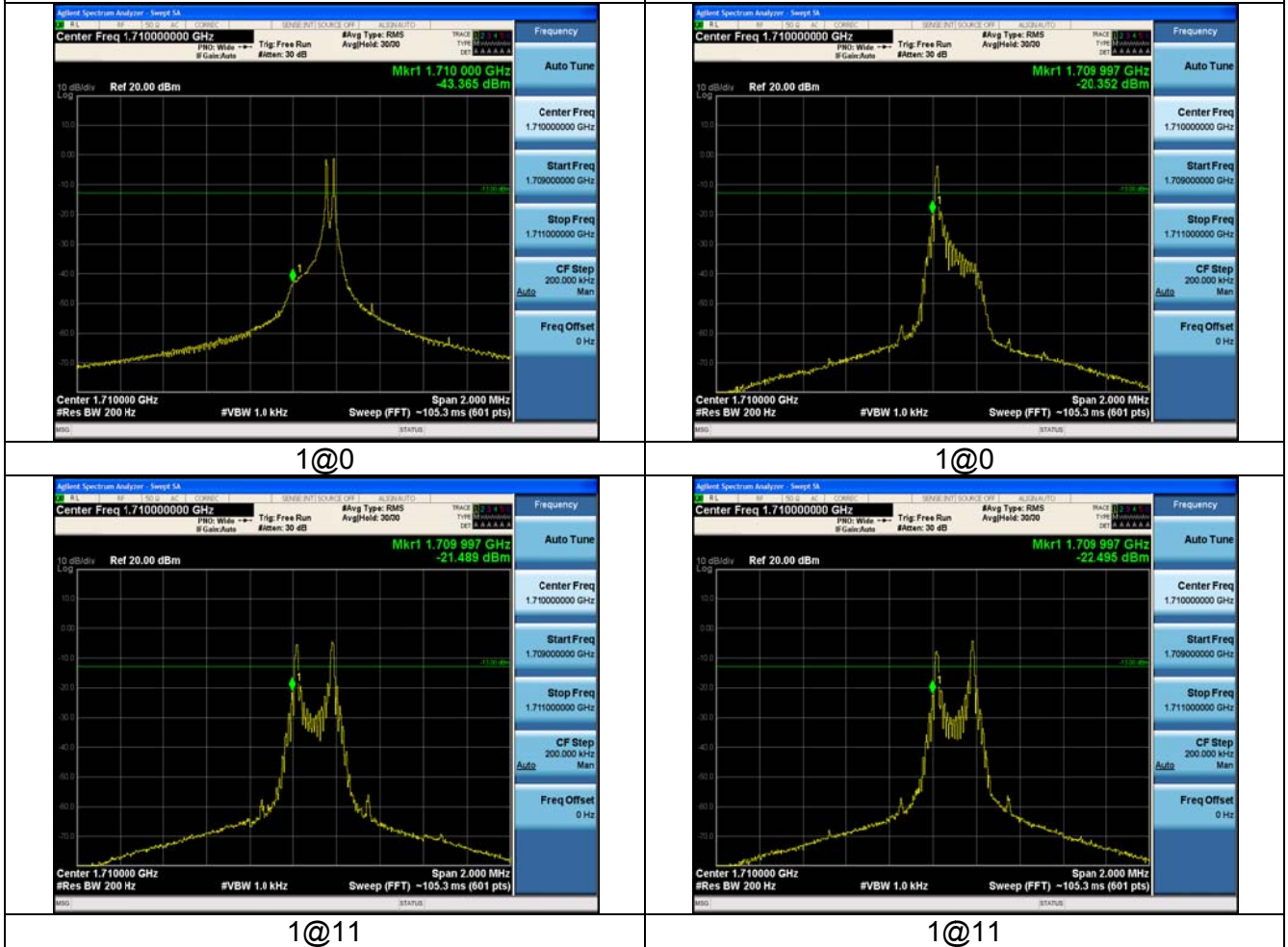

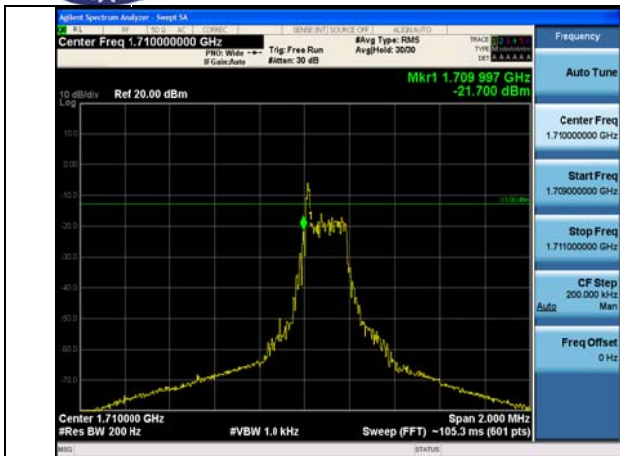

12@0

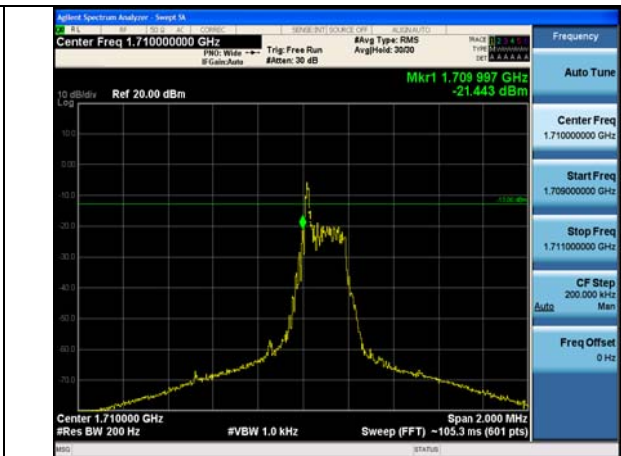

12@0

Low Channel

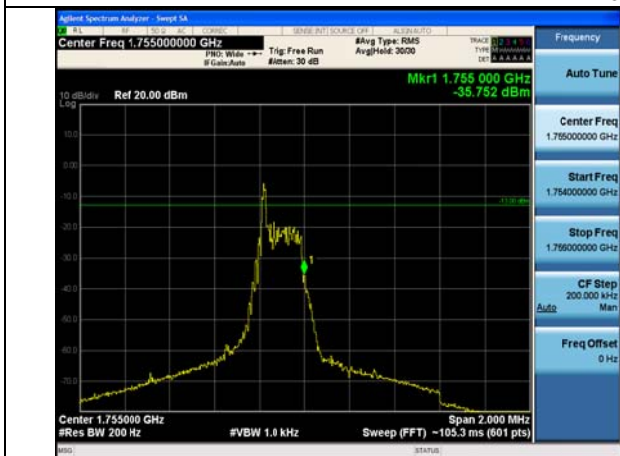

1@0

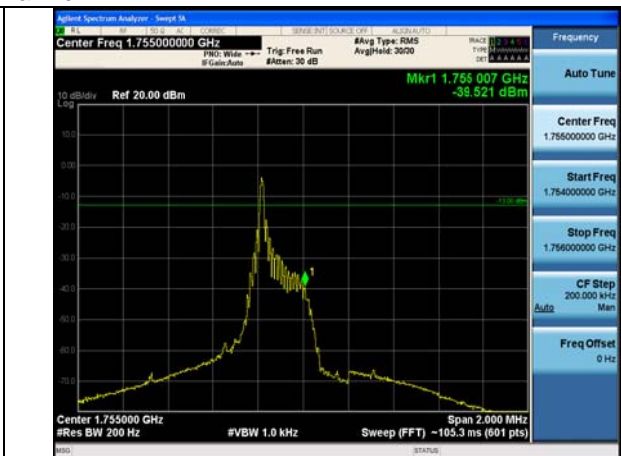

1@0

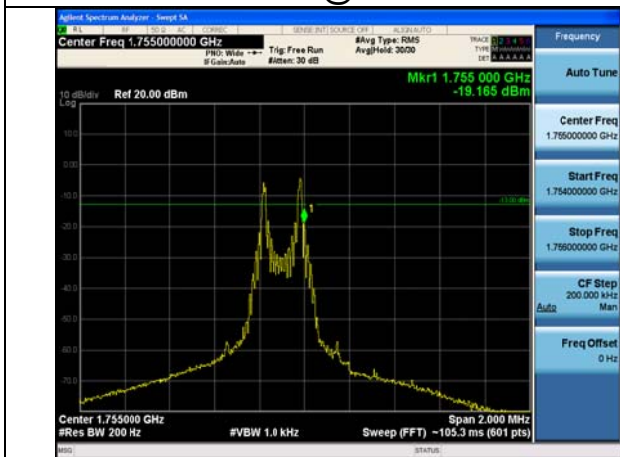

1@11



1@11

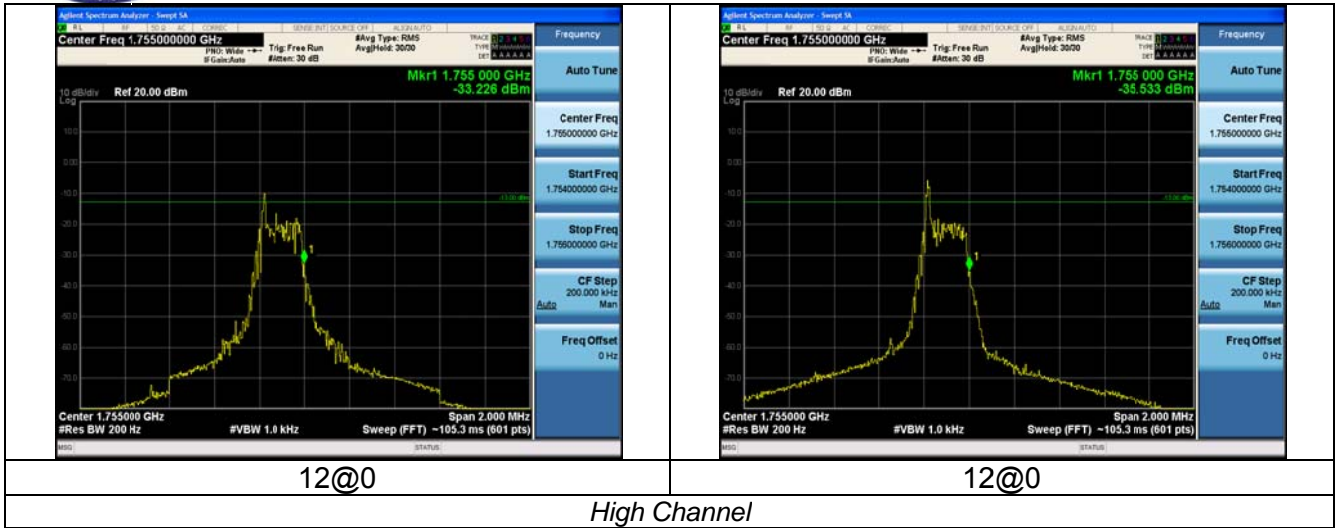

### 3.6 Spurious Emission

#### LIMIT

According to §27.53 (h): For operations in the 1710–1755 MHz and 2110–2155 MHz bands, the power of any emission outside a licensee’s frequency block shall be attenuated below the transmitter power (P) by at least  $43 + 10 \log_{10}(P)$  dB.

#### TEST CONFIGURATION

Conducted Spurious Measurement:

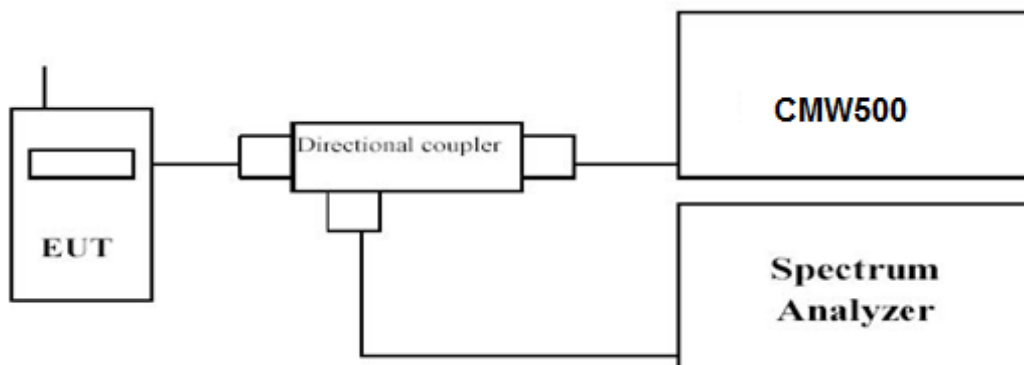

Radiated Spurious Measurement:

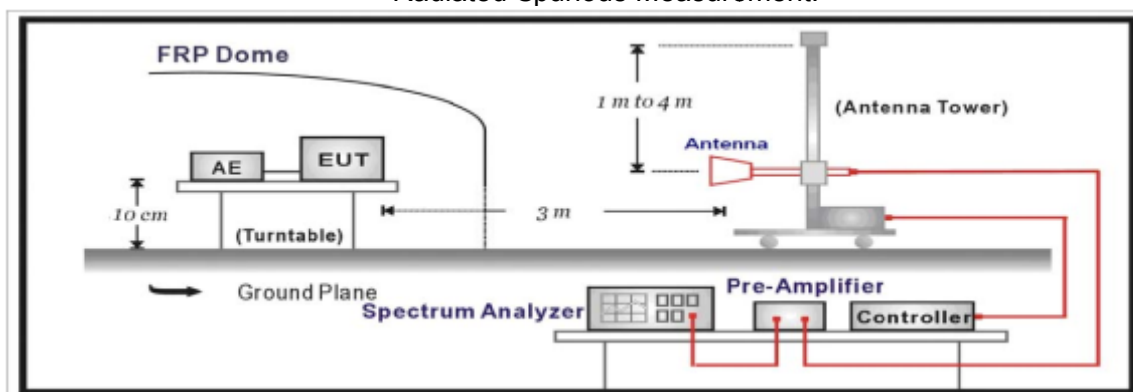

#### TEST PROCEDURE

The EUT was setup according to EIA/TIA 603D

##### Conducted Spurious Measurement:

- Place the EUT on a bench and set it in transmitting mode.
- Connect a low loss RF cable from the antenna port to a spectrum analyzer and CMW500 by a Directional Couple.
- EUT Communicate with CMW500, then select a channel for testing.
- Add a correction factor to the display of spectrum, and then test.
- The resolution bandwidth of the spectrum analyzer was set sufficient scans were taken to show the out of band Emission if any up to  $10^{th}$  harmonic.
- Please refer to following tables for test antenna conducted emissions.

Working Frequency	Sub range (GHz)	RBW	VBW	Sweep time (s)
LTE FDD Band 4	0.000009~0.000015	1KHz	3KHz	Auto
	0.000015~0.03	10KHz	30KHz	Auto
	0.03~26.5	1 MHz	3 MHz	Auto

##### Radiated Spurious Measurement:

- The EUT shall be placed at the specified height on a support, and in the position closest to normal use as declared by provider.
- The test antenna shall be oriented initially for vertical polarization and shall be chosen to correspond to the frequency of the transmitter
- The output of the test antenna shall be connected to the measuring receiver.



- d. The transmitter shall be switched on and the measuring receiver shall be tuned to the frequency of the transmitter under test.
- e. The test antenna shall be raised and lowered through the specified range of height until a maximum signal level is detected by the measuring receiver.
- f. The transmitter shall then be rotated through 360° in the horizontal plane, until the maximum signal level is detected by the measuring receiver.
- g. The test antenna shall be raised and lowered again through the specified range of height until a maximum signal level is detected by the measuring receiver.
- h. The maximum signal level detected by the measuring receiver shall be noted.
- i. The transmitter shall be replaced by a substitution antenna.
- j. The substitution antenna shall be orientated for vertical polarization and the length of the substitution antenna shall be adjusted to correspond to the frequency of the transmitter.
- k. The substitution antenna shall be connected to a calibrated signal generator.
- l. If necessary, the input attenuator setting of the measuring receiver shall be adjusted in order to increase the sensitivity of the measuring receiver.
- m. The test antenna shall be raised and lowered through the specified range of height to ensure that the maximum signal is received.
- n. The input signal to the substitution antenna shall be adjusted to the level that produces a level detected by the measuring receiver, that is equal to the level noted while the transmitter radiated power was measured, corrected for the change of input attenuator setting of the measuring receiver.
- o. The measurement shall be repeated with the test antenna and the substitution antenna orientated for horizontal polarization.
- p. The measure of the effective radiated power is the larger of the two levels recorded at the input to the substitution antenna, corrected for gain of the substitution antenna if necessary.
- q. The resolution bandwidth of the spectrum analyzer was set at 100 kHz for Part 22 and 1MHz for Part 24. The frequency range was checked up to 10th harmonic.
- r. Test site anechoic chamber refer to ANSI C63.

## **TEST RESULTS**

### *Remark:*

1. *We were tested all RB Configuration refer 3GPP TS136 521 for each Channel Bandwidth of LTE FDD Band 4; recorded worst case for each Channel Bandwidth of LTE FDD Band 4.*

### **Conducted Measurement:**





LTE Band 4-3.75kHz Sub-carrier Space  
Low Channel

BPSK

QPSK

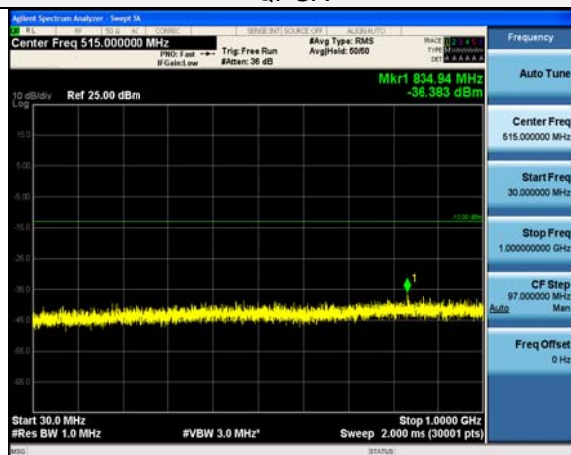
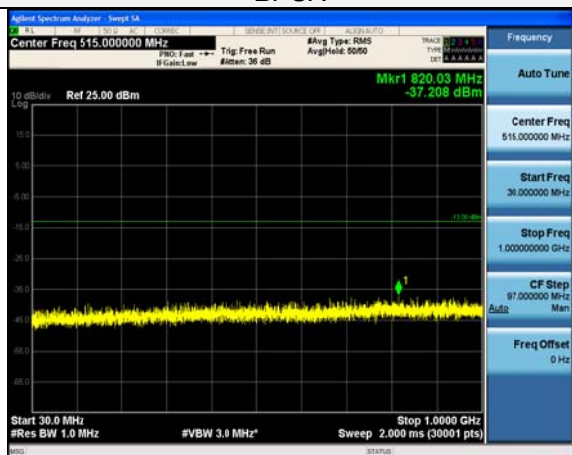

30MHz~1GHz

30MHz~1GHz



1GHz ~5GHz

1GHz ~5GHz



5GHz ~12GHz

5GHz ~12GHz

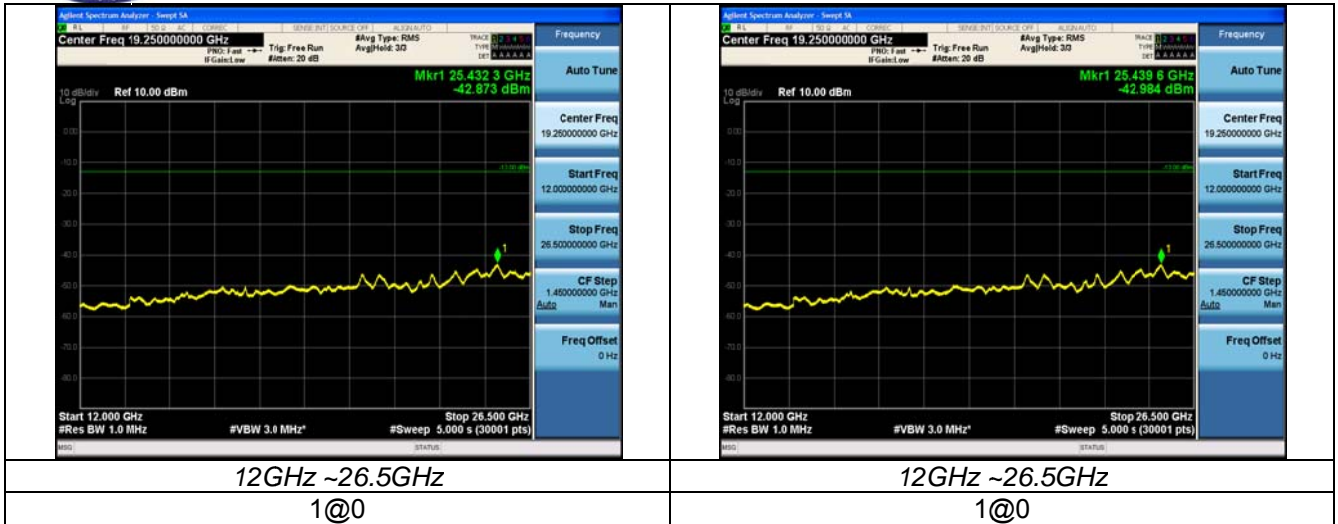

**LTE Band 4-3.75kHz Sub-carrier Space  
Middle Channel**

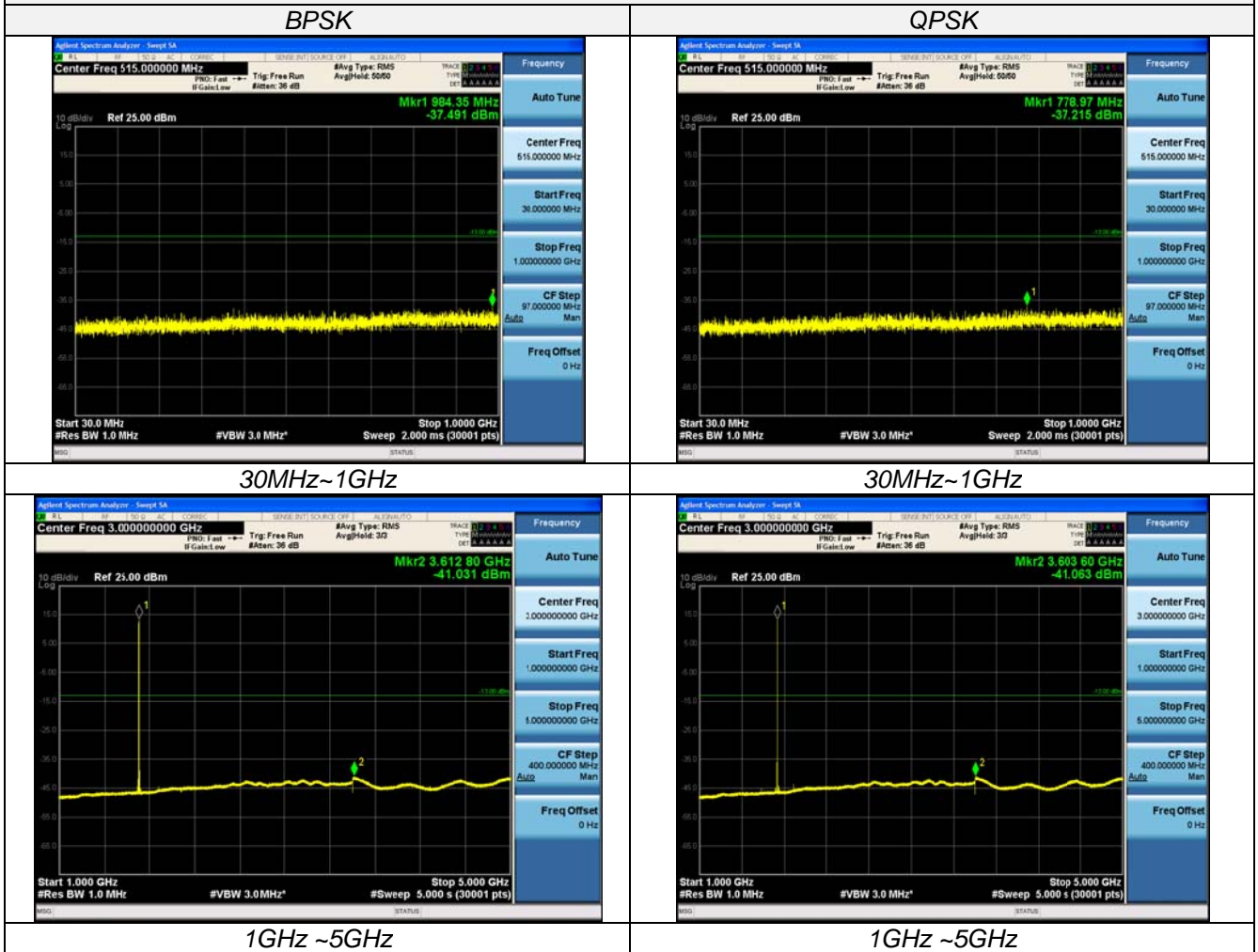

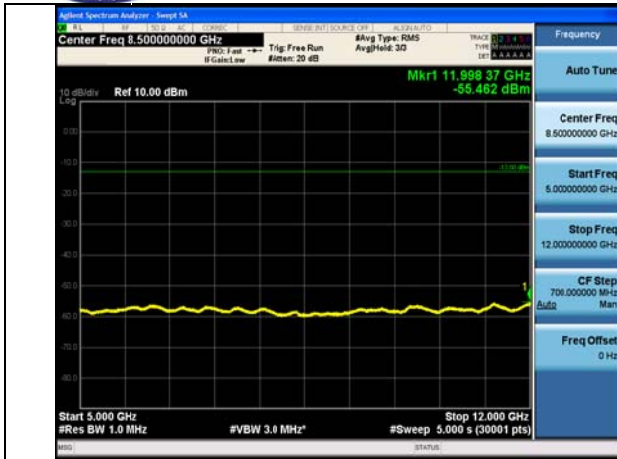

5GHz ~12GHz

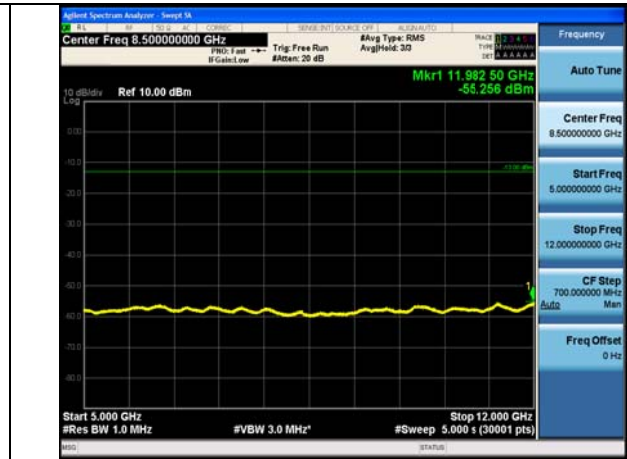

5GHz ~12GHz

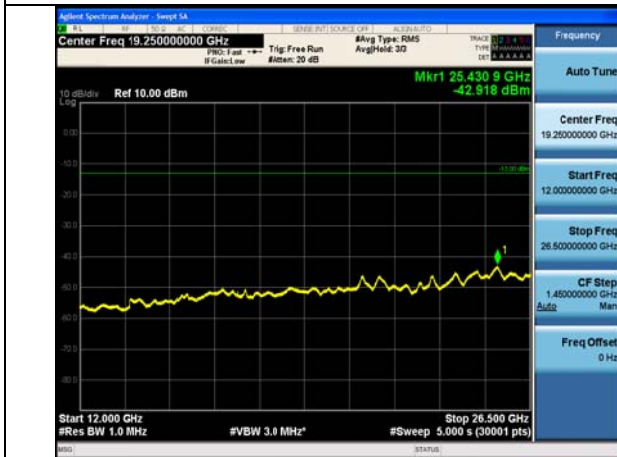

12GHz ~26.5GHz

1@0

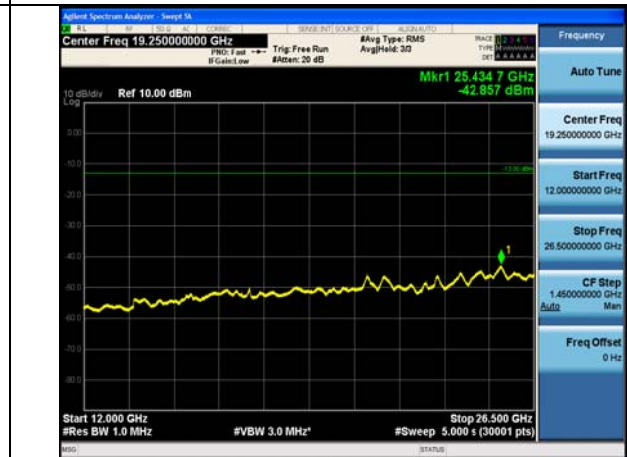

12GHz ~26.5GHz

1@0

LTE Band 4-3.75kHz Sub-carrier Space  
High Channel

BPSK

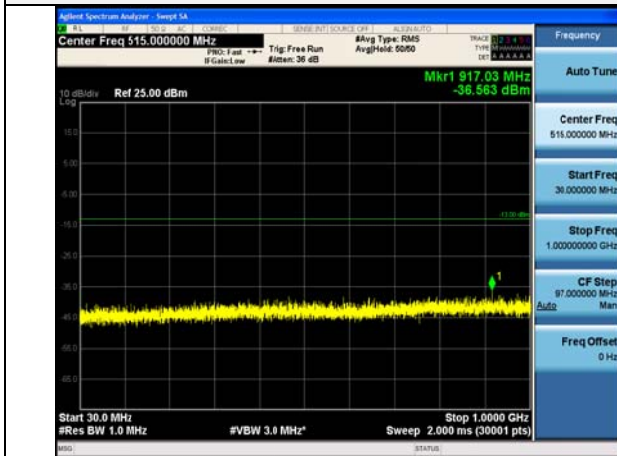

30MHz~1GHz

QPSK

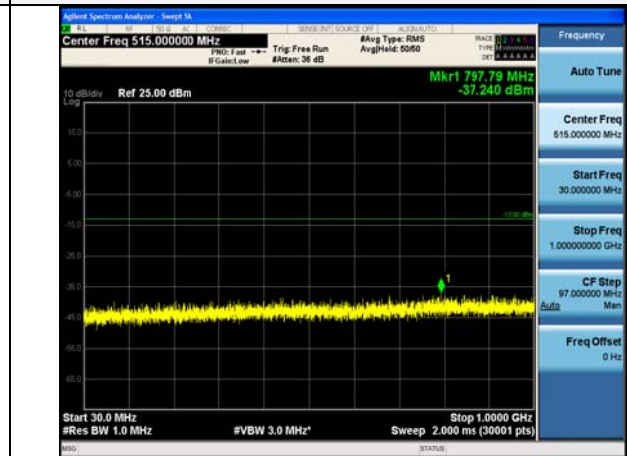

30MHz~1GHz



1GHz ~5GHz



1GHz ~5GHz



5GHz ~12GHz



5GHz ~12GHz



12GHz ~26.5GHz

1@0



12GHz ~26.5GHz

1@0



LTE Band 4-15kHz Sub-carrier Space  
Low Channel

BPSK

QPSK

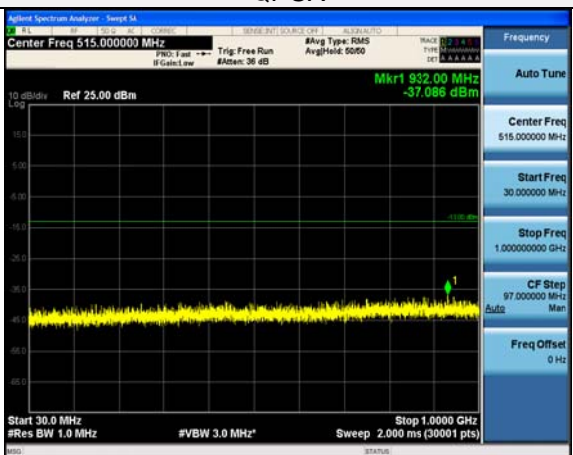
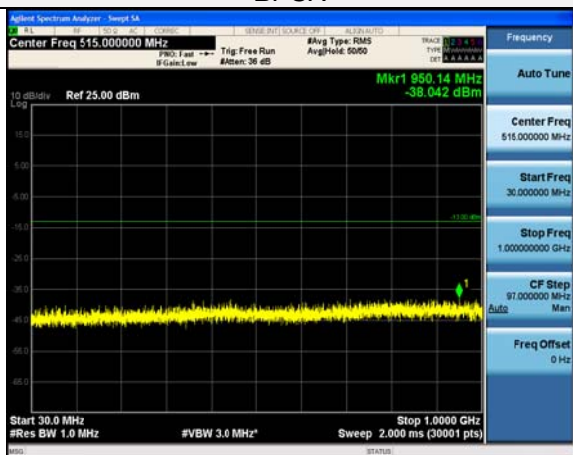

30MHz~1GHz

30MHz~1GHz



1GHz ~5GHz

1GHz ~5GHz



5GHz ~12GHz

5GHz ~12GHz

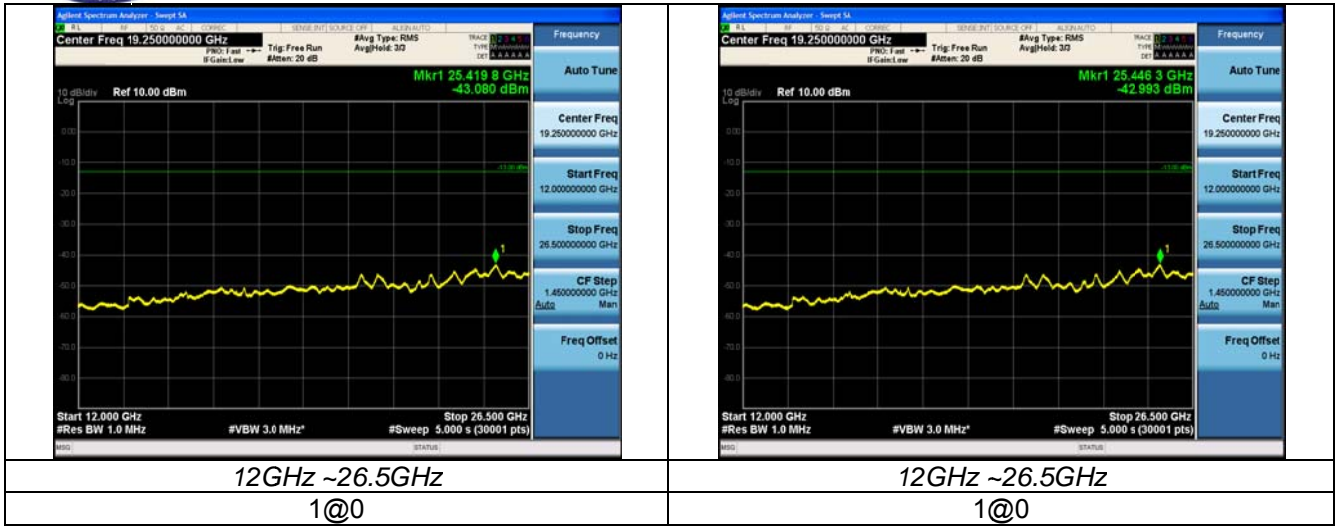

*LTE Band 4-15kHz Sub-carrier Space  
Middle Channel*

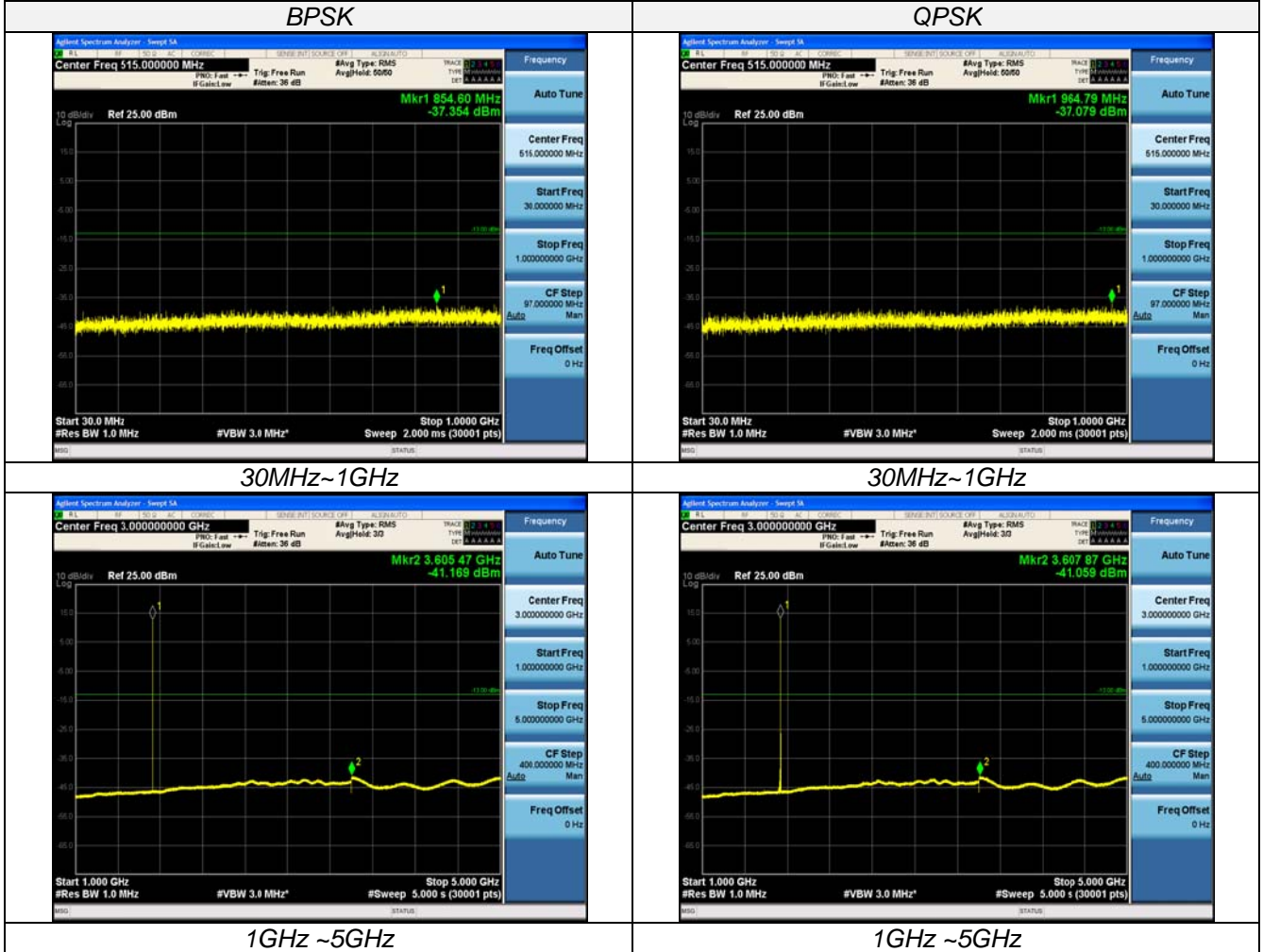

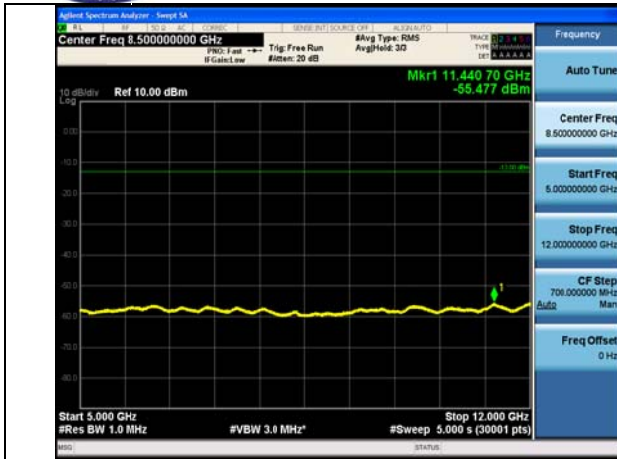

5GHz ~12GHz

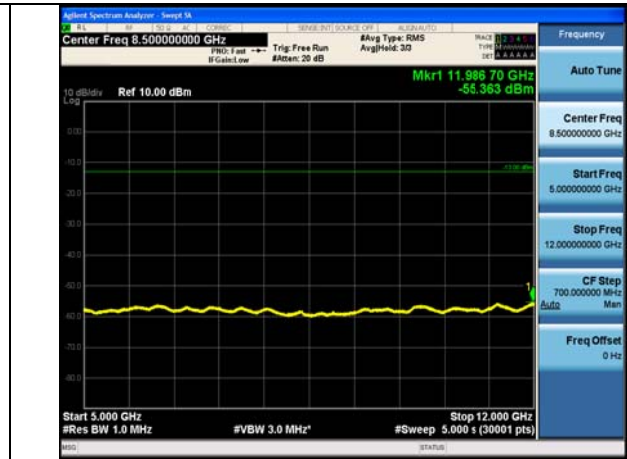

5GHz ~12GHz

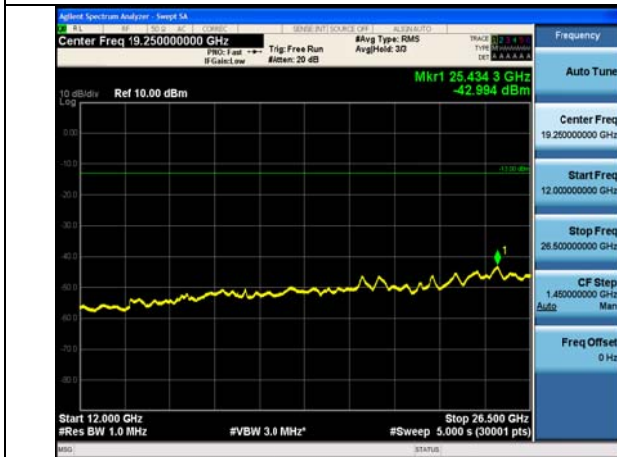

12GHz ~26.5GHz

1@0

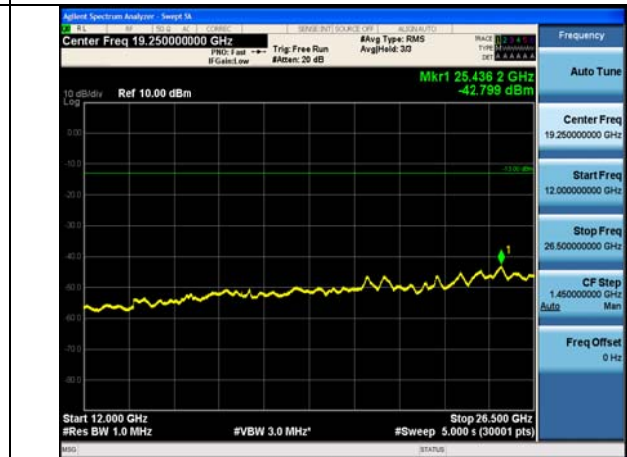

12GHz ~26.5GHz

1@0

LTE Band 4-15kHz Sub-carrier Space  
High Channel

BPSK

QPSK

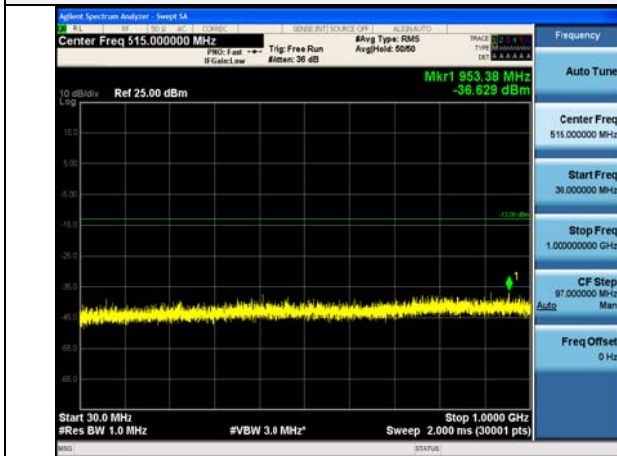

30MHz~1GHz

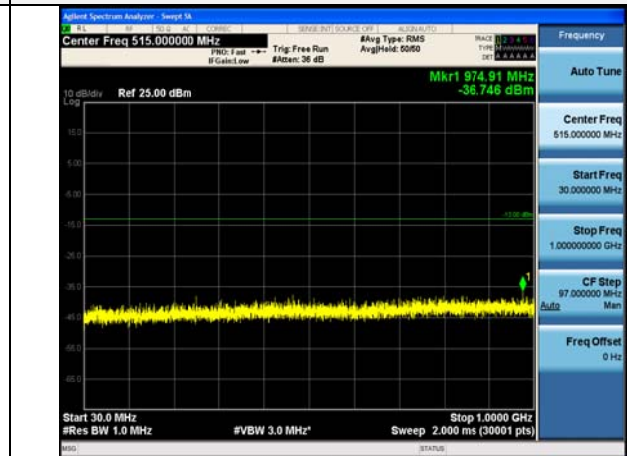

30MHz~1GHz

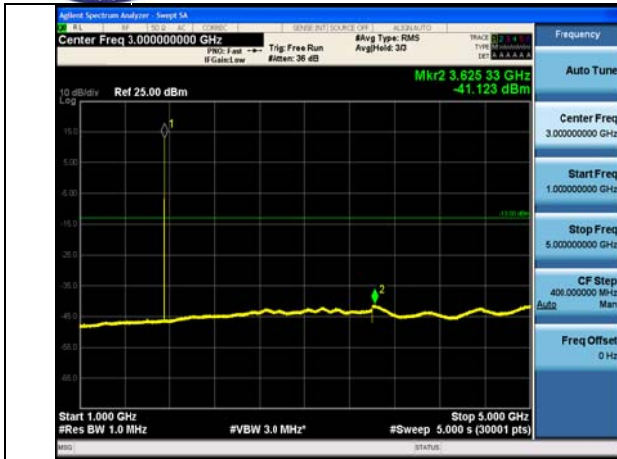

1GHz ~5GHz

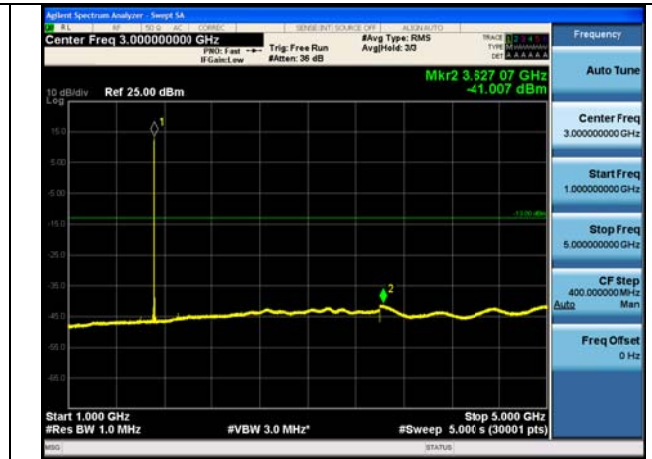

1GHz ~5GHz

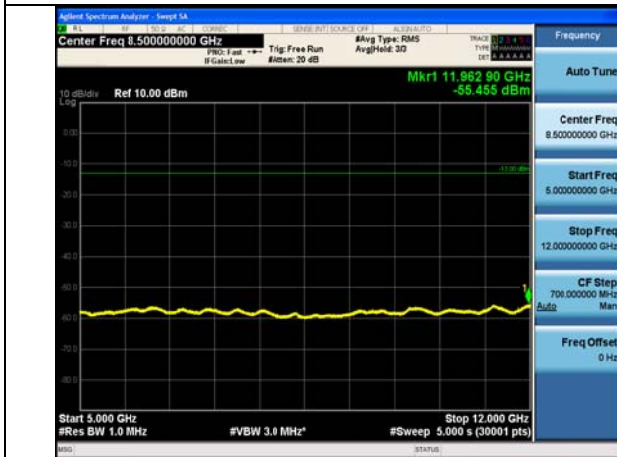

5GHz ~12GHz



5GHz ~12GHz

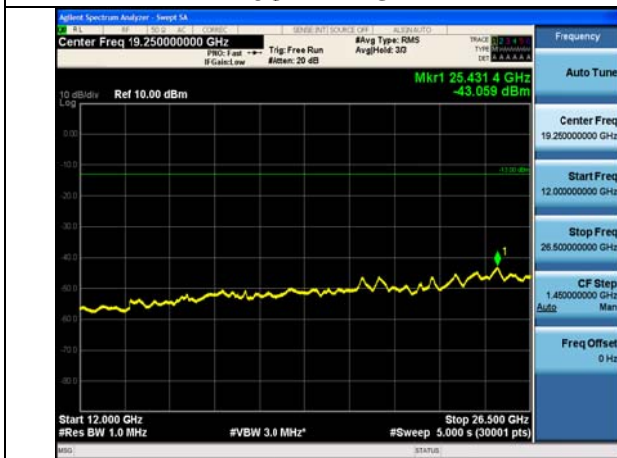

12GHz ~26.5GHz

1@0

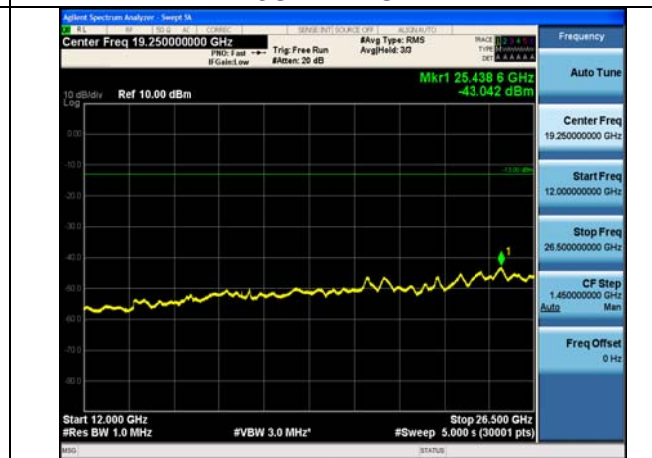

12GHz ~26.5GHz

1@0



**Radiated Measurement:***Remark:*

1. We were tested all RB Configuration refer 3GPP TS136 521 for each Channel Bandwidth of LTE FDD Band 4; recorded worst case for each Channel Bandwidth of LTE FDD Band 4.
2.  $EIRP = P_{Mea}(dBm) - P_{cl}(dB) + G_a(dBi)$
3. We were not recorded other points as values lower than limits.
4.  $Margin = Limit - EIRP$

LTE FDD Band 4 Sub-carrier Space 3.75kHz BPSK Low Channel

Frequency (MHz)	PMea (dBm)	Pcl (dB)	Diatance	Ga Antenna Gain(dB)	Peak EIRP (dBm)	Limit (dBm)	Margin (dB)	Polarization
3420.2	-43.64	4.02	3	12.5	-35.16	-13.00	22.16	H
5130.3	-47.54	5.11	3	13.38	-39.27	-13.00	26.27	H
3420.2	-49.75	4.02	3	12.5	-41.27	-13.00	28.27	V
5130.3	-47.79	5.11	3	13.38	-39.52	-13.00	26.52	V

LTE FDD Band 4 Sub-carrier Space 3.75kHz BPSK Middle Channel

Frequency (MHz)	PMea (dBm)	Pcl (dB)	Diatance	Ga Antenna Gain(dB)	EIRP (dBm)	Limit (dBm)	Margin (dB)	Polarization
3465.0	-43.85	4.02	3	12.45	-35.42	-13.00	22.42	H
5197.5	-47.56	5.11	3	13.38	-39.29	-13.00	26.29	H
3465.0	-49.29	4.02	3	12.45	-40.86	-13.00	27.86	V
5197.5	-47.66	5.11	3	13.38	-39.39	-13.00	26.39	V

LTE FDD Band 4 Sub-carrier Space 3.75kHz BPSK High Channel

Frequency (MHz)	PMea (dBm)	Pcl (dB)	Diatance	Ga Antenna Gain(dB)	EIRP (dBm)	Limit (dBm)	Margin (dB)	Polarization
3508.6	-42.69	4.02	3	12.21	-34.5	-13.00	21.5	H
5262.9	-46.57	5.11	3	13.26	-38.42	-13.00	25.42	H
3508.6	-49.1	4.02	3	12.21	-40.91	-13.00	27.91	V
5262.9	-48	5.11	3	13.26	-39.85	-13.00	26.85	V

LTE FDD Band 4 Sub-carrier Space 15kHz BPSK Low Channel

Frequency (MHz)	PMea (dBm)	Pcl (dB)	Diatance	Ga Antenna Gain(dB)	Peak EIRP (dBm)	Limit (dBm)	Margin (dB)	Polarization
3420.2	-45.25	4.02	3	12.5	-36.77	-13.00	23.77	H
5130.3	-48.98	5.11	3	13.38	-40.71	-13.00	27.71	H
3420.2	-51.18	4.02	3	12.5	-42.7	-13.00	29.7	V
5130.3	-48.9	5.11	3	13.38	-40.63	-13.00	27.63	V

LTE FDD Band 4 Sub-carrier Space 15kHz BPSK Middle Channel

Frequency (MHz)	PMea (dBm)	Pcl (dB)	Diatance	Ga Antenna Gain(dB)	EIRP (dBm)	Limit (dBm)	Margin (dB)	Polarization
3465.0	-44.16	4.02	3	12.45	-35.73	-13.00	22.73	H
5197.5	-47.36	5.11	3	13.38	-39.09	-13.00	26.09	H
3465.0	-49.3	4.02	3	12.45	-40.87	-13.00	27.87	V
5197.5	-47.17	5.11	3	13.38	-38.9	-13.00	25.9	V

LTE FDD Band 4 Sub-carrier Space 15kHz BPSK High Channel

Frequency (MHz)	PMea (dBm)	Pcl (dB)	Diatance	Ga Antenna Gain(dB)	EIRP (dBm)	Limit (dBm)	Margin (dB)	Polarization
3508.6	-43.22	4.02	3	12.21	-35.03	-13.00	22.03	H
5262.9	-47.2	5.11	3	13.26	-39.05	-13.00	26.05	H
3508.6	-48.77	4.02	3	12.21	-40.58	-13.00	27.58	V
5262.9	-48.3	5.11	3	13.26	-40.15	-13.00	27.15	V



## LTE FDD Band 4 Sub-carrier Space 3.75kHz QPSK Low Channel

Frequency (MHz)	PMea (dBm)	Pcl (dB)	Diatance	Ga Antenna Gain(dB)	Peak EIRP (dBm)	Limit (dBm)	Margin (dB)	Polarization
3420.2	-45.72	4.02	3	12.5	-37.24	-13.00	24.24	H
5130.3	-47.51	5.11	3	13.38	-39.24	-13.00	26.24	H
3420.2	-49.75	4.02	3	12.5	-41.27	-13.00	28.27	V
5130.3	-48.67	5.11	3	13.38	-40.4	-13.00	27.4	V

## LTE FDD Band 4 Sub-carrier Space 3.75kHz QPSK Middle Channel

Frequency (MHz)	PMea (dBm)	Pcl (dB)	Diatance	Ga Antenna Gain(dB)	EIRP (dBm)	Limit (dBm)	Margin (dB)	Polarization
3465.0	-43.73	4.02	3	12.45	-35.3	-13.00	22.3	H
5197.5	-47.44	5.11	3	13.38	-39.17	-13.00	26.17	H
3465.0	-49.38	4.02	3	12.45	-40.95	-13.00	27.95	V
5197.5	-47.32	5.11	3	13.38	-39.05	-13.00	26.05	V

## LTE FDD Band 4 Sub-carrier Space 3.75kHz QPSK High Channel

Frequency (MHz)	PMea (dBm)	Pcl (dB)	Diatance	Ga Antenna Gain(dB)	EIRP (dBm)	Limit (dBm)	Margin (dB)	Polarization
3508.6	-42.59	4.02	3	12.21	-34.4	-13.00	21.4	H
5262.9	-46.35	5.11	3	13.26	-38.2	-13.00	25.2	H
3508.6	-49.18	4.02	3	12.21	-40.99	-13.00	27.99	V
5262.9	-48.31	5.11	3	13.26	-40.16	-13.00	27.16	V

## LTE FDD Band 4 Sub-carrier Space 15kHz QPSK Low Channel

Frequency (MHz)	PMea (dBm)	Pcl (dB)	Diatance	Ga Antenna Gain(dB)	Peak EIRP (dBm)	Limit (dBm)	Margin (dB)	Polarization
3420.2	-43.25	4.02	3	12.5	-34.77	-13.00	21.77	H
5130.3	-49.4	5.11	3	13.38	-41.13	-13.00	28.13	H
3420.2	-50.94	4.02	3	12.5	-42.46	-13.00	29.46	V
5130.3	-47.36	5.11	3	13.38	-39.09	-13.00	26.09	V

## LTE FDD Band 4 Sub-carrier Space 15kHz QPSK Middle Channel

Frequency (MHz)	PMea (dBm)	Pcl (dB)	Diatance	Ga Antenna Gain(dB)	EIRP (dBm)	Limit (dBm)	Margin (dB)	Polarization
3465.0	-44.18	4.02	3	12.45	-35.75	-13.00	22.75	H
5197.5	-47.4	5.11	3	13.38	-39.13	-13.00	26.13	H
3465.0	-49.42	4.02	3	12.45	-40.99	-13.00	27.99	V
5197.5	-47.6	5.11	3	13.38	-39.33	-13.00	26.33	V

## LTE FDD Band 4 Sub-carrier Space 15kHz QPSK High Channel

Frequency (MHz)	PMea (dBm)	Pcl (dB)	Diatance	Ga Antenna Gain(dB)	EIRP (dBm)	Limit (dBm)	Margin (dB)	Polarization
3508.6	-42.79	4.02	3	12.21	-34.6	-13.00	21.6	H
5262.9	-46.83	5.11	3	13.26	-38.68	-13.00	25.68	H
3508.6	-48.78	4.02	3	12.21	-40.59	-13.00	27.59	V
5262.9	-48.27	5.11	3	13.26	-40.12	-13.00	27.12	V



### 3.7 Frequency Stability under Temperature & Voltage Variations

#### LIMIT

According to §27.54, §2.1055 requirement, the frequency stability shall be sufficient to ensure that the fundamental emissions stay within the authorized bands of operation and should not exceed 2.5ppm.

#### TEST CONFIGURATION

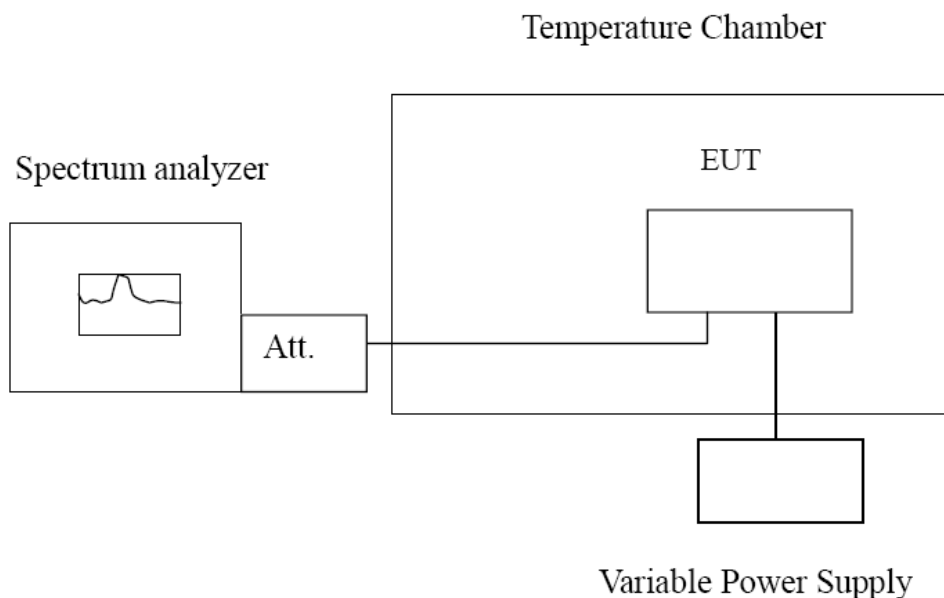

#### TEST PROCEDURE

The EUT was setup according to EIA/TIA 603D

##### **Frequency Stability Under Temperature Variations:**

In order to measure the carrier frequency under the condition of AFC lock, it is necessary to make measurements with the EUT in a "call mode". This is accomplished with the use of R&S CMW500 DIGITAL RADIO COMMUNICATION TESTER.

1. Measure the carrier frequency at room temperature.
2. Subject the EUT to overnight soak at -30°C.
3. With the EUT, powered via nominal voltage, connected to the CMW500 and in a simulated call on middle channel for LTE band 4, measure the carrier frequency. These measurements should be made within 2 minutes of Powering up the EUT, to prevent significant self-warming.
4. Repeat the above measurements at 10°C increments from -30°C to +50°C. Allow at least 1.5 hours at each temperature, unpowered, before making measurements.
5. Re-measure carrier frequency at room temperature with nominal voltage. Vary supply voltage from minimum voltage to maximum voltage, in 0.1Volt increments re-measuring carrier frequency at each voltage. Pause at nominal voltage for 1.5 hours unpowered, to allow any self-heating to stabilize, before continuing.
6. Subject the EUT to overnight soak at +50°C.
7. With the EUT, powered via nominal voltage, connected to the CMW500 and in a simulated call on the centre channel, measure the carrier frequency. These measurements should be made within 2 minutes of Powering up the EUT, to prevent significant self-warming.
8. Repeat the above measurements at 10 °C increments from +50°C to -30°C. Allow at least 1.5 hours at each temperature, unpowered, before making measurements
9. At all temperature levels hold the temperature to +/- 0.5°C during the measurement procedure.

##### **Frequency Stability Under Voltage Variations:**

Set chamber temperature to 20°C. Use a variable AC power supply / DC power source to power the EUT and set the voltage to rated voltage. Set the spectrum analyzer RBW low enough to obtain the desired frequency resolution and recorded the frequency.

Reduce the input voltage to specify extreme voltage variation ( $\pm 15\%$ ) and endpoint, record the maximum frequency change.



## **TEST RESULTS**

*Remark:*

1. We tested all RB Configuration refer 3GPP TS136 521 for each Channel Bandwidth of LTE FDD Band 4; recorded worst case.

LTE Band 4, 15kHz Sub-carrier Space (worst case of all Sub-carrier Space)

### ***Frequency Error vs Voltage***

Voltage (V)	Frequency error (Hz)		Frequency error (ppm)		Limit (ppm)
	BPSK	QPSK	BPSK	QPSK	
6	1.6	4.8	0.000936	0.002807	2.50
5.1	6.1	7.9	0.003521	0.004560	2.50
6.9	1.3	2.6	0.000741	0.001482	2.50

### ***Frequency Error vs Temperature***

Temperature (°C)	Frequency error (Hz)		Frequency error (ppm)		Limit (ppm)
	BPSK	QPSK	BPSK	QPSK	
-30°	6.0	6.1	0.003509	0.003567	2.50
-20°	8.9	4.8	0.005137	0.002771	2.50
-10°	5.3	4.2	0.003021	0.002394	2.50
0°	8.5	3.6	0.004970	0.002105	2.50
10°	3.5	3.5	0.002020	0.002020	2.50
20°	8.6	9.8	0.004902	0.005586	2.50
30°	3.3	0.1	0.001930	0.000058	2.50
40°	2.2	2.8	0.001270	0.001616	2.50
50°	1.4	2.8	0.000798	0.001596	2.50

#### 4 Test Setup Photos of the EUT

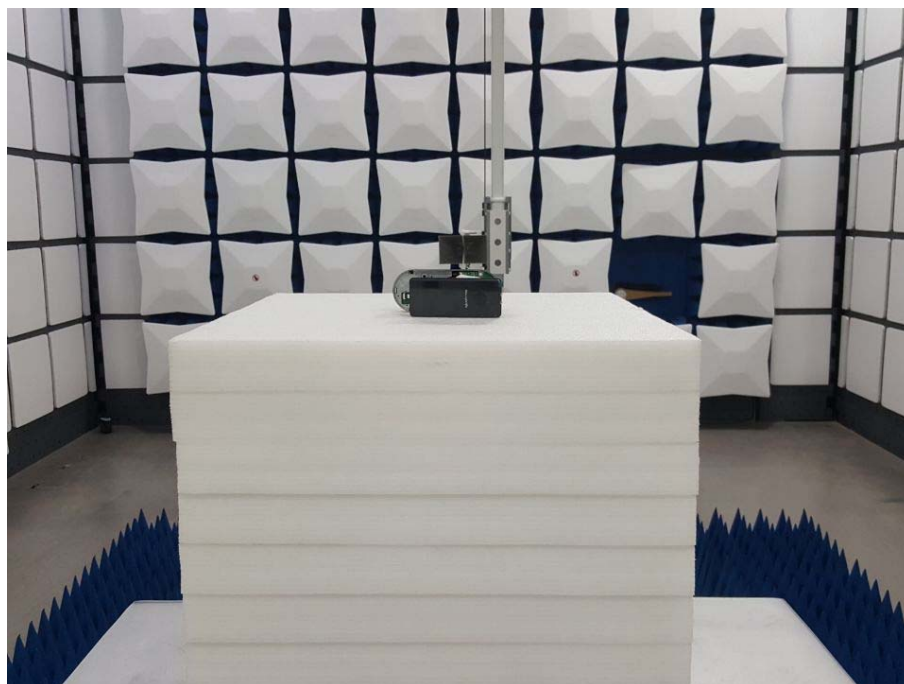
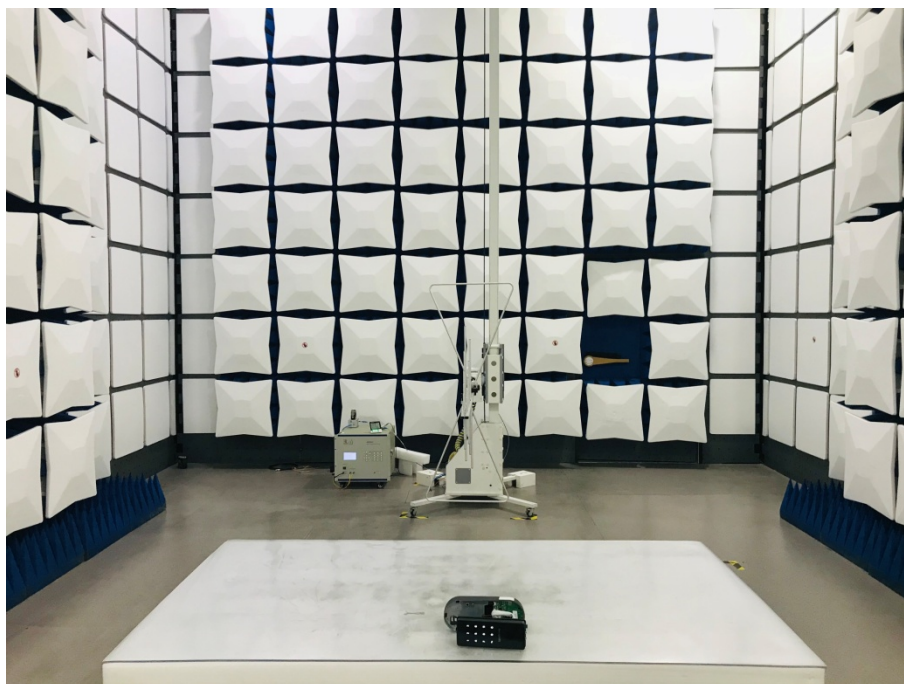

\*\*\*\*\* End of Report \*\*\*\*\*