

Antenna Testing Report

Customer : Shenzhen sangge'er Polytron Technologies Inc

Project Name : MS1-15

Antenna Manufacturer: Sunnyway Technology(CHINA)

**Address: The 6th floor, Building 5, Nantaiyun Innovation Valley Center,
Guangming District, Shenzhen City**

**Report version: 2024/4/17 A0
Research staff: Xu Jun**

Version	Report date	Remark
A0	2024.4.17	Antenna test report
A1		
A2		
A3		
A4		
A5		
A6		
A7		
A8		
A9		

- 1. Record·····
- 2. Project Overview ·····
- 3. Equipment List·····
- 4. Antenna mounting position·····
- 5. Passive parameters ·····
- 6. Passive efficiency and gain ·····
- 7. OTA test data ·····
- 8. Directional pattern ·····
- 9. Summary·····

Prototype status	Debugging machine	<p>Project pictures</p> 
Device type		
Number of antennas	Main antenna; diversity antenna; three-in-one antenna NFC antenna	
Frequency band	GSM :850/900/1800/1900	
	WCDMA: B1/2/5/8	
	FDD: B1/2/3/4/5/7/8/12/14/17//25/26/66 TDD: 38/40/41	
Structural style	LDS+FPC	
Environment adjustment	Change made	
Matching modification	Change made	

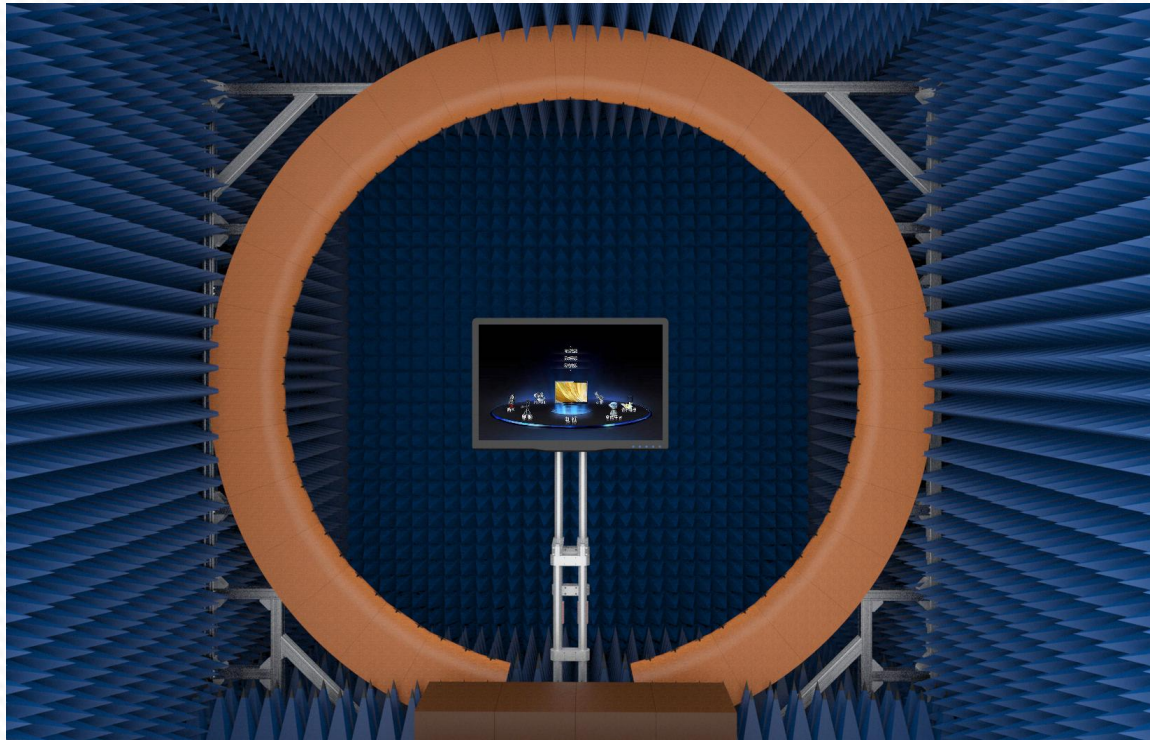

The industry's top 64 sensors OTA chamber

Frequency range: 400MHz-11GHz

Device Llimitation: 2M

Load-bearing limitation:100KG

Equipments Items	Total Quantity	Quantity for Shanghai R&D	Quantity for Shenzhen R&D	Quantity for ChongQing R&D
OTA chamber	10	4	5	1
5G Tester (SP9500-CTS)	3	1	1	1
R&S Tester (high configuration CMW500)	6	3	2	1
Japan Anritsu Tester (Dual Channel 8820)	4	2	2	--
NB-IoT Tester (SP8315)	3	1	1	1
Agilent Tester (8960)	9	4	4	--
Agilent Network Analyzer (E5062A)	7	3	3	1
Agilent Network Analyzer (E5071C 8.5GHZ)	11	5	5	1
Agilent Network Analyzer (E5071B 8.5GHZ)	7	3	3	1
R&S Network Analyzer (ZND)	9	4	4	1
R&S Network Analyzer (ZVB)	3	1	1	1
OTA head hand / ear hand / arm hand	5	2	2	1
GPS/WIFI active test equipment	5	2	2	1

Main antenna :

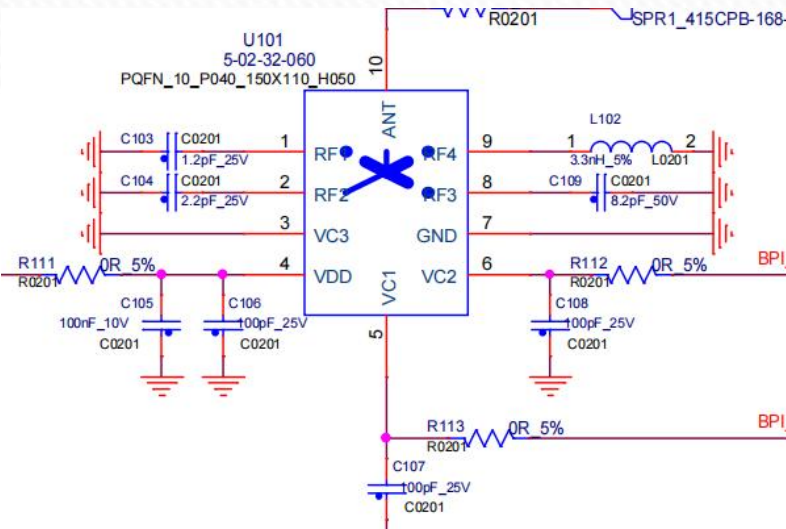
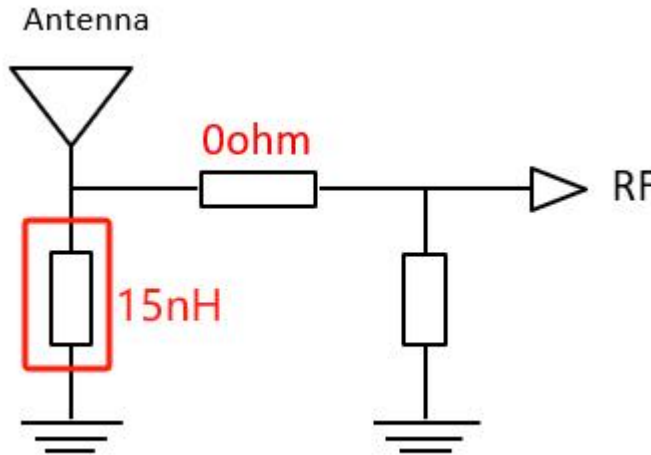

- RF1 C103:0R
- RF2 C104:4.7nH
- RF3 C109:NC
- RF4 L102:22nH

three-in-one antenna :

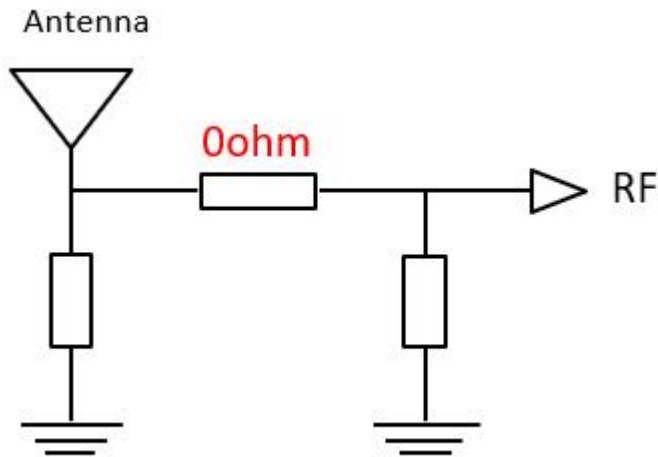

diversity antenna antenna :

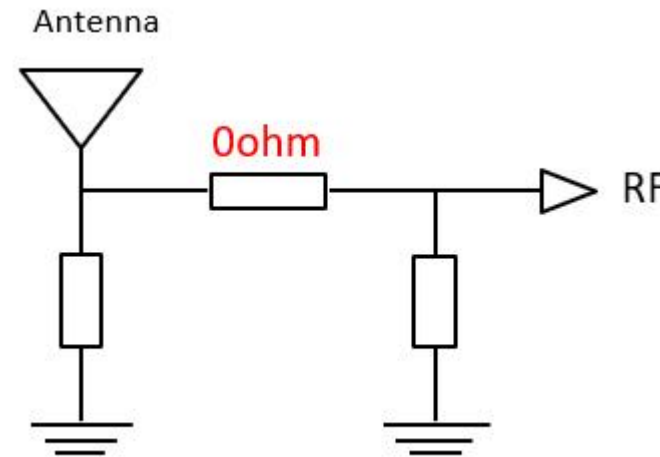

NFC matching circuit

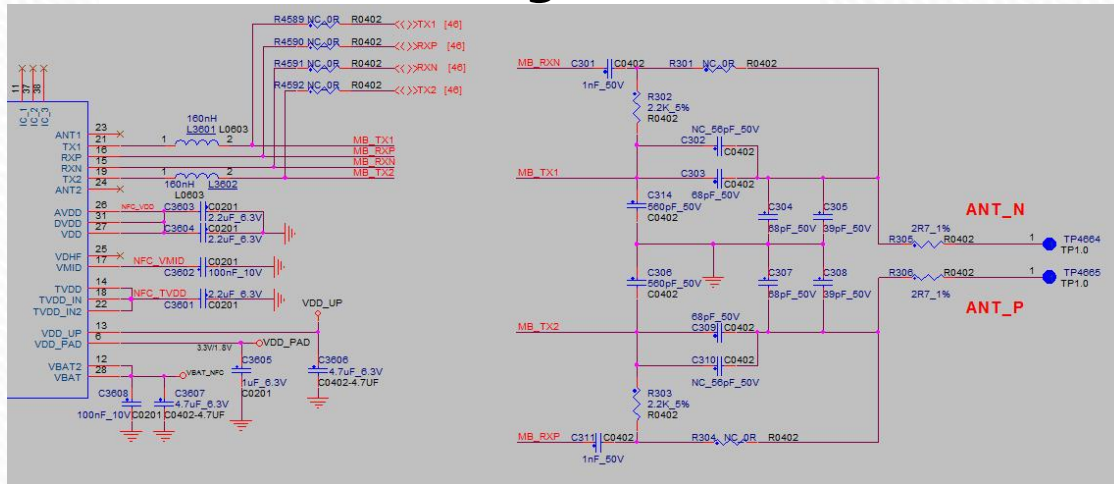

position	specifications and models	
C306/C314	820pF	0402 50V/±5%
C305/C308	47pF	0402 50V/±5%
C302/C310	27pF	0402 50V/±5%

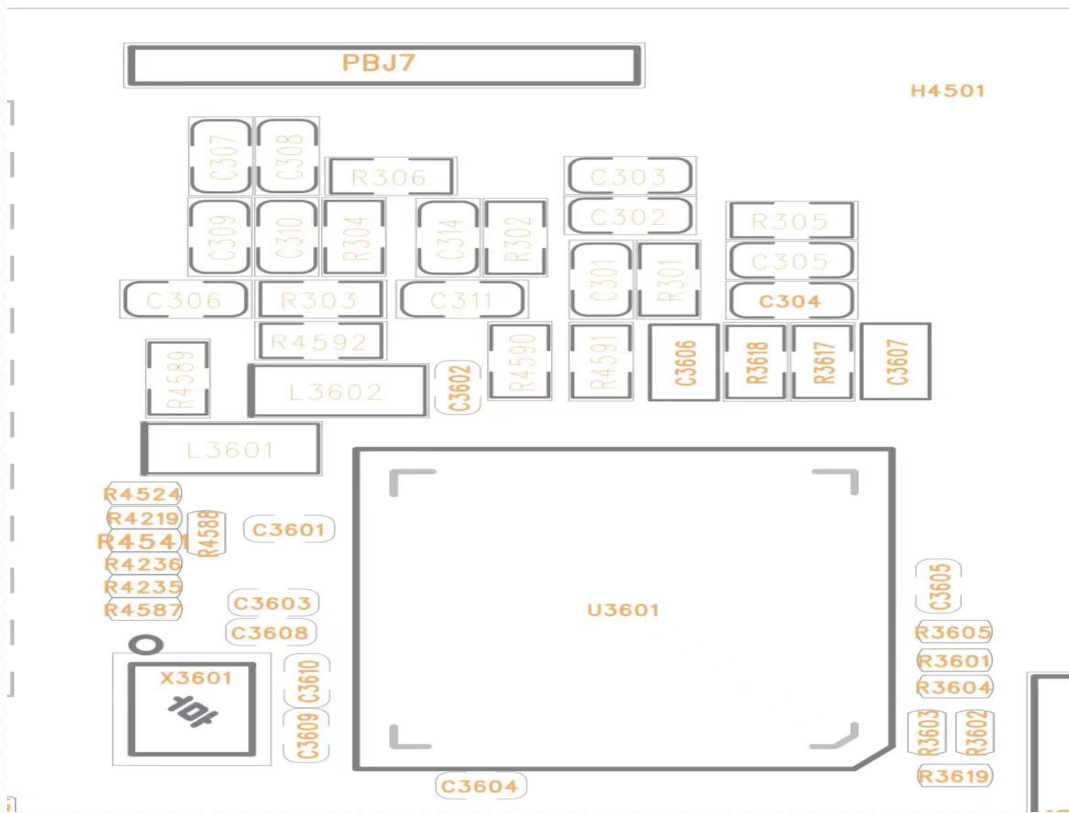

Complete machine antenna data:

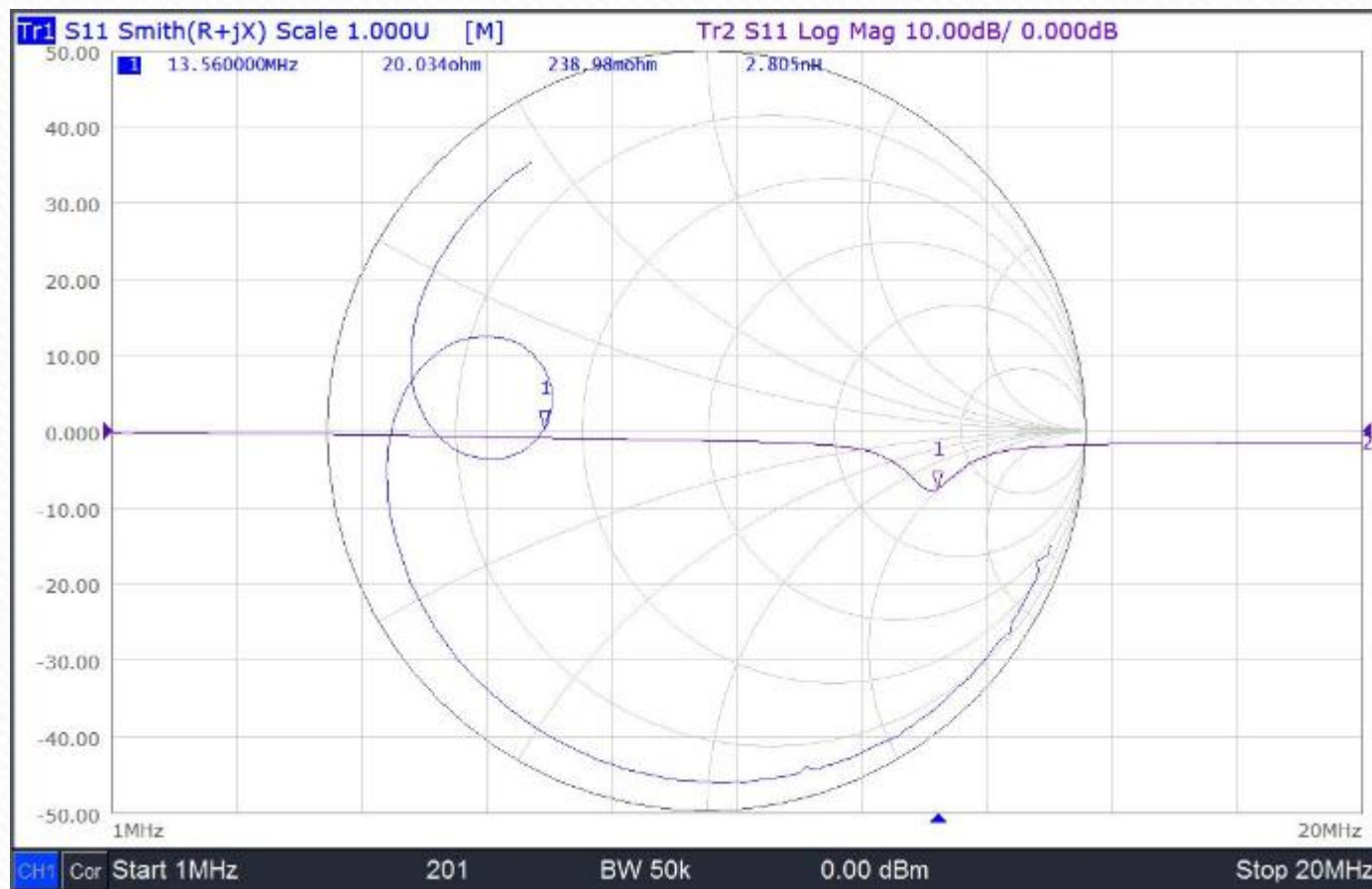

S11-VSWR



Main antenna efficiency and gain

Freq	Effi	Gain	Freq	Effi	Gain	Freq	Effi	Gain
(MHz)	(%)	(dBi)	(MHz)	(%)	(dBi)	(MHz)	(%)	(dBi)
700	5.47	-5.35	1700	22.39	-0.03	2300	23.5	0.88
750	6.29	-6.32	1720	26	0.18	2320	26.24	1.26
800	7.82	-8.56	1740	27.73	0.63	2340	26	1.34
850	10.03	-5.35	1760	28.31	1.11	2360	29.04	2.37
880	12.18	-5.85	1780	29.24	0.96	2380	27.16	2.43
890	13.28	-5.35	1800	27.04	0.46	2400	25.7	2.42
900	13.5	-5.46	1820	25.88	0.44	2420	22.18	1.72
910	11.69	-6.46	1840	25	0.53	2440	22.08	1.37
920	10.1	-7.46	1860	22.08	-0.36	2460	20.18	0.63
930	8.74	-8.24	1880	19.54	-1.22	2480	20.75	0.59
940	8.19	-8.51	1900	18.32	-1.17	2500	19.19	0.39
950	7.55	-9.04	1920	17.66	-1.06	2520	18.2	0.69
960	6.82	-10.16	1940	16.44	-2	2540	15.49	0.35
			1960	15.89	-2.38	2560	13.87	0.06
			1980	14.79	-2.3	2580	10.59	-0.93
			2000	14.13	-2.04	2600	8.55	-1.95
			2020	12.33	-2.41	2620	6.71	-3.29
			2040	11.99	-2.19	2640	5.78	-4.22
			2060	12.22	-1.96	2660	4.46	-5.62
			2080	12.97	-1.9	2680	4.18	-6.08
			2100	11.91	-2.54	2700	3.53	-7.01
			2120	12.94	-2.03			
			2140	13.74	-1.77			
			2160	14.06	-1.53			
			2180	15.14	-1.04			

Bright screen

Band	Channel	TRP	TIS
GSM850	128	24.72	
	190	25.73	
	251	25.3	-94.36
GSM900	1	24.98	
	62	23.68	
	124	23.58	-94.68
DCS1800	512	23.55	
	699	23.53	
	885	23.42	-99.73
PCS1900	512	24.16	
	661	24.7	
	810	26.06	-98.25
WCDMA_B1	9612	16.71	
	9750	16.59	
	9888	16.16	-99.74
WCDMA_B2	9262	16.98	
	9400	18.09	
	9538	18.33	-100.55
WCDMA_B5	4132	15.8	
	4183	15.09	
	4233	15.2	-96.93
WCDMA_B8	2712	15.46	
	2787	14.58	
	2863	14.32	-93.31

Band	Channel	TRP	TIS
FDD_B1(10MHz)	18050	18.77	
	18300	17.77	
	18550	17.49	-90.58
FDD_B2(10MHz)	18650	17.49	
	18900	18.62	
	19150	18.66	-91.61
FDD_B3(10MHz)	19250	14.48	
	19575	15.14	
	19900	14.97	-96.09
FDD_B4(10MHz)	20000	14.55	
	20175	14.02	
	20350	14.37	-93.44
FDD_B5(10MHz)	20450	15.93	
	20525	15.23	
	20600	14.23	-88.18
FDD_B7(10MHz)	20800	17.33	
	21100	17.85	
	21400	18	-90.01
FDD_B8(10MHz)	21500	15.54	
	21625	14.76	
	21750	14.85	-89.65
FDD_B12(10MHz)	23060	15.96	
	23095	15.95	
	23130	15.33	-83.59

Band	Channel	TRP	TIS
FDD_B14(10MHz)	23330	13.61	-84.23
FDD_B17(10MHz)	23780	15.07	
	23790	15.76	
	23800	15.34	-83.57
FDD_B25(10MHz)	26090	17.45	
	26365	18.61	
FDD_B26(10MHz)	26640	19.04	-90.34
	26740	14.56	
	26865	15.03	
FDD_B66(10MHz)	26990	15.17	-90.64
	132022	15.77	
	132322	15.69	
TDD_B38(20MHz)	132622	15.79	-90.58
	37850	18.69	
	38000	18.57	
TDD_B40(20MHz)	38150	18.78	-89.3
	38750	16.72	
	39150	16.87	
TDD_B41(20MHz)	39550	16.56	-91.05
	40340	18.84	
	40620	18.14	
	41140	17.97	-88.64

Screen extinction

Band	Channel	TRP	TIS
GSM850	128	24.65	
	190	25.76	
	251	25.37	-94.7
GSM900	1	24.97	
	62	24.66	
	124	23.53	-95.27
DCS1800	512	23.49	
	699	23.43	
	885	23.36	-100.41
PCS1900	512	23.88	
	661	24.78	
	810	26.18	-98.84
WCDMA_B1	9612	16.86	
	9750	16.01	
	9888	16.23	-99.94
WCDMA_B2	9262	16.96	
	9400	18.08	
	9538	18.43	-100.57
WCDMA_B5	4132	15.87	
	4183	15.17	
	4233	14.77	-97.43
WCDMA_B8	2712	15.53	
	2787	14.66	
	2863	14.57	-93.68

Band	Channel	TRP	TIS
FDD_B1(10MHz)	18050	18.9	
	18300	17.9	
	18550	17.55	-90.83
FDD_B2(10MHz)	18650	17.44	
	18900	18.64	
	19150	18.71	-90.94
FDD_B3(10MHz)	19250	14.56	
	19575	15.16	
	19900	15.05	-97.12
FDD_B4(10MHz)	20000	14.63	
	20175	14.55	
	20350	14.41	-93.85
FDD_B5(10MHz)	20450	16.02	
	20525	15.31	
	20600	14.28	-88.82
FDD_B7(10MHz)	20800	17.36	
	21100	17.9	
	21400	19.08	-91.12
FDD_B8(10MHz)	21500	15.63	
	21625	14.83	
	21750	14.53	-90.07
FDD_B12(10MHz)	23060	16.02	
	23095	16.02	
	23130	15.38	-85.52

Band	Channel	TRP	TIS
FDD_B14(10MHz)	23330	13.63	-86.25
FDD_B17(10MHz)	23780	15.15	
	23790	15.8	
	23800	15.38	-84.44
FDD_B25(10MHz)	26090	17.4	
	26365	18.64	
	26640	19.15	-90.38
FDD_B26(10MHz)	26740	15.57	
	26865	15.96	
	26990	14.76	-90.77
FDD_B66(10MHz)	132022	15.83	
	132322	15.72	
	132622	15.81	-91.25
TDD_B38(20MHz)	37850	19.77	
	38000	19.73	
	38150	18.94	-89.79
TDD_B40(20MHz)	38750	16.72	
	39150	16.98	
	39550	16.47	-92.15
TDD_B41(20MHz)	40340	18.92	
	40620	18.29	
	41140	18.04	-88.76

Main antenna Directional pattern

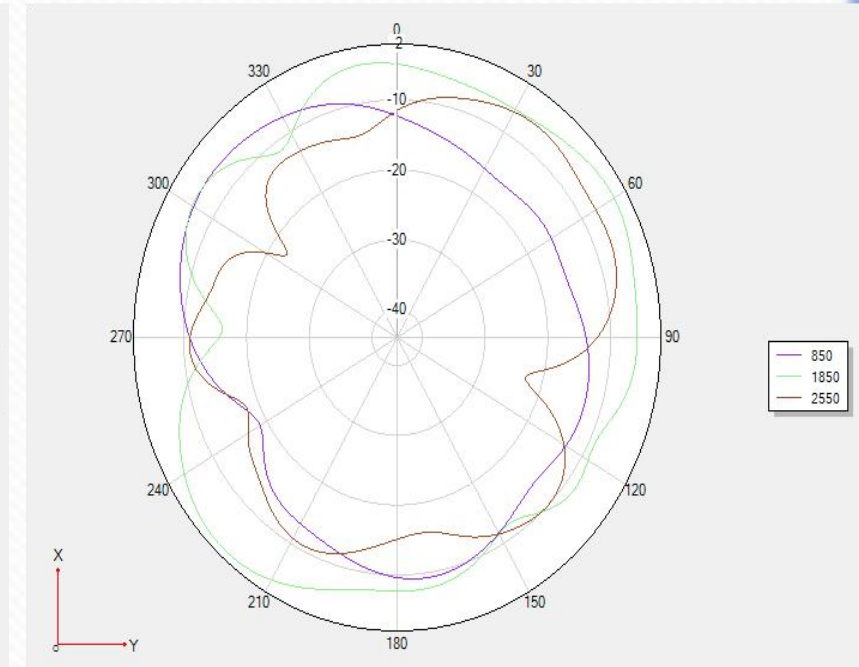
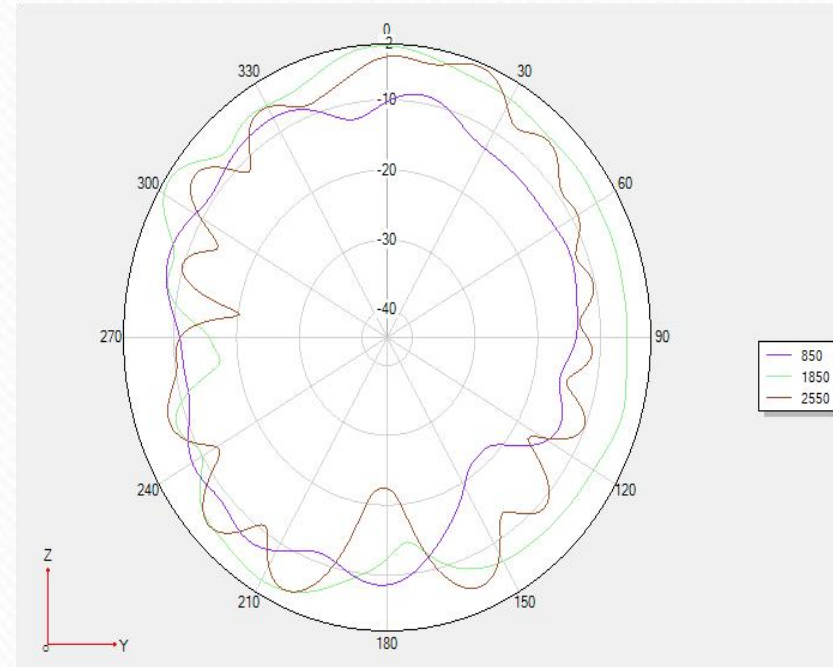
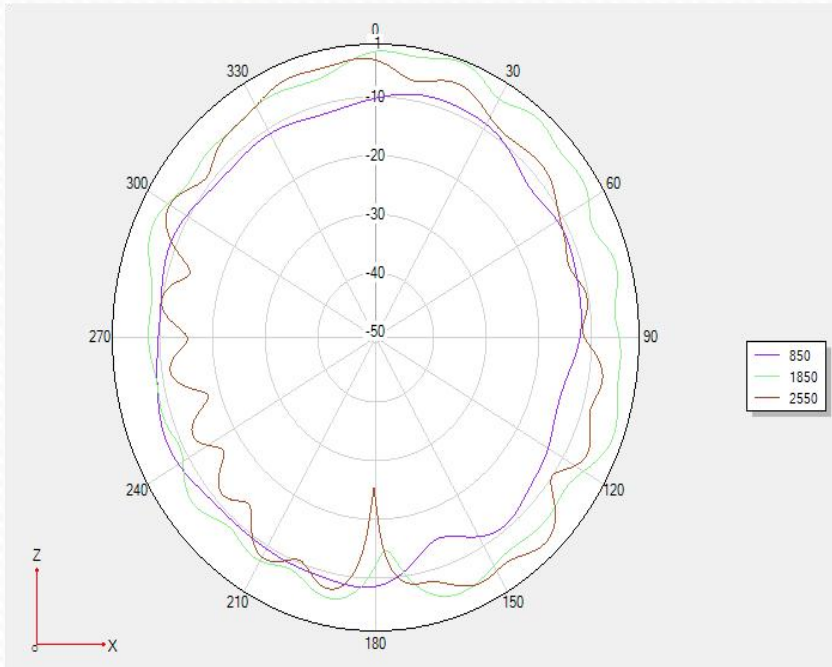

Main antenna Directional pattern

850MHz

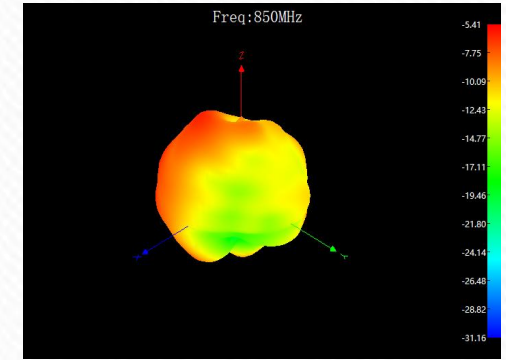
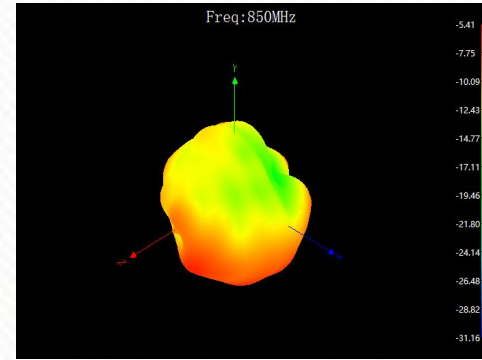
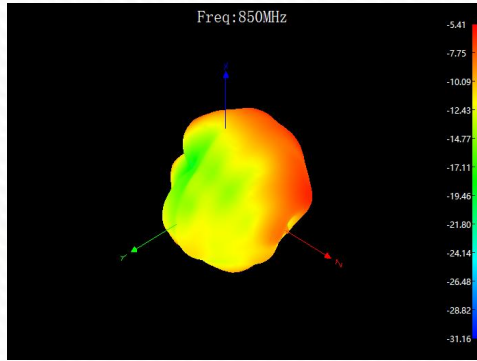

1850MHz

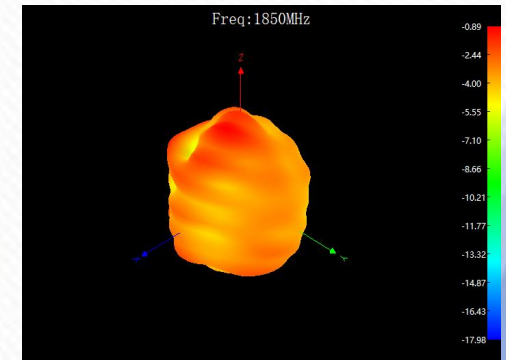
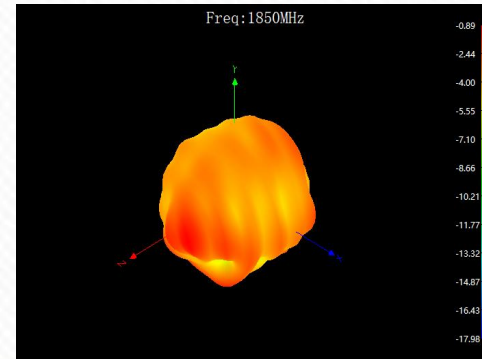
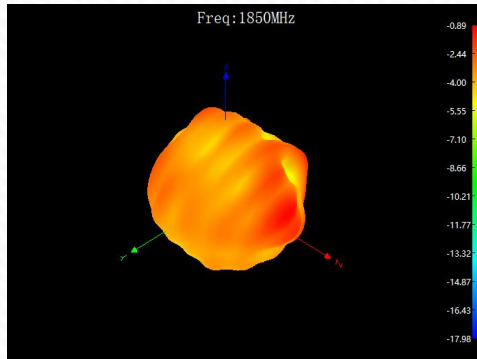

2550MHz

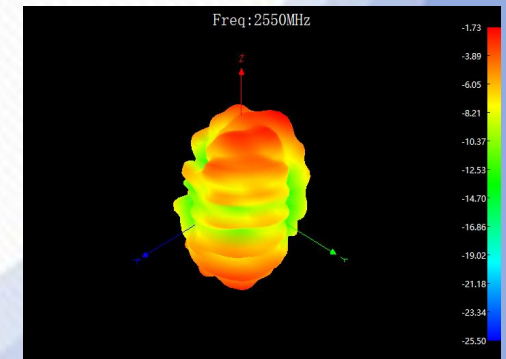
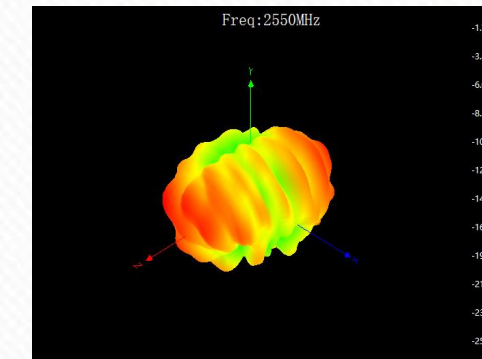
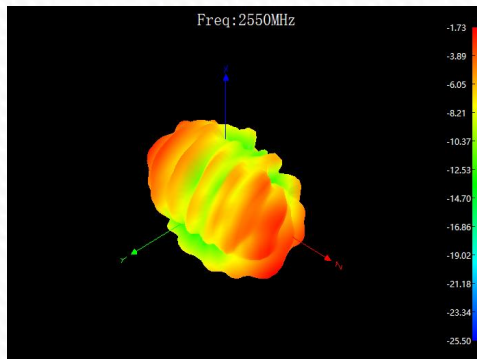

S11-VSWR

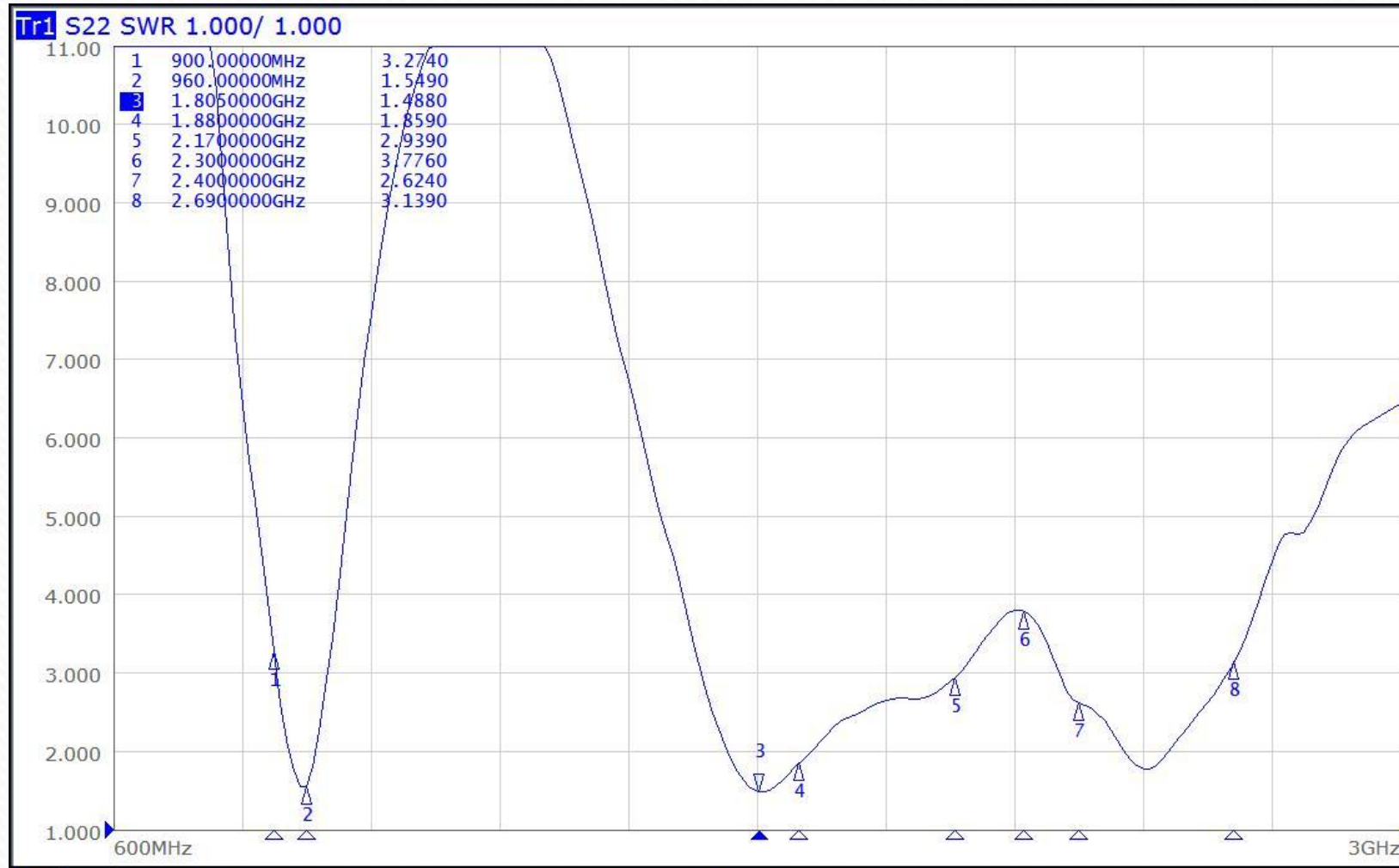

Diversity antenna efficiency and gain

Frequenc y/Mhz	MaxGa in/dBi	Efficienc y / %
800	-14.64	0.88
810	-13.98	1
820	-13.65	1.1
830	-12.58	1.37
840	-11.61	1.71
850	-10.41	2.15
860	-9.37	2.66
870	-8.24	3.33
880	-7.4	4.19
890	-6.6	5.04
900	-5.71	6.85
910	-4.78	8.67
920	-4.2	10.23
930	-4.17	9.73
940	-3.88	9.98
950	-4.19	9.08
960	-4.86	7.87
1710	-6.38	5.46
1720	-5.53	6.81
1730	-5.14	7.55
1740	-4.52	8.75
1750	-3.82	10.09
1760	-2.84	12.13
1770	-2.23	13.68
1780	-1.74	14.96
1790	-1.53	15.28
1800	-0.98	16.41
1810	-0.22	18.45

Frequenc y/Mhz	MaxGa in/dBi	Efficienc y / %
1820	0.19	19.1
1830	0.21	19.28
1840	0.23	20.14
1850	0.29	21.43
1860	0.19	21.09
1870	0.19	21.23
1880	0.39	21.63
1890	0.63	22.8
1900	0.28	22.03
1910	-0.32	21.83
1920	-0.88	21.83
1930	-0.92	21.68
1940	-0.77	21.73
1950	-0.54	22.28
1960	-0.4	22.23
1970	-0.43	22.13
1980	-0.38	22.44
1990	-0.65	21.13
2000	-0.28	22.18
2010	-0.23	22.34
2020	-0.27	22.03
2030	-0.36	21.98
2040	-0.12	23.07
2050	-0.15	23.07
2060	-0.3	21.88
2070	-0.45	22.34
2080	-0.17	22.96
2090	-0.06	23.17

Frequenc y/Mhz	MaxGa in/dBi	Efficienc y / %
2100	0.11	22.18
2110	0.31	22.13
2120	0.76	22.59
2130	0.56	23.55
2140	0.12	22.86
2150	-0.08	23.28
2160	0.18	24.1
2170	0.26	24.43
2310	2.23	31.26
2320	2.26	32.28
2330	2.02	31.7
2340	1.66	29.99
2350	1.77	30.83
2360	1.89	31.55
2370	1.98	31.41
2380	1.75	29.31
2390	1.89	29.85
2400	1.79	29.17
2410	1.51	28.18
2420	1.05	26.06
2430	0.91	26.12
2440	0.6	25.18
2450	0.46	25.18
2460	0	23.12
2470	-0.04	23.33
2480	-0.31	23.23
2490	-0.56	22.59
2500	-1.01	21.63

Frequenc y/Mhz	MaxGa in/dBi	Efficienc y / %
2510	-0.95	22.44
2520	-1.34	21.68
2530	-1.62	20.37
2540	-1.71	20.75
2550	-1.26	21.43
2560	-1.16	21.73
2570	-1.24	21.43
2580	-1.2	22.7
2590	-1.42	23.17
2600	-1.48	24.21
2610	-1.82	23.55
2620	-1.9	23.71
2630	-1.52	25.76
2640	-1.51	26.55
2650	-1.64	25.7
2660	-1.57	25.82
2670	-1.42	26.98
2680	-1.23	26.67
2690	-1.55	25.64

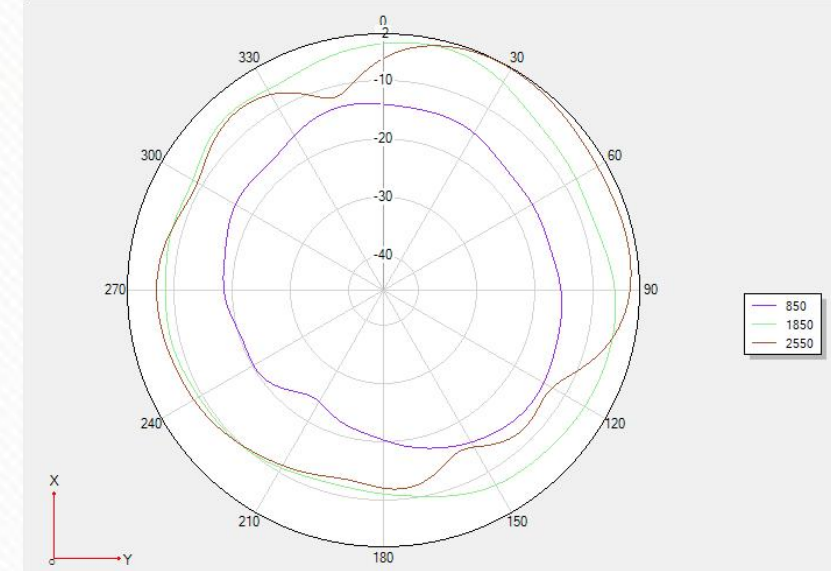
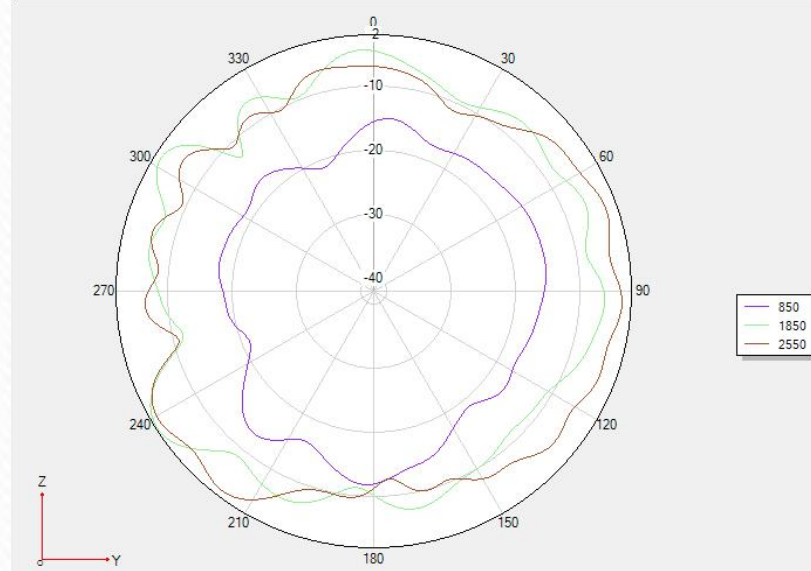
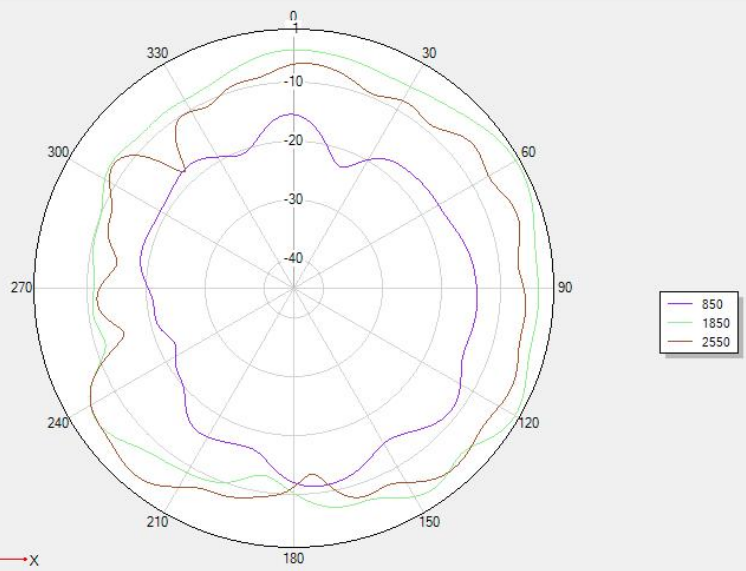

Directional pattern Directional pattern

850Mhz

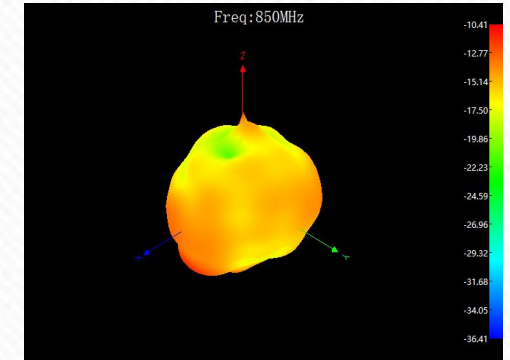
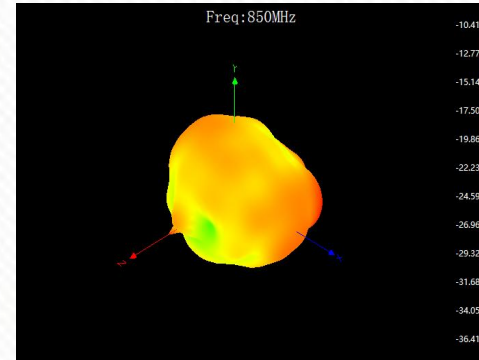
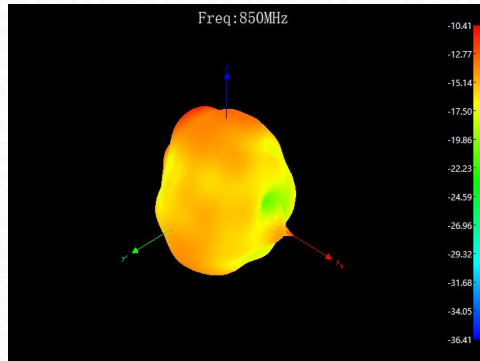

1850MHz

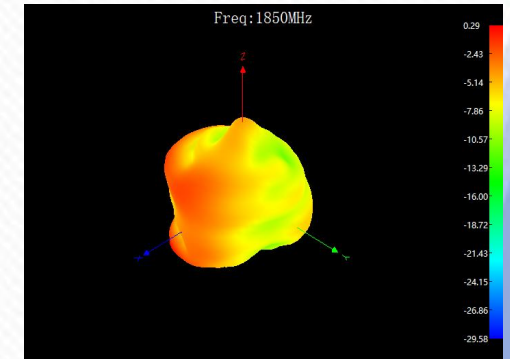
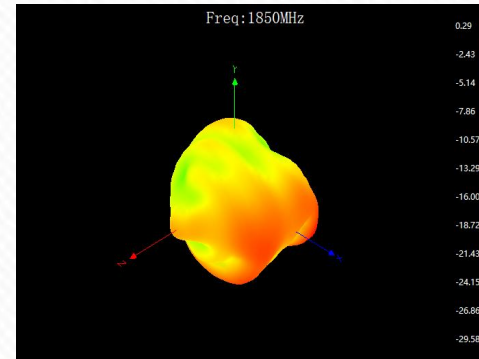
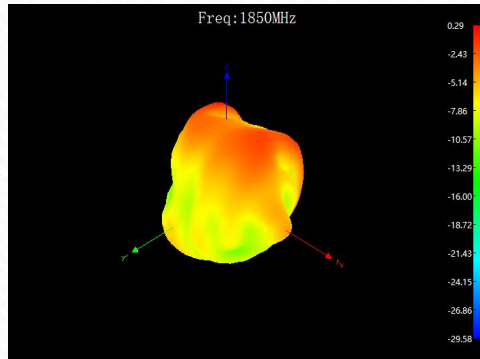

2550MHz

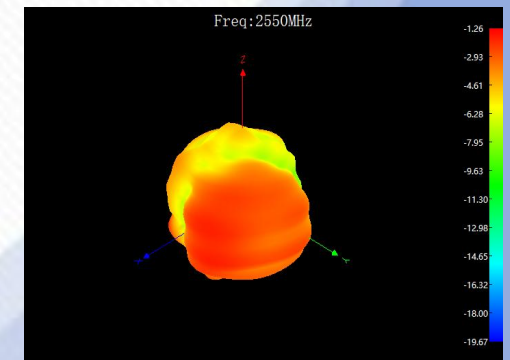
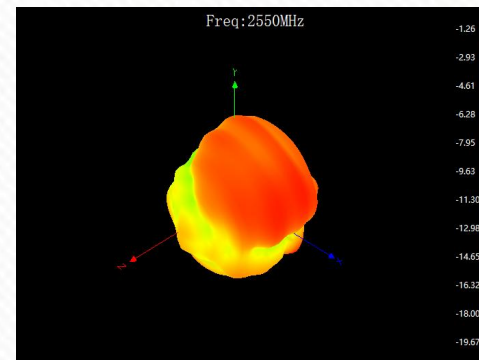
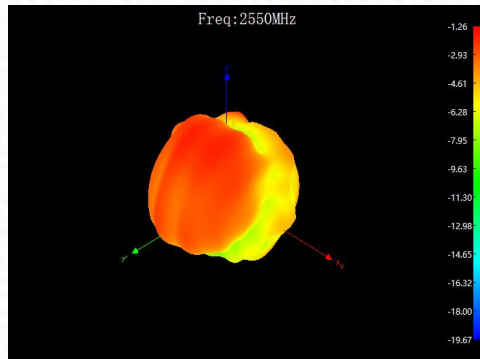

S11-VSWR

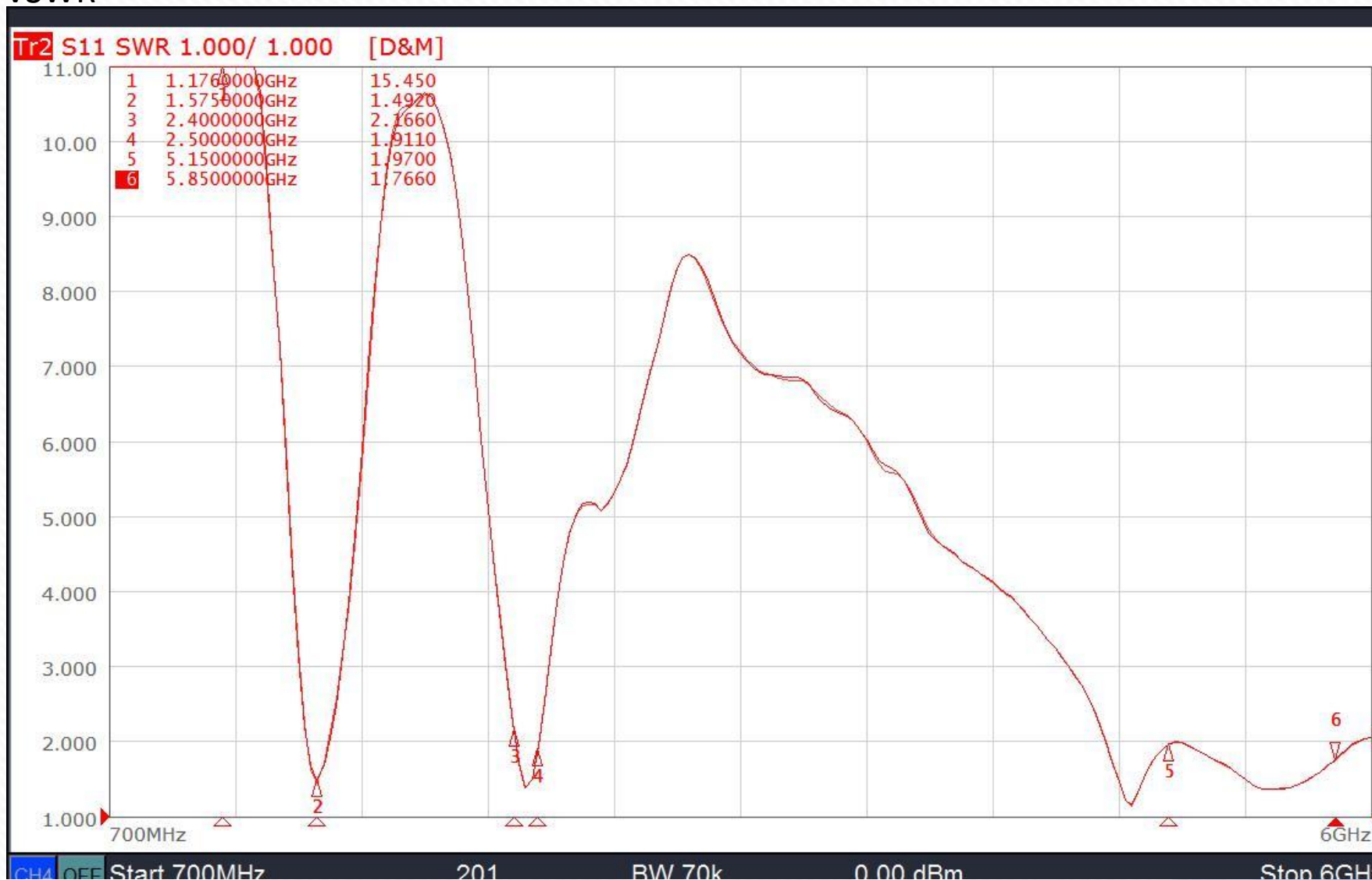

Freq (MHz)	Effi (%)	Gain (dBi)	Freq (MHz)	Effi (%)	Gain (dBi)	Freq (MHz)	Effi (%)	Gain (dBi)
1565	36.98	1.55	2400	30.71	1.6	5150	31.18	1.02
1570	36.59	1.57	2410	33.61	-0.19	5200	30.84	0.09
1575	37.07	1.69	2420	35.31	0.64	5250	31.63	0.17
1580	36.02	1.76	2430	36.62	0.57	5300	32.8	0.23
1585	34.9	1.75	2440	36.99	1.24	5350	31.04	0.18
1590	32.93	1.68	2450	38.31	1.4	5400	32.39	0.14
			2460	37.4	1.9	5450	33.77	1.44
			2470	37.73	1.5	5500	31.05	2.01
			2480	37.89	1.78	5550	35.09	1.75
			2490	36.36	1.45	5600	35.27	1.98
			2500	34.06	1.55	5650	36.78	2.04
						5700	37.27	2.65
						5750	35.36	2.75
						5800	32.58	2.87
						5850	33.19	2.66

WIFI antenna OTA data

Bright screen			
Measurement	Band	Channel	Total
TRP	WIFI_B (1M)	1	11.84
TRP	WIFI_B (1M)	6	12.15
TRP	WIFI_B (1M)	11	12.95
TIS(EIRP)	WIFI_B (11M)	11	-82.46
TRP	WIFI_G (6M)	1	10.43
TRP	WIFI_G (6M)	6	11.29
TRP	WIFI_G (6M)	11	11.4
TIS(EIRP)	WIFI_G (54M)	11	-69.61
TRP	WIFI_N_ISM (6.5M)	1	9.38
TRP	WIFI_N_ISM (6.5M)	6	10.29
TRP	WIFI_N_ISM (6.5M)	11	10.33
TIS(EIRP)	WIFI_N_ISM (65M)	11	-67.23
TRP	WIFI_A (6M)	36	8.93
TRP	WIFI_A (6M)	149	8.81
TRP	WIFI_A (6M)	165	9.52
TIS(EIRP)	WIFI_A (54M)	165	-68.05

Screen extinction			
Measurement	Band	Channel	Total
TRP	WIFI_B (1M)	1	11.85
TRP	WIFI_B (1M)	6	12.13
TRP	WIFI_B (1M)	11	12.32
TIS(EIRP)	WIFI_B (11M)	11	-82.91
TRP	WIFI_G (6M)	1	10.39
TRP	WIFI_G (6M)	6	11.23
TRP	WIFI_G (6M)	11	11.39
TIS(EIRP)	WIFI_G (54M)	11	-69.46
TRP	WIFI_N_ISM (6.5M)	1	9.33
TRP	WIFI_N_ISM (6.5M)	6	10.24
TRP	WIFI_N_ISM (6.5M)	11	10.31
TIS(EIRP)	WIFI_N_ISM (65M)	11	-66.42
TRP	WIFI_A (6M)	36	8.86
TRP	WIFI_A (6M)	149	8.75
TRP	WIFI_A (6M)	165	9.46
TIS(EIRP)	WIFI_A (54M)	165	-68.36



A smartphone screen displaying a table of GPS data. The table has columns for 'Elevation' and 'Azimuth'. The data is presented in a list format with small icons and numerical values.

PRN	PD	PD	CNR	Elevation	Azimuth
2	L1	30.1	64.00	148.00	
3	L1	26.1	2.00	167.00	
4	L1	37.9	12.00	188.00	
7	L1	34.4	59.00	313.00	
8	L1	41.5	45.00	23.00	
9	L1	30.7	23.00	228.00	
14	L1	42.8	11.00	301.00	
16	L1	32.4	14.00	85.00	
17	L1	23.1	14.00	243.00	
21	L1	28.3	6.00	103.00	
27	L1	36.0	14.00	44.00	
30	L1	44.0	27.00	318.00	
71	L1	18.5	3.00	270.00	
78	L1	30.7	38.00	347.00	
79	L1	32.4	3.00	322.00	
79	L1	28.5	12.00	117.00	
80	L1	43.6	50.00	72.00	
82	L1	43.7	28.00	77.00	
83	L1	0.0	74.00	75.00	

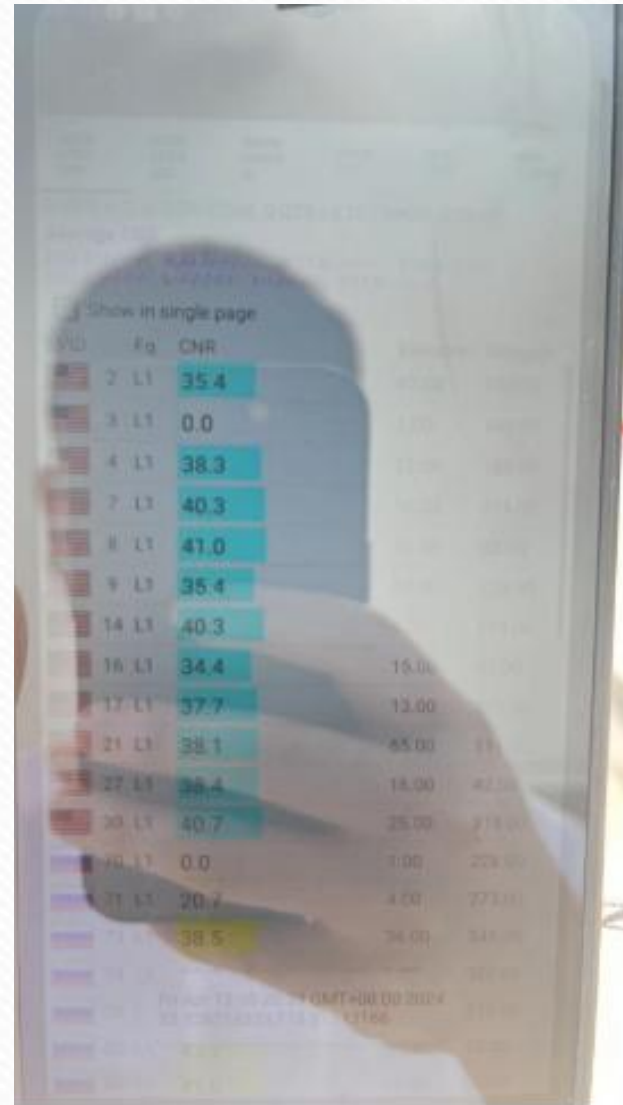

A smartphone screen displaying a table of GPS data, similar to the first image. The table has columns for 'Elevation' and 'Azimuth'. The data is presented in a list format with small icons and numerical values.

PRN	PD	PD	CNR	Elevation	Azimuth
2	L1	35.4	15.00	180.00	
3	L1	0.0	1.00	167.00	
4	L1	38.3	12.00	188.00	
7	L1	40.3	16.00	313.00	
8	L1	41.0	50.00	23.00	
9	L1	35.4	19.00	228.00	
14	L1	40.3	19.00	301.00	
16	L1	34.4	15.00	85.00	
17	L1	37.7	13.00	243.00	
21	L1	38.1	45.00	103.00	
27	L1	38.4	18.00	44.00	
30	L1	40.7	25.00	318.00	
70	L1	0.0	1.00	228.00	
71	L1	20.7	4.00	273.00	
71	L1	38.5	34.00	348.00	
74	L1	0.0	0.00	0.00	
78	L1	0.0	0.00	0.00	
80	L1	0.0	0.00	0.00	
82	L1	0.0	0.00	0.00	
83	L1	0.0	0.00	0.00	

Three-in-one antenna directional pattern

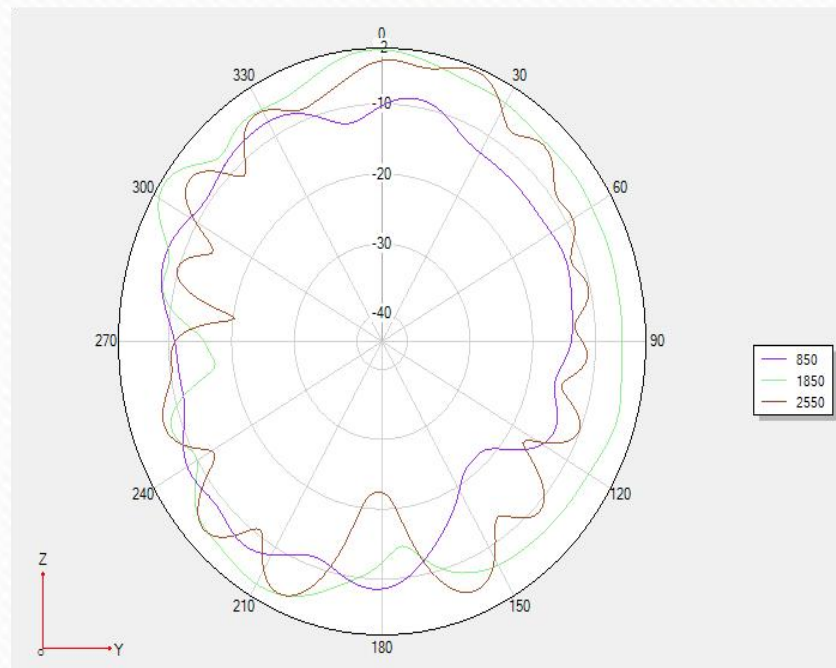
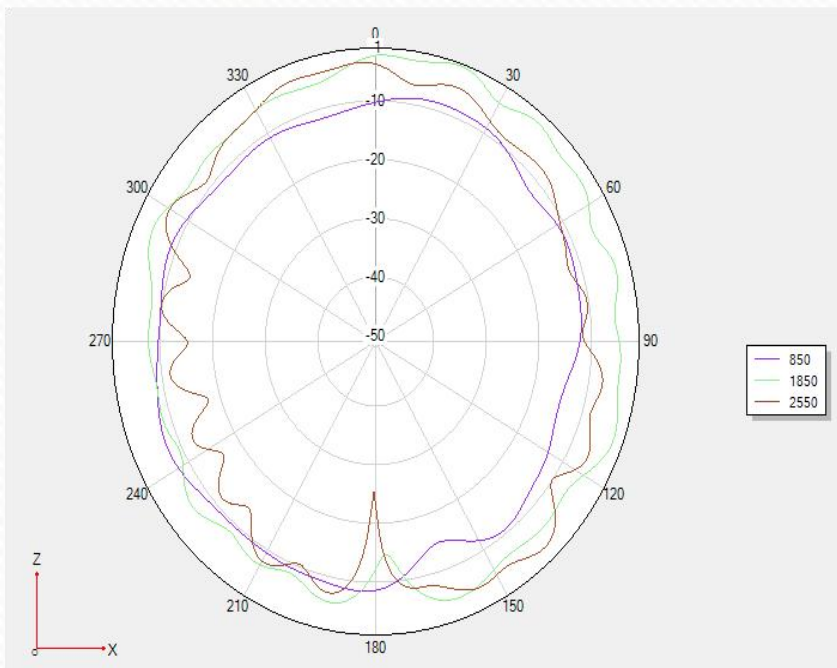

Three-in-one antenna directional pattern

1575Mhz

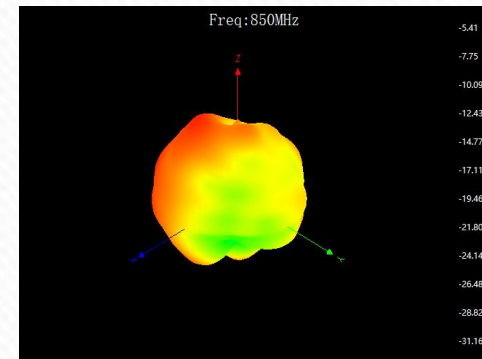
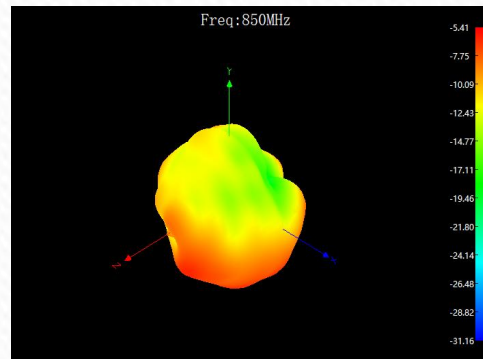
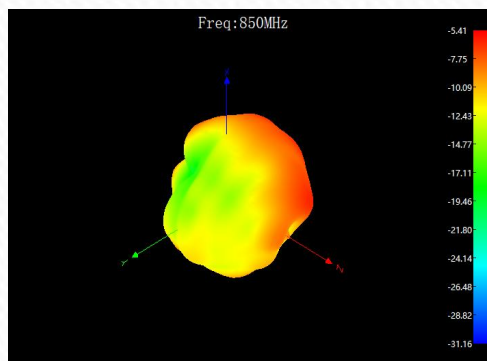

2450MHz

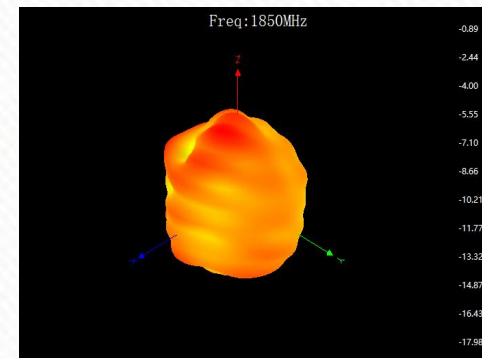
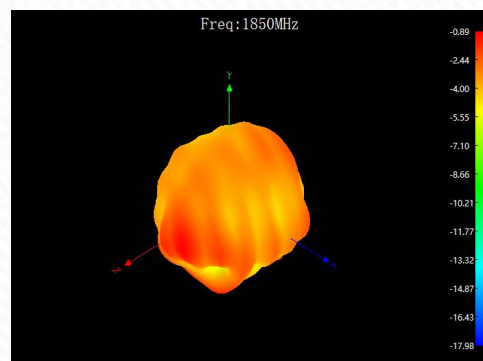
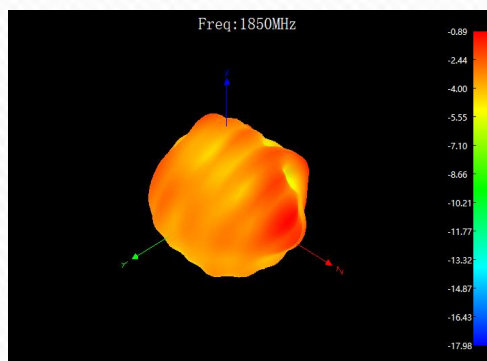

5550MHz

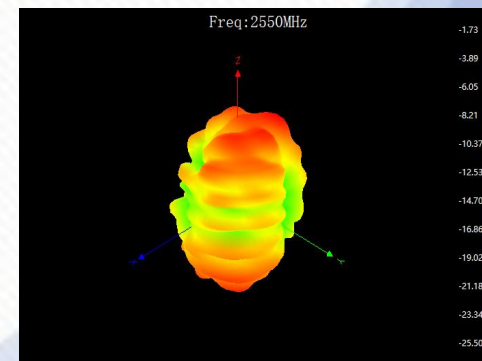
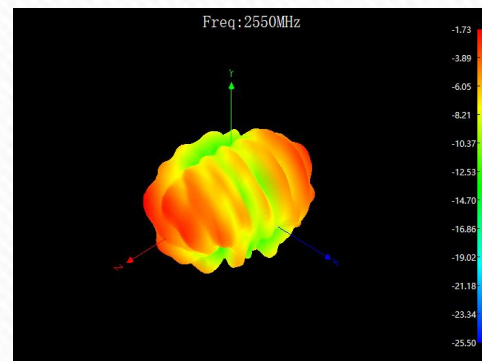
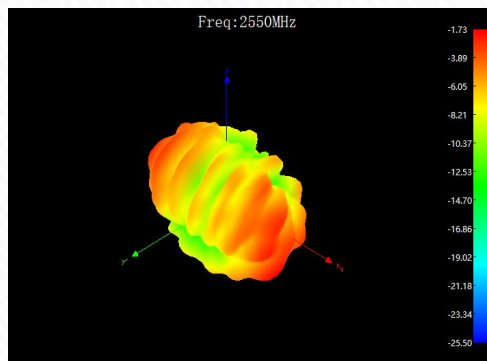

4G main ANT

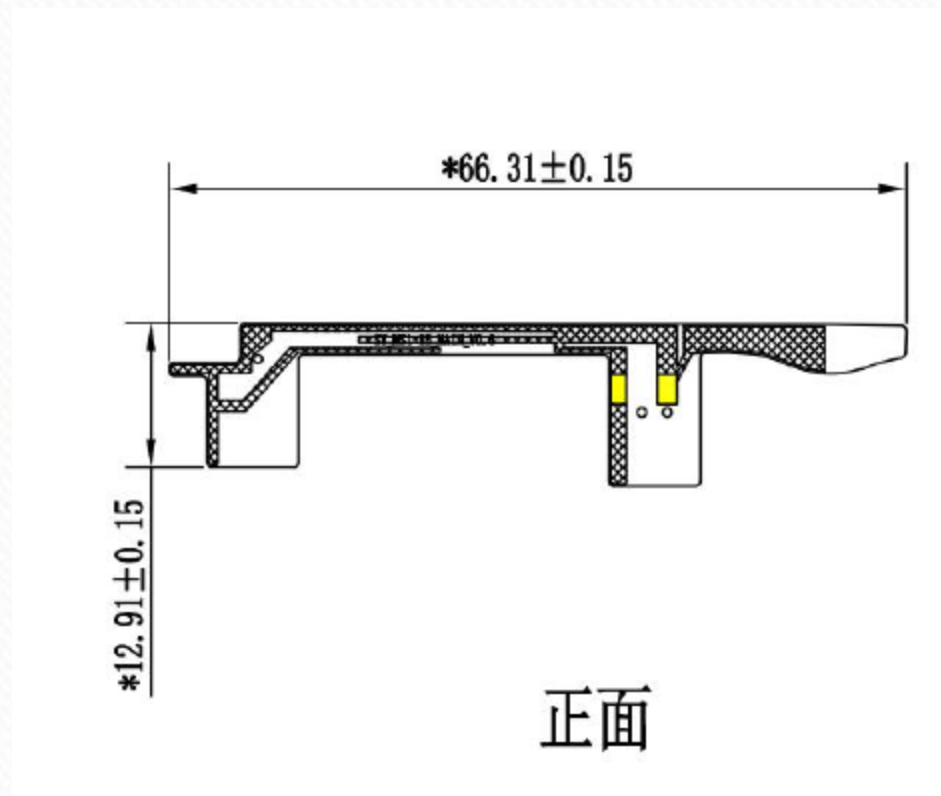

NFC ANT

We statement that All measurements were performed radiated and therefore additional antenna gain documentation is not required.

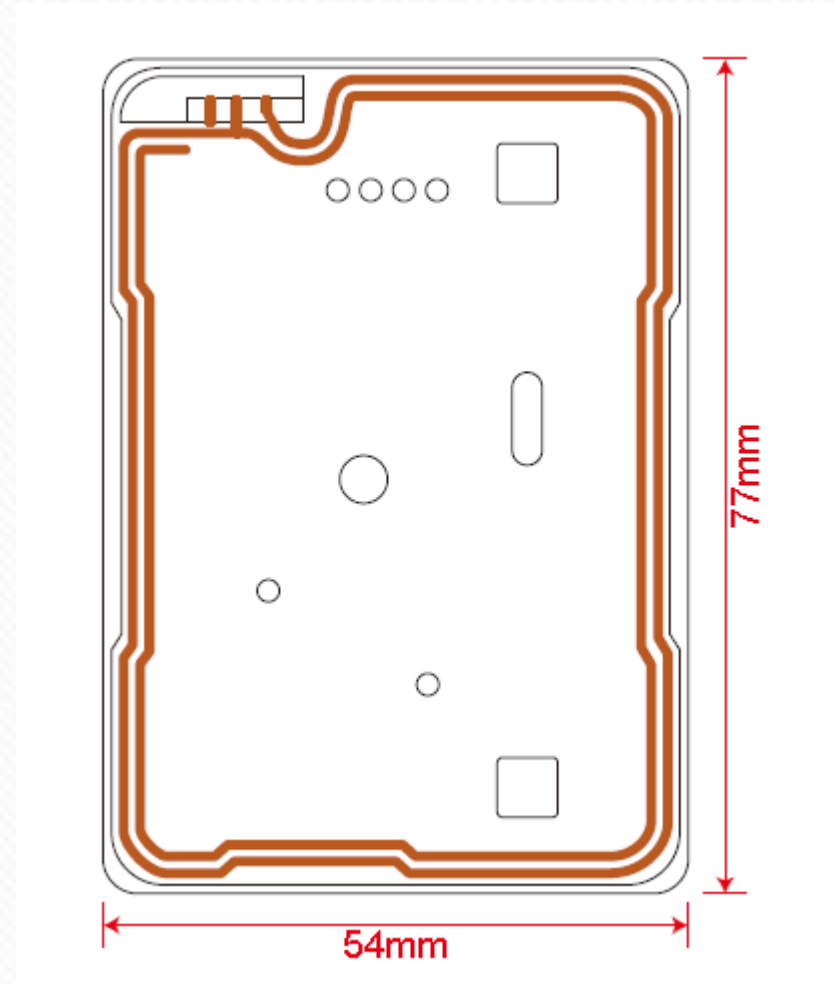
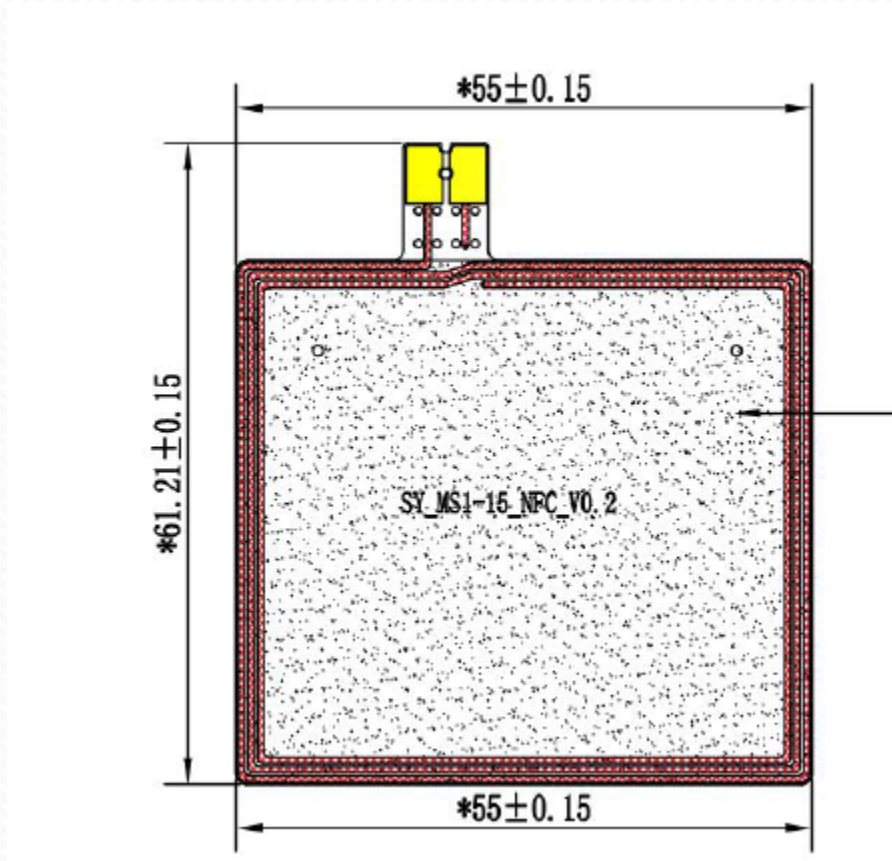

BT&WLAN&GPS ANT

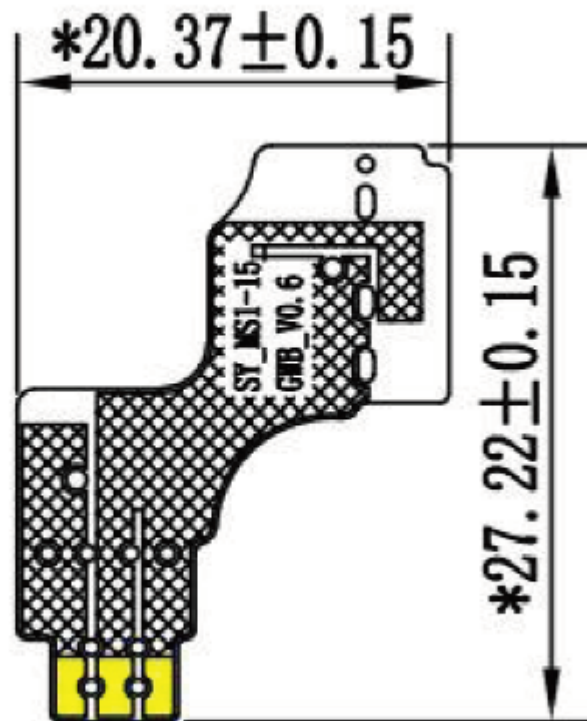

4G DIV ANT

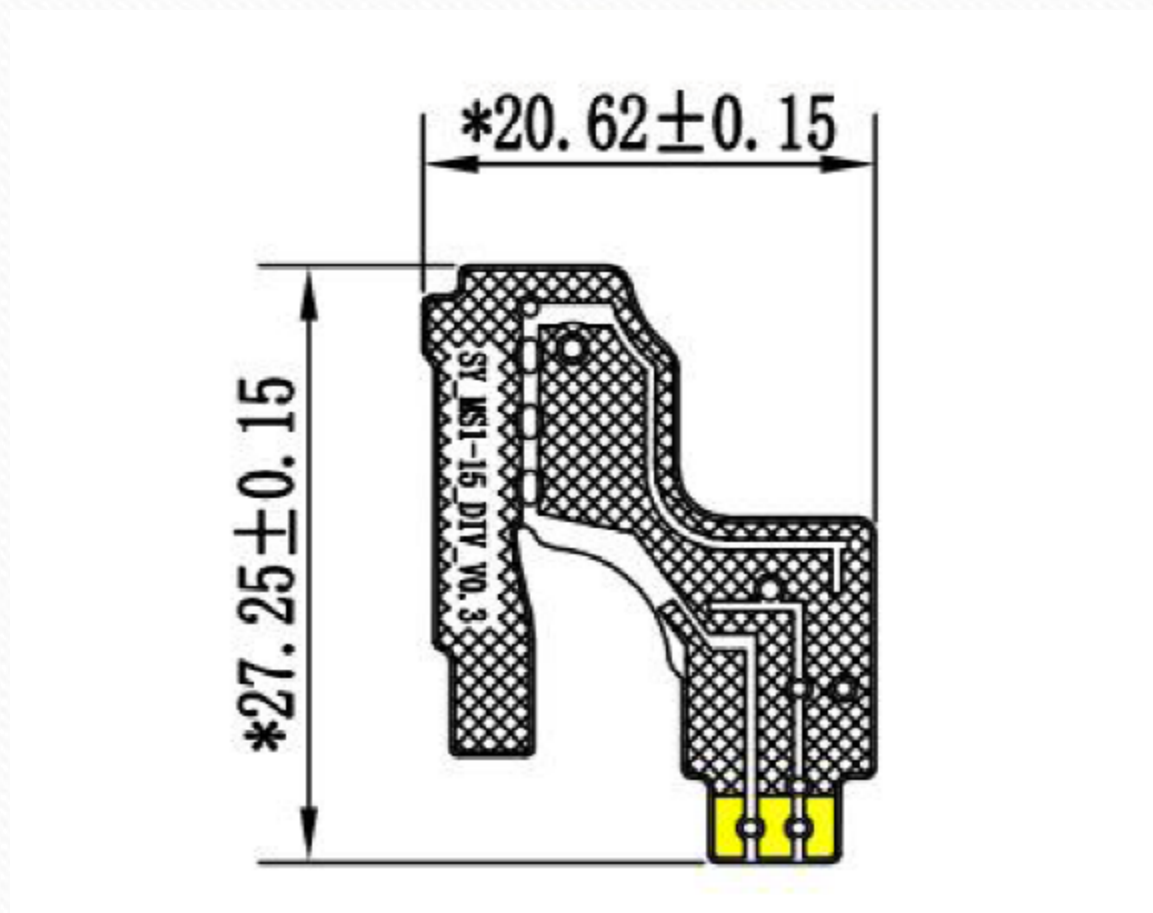

Thank You

Shanghai R&D Center: 1F, Building 4, No.99, Lane 215, Gaoguang Road, Qingpu District, Shanghai, 201799, PRC

Shenzhen R&D Center: The 6th floor, Building 5, Nantaiyun Innovation Valley Center, Guangming District, Shenzhen City

ChongQing R&D Center: 1F, ARM Ecological Industrial Park, 19 East Datugu Road, Xiantao, Yubei District, Chongqing, 401120, PRC

Huizhou Factory: 4-5F, No.1, Central Village Road, Longhu Industrial Zone, Shuikou Town, Huicheng District, Huizhou, 516255, PRC

TEL: 021-60835368 E-mail: sales@sunnyway-iot.com

www.sunnyway-iot.com

