



# CTC Laboratories, Inc.

1-2/F., Building 2, Jiaquan Building, Guanlan High-Tech Park, Shenzhen, Guangdong, China  
Tel: +86-755- 27521059 Fax: +86-755- 27521011 Http://www.sz-ctc.org.cn

## TEST REPORT

**Report No.** .....: **CTC20201784E02**

**FCC ID**.....: **2AYD5-M2-203**

**Applicant**.....: **Imin Technology Pte Ltd**

Address.....: 63 Ubi Ave 1 #07-02 63@Ubi Singapore 408937

Manufacturer.....: Imin Technology Pte Ltd

Address.....: 63 Ubi Ave 1 #07-02 63@Ubi Singapore 408937

**Product Name**.....: **Mobile POS**

Trade Mark.....: N/A

Model/Type reference.....: M2-203

Listed Model(s) .....: N/A



**Standard**.....: **FCC CFR Title 47 Part 15 Subpart C Section 15.247**

Date of receipt of test sample...: Dec. 02, 2020

Date of testing.....: Dec. 03, 2020 ~ Jan. 04, 2021

Date of issue.....: Jan. 05, 2021

**Result**.....: **PASS**

Compiled by:		
(Printed name+signature)	Terry Su	
Supervised by:		
(Printed name+signature)	Miller Ma	
Approved by:		
(Printed name+signature)	Walter Chen	

**Testing Laboratory Name**.....: **CTC Laboratories, Inc.**

Address.....: 1-2/F., Building 2, Jiaquan Building, Guanlan High-Tech Park, Shenzhen, Guangdong, China

This test report may be duplicated completely for legal use with the approval of the applicant. It should not be reproduced except in full, without the written approval of our laboratory. The client should not use it to claim product endorsement by CTC. The test results in the report only apply to the tested sample. The test report shall be invalid without all the signatures of testing engineers, reviewer and approver. Any objections must be raised to CTC within 15 days since the date when the report is received. It will not be taken into consideration beyond this limit. The test report merely correspond to the test sample.



## Table of Contents

Page

<b>1. TEST SUMMARY.....</b>	<b>3</b>
1.1. TEST STANDARDS.....	3
1.2. REPORT VERSION.....	3
1.3. TEST DESCRIPTION.....	4
1.4. TEST FACILITY.....	5
1.5. MEASUREMENT UNCERTAINTY.....	5
1.6. ENVIRONMENTAL CONDITIONS.....	6
<b>2. GENERAL INFORMATION.....</b>	<b>7</b>
2.1. CLIENT INFORMATION.....	7
2.2. GENERAL DESCRIPTION OF EUT.....	8
2.3. ACCESSORY EQUIPMENT INFORMATION.....	9
2.4. OPERATION STATE.....	10
2.5. MEASUREMENT INSTRUMENTS LIST.....	11
<b>3. TEST ITEM AND RESULTS.....</b>	<b>13</b>
3.1. CONDUCTED EMISSION.....	13
3.2. RADIATED EMISSION.....	16
3.3. BAND EDGE EMISSIONS (RADIATED).....	38
3.4. BAND EDGE AND SPURIOUS EMISSIONS (CONDUCTED).....	51
3.5. 20DB BANDWIDTH.....	66
3.6. CHANNEL SEPARATION.....	70
3.7. NUMBER OF HOPPING CHANNEL.....	75
3.8. DWELL TIME.....	77
3.9. PEAK OUTPUT POWER.....	82
3.10. DUTY CYCLE.....	86
3.11. ANTENNA REQUIREMENT.....	90



# 1. TEST SUMMARY

## 1.1. Test Standards

The tests were performed according to following standards:

[FCC Rules Part 15.247](#): Operation within the bands of 902-928MHz, 2400-2483.5MHz, and 5725-5850MHz.

[RSS 247 Issue 2](#): Standard Specifications for Frequency Hopping Systems (FHSs) and Digital Transmission Systems (DTSs) Operating in the Bands 902-928MHz, 2400-2483.5MHz and 5725-5850MHz.

[ANSI C63.10-2013](#): American National Standard for Testing Unlicensed Wireless Devices.

## 1.2. Report version

Revised No.	Date of issue	Description
01	Jan. 05, 2020	Original



### 1.3. Test Description

FCC Part 15 Subpart C (15.247)/ RSS 247 Issue 2				
Test Item	Standard Section		Result	Test Engineer
	FCC	IC		
Antenna Requirement	15.203	/	Pass	Rod Luo
Conducted Emission	15.207	RSS-Gen 8.8	Pass	Jon Huang
Restricted Bands	15.205	RSS-Gen 8.10	Pass	Rod Luo
Hopping Channel Separation	15.247(a)(1)	RSS 247 5.1 (b)	Pass	Rod Luo
Dwell Time	15.247(a)(iii)	RSS 247 5.1 (d)	Pass	Rod Luo
Peak Output Power	15.247(b)(1)	RSS 247 5.4 (b)	Pass	Rod Luo
Number of Hopping Frequency	15.247(a)(iii)	RSS 247 5.1 (d)	Pass	Rod Luo
Conducted Band Edge and Spurious Emissions	15.247(d)	RSS 247 5.5	Pass	Rod Luo
Radiated Band Edge and Spurious Emissions	15.205&15.209&15.247(d)	RSS 247 5.5	Pass	Rod Luo
Radiated Spurious Emission	15.247(d)&15.209	RSS 247 5.5&RSS-Gen 8.9	Pass	Rod Luo
20dB Bandwidth	15.247(a)	RSS 247 5.1 (b)	Pass	Rod Luo

Note: The measurement uncertainty is not included in the test result.



## 1.4. Test Facility

### CTC Laboratories, Inc.

Add: 1-2/F., Building 2, Jiaquan Building, Guanlan High-Tech Park, Shenzhen, Guangdong, China

### Laboratory accreditation

The test facility is recognized, certified, or accredited by the following organizations:

#### CNAS-Lab Code: L5365

CTC Laboratories, Inc. has been assessed and proved to be in compliance with CNAS-CL01 Accreditation. Criteria for Testing and Calibration Laboratories (identical to ISO/IEC 17025:2017 General Requirements) for the Competence of Testing and Calibration Laboratories.

#### A2LA-Lab Cert. No.: 4340.01

CTC Laboratories, Inc. EMC Laboratory has been accredited by A2LA for technical competence in the field of electrical testing, and proved to be in compliance with ISO/IEC 17025:2017 General Requirements for the Competence of Testing and Calibration Laboratories and any additional program requirements in the identified field of testing.

#### Industry Canada (Registration No.: 9783A, CAB Identifier: CN0029)

CTC Laboratories, Inc. EMC Laboratory has been registered by Certification and Engineer Bureau of Industry Canada for the performance of with Registration NO.: 9783A on Jan, 2016.

#### FCC (Registration No.: 951311, Designation Number CN1208)

CTC Laboratories, Inc. EMC Laboratory has been registered and fully described in a report filed with the (FCC) Federal Communications Commission. The acceptance letter from the FCC is maintained in our files. Registration 951311, Aug 26, 2017.

## 1.5. Measurement Uncertainty

The data and results referenced in this document are true and accurate. The reader is cautioned that there may be errors within the calibration limits of the equipment and facilities. The measurement uncertainty was calculated for all measurements listed in this test report acc. to TR-100028-01 "Electromagnetic compatibility and Radio spectrum Matters (ERM); Uncertainties in the measurement of mobile radio equipment characteristics; Part 1" and TR-100028-02 "Electromagnetic compatibility and Radio spectrum Matters (ERM); Uncertainties in the measurement of mobile radio equipment characteristics; Part 2" and is documented in the CTC Laboratories, Inc. quality system acc. to DIN EN ISO/IEC 17025. Furthermore, component and process variability of devices similar to that tested may result in additional deviation. The manufacturer has the sole responsibility of continued compliance of the device.

Below is the best measurement capability for CTC Laboratories, Inc.



Test Items	Measurement Uncertainty	Notes
Transmitter power conducted	0.42 dB	(1)
Transmitter power Radiated	2.14 dB	(1)
Conducted spurious emissions 9kHz~40GHz	1.60 dB	(1)
Radiated spurious emissions 9kHz~40GHz	2.20 dB	(1)
Conducted Emissions 9kHz~30MHz	3.08 dB	(1)
Radiated Emissions 30~1000MHz	4.51 dB	(1)
Radiated Emissions 1~18GHz	5.84 dB	(1)
Radiated Emissions 18~40GHz	6.12 dB	(1)
Occupied Bandwidth	-----	(1)

**Note (1):** This uncertainty represents an expanded uncertainty expressed at approximately the 95% confidence level using a coverage factor of k=1.96.

## 1.6. Environmental conditions

During the measurement the environmental conditions were within the listed ranges:

Temperature:	21°C ~ 27°C
Relative Humidity:	40% ~ 60%
Air Pressure:	101kPa



## 2. GENERAL INFORMATION

### 2.1. Client Information

Applicant:	Imin Technology Pte Ltd
Address:	63 Ubi Ave 1 #07-02 63@Ubi Singapore 408937
Manufacturer:	Imin Technology Pte Ltd
Address:	63 Ubi Ave 1 #07-02 63@Ubi Singapore 408937



## 2.2. General Description of EUT

Product Name:	Mobile POS
Trade Mark:	N/A
Model/Type reference:	M2-203
Listed Model(s):	N/A
Power supply:	5Vdc/2A from AC/DC Adapter 7.4Vdc from 2600mAh Li-ion Battery
Adapter Model:	TPA-46050200UU Input:100-240V~ 50/60Hz 0.3A Output: 5Vdc/2A
Hardware version:	Z2-MB-V2.0
Software version:	M2_1.1.6SG
<b>Bluetooth 4.2+EDR</b>	
Modulation:	GFSK, $\pi/4$ -DQPSK, 8-DPSK
Operation frequency:	2402MHz~2480MHz
Channel number:	79
Channel separation:	1MHz
Antenna type:	PIFA Antenna
Antenna gain:	2.51dBi





### 2.3. Accessory Equipment information

Equipment Information			
Name	Model	S/N	Manufacturer
/	/	/	/
/	/	/	/
Cable Information			
Name	Shielded Type	Ferrite Core	Length
/	/	/	/
Test Software Information			
Name	/	/	/
/	/	/	/



### 2.4. Operation state

Operation Frequency List: The EUT has been tested under typical operating condition. The Applicant provides communication tools software to control the EUT for staying in continuous transmitting and receiving mode for testing. BT EDR, 79 channels are provided to the EUT. Channels 00/39/78 were selected for testing.

Operation Frequency List:

Channel	Frequency (MHz)
<b>00</b>	<b>2402</b>
01	2403
:	:
38	2440
<b>39</b>	<b>2441</b>
40	2442
:	:
77	2479
<b>78</b>	<b>2480</b>

Note: The display in grey were the channel selected for testing.

#### Test mode

For RF test items:
The engineering test program was provided and enabled to make EUT continuous transmit
For AC power line conducted emissions:
The EUT was set to connect with the Bluetooth instrument under large package sizes transmission.
For Radiated spurious emissions test item:
The engineering test program was provided and enabled to make EUT continuous transmit. The EUT in each of three orthogonal axis emissions had been tested, but only the worst case (X axis) data recorded in the report.





## 2.5. Measurement Instruments List

Tonscend JS0806-2 Test system					
Item	Test Equipment	Manufacturer	Model No.	Serial No.	Calibrated until
1	Spectrum Analyzer	Rohde & Schwarz	FSU26	100105	Dec. 26, 2021
2	Spectrum Analyzer	Rohde & Schwarz	FUV40-N	101331	Mar. 15, 2021
3	MXG Vector Signal Generator	Agilent	N5182A	MY47420864	Dec. 26, 2021
4	Signal Generator	Agilent	E8257D	MY46521908	Dec. 26, 2021
5	Power Sensor	Agilent	U2021XA	MY5365004	Dec. 26, 2021
6	Power Sensor	Agilent	U2021XA	MY5365006	Dec. 26, 2021
7	Simultaneous Sampling DAQ	Agilent	U2531A	TW54493510	Dec. 26, 2021
8	Climate Chamber	TABAI	PR-4G	A8708055	Dec. 26, 2021
9	Wideband Radio Communication Tester	Rohde & Schwarz	CMW500	116410	Dec. 26, 2021
10	Climate Chamber	ESPEC	MT3065	/	Dec. 26, 2021
11	Wideband Radio Communication Tester	Rohde & Schwarz	CMW500	116410	Dec. 26, 2021
12	300328 v2.2.2 test system	TONSCEND	v2.6	/	/

Radiated Emission and Transmitter spurious emissions					
Item	Test Equipment	Manufacturer	Model No.	Serial No.	Calibrated until
1	EMI Test Receiver	Rohde & Schwarz	ESCI	100658	Dec. 26, 2021
2	High pass filter	micro-tranics	HPM50111	142	Dec. 26, 2021
3	Log-Bicon Antenna	Schwarzbeck	CBL6141A	4180	Dec. 26, 2021
4	Ultra-Broadband Antenna	ShwarzBeck	BBHA9170	25841	Dec. 26, 2021
5	Loop Antenna	LAPLAC	RF300	9138	Dec. 26, 2021
6	Spectrum Analyzer	Rohde & Schwarz	FSU26	100105	Dec. 26, 2021
7	Horn Antenna	Schwarzbeck	BBHA 9120D	647	Dec. 26, 2021
8	Pre-Amplifier	HP	8447D	1937A03050	Dec. 26, 2021
9	Pre-Amplifier	EMCI	EMC051835	980075	Dec. 26, 2021
10	Antenna Mast	UC	UC3000	N/A	N/A
11	Turn Table	UC	UC3000	N/A	N/A
12	Cable Below 1GHz	Schwarzbeck	AK9515E	33155	Dec. 26, 2021
13	Cable Above 1GHz	Hubersuhner	SUCOFLEX102	DA1580	Dec. 26, 2021
14	Splitter	Mini-Circuit	ZAPD-4	400059	Dec. 26, 2021
15	RF Connection Cable	HUBER+SUHNER	RE-7-FL	N/A	Dec. 26, 2021

CTC Laboratories, Inc.

1-2/F., Building 2, Jiaquan Building, Guanlan High-Tech Park, Shenzhen, Guangdong, China

Tel.: (86)755-27521059

Fax: (86)755-27521011

Http://www.sz-ctc.org.cn

For anti-fake verification, please visit the official website of Certification and Accreditation Administration of the People's Republic of China : [yz.cnca.cn](http://yz.cnca.cn)



16	RF Connection Cable	Chengdu E-Microwave	---	---	Dec. 26, 2021
17	High pass filter	Compliance Direction systems	BSU-6	34202	Dec. 26, 2021
18	Attenuator	Chengdu E-Microwave	EM-CAXX-10RNZ-3	---	Dec. 26, 2021
19	High and low temperature box	ESPEC	MT3065	12114019	Dec. 26, 2021

Conducted Emission					
Item	Test Equipment	Manufacturer	Model No.	Serial No.	Calibrated until
1	LISN	Rohde & Schwarz	ENV216	101112	Dec. 26, 2021
2	LISN	Rohde & Schwarz	ENV216	101113	Dec. 26, 2021
3	EMI Test Receiver	Rohde & Schwarz	ESCI	100658	Dec. 26, 2021

Note:1. The Cal. Interval was one year.

2. The cable loss has calculated in test result which connection between each test instruments.

### 3. TEST ITEM AND RESULTS

#### 3.1. Conducted Emission

**Limit**

FCC CFR Title 47 Part 15 Subpart C Section 15.207/ RSS – Gen 8.8

Frequency range (MHz)	Limit (dBuV)	
	Quasi-peak	Average
0.15-0.5	66 to 56*	56 to 46*
0.5-5	56	46
5-30	60	50

\* Decreases with the logarithm of the frequency.

**Test Configuration**

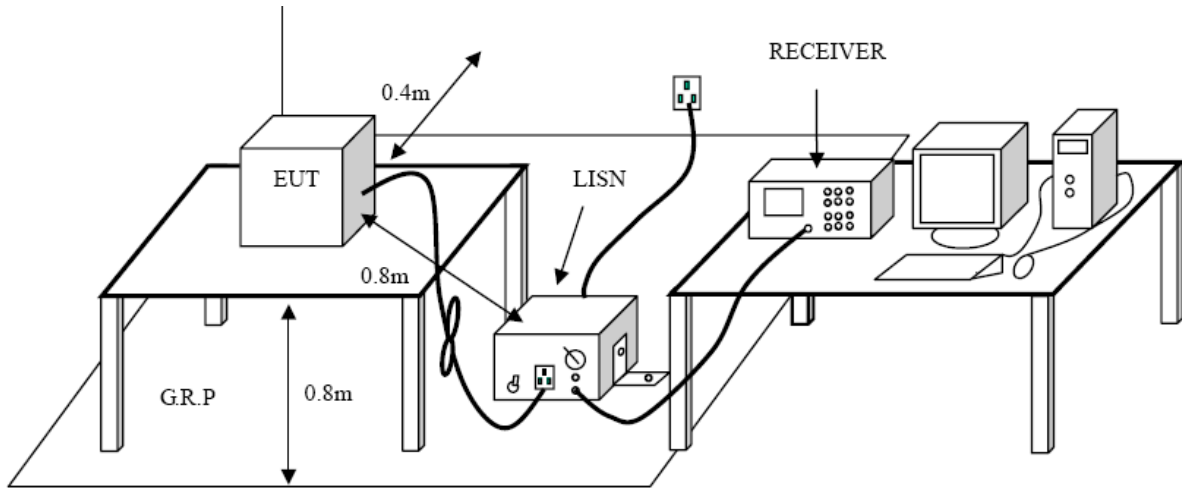

**Test Procedure**

1. The EUT was setup according to ANSI C63.10:2013 requirements.
2. The EUT was placed on a platform of nominal size, 1 m by 1.5 m, raised 80 cm above the conducting ground plane. The vertical conducting plane was located 40 cm to the rear of the EUT. All other surfaces of EUT were at least 80 cm from any other grounded conducting surface.
3. The EUT and simulators are connected to the main power through a line impedances stabilization network (LISN). The LISN provides a 50ohm /50uH coupling impedance for the measuring equipment. The peripheral devices are also connected to the main power through a LISN. (Please refer to the block diagram of the test setup and photographs)
4. Each current-carrying conductor of the EUT power cord, except the ground (safety) conductor, was individually connected through a LISN to the input power source.
5. The excess length of the power cord between the EUT and the LISN receptacle were folded back and forth at the center of the lead to form a bundle not exceeding 40 cm in length.
6. Conducted Emissions were investigated over the frequency range from 0.15MHz to 30MHz using a receiver bandwidth of 9 kHz.
7. During the above scans, the emissions were maximized by cable manipulation.

**Test Mode**

Please refer to the clause 2.4.



**Test Results**

<b>Test Voltage:</b>	AC 120V/60 Hz
<b>Terminal:</b>	Line

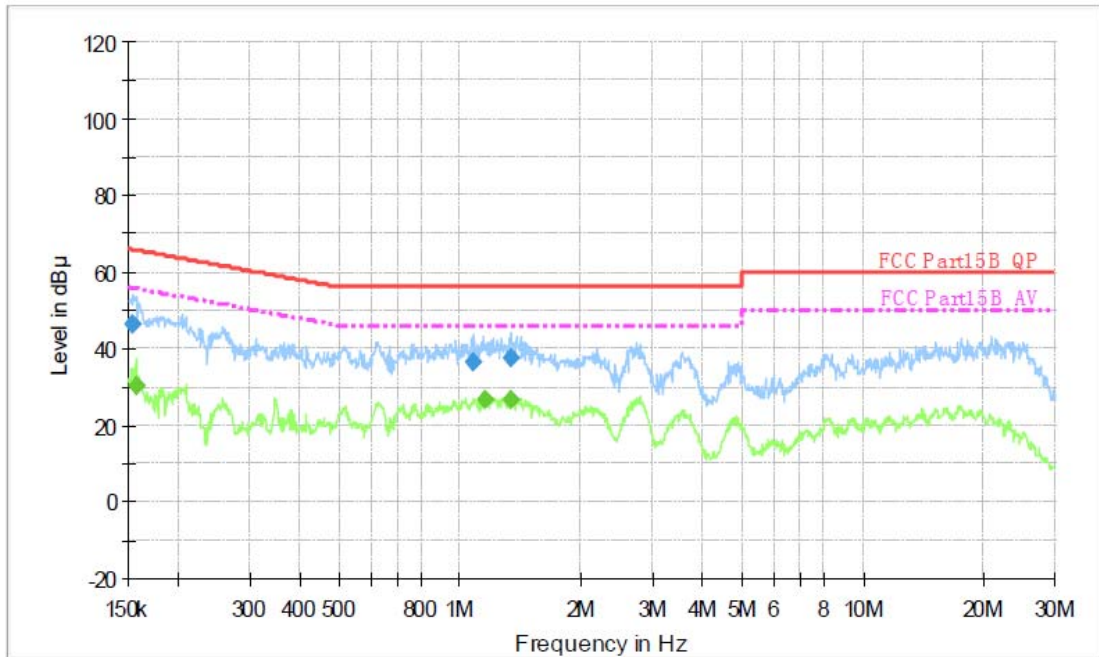

**Final Measurement Detector 1**

Frequency (MHz)	QuasiPeak (dBµ V)	Meas. Time (ms)	Bandwidth (kHz)	Filter	Line	Corr. (dB)	Margin (dB)	Limit (dBµ V)	Comment
0.154250	46.4	1000.00	9.000	On	L1	10.4	19.4	65.8	
1.082130	36.3	1000.00	9.000	On	L1	10.4	19.7	56.0	
1.331780	37.3	1000.00	9.000	On	L1	10.4	18.7	56.0	

**Final Measurement Detector 2**

Frequency (MHz)	Average (dBµ V)	Meas. Time (ms)	Bandwidth (kHz)	Filter	Line	Corr. (dB)	Margin (dB)	Limit (dBµ V)	Comment
0.156110	30.3	1000.00	9.000	On	L1	10.4	25.4	55.7	
1.148910	26.5	1000.00	9.000	On	L1	10.4	19.5	46.0	
1.331780	26.5	1000.00	9.000	On	L1	10.4	19.5	46.0	

Emission Level= Read Level+ Correct Factor



<b>Test Voltage:</b>	AC 120V/60 Hz
<b>Terminal:</b>	Neutral

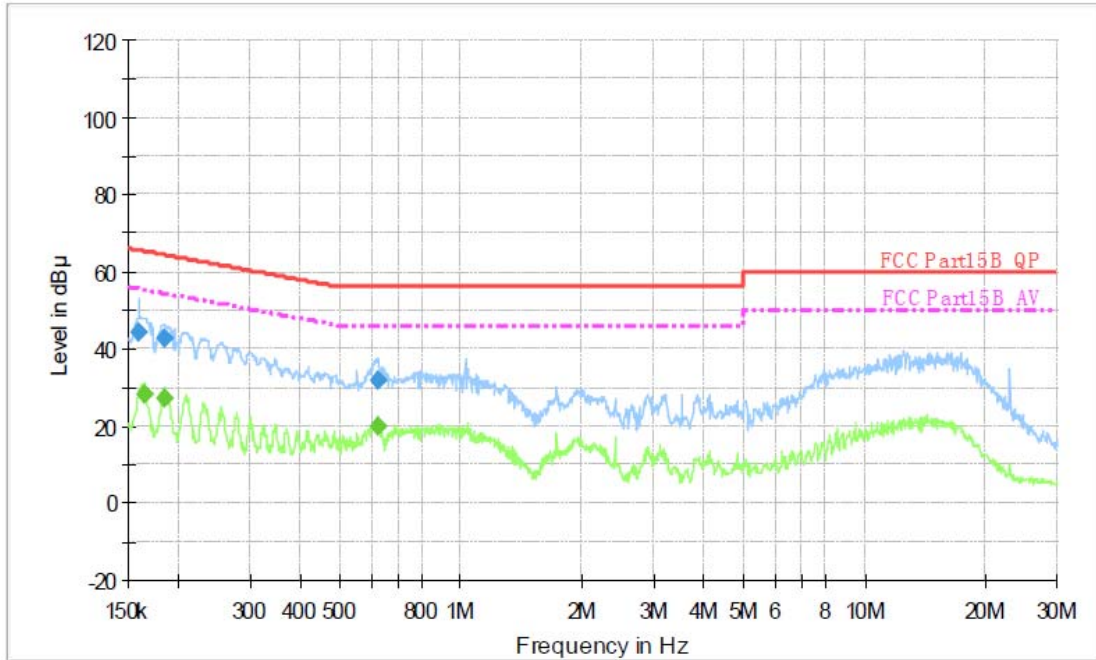

**Final Measurement Detector 1**

Frequency (MHz)	QuasiPeak (dBµ V)	Meas. Time (ms)	Bandwidth (kHz)	Filter	Line	Corr. (dB)	Margin (dB)	Limit (dBµ V)	Comment
0.158620	44.3	1000.00	9.000	On	N	10.7	21.2	65.5	
0.183140	42.9	1000.00	9.000	On	N	10.7	21.4	64.3	
0.621290	32.0	1000.00	9.000	On	N	10.7	24.0	56.0	

**Final Measurement Detector 2**

Frequency (MHz)	Average (dBµ V)	Meas. Time (ms)	Bandwidth (kHz)	Filter	Line	Corr. (dB)	Margin (dB)	Limit (dBµ V)	Comment
0.163770	28.3	1000.00	9.000	On	N	10.7	27.0	55.3	
0.184610	27.3	1000.00	9.000	On	N	10.7	27.0	54.3	
0.623770	19.9	1000.00	9.000	On	N	10.7	26.1	46.0	

Emission Level= Read Level+ Correct Factor

### 3.2. Radiated Emission

**Limit**

FCC CFR Title 47 Part 15 Subpart C Section 15.209/ RSS – Gen 8.9

Frequency	Limit (dBuV/m @3m)	Value
30 MHz ~ 88 MHz	40.00	Quasi-peak
88 MHz ~ 216 MHz	43.50	Quasi-peak
216 MHz ~ 960 MHz	46.00	Quasi-peak
960 MHz ~ 1 GHz	54.00	Quasi-peak
Above 1 GHz	54.00	Average
	74.00	Peak

**Note:**

- (1) The tighter limit applies at the band edges.
- (2) Emission Level (dBuV/m)=20log Emission Level (uV/m).

**Test Configuration**

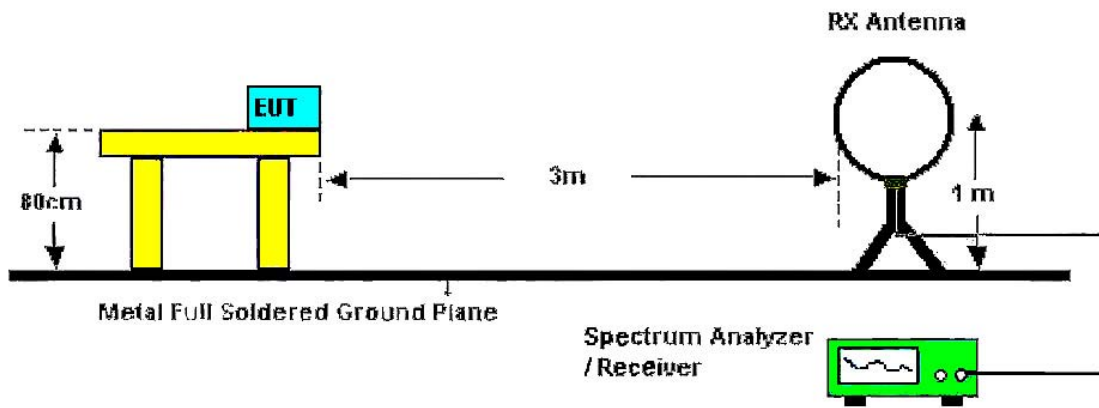

Below 30MHz Test Setup

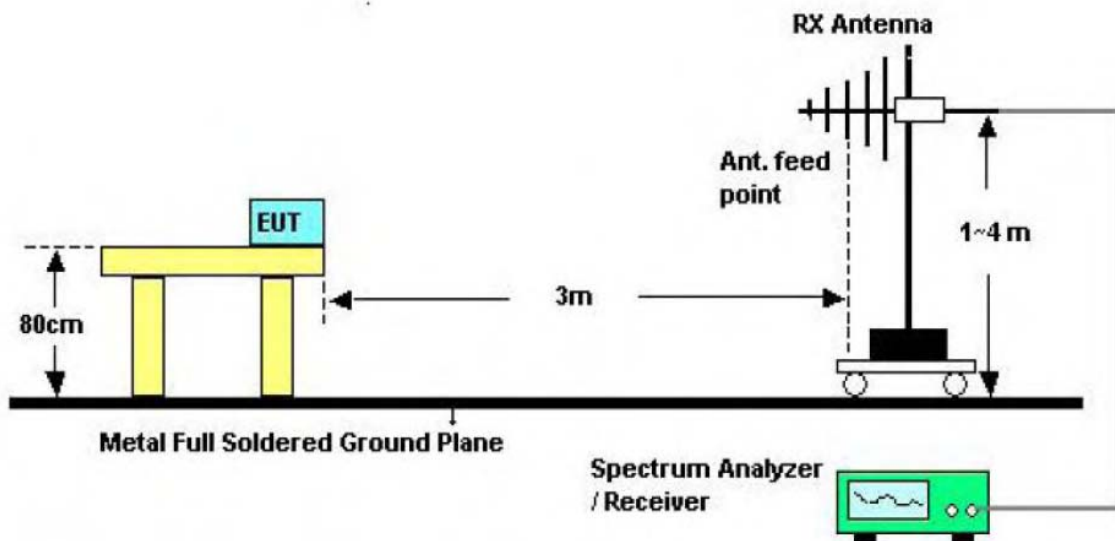

Below 1000MHz Test Setup



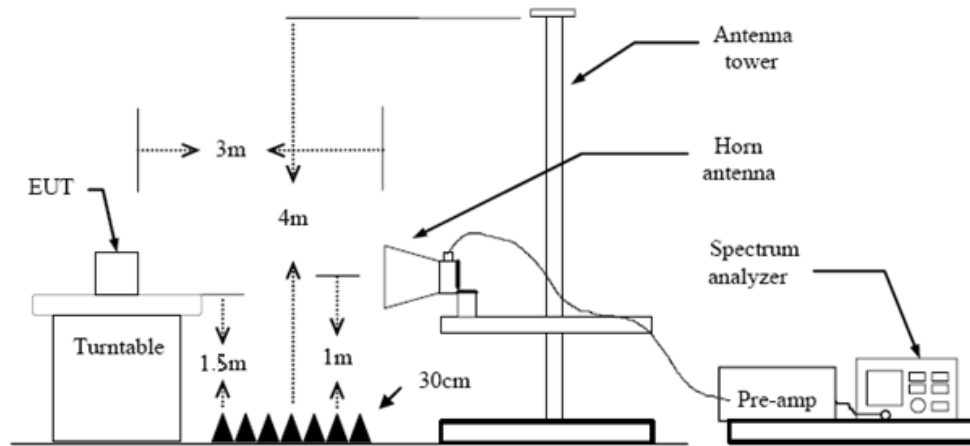

Above 1GHz Test Setup

### **Test Procedure**

1. The EUT was setup and tested according to ANSI C63.10:2013
2. The EUT is placed on a turn table which is 0.8 meter above ground for below 1 GHz, and 1.5 m for above 1 GHz. The turn table is rotated 360 degrees to determine the position of the maximum emission level.
3. The EUT was set 3 meters from the receiving antenna, which was mounted on the top of a variable height antenna tower.
4. For each suspected emission, the EUT was arranged to its worst case and then tune the Antenna tower (from 1 m to 4 m) and turntable (from 0 degree to 360 degrees) to find the maximum reading. A pre-amp and a high pass filter are used for the test in order to get better signal level to comply with the guidelines.
5. Set to the maximum power setting and enable the EUT transmit continuously.
6. Use the following spectrum analyzer settings
  - (1) Span shall wide enough to fully capture the emission being measured;
  - (2) Below 1 GHz:  
RBW=120 kHz, VBW=300 kHz, Sweep=auto, Detector function=peak, Trace=max hold;  
If the emission level of the EUT measured by the peak detector is 3 dB lower than the applicable limit, the peak emission level will be reported. Otherwise, the emission measurement will be repeated using the quasi-peak detector and reported.
  - (3) From 1 GHz to 10<sup>th</sup> harmonic:  
RBW=1MHz, VBW=3MHz Peak detector for Peak value.  
RBW=1MHz, VBW $\geq$ 1/T Peak detector for Average value.Note 1: For the 1/T& Duty Cycle please refer to clause 3.10 Duty Cycle.

### **Test Mode**

Please refer to the clause 2.4.

### **Test Result**

#### **9 KHz~30 MHz**

From 9 KHz to 30 MHz: Conclusion: PASS

Note: The amplitude of spurious emissions which are attenuated by more than 20dB below the permissible value has no need to be reported.



30MHz-1GHz

<b>Ant. Pol.</b>	Horizontal
<b>Test Mode:</b>	TX GFSK Mode 2402MHz
<b>Remark:</b>	Only worse case is reported

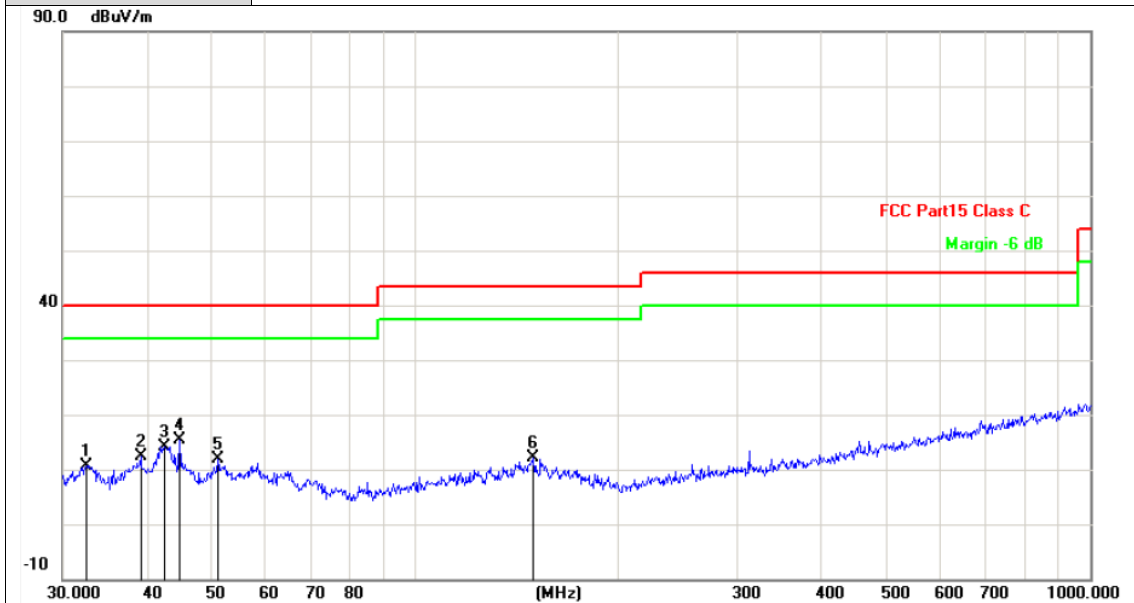

No.	Frequency (MHz)	Factor (dB/m)	Reading (dBuV)	Level (dBuV/m)	Limit (dBuV/m)	Margin (dB)	Detector
1	32.5197	-18.08	28.73	10.65	40.00	-29.35	QP
2	39.1615	-17.41	29.86	12.45	40.00	-27.55	QP
3	42.4508	-17.48	31.67	14.19	40.00	-25.81	QP
4	44.7433	-17.65	33.11	15.46	40.00	-24.54	QP
5	50.9419	-17.84	29.64	11.80	40.00	-28.20	QP
6	149.4857	-16.81	28.93	12.12	43.50	-31.38	QP

Remarks:

1. Factor (dB/m) = Antenna Factor (dB/m)+Cable Factor (dB)-Pre-amplifier Factor
2. Margin value = Level -Limit value



Ant. Pol.	Vertical
Test Mode:	TX GFSK Mode 2402MHz
Remark:	Only worse case is reported

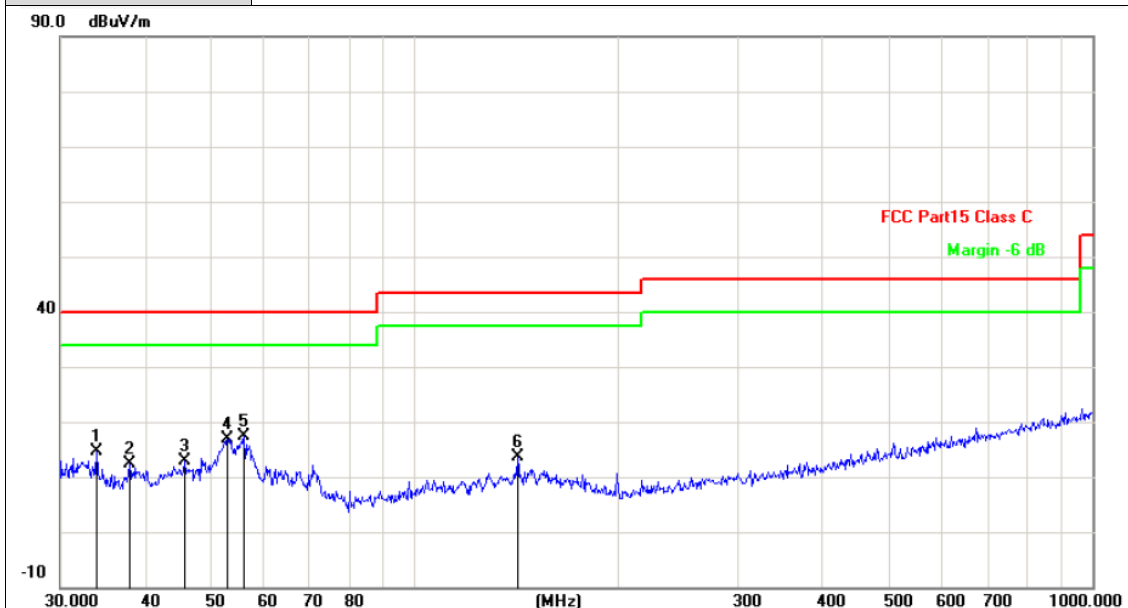

No.	Frequency (MHz)	Factor (dB/m)	Reading (dBuV)	Level (dBuV/m)	Limit (dBuV/m)	Margin (dB)	Detector
1	33.9173	-18.04	32.59	14.55	40.00	-25.45	QP
2	37.9449	-17.58	29.96	12.38	40.00	-27.62	QP
3	45.6947	-17.68	30.68	13.00	40.00	-27.00	QP
4	52.9453	-17.99	34.87	16.88	40.00	-23.12	QP
5	56.0007	-18.21	35.49	17.28	40.00	-22.72	QP
6	141.8262	-17.49	31.16	13.67	43.50	-29.83	QP

Remarks:

1. Factor (dB/m) = Antenna Factor (dB/m)+Cable Factor (dB)-Pre-amplifier Factor
2. Margin value = Level -Limit value



Above 1GHz

<b>Ant. Pol.</b>	Horizontal
<b>Test Mode:</b>	TX GFSK Mode 2402MHz
<b>Remark:</b>	No report for the emission which more than 10 dB below the pre-scribed limit.

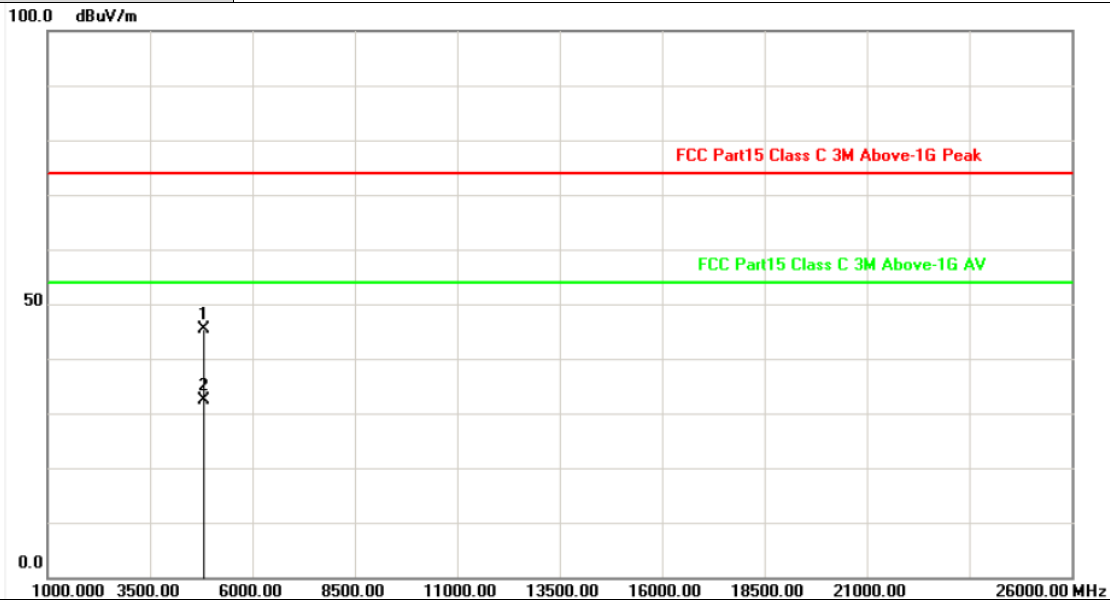

No.	Frequency (MHz)	Factor (dB/m)	Reading (dBuV)	Level (dBuV/m)	Limit (dBuV/m)	Margin (dB)	Detector
1	4803.782	-2.82	48.18	45.36	74.00	-28.64	peak
2	4804.907	-2.82	35.08	32.26	54.00	-21.74	AVG

Remarks:

- Factor (dB/m) = Antenna Factor (dB/m)+Cable Factor (dB)-Pre-amplifier Factor
- Margin value = Level -Limit value



<b>Ant. Pol.</b>	Vertical
<b>Test Mode:</b>	TX GFSK Mode 2402MHz
<b>Remark:</b>	No report for the emission which more than 10 dB below the pre-scribed limit.

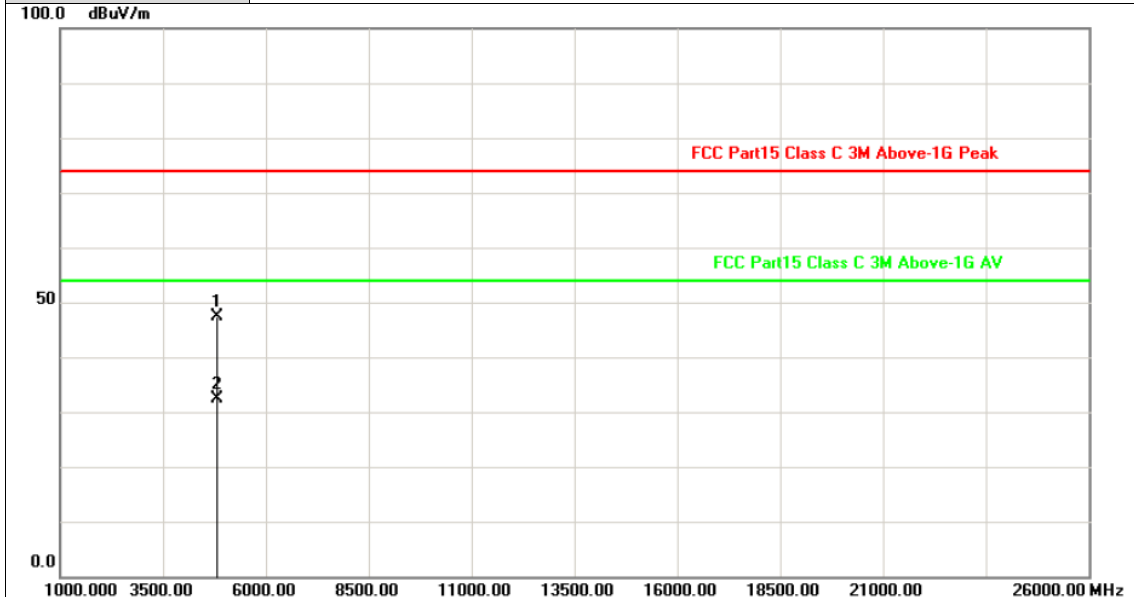

No.	Frequency (MHz)	Factor (dB/m)	Reading (dBuV)	Level (dBuV/m)	Limit (dBuV/m)	Margin (dB)	Detector
1	4803.999	-2.82	50.08	47.26	74.00	-26.74	peak
2	4804.001	-2.82	35.22	32.40	54.00	-21.60	AVG

Remarks:  
 1. Factor (dB/m) = Antenna Factor (dB/m)+Cable Factor (dB)-Pre-amplifier Factor  
 2. Margin value = Level -Limit value



<b>Ant. Pol.</b>	Horizontal
<b>Test Mode:</b>	TX GFSK Mode 2441MHz
<b>Remark:</b>	No report for the emission which more than 10 dB below the pre-scribed limit.

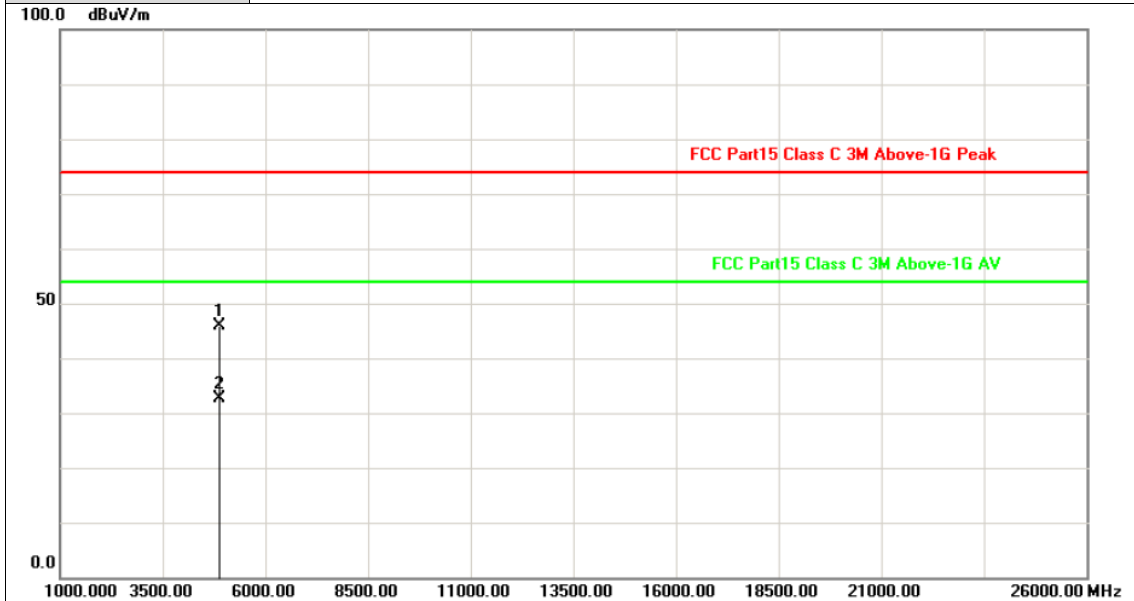

No.	Frequency (MHz)	Factor (dB/m)	Reading (dBuV)	Level (dBuV/m)	Limit (dBuV/m)	Margin (dB)	Detector
1	4881.372	-2.60	48.60	46.00	74.00	-28.00	peak
2	4882.567	-2.59	35.18	32.59	54.00	-21.41	AVG

Remarks:  
 1. Factor (dB/m) = Antenna Factor (dB/m)+Cable Factor (dB)-Pre-amplifier Factor  
 2. Margin value = Level -Limit value



<b>Ant. Pol.</b>	Vertical
<b>Test Mode:</b>	TX GFSK Mode 2441MHz
<b>Remark:</b>	No report for the emission which more than 10 dB below the prescribed limit.

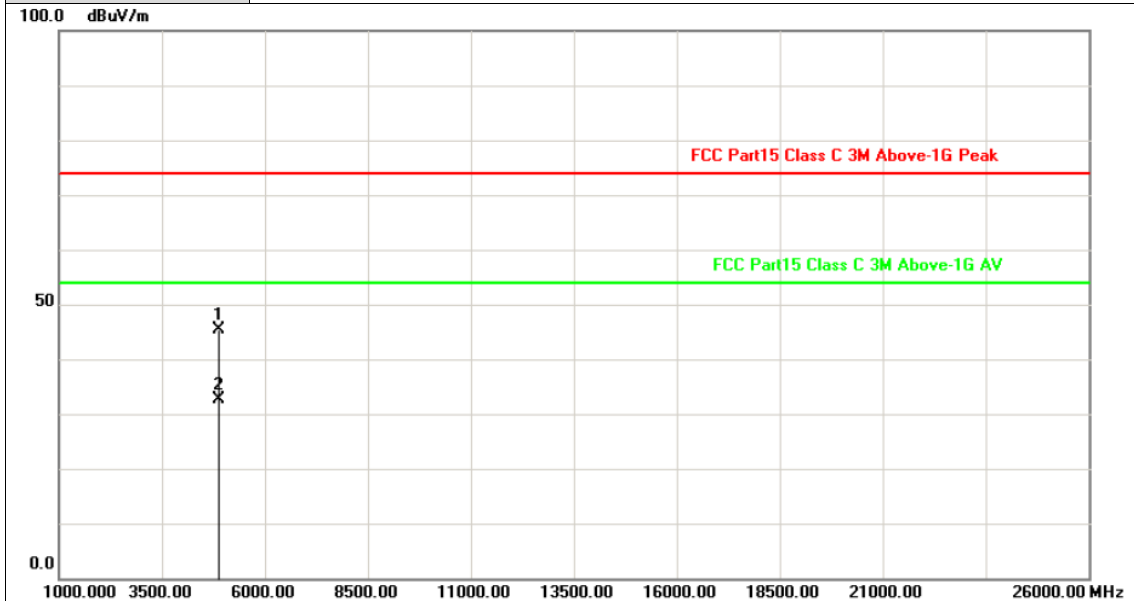

No.	Frequency (MHz)	Factor (dB/m)	Reading (dBuV)	Level (dBuV/m)	Limit (dBuV/m)	Margin (dB)	Detector
1	4882.000	-2.60	48.10	45.50	74.00	-28.50	peak
2	4882.001	-2.60	35.25	32.65	54.00	-21.35	AVG

Remarks:  
 1. Factor (dB/m) = Antenna Factor (dB/m)+Cable Factor (dB)-Pre-amplifier Factor  
 2. Margin value = Level -Limit value



<b>Ant. Pol.</b>	Horizontal
<b>Test Mode:</b>	TX GFSK Mode 2480MHz
<b>Remark:</b>	No report for the emission which more than 10 dB below the pre-scribed limit.

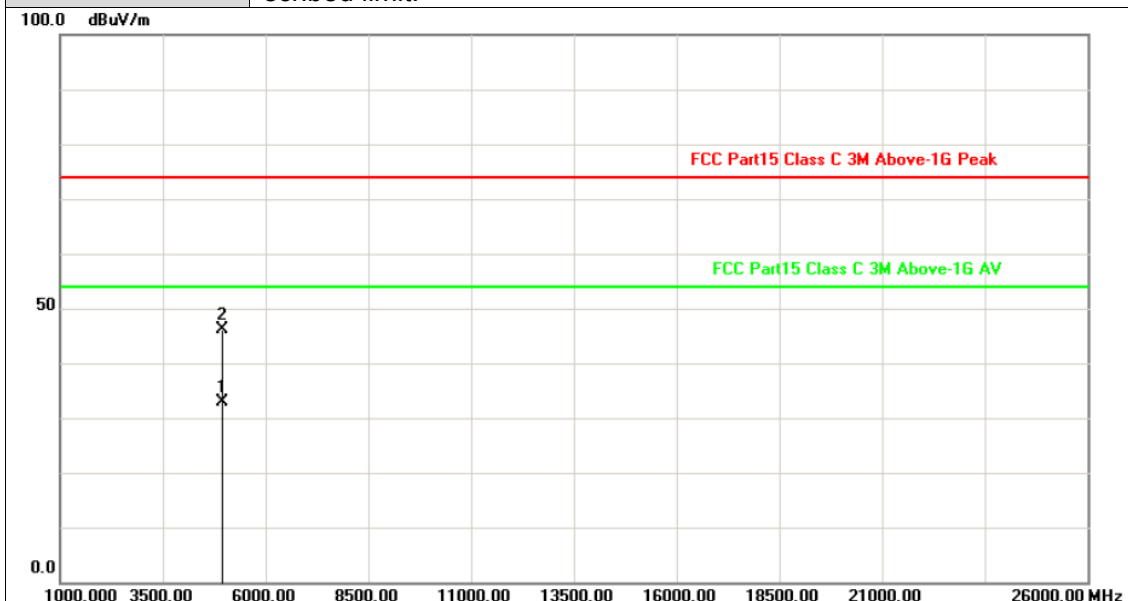

No.	Frequency (MHz)	Factor (dB/m)	Reading (dBuV)	Level (dBuV/m)	Limit (dBuV/m)	Margin (dB)	Detector
1	4959.090	-2.38	35.25	32.87	54.00	-21.13	AVG
2	4959.728	-2.38	48.47	46.09	74.00	-27.91	peak

Remarks:  
 1. Factor (dB/m) = Antenna Factor (dB/m)+Cable Factor (dB)-Pre-amplifier Factor  
 2. Margin value = Level -Limit value





<b>Ant. Pol.</b>	Vertical
<b>Test Mode:</b>	TX GFSK Mode 2480MHz
<b>Remark:</b>	No report for the emission which more than 10 dB below the pre-scribed limit.

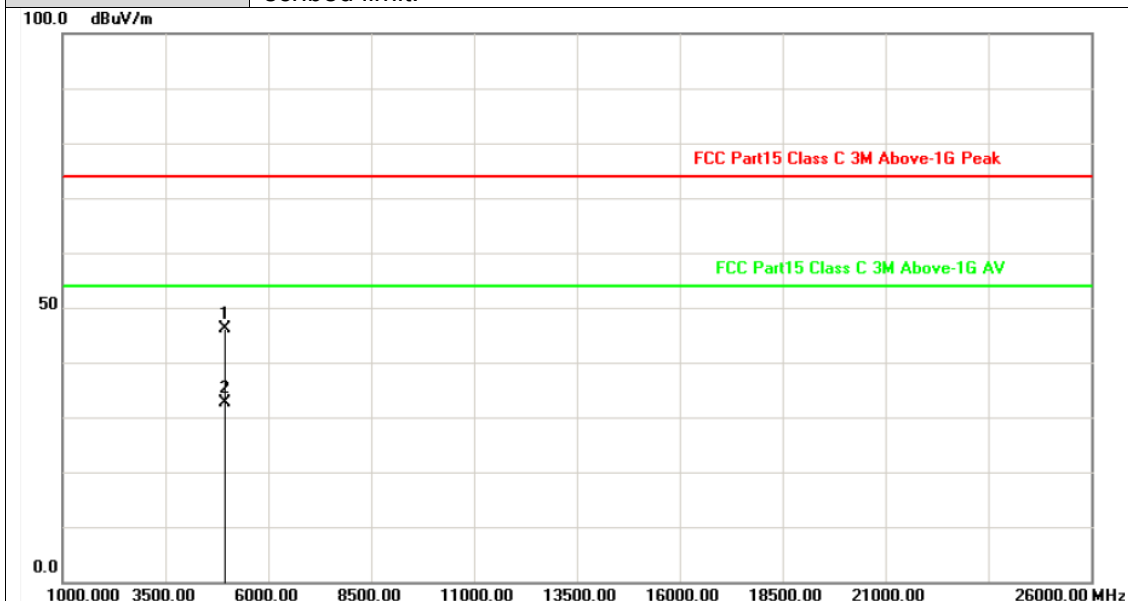

No.	Frequency (MHz)	Factor (dB/m)	Reading (dBuV)	Level (dBuV/m)	Limit (dBuV/m)	Margin (dB)	Detector
1	4959.999	-2.38	48.42	46.04	74.00	-27.96	peak
2	4960.001	-2.38	35.13	32.75	54.00	-21.25	AVG

Remarks:  
 1. Factor (dB/m) = Antenna Factor (dB/m)+Cable Factor (dB)-Pre-amplifier Factor  
 2. Margin value = Level -Limit value



<b>Ant. Pol.</b>	Horizontal
<b>Test Mode:</b>	TX $\pi/4$ -DQPSK Mode 2402MHz
<b>Remark:</b>	No report for the emission which more than 10 dB below the prescribed limit.

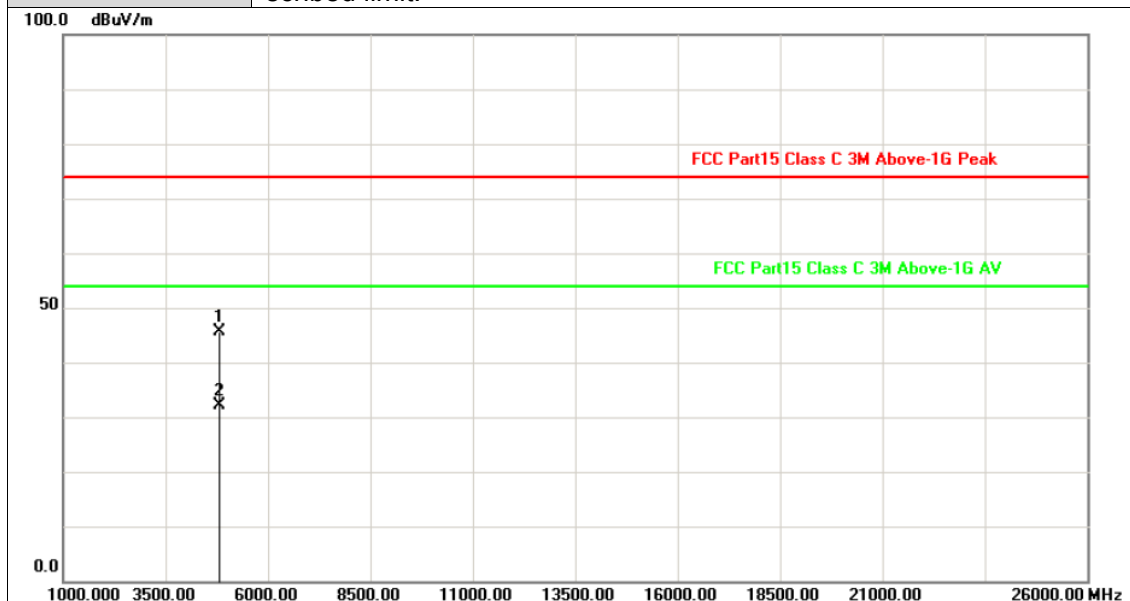

No.	Frequency (MHz)	Factor (dB/m)	Reading (dBuV)	Level (dBuV/m)	Limit (dBuV/m)	Margin (dB)	Detector
1	4803.750	-2.82	48.41	45.59	74.00	-28.41	peak
2	4803.827	-2.82	34.98	32.16	54.00	-21.84	AVG

Remarks:  
 1. Factor (dB/m) = Antenna Factor (dB/m)+Cable Factor (dB)-Pre-amplifier Factor  
 2. Margin value = Level -Limit value



<b>Ant. Pol.</b>	Vertical
<b>Test Mode:</b>	TX $\pi/4$ -DQPSK Mode 2402MHz
<b>Remark:</b>	No report for the emission which more than 10 dB below the pre-scribed limit.

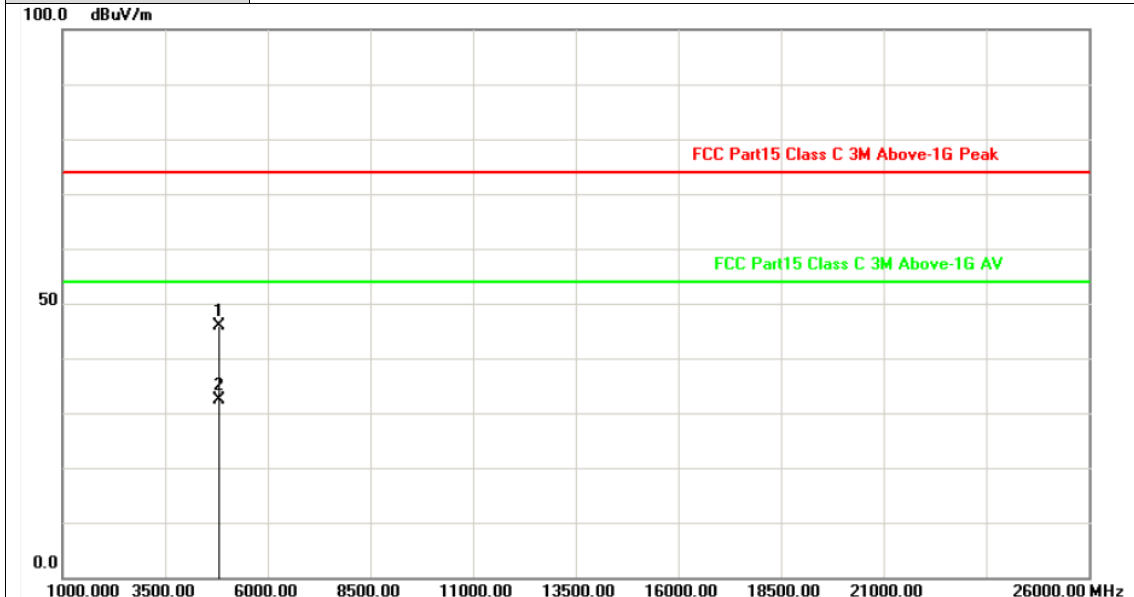

No.	Frequency (MHz)	Factor (dB/m)	Reading (dBuV)	Level (dBuV/m)	Limit (dBuV/m)	Margin (dB)	Detector
1	4804.000	-2.82	48.75	45.93	74.00	-28.07	peak
2	4804.001	-2.82	35.15	32.33	54.00	-21.67	AVG

Remarks:  
 1. Factor (dB/m) = Antenna Factor (dB/m)+Cable Factor (dB)-Pre-amplifier Factor  
 2. Margin value = Level -Limit value



<b>Ant. Pol.</b>	Horizontal
<b>Test Mode:</b>	TX $\pi/4$ -DQPSK Mode 2441MHz
<b>Remark:</b>	No report for the emission which more than 10 dB below the prescribed limit.

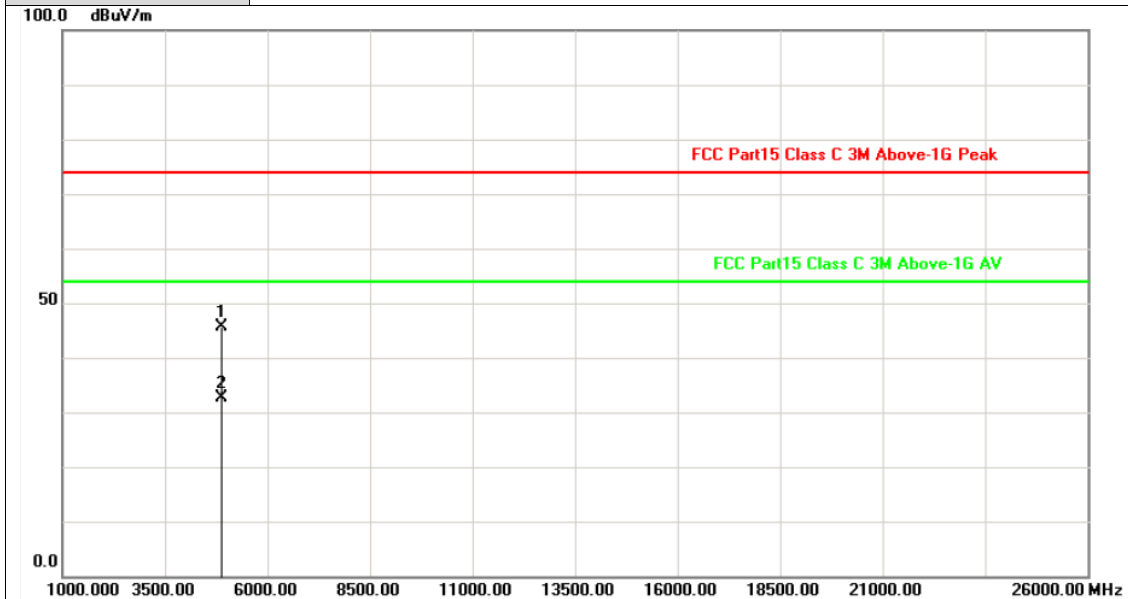

No.	Frequency (MHz)	Factor (dB/m)	Reading (dBuV)	Level (dBuV/m)	Limit (dBuV/m)	Margin (dB)	Detector
1	4881.426	-2.60	48.31	45.71	74.00	-28.29	peak
2	4882.955	-2.59	35.10	32.51	54.00	-21.49	AVG

Remarks:  
 1. Factor (dB/m) = Antenna Factor (dB/m)+Cable Factor (dB)-Pre-amplifier Factor  
 2. Margin value = Level -Limit value



<b>Ant. Pol.</b>	Vertical
<b>Test Mode:</b>	TX $\pi/4$ -DQPSK Mode 2441MHz
<b>Remark:</b>	No report for the emission which more than 10 dB below the pre-scribed limit.

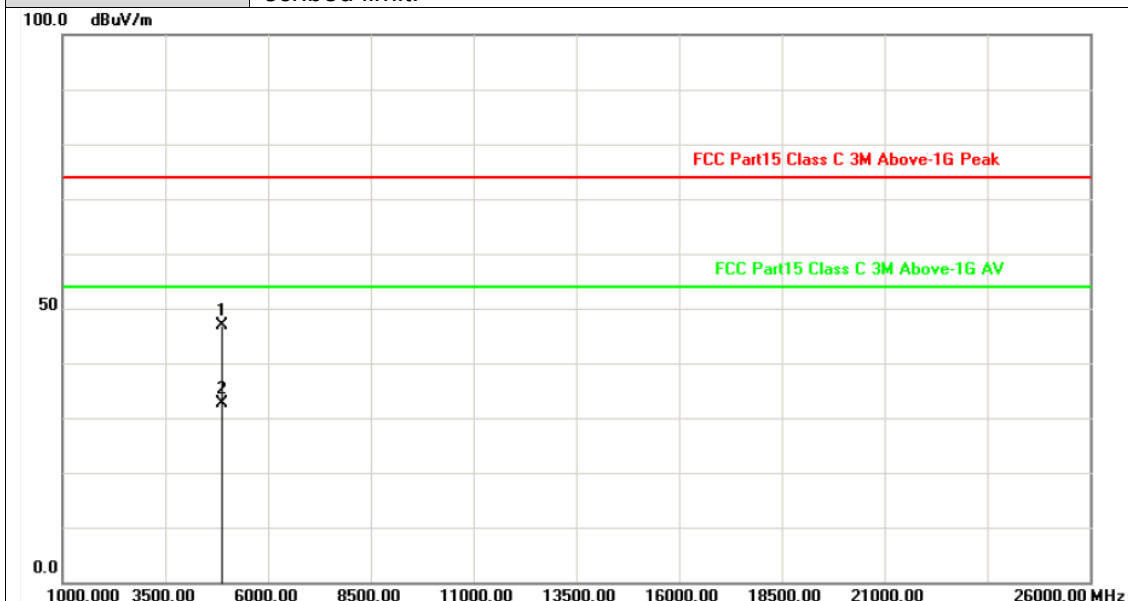

No.	Frequency (MHz)	Factor (dB/m)	Reading (dBuV)	Level (dBuV/m)	Limit (dBuV/m)	Margin (dB)	Detector
1	4882.000	-2.60	49.49	46.89	74.00	-27.11	peak
2	4882.001	-2.60	35.30	32.70	54.00	-21.30	AVG

Remarks:  
 1. Factor (dB/m) = Antenna Factor (dB/m)+Cable Factor (dB)-Pre-amplifier Factor  
 2. Margin value = Level -Limit value



<b>Ant. Pol.</b>	Horizontal
<b>Test Mode:</b>	TX $\pi/4$ -DQPSK Mode 2480MHz
<b>Remark:</b>	No report for the emission which more than 10 dB below the pre-scribed limit.

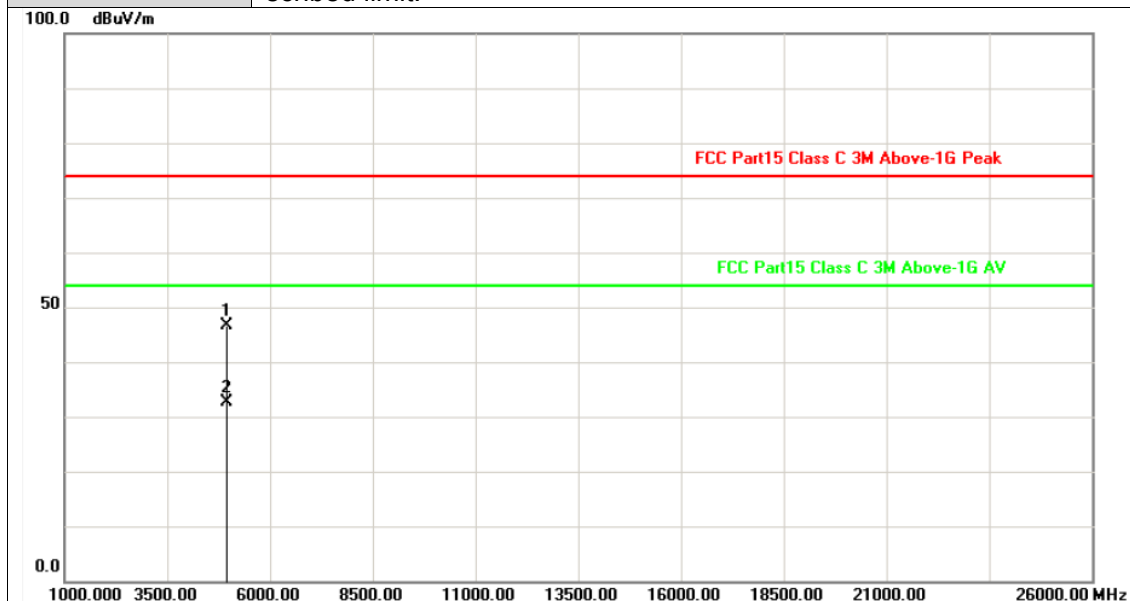

No.	Frequency (MHz)	Factor (dB/m)	Reading (dBuV)	Level (dBuV/m)	Limit (dBuV/m)	Margin (dB)	Detector
1	4959.359	-2.38	49.06	46.68	74.00	-27.32	peak
2	4960.946	-2.38	35.03	32.65	54.00	-21.35	AVG

Remarks:  
 1. Factor (dB/m) = Antenna Factor (dB/m)+Cable Factor (dB)-Pre-amplifier Factor  
 2. Margin value = Level -Limit value



<b>Ant. Pol.</b>	Vertical
<b>Test Mode:</b>	TX $\pi/4$ -DQPSK Mode 2480MHz
<b>Remark:</b>	No report for the emission which more than 10 dB below the pre-scribed limit.

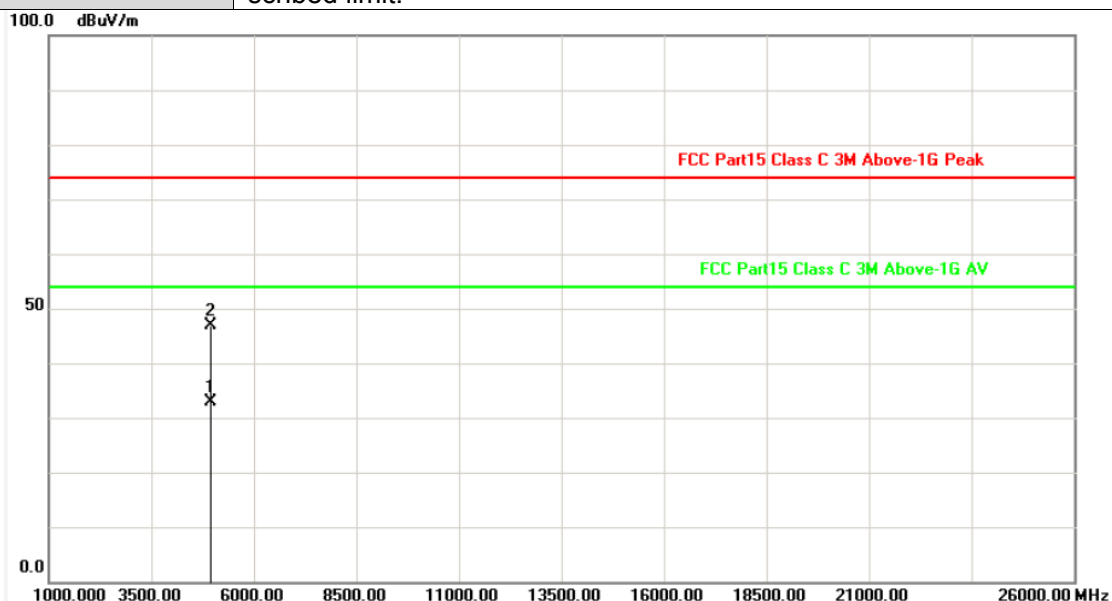

No.	Frequency (MHz)	Factor (dB/m)	Reading (dBuV)	Level (dBuV/m)	Limit (dBuV/m)	Margin (dB)	Detector
1	4959.999	-2.38	35.28	32.90	54.00	-21.10	AVG
2	4960.001	-2.38	49.16	46.78	74.00	-27.22	peak

Remarks:

- Factor (dB/m) = Antenna Factor (dB/m)+Cable Factor (dB)-Pre-amplifier Factor
- Margin value = Level -Limit value



<b>Ant. Pol.</b>	Horizontal
<b>Test Mode:</b>	TX 8-DPSK Mode 2402MHz
<b>Remark:</b>	No report for the emission which more than 10 dB below the pre-scribed limit.

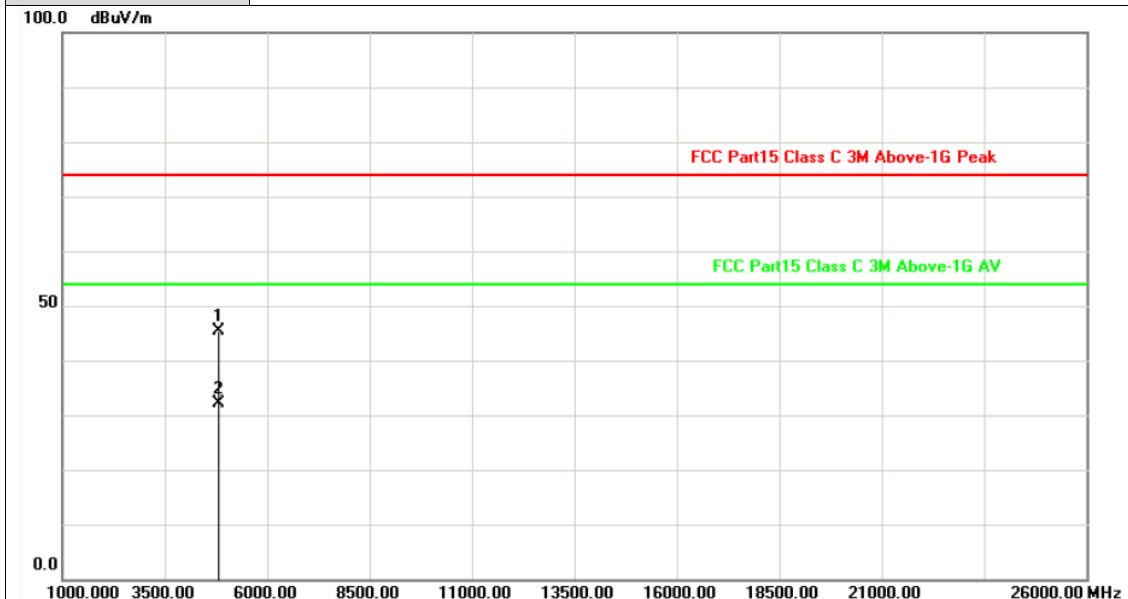

No.	Frequency (MHz)	Factor (dB/m)	Reading (dBuV)	Level (dBuV/m)	Limit (dBuV/m)	Margin (dB)	Detector
1	4803.378	-2.82	48.29	45.47	74.00	-28.53	peak
2	4803.699	-2.82	35.01	32.19	54.00	-21.81	AVG

Remarks:

- 1. Factor (dB/m) = Antenna Factor (dB/m)+Cable Factor (dB)-Pre-amplifier Factor
- 2. Margin value = Level -Limit value







<b>Ant. Pol.</b>	Vertical
<b>Test Mode:</b>	TX 8-DPSK Mode 2402MHz
<b>Remark:</b>	No report for the emission which more than 10 dB below the prescribed limit.

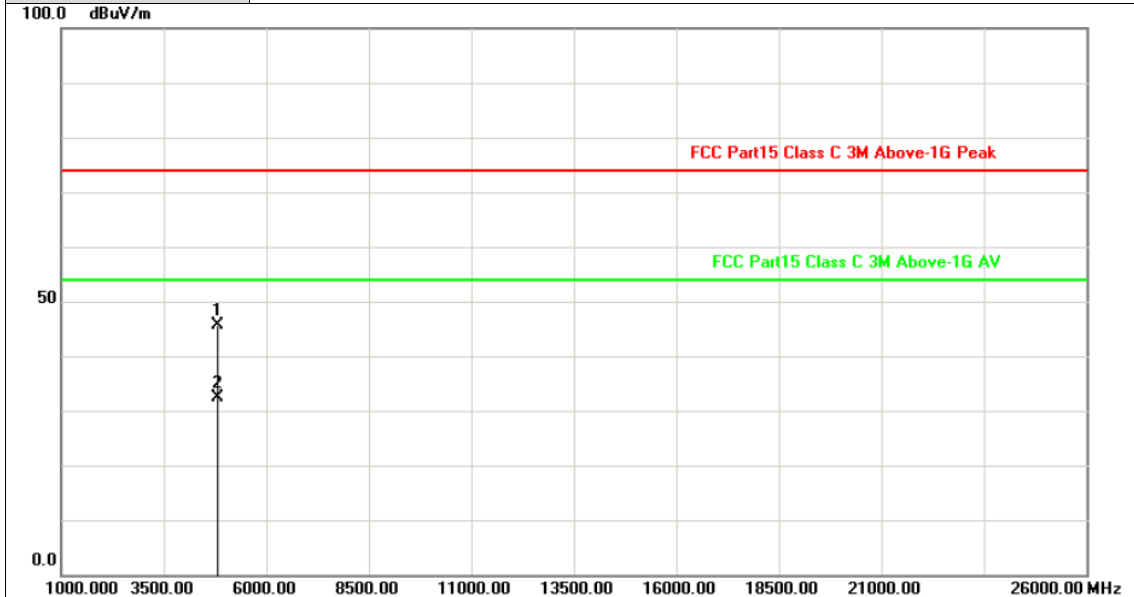

No.	Frequency (MHz)	Factor (dB/m)	Reading (dBuV)	Level (dBuV/m)	Limit (dBuV/m)	Margin (dB)	Detector
1	4801.999	-2.83	48.49	45.66	74.00	-28.34	peak
2	4802.000	-2.83	35.11	32.28	54.00	-21.72	AVG

Remarks:  
 1. Factor (dB/m) = Antenna Factor (dB/m)+Cable Factor (dB)-Pre-amplifier Factor  
 2. Margin value = Level -Limit value



<b>Ant. Pol.</b>	Horizontal
<b>Test Mode:</b>	TX 8-DPSK Mode 2441MHz
<b>Remark:</b>	No report for the emission which more than 10 dB below the pre-scribed limit.

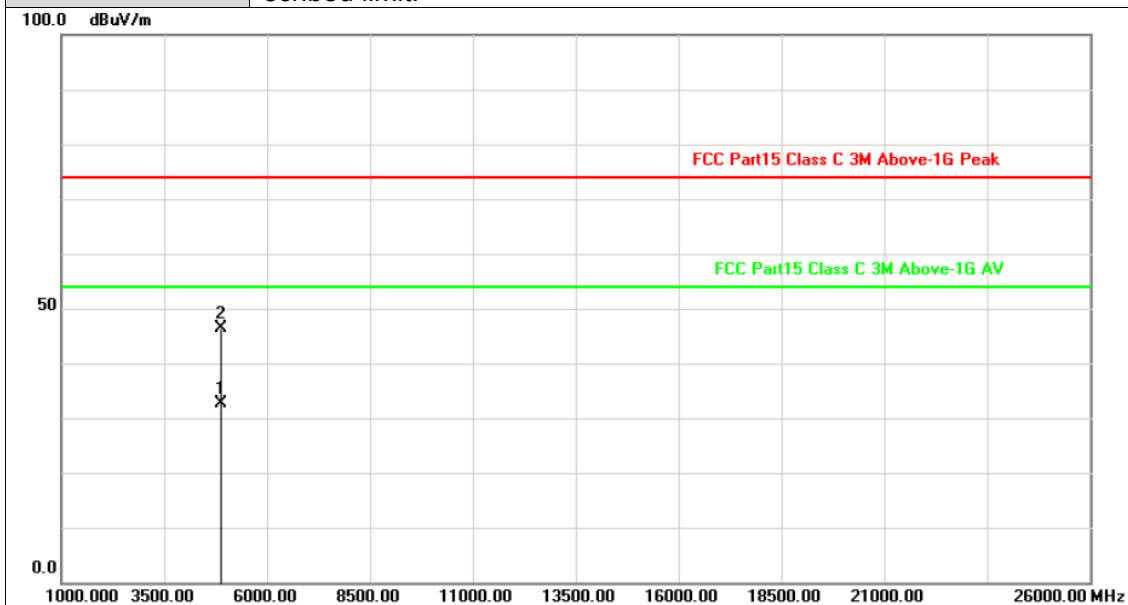

No.	Frequency (MHz)	Factor (dB/m)	Reading (dBuV)	Level (dBuV/m)	Limit (dBuV/m)	Margin (dB)	Detector
1	4881.160	-2.60	35.12	32.52	54.00	-21.48	AVG
2	4882.647	-2.59	48.99	46.40	74.00	-27.60	peak

Remarks:  
 1. Factor (dB/m) = Antenna Factor (dB/m)+Cable Factor (dB)-Pre-amplifier Factor  
 2. Margin value = Level -Limit value



<b>Ant. Pol.</b>	Vertical
<b>Test Mode:</b>	TX 8-DPSK Mode 2441MHz
<b>Remark:</b>	No report for the emission which more than 10 dB below the pre-scribed limit.

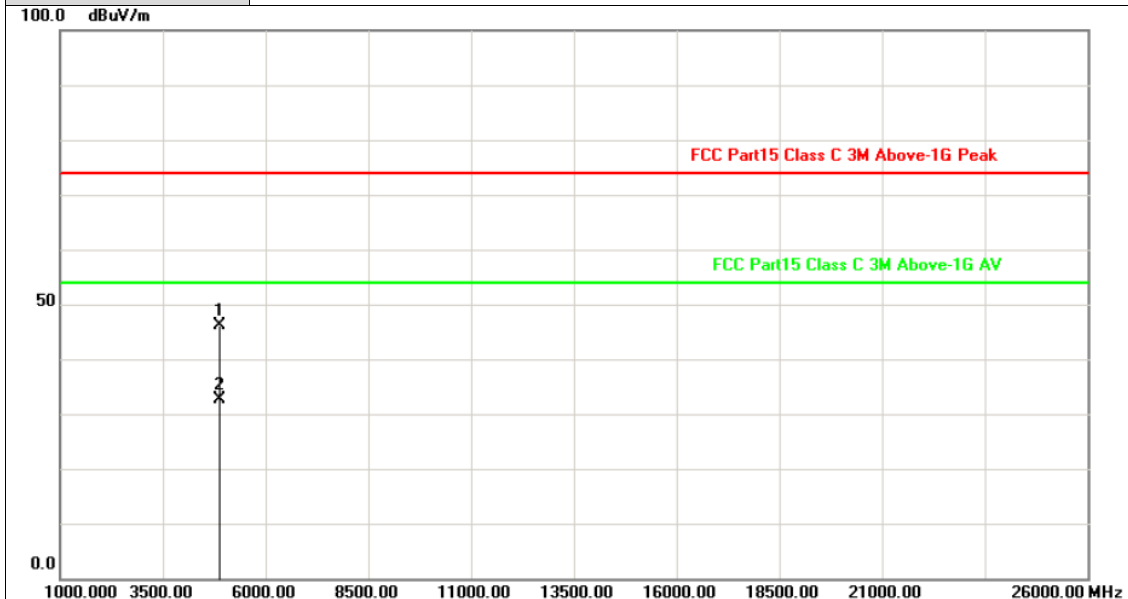

No.	Frequency (MHz)	Factor (dB/m)	Reading (dBuV)	Level (dBuV/m)	Limit (dBuV/m)	Margin (dB)	Detector
1	4882.001	-2.60	48.76	46.16	74.00	-27.84	peak
2	4882.001	-2.60	35.21	32.61	54.00	-21.39	AVG

Remarks:  
 1. Factor (dB/m) = Antenna Factor (dB/m)+Cable Factor (dB)-Pre-amplifier Factor  
 2. Margin value = Level -Limit value



<b>Ant. Pol.</b>	Horizontal
<b>Test Mode:</b>	TX 8-DPSK Mode 2480MHz
<b>Remark:</b>	No report for the emission which more than 10 dB below the pre-scribed limit.

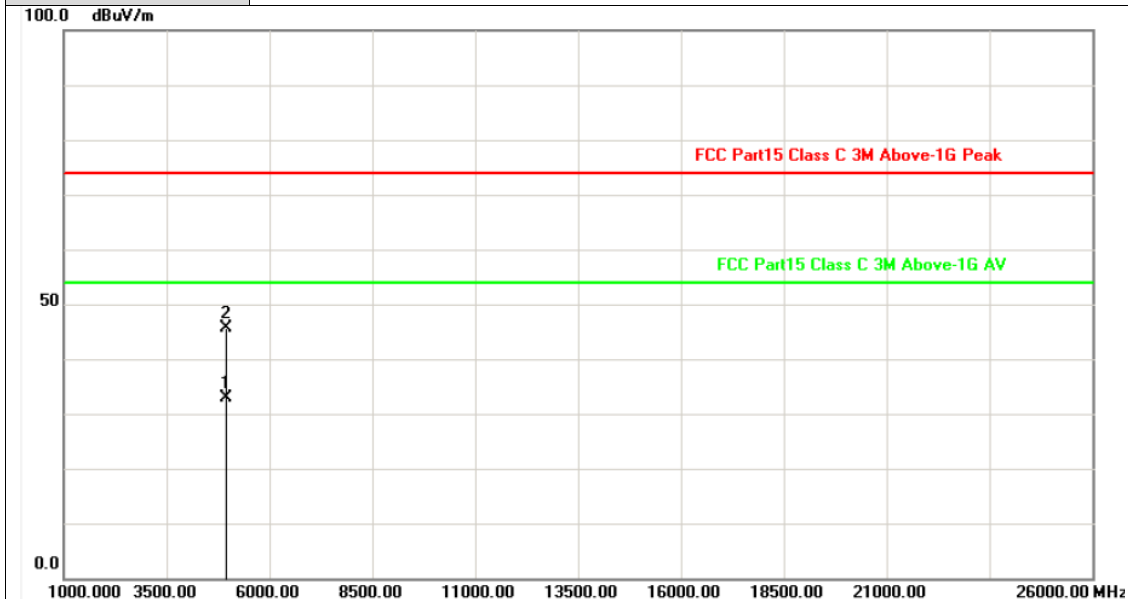

No.	Frequency (MHz)	Factor (dB/m)	Reading (dBuV)	Level (dBuV/m)	Limit (dBuV/m)	Margin (dB)	Detector
1	4959.449	-2.38	35.17	32.79	54.00	-21.21	AVG
2	4960.314	-2.38	48.11	45.73	74.00	-28.27	peak

Remarks:  
 1. Factor (dB/m) = Antenna Factor (dB/m)+Cable Factor (dB)-Pre-amplifier Factor  
 2. Margin value = Level -Limit value



<b>Ant. Pol.</b>	Vertical
<b>Test Mode:</b>	TX 8-DPSK Mode 2480MHz
<b>Remark:</b>	No report for the emission which more than 10 dB below the pre-scribed limit.

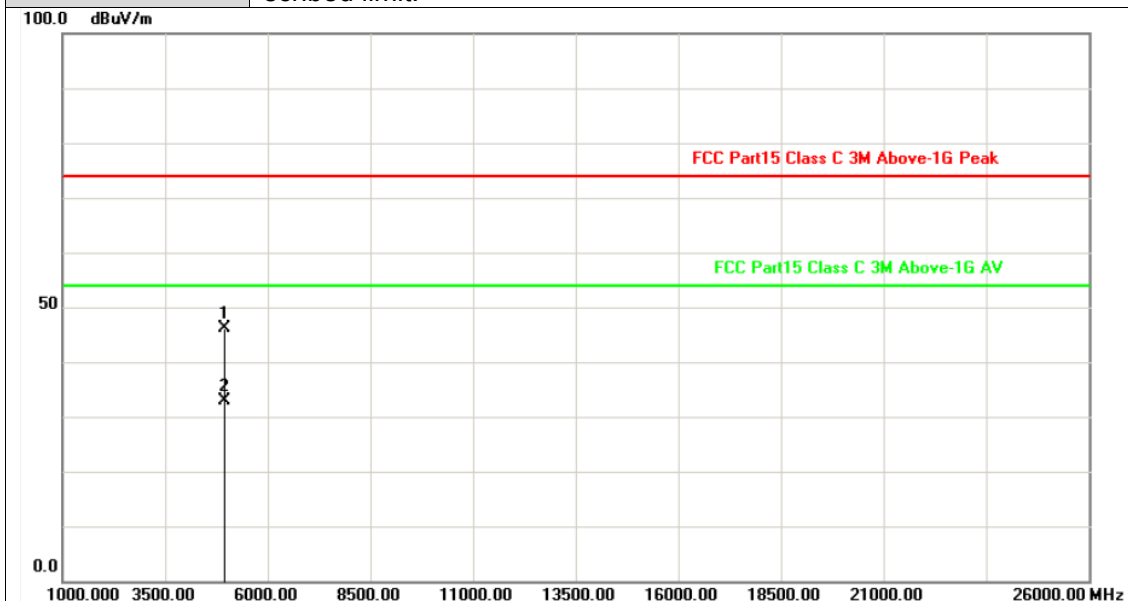

No.	Frequency (MHz)	Factor (dB/m)	Reading (dBuV)	Level (dBuV/m)	Limit (dBuV/m)	Margin (dB)	Detector
1	4959.999	-2.38	48.51	46.13	74.00	-27.87	peak
2	4960.001	-2.38	35.16	32.78	54.00	-21.22	AVG

Remarks:  
 1. Factor (dB/m) = Antenna Factor (dB/m)+Cable Factor (dB)-Pre-amplifier Factor  
 2. Margin value = Level -Limit value

### 3.3. Band Edge Emissions (Radiated)

**Limit**

FCC CFR Title 47 Part 15 Subpart C Section 15.247 (d):

Restricted Frequency Band (MHz)	(dBuV/m)(at 3m)	
	Peak	Average
2310 ~ 2390	74	54
2483.5 ~ 2500	74	54

**Test Configuration**

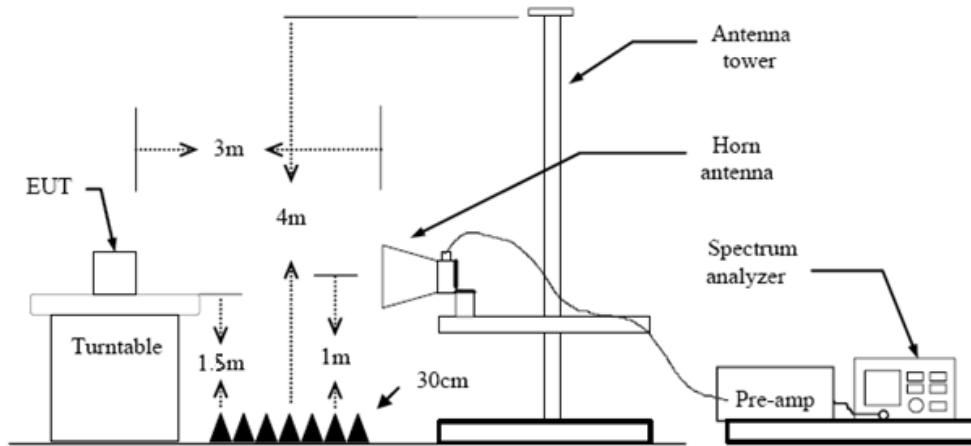

**Test Procedure**

1. The EUT was setup and tested according to ANSI C63.10:2013 requirements.
2. The EUT is placed on a turn table which is 1.5 meter above ground. The turn table is rotated 360 degrees to determine the position of the maximum emission level.
3. The EUT was positioned such that the distance from antenna to the EUT was 3 meters.
4. The antenna is scanned from 1 meter to 4 meters to find out the maximum emission level. This is repeated for both horizontal and vertical polarization of the antenna. In order to find the maximum emission, all of the interface cables were manipulated according to ANSI C63.10:2013 on radiated measurement.
5. The receiver set as follow:  
 RBW=1MHz, VBW=3MHz Peak detector for Peak value.  
 RBW=1MHz, VBW see note 1 with Peak Detector for Average Value.

Note 1: For measurements above 1 GHz the resolution bandwidth is set to 1 MHz, then the video bandwidth is set to 3 MHz for peak measurements and 1 MHz resolution bandwidth with 1/T video bandwidth with peak detector for average measurements. For the Duty Cycle please refer to clause 3.9 Duty Cycle.

**Test Mode**

Please refer to the clause 2.4.



Test Results

Ant. Pol.	Horizontal
Test Mode:	GFSK Mode 2402MHz

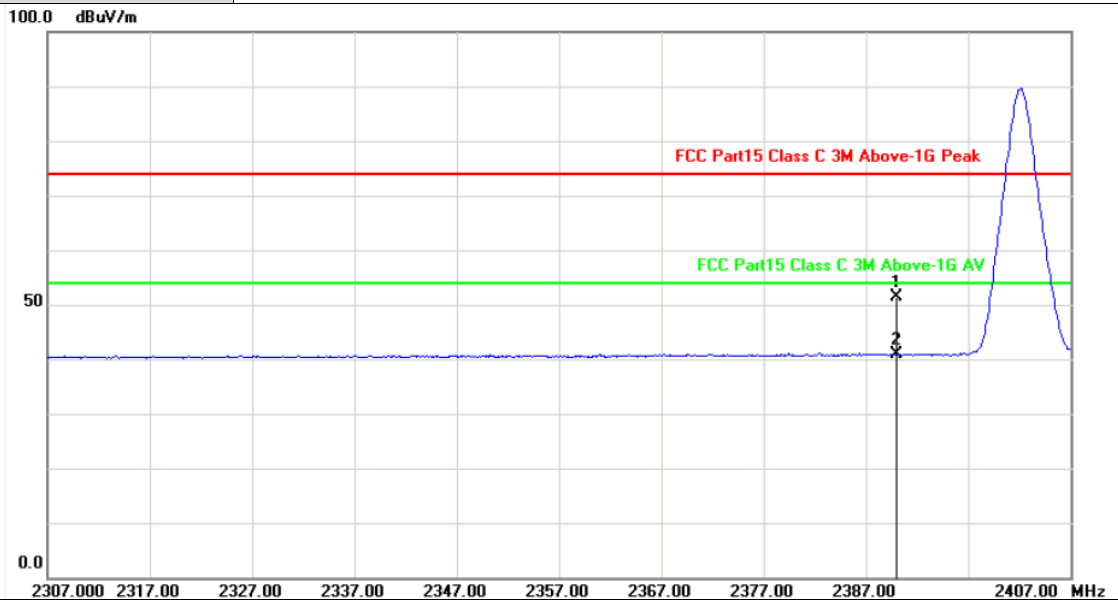

No.	Frequency (MHz)	Factor (dB/m)	Reading (dBuV)	Level (dBuV/m)	Limit (dBuV/m)	Margin (dB)	Detector
1	2390.000	31.10	20.37	51.47	74.00	-22.53	peak
2	2390.000	31.10	9.77	40.87	54.00	-13.13	AVG

Remarks:

- 1. Factor (dB/m) = Antenna Factor (dB/m)+Cable Factor (dB)-Pre-amplifier Factor
- 2. Margin value = Level -Limit value



Ant. Pol.	Vertical
Test Mode:	GFSK Mode 2402MHz

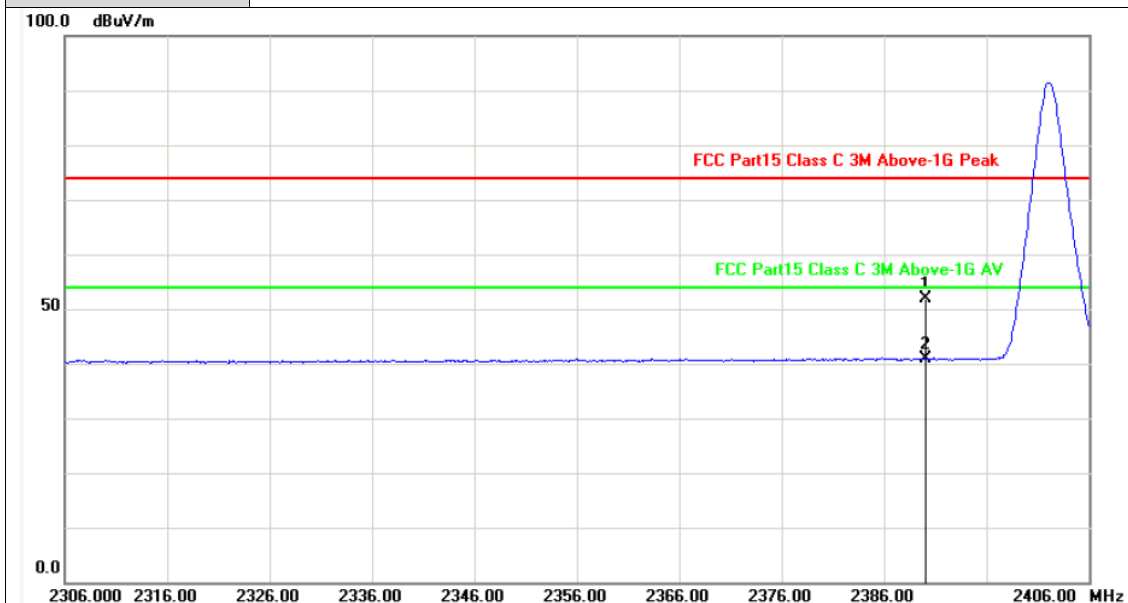

No.	Frequency (MHz)	Factor (dB/m)	Reading (dBuV)	Level (dBuV/m)	Limit (dBuV/m)	Margin (dB)	Detector
1	2390.000	31.10	20.79	51.89	74.00	-22.11	peak
2	2390.000	31.10	9.76	40.86	54.00	-13.14	AVG

Remarks:

- Factor (dB/m) = Antenna Factor (dB/m)+Cable Factor (dB)-Pre-amplifier Factor
- Margin value = Level -Limit value





<b>Ant. Pol.</b>	Horizontal
<b>Test Mode:</b>	GFSK Mode 2480 MHz

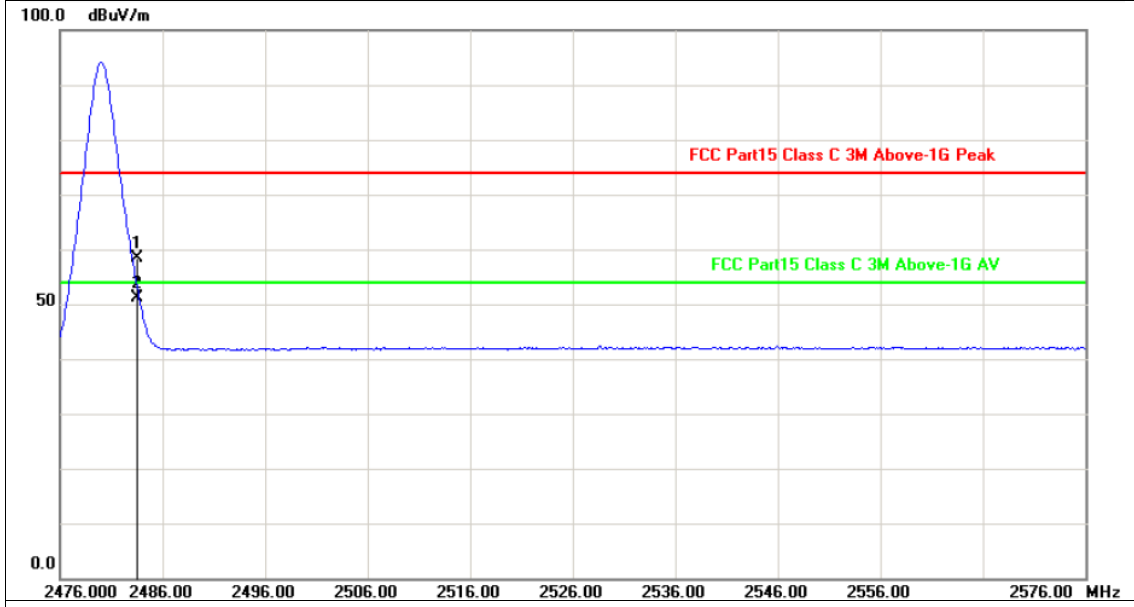

No.	Frequency (MHz)	Factor (dB/m)	Reading (dBuV)	Level (dBuV/m)	Limit (dBuV/m)	Margin (dB)	Detector
1	2483.500	31.50	26.82	58.32	74.00	-15.68	peak
2	2483.500	31.50	19.70	51.20	54.00	-2.80	AVG

Remarks:

- Factor (dB/m) = Antenna Factor (dB/m)+Cable Factor (dB)-Pre-amplifier Factor
- Margin value = Level -Limit value



<b>Ant. Pol.</b>	Vertical
<b>Test Mode:</b>	GFSK Mode 2480 MHz

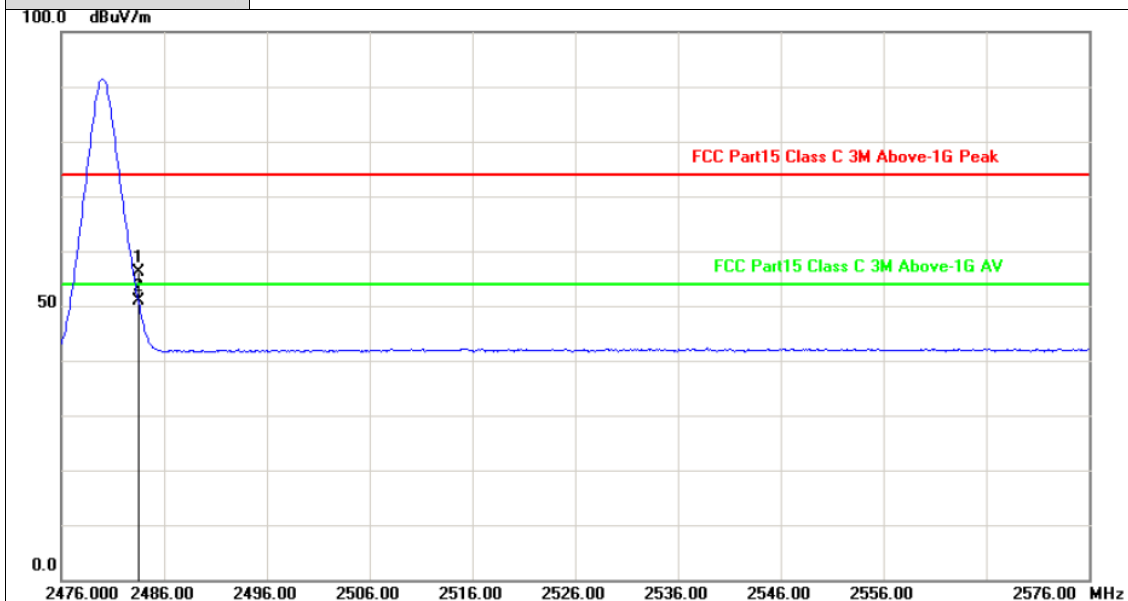

No.	Frequency (MHz)	Factor (dB/m)	Reading (dBuV)	Level (dBuV/m)	Limit (dBuV/m)	Margin (dB)	Detector
1	2483.500	31.50	24.60	56.10	74.00	-17.90	peak
2	2483.500	31.50	19.42	50.92	54.00	-3.08	AVG

Remarks:

- Factor (dB/m) = Antenna Factor (dB/m)+Cable Factor (dB)-Pre-amplifier Factor
- Margin value = Level -Limit value



<b>Ant. Pol.</b>	Horizontal
<b>Test Mode:</b>	$\pi/4$ -DQPSK Mode 2402MHz

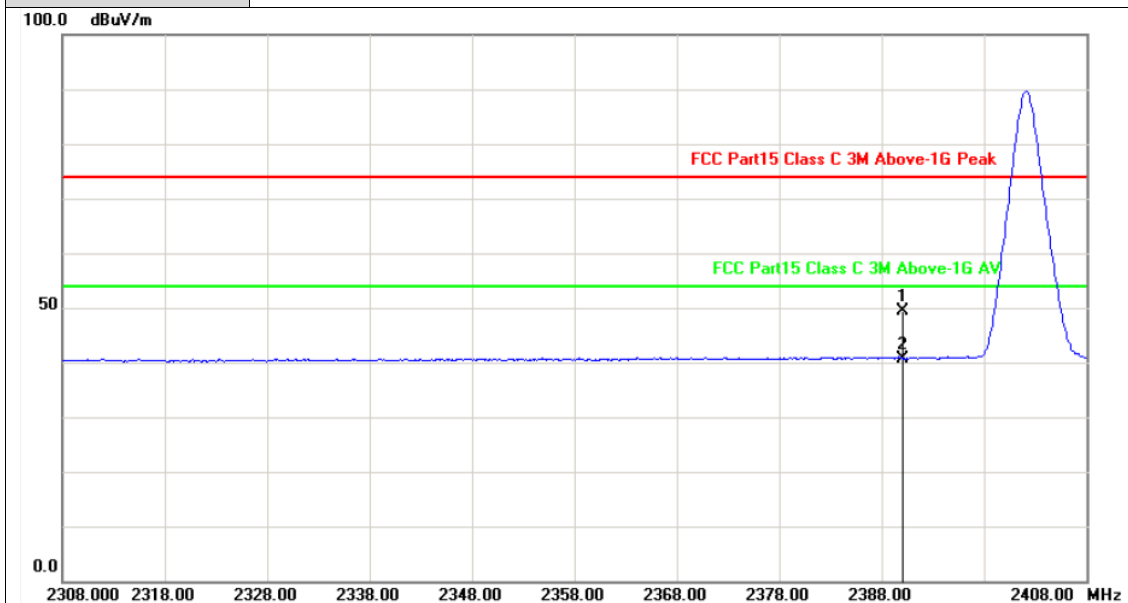

No.	Frequency (MHz)	Factor (dB/m)	Reading (dBuV)	Level (dBuV/m)	Limit (dBuV/m)	Margin (dB)	Detector
1	2390.000	31.10	18.33	49.43	74.00	-24.57	peak
2	2390.000	31.10	9.60	40.70	54.00	-13.30	AVG

Remarks:

- 1.Factor (dB/m) = Antenna Factor (dB/m)+Cable Factor (dB)-Pre-amplifier Factor
- 2.Margin value = Level -Limit value



<b>Ant. Pol.</b>	Vertical
<b>Test Mode:</b>	$\pi/4$ -DQPSK Mode 2402MHz

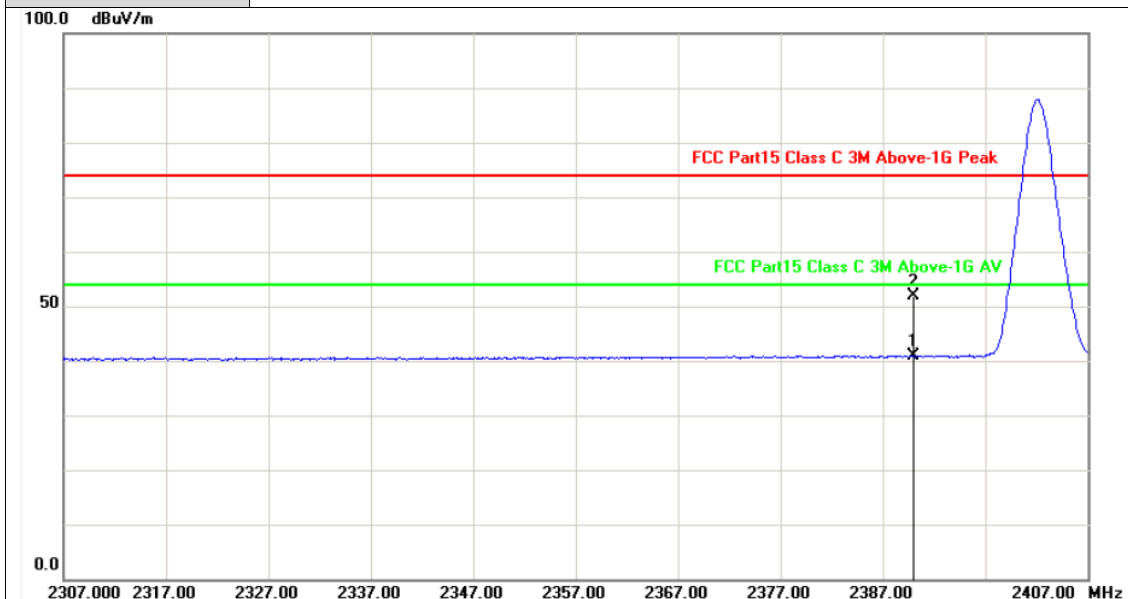

No.	Frequency (MHz)	Factor (dB/m)	Reading (dBuV)	Level (dBuV/m)	Limit (dBuV/m)	Margin (dB)	Detector
1	2390.000	31.10	9.89	40.99	54.00	-13.01	AVG
2	2390.000	31.10	20.69	51.79	74.00	-22.21	peak

Remarks:  
 1. Factor (dB/m) = Antenna Factor (dB/m)+Cable Factor (dB)-Pre-amplifier Factor  
 2. Margin value = Level -Limit value



Ant. Pol.	Horizontal
Test Mode:	$\pi/4$ -DQPSK Mode 2480MHz

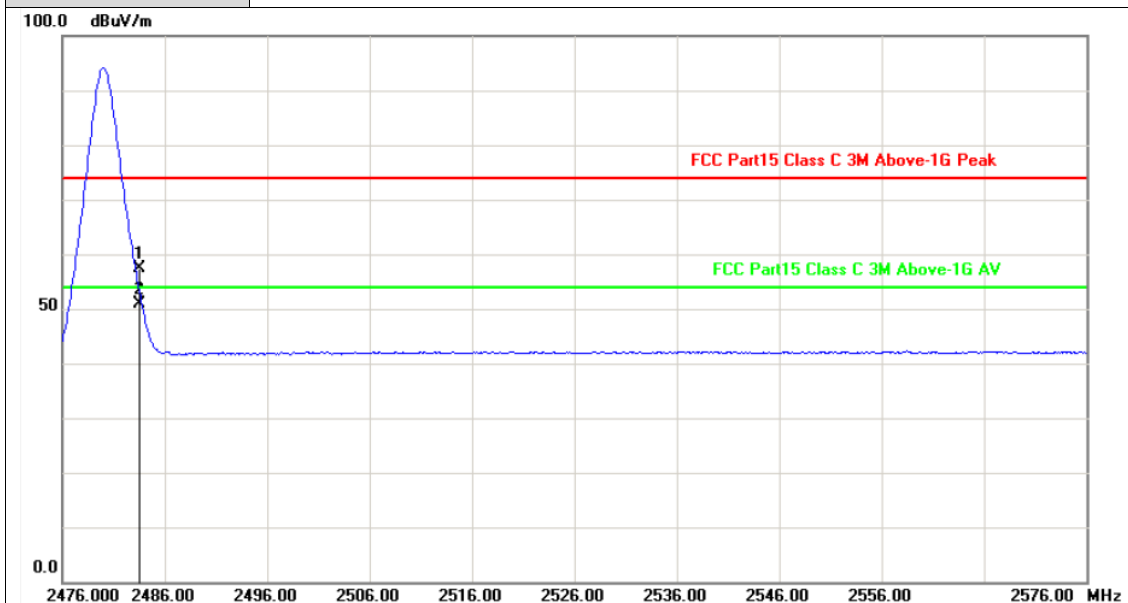

No.	Frequency (MHz)	Factor (dB/m)	Reading (dBuV)	Level (dBuV/m)	Limit (dBuV/m)	Margin (dB)	Detector
1	2483.500	31.50	25.94	57.44	74.00	-16.56	peak
2	2483.500	31.50	19.30	50.80	54.00	-3.20	AVG

Remarks:

- Factor (dB/m) = Antenna Factor (dB/m)+Cable Factor (dB)-Pre-amplifier Factor
- Margin value = Level -Limit value



Ant. Pol.	Vertical
Test Mode:	$\pi/4$ -DQPSK Mode 2480MHz

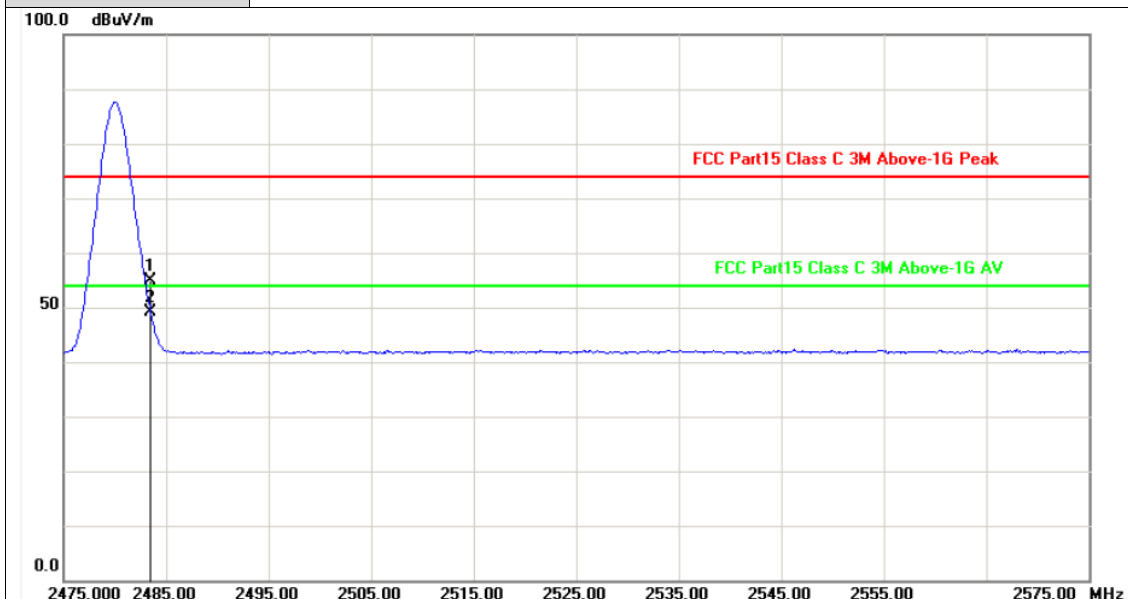

No.	Frequency (MHz)	Factor (dB/m)	Reading (dBuV)	Level (dBuV/m)	Limit (dBuV/m)	Margin (dB)	Detector
1	2483.500	31.50	23.27	54.77	74.00	-19.23	peak
2	2483.500	31.50	17.58	49.08	54.00	-4.92	AVG

Remarks:

- Factor (dB/m) = Antenna Factor (dB/m)+Cable Factor (dB)-Pre-amplifier Factor
- Margin value = Level -Limit value



<b>Ant. Pol.</b>	Horizontal
<b>Test Mode:</b>	8-DPSK Mode 2402MHz

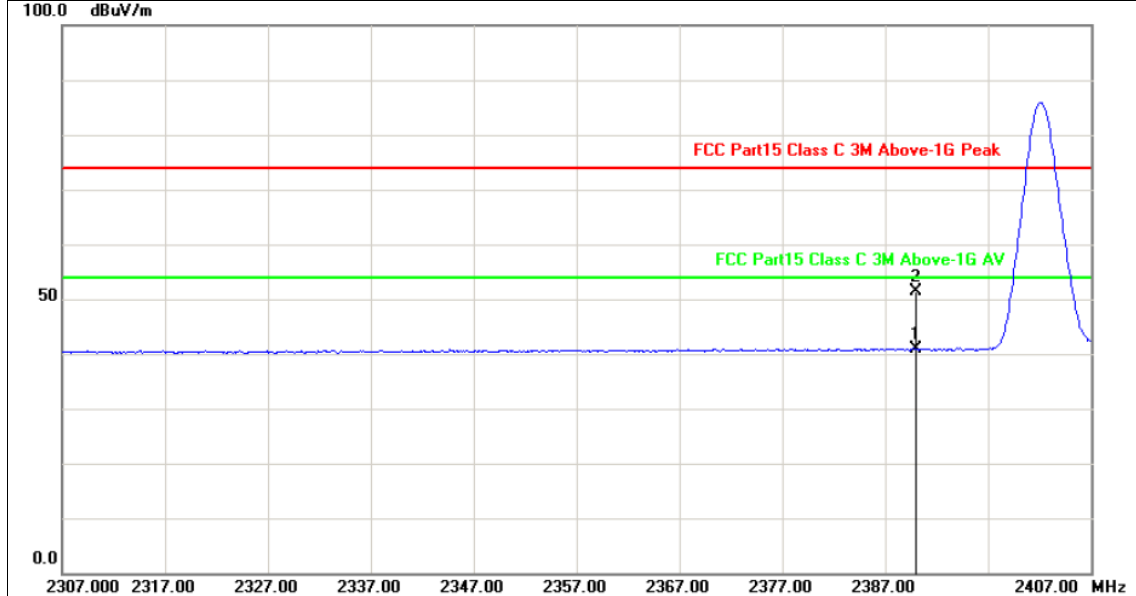

No.	Frequency (MHz)	Factor (dB/m)	Reading (dBuV)	Level (dBuV/m)	Limit (dBuV/m)	Margin (dB)	Detector
1	2390.000	31.10	9.78	40.88	54.00	-13.12	AVG
2	2390.000	31.10	20.37	51.47	74.00	-22.53	peak

Remarks:  
 1. Factor (dB/m) = Antenna Factor (dB/m)+Cable Factor (dB)-Pre-amplifier Factor  
 2. Margin value = Level -Limit value



<b>Ant. Pol.</b>	Vertical
<b>Test Mode:</b>	8-DPSK Mode 2402MHz

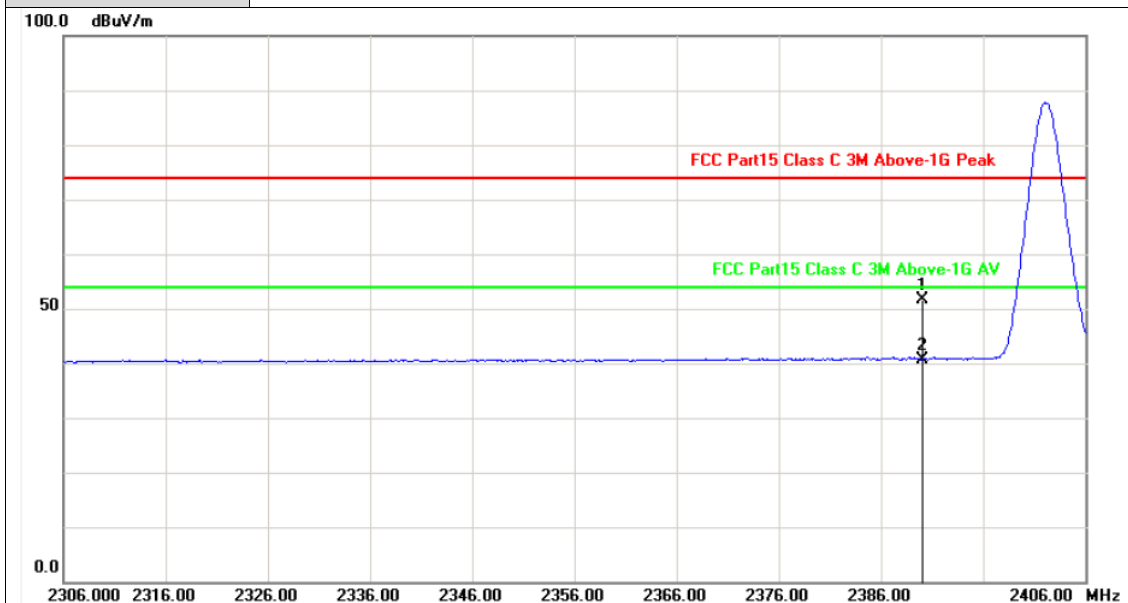

No.	Frequency (MHz)	Factor (dB/m)	Reading (dBuV)	Level (dBuV/m)	Limit (dBuV/m)	Margin (dB)	Detector
1	2390.000	31.10	20.57	51.67	74.00	-22.33	peak
2	2390.000	31.10	9.62	40.72	54.00	-13.28	AVG

Remarks:

- Factor (dB/m) = Antenna Factor (dB/m)+Cable Factor (dB)-Pre-amplifier Factor
- Margin value = Level -Limit value





Ant. Pol.	Horizontal
Test Mode:	8-DPSK Mode 2480MHz

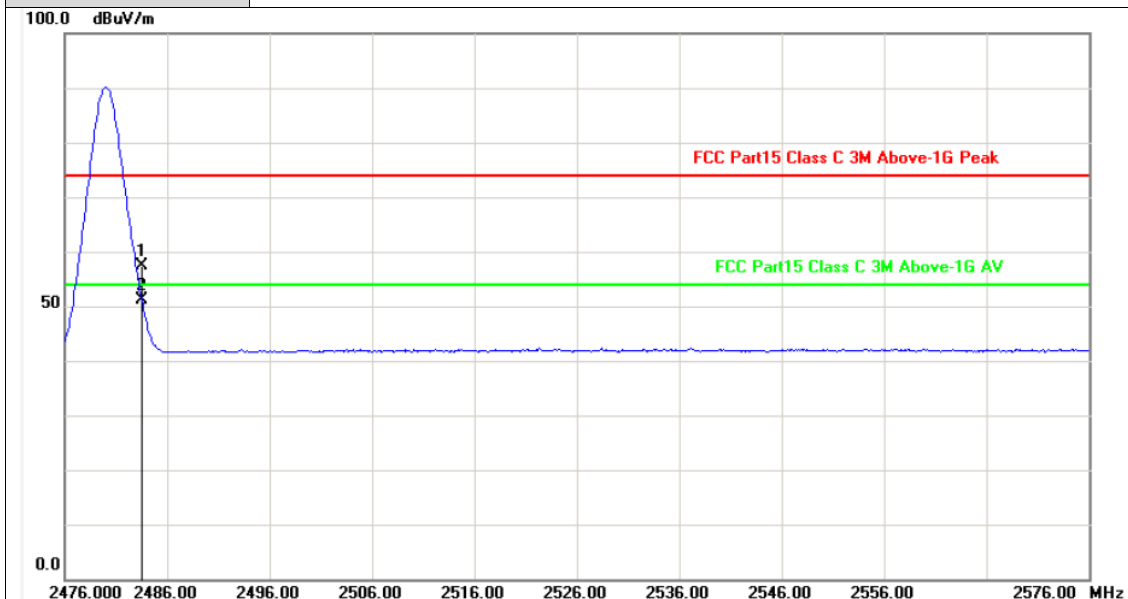

No.	Frequency (MHz)	Factor (dB/m)	Reading (dBuV)	Level (dBuV/m)	Limit (dBuV/m)	Margin (dB)	Detector
1	2483.500	31.50	25.93	57.43	74.00	-16.57	peak
2	2483.500	31.50	19.75	51.25	54.00	-2.75	AVG

Remarks:

- Factor (dB/m) = Antenna Factor (dB/m)+Cable Factor (dB)-Pre-amplifier Factor
- Margin value = Level -Limit value



<b>Ant. Pol.</b>	Vertical
<b>Test Mode:</b>	8-DPSK Mode 2480MHz

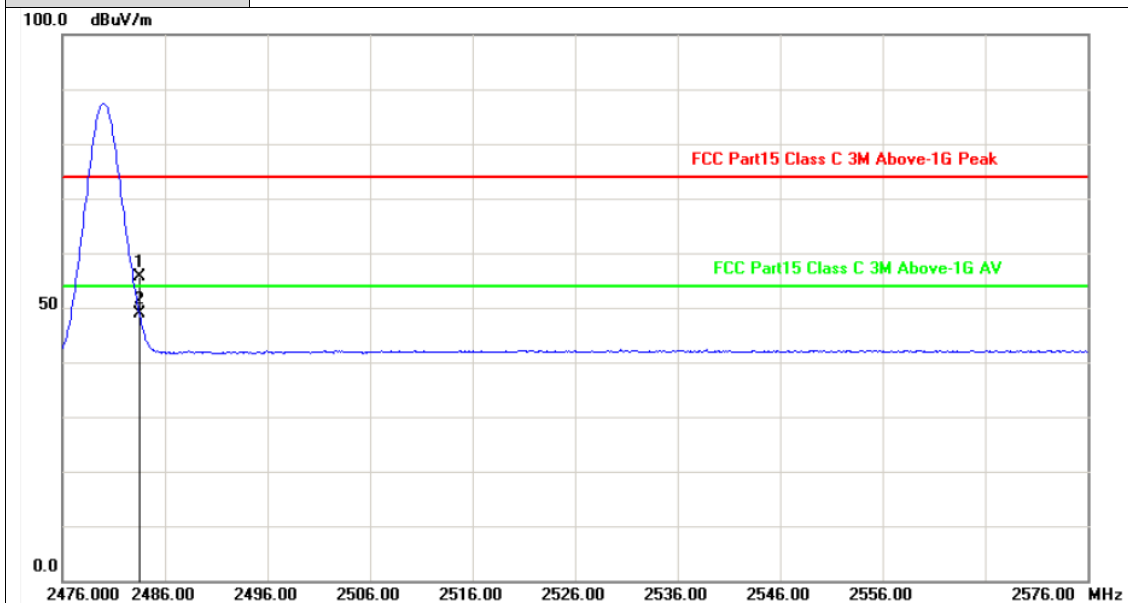

No.	Frequency (MHz)	Factor (dB/m)	Reading (dBuV)	Level (dBuV/m)	Limit (dBuV/m)	Margin (dB)	Detector
1	2483.500	31.50	24.09	55.59	74.00	-18.41	peak
2	2483.500	31.50	17.26	48.76	54.00	-5.24	AVG

Remarks:

- Factor (dB/m) = Antenna Factor (dB/m)+Cable Factor (dB)-Pre-amplifier Factor
- Margin value = Level -Limit value



### 3.4. Band edge and Spurious Emissions (Conducted)

#### Limit

FCC CFR Title 47 Part 15 Subpart C Section 15.247 (d): In any 100 kHz bandwidth outside the frequency band in which the spread spectrum intentional radiator is operating, the radio frequency power that is produced by the intentional radiator shall be at least 20 dB below that in the 100 kHz bandwidth within the band that contains the highest level of the desired power, based on either an RF conducted or a radiated measurement.

#### Test Configuration

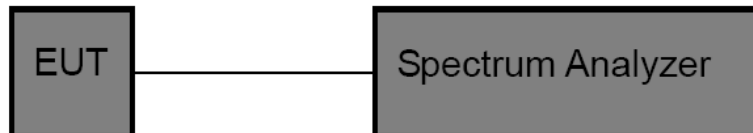

#### Test Procedure

1. The transmitter output was connected to the spectrum analyzer through an attenuator, the path loss was compensated to the results for each measurement.
2. Set to the maximum power setting and enable the EUT transmit continuously
3. Use the following spectrum analyzer settings:  
RBW = 100 kHz, VBW  $\geq$  RBW, scan up through 10<sup>th</sup> harmonic.  
Sweep = auto, Detector function = peak, Trace = max hold
4. Measure and record the results in the test report.

#### Test Mode

Please refer to the clause 2.4.

#### Test Results

##### (1) Band edge Conducted Test

Test Mode	ChName	Channel	RefLevel [dBm]	Result [dBm]	Limit [dBm]	Verdict
GFSK	Low	2402	2.75	-53.05	$\leq -17.25$	PASS
	High	2480	2.96	-52.58	$\leq -17.04$	PASS
	Low	Hop_2402	2.13	-52.12	-17.87	PASS
	High	Hop_2480	2.58	-52.33	-17.42	PASS
$\pi$ / 4-DQPSK	Low	2402	0.74	-52.08	$\leq -19.26$	PASS
	High	2480	0.42	-52.19	$\leq -19.58$	PASS
	Low	Hop_2402	-0.94	-53	-20.94	PASS
	High	Hop_2480	0.91	-52.28	-19.09	PASS
8-DPSK	Low	2402	1.14	-52.39	$\leq -18.86$	PASS
	High	2480	1.10	-52.79	$\leq -18.9$	PASS
	Low	Hop_2402	-2.57	-52.8	-22.57	PASS
	High	Hop_2480	1.31	-51.83	-18.69	PASS



### DH5\_Low\_2402

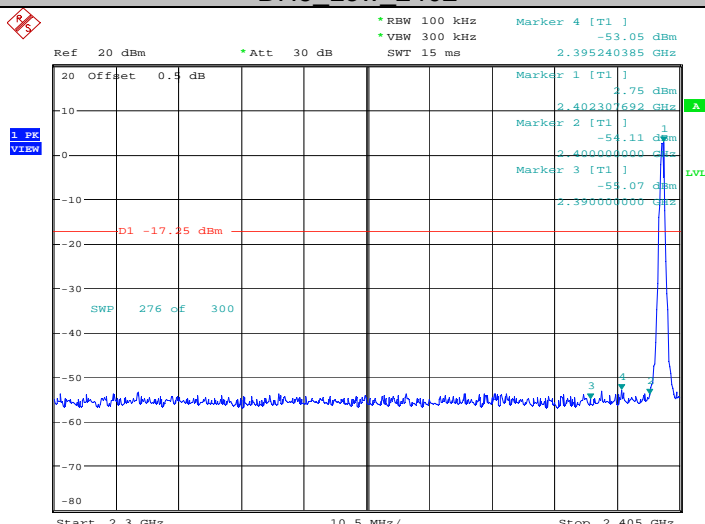

Date: 4.DEC.2020 14:24:08

### DH5\_High\_2480

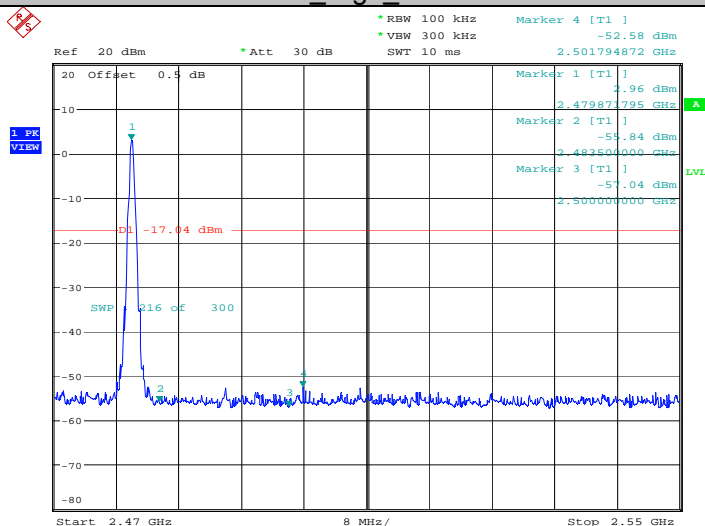

Date: 4.DEC.2020 14:59:09

### DH5\_Low\_Hop\_2402

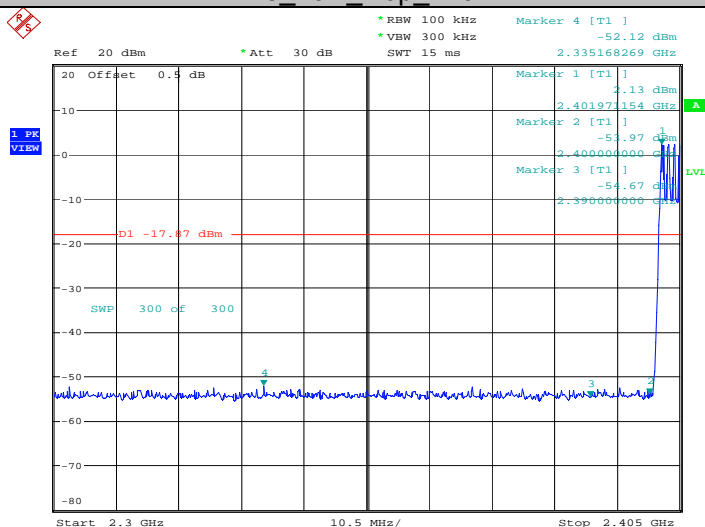

Date: 5.DEC.2020 10:26:40

### DH5\_High\_Hop\_2480

CTC Laboratories, Inc.

1-2/F., Building 2, Jiaquan Building, Guanlan High-Tech Park, Shenzhen, Guangdong, China

Tel.: (86)755-27521059

Fax: (86)755-27521011

Http://www.sz-ctc.org.cn



For anti-fake verification, please visit the official website of Certification and Accreditation Administration of the People's Republic of China : [yz.cnca.cn](http://yz.cnca.cn)

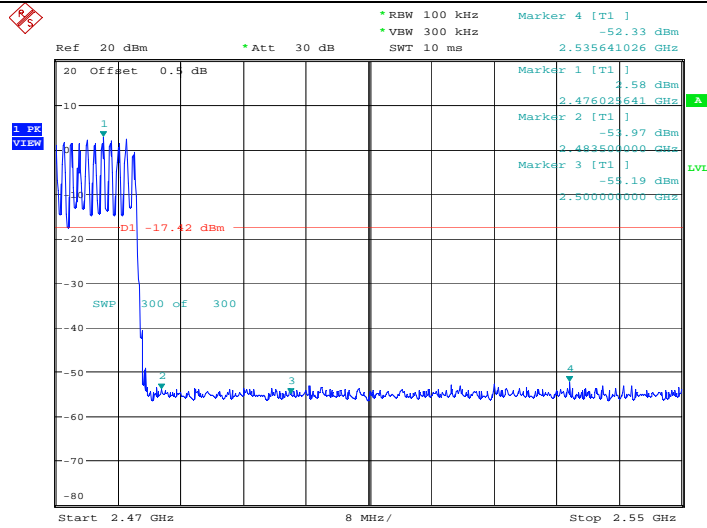

Date: 5.DEC.2020 10:51:31

### 2DH5 Low 2402

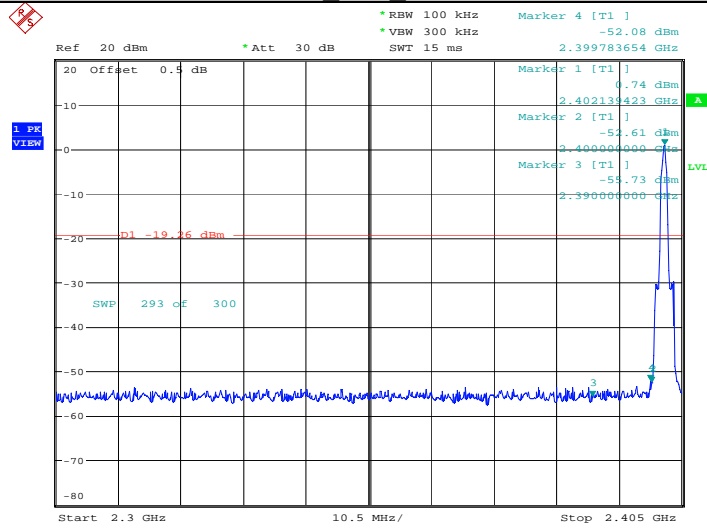

Date: 5.DEC.2020 09:59:15

### 2DH5 High 2480

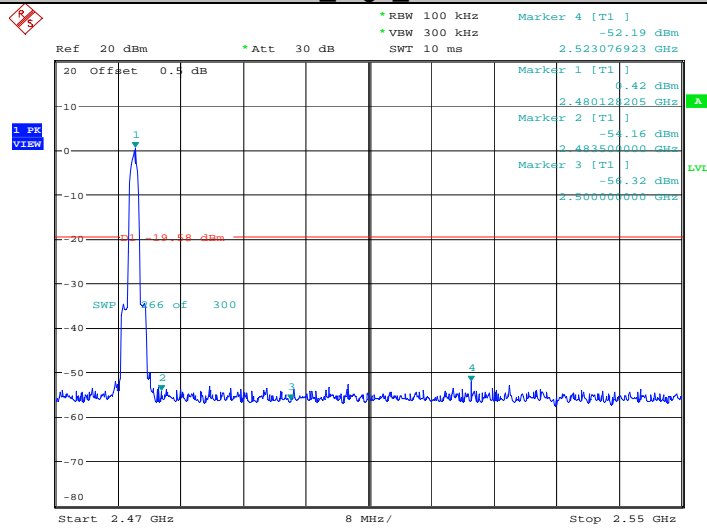

Date: 5.DEC.2020 10:07:23

### 2DH5 Low Hop 2402

CTC Laboratories, Inc.

1-2/F., Building 2, Jiaquan Building, Guanlan High-Tech Park, Shenzhen, Guangdong, China

Tel.: (86)755-27521059

Fax: (86)755-27521011

Http://www.sz-ctc.org.cn



For anti-fake verification, please visit the official website of Certification and Accreditation Administration of the People's Republic of China : [yz.cnca.cn](http://yz.cnca.cn)

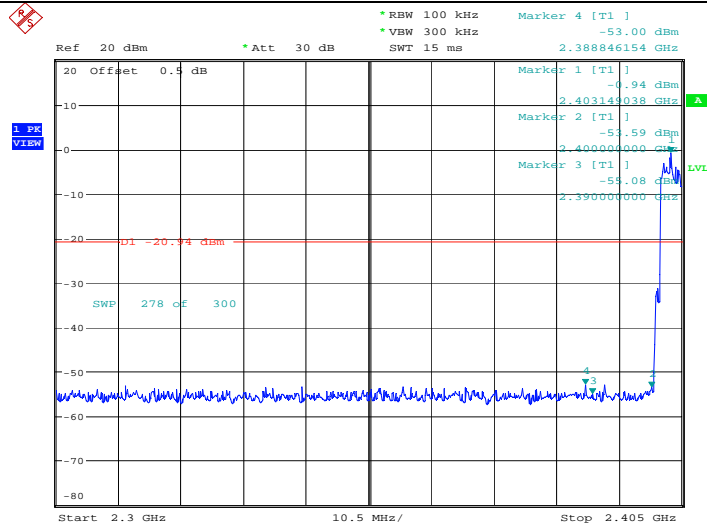

Date: 5.DEC.2020 10:58:42

### 2DH5\_High\_Hop\_2480

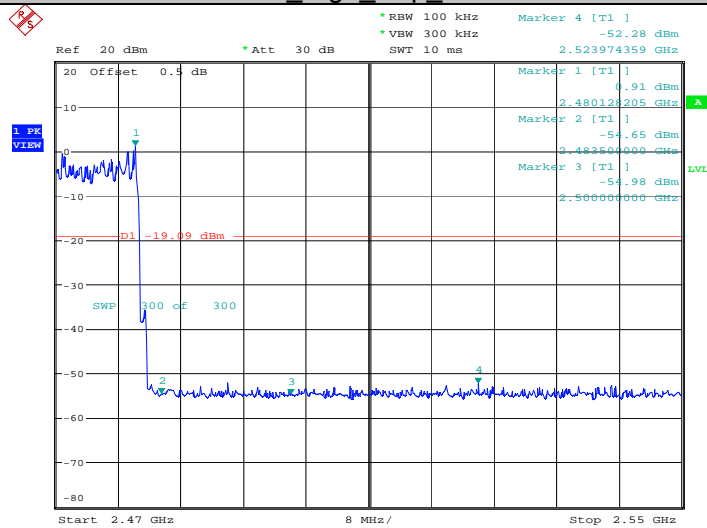

Date: 5.DEC.2020 11:17:59

### 3DH5\_Low\_2402

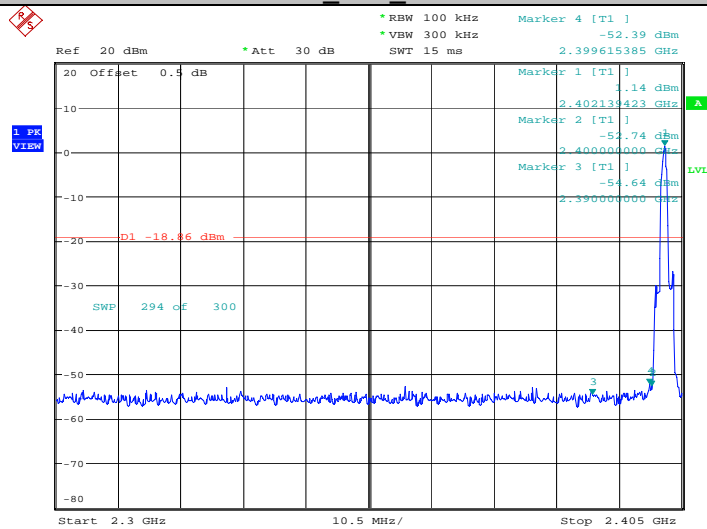

Date: 5.DEC.2020 10:13:08

### 3DH5\_High\_2480

CTC Laboratories, Inc.

1-2/F., Building 2, Jiaquan Building, Guanlan High-Tech Park, Shenzhen, Guangdong, China  
 Tel.: (86)755-27521059 Fax: (86)755-27521011 Http://www.sz-ctc.org.cn



For anti-fake verification, please visit the official website of Certification and Accreditation Administration of the People's Republic of China : [yz.cnca.cn](http://yz.cnca.cn)

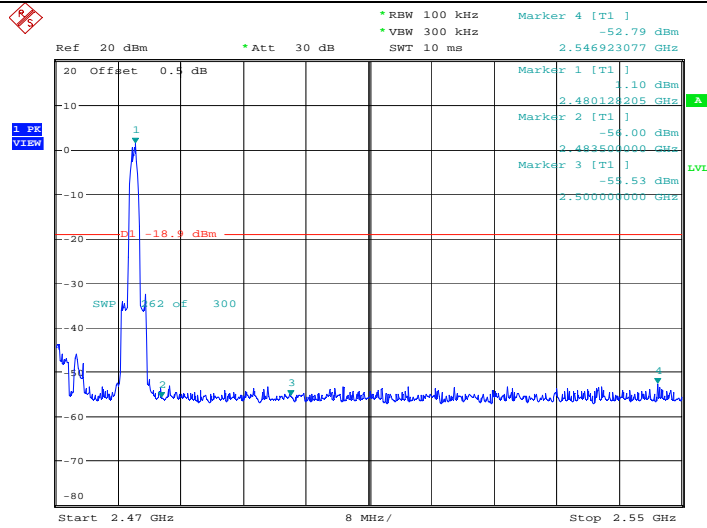

Date: 5.DEC.2020 10:21:16

### 3DH5\_Low\_Hop\_2402

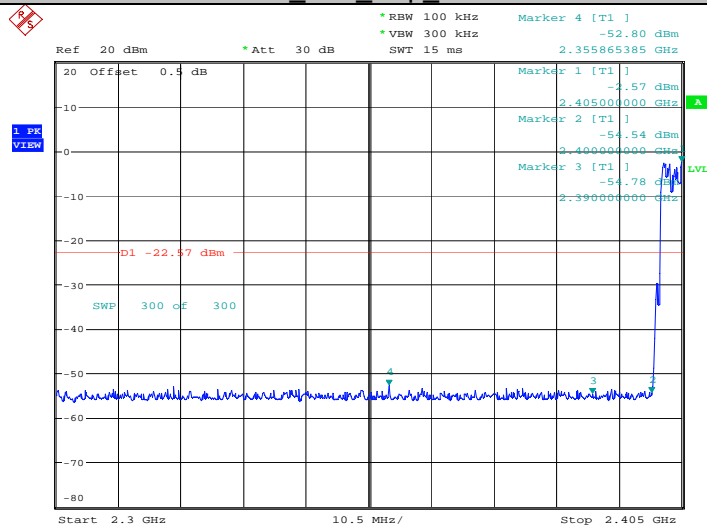

Date: 5.DEC.2020 13:01:33

### 3DH5\_High\_Hop\_2480

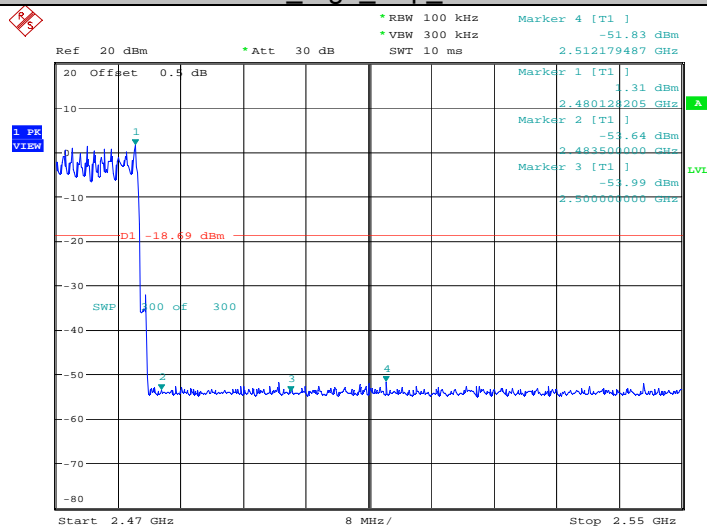

Date: 5.DEC.2020 13:41:47

CTC Laboratories, Inc.

1-2/F., Building 2, Jiaquan Building, Guanlan High-Tech Park, Shenzhen, Guangdong, China  
Tel.: (86)755-27521059 Fax: (86)755-27521011 Http://www.sz-ctc.org.cn



For anti-fake verification, please visit the official website of Certification and Accreditation Administration of the People's Republic of China : [yz.cnca.cn](http://yz.cnca.cn)



## (2) Conducted Spurious Emissions Test

Test Mode	Channel	FreqRange [MHz]	RefLevel [dBm]	Result [dBm]	Limit [dBm]	Verdict
GFSK	2402	Reference	2.78	2.78	---	PASS
		30~1000	30~1000	-53.56	<=-17.22	PASS
		1000~26500	1000~26500	-18.81	<=-17.22	PASS
	2441	Reference	0.26	0.26	---	PASS
		30~1000	30~1000	-55.93	<=-19.74	PASS
		1000~26500	1000~26500	-36.21	<=-19.74	PASS
	2480	Reference	3.18	3.18	---	PASS
		30~1000	30~1000	-50.04	<=-16.82	PASS
		1000~26500	1000~26500	-36.57	<=-16.82	PASS
$\pi$ / /4-DQPSK	2402	Reference	1.36	1.36	---	PASS
		30~1000	30~1000	-55.87	<=-18.64	PASS
		1000~26500	1000~26500	-18.73	<=-18.64	PASS
	2441	Reference	-0.95	-0.95	---	PASS
		30~1000	30~1000	-55.76	<=-20.95	PASS
		1000~26500	1000~26500	-37.15	<=-20.95	PASS
	2480	Reference	1.58	1.58	---	PASS
		30~1000	30~1000	-56.43	<=-18.42	PASS
		1000~26500	1000~26500	-35.6	<=-18.42	PASS
8-DPSK	2402	Reference	1.45	1.45	---	PASS
		30~1000	30~1000	-55.64	<=-18.55	PASS
		1000~26500	1000~26500	-17.82	<=-18.55	PASS
	2441	Reference	-1.01	-1.01	---	PASS
		30~1000	30~1000	-55.82	<=-21.01	PASS
		1000~26500	1000~26500	-35.58	<=-21.01	PASS
	2480	Reference	1.50	1.50	---	PASS
		30~1000	30~1000	-55.28	<=-18.5	PASS
		1000~26500	1000~26500	-36.56	<=-18.5	PASS



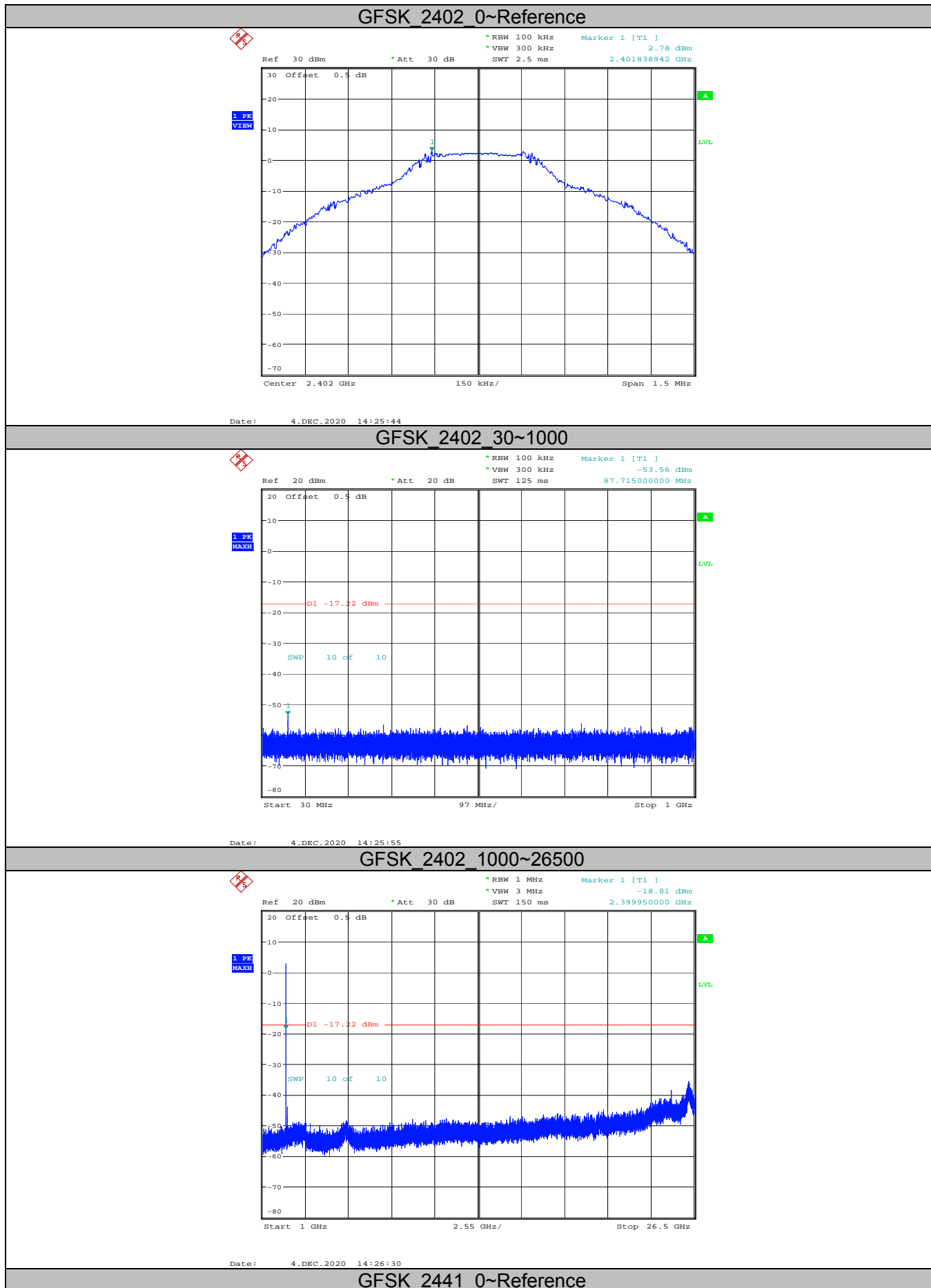

GFSK\_2441\_0~Reference

CTC Laboratories, Inc.

1-2/F., Building 2, Jiaquan Building, Guanlan High-Tech Park, Shenzhen, Guangdong, China

Tel.: (86)755-27521059

Fax: (86)755-27521011

Http://www.sz-ctc.org.cn



For anti-fake verification, please visit the official website of Certification and Accreditation Administration of the People's Republic of China : [yz.cnca.cn](http://yz.cnca.cn)

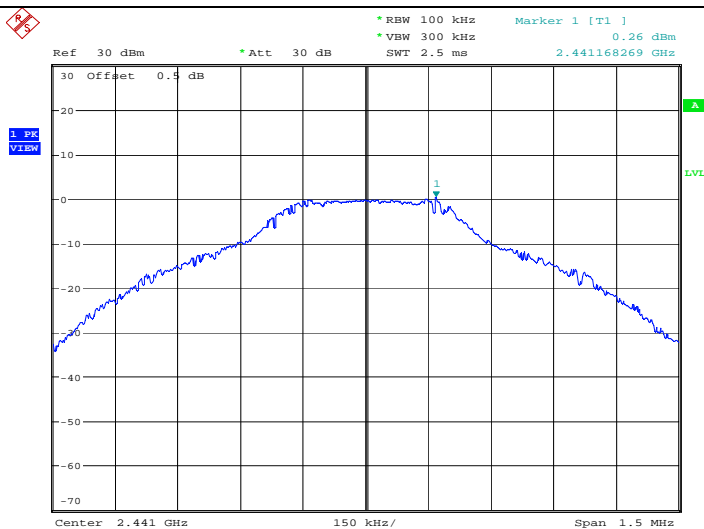

Date: 4.DEC.2020 14:55:59

### GFSK\_2441\_30~1000

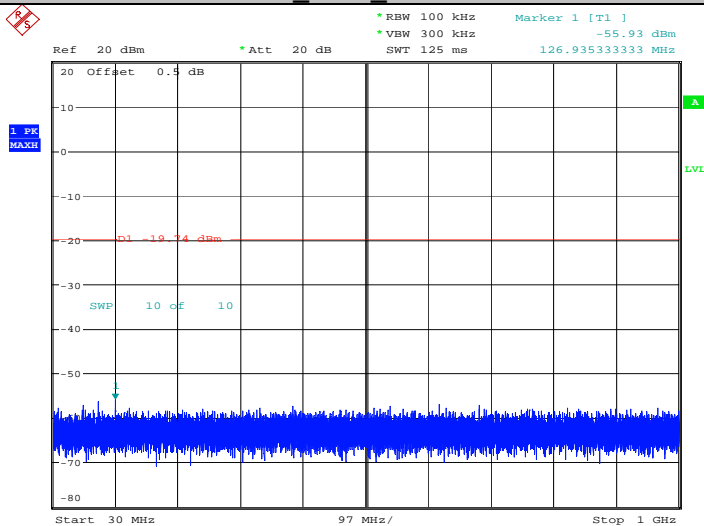

Date: 4.DEC.2020 14:56:10

### GFSK\_2441\_1000~26500

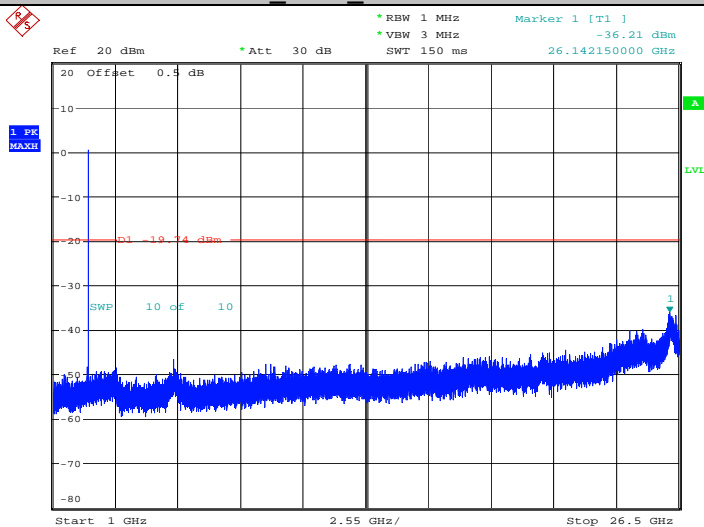

Date: 4.DEC.2020 14:56:45

### GFSK\_2480\_0~Reference

CTC Laboratories, Inc.

1-2/F., Building 2, Jiaquan Building, Guanlan High-Tech Park, Shenzhen, Guangdong, China

Tel.: (86)755-27521059

Fax: (86)755-27521011

Http://www.sz-ctc.org.cn



For anti-fake verification, please visit the official website of Certification and Accreditation Administration of the People's Republic of China : [yz.cnca.cn](http://yz.cnca.cn)

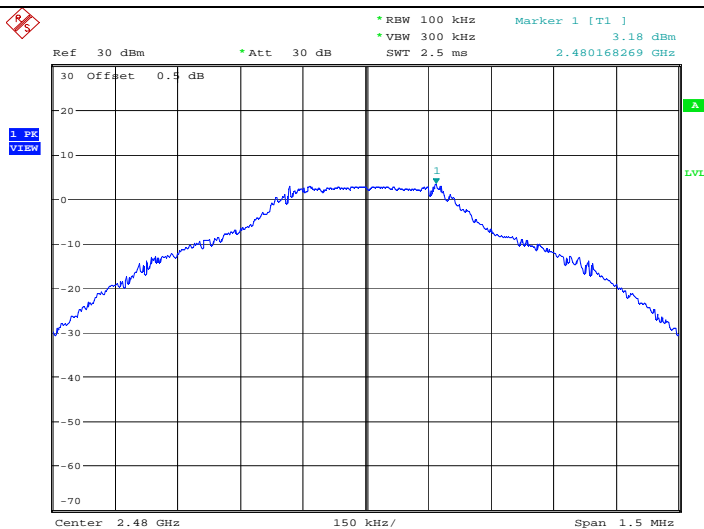

Date: 4.DEC.2020 15:00:36

### GFSK\_2480\_30~1000

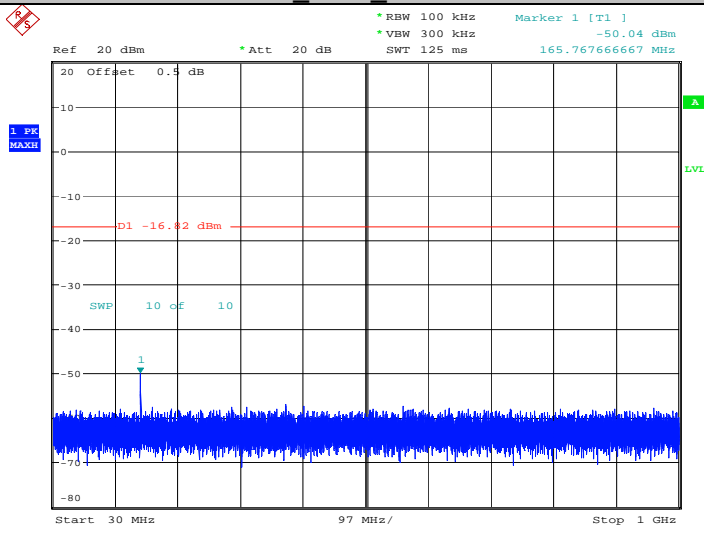

Date: 4.DEC.2020 15:00:47

### GFSK\_2480\_1000~26500

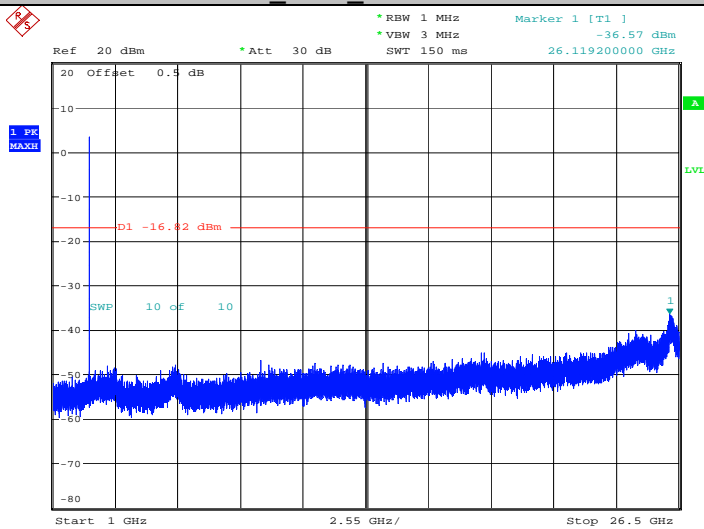

Date: 4.DEC.2020 15:01:21

### $\pi/4$ -DQPSK\_2402\_0~Reference

CTC Laboratories, Inc.

1-2/F., Building 2, Jiaquan Building, Guanlan High-Tech Park, Shenzhen, Guangdong, China  
 Tel.: (86)755-27521059    Fax: (86)755-27521011    Http://www.sz-ctc.org.cn



For anti-fake verification, please visit the official website of Certification and Accreditation Administration of the People's Republic of China : [yz.cnca.cn](http://yz.cnca.cn)

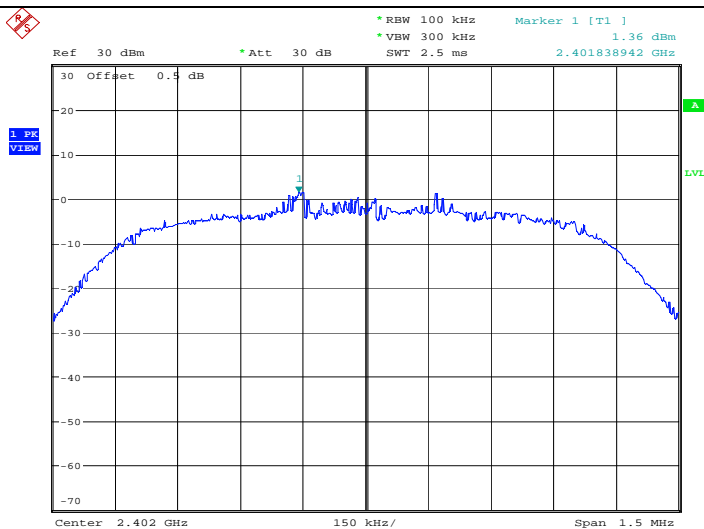

Date: 5.DEC.2020 10:00:51

π/4-DQPSK\_2402\_30~1000

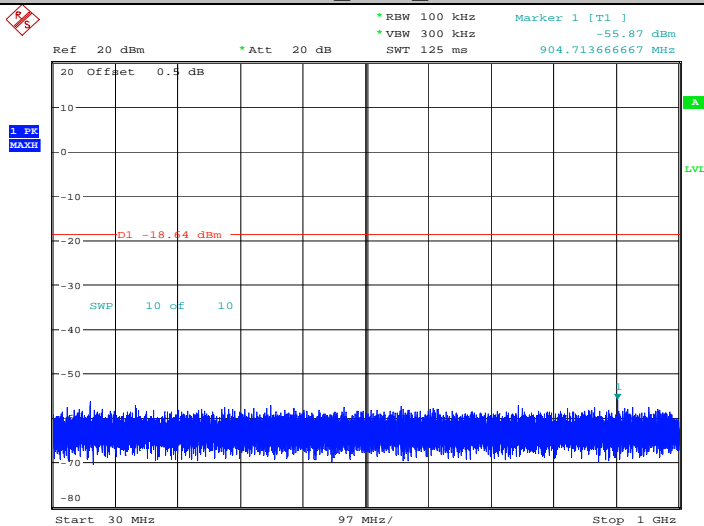

Date: 5.DEC.2020 10:01:02

π/4-DQPSK\_2402\_1000~26500

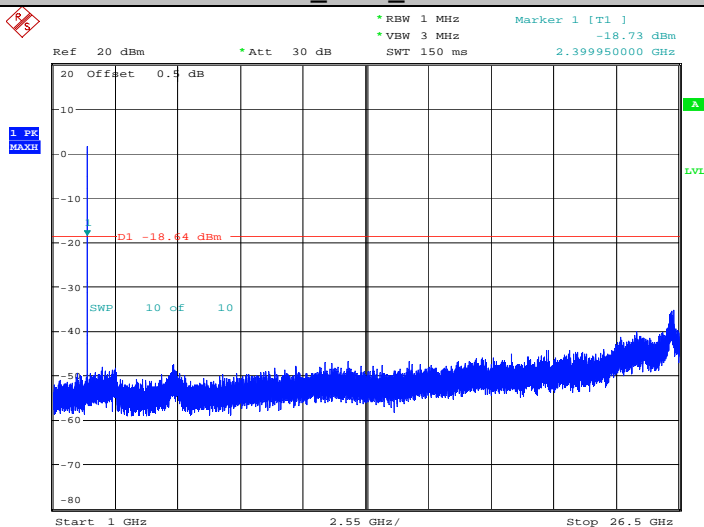

Date: 5.DEC.2020 10:01:37

π/4-DQPSK\_2441\_0~Reference

CTC Laboratories, Inc.

1-2/F., Building 2, Jiaquan Building, Guanlan High-Tech Park, Shenzhen, Guangdong, China

Tel.: (86)755-27521059

Fax: (86)755-27521011

Http://www.sz-ctc.org.cn



For anti-fake verification, please visit the official website of Certification and Accreditation Administration of the People's Republic of China : [yz.cnca.cn](http://yz.cnca.cn)