



CTC Laboratories, Inc.

1-2/F., Building 2, Jiaquan Building, Guanlan High-Tech Park, Shenzhen, Guangdong, China
Tel: +86-755- 27521059 Fax: +86-755- 27521011 Http://www.sz-ctc.org.cn

TEST REPORT

Report No.: **CTC20201784E06**

FCC ID.....: **2AYD5-M2-203**

Applicant.....: **Imin Technology Pte Ltd**

Address.....: 63 Ubi Ave 1 #07-02 63@Ubi Singapore 408937

Manufacturer.....: Imin Technology Pte Ltd

Address.....: 63 Ubi Ave 1 #07-02 63@Ubi Singapore 408937

Product Name.....: **Mobile POS**

Trade Mark.....: N/A

Model/Type reference.....: M2-203

Listed Model(s): N/A

Standard.....: **CFR47 PART 22H, 24E, 27**

Date of receipt of test sample.: Dec. 02, 2020

Date of testing.....: Dec. 03, 2020 ~ Dec. 28, 2020

Date of issue.....: Dec. 29, 2020

Result.....: **PASS**

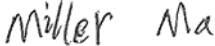
Compiled by:		
(Printed name+signature)	Terry Su	
Supervised by:		
(Printed name+signature)	Miller Ma	
Approved by:		
(Printed name+signature)	Walter Chen	

Testing Laboratory Name...: **CTC Laboratories, Inc.**

Address.....: 1-2/F., Building 2, Jiaquan Building, Guanlan High-Tech Park, Shenzhen, Guangdong, China

This test report may be duplicated completely for legal use with the approval of the applicant. It should not be reproduced except in full, without the written approval of our laboratory. The client should not use it to claim product endorsement by CTC. The test results in the report only apply to the tested sample. The test report shall be invalid without all the signatures of testing engineers, reviewer and approver. Any objections must be raised to CTC within 15 days since the date when the report is received. It will not be taken into consideration beyond this limit. The test report merely correspond to the test sample.



Table of Contents

Page

1. SUMMARY..... 3

1.1. TEST STANDARDS.....3

1.2. REPORT VERSION.....3

1.3. TEST DESCRIPTION.....4

1.4. TEST FACILITY5

1.5. MEASUREMENT UNCERTAINTY6

1.6. ENVIRONMENTAL CONDITIONS6

2. GENERAL INFORMATION..... 7

2.1. CLIENT INFORMATION7

2.2. GENERAL DESCRIPTION OF EUT8

2.3. DESCRIPTION OF TEST MODES AND TEST FREQUENCY.....9

2.4. MEASUREMENT INSTRUMENTS LIST11

3. TEST ITEM AND RESULTS..... 12

3.1. CONDUCTED OUTPUT POWER12

3.2. PEAK-TO-AVERAGE RATIO13

3.3. OCCUPY BANDWIDTH.....14

3.4. OUT OF BAND EMISSION AT ANTENNA TERMINALS.....15

3.5. BAND EDGE COMPLIANCE16

3.6. RADIATED POWER MEASUREMENT18

3.7. RADIATED SPURIOUS EMISSION.....27

3.8. FREQUENCY STABILITY35



1. SUMMARY

1.1. Test Standards

[FCC Rules Part 2](#): FREQUENCY ALLOCATIONS AND RADIO TREATY MATTERS; GENERAL RULES AND REGULATIONS

[FCC Rules Part 22](#): PRIVATE LAND MOBILE RADIO SERVICES.

[FCC Part 22 Subpart H](#): Cellular Radiotelephone Service.

[FCC Rules Part 24](#): PUBLIC MOBILE SERVICES

[FCC Rules Part 27](#): MISCELLANEOUS WIRELESS COMMUNICATIONS SERVICES

[ANSI C63.26: 2015](#): American National Standard for Compliance Testing of Transmitters Used in Licensed Radio Services

[KDB 971168 D01 Power Meas License Digital Systems v03](#): MEASUREMENT GUIDANCE FOR CERTIFICATION OF LICENSED DIGITAL TRANSMITTERS

[RSS-Gen Issue 5](#): General Requirements for Compliance of Radio Apparatus.

[RSS-130 Issue 1](#): Mobile Broadband Services (MBS) Equipment Operating in the Frequency Bands 698-756 MHz and 777-787 MHz

[RSS-132 Issue 3](#): Cellular Telephone Systems Operating in the Bands 824-849 MHz and 869-894 MHz.

[RSS-133 Issue 6](#): 2 GHz Personal Communications Services.

[RSS-139 Issue 3](#): Advanced Wireless Services Equipment Operating in the Bands 1710-1780 MHz and 2110-2180 MHz

[RSS-199 Issue 3](#): Broadband Radio Service (BRS) Equipment Operating in the Band 2500–2690 MHz

1.2. Report version

Revised No.	Date of issue	Description
01	Dec. 29, 2020	Original



1.3. Test Description

Test Item	Section in CFR 47	RSS Rule	Result	Test Engineer
Conducted Output Power	Part 2.1046 Part 22.913(a) Part 24.232(c) Part 27.50	RSS-130(4.4) RSS-132(5.4) RSS-133(6.4) RSS-139(6.4)	Pass	Rod Luo
Peak-to-Average Ratio	Part 24.232 Part 27.50	RSS-130(4.4) RSS-132(5.4) RSS-133(6.4) RSS-139(6.4)	Pass	Rod Luo
99% Occupied Bandwidth & 26 dB Bandwidth	Part 2.1049 Part 22.917(b) Part 24.238(b) Part 27.53	RSS-GEN(6.6) RSS-130(3.1) RSS-133(6.5) RSS-139(6.5) RSS-199(4.2)	Pass	Rod Luo
Band Edge	Part 2.1051 Part 22.917 Part 24.238 Part 27.53	RSS-130(4.6) RSS-132(5.5) RSS-133(6.5) RSS-139(6.5)	Pass	Rod Luo
Conducted Spurious Emissions	Part 2.1051 Part 22.917 Part 24.238 Part 27.53	RSS-130(4.6) RSS-132(5.5) RSS-133(6.5) RSS-139(6.5)	Pass	Rod Luo
Frequency stability VS Temperature	Part 2.1055(a)(1)(b) Part 22.355 Part 24.235 Part 27.54	RSS-GEN(6.11) RSS-130(4.3) RSS-132(5.3) RSS-133(6.3) RSS-199(4.3)	Pass	Rod Luo
Frequency stability VS Voltage	Part 2.1055(d)(1)(2) Part 22.355 Part 24.235 Part 27.54	RSS-GEN(6.11) RSS-132(5.3) RSS-133(6.3) RSS-139(6.3) RSS-199(4.3)	Pass	Rod Luo
ERP and EIRP	Part 22.913(a) Part 24.232(b) Part 27.50	RSS-130(4.4) RSS-132(5.4) RSS-133(6.4) RSS-139(6.4) RSS-199(4.4)	Pass	Rod Luo
Radiated Spurious Emissions	Part 2.1053 Part 22.917 Part 24.238 Part 27.53	RSS-130(4.6) RSS-132(5.5) RSS-133(6.5) RSS-139(6.5) RSS-199(4.5)	Pass	Rod Luo
Receiver Spurious Emissions	/	RSS-GEN(7.1.3)	Pass	Rod Luo

Note: The measurement uncertainty is not included in the test result.

CTC Laboratories, Inc.

1-2/F., Building 2, Jiaquan Building, Guanlan High-Tech Park, Shenzhen, Guangdong, China

Tel.: (86)755-27521059

Fax: (86)755-27521011

Http://www.sz-ctc.org.cn



For anti-fake verification, please visit the official website of Certification and

Accreditation Administration of the People's Republic of China : <http://yz.cnca.cn>



1.4. Test Facility

Address of the report laboratory

CTC Laboratories, Inc.

Add: 1-2/F., Building 2, Jiaquan Building, Guanlan High-Tech Park, Shenzhen, Guangdong, China

Laboratory accreditation

The test facility is recognized, certified, or accredited by the following organizations:

CNAS-Lab Code: L5365

CTC Laboratories, Inc. has been assessed and proved to be in compliance with CNAS-CL01 Accreditation Criteria for Testing and Calibration Laboratories (identical to ISO/IEC 17025:2017 General Requirements) the Competence of Testing and Calibration Laboratories.

A2LA-Lab Cert. No.: 4340.01

CTC Laboratories, Inc. EMC Laboratory has been accredited by A2LA for technical competence in the field of electrical testing, and proved to be in compliance with ISO/IEC 17025:2017 General Requirements for the Competence of Testing and Calibration Laboratories and any additional program requirements in the identified field of testing.

Industry Canada (Registration No.: 9783A, CAB Identifier: CN0029)

CTC Laboratories, Inc. EMC Laboratory has been registered by Certification and Engineer Bureau of Industry Canada for the performance of with Registration NO.: 9783A on Jan, 2016.

FCC (Registration No.: 951311, Designation Number CN1208)

CTC Laboratories, Inc. EMC Laboratory has been registered and fully described in a report filed with the (FCC) Federal Communications Commission. The acceptance letter from the FCC is maintained in our files. Registration 951311, Aug 26, 2017.



1.5. Measurement Uncertainty

The data and results referenced in this document are true and accurate. The reader is cautioned that there may be errors within the calibration limits of the equipment and facilities. The measurement uncertainty was calculated for all measurements listed in this test report acc. to TR-100028-01” Electromagnetic compatibility and Radio spectrum Matters (ERM); Uncertainties in the measurement of mobile radio equipment characteristics; Part 1” and TR-100028-02 “Electromagnetic compatibility and Radio spectrum Matters (ERM); Uncertainties in the measurement of mobile radio equipment characteristics; Part 2 “ and is documented in the CTC Laboratories, Inc. quality system acc. to DIN EN ISO/IEC 17025. Furthermore, component and process variability of devices similar to that tested may result in additional deviation. The manufacturer has the sole responsibility of continued compliance of the device.

Hereafter the best measurement capability for CTC Laboratories, Inc. is reported:

Test Items	Measurement Uncertainty	Notes
Frequency stability	25 Hz	(1)
Transmitter power conducted	0.57 dB	(1)
Transmitter power Radiated	2.20 dB	(1)
Conducted spurious emission 9KHz-12.75 GHz	1.60 dB	(1)
Conducted Emission 9KHz-30MHz	3.39 dB	(1)
Radiated Emission 30~1000MHz	4.24 dB	(1)
Radiated Emission 1~18GHz	5.16 dB	(1)
Radiated Emission 18-40GHz	5.54 dB	(1)
Occupied Bandwidth	-----	(1)
Emission Mask	-----	(1)
Modulation Characteristic	-----	(1)
Transmitter Frequency Behavior	-----	(1)

Note: (1) This uncertainty represents an expanded uncertainty expressed at approximately the 95% confidence level using a coverage factor of k=1.96.

1.6. Environmental conditions

During the measurement the environmental conditions were within the listed ranges:

Normal Temperature:	20°C-25°C
Relative Humidity:	50 %-55 %
Air Pressure:	101kPa



2. GENERAL INFORMATION

2.1. Client Information

Applicant:	Imin Technology Pte Ltd
Address:	63 Ubi Ave 1 #07-02 63@Ubi Singapore 408937
Manufacturer:	Imin Technology Pte Ltd
Address:	63 Ubi Ave 1 #07-02 63@Ubi Singapore 408937



2.2. General Description of EUT

Product Name:	Mobile POS
Trade Mark:	N/A
Model/Type reference:	M2-203
Listed Model(s):	N/A
Power supply:	5Vdc/2A from AC/DC Adapter 7.4Vdc from 2600mAh Li-ion Battery
Adapter Model:	TPA-46050200UU Input:100-240V~ 50/60Hz 0.3A Output: 5Vdc/2A
Hardware version:	Z2-MB-V2.0
Software version:	M2_1.1.6SG
LTE	
Operation Band:	Band 4: UL: 1710.7MHz~1754.3MHz, DL: 2110.7MHz~2154.3MHz Band 5: UL: 824.7MHz~848.3MHz, DL: 869.7MHz~893.3MHz Band 7: UL: 2502.5MHz~2567.5MHz, DL: 2622.5MHz~2687.5MHz Band 17: UL: 706.5MHz~713.5MHz, DL: 736.5MHz~743.5MHz Band 41: UL: 2555MHz~2655MHz, DL: 2555MHz~2655MHz
Modulation Type:	QPSK, 16QAM
Antenna type:	PIFA Antenna
Antenna Gain:	Main Antenna: FDD Band 4: 1.35dBi FDD Band 5: 1.19dBi FDD Band 7: -1.06dBi FDD Band 17: -1.32dBi TDD Band 41: -0.64dBi



2.3. Description of Test Modes and Test Frequency

The EUT has been tested under typical operating condition. The CMW500 used to control the EUT staying in continuous transmitting and receiving mode for testing.

Test Frequency:

Band 4			
Test channel	Bandwidth(MHz)	N _{UL}	Frequency of Uplink (MHz)
Low Range	1.4	19957	1710.70
	3	19965	1711.50
	5	19975	1712.50
	10	20000	1715.00
	15	20025	1717.50
	20	20050	1720.00
Mid Range	1.4/3/5/10/15/20	20175	1732.50
High Range	1.4	20393	1754.30
	3	20385	1753.50
	5	20375	1752.50
	10	20350	1750.00
	15	20325	1747.50
	20	20300	1745.00

Band 5			
Test channel	Bandwidth(MHz)	N _{UL}	Frequency of Uplink (MHz)
Low Range	1.4	20407	824.70
	3	20415	825.50
	5	20425	826.50
	10	20450	829.00
Mid Range	1.4/3/5/10	20525	836.50
High Range	1.4	20643	848.30
	3	20635	847.50
	5	20625	846.50
	10	20600	844.00

Band 7			
Test channel	Bandwidth(MHz)	N _{UL}	Frequency of Uplink (MHz)
Low Range	5	20775	2502.50
	10	20800	2505.00
	15	20825	2507.50
	20	20850	2510.00
Mid Range	5/10/15/20	21100	2535.00
High Range	5	21425	2567.50
	10	21400	2565.00
	15	21375	2562.50
	20	21350	2560.00

Band 17			
Test channel	Bandwidth(MHz)	N _{UL}	Frequency of Uplink (MHz)
Low Range	5	23755	706.50
	10	23780	709.00
Mid Range	5/10	23790	710.00
High Range	5	23825	713.50
	10	23800	711.00



Band 41			
Test channel	Bandwidth(MHz)	N _{UL}	Frequency of Uplink (MHz)
Low Range	5	40265	2557.5
	10	40290	2560.0
	15	40315	2562.5
	20	40340	2565.0
Mid Range	5/10/15/20	40740	2605.0
High Range	5	41215	2652.5
	10	41190	2650.0
	15	41165	2647.5
	20	41140	2645.0



2.4. Measurement Instruments List

Output Power (Radiated) & Radiated Spurious Emission					
Item	Test Equipment	Manufacturer	Model No.	Serial No.	Calibrated until
1	EMI Test Receiver	R&S	ESCI	100967	Dec. 26, 2021
2	High pass filter	Compliance Direction systems	BSU-6	34202	Dec. 26, 2021
3	Log-Bicon Antenna	Schwarzbeck	CBL6141A	4180	Dec. 26, 2021
4	Log-Bicon Antenna	Schwarzbeck	CBL6141A	4181	Dec. 26, 2021
5	Spectrum Analyzer	HP	8563E	02052	Dec. 26, 2021
6	Horn Antenna	Schwarzbeck	BBHA 9120D	648	Dec. 26, 2021
7	Horn Antenna	Schwarzbeck	BBHA 9120D	649	Dec. 26, 2021
8	Ultra-Broadband Antenna	Schwarzbeck	BBHA9170	25841	Dec. 26, 2021
9	Ultra-Broadband Antenna	Schwarzbeck	BBHA9170	25842	Dec. 26, 2021
10	Pre-Amplifier	HP	8447D	1937A03050	Dec. 26, 2021
11	Pre-Amplifier	EMCI	EMC051835	980075	Dec. 26, 2021
12	Splitter	Mini-Circuit	ZAPD-4	400059	Dec. 26, 2021
13	Signal Generator	Agilent	N5182A	1019356	Dec. 26, 2021
14	Wideband Radio Communication Tester	Rohde & Schwarz	CMW500	116410	Dec. 26, 2021
15	Antenna Mast	UC	UC3000	N/A	N/A
16	Antenna mast	MATURO	TAM-4.0-P	N/A	N/A
17	Turn Table	UC	UC3000	N/A	N/A
18	Cable Below 1GHz	Schwarzbeck	AK9515E	33155	Dec. 26, 2021
19	Cable Above 1GHz	Hubersuhner	SUCOFLEX102	DA1580	Dec. 26, 2021

Output Power(Conducted) & Occupied Bandwidth & Emission Bandwidth & Band Edge Compliance & Conducted Spurious Emission					
Item	Test Equipment	Manufacturer	Model No.	Serial No.	Calibrated until
1	UNIVERSAL RADIO COMMUNICATION	Rohde & Schwarz	CMU200	114694	Dec. 26, 2021
2	Spectrum Analyzer	Rohde & Schwarz	FSU	100105	Dec. 26, 2021
3	Spectrum Analyzer	Rohde & Schwarz	FUV40-N	101331	Mar. 15, 2021
4	Splitter	Mini-Circuit	ZAPD-4	400059	Dec. 26, 2021

Frequency Stability					
Item	Test Equipment	Manufacturer	Model No.	Serial No.	Calibrated until
1	UNIVERSAL RADIO COMMUNICATION	Rohde & Schwarz	CMU200	114694	Dec. 26, 2021
2	Spectrum Analyzer	Rohde & Schwarz	FSU	100105	Dec. 26, 2021
3	Spectrum Analyzer	Rohde & Schwarz	FUV40-N	101331	Mar. 15, 2021
4	Splitter	Mini-Circuit	ZAPD-4	400059	Dec. 26, 2021
5	Climate Chamber	ESPEC	EL-10KA	05107008	Dec. 26, 2021

Note: 1. The Cal. Interval was one year.

2. The cable loss has calculated in test result which connection between each test instruments.

3. TEST ITEM AND RESULTS

3.1. Conducted Output Power

LIMIT

Conducted Output Power: N/A

TEST CONFIGURATION

- For Conducted output Power



Note: Measurement setup for testing on Antenna connector

TEST PROCEDURE

- For Conducted output Power
 1. The transmitter output port was connected to base station.
 2. The RF output of EUT was connected to the power meter by RF cable and attenuator, the path loss was compensated to the results for each measurement.
 3. Set EUT at maximum power through base station.
 4. Select lowest, middle, and highest channels for each band and different modulation.
 5. Measure the maximum PK burst power and maximum Avg. burst power.

TEST RESULTS

Please see the appendix for every tested band.



3.2. Peak-to-Average Ratio

LIMIT:

The Peak-to-Average Ratio (PAR) of the transmission may not exceed 13dB.

TEST CONFIGURATION

- For Peak-to-Average Ratio

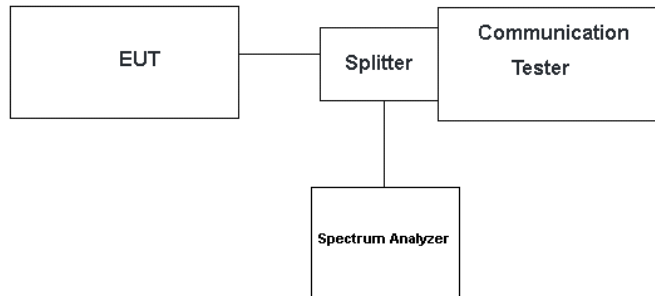

TEST PROCEDURE

- For Peak-to-Average Ratio
 1. The testing follows FCC KDB 971168 v02r02 Section 5.7.1.
 2. The EUT was connected to spectrum and communication tester via a splitter
 3. Set the CCDF (Complementary Cumulative Distribution Function) option in spectrum analyzer.
 4. The highest RF powers were measured and recorded the maximum PAPR level associated with a probability of 0.1 %.
 6. Record the deviation as Peak to Average Ratio.

TEST RESULTS

Please see the appendix for every tested band.

3.3. Occupy Bandwidth

TEST CONFIGURATION

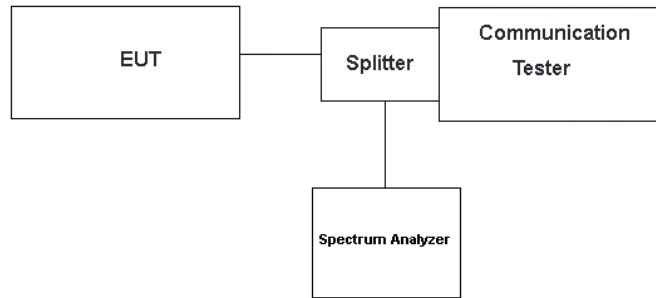

TEST PROCEDURE

1. The EUT's output RF connector was connected with a short cable to the spectrum analyzer
2. RBW was set to about 1% of emission BW, $VBW \geq 3$ times RBW.
3. -26dBc display line was placed on the screen (or 99% bandwidth), the occupied bandwidth is the delta frequency between the two points where the display line intersects the signal trace.

TEST RESULTS

Please see the appendix for every tested band.



3.4. Out of band emission at antenna terminals

LIMIT

§ 22.917, §24.238, §27.53 (c), (g), (h), §90.691, §90.543 (Band 14)

The minimum permissible attenuation level of any spurious emissions is $43 + 10 \log (P)$ dB where transmitting power (P) in Watts.

§ 27.53 (a) (Band 30, 40)

The minimum permissible attenuation level of any spurious emissions is $70 + 10 \log (P)$ dB where transmitting power (P) in Watts.

§ 27.53 (m) (Band 7, 41)

The minimum permissible attenuation level of any spurious emissions is $55 + 10 \log (P)$ dB where transmitting power (P) in Watts.

§ 96.41

(e) 3.5 GHz Emissions and Interference Limits—

(2) Additional protection levels. Notwithstanding paragraph (d)(1) of this section, the conducted power of any emissions below 3530 MHz or above 3720 MHz shall not exceed -40dBm/MHz .

TEST CONFIGURATION

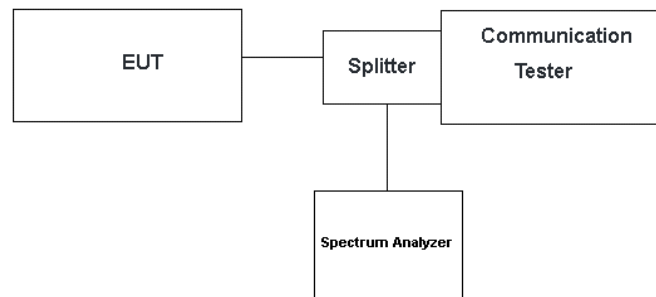

TEST PROCEDURE

1. The RF output of the transceiver was connected to a spectrum analyzer through appropriate attenuation.
2. The resolution bandwidth of the spectrum analyzer was set at 1MHz; sufficient scans were taken to show the out of band Emissions if any up to 10th harmonic.
3. For the out of band: Set the RBW = 1MHz VBW ≥ 3 times RBW, Start=30MHz, Stop= 10th harmonic.

TEST RESULTS

Please see the appendix for every tested band.



3.5. Band Edge compliance

LIMIT

§ 22.917, §24.238, §27.53(h)

The power of any emission outside of the authorized operating frequency ranges must be attenuated below the transmitting power (P) by a factor of at least $43 + 10 \log (P)$ dB.

§ 90.691 Emission mask requirements for EA-based systems.

(a) Out-of-band emission requirement shall apply only to the “outer” channels included in an EA license and to spectrum

adjacent to interior channels used by incumbent licensees. The emission limits are as follows:

(1) For any frequency removed from the EA licensee's frequency block by up to and including 37.5 kHz, the power of any

emission shall be attenuated below the transmitter power (P) in watts by at least $116 \log_{10}(f/6.1)$ decibels or $50 + 10$

$\log_{10}(P)$ decibels or 80 decibels, whichever is the lesser attenuation, where f is the frequency removed from the center of

the outer channel in the block in kilohertz and where f is greater than 12.5 kHz.

(2) For any frequency removed from the EA licensee's frequency block greater than 37.5 kHz, the power of any emission

shall be attenuated below the transmitter power (P) in watts by at least $43 + 10 \log_{10}(P)$ decibels or 80 decibels,

whichever is the lesser attenuation, where f is the frequency removed from the center of the outer channel in the block in

kilohertz and where f is greater than 37.5 kHz.

§ 27.53 (Band 30)

(a) For operations in the 2305-2320 MHz band and the 2345-2360 MHz band, the power of any emission outside a licensee's frequency band(s) of operation shall be attenuated below the transmitter power P (with averaging performed only during periods of transmission) within the licensed band(s) of operation, in watts, by the following amounts:

(4) For mobile and portable stations operating in the 2305-2315 MHz and 2350-2360 MHz bands:

(i) By a factor of not less than: $43 + 10 \log (P)$ dB on all frequencies between 2305 and 2320 MHz and on all frequencies between 2345 and 2360 MHz that are outside the licensed band(s) of operation, not less than $55 + 10 \log (P)$ dB on all frequencies between 2320 and 2324 MHz and on all frequencies between 2341 and 2345 MHz, not less than $61 + 10 \log (P)$ dB on all frequencies between 2324 and 2328 MHz and on all frequencies between 2337 and 2341 MHz, and not less than $67 + 10 \log (P)$ dB on all frequencies between 2328 and 2337 MHz;

(ii) By a factor of not less than $43 + 10 \log (P)$ dB on all frequencies between 2300 and 2305 MHz, $55 + 10 \log (P)$ dB on all frequencies between 2296 and 2300 MHz, $61 + 10 \log (P)$ dB on all frequencies between 2292 and 2296 MHz, $67 + 10 \log (P)$ dB on all frequencies between 2288 and 2292 MHz, and $70 + 10 \log (P)$ dB below 2288 MHz;

(iii) By a factor of not less than $43 + 10 \log (P)$ dB on all frequencies between 2360 and 2365 MHz, and not less than $70 + 10 \log (P)$ dB above 2365 MHz.

§ 27.53 (Band 13)

(c) For operations in the 746-758 MHz band and the 776-788 MHz band, the power of any emission outside the licensee's frequency band(s) of operation shall be attenuated below the transmitter power (P) within the licensed band(s) of operation, measured in watts, in accordance with the following:

(2) On any frequency outside the 776-788 MHz band, the power of any emission shall be attenuated outside the band below the transmitter power (P) by at least $43 + 10 \log (P)$ dB;

(4) On all frequencies between 763-775 MHz and 793-805 MHz, by a factor not less than $65 + 10 \log (P)$ dB in a 6.25 kHz band segment, for mobile and portable stations;

(5) Compliance with the provisions of paragraphs (c)(2) of this section is based on the use of measurement instrumentation employing a resolution bandwidth of 100 kHz or greater. However, in the 100 kHz bands immediately outside and adjacent to the frequency block, a resolution bandwidth of at least 30 kHz may be employed;

(6) Compliance with the provisions of paragraphs (c)(4) of this section is based on the use of measurement instrumentation such that the reading taken with any resolution bandwidth setting should



be adjusted to indicate spectral energy in a 6.25 kHz segment.

(f) Emissions in the band 1559-1610 MHz shall be limited to -70 dBW/MHz equivalent isotropically radiated power (EIRP) for wideband signals. (-70 dBW/MHz = -40 dBm/MHz).

§ 27.53 (Band 12, 17, 71)

(g) For operations in the 600 MHz band and the 698-746 MHz band, the power of any emission outside a licensee's frequency band(s) of operation shall be attenuated below the transmitter power (P) within the licensed band(s) of operation, measured in watts, by at least $43 + 10 \log(P)$ dB. Compliance with this provision is based on the use of measurement instrumentation employing a resolution bandwidth of 100 kilohertz or greater. However, in the 100 kilohertz bands immediately outside and adjacent to a licensee's frequency block, a resolution bandwidth of at least 30 kHz may be employed.

§ 27.53 (Band 7, 41)

(m)(4) For mobile digital stations, the attenuation factor shall be not less than $40 + 10 \log(P)$ dB on all frequencies between the channel edge and 5 megahertz from the channel edge, $43 + 10 \log(P)$ dB on all frequencies between 5 megahertz and X megahertz from the channel edge, and $55 + 10 \log(P)$ dB on all frequencies more than X megahertz from the channel edge, where X is the greater of 6 megahertz or the actual emission bandwidth as defined in paragraph

(m)(6) of this section. In addition, the attenuation factor shall not be less than $43 + 10 \log(P)$ dB on all frequencies between 2490.5 MHz and 2496 MHz and $55 + 10 \log(P)$ dB at or below 2490.5 MHz.

Mobile Satellite Service licensees operating on frequencies below 2495 MHz may also submit a documented interference complaint against BRS licensees operating on channel BRS Channel 1 on the same terms and conditions as adjacent channel BRS or EBS licensees.

FCC: §96.41

(e) 3.5 GHz Emissions and Interference Limits—(1) General protection levels. Except as otherwise specified in paragraph

(e)(2) of this section, for channel and frequency assignments made by the SAS to CBSDs, the conducted power of any emission outside the fundamental emission (whether in or outside of the authorized band) shall not exceed -13 dBm/MHz within 0-10 megahertz above the upper SAS-assigned channel edge and within 0-10 megahertz below the lower SAS assigned channel edge. At all frequencies greater than 10 megahertz above the upper SAS assigned channel edge and less than 10 MHz below the lower SAS assigned channel edge, the conducted power of any emission shall not exceed -25 dBm/MHz. The upper and lower SAS assigned channel edges are the upper and lower limits of any channel assigned to a CBSD by an SAS, or in the case of multiple contiguous channels, the upper and lower limits of the combined contiguous channels.

(2) Additional protection levels. Notwithstanding paragraph (d)(1) of this section, the conducted power of any emissions below 3530 MHz or above 3720 MHz shall not exceed -40 dBm/MHz.

TEST CONFIGURATION

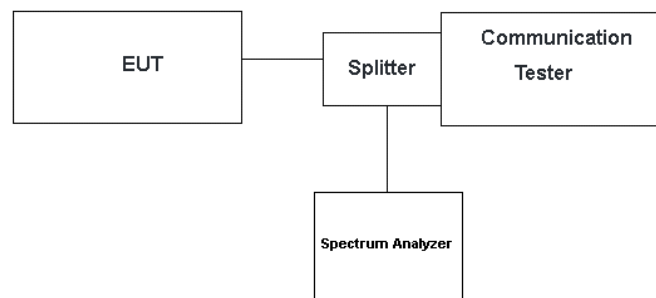

TEST PROCEDURE

1. The RF output of the transceiver was connected to a spectrum analyzer through appropriate attenuation.
2. RBW was set to about 1% of emission BW, VBW \geq 3 times RBW.

TEST RESULTS

Please see the appendix for every tested band.

3.6. Radiated Power Measurement

LIMIT

LTE FDD Band 2: 2W(33dBm) EIRP
LTE FDD Band 4: 1W(30dBm) EIRP
LTE FDD Band 5: 7W(38.45dBm) ERP
LTE FDD Band 7: 2W(33dBm) EIRP
LTE FDD Band 12: 3W(34.77dBm) ERP
LTE FDD Band 13: 3W(34.77dBm) ERP
LTE FDD Band 17: 3W(34.77dBm) ERP
LTE FDD Band 25: 2W(33dBm) EIRP
LTE FDD Band 26: 7W(38.45dBm) ERP
LTE FDD Band 30: 0.25W(23.97dBm) EIRP
LTE TDD Band 41: 2W(33dBm) EIRP
LTE FDD Band 66: 1W(30dBm) EIRP
LTE FDD Band 71: 2W(34.77dBm) ERP
FCC: §2.1046, §22.913, §24.232, §27.50, §90.635, §90.541, and §96.41

TEST CONFIGURATION

For the actual test configuration, please refer to the related Item – EUT Test Photos.

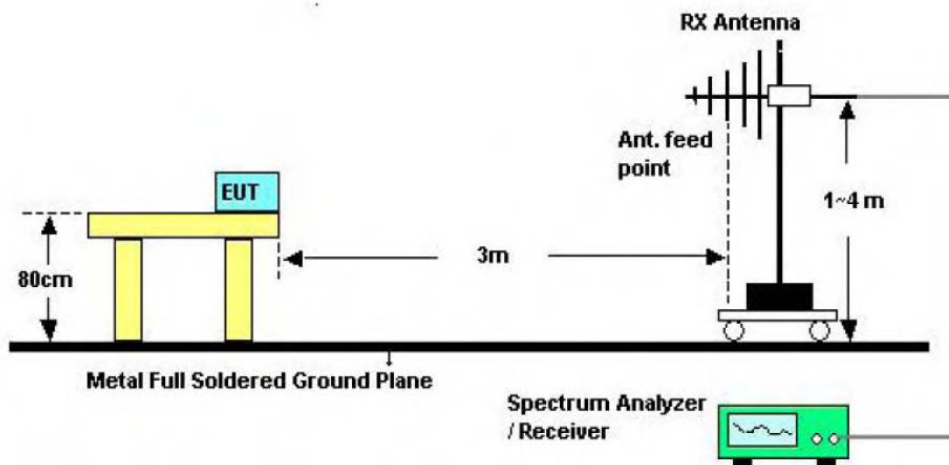

Below 1GHz

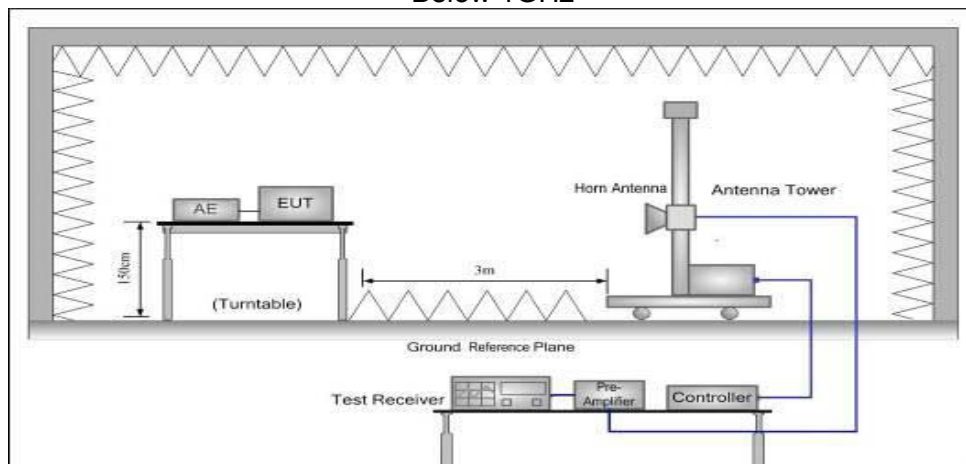

Above 1GHz

TEST PROCEDURE

CTC Laboratories, Inc.

1-2/F., Building 2, Jiaquan Building, Guanlan High-Tech Park, Shenzhen, Guangdong, China

Tel.: (86)755-27521059

Fax: (86)755-27521011

Http://www.sz-ctc.org.cn



1. EUT was placed on a 1.50 meter high non-conductive stand at a 3 meter test distance from the receive antenna. A receiving antenna was placed on the antenna mast 3 meters from the EUT for emission measurements. The height of receiving antenna is 1.50m. Detected emissions were maximized at each frequency by rotating the EUT through 360° and adjusting the receiving antenna polarization. The radiated emission measurements of all transmit frequencies in three channels (High, Middle, Low) were measured with peak detector.
2. A log-periodic antenna or double-ridged waveguide horn antenna shall be substituted in place of the EUT. The log-periodic antenna will be driven by a signal generator and the level will be adjusted till the same power value on the spectrum analyzer or receiver. The level of the spurious emissions can be calculated through the level of the signal generator, cable loss, the gain of the substitution antenna and the reading of the spectrum analyzer or receiver.
3. The EUT is then put into continuously transmitting mode at its maximum power level during the test. Set Test Receiver or Spectrum RBW=1MHz, VBW=3MHz, and the maximum value of the receiver should be recorded as (Pr).
4. The EUT shall be replaced by a substitution antenna. In the chamber, an substitution antenna for the frequency band of interest is placed at the reference point of the chamber. An RF Signal source for the frequency band of interest is connected to the substitution antenna with a cable that has been constructed to not interfere with the radiation pattern of the antenna. A power (PMea) is applied to the input of the substitution antenna, and adjusts the level of the signal generator output until the value of the receiver reach the previously recorded (Pr). The power of signal source (PMea) is recorded. The test should be performed by rotating the test item and adjusting the receiving antenna polarization.
5. An amplifier should be connected to the Signal Source output port. And the cable should be connecting between the Amplifier and the Substitution Antenna. The cable loss (Pcl), the Substitution Antenna Gain (Ga) and the Amplifier Gain (PAg) should be recorded after test.
6. The measurement results are obtained as described below:
Power(EIRP)=PMea- PAg - Pcl + Ga
We used N5182A microwave signal generator which signal level can up to 33dBm,so we not used power Amplifier for substitution test; The measurement results are amend as described below:
Power(EIRP)=PMea- Pcl + Ga
7. This value is EIRP since the measurement is calibrated using an antenna of known gain (2.15 dBi) and known input power.
ERP can be calculated from EIRP by subtracting the gain of the dipole, ERP = EIRP-2.15dBi.

TEST RESULTS

Remark:

1. By preliminary testing and verifying three axis (X, Y and Z) position of EUT transmitted status, it was found that "Z axis" position was the worst, and test data recorded in this report.



LTE Band 4 - 1.4MHz					
Modulation	Channel	EIRP (dBm)		Limit (dBm)	Result
		Vertical	Horizontal		
QPSK	Low	20.31	18.62	≤30	PASS
	Mid	20.66	18.56		
	High	20.60	19.21		
16QAM	Low	20.76	19.20		
	Mid	21.18	19.19		
	High	20.25	18.99		

LTE Band 4 - 3MHz					
Modulation	Channel	EIRP (dBm)		Limit (dBm)	Result
		Vertical	Horizontal		
QPSK	Low	20.60	18.47	≤30	PASS
	Mid	21.14	19.33		
	High	20.97	18.62		
16QAM	Low	20.66	18.98		
	Mid	20.31	18.48		
	High	20.73	19.27		

LTE Band 4 - 5MHz					
Modulation	Channel	EIRP (dBm)		Limit (dBm)	Result
		Vertical	Horizontal		
QPSK	Low	21.06	19.34	≤30	PASS
	Mid	20.56	18.98		
	High	21.08	19.22		
16QAM	Low	21.00	18.44		
	Mid	20.86	18.95		
	High	21.20	19.27		



LTE Band 4 - 10MHz					
Modulation	Channel	EIRP (dBm)		Limit (dBm)	Result
		Vertical	Horizontal		
QPSK	Low	20.68	18.76	≤30	PASS
	Mid	20.77	18.68		
	High	20.64	19.20		
16QAM	Low	20.54	18.93		
	Mid	21.09	18.99		
	High	21.19	18.59		

LTE Band 4 - 15MHz					
Modulation	Channel	EIRP (dBm)		Limit (dBm)	Result
		Vertical	Horizontal		
QPSK	Low	20.23	19.00	≤30	PASS
	Mid	20.58	19.12		
	High	20.33	19.13		
16QAM	Low	20.36	18.74		
	Mid	20.79	18.47		
	High	20.90	18.94		

LTE Band 4 - 20MHz					
Modulation	Channel	EIRP (dBm)		Limit (dBm)	Result
		Vertical	Horizontal		
QPSK	Low	20.91	19.19	≤30	PASS
	Mid	20.88	18.58		
	High	20.67	18.44		
16QAM	Low	20.64	18.78		
	Mid	20.73	18.87		
	High	21.08	18.83		



LTE Band 5 - 1.4MHz					
Modulation	Channel	ERP (dBm)		Limit (dBm)	Result
		Vertical	Horizontal		
QPSK	Low	21.16	18.90	≤38.45	PASS
	Mid	20.23	18.48		
	High	20.47	18.49		
16QAM	Low	20.74	18.86		
	Mid	20.96	18.45		
	High	21.22	18.78		

LTE Band 5 - 3MHz					
Modulation	Channel	ERP (dBm)		Limit (dBm)	Result
		Vertical	Horizontal		
QPSK	Low	20.55	18.45	≤38.45	PASS
	Mid	20.80	18.57		
	High	20.99	19.03		
16QAM	Low	21.14	18.85		
	Mid	20.79	19.15		
	High	20.96	18.74		

LTE Band 5 - 5MHz					
Modulation	Channel	ERP (dBm)		Limit (dBm)	Result
		Vertical	Horizontal		
QPSK	Low	20.30	18.87	≤38.45	PASS
	Mid	20.94	18.96		
	High	20.36	18.45		
16QAM	Low	20.41	18.91		
	Mid	20.88	18.38		
	High	20.31	18.95		



LTE Band 5 - 10MHz					
Modulation	Channel	ERP (dBm)		Limit (dBm)	Result
		Vertical	Horizontal		
QPSK	Low	20.40	18.68	≤38.45	PASS
	Mid	21.16	19.31		
	High	21.17	19.21		
16QAM	Low	20.80	18.83		
	Mid	20.71	19.31		
	High	20.93	18.75		

LTE Band 7 - 5MHz					
Modulation	Channel	EIRP (dBm)		Limit (dBm)	Result
		Vertical	Horizontal		
QPSK	Low	20.67	18.62	≤33	PASS
	Mid	20.67	19.05		
	High	21.18	18.70		
16QAM	Low	20.37	18.49		
	Mid	20.33	18.58		
	High	20.80	18.95		

LTE Band 7 - 10MHz					
Modulation	Channel	EIRP (dBm)		Limit (dBm)	Result
		Vertical	Horizontal		
QPSK	Low	21.13	18.76	≤33	PASS
	Mid	20.76	18.63		
	High	21.08	19.24		
16QAM	Low	20.52	18.41		
	Mid	20.32	19.13		
	High	20.29	18.93		



LTE Band 7 - 15MHz					
Modulation	Channel	EIRP (dBm)		Limit (dBm)	Result
		Vertical	Horizontal		
QPSK	Low	20.65	19.20	≤33	PASS
	Mid	21.21	18.54		
	High	20.27	18.92		
16QAM	Low	20.41	18.61		
	Mid	20.53	19.09		
	High	21.21	19.34		

LTE Band 7 - 20MHz					
Modulation	Channel	EIRP (dBm)		Limit (dBm)	Result
		Vertical	Horizontal		
QPSK	Low	20.83	18.95	≤33	PASS
	Mid	20.66	18.70		
	High	20.40	18.66		
16QAM	Low	20.34	18.92		
	Mid	21.17	19.01		
	High	21.01	19.11		

LTE Band 17 - 5MHz					
Modulation	Channel	ERP (dBm)		Limit (dBm)	Result
		Vertical	Horizontal		
QPSK	Low	20.69	19.09	≤34.77	PASS
	Mid	20.79	18.35		
	High	21.00	18.94		
16QAM	Low	20.89	19.26		
	Mid	20.70	19.20		
	High	20.82	18.54		



LTE Band 17 - 10MHz					
Modulation	Channel	ERP (dBm)		Limit (dBm)	Result
		Vertical	Horizontal		
QPSK	Low	20.70	18.43	≤34.77	PASS
	Mid	20.52	18.61		
	High	20.90	18.62		
16QAM	Low	20.26	18.36		
	Mid	20.47	18.90		
	High	20.74	18.73		

LTE Band 41 - 5MHz					
Modulation	Channel	EIRP (dBm)		Limit (dBm)	Result
		Vertical	Horizontal		
QPSK	Low	20.94	19.20	≤33	PASS
	Mid	21.11	18.69		
	High	21.03	18.60		
16QAM	Low	21.03	18.89		
	Mid	20.47	19.24		
	High	20.79	18.92		

LTE Band 41 - 10MHz					
Modulation	Channel	EIRP (dBm)		Limit (dBm)	Result
		Vertical	Horizontal		
QPSK	Low	20.77	18.50	≤33	PASS
	Mid	20.63	18.90		
	High	21.08	18.73		
16QAM	Low	20.33	19.18		
	Mid	20.93	18.86		
	High	20.32	18.39		



LTE Band 41 - 15MHz					
Modulation	Channel	EIRP (dBm)		Limit (dBm)	Result
		Vertical	Horizontal		
QPSK	Low	20.39	18.56	≤33	PASS
	Mid	21.11	18.52		
	High	20.30	18.63		
16QAM	Low	21.12	18.55		
	Mid	21.11	19.01		
	High	20.79	18.49		

LTE Band 41 - 20MHz					
Modulation	Channel	EIRP (dBm)		Limit (dBm)	Result
		Vertical	Horizontal		
QPSK	Low	21.12	19.11	≤33	PASS
	Mid	20.64	18.54		
	High	20.51	19.17		
16QAM	Low	21.19	19.09		
	Mid	20.85	19.21		
	High	21.09	18.66		

3.7. Radiated Spurious Emission

LIMIT

§ 22.917(a), §24.238(a), §27.53 (g), (h), §90.691

The power of any emission outside of the authorized operating frequency ranges must be attenuated below the transmitting power (P) by a factor of at least $43 + 10 \log (P)$ dB.

§ 27.53 (Band 13)

(c) The power of any emission outside of the authorized operating frequency ranges must be attenuated below the transmitting power (P) by a factor of at least $43 + 10 \log (P)$ dB.

(f) Emissions in the band 1559-1610 MHz shall be limited to -70 dBW/MHz equivalent isotropically radiated power (EIRP) for wideband signals. (-70 dBW/MHz = -40 dBm/MHz).

FCC: § 90.669 Emission limits. (Band 26)

(a) On any frequency in an MTA licensee's spectrum block that is adjacent to a non-MTA frequency, the power of any emission shall be attenuated below the transmitter power (P) by at least 43 plus $10 \log_{10}(P)$ decibels or 80 decibels, whichever is the lesser attenuation.

§ 27.53 (a) (Band 30)

For mobile and portable stations operating in the 2305-2315 MHz: by a factor of not less than $43 + 10 \log (P)$ dB on all frequencies between 2360 and 2365 MHz, and not less than $70 + 10 \log (P)$ dB above 2365 MHz.

§ 27.53 (m) (Band 7, 41)

At least $55 + 10 \log (P)$ dB on all frequencies more than X megahertz from the channel edge, where X is the greater of 6 megahertz or the actual emission bandwidth as defined in paragraph (m)(6) of this section.

TEST CONFIGURATION

For the actual test configuration, please refer to the related Item – EUT Test Photos.

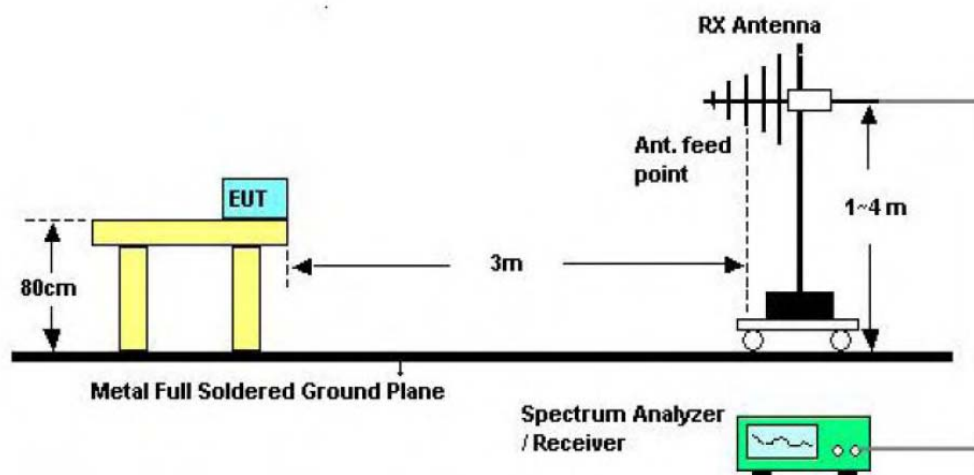

Below 1GHz

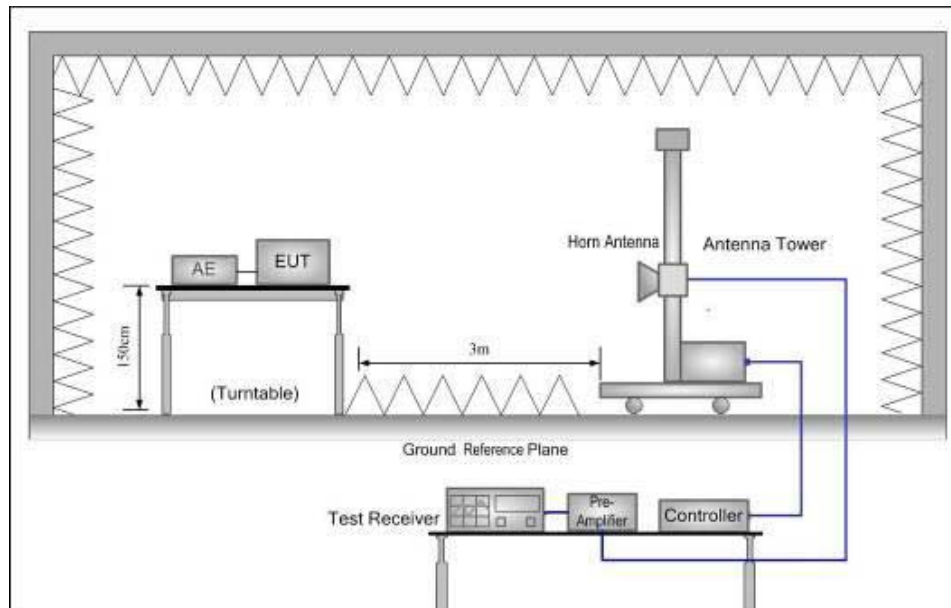

Above 1GHz

TEST PROCEDURE

1. EUT was placed on a 1.50 meter high non-conductive stand at a 3 meter test distance from the receive antenna. A receiving antenna was placed on the antenna mast 3 meters from the EUT for emission measurements. The height of receiving antenna is 1.50m. Detected emissions were maximized at each frequency by rotating the EUT through 360° and adjusting the receiving antenna polarization. The radiated emission measurements of all transmit frequencies in three channels (High, Middle, Low) were measured with peak detector.
2. A log-periodic antenna or double-ridged waveguide horn antenna shall be substituted in place of the EUT. The log-periodic antenna will be driven by a signal generator and the level will be adjusted till the same power value on the spectrum analyzer or receiver. The level of the spurious emissions can be calculated through the level of the signal generator, cable loss, the gain of the substitution antenna and the reading of the spectrum analyzer or receiver.
3. The EUT is then put into continuously transmitting mode at its maximum power level during the test. Set Test Receiver or Spectrum RBW=1MHz, VBW=3MHz, and the maximum value of the receiver should be recorded as (Pr).
4. The EUT shall be replaced by a substitution antenna. In the chamber, an substitution antenna for the frequency band of interest is placed at the reference point of the chamber. An RF Signal source for the frequency band of interest is connected to the substitution antenna with a cable that has been constructed to not interfere with the radiation pattern of the antenna. A power (PMea) is applied to the input of the substitution antenna, and adjusts the level of the signal generator output until the value of the receiver reach the previously recorded (Pr). The power of signal source (PMea) is recorded. The test should be performed by rotating the test item and adjusting the receiving antenna polarization.
5. An amplifier should be connected to the Signal Source output port. And the cable should be connecting between the Amplifier and the Substitution Antenna. The cable loss (Pcl), the Substitution Antenna Gain (Ga) and the Amplifier Gain (PAG) should be recorded after test.
6. The measurement results are obtained as described below:



7. Power(EIRP)=PMea- PAg - Pcl + Ga

We used SMF100A microwave signal generator which signal level can up to 33dBm,so we not used power Amplifier for substitution test; The measurement results are amend as described below:

$$\text{Power(EIRP)}=\text{PMea}- \text{Pcl} + \text{Ga}$$

8. This value is EIRP since the measurement is calibrated using an antenna of known gain (2.15dBi) and known input power.

ERP can be calculated from EIRP by subtracting the gain of the dipole, ERP = EIRP-2.15dBi.

9. Test frequency range should extend to 10th harmonic of highest fundamental frequency.

TEST RESULTS

Remark:

1. By preliminary testing and verifying three axis (X, Y and Z) position of EUT transmitted status, it was found that "Z axis" position was the worst, and test data recorded in this report.
2. We test all modulation types, all bandwidths, and record the worst case at the maximum bandwidth of each modulation.



Measured data (worst case):

Band 4 Radiated Spurious Emissions							
Bandwidth	Modulation	Test Channel	Spurious Emission			Limit (dBm)	Result
			Frequency	Level (dBm)	Polarization		
20MHz	QPSK	L	3440.00	-41.59	Vertical	-13.00	Pass
			5160.00	-47.53	Vertical		
			3440.00	-47.36	Horizontal		
			5160.00	-54.79	Horizontal		
20MHz	QPSK	M	3465.00	-40.95	Vertical	-13.00	Pass
			5197.50	-47.48	Vertical		
			3465.00	-42.36	Horizontal		
			5197.50	-53.83	Horizontal		
20MHz	QPSK	H	3490.00	-42.97	Vertical	-13.00	Pass
			5235.00	-47.04	Vertical		
			3490.00	-42.68	Horizontal		
			5235.00	-53.87	Horizontal		
20MHz	16QAM	L	3440.00	-42.35	Vertical	-13.00	Pass
			5160.00	-48.03	Vertical		
			3440.00	-42.89	Horizontal		
			5160.00	-54.03	Horizontal		
20MHz	16QAM	M	3465.00	-42.67	Vertical	-13.00	Pass
			5197.50	-49.00	Vertical		
			3465.00	-41.96	Horizontal		
			5197.50	-53.24	Horizontal		
20MHz	16QAM	H	3490.00	-41.53	Vertical	-13.00	Pass
			5235.00	-49.33	Vertical		
			3490.00	-41.66	Horizontal		
			5235.00	-54.94	Horizontal		

Remark:

1. The emission behavior belongs to narrowband spurious emission.
2. The emission levels of below 1 GHz are very lower than the limit above 10dB and not show in test report.



Band 5 Radiated Spurious Emissions							
Bandwidth	Modulation	Test Channel	Spurious Emission			Limit (dBm)	Result
			Frequency	Level (dBm)	Polarization		
10MHz	QPSK	L	3430.00	-40.43	Vertical	-13.00	Pass
			5145.00	-48.50	Vertical		
			3430.00	-46.67	Horizontal		
			5145.00	-53.93	Horizontal		
10MHz	QPSK	M	3465.00	-41.41	Vertical	-13.00	Pass
			5197.50	-47.52	Vertical		
			3465.00	-42.53	Horizontal		
			5197.50	-53.27	Horizontal		
10MHz	QPSK	H	3500.00	-41.56	Vertical	-13.00	Pass
			5250.00	-49.30	Vertical		
			3500.00	-41.76	Horizontal		
			5250.00	-53.09	Horizontal		
10MHz	16QAM	L	3430.00	-41.68	Vertical	-13.00	Pass
			5145.00	-49.60	Vertical		
			3430.00	-41.44	Horizontal		
			5145.00	-54.46	Horizontal		
10MHz	16QAM	M	3465.00	-41.83	Vertical	-13.00	Pass
			5197.50	-48.87	Vertical		
			3465.00	-41.90	Horizontal		
			5197.50	-54.92	Horizontal		
10MHz	16QAM	H	3500.00	-42.12	Vertical	-13.00	Pass
			5250.00	-48.75	Vertical		
			3500.00	-40.45	Horizontal		
			5250.00	-54.36	Horizontal		

Remark:

1. The emission behavior belongs to narrowband spurious emission.
2. The emission levels of below 1 GHz are very lower than the limit above 10dB and not show in test report.



Band 7 Radiated Spurious Emissions							
Bandwidth	Modulation	Test Channel	Spurious Emission			Limit (dBm)	Result
			Frequency	Level (dBm)	Polarization		
20MHz	QPSK	L	5020.00	-40.98	Vertical	-25.00	Pass
			7530.00	-47.31	Vertical		
			5020.00	-47.36	Horizontal		
			7530.00	-52.45	Horizontal		
20MHz	QPSK	M	5070.00	-40.19	Vertical	-25.00	Pass
			7605.00	-47.96	Vertical		
			5070.00	-42.84	Horizontal		
			7605.00	-52.14	Horizontal		
20MHz	QPSK	H	5120.00	-40.32	Vertical	-25.00	Pass
			7680.00	-48.98	Vertical		
			5120.00	-40.57	Horizontal		
			7680.00	-53.61	Horizontal		
20MHz	16QAM	L	5020.00	-40.09	Vertical	-25.00	Pass
			7530.00	-49.87	Vertical		
			5020.00	-41.35	Horizontal		
			7530.00	-54.96	Horizontal		
20MHz	16QAM	M	5070.00	-41.88	Vertical	-25.00	Pass
			7605.00	-48.47	Vertical		
			5070.00	-41.30	Horizontal		
			7605.00	-52.36	Horizontal		
20MHz	16QAM	H	5120.00	-40.82	Vertical	-25.00	Pass
			7680.00	-48.67	Vertical		
			5120.00	-42.41	Horizontal		
			7680.00	-52.89	Horizontal		

Remark:

1. The emission behavior belongs to narrowband spurious emission.
2. The emission levels of below 1 GHz are very lower than the limit above 10dB and not show in test report.



Band 17 Radiated Spurious Emissions							
Bandwidth	Modulation	Test Channel	Spurious Emission			Limit (dBm)	Result
			Frequency	Level (dBm)	Polarization		
10MHz	QPSK	L	1418.00	-40.95	Vertical	-13.00	Pass
			2127.00	-49.80	Vertical		
			1418.00	-47.02	Horizontal		
			2127.00	-52.60	Horizontal		
10MHz	QPSK	M	1420.00	-41.40	Vertical	-13.00	Pass
			2130.00	-48.89	Vertical		
			1420.00	-41.77	Horizontal		
			2130.00	-53.08	Horizontal		
10MHz	QPSK	H	1422.00	-40.58	Vertical	-13.00	Pass
			2133.00	-48.70	Vertical		
			1422.00	-41.24	Horizontal		
			2133.00	-53.45	Horizontal		
10MHz	16QAM	L	1418.00	-41.77	Vertical	-13.00	Pass
			2127.00	-47.15	Vertical		
			1418.00	-41.94	Horizontal		
			2127.00	-54.58	Horizontal		
10MHz	16QAM	M	1420.00	-41.79	Vertical	-13.00	Pass
			2130.00	-47.62	Horizontal		
			1420.00	-41.93	Vertical		
			2130.00	-52.95	Horizontal		
10MHz	16QAM	H	1422.00	-41.53	Vertical	-13.00	Pass
			2133.00	-47.03	Horizontal		
			1422.00	-41.61	Vertical		
			2133.00	-52.64	Horizontal		

Remark:

1. The emission behavior belongs to narrowband spurious emission.
2. The emission levels of below 1 GHz are very lower than the limit above 10dB and not show in test report.



Band 41 Radiated Spurious Emissions							
Bandwidth	Modulation	Test Channel	Spurious Emission			Limit (dBm)	Result
			Frequency	Level (dBm)	Polarization		
20MHz	QPSK	L	5012	-42.35	Vertical	-25.00	Pass
			7518	-48.92	Vertical		
			5012	-45.17	Horizontal		
			7518	-52.17	Horizontal		
20MHz	QPSK	M	5186	-40.48	Vertical	-25.00	Pass
			7779	-49.87	Vertical		
			5186	-41.20	Horizontal		
			7779	-52.69	Horizontal		
20MHz	QPSK	H	5360	-42.50	Vertical	-25.00	Pass
			8040	-47.33	Vertical		
			5360	-42.46	Horizontal		
			8040	-52.12	Horizontal		
20MHz	16QAM	L	5012	-41.06	Vertical	-25.00	Pass
			7518	-48.24	Vertical		
			5012	-40.67	Horizontal		
			7518	-52.29	Horizontal		
20MHz	16QAM	M	5186	-41.36	Vertical	-25.00	Pass
			7779	-48.00	Horizontal		
			5186	-42.38	Vertical		
			7779	-52.87	Horizontal		
20MHz	16QAM	H	5360	-41.97	Vertical	-25.00	Pass
			8040	-47.69	Horizontal		
			5360	-41.48	Vertical		
			8040	-52.65	Horizontal		

Remark:

1. The emission behavior belongs to narrowband spurious emission.
2. The emission levels of below 1 GHz are very lower than the limit above 10dB and not show in test report.

3.8. Frequency stability

LIMIT

Cellular Band: $\pm 2.5\text{ppm}$ PCS Band: Within the authorized frequency block

TEST CONFIGURATION

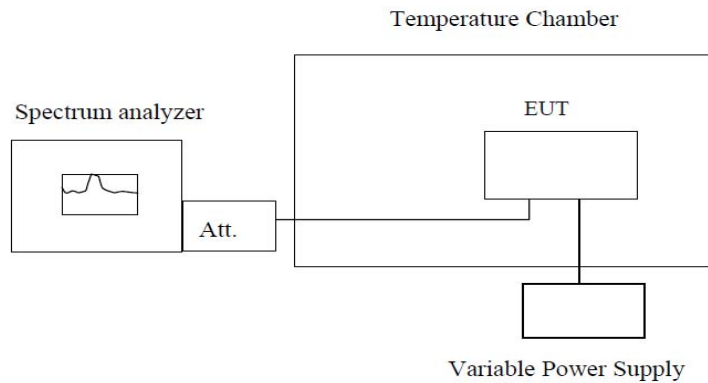

Note : Measurement setup for testing on Antenna connector

TEST PROCEDURE

1. The equipment under test was connected to an external DC power supply and input rated voltage.
2. RF output was connected to a frequency counter or spectrum analyzer via feed through attenuators.
3. The EUT was placed inside the temperature chamber.
4. Set the spectrum analyzer RBW low enough to obtain the desired frequency resolution and measure EUT 25°C operating frequency as reference frequency.
5. Turn EUT off and set the chamber temperature to -10°C. After the temperature stabilized for approximately 30 minutes recorded the frequency.
6. Repeat step measure with 10°C increased per stage until the highest temperature of +40°C reached.
7. Reduce the input voltage to specified extreme voltage variation (+/- 10%) and endpoint, record the maximum frequency change.

TEST RESULTS

Please see the appendix for every tested band.

*****THE END*****