

# Antenna Testing Report

**Customer :** Shenzhen sangge'er Polytron Technologies Inc

**Project Name :** ML1

**Antenna Manufacturer:** Sunnyway Technology(CHINA)

**Address:** The 6th floor, Building 5, Nantaiyun Innovation Valley Center,  
Guangming District, Shenzhen City

**Report version:** 2024/4/17 A0  
**Research staff:** Xu Jun

Version	Report date	Remark
A0	2024.4.17	Antenna test report
A1		
A2		
A3		
A4		
A5		
A6		
A7		
A8		
A9		

- 1. Record·····
- 2. Project Overview ·····
- 3. Equipment List·····
- 4. Antenna mounting position·····
- 5. Passive parameters ·····
- 6. Passive efficiency and gain ·····
- 7. OTA test data ·····
- 8. Directional pattern ·····
- 9. Summary·····



Prototype status	Debugging machine	Project pictures
Device type		
Number of antennas	Main antenna; diversity antenna; three-in-one antenna NFC antenna	
Frequency band	GSM : 850/900/1800/1900	
	WCDMA: B1/2/5/8	
	FDD: B1/2/3/4/5/7/8/12/14/17//25/26/66 TDD: 38/40/41	
Structural style	LDS+FPC	
Environment adjustment	Change made	
Matching modification	Change made	



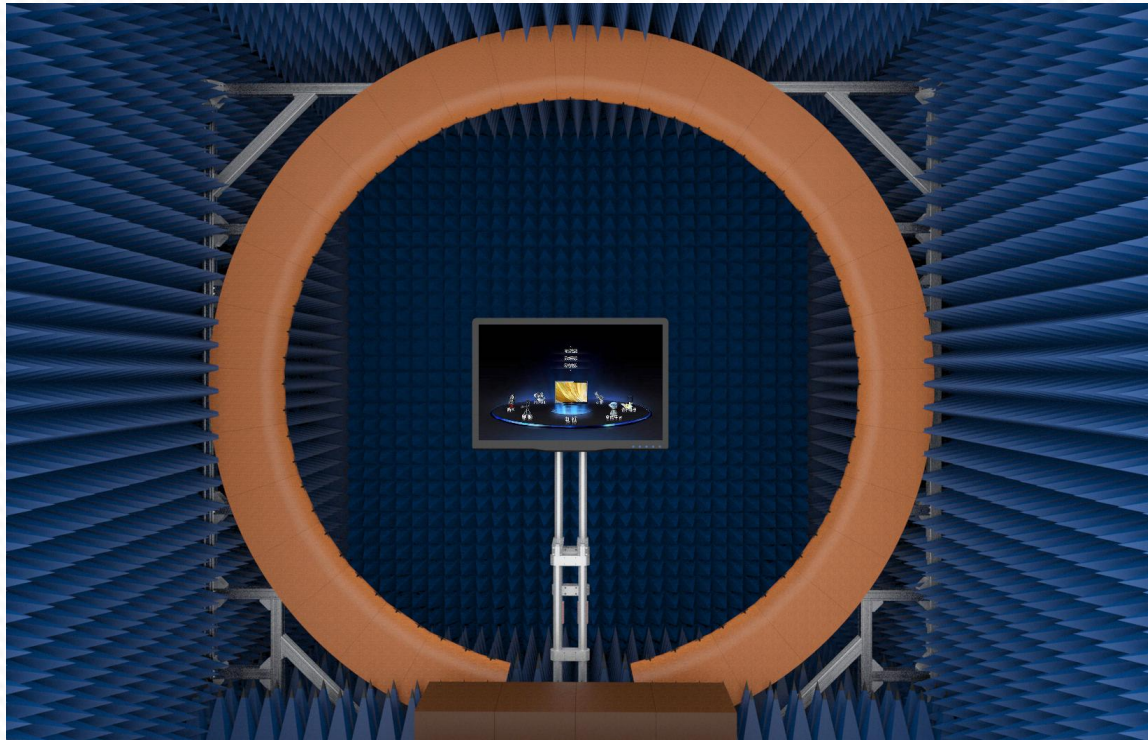

The industry's top 64 sensors OTA chamber

Frequency range: 400MHz-11GHz

Device Llimitation: 2M

Load-bearing limitation:100KG

Equipments Items	Total Quantity	Quantity for Shanghai R&D	Quantity for Shenzhen R&D	Quantity for ChongQing R&D
OTA chamber	10	4	5	1
5G Tester (SP9500-CTS)	3	1	1	1
R&S Tester (high configuration CMW500)	6	3	2	1
Japan Anritsu Tester (Dual Channel 8820)	4	2	2	--
NB-IoT Tester (SP8315)	3	1	1	1
Agilent Tester (8960)	9	4	4	--
Agilent Network Analyzer (E5062A)	7	3	3	1
Agilent Network Analyzer (E5071C 8.5GHZ )	11	5	5	1
Agilent Network Analyzer (E5071B 8.5GHZ )	7	3	3	1
R&S Network Analyzer (ZND)	9	4	4	1
R&S Network Analyzer (ZVB)	3	1	1	1
OTA head hand / ear hand / arm hand	5	2	2	1
GPS/WIFI active test equipment	5	2	2	1

Main antenna :

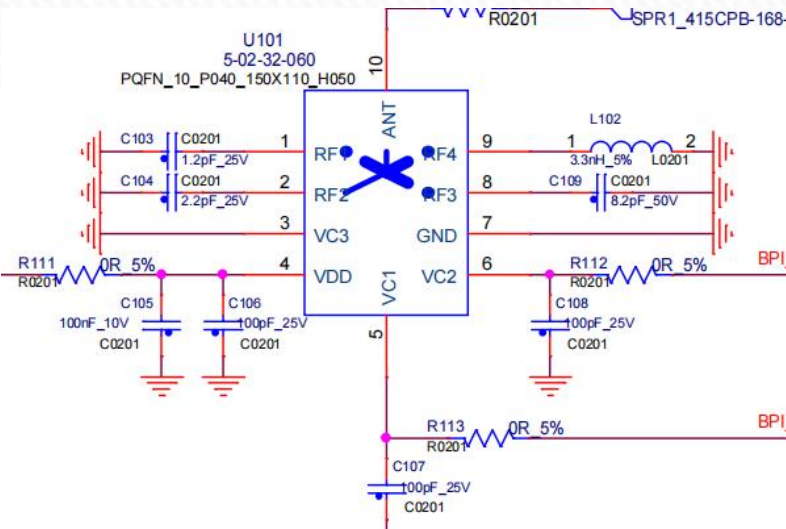
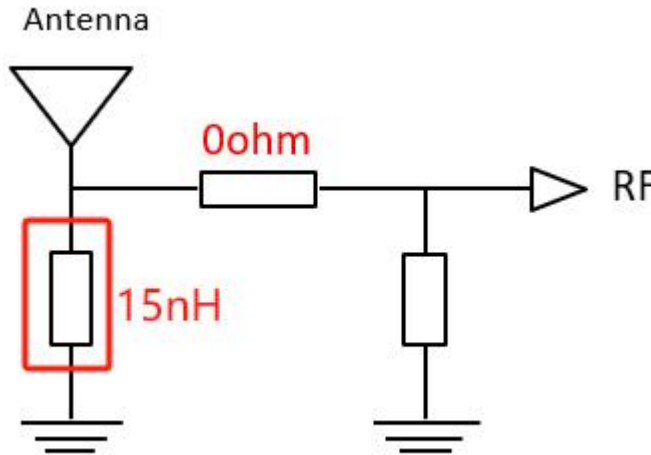

- RF1 C103:0R
- RF2 C104:4.7nH
- RF3 C109:NC
- RF4 L102:22nH

three-in-one antenna :

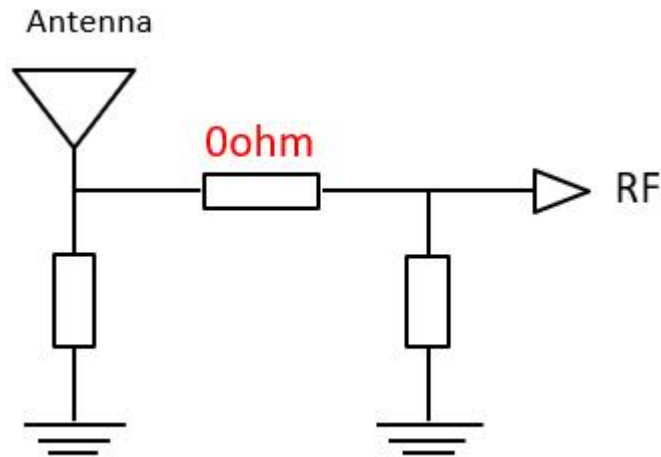

diversity antenna antenna :

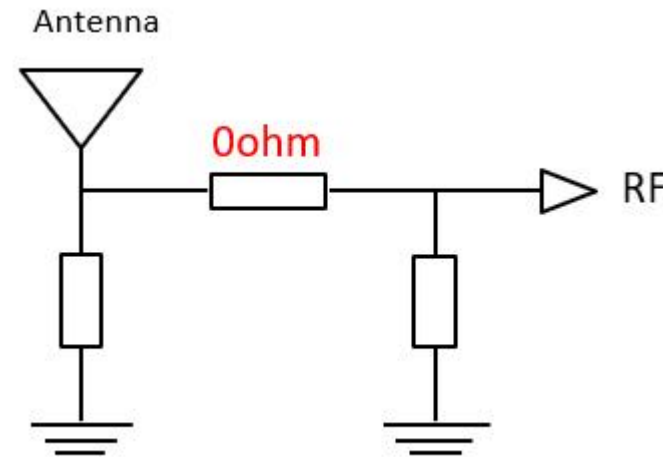



# NFC matching circuit

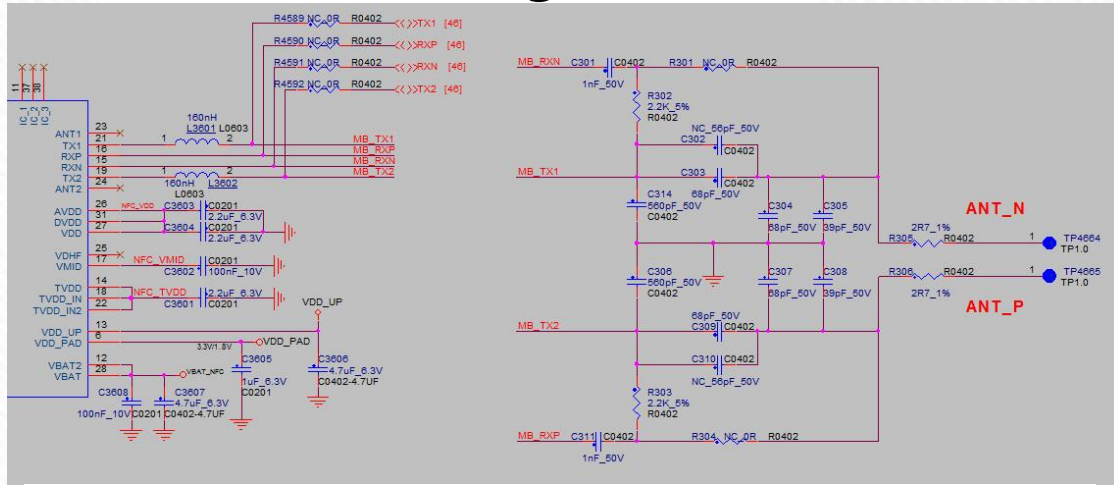

position	specifications and models	
C306/C314	820pF	0402 50V/±5%
C305/C308	47pF	0402 50V/±5%
C302/C310	27pF	0402 50V/±5%

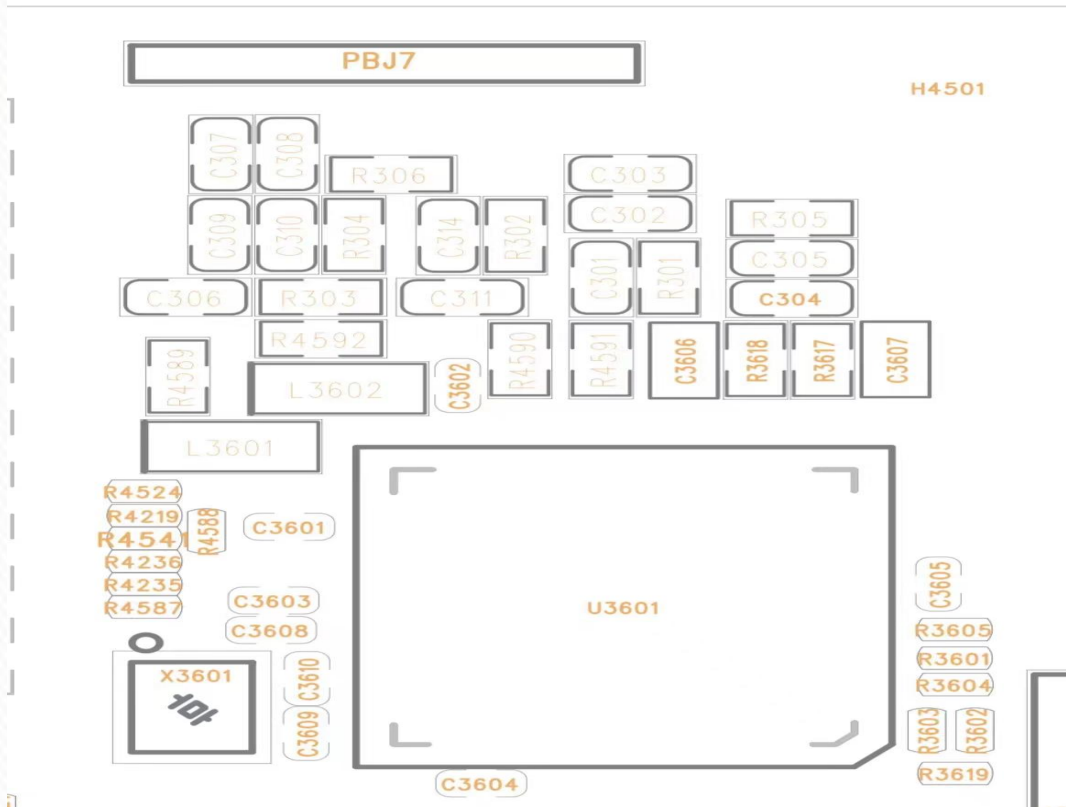

Complete machine antenna data:

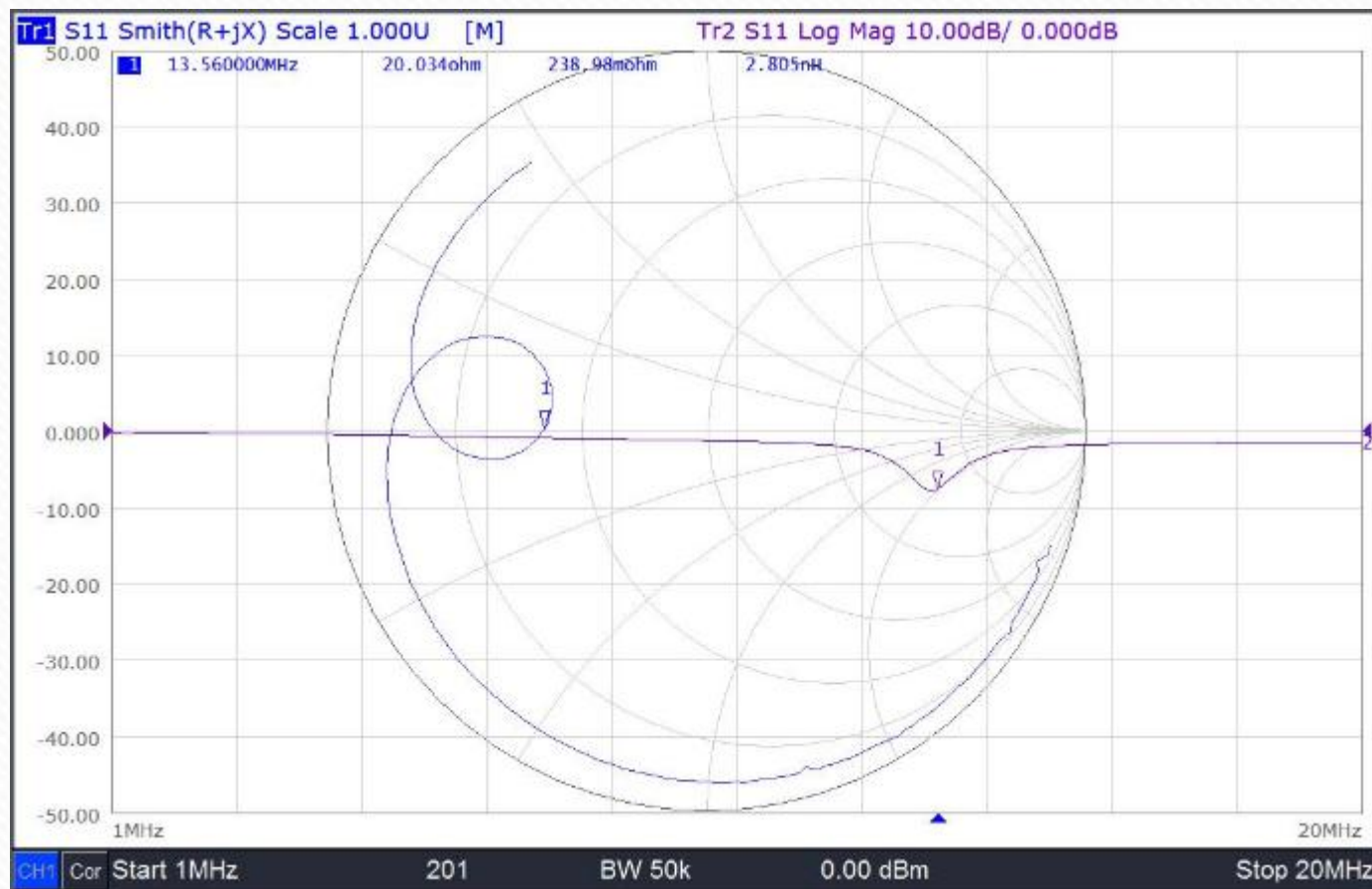



## S11-VSWR

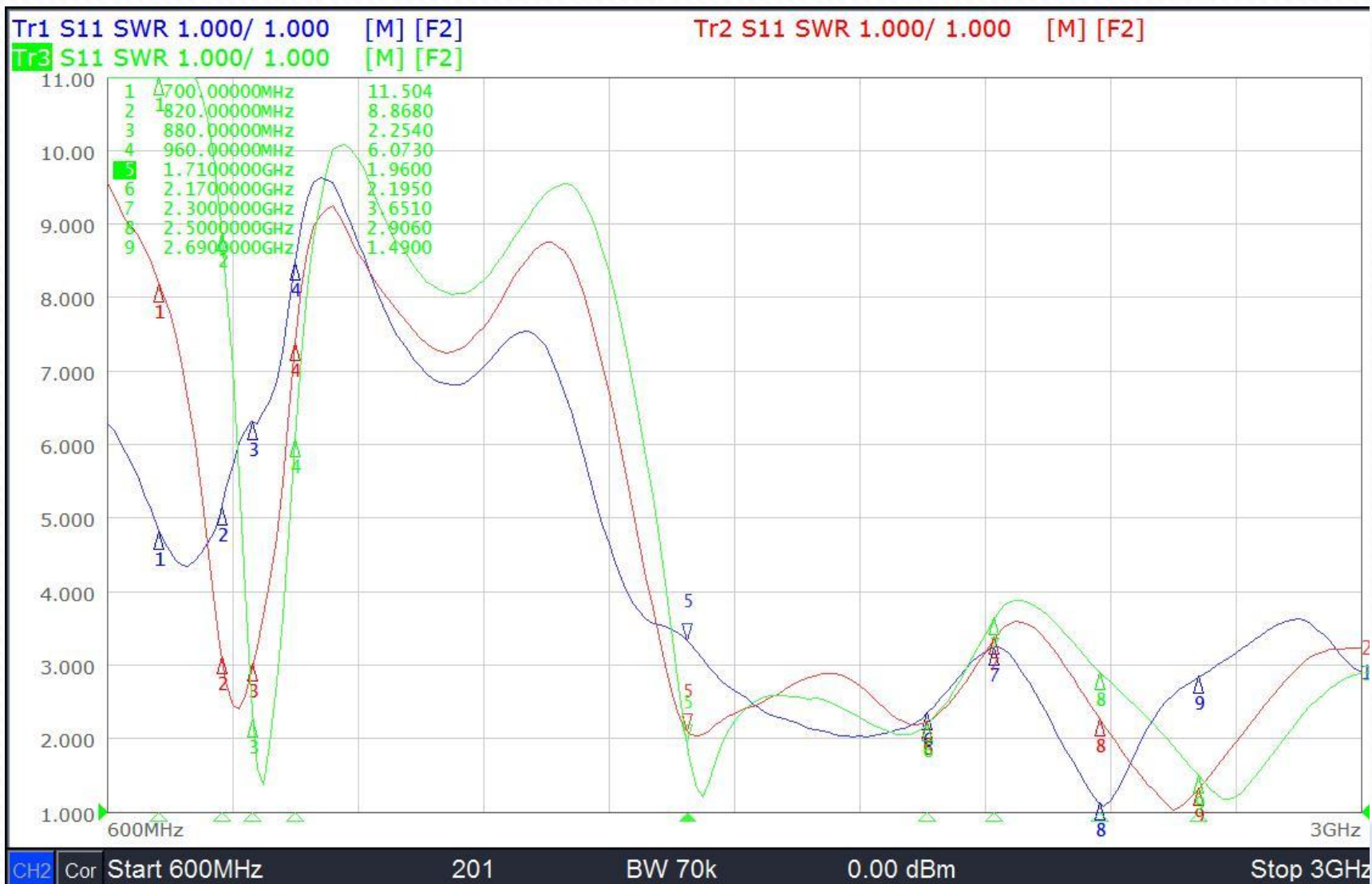

# Main antenna efficiency and gain

Frequency/MHz	MaxGain/dBi	Efficiency / %
700	-2.7	13.55
710	-3.22	13.3
720	-4.07	13.39
730	-4.39	13.97
740	-3.68	15.23
750	-3.21	15.64
760	-3.07	15.79
770	-3.05	16.3
780	-3.06	15.96
790	-2.63	16.22
800	-4.78	14.77
810	-4.82	14.85
820	-0.82	18.75
830	-1.33	19.72
840	-1.56	18.92
850	-1.68	18.32
860	-1.68	16.75
870	-1.78	15.67
880	-1.56	25.83
890	-2.27	24.42
900	-1.78	24.41
910	-0.63	28.07
920	0.09	30.12
930	-0.16	28.17
940	-1.36	22.46
950	-2.91	24.61

Frequency/MHz	MaxGain/dBi	Efficiency / %
1710	-1.76	20.05
1720	-1.17	20.27
1730	-0.8	20.07
1740	-1.31	21.33
1750	-1.81	25.35
1760	-1.21	30.2
1770	-0.84	33.19
1780	-0.89	33.5
1790	-1.21	31.41
1800	-1.17	30.69
1810	-0.78	31.62
1820	-0.9	30.55
1830	-0.89	29.31
1840	-0.79	29.51
1850	-0.77	29.92
1860	-1.06	28.12
1870	-1.22	26.98
1880	-1.19	27.29
1890	-1.21	27.61
1900	-1.19	27.1
1910	-1.15	27.35
1920	-1.23	27.61
1930	-1.31	27.23
1940	-1.05	27.86
1950	-0.88	27.99
1960	-0.83	27.93

Frequency/MHz	MaxGain/dBi	Efficiency / %
1980	-0.73	26.36
1990	-0.83	23.93
2000	-0.46	23.99
2010	-0.2	23.33
2020	-0.1	22.39
2030	0	21.58
2040	0.27	22.13
2050	0.27	21.38
2060	0.14	19.86
2070	0.25	20
2080	0.45	20.84
2090	0.41	20.61
2100	0.01	18.58
2110	0.04	18.62
2120	-0.09	18.07
2130	-0.44	17.46
2140	-0.92	16.67
2150	-1.53	15.81
2160	-1.92	15.17
2170	-2.02	15
2300	-3.43	22.33
2310	-3.65	22.19
2320	-3.6	22.88
2330	-3.71	23.09
2340	-3.72	22.65
2350	-3	23.87

Frequency/MHz	MaxGain/dBi	Efficiency / %
2370	-2.25	25.03
2380	-2.35	24.39
2390	-1.99	25.07
2400	-1.98	24.96
2410	-1.93	24.83
2420	-1.84	25
2430	-1.47	25.92
2440	-1.26	26.75
2450	-0.82	28.03
2460	-0.66	28.2
2470	-0.12	29.82
2480	0.26	31.58
2490	0.56	32.54
2500	0.73	33.12
2510	1.22	34.95
2520	1.38	35.64
2530	1.53	35.53
2540	1.92	36.67
2550	2.29	36.8
2560	2.47	35.18
2570	2.42	36.23
2580	2.51	36.61
2590	2.44	36.67
2600	2.24	36.85
2610	1.8	34.6
2620	1.55	33.39

Frequency/MHz	MaxGain/dBi	Efficiency / %
2640	1.35	31.48
2650	1.17	29.63
2660	0.97	27.99
2670	1.03	27.38
2680	0.99	26.48
2690	0.8	15.21



## Bright screen

Band	Channel	TRP	TIS
GSM850	128	24.72	
	190	25.73	
	251	25.3	-94.36
GSM900	1	24.98	
	62	23.68	
	124	23.58	-94.68
DCS1800	512	23.55	
	699	23.53	
	885	23.42	-99.73
PCS1900	512	24.16	
	661	24.7	
	810	26.06	-98.25
WCDMA_B1	9612	16.71	
	9750	16.59	
	9888	16.16	-99.74
WCDMA_B2	9262	16.98	
	9400	18.09	
	9538	18.33	-100.55
WCDMA_B5	4132	15.8	
	4183	15.09	
	4233	15.2	-96.93
WCDMA_B8	2712	15.46	
	2787	14.58	
	2863	14.32	-93.31

Band	Channel	TRP	TIS
FDD_B1(10MHz)	18050	18.77	
	18300	17.77	
	18550	17.49	-90.58
FDD_B2(10MHz)	18650	17.49	
	18900	18.62	
	19150	18.66	-91.61
FDD_B3(10MHz)	19250	14.48	
	19575	15.14	
	19900	14.97	-96.09
FDD_B4(10MHz)	20000	14.55	
	20175	14.02	
	20350	14.37	-93.44
FDD_B5(10MHz)	20450	15.93	
	20525	15.23	
	20600	14.23	-88.18
FDD_B7(10MHz)	20800	17.33	
	21100	17.85	
	21400	18	-90.01
FDD_B8(10MHz)	21500	15.54	
	21625	14.76	
	21750	14.85	-89.65
FDD_B12(10MHz)	23060	15.96	
	23095	15.95	
	23130	15.33	-83.59

Band	Channel	TRP	TIS
FDD_B14(10MHz)	23330	13.61	-84.23
FDD_B17(10MHz)	23780	15.07	
	23790	15.76	
	23800	15.34	-83.57
FDD_B25(10MHz)	26090	17.45	
	26365	18.61	
FDD_B26(10MHz)	26640	19.04	-90.34
	26740	14.56	
	26865	15.03	
FDD_B66(10MHz)	26990	15.17	-90.64
	132022	15.77	
	132322	15.69	
TDD_B38(20MHz)	132622	15.79	-90.58
	37850	18.69	
	38000	18.57	
TDD_B40(20MHz)	38150	18.78	-89.3
	38750	16.72	
	39150	16.87	
TDD_B41(20MHz)	39550	16.56	-91.05
	40340	18.84	
	40620	18.14	
	41140	17.97	-88.64



## Screen extinction

Band	Channel	TRP	TIS
GSM850	128	24.65	
	190	25.76	
	251	25.37	-94.7
GSM900	1	24.97	
	62	24.66	
	124	23.53	-95.27
DCS1800	512	23.49	
	699	23.43	
	885	23.36	-100.41
PCS1900	512	23.88	
	661	24.78	
	810	26.18	-98.84
WCDMA_B1	9612	16.86	
	9750	16.01	
	9888	16.23	-99.94
WCDMA_B2	9262	16.96	
	9400	18.08	
	9538	18.43	-100.57
WCDMA_B5	4132	15.87	
	4183	15.17	
	4233	14.77	-97.43
WCDMA_B8	2712	15.53	
	2787	14.66	
	2863	14.57	-93.68

Band	Channel	TRP	TIS
FDD_B1(10MHz)	18050	18.9	
	18300	17.9	
	18550	17.55	-90.83
FDD_B2(10MHz)	18650	17.44	
	18900	18.64	
	19150	18.71	-90.94
FDD_B3(10MHz)	19250	14.56	
	19575	15.16	
	19900	15.05	-97.12
FDD_B4(10MHz)	20000	14.63	
	20175	14.55	
	20350	14.41	-93.85
FDD_B5(10MHz)	20450	16.02	
	20525	15.31	
	20600	14.28	-88.82
FDD_B7(10MHz)	20800	17.36	
	21100	17.9	
	21400	19.08	-91.12
FDD_B8(10MHz)	21500	15.63	
	21625	14.83	
	21750	14.53	-90.07
FDD_B12(10MHz)	23060	16.02	
	23095	16.02	
	23130	15.38	-85.52

Band	Channel	TRP	TIS
FDD_B14(10MHz)	23330	13.63	-86.25
FDD_B17(10MHz)	23780	15.15	
	23790	15.8	
	23800	15.38	-84.44
FDD_B25(10MHz)	26090	17.4	
	26365	18.64	
	26640	19.15	-90.38
FDD_B26(10MHz)	26740	15.57	
	26865	15.96	
	26990	14.76	-90.77
FDD_B66(10MHz)	132022	15.83	
	132322	15.72	
	132622	15.81	-91.25
TDD_B38(20MHz)	37850	19.77	
	38000	19.73	
	38150	18.94	-89.79
TDD_B40(20MHz)	38750	16.72	
	39150	16.98	
	39550	16.47	-92.15
TDD_B41(20MHz)	40340	18.92	
	40620	18.29	
	41140	18.04	-88.76

# Main antenna Directional pattern

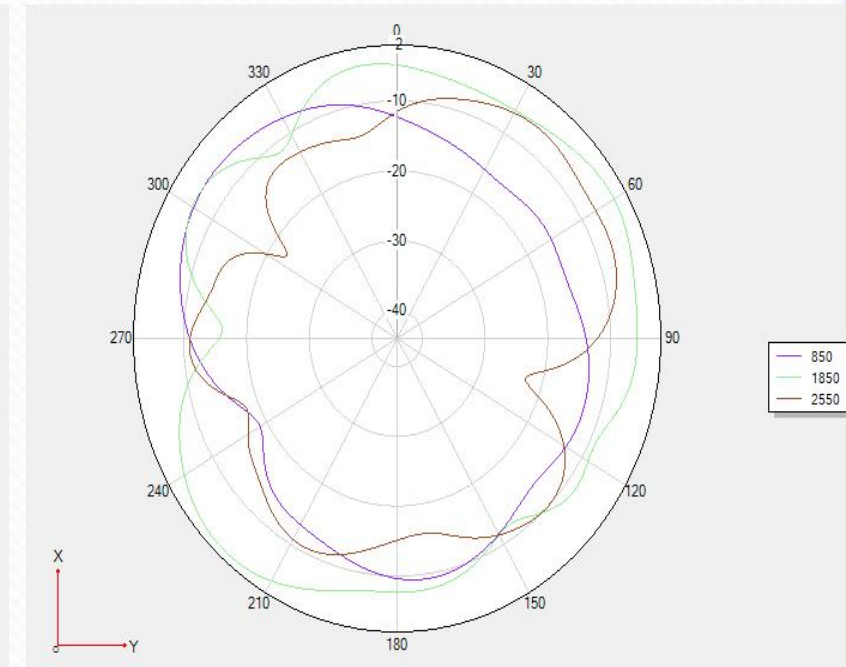
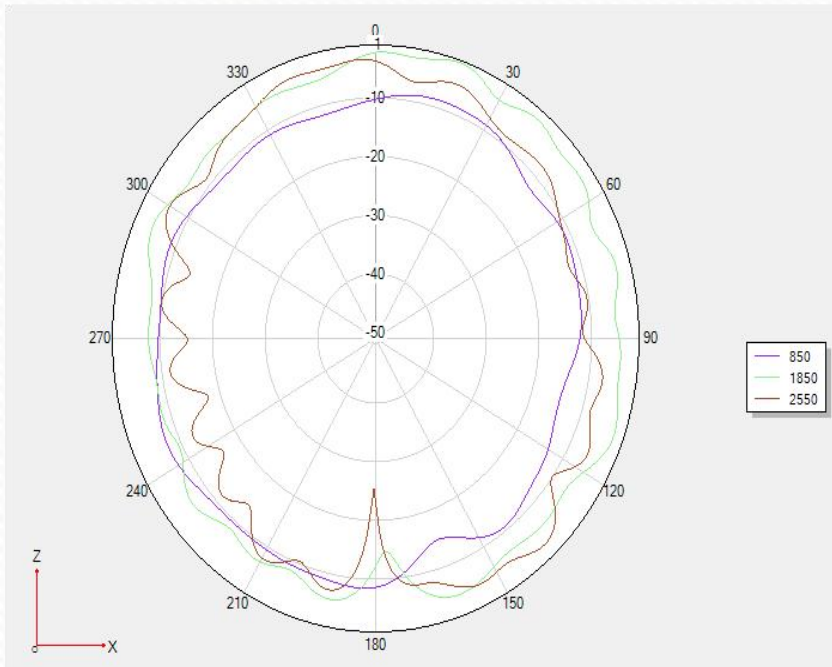

# Main antenna Directional pattern

850MHz

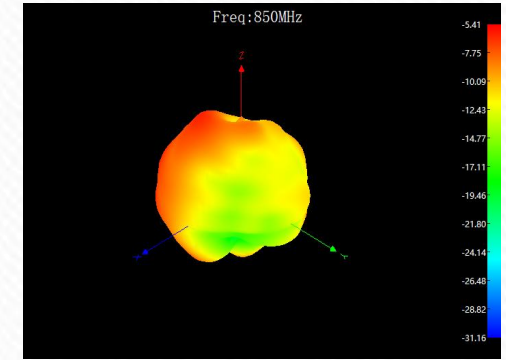
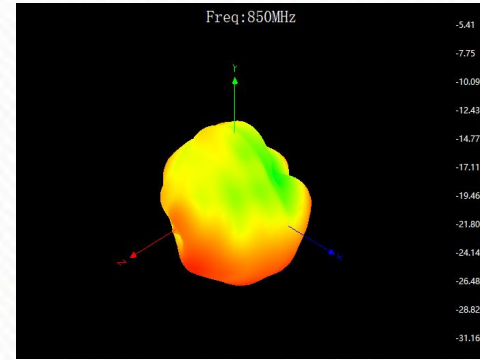
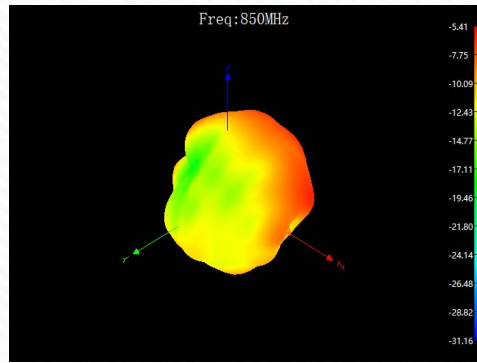

1850MHz

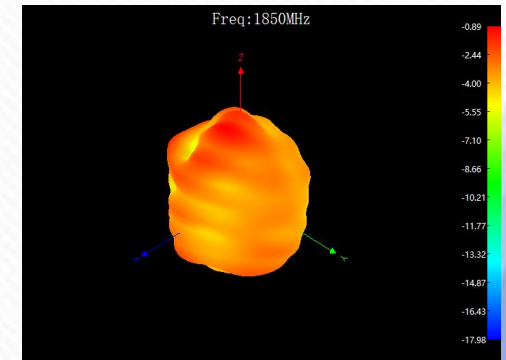
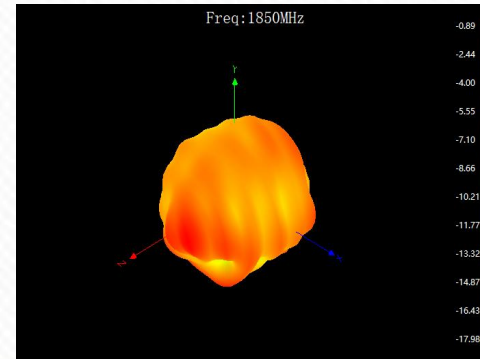
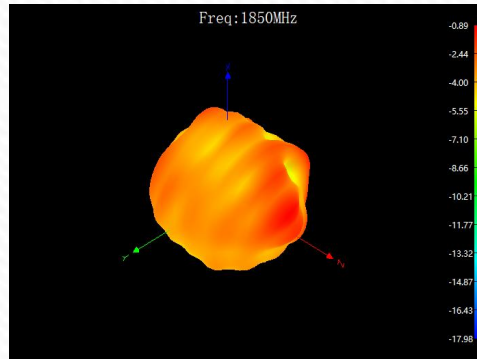

2550MHz

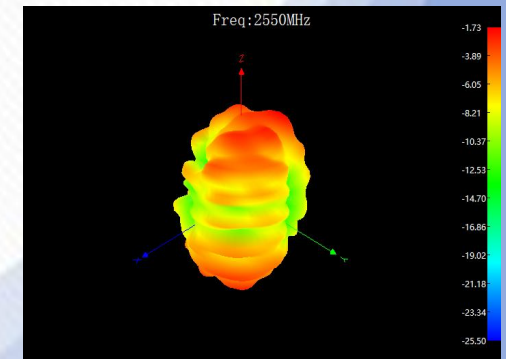
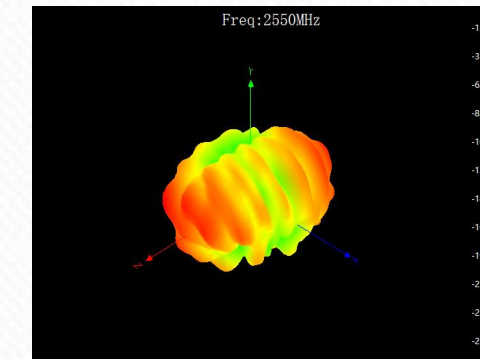
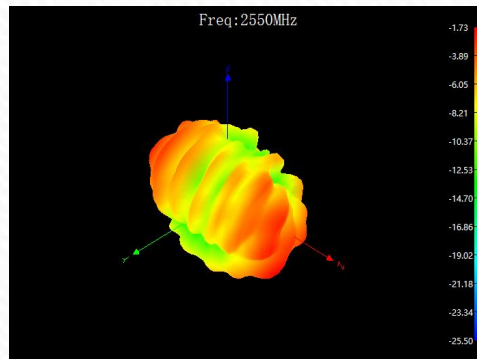



## S11-VSWR

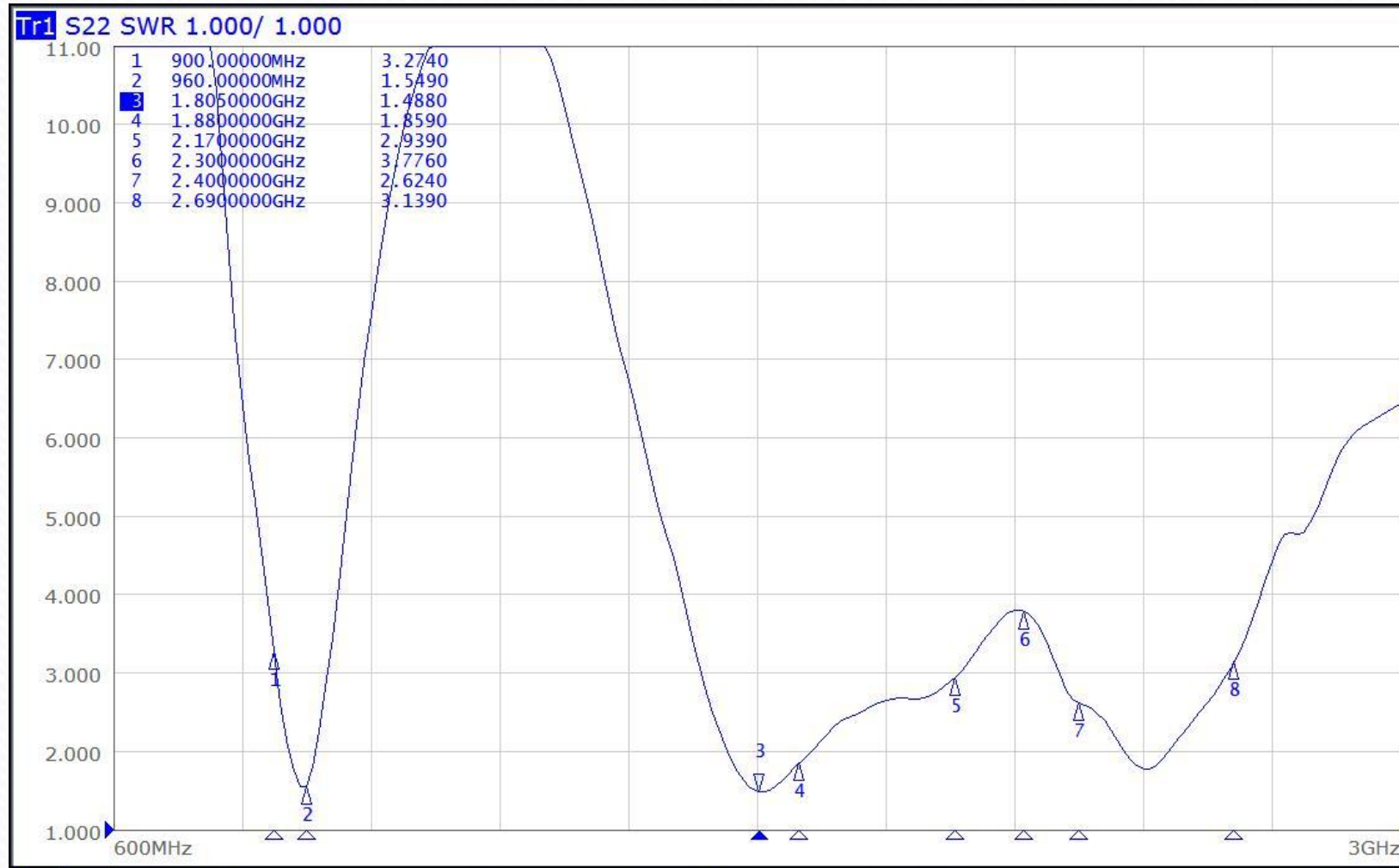

# Diversity antenna efficiency and gain

Frequenc y/Mhz	MaxGa in/dBi	Efficienc y / %
800	-14.64	0.88
810	-13.98	1
820	-13.65	1.1
830	-12.58	1.37
840	-11.61	1.71
850	-10.41	2.15
860	-9.37	2.66
870	-8.24	3.33
880	-7.4	4.19
890	-6.6	5.04
900	-5.71	6.85
910	-4.78	8.67
920	-4.2	10.23
930	-4.17	9.73
940	-3.88	9.98
950	-4.19	9.08
960	-4.86	7.87
1710	-6.38	5.46
1720	-5.53	6.81
1730	-5.14	7.55
1740	-4.52	8.75
1750	-3.82	10.09
1760	-2.84	12.13
1770	-2.23	13.68
1780	-1.74	14.96
1790	-1.53	15.28
1800	-0.98	16.41
1810	-0.22	18.45

Frequenc y/Mhz	MaxGa in/dBi	Efficienc y / %
1820	0.19	19.1
1830	0.21	19.28
1840	0.23	20.14
1850	0.29	21.43
1860	0.19	21.09
1870	0.19	21.23
1880	0.39	21.63
1890	0.63	22.8
1900	0.28	22.03
1910	-0.32	21.83
1920	-0.88	21.83
1930	-0.92	21.68
1940	-0.77	21.73
1950	-0.54	22.28
1960	-0.4	22.23
1970	-0.43	22.13
1980	-0.38	22.44
1990	-0.65	21.13
2000	-0.28	22.18
2010	-0.23	22.34
2020	-0.27	22.03
2030	-0.36	21.98
2040	-0.12	23.07
2050	-0.15	23.07
2060	-0.3	21.88
2070	-0.45	22.34
2080	-0.17	22.96
2090	-0.06	23.17

Frequenc y/Mhz	MaxGa in/dBi	Efficienc y / %
2100	0.11	22.18
2110	0.31	22.13
2120	0.76	22.59
2130	0.56	23.55
2140	0.12	22.86
2150	-0.08	23.28
2160	0.18	24.1
2170	0.26	24.43
2310	2.23	31.26
2320	2.26	32.28
2330	2.02	31.7
2340	1.66	29.99
2350	1.77	30.83
2360	1.89	31.55
2370	1.98	31.41
2380	1.75	29.31
2390	1.89	29.85
2400	1.79	29.17
2410	1.51	28.18
2420	1.05	26.06
2430	0.91	26.12
2440	0.6	25.18
2450	0.46	25.18
2460	0	23.12
2470	-0.04	23.33
2480	-0.31	23.23
2490	-0.56	22.59
2500	-1.01	21.63

Frequenc y/Mhz	MaxGa in/dBi	Efficienc y / %
2510	-0.95	22.44
2520	-1.34	21.68
2530	-1.62	20.37
2540	-1.71	20.75
2550	-1.26	21.43
2560	-1.16	21.73
2570	-1.24	21.43
2580	-1.2	22.7
2590	-1.42	23.17
2600	-1.48	24.21
2610	-1.82	23.55
2620	-1.9	23.71
2630	-1.52	25.76
2640	-1.51	26.55
2650	-1.64	25.7
2660	-1.57	25.82
2670	-1.42	26.98
2680	-1.23	26.67
2690	-1.55	25.64



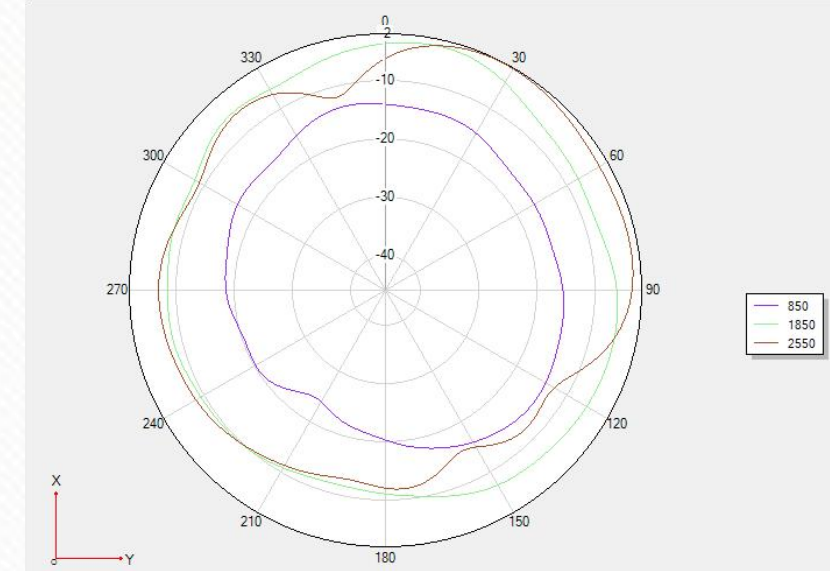
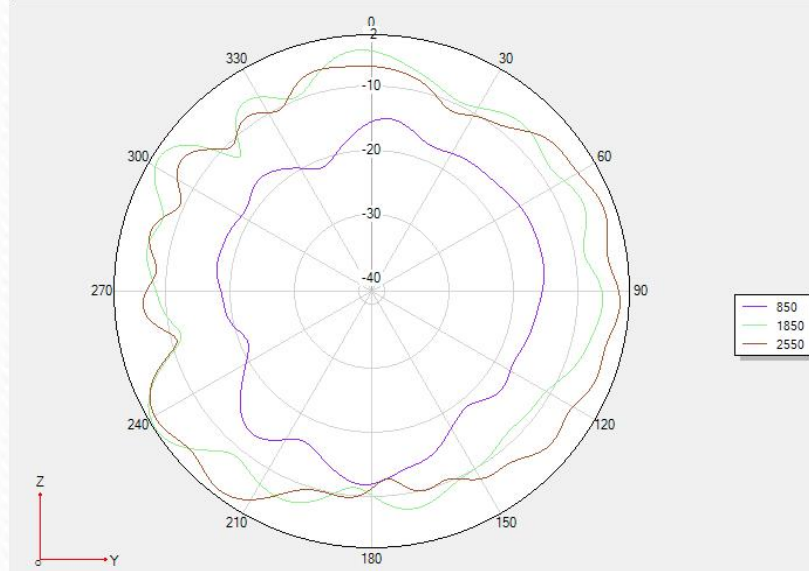
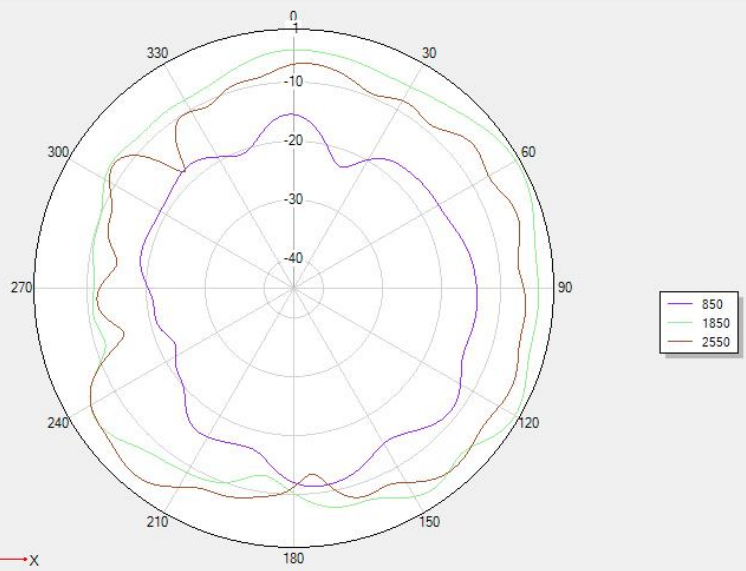



# Directional pattern Directional pattern

850Mhz

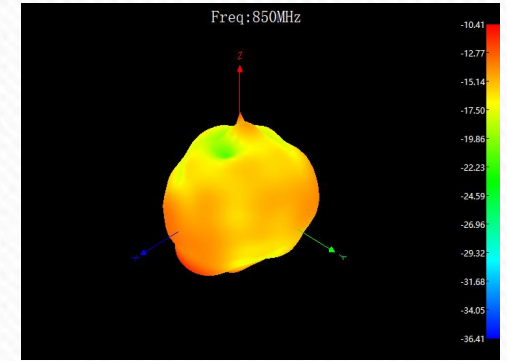
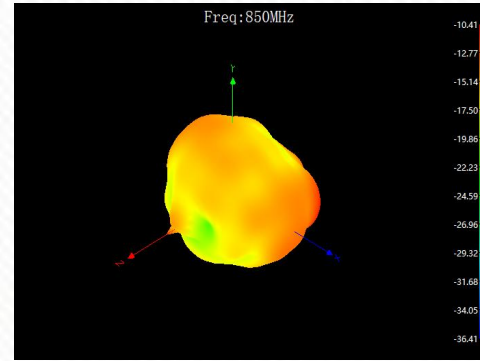
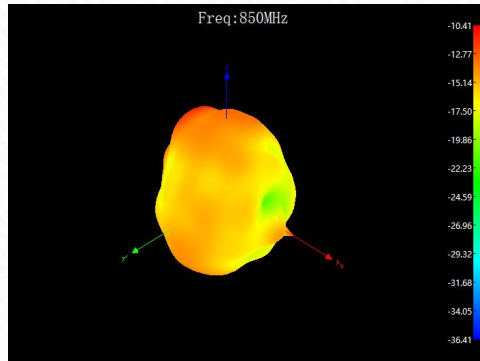

1850MHz

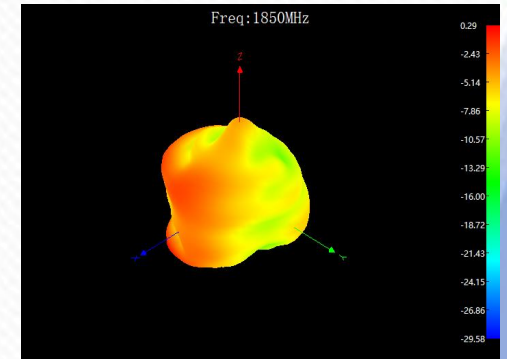
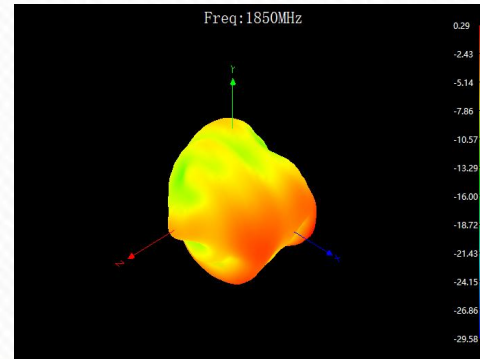
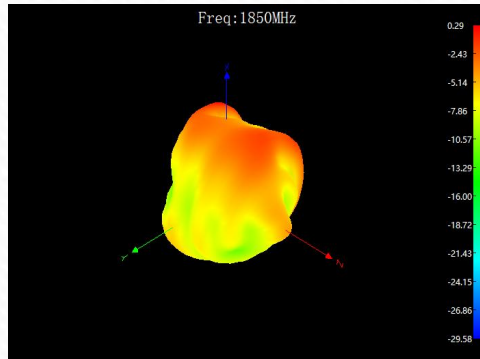

2550MHz

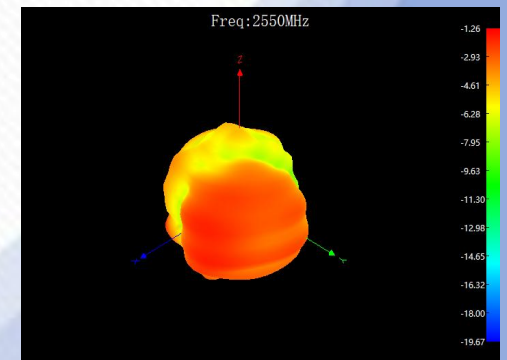
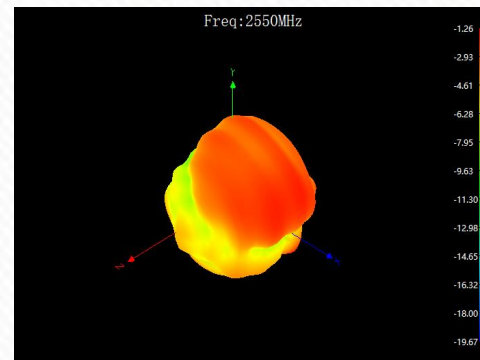
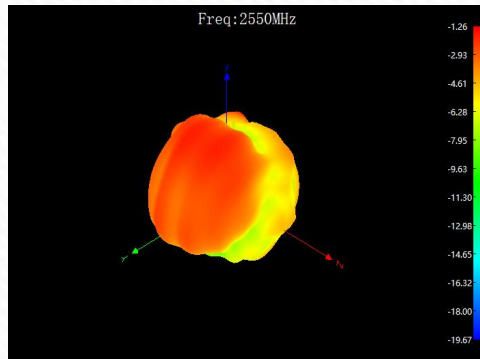

## S11-VSWR

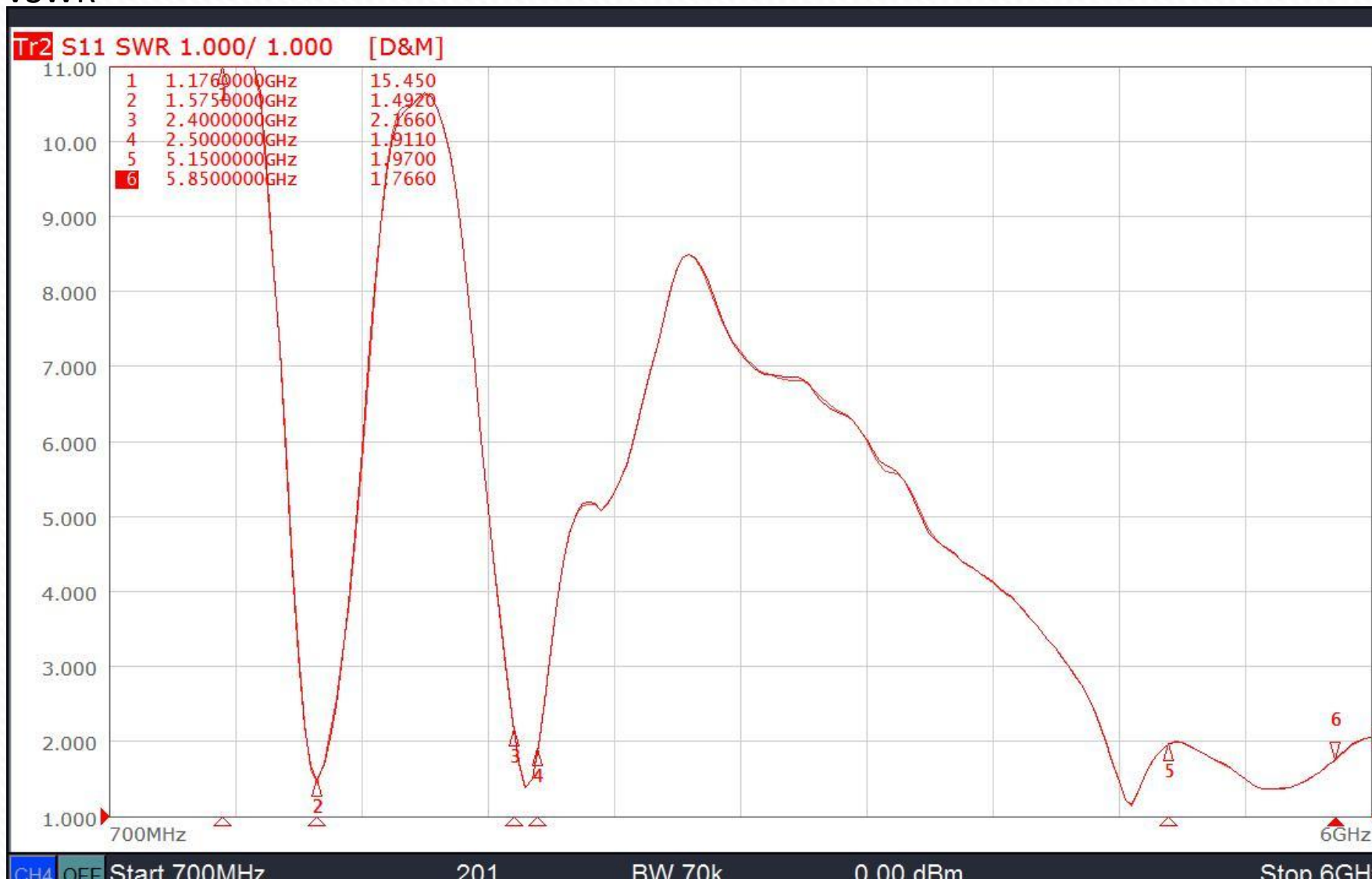

# Three-in-one antenna efficiency and gain

Frequency/ Mhz	MaxGain/ dBi	Efficiency / %
1550	0.56	35.97
1555	0.74	37.41
1560	0.78	38.28
1565	0.89	40.18
1570	0.95	41.11
<b>1575</b>	<b>1.15</b>	<b>42.76</b>
1580	1.15	42.95
1585	1.16	42.66
1590	1.2	41.98
1595	1.22	41.02
1600	1.26	40.74

Frequency/ Mhz	MaxGain/ dBi	Efficiency / %
2400	-0.78	22.78
2410	-0.54	23.83
2420	-0.84	23.67
2430	-0.62	24.99
2440	-0.46	26.36
2450	-0.39	27
2460	-0.59	26.45
2470	-0.23	27.32
2480	-0.18	27.46
2490	-0.22	26.5
2500	-0.51	25.58

Frequency/ Mhz	MaxGain/ dBi	Efficiency / %
5150	2.51	22.7
5200	3.31	24.49
5250	3.75	26.61
5300	4.01	28.64
5350	3.84	27.67
5400	3.98	29.31
5450	3.73	29.65
5500	3.64	30.55
5550	3.63	33.27
5600	3.48	33.19
5650	3.49	34.89
5700	3.36	34.9
5750	3.08	34.33
5800	3.2	35.14
5850	3.22	35.64



# WiFi antenna OTA data

Bright screen			
Measurement	Band	Channel	Total
TRP	WIFI_B (1M)	1	11.84
TRP	WIFI_B (1M)	6	12.15
TRP	WIFI_B (1M)	11	12.95
TIS(EIRP)	WIFI_B (11M)	11	-82.46
TRP	WIFI_G (6M)	1	10.43
TRP	WIFI_G (6M)	6	11.29
TRP	WIFI_G (6M)	11	11.4
TIS(EIRP)	WIFI_G (54M)	11	-69.61
TRP	WIFI_N_ISM (6.5M)	1	9.38
TRP	WIFI_N_ISM (6.5M)	6	10.29
TRP	WIFI_N_ISM (6.5M)	11	10.33
TIS(EIRP)	WIFI_N_ISM (65M)	11	-67.23
TRP	WIFI_A (6M)	36	8.93
TRP	WIFI_A (6M)	149	8.81
TRP	WIFI_A (6M)	165	9.52
TIS(EIRP)	WIFI_A (54M)	165	-68.05

Screen extinction			
Measurement	Band	Channel	Total
TRP	WIFI_B (1M)	1	11.85
TRP	WIFI_B (1M)	6	12.13
TRP	WIFI_B (1M)	11	12.32
TIS(EIRP)	WIFI_B (11M)	11	-82.91
TRP	WIFI_G (6M)	1	10.39
TRP	WIFI_G (6M)	6	11.23
TRP	WIFI_G (6M)	11	11.39
TIS(EIRP)	WIFI_G (54M)	11	-69.46
TRP	WIFI_N_ISM (6.5M)	1	9.33
TRP	WIFI_N_ISM (6.5M)	6	10.24
TRP	WIFI_N_ISM (6.5M)	11	10.31
TIS(EIRP)	WIFI_N_ISM (65M)	11	-66.42
TRP	WIFI_A (6M)	36	8.86
TRP	WIFI_A (6M)	149	8.75
TRP	WIFI_A (6M)	165	9.46
TIS(EIRP)	WIFI_A (54M)	165	-68.36



A smartphone screen displaying a table of GPS data. The table has columns for 'Elevation' and 'Azimuth'. The 'CNR' column values are highlighted in light blue. A hand is visible at the bottom of the screen, interacting with the device.

SPD	Fq	CNR	Elevation	Azimuth
2 L1		30.1	64.00	148.00
3 L1		26.1	2.00	167.00
4 L1		37.9	12.00	188.00
7 L1		34.4	59.00	313.00
8 L1		41.5	45.00	23.00
9 L1		30.7	23.00	228.00
14 L1		42.8	11.00	301.00
16 L1		32.4	14.00	85.00
17 L1		23.1	14.00	243.00
21 L1		28.3	6.00	103.00
27 L1		36.0	14.00	44.00
30 L1		44.0	27.00	318.00
71 L1		18.5	3.00	270.00
78 L1		30.7	38.00	347.00
79 L1		32.4	3.00	322.00
79 L1		28.5	12.00	117.00
80 L1		43.6	50.00	72.00
82 L1		43.7	28.00	77.00
83 L1		0.0	74.00	75.00

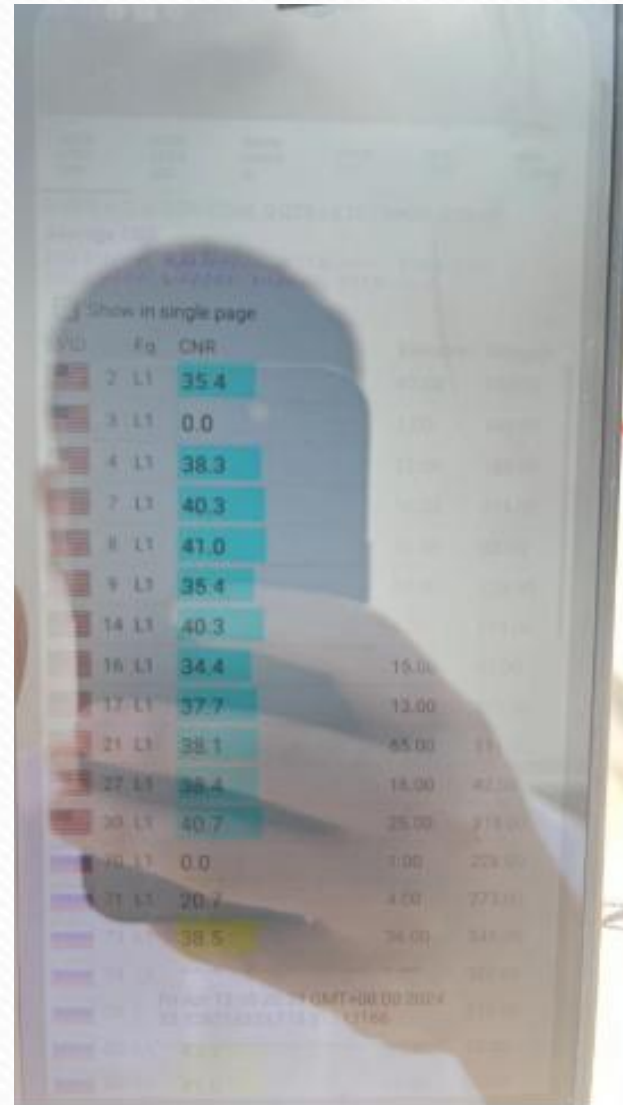

A smartphone screen displaying a table of GPS data. The table has columns for 'Elevation' and 'Azimuth'. The 'CNR' column values are highlighted in light blue. A hand is visible at the bottom of the screen, interacting with the device.

SPD	Fq	CNR	Elevation	Azimuth
2 L1		35.4	47.00	180.00
3 L1		0.0	1.00	167.00
4 L1		38.3	12.00	188.00
7 L1		40.3	59.00	313.00
8 L1		41.0	50.00	23.00
9 L1		35.4	23.00	228.00
14 L1		40.3	11.00	301.00
16 L1		34.4	15.00	85.00
17 L1		37.7	13.00	243.00
21 L1		38.1	65.00	103.00
27 L1		38.4	18.00	44.00
30 L1		40.7	25.00	318.00
70 L1		0.0	1.00	228.00
71 L1		20.7	4.00	273.00
71 L1		38.5	34.00	347.00
79 L1			3.00	322.00
79 L1			12.00	117.00
80 L1			50.00	72.00
82 L1			28.00	77.00
83 L1			74.00	75.00

# Three-in-one antenna directional pattern

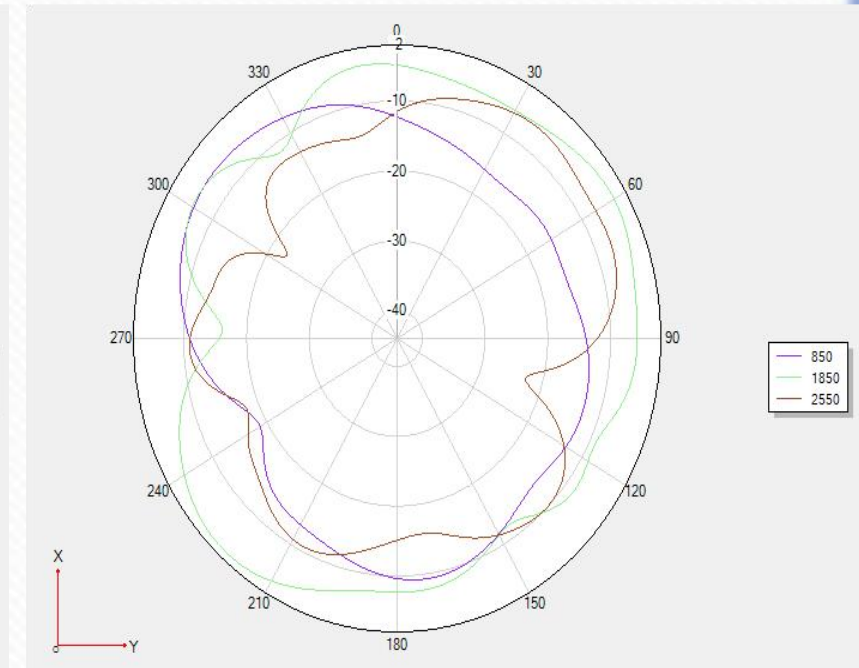
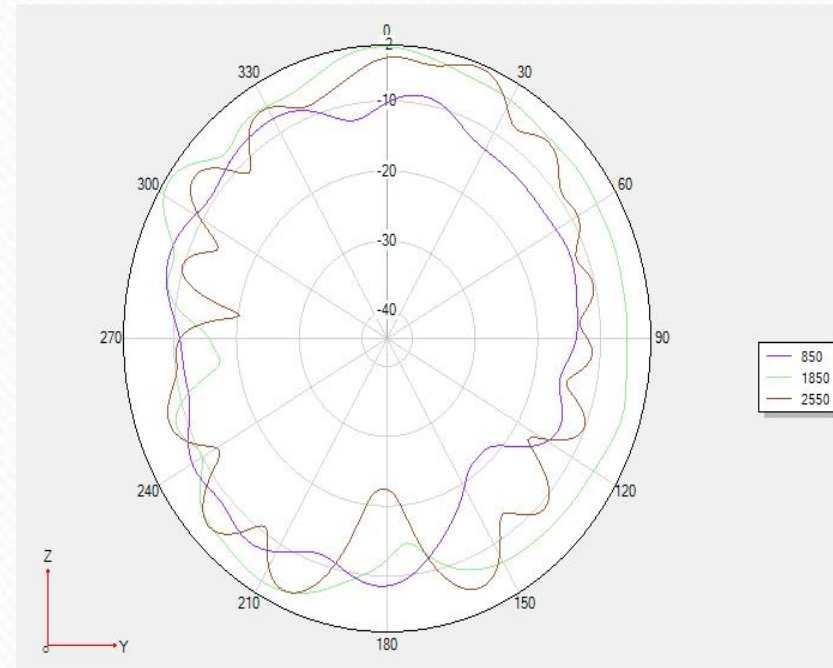
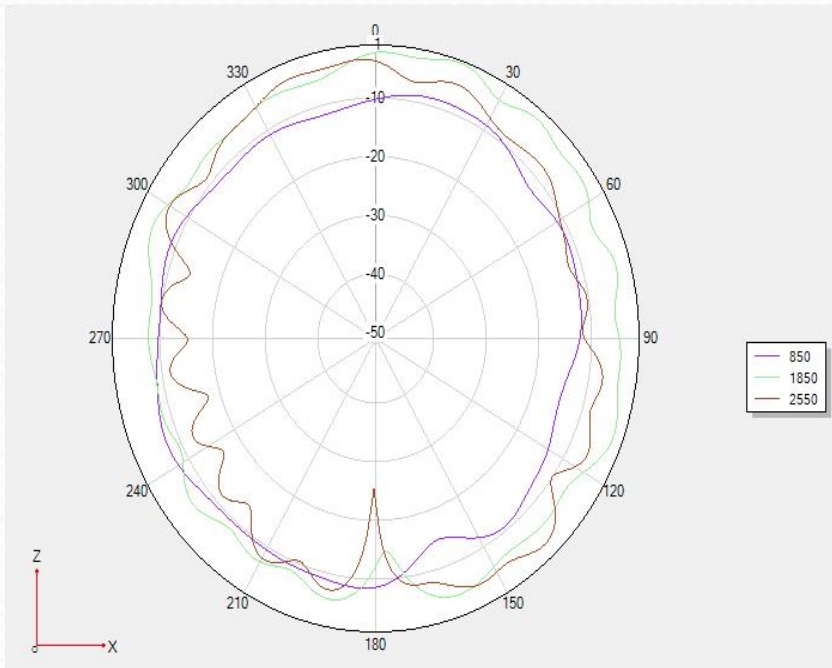



# Three-in-one antenna directional pattern

1575Mhz

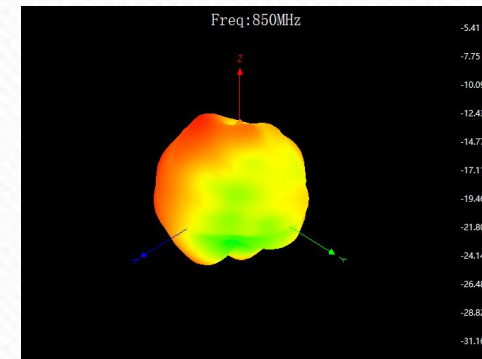
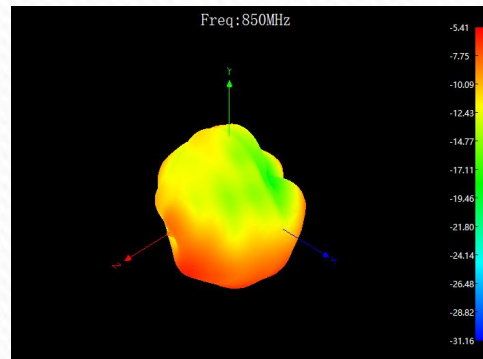
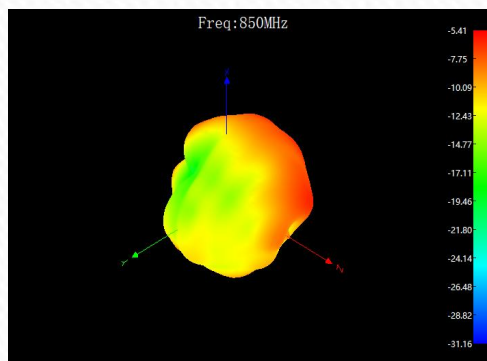

2450MHz

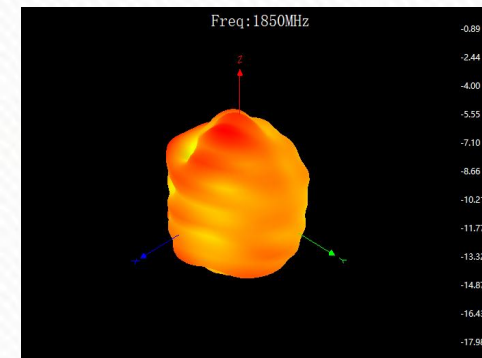
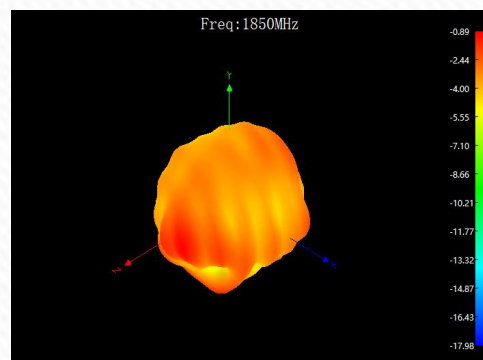
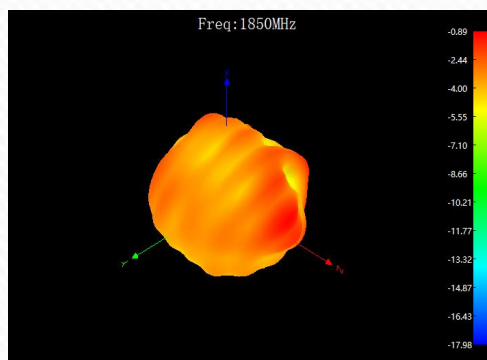

5550Mhz

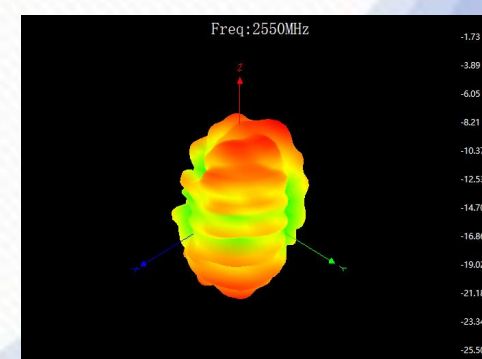
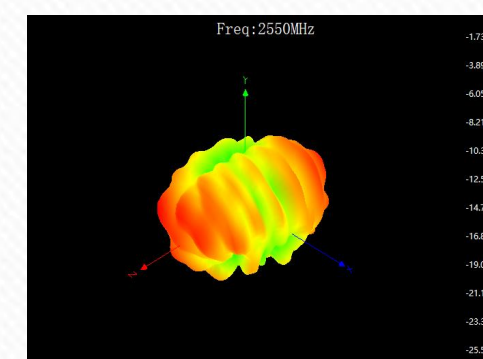
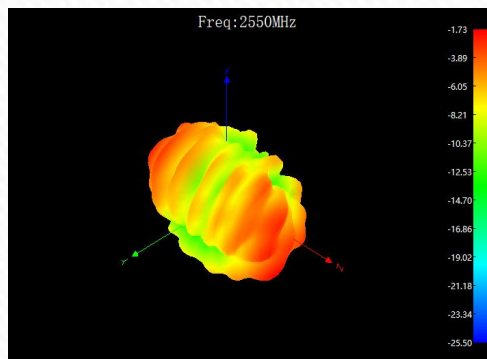

4G main ANT

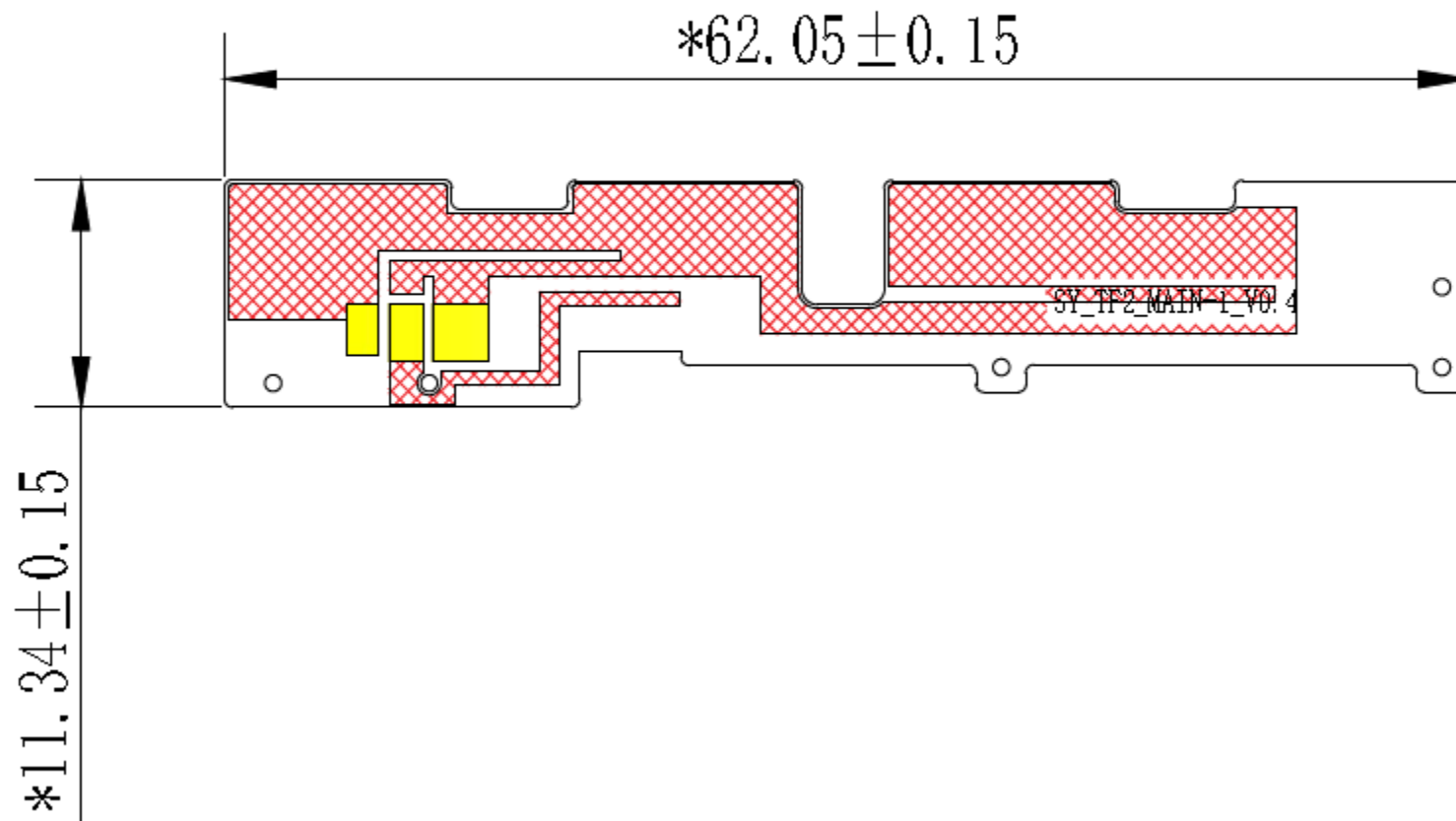

## NFC ANT

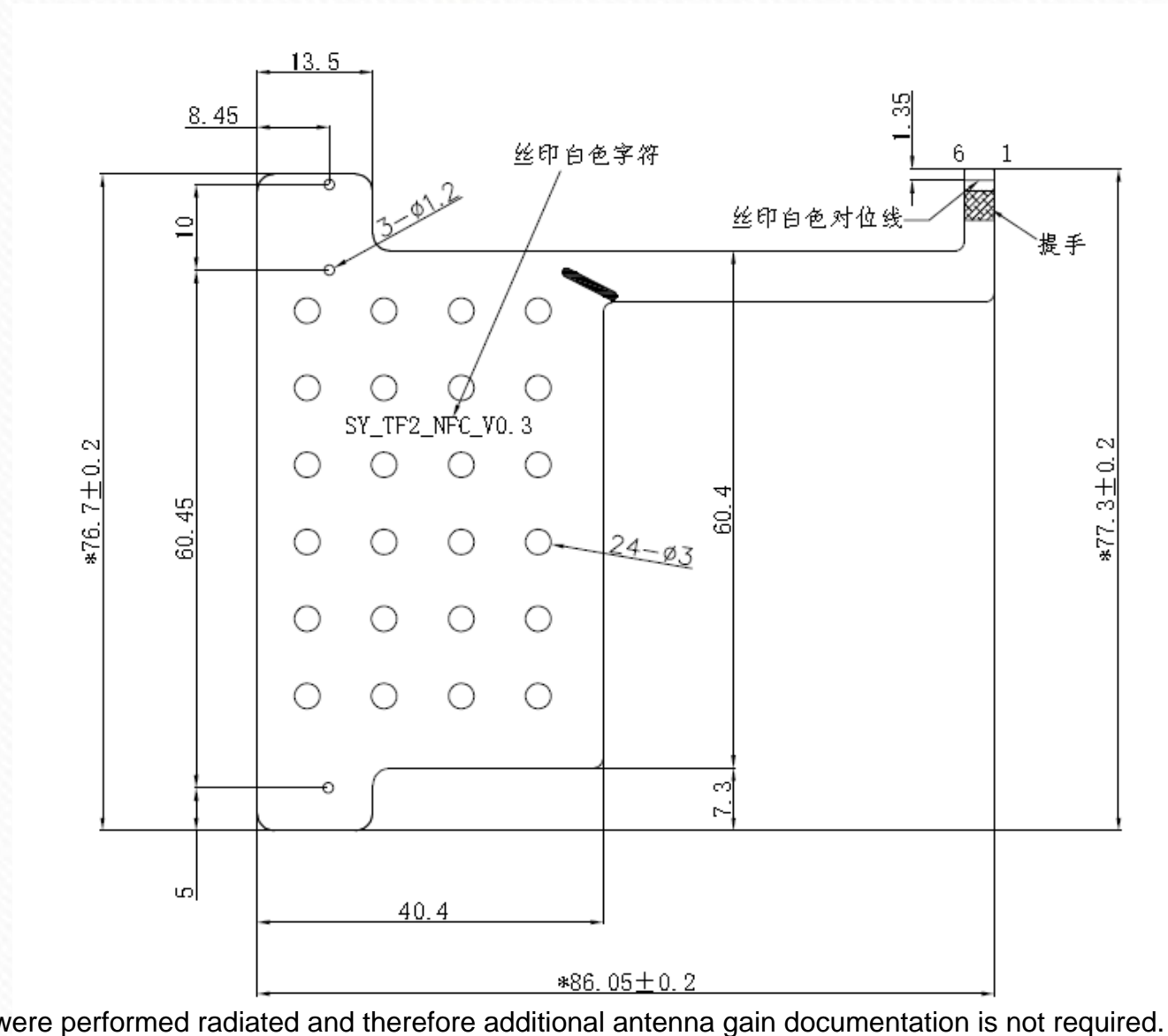

We statement that All measurements were performed radiated and therefore additional antenna gain documentation is not required.



BT&WLAN&GPS ANT

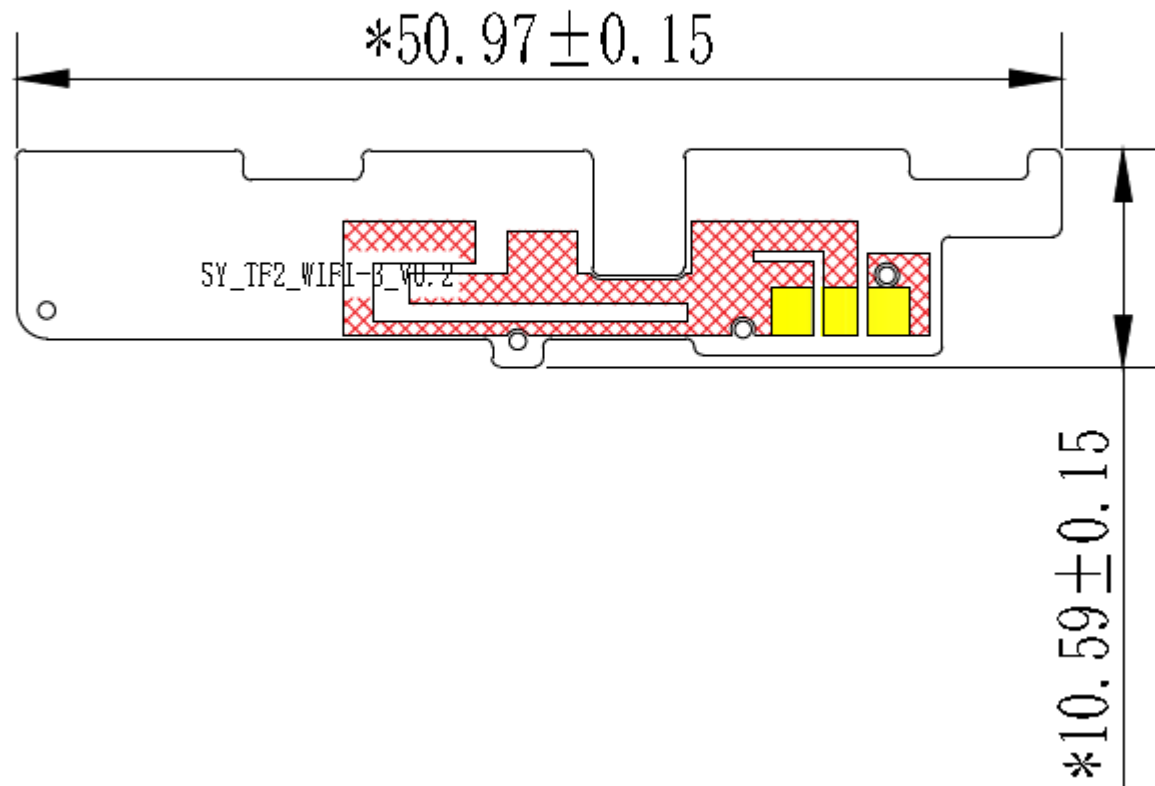

4G DIV ANT

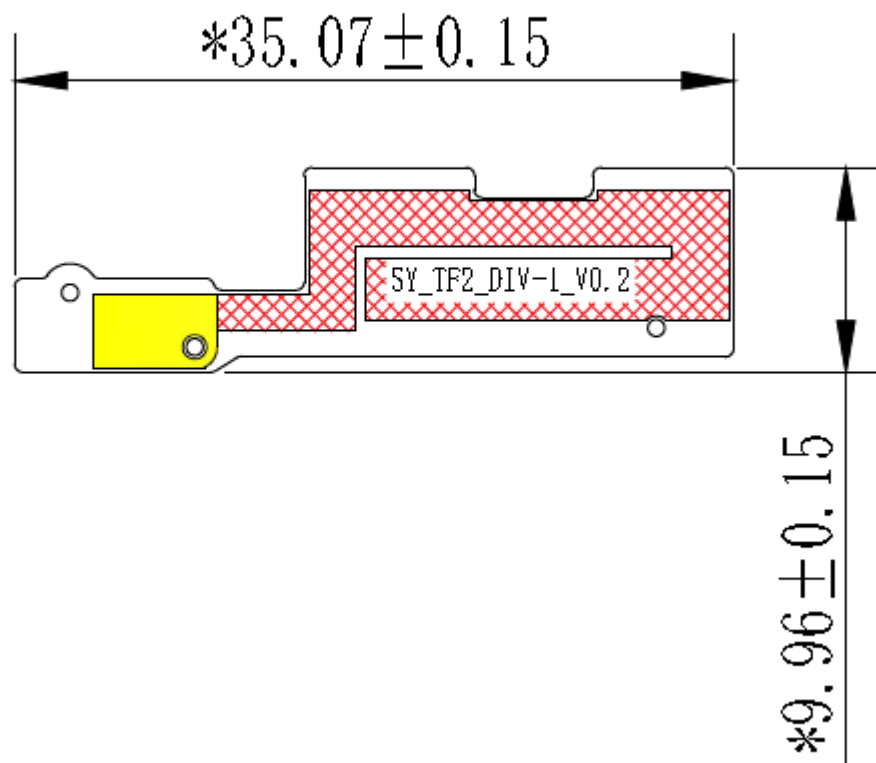

# Thank You

**Shanghai R&D Center:** 1F, Building 4, No.99, Lane 215, Gaoguang Road, Qingpu District, Shanghai, 201799, PRC

**Shenzhen R&D Center:** The 6th floor, Building 5, Nantaiyun Innovation Valley Center, Guangming District, Shenzhen City

**ChongQing R&D Center:** 1F, ARM Ecological Industrial Park, 19 East Datugu Road, Xiantao, Yubei District, Chongqing, 401120, PRC

**Huizhou Factory:** 4-5F, No.1, Central Village Road, Longhu Industrial Zone, Shuikou Town, Huicheng District, Huizhou, 516255, PRC

TEL: 021-60835368      E-mail: [sales@sunnyway-iot.com](mailto:sales@sunnyway-iot.com)

[www.sunnyway-iot.com](http://www.sunnyway-iot.com)

