



**Shenzhen CTA Testing Technology Co., Ltd.**  
 Room 106, Building 1, Yibaolai Industrial Park, Qiaotou Community, Fuhai Street, Bao'an District, Shenzhen, China

## FCC PART 15 SUBPART C TEST REPORT

### FCC PART 15.407

**Report Reference No.....: CTA24050902604**

**FCC ID.....: 2AYD5-I24P01**

Compiled by

( position+printed name+signature) .: File administrators Jinghua Xiao

Supervised by

( position+printed name+signature) .: Test Engineer Lushan Kong

Approved by

( position+printed name+signature) .: Manager Eric Wang

Date of issue .....: May. 11, 2024

**Representative Laboratory Name.: Shenzhen CTA Testing Technology Co., Ltd.**

Address .....: Room 106, Building 1, Yibaolai Industrial Park, Qiaotou Community, Fuhai Street, Bao'an District, Shenzhen, China

**Applicant's name.....: Imin Technology Pte Ltd**

Address .....: 11 Bishan Street 21, #03-05 Bosch Building, Singapore 573943

**Test specification .....**

Standard.....: **FCC Part 15.407: General technical requirements**

TRF Originator.....: Shenzhen Global Test Service Co.,Ltd.

Master TRF .....: Dated 2014-12

**Shenzhen CTA Testing Technology Co., Ltd. All rights reserved.**

This publication may be reproduced in whole or in part for non-commercial purposes as long as the Shenzhen CTA Testing Technology Co., Ltd. is acknowledged as copyright owner and source of the material. Shenzhen CTA Testing Technology Co., Ltd. takes no responsibility for and will not assume liability for damages resulting from the reader's interpretation of the reproduced material due to its placement and context.

**Test item description .....** **Mobile Data Terminal, Mobile Computer, Handheld Data Terminal, Wireless Handheld Terminal**

Trade Mark .....:

Manufacturer .....: Imin Technology Pte Ltd

Model/Type reference .....: I24P01

Listed Models .....: N/A

Operation Frequency.....: From 5180MHz to 5240MHz/ 5260MHz to 5320MHz/ 5500MHz to 5700MHz/ 5745MHz to 5825MHz

Hardware Version .....: N/A

Software Version.....: N/A

Rating .....: DC 3.87V by battery  
Recharged by DC 9.0V

Result .....: **PASS**

# TEST REPORT

<b>Test Report No.:</b> CTA24050902604	May. 11, 2024 Date of issue
--	--------------------------------

Equipment under Test : Mobile Data Terminal, Mobile Computer, Handheld Data Terminal, Wireless Handheld Terminal

Model /Type : I24P01

Listed model : N/A

**Applicant** : **Imin Technology Pte Ltd**

Address : 11 Bishan Street 21, #03-05 Bosch Building, Singapore 573943

**Manufacturer** : **Imin Technology Pte Ltd**

Address : 11 Bishan Street 21, #03-05 Bosch Building, Singapore 573943

<b>Test Result:</b>	<b>PASS</b>
---------------------	-------------

The test report merely corresponds to the test sample.  
It is not permitted to copy extracts of these test result without the written permission of the test laboratory.

## Contents

<b>1. TEST STANDARDS .....</b>	<b>4</b>
<b>2. SUMMARY .....</b>	<b>5</b>
2.1. General Remarks .....	5
2.2. Product Description .....	5
2.3. Equipment Under Test .....	5
2.4. Short description of the Equipment under Test (EUT) .....	8
2.5. EUT operation mode .....	8
2.6. Block Diagram of Test Setup .....	9
2.7. Related Submittal(s) / Grant (s) .....	9
2.8. EUT Exercise Software .....	9
2.9. Special Accessories .....	9
2.10. External I/O Cable .....	9
2.11. Modifications .....	9
<b>3. TEST ENVIRONMENT .....</b>	<b>10</b>
3.1. Address of the test laboratory .....	10
3.2. Test Facility .....	10
3.3. Environmental conditions .....	10
3.4. Statement of the measurement uncertainty .....	10
3.5. Test Description .....	11
3.6. Equipments Used during the Test.....	13
<b>4. TEST CONDITIONS AND RESULTS .....</b>	<b>14</b>
4.1. AC Power Conducted Emission .....	14
4.2. Radiated Emission .....	16
4.3. Duty Cycle .....	26
4.4. Maximum Average Output Power .....	27
4.5. Power Spectral Density .....	28
4.6. 99% and 6dB Bandwidth .....	29
4.7. 99% and 26dBc Bandwidth .....	30
4.8. Conducted Spurious Emissions and Band Edge Compliance .....	31
4.9. Frequency Stability.....	33
4.10. Antenna Requirement .....	37
<b>5. TEST SETUP PHOTOS OF THE EUT.....</b>	<b>38</b>
<b>6. EXTERNAL AND INTERNAL PHOTOS OF THE EUT .....</b>	<b>38</b>

## 1. TEST STANDARDS

The tests were performed according to following standards:

[FCC Rules Part 15.407](#): General technical requirements.

[ANSI C63.10-2020](#): American National Standard for Testing Unlicensed Wireless Devices

[KDB 789033 D02 General U-NII Test Procedures New Rules v02r01](#): UNII, U-NII, U-NII Test Procedures

## 2. SUMMARY

### 2.1. General Remarks

Date of receipt of test sample	:	Apr. 13, 2024
Testing commenced on	:	Apr. 13, 2024
Testing concluded on	:	May. 10, 2024

### 2.2. Product Description

Product Name:	Mobile Data Terminal, Mobile Computer, Handheld Data Terminal, Wireless Handheld Terminal
Trade Mark:	
Model/Type reference:	I24P01
List Model:	N/A
Model Declaration	N/A
Power supply:	DC 3.87V by battery Recharged by DC 9.0V
Hardware Version	N/A
Software Version	N/A
Sample ID	GTS20240329015-1-S0001-1#, GTS20240329015-1-S0001-2#
Bluetooth	
Frequency Range	2402MHz ~ 2480MHz
Channel Number	79 channels for Bluetooth (DSS) 40 channels for Bluetooth (DTS)
Channel Spacing	1MHz for Bluetooth (DSS) 2MHz for Bluetooth (DTS)
Modulation Type	GFSK, $\pi/4$ -DQPSK, 8-DPSK for Bluetooth (DSS) GFSK for Bluetooth (DTS)
2.4G WLAN	
WLAN Operation frequency	IEEE 802.11b:2412-2462MHz IEEE 802.11g:2412-2462MHz IEEE 802.11n HT20:2412-2462MHz
WLAN Modulation Type	IEEE 802.11b: DSSS (CCK, DQPSK, DBPSK) IEEE 802.11g: OFDM (64QAM, 16QAM, QPSK, BPSK) IEEE 802.11n HT20: OFDM (64QAM, 16QAM, QPSK, BPSK)
Channel number:	11 Channel for IEEE 802.11b/g/n (HT20)
Channel separation:	5MHz
WIFI (5.2G/5.3G/5.7G/5.8G Band)	
Frequency Range	5180-5240MHz/ 5260MHz to 5320MHz/ 5500MHz to 5700MHz/ 5745MHz to 5825MHz
Channel Number	4 Channels for 20MHz bandwidth(5180-5240MHz) 4 Channels for 20MHz bandwidth(5260-5320MHz) 11 Channels for 20MHz bandwidth(5500-5700MHz) 5 channels for 20MHz bandwidth(5745-5825MHz) 2 channels for 40MHz bandwidth(5190~5230MHz) 2 channels for 40MHz bandwidth(5270~5310MHz) 5 Channels for 40MHz bandwidth(5510-5670MHz) 2 channels for 40MHz bandwidth(5755~5795MHz) 1 channels for 80MHz bandwidth(5210MHz) 1 channels for 80MHz bandwidth(5290MHz) 2 Channels for 80MHz bandwidth(5530-5610MHz) 1 channels for 80MHz bandwidth(5775MHz)
Modulation Type	IEEE 802.11a: OFDM (64QAM, 16QAM, QPSK, BPSK) IEEE 802.11n HT20: OFDM (64QAM, 16QAM, QPSK, BPSK)

	IEEE 802.11n HT40: OFDM (64QAM, 16QAM, QPSK, BPSK) IEEE 802.11ac VHT20: OFDM (256QAM,64QAM, 16QAM, QPSK, BPSK) IEEE 802.11ac VHT40: OFDM (256QAM,64QAM, 16QAM, QPSK, BPSK) IEEE 802.11ac VHT80: OFDM (256QAM,64QAM, 16QAM, QPSK, BPSK)
Antenna Description	Internal Antenna, -0.18dBi(Max.) for 2.4G Band and 4.01dBi(Max.) for 5G Band
<b>2G</b>	
Support Band	GPRS850/GPRS1900/EDGE850/EDGE1900
Release Version	R99
GPRS Class	Class 12
EGPRS Class	Class 12
GPRS/EDGE Multislot Class	GPRS/EDGE: Multi-slot Class 12
Type Of Modulation	GMSK for GPRS; GMSK/8PSK for EGPRS
Antenna Description	Internal Antenna -0.82dBi (max.) For GPRS850/EDGE850 -0.77dBi (max.) For GPRS1900/EDGE1900
<b>3G</b>	
UMTS Operation Frequency Band	UMTS FDD Band 2(1850 MHz -1910MHz) UMTS FDD Band 5(824 MHz -849MHz)
WCDMA Release Version	R7
HSDPA Release Version	Release 5
HSUPA Release Version	Release 6
HSPA+ Release Version	Release 7
Modulation Type	QPSK for UMTS
Antenna Description	Internal Antenna -0.77dBi (max.) For WCDMA Band 2 -0.82dBi (max.) For WCDMA Band 5
<b>LTE</b>	
LTE Operation Frequency Band	E-UTRA Band 2(1850 MHz -1910MHz) E-UTRA Band 4(1710 MHz -1755MHz) E-UTRA Band 5(824 MHz -849MHz) E-UTRA Band 7(2500 MHz -2570MHz) E-UTRA Band 12(699 MHz -716MHz) E-UTRA Band 14(788 MHz -798MHz) E-UTRA Band 17(704 MHz -716MHz) E-UTRA Band 25(1850 MHz -1915MHz) E-UTRA Band 26(814 MHz -824MHz) E-UTRA Band 26(824 MHz -849MHz) E-UTRA Band 41(2496 MHz -2690MHz) E-UTRA Band 66(1710 MHz -1780MHz)
LTE Release Version	R10
Type Of Modulation	QPSK/16QAM
Antenna Description	Internal Antenna; -0.77dBi (max.) For LTE Band 2; -0.8dBi (max.) For LTE Band 4; -0.82dBi (max.) For LTE Band 5; 2.47dBi (max.) For LTE Band 7; -2.7dBi (max.) For LTE Band 12; -2.63dBi (max.) For LTE Band 14; -2.7dBi (max.) For LTE Band 17;

	-0.77dBi (max.) For LTE Band 25; -0.82dBi (max.) For LTE Band 26; 2.51dBi (max.) For LTE Band 41; -0.8dBi (max.) For LTE Band 66;
RFID(13.56MHz) (Optional)	
Frequency Range	13.56MHz
Channel Number	1
Modulation Type	ASK
Antenna Description	Internal Antenna, 0dBi (Max.)
GPS(RX)	Support
Remark:The I24P01 model has 2 versions; Version A: With fingerprint recognition function Version B: No fingerprint recognition function	

### 2.3. Equipment Under Test

#### Power supply system utilised

Power supply voltage	:	<input type="radio"/> 230V / 50 Hz	<input type="radio"/> 120V / 60Hz
		<input type="radio"/> 12 V DC	<input type="radio"/> 24 V DC
		<input checked="" type="radio"/> Other (specified in blank below)	

DC 3.87V

### 2.4. Short description of the Equipment under Test (EUT)

This is a Mobile Data Terminal, Mobile Computer, Handheld DataTerminal,Wireless Handheld Terminal.

For more details, refer to the user’s manual of the EUT.

### 2.5. EUT operation mode

The application provider specific test software to control sample in continuous TX and RX.

Antenna	Chain0 (ANT0)			Chain1 (ANT1)			Simultaneously
Bandwidth Mode	20MHz	40MHz	80MHz	20MHz	40MHz	80MHz	/
IEEE 802.11a	<input checked="" type="checkbox"/>	<input type="checkbox"/>	<input type="checkbox"/>	<input type="checkbox"/>	<input type="checkbox"/>	<input type="checkbox"/>	<input type="checkbox"/>
IEEE 802.11n	<input checked="" type="checkbox"/>	<input checked="" type="checkbox"/>	<input type="checkbox"/>	<input type="checkbox"/>	<input type="checkbox"/>	<input type="checkbox"/>	<input type="checkbox"/>
IEEE 802.11ac	<input checked="" type="checkbox"/>	<input checked="" type="checkbox"/>	<input checked="" type="checkbox"/>	<input type="checkbox"/>	<input type="checkbox"/>	<input type="checkbox"/>	<input type="checkbox"/>

IEEE 802.11a/ac20/ac40/ac80/n20/n40:

UNII-1		UNII-1		UNII-1	
Channel	Frequency (MHz)	Channel	Frequency (MHz)	Channel	Frequency (MHz)
<b>36</b>	<b>5180</b>	38	5190	42	5210
<b>40</b>	<b>5200</b>	46	5230		
44	5220				
<b>48</b>	<b>5240</b>				

U-NI-2A		U-NI-2A		U-NI-2A	
Channel	Frequency (MHz)	Channel	Frequency (MHz)	Channel	Frequency (MHz)
52	5260	54	5270	58	5290
56	5280	62	5310		
60	5300				
64	5320				

U-NI-2C		U-NI-2C		U-NI-2C	
Channel	Frequency (MHz)	Channel	Frequency (MHz)	Channel	Frequency (MHz)
100	5500	102	5510	106	5530
104	5520	110	5550	122	5610
108	5540	118	5590		
112	5560	126	5630		
116	5580	134	5670		
120	5600				
124	5620				
128	5640				
132	5660				
136	5680				
140	5700				



U-NI-3		U-NI-3		U-NI-3	
Channel	Frequency (MHz)	Channel	Frequency (MHz)	Channel	Frequency (MHz)
149	5745	151	5755	155	5775
153	5765	159	5795		
157	5785				
161	5805				
165	5825				

The EUT has been tested under operating condition.

This test was performed with EUT in X, Y, Z position and the worst case was found when EUT in X position. AC conducted emission pre-test at both at AC 120V/60Hz and AC 240V/50Hz modes, recorded worst case(AC 120V/60Hz).

AC main conducted emission pre-test at charge from PC modes, recorded worst case;

Worst-case mode and channel used for 9 KHz-1000 MHz radiated emissions was the mode and channel with the highest output power, that was determined to be IEEE 802.11ac VHT20 mode (HCH).

### 2.6. Block Diagram of Test Setup

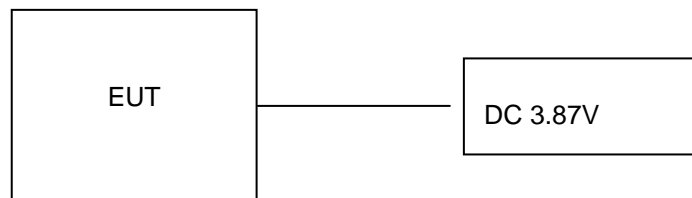

### 2.7. Related Submittal(s) / Grant (s)

This submittal(s) (test report) is intended for **FCC ID: 2AYD5-I24P01** filing to comply with Section 15.407 of the FCC Part 15, Subpart E Rules.

### 2.8. EUT Exercise Software

The system was configured for testing in a continuous transmits condition and change test channels by software (MTK Mode) provided by application.

### 2.9. Special Accessories

Manufacturer	Description	Model	Serial Number	Certificate
SHENZHEN TIANYIN ELECTRONICS CO.,LTD.	Adapter	TPD-203A120167UF0 1	--	SDOC
/	Charger Base	Lark1 Dock A	--	SDOC
/	Hand Shank	Lark1 Handle	--	SDOC

Note:The product accessories are selected by customers to matched product to use.

### 2.10. External I/O Cable

I/O Port Description	Quantity	Cable
DC IN Port	1	1.0M, Unscreened Cable

### 2.11. Modifications

No modifications were implemented to meet testing criteria.

### 3. TEST ENVIRONMENT

#### 3.1. Address of the test laboratory

##### Shenzhen CTA Testing Technology Co., Ltd.

Room 106, Building 1, Yibaolai Industrial Park, Qiaotou Community, Fuhai Street, Bao'an District, Shenzhen, China

#### 3.2. Test Facility

The test facility is recognized, certified, or accredited by the following organizations:

##### FCC-Registration No.: 517856 Designation Number: CN1318

Shenzhen CTA Testing Technology Co., Ltd. has been listed on the US Federal Communications Commission list of test facilities recognized to perform electromagnetic emissions measurements.

##### A2LA-Lab Cert. No.: 6534.01

Shenzhen CTA Testing Technology Co., Ltd. has been listed by American Association for Laboratory Accreditation to perform electromagnetic emission measurement.

The 3m-Semi anechoic test site fulfils CISPR 16-1-4 according to ANSI C63.10 and CISPR 16-1-4:2010.

#### 3.3. Environmental conditions

During the measurement the environmental conditions were within the listed ranges:

Temperature:	15-35 ° C
Humidity:	30-60 %
Atmospheric pressure:	950-1050mbar

#### 3.4. Statement of the measurement uncertainty

The data and results referenced in this document are true and accurate. The reader is cautioned that there may be errors within the calibration limits of the equipment and facilities. The measurement uncertainty was calculated for all measurements listed in this test report acc. to TR-100028-01 "Electromagnetic compatibility and Radio spectrum Matters (ERM);Uncertainties in the measurement of mobile radio equipment characteristics; Part 1" and TR-100028-02 "Electromagnetic compatibility and Radio spectrum Matters (ERM);Uncertainties in the measurement of mobile radio equipment characteristics; Part 2 " and is documented in the Shenzhen CTA Testing Technology Co., Ltd. quality system acc. to DIN EN ISO/IEC 17025. Furthermore, component and process variability of devices similar to that tested may result in additional deviation. The manufacturer has the sole responsibility of continued compliance of the device.

Hereafter the best measurement capability for Shenzhen CTA Testing Technology Co., Ltd. :

Test	Range	Measurement Uncertainty	Notes
Radiated Emission	9KHz~30MHz	3.02 dB	(1)
Radiated Emission	30~1000MHz	4.06 dB	(1)
Radiated Emission	1~18GHz	5.14 dB	(1)
Radiated Emission	18-40GHz	5.38 dB	(1)
Conducted Disturbance	0.15~30MHz	2.14 dB	(1)
Output Peak power	30MHz~18GHz	0.55 dB	(1)
Power spectral density	/	0.57 dB	(1)
Spectrum bandwidth	/	1.1%	(1)
Radiated spurious emission (30MHz-1GHz)	30~1000MHz	4.10 dB	(1)
Radiated spurious emission (1GHz-18GHz)	1~18GHz	4.32 dB	(1)
Radiated spurious emission (18GHz-40GHz)	18-40GHz	5.54 dB	(1)

This uncertainty represents an expanded uncertainty expressed at approximately the 95% confidence level using a coverage factor of k=2.

### 3.5. Test Description

Applied Standard: FCC Part 15 Subpart E				
FCC Rules	Description of Test	Test Sample	Result	Remark
/	On Time and Duty Cycle	GTS20240329015-1-S0001-1#	Compliant	Appendix D Appendix E Appendix F Appendix G
§15.407(a)	Maximum Conducted Output Power	GTS20240329015-1-S0001-1#	Compliant	Appendix D Appendix E Appendix F Appendix G
§15.407(a)	Power Spectral Density	GTS20240329015-1-S0001-1#	Compliant	Appendix D Appendix E Appendix F Appendix G
§15.407(a)	26dB&6dB Bandwidth and 99% Bandwidth	GTS20231018011-1-S0001-1#	Compliant	Appendix D Appendix E Appendix F Appendix G
§15.209, §15.407(b)	Radiated Emissions	GTS20240329015-1-S0001-1# GTS20240329015-1-S0001-2#	Compliant	Note 1
§15.209, §15.407(b)	Conducted Spurious Emissions and Band Edges Test	GTS20240329015-1-S0001-1#	Compliant	Appendix D Appendix E Appendix F Appendix G
§15.209, §15.407(b)	Emissions at Restricted Band	GTS20240329015-1-S0001-1#	Compliant	Appendix D Appendix E Appendix F Appendix G
§15.407(g)	Frequency Stability	GTS20240329015-1-S0001-1#	Compliant	Note 1
§15.207(a)	AC Mians Line Conducted Emissions	GTS20240329015-1-S0001-2#	Compliant	Note 1
§15.203 §15.407(h)	Antenna Requirements	GTS20240329015-1-S0001-1#	Compliant	Note 1
§15.407 §2.1093	RF Exposure	/	Compliant	Note 2

Remark:

1. The measurement uncertainty is not included in the test result.
2. NA = Not Applicable; NP = Not Performed
3. Note 1 – Test results inside test report;
4. Note 2 – Test results in other test report (SAR Report).
5. We tested all test mode and recorded worst case in report

Preliminary tests were performed in different data rate to find the worst radiated emission. The data rate shown in the table below is the worst-case rate with respect to the specific test item. Investigation has been done on all the possible configurations for searching the worst cases. The following table is a list of the test modes shown in this test report.

Test Items	Mode	Data Rate
Maximum Peak Conducted Output Power Power Spectral Density 6dB Bandwidth 26dB Bandwidth Radiated Emission 30M~1GHz & Radiated Emission 1GHz~10 <sup>th</sup> Harmonic	802.11a	6 Mbps
	802.11ac20/ac40/ac80 802.11n HT20/40	MCS0
Band Edge	802.11a	6 Mbps
	802.11ac20/ac40/ac80 802.11n HT20/40	MCS0

### 3.6. Equipments Used during the Test

Test Equipment	Manufacturer	Model No.	Equipment No.	Calibration Date	Calibration Due Date
LISN	R&S	ENV216	CTA-308	2023/08/02	2024/08/01
LISN	R&S	ENV216	CTA-314	2023/08/02	2024/08/01
EMI Test Receiver	R&S	ESPI	CTA-307	2023/08/02	2024/08/01
EMI Test Receiver	R&S	ESCI	CTA-306	2023/08/02	2024/08/01
Spectrum Analyzer	Agilent	N9020A	CTA-301	2023/08/02	2024/08/01
Spectrum Analyzer	R&S	FSP	CTA-337	2023/08/02	2024/08/01
Vector Signal generator	Agilent	N5182A	CTA-305	2023/08/02	2024/08/01
Analog Signal Generator	R&S	SML03	CTA-304	2023/08/02	2024/08/01
Universal Radio Communication	CMW500	R&S	CTA-302	2023/08/02	2024/08/01
Temperature and humidity meter	Chigo	ZG-7020	CTA-326	2023/08/02	2024/08/01
Ultra-Broadband Antenna	Schwarzbeck	VULB9163	CTA-310	2023/10/17	2024/10/16
Horn Antenna	Schwarzbeck	BBHA 9120D	CTA-309	2023/10/13	2024/10/12
Loop Antenna	Zhinan	ZN30900C	CTA-311	2023/10/17	2024/10/16
Horn Antenna	Beijing Hangwei Dayang	OBH100400	CTA-336	2021/08/07	2024/08/06
Antenna Tower	Suzhou Keletuo electronic Technology Co., LTD	BK-*AT-BS	N/A	N/A	N/A
Amplifier	Schwarzbeck	BBV 9745	CTA-312	2023/08/02	2024/08/01
Amplifier	Taiwan chengyi	EMC051845B	CTA-313	2023/08/02	2024/08/01
Directional coupler	NARDA	4226-10	CTA-303	2023/08/02	2024/08/01
High-Pass Filter	XingBo	XBLBQ-GTA18	CTA-402	2023/08/02	2024/08/01
High-Pass Filter	XingBo	XBLBQ-GTA27	CTA-403	2023/08/02	2024/08/01
Automated filter bank	Tonscend	JS0806-F	CTA-404	2023/08/02	2024/08/01
Power Sensor	Agilent	U2021XA	CTA-405	2023/08/02	2024/08/01
Amplifier	Schwarzbeck	BBV9719	CTA-406	2023/08/02	2024/08/01

Note: The Cal.Interval was one year.

## 4. TEST CONDITIONS AND RESULTS

### 4.1. AC Power Conducted Emission

#### TEST CONFIGURATION

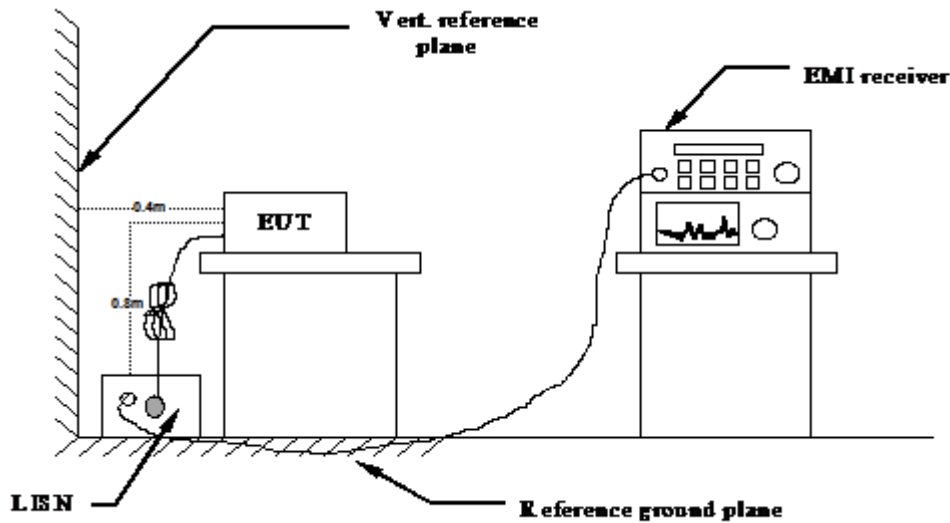

#### TEST PROCEDURE

1 The equipment was set up as per the test configuration to simulate typical actual usage per the user's manual. The EUT is a tabletop system, a wooden table with a height of 0.8 meters is used and is placed on the ground plane as per ANSI C63.10-2020.

2 Support equipment, if needed, was placed as per ANSI C63.10-2020

3 All I/O cables were positioned to simulate typical actual usage as per ANSI C63.10-2020

4 The EUT received DC 5.0V power, the adapter received AC120V/60Hz or AC 240V/50Hz power through a Line Impedance Stabilization Network (LISN) which supplied power source and was grounded to the ground plane.

5 All support equipments received AC power from a second LISN, if any.

6 The EUT test program was started. Emissions were measured on each current carrying line of the EUT using a spectrum Analyzer / Receiver connected to the LISN powering the EUT. The LISN has two monitoring points: Line 1 (Hot Side) and Line 2 (Neutral Side). Two scans were taken: one with Line 1 connected to Analyzer / Receiver and Line 2 connected to a 50 ohm load; the second scan had Line 1 connected to a 50 ohm load and Line 2 connected to the Analyzer / Receiver.

7 Analyzer / Receiver scanned from 150 KHz to 30MHz for emissions in each of the test modes.

8 During the above scans, the emissions were maximized by cable manipulation.

#### AC Power Conducted Emission Limit

For intentional device, according to § 15.207(a) AC Power Conducted Emission Limits is as following :

Frequency range (MHz)	Limit (dBuV)	
	Quasi-peak	Average
0.15-0.5	66 to 56*	56 to 46*
0.5-5	56	46
5-30	60	50

\* Decreases with the logarithm of the frequency.

#### DISTURBANCE Calculation

The AC mains conducted disturbance is calculated by adding the 10dB Pulse Limiter and Cable Factor and Duty Cycle Correction Factor (if any) from the measured reading. The basic equation with a sample calculation is as follows:

$$CD \text{ (dBuV)} = RA \text{ (dBuV)} + PL \text{ (dB)} + CL \text{ (dB)}$$

Where CD = Conducted Disturbance	CL = Cable Attenuation Factor (Cable Loss)
RA = Reading Amplitude	PL = 10 dB Pulse Limiter Factor

**TEST RESULTS**

Remark: We measured Conducted Emission at all mode in AC 120V/60Hz, the worst case was recorded .

Temperature	25°C	Humidity	60%
Test Engineer	Lushan Kong	Configurations	IEEE 802.11ac20 HCH

**Version A:**

Power supply:	AC 120V/60Hz	Polarization	L
---------------	--------------	--------------	---

Test Graph

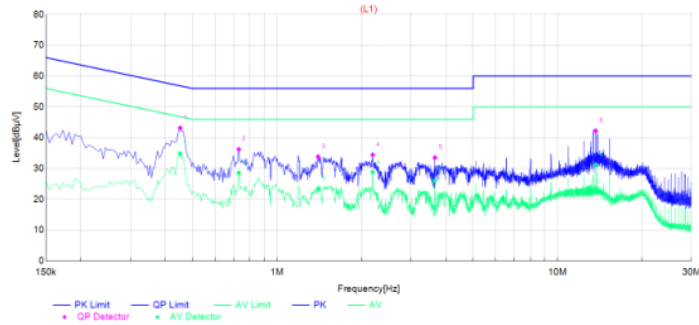

Final Data List

NO.	Frequency	QP	AVG.	Factor	QP	AVG.	QP	AVG.	QP	AVG.	Line	Remark
		Reading	Reading		Result	Result	Limit	Limit	Margin	Margin		
1	0.4515	32.98	24.63	10.22	43.20	34.85	56.85	46.85	13.65	12.00	L1	PASS
2	0.7305	26.01	18.38	10.23	36.24	28.61	56.00	46.00	19.76	17.39	L1	PASS
3	1.401	23.60	13.15	10.23	33.83	23.38	56.00	46.00	22.17	22.62	L1	PASS
4	2.193	24.15	18.56	10.28	34.43	28.84	56.00	46.00	21.57	17.16	L1	PASS
5	3.6555	23.17	15.77	10.36	33.53	26.13	56.00	46.00	22.47	19.87	L1	PASS
6	13.677	31.33	20.39	10.88	42.21	31.27	60.00	50.00	17.79	18.73	L1	PASS

Note:1. Result (dBµV) = Reading (dBµV) + Factor (dB).

2. Factor (dB) = Cable loss (dB) + LISN Factor (dB).

Power supply:	AC 120V/60Hz	Polarization	N
---------------	--------------	--------------	---

Test Graph

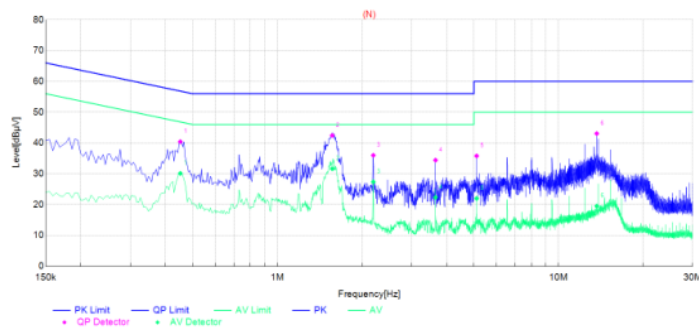

Final Data List

NO.	Frequency	QP	AVG.	Factor	QP	AVG.	QP	AVG.	QP	AVG.	Line	Remark
		Reading	Reading		Result	Result	Limit	Limit	Margin	Margin		
1	0.4515	30.20	19.91	10.22	40.42	30.13	56.85	46.85	16.43	16.72	N	PASS
2	1.5675	32.20	21.40	10.24	42.44	31.64	56.00	46.00	13.56	14.36	N	PASS
3	2.193	25.73	17.10	10.28	36.01	27.38	56.00	46.00	19.99	18.62	N	PASS
4	3.651	24.06	11.98	10.36	34.42	22.34	56.00	46.00	21.58	23.66	N	PASS
5	5.1135	25.45	11.64	10.36	35.81	22.00	60.00	50.00	24.19	28.00	N	PASS
6	13.677	32.18	8.63	10.88	43.06	19.51	60.00	50.00	16.94	30.49	N	PASS

Note:1. Result (dBµV) = Reading (dBµV) + Factor (dB).

2. Factor (dB) = Cable loss (dB) + LISN Factor (dB).

Version B:

Power supply:	AC 120V/60Hz	Polarization	L
---------------	--------------	--------------	---

Test Graph

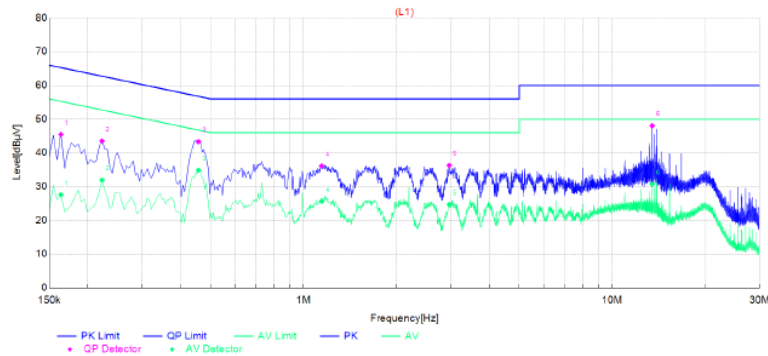

Final Data List												
NO.	Frequency	QP	AVG.	Factor	QP	AVG.	QP	AVG.	QP	AVG.	Line	Remark
		Reading	Reading		Result	Result	Limit	Limit	Margin	Margin		
1	0.1635	35.17	17.33	10.29	45.46	27.62	65.28	55.28	19.82	27.66	L1	PASS
2	0.222	33.40	21.82	10.14	43.54	31.96	62.74	52.74	19.20	20.78	L1	PASS
3	0.456	33.09	24.65	10.22	43.31	34.87	56.77	46.77	13.46	11.90	L1	PASS
4	1.1445	25.92	15.37	10.21	36.13	25.58	56.00	46.00	19.87	20.42	L1	PASS
5	2.9625	25.97	14.37	10.34	36.31	24.71	56.00	46.00	19.69	21.29	L1	PASS
6	13.479	37.16	19.89	10.89	48.05	30.78	60.00	50.00	11.95	19.22	L1	PASS

Note: 1. Result (dBµV) = Reading (dBµV) + Factor (dB).

2. Factor (dB) = Cable loss (dB) + LISN Factor (dB).

Power supply:	AC 120V/60Hz	Polarization	N
---------------	--------------	--------------	---

Test Graph

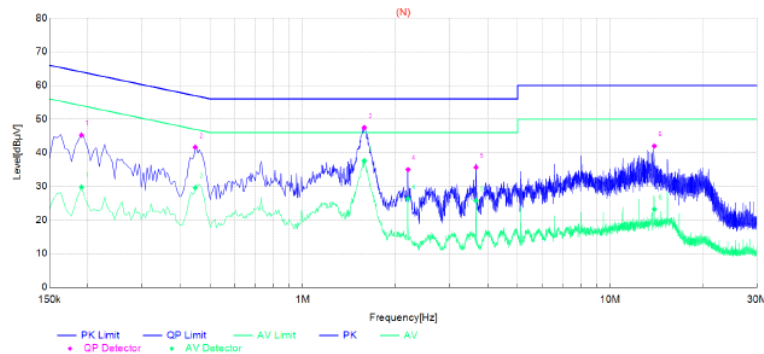

Final Data List												
NO.	Frequency	QP	AVG.	Factor	QP	AVG.	QP	AVG.	QP	AVG.	Line	Remark
		Reading	Reading		Result	Result	Limit	Limit	Margin	Margin		
1	0.1905	35.06	19.59	10.16	45.22	29.75	64.01	54.01	18.79	24.26	N	PASS
2	0.447	31.41	19.37	10.21	41.62	29.58	56.93	46.93	15.31	17.35	N	PASS
3	1.5855	37.21	27.35	10.24	47.45	37.59	56.00	46.00	8.55	8.41	N	PASS
4	2.1975	24.72	16.05	10.28	35.00	26.33	56.00	46.00	21.00	19.67	N	PASS
5	3.66	25.28	15.36	10.36	35.64	25.72	56.00	46.00	20.36	20.28	N	PASS
6	13.8975	31.12	12.32	10.87	41.99	23.19	60.00	50.00	18.01	26.81	N	PASS

Note: 1. Result (dBµV) = Reading (dBµV) + Factor (dB).

2. Factor (dB) = Cable loss (dB) + LISN Factor (dB).



## 4.2. Radiated Emission

### TEST CONFIGURATION

Frequency range 9 KHz – 30MHz

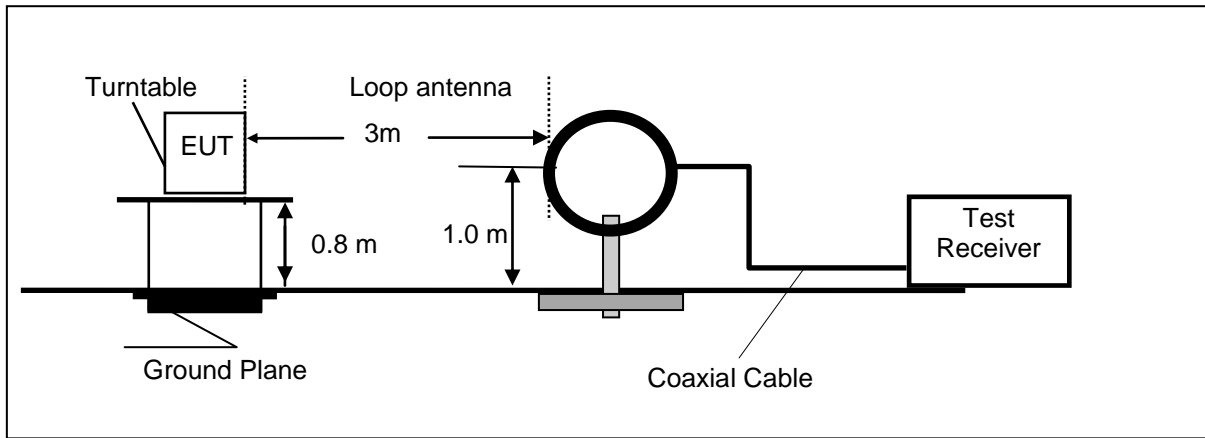

Frequency range 30MHz – 1000MHz

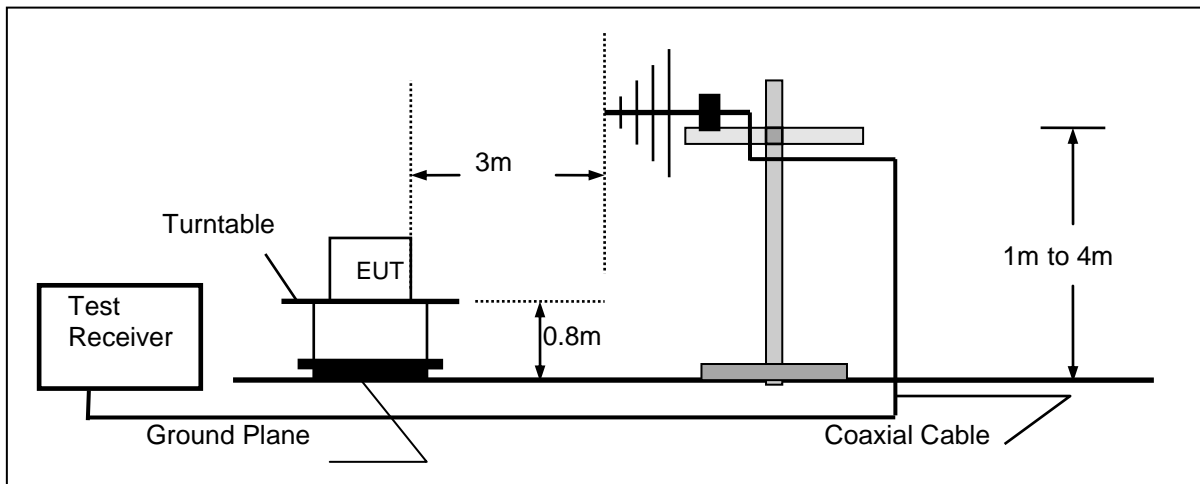

Frequency range above 1GHz

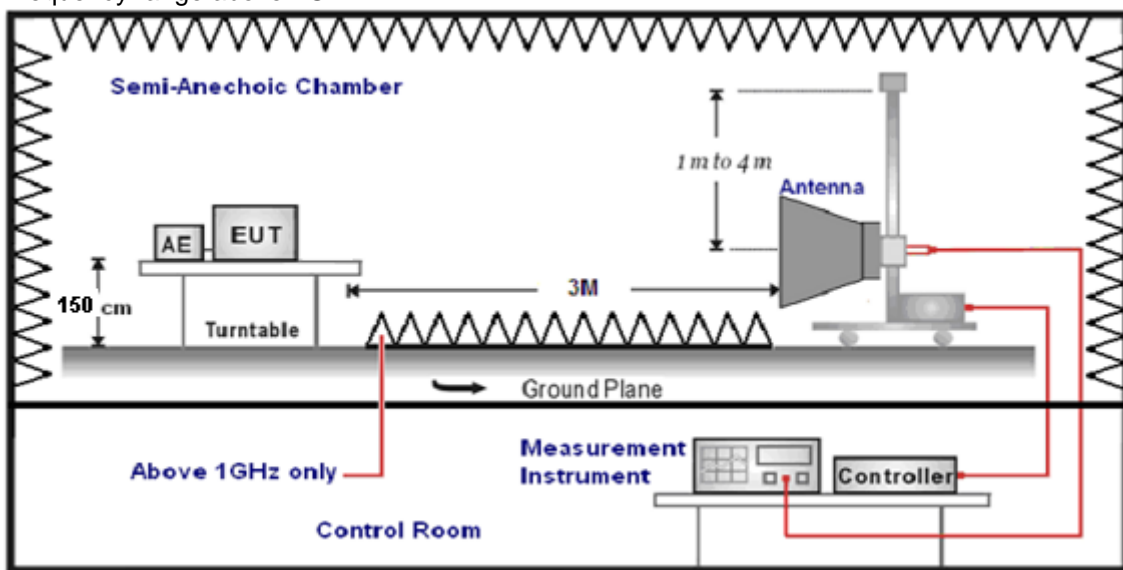

**TEST PROCEDURE**

1. The EUT was placed on a turn table which is 0.8m above ground plane when testing frequency range 9 KHz –1GHz;the EUT was placed on a turn table which is 1.5m above ground plane when testing above 1GHz.
2. Maximum procedure was performed by raising the receiving antenna from 1m to 4m and rotating the turn table from 0° to 360° to acquire the highest emissions from EUT.
3. And also, each emission was to be maximized by changing the polarization of receiving antenna both horizontal and vertical.
4. Repeat above procedures until all frequency measurements have been completed.
5. The EUT minimum operation frequency was 24MHz and maximum operation frequency was 5825MHz.so radiated emission test frequency band from 9KHz to 40GHz.
6. The distance between test antenna and EUT as following table states:

Test Frequency range	Test Antenna Type	Test Distance
9KHz-30MHz	Active Loop Antenna	3
30MHz-1GHz	Ultra-Broadband Antenna	3
1GHz-18GHz	Double Ridged Horn Antenna	3
18GHz-25GHz	Horn Antenna	1

7. Setting test receiver/spectrum as following table states:

Test Frequency range	Test Receiver/Spectrum Setting	Detector
9KHz-150KHz	RBW=200Hz/VBW=3KHz, Sweep time=Auto	QP
150KHz-30MHz	RBW=9KHz/VBW=100KHz, Sweep time=Auto	QP
30MHz-1GHz	RBW=120KHz/VBW=1000KHz, Sweep time=Auto	QP
1GHz-40GHz	Peak Value: RBW=1MHz/VBW=3MHz, Sweep time=Auto Average Value: RBW=1MHz/VBW=10Hz, Sweep time=Auto	Peak

**Field Strength Calculation**

The field strength is calculated by adding the Antenna Factor and Cable Factor and subtracting the Amplifier Gain and Duty Cycle Correction Factor(if any) from the measured reading. The basic equation with a sample calculation is as follows:

**FS = RA + AF + CL - AG**

Where FS = Field Strength	CL = Cable Attenuation Factor (Cable Loss)
RA = Reading Amplitude	AG = Amplifier Gain
AF = Antenna Factor	

Transd=AF +CL-AG

**RADIATION LIMIT**

According to §15.407 (b): Except as shown in paragraph (b)(7) of this section, the maximum emissions outside of the frequency bands of operation shall be attenuated in accordance with the following limits

Frequency (MHz)	EIRP Limit (dBm)	Equivalent Field Strength at 3m (dBµV/m)
5150-5250	-27	68.2
5250-5350	-27	68.2
5470-5725	-27	68.2
5725-5850	-27 (beyond 10MHz of the bandedge)	68.2
	-17 (within 10 MHz of band edge)	78.2

Frequency (MHz)	Distance (Meters)	Radiated (dBµV/m)	Radiated (µV/m)
0.009-0.49	3	$20\log(2400/F(KHz))+40\log(300/3)$	2400/F(KHz)
0.49-1.705	3	$20\log(24000/F(KHz))+ 40\log(30/3)$	24000/F(KHz)
1.705-30	3	$20\log(30)+ 40\log(30/3)$	30
30-88	3	40.0	100
88-216	3	43.5	150
216-960	3	46.0	200
Above 960	3	54.0	500

**TEST RESULTS**

Remark: We measured Radiated Emission at all mode from 9KHz to 25GHz in AC 120V/60Hz and the worst case was recorded.

Temperature	23.4°C	Humidity	54.5%
Test Engineer	Lushan Kong	Configurations	IEEE 802.11ac20 HCH

**For 9 KHz~30MHz**

Freq. (MHz)	Level (dBuV)	Over Limit (dB)	Over Limit (dBuV)	Remark
-	-	-	-	See Note

Note:

The amplitude of spurious emissions which are attenuated by more than 20 dB below the permissible value has no need to be reported.

Distance extrapolation factor =  $40 \log(\text{specific distance} / \text{test distance})$  (dB);

Limit line = specific limits (dBuV) + distance extrapolation factor.

For 30MHz-1GHz

Version A:

Horizontal

Test Graph

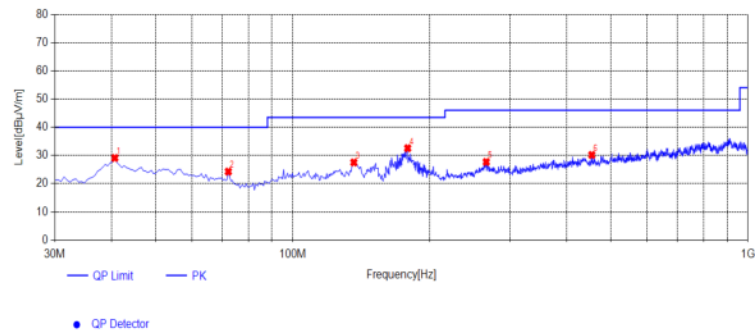

Suspected List

NO.	Frequency [MHz]	Reading [dBµV/m]	Factor [dB]	Result [dBµV/m]	Limit [dBµV/m]	Margin [dB]	Height [cm]	Angle [°]	Detector	Polarity	Remark
1	40.67	33.36	-4.24	29.12	40.00	10.88	100	358	PK	Horizontal	PASS
2	72.195	31.70	-7.41	24.29	40.00	15.71	100	30	PK	Horizontal	PASS
3	136.215	35.64	-8.11	27.53	43.50	15.97	100	320	PK	Horizontal	PASS
4	178.895	39.28	-6.69	32.59	43.50	10.91	100	83	PK	Horizontal	PASS
5	266.195	30.52	-2.82	27.70	46.00	18.30	100	111	PK	Horizontal	PASS
6	453.89	29.12	1.07	30.19	46.00	15.81	100	252	PK	Horizontal	PASS

Note:1. Result (dBµV/m) = Reading(dBµV/m) + Factor (dB) .

2. Factor (dB) = Antenna Factor (dB/m) + Cable loss (dB) - Pre Amplifier gain (dB).

Vertical

Test Graph

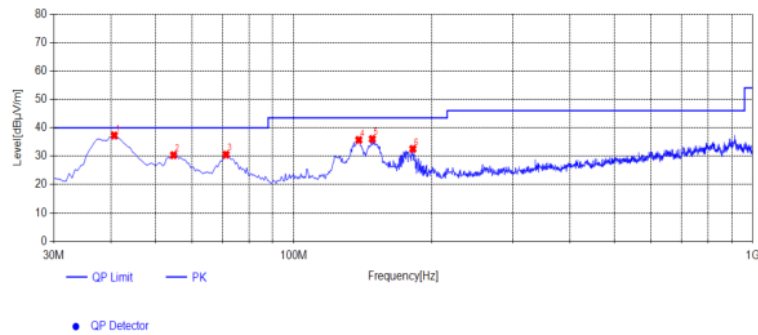

Suspected List

NO.	Frequency [MHz]	Reading [dBµV/m]	Factor [dB]	Result [dBµV/m]	Limit [dBµV/m]	Margin [dB]	Height [cm]	Angle [°]	Detector	Polarity	Remark
1	40.67	41.53	-4.24	37.29	40.00	2.71	100	350	PK	Vertical	PASS
2	54.735	34.17	-3.81	30.36	40.00	9.64	100	358	PK	Vertical	PASS
3	71.225	37.79	-7.25	30.54	40.00	9.46	100	21	PK	Vertical	PASS
4	138.64	44.25	-8.53	35.72	43.50	7.78	100	0	PK	Vertical	PASS
5	148.34	44.59	-8.55	36.04	43.50	7.46	100	0	PK	Vertical	PASS
6	181.805	39.03	-6.48	32.55	43.50	10.95	100	38	PK	Vertical	PASS

Note:1. Result (dBµV/m) = Reading(dBµV/m) + Factor (dB) .

2. Factor (dB) = Antenna Factor (dB/m) + Cable loss (dB) - Pre Amplifier gain (dB).

Version B:

**Horizontal**

**Test Graph**

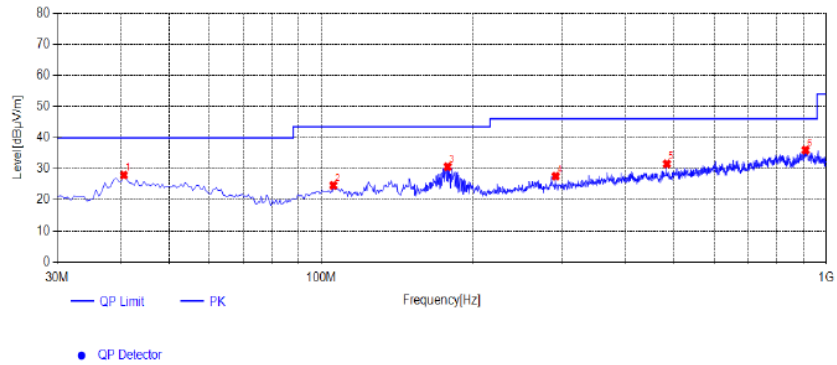

Suspected List											
NO.	Frequency [MHz]	Reading [dBµV/m]	Factor [dB]	Result [dBµV/m]	Limit [dBµV/m]	Margin [dB]	Height [cm]	Angle [°]	Detector	Polarity	Remark
1	40.67	32.22	-4.24	27.98	40.00	12.02	100	290	PK	Horizontal	PASS
2	105.66	28.53	-3.92	24.61	43.50	18.89	100	317	PK	Horizontal	PASS
3	177.925	37.21	-6.53	30.68	43.50	12.82	100	88	PK	Horizontal	PASS
4	291.415	29.83	-2.22	27.61	46.00	18.39	100	108	PK	Horizontal	PASS
5	483.96	29.27	2.31	31.58	46.00	14.42	100	357	PK	Horizontal	PASS
6	910.76	27.67	8.27	35.94	46.00	10.06	100	242	PK	Horizontal	PASS

Note: 1. Result (dBµV/m) = Reading(dBµV/m) + Factor (dB) .

2. Factor (dB) = Antenna Factor (dB/m) + Cable loss (dB) - Pre Amplifier gain (dB).

**Vertical**

**Test Graph**

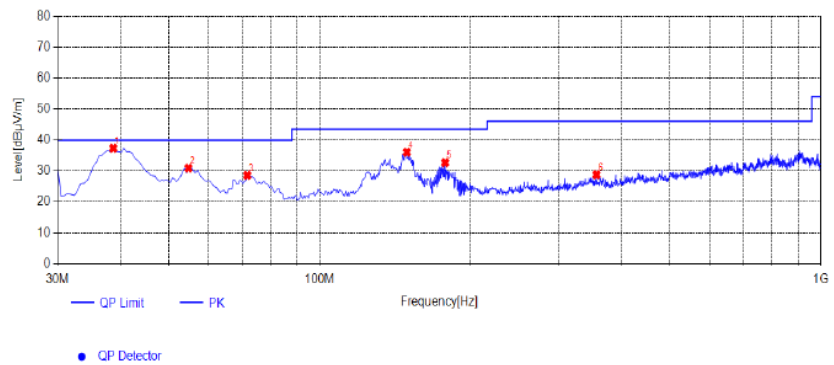

Suspected List											
NO.	Frequency [MHz]	Reading [dBµV/m]	Factor [dB]	Result [dBµV/m]	Limit [dBµV/m]	Margin [dB]	Height [cm]	Angle [°]	Detector	Polarity	Remark
1	38.73	42.19	-4.90	37.29	40.00	2.71	100	358	PK	Vertical	PASS
2	54.735	34.73	-3.81	30.92	40.00	9.08	100	63	PK	Vertical	PASS
3	71.71	35.94	-7.32	28.62	40.00	11.38	100	127	PK	Vertical	PASS
4	149.31	44.50	-8.50	36.00	43.50	7.50	100	2	PK	Vertical	PASS
5	177.925	39.19	-6.53	32.66	43.50	10.84	100	2	PK	Vertical	PASS
6	356.89	29.08	-0.27	28.81	46.00	17.19	100	229	PK	Vertical	PASS

Note: 1. Result (dBµV/m) = Reading(dBµV/m) + Factor (dB) .

2. Factor (dB) = Antenna Factor (dB/m) + Cable loss (dB) - Pre Amplifier gain (dB).

For 1GHz to 40GHz

5150-5250MHz:

IEEE 802.11a (Worst Case)

**802.11a Mode\_Channel 36\_ 5180 MHz**

Item (Mark)	Freq (MHz)	Read Level (dB $\mu$ V)	Antenna Factor (dB/m)	PRM Factor dB	Cable Loss (dB)	Result Level (dB $\mu$ V/m)	Limit Line (dB $\mu$ V/m)	Margin (dB)	Detector	Polarization
1	10360	40.24	38.55	33.13	11.26	56.92	68.20	-11.28	Peak	Horizontal
1	10360	30.53	38.55	33.13	11.26	47.21	54.00	-6.79	AV	Horizontal
1	10360	41.50	38.55	33.13	11.26	58.18	68.20	-10.02	Peak	Vertical
1	10360	29.31	38.55	33.13	11.26	45.99	54.00	-8.01	AV	Vertical

**802.11a Mode\_Channel 40\_ 5200 MHz**

Item (Mark)	Freq (MHz)	Read Level (dB $\mu$ V)	Antenna Factor (dB/m)	PRM Factor dB	Cable Loss (dB)	Result Level (dB $\mu$ V/m)	Limit Line (dB $\mu$ V/m)	Margin (dB)	Detector	Polarization
1	10400	41.00	38.55	33.13	11.26	57.68	68.20	-10.52	Peak	Horizontal
1	10400	30.71	38.55	33.13	11.26	47.39	54.00	-6.61	AV	Horizontal
1	10400	40.35	38.55	33.13	11.26	57.03	68.20	-11.17	Peak	Vertical
1	10400	28.09	38.55	33.13	11.26	44.77	54.00	-9.23	AV	Vertical

**802.11a Mode\_Channel 48\_ 5240 MHz**

Item (Mark)	Freq (MHz)	Read Level (dB $\mu$ V)	Antenna Factor (dB/m)	PRM Factor dB	Cable Loss (dB)	Result Level (dB $\mu$ V/m)	Limit Line (dB $\mu$ V/m)	Margin (dB)	Detector	Polarization
1	10480	40.31	38.55	33.13	11.26	56.99	68.20	-11.21	Peak	Horizontal
1	10480	30.68	38.55	33.13	11.26	47.36	54.00	-6.64	AV	Horizontal
1	10480	41.69	38.55	33.13	11.26	58.37	68.20	-9.83	Peak	Vertical
1	10480	29.29	38.55	33.13	11.26	45.97	54.00	-8.03	AV	Vertical

5260-5320MHz:

IEEE 802.11a (Worst Case)

**802.11a Mode Channel 52 5260 MHz**

Item (Mark)	Freq (MHz)	Read Level (dBμV)	Antenna Factor (dB/m)	PRM Factor dB	Cable Loss (dB)	Result Level (dBμV/m)	Limit Line (dBμV/m)	Margin (dB)	Detector	Polarization
1	10520	39.68	38.55	33.13	11.26	56.36	68.20	-11.84	Peak	Horizontal
1	10520	30.20	38.55	33.13	11.26	46.88	54.00	-7.12	AV	Horizontal
1	10520	40.22	38.55	33.13	11.26	56.90	68.20	-11.30	Peak	Vertical
1	10520	28.09	38.55	33.13	11.26	44.77	54.00	-9.23	AV	Vertical

**802.11a Mode Channel 56 5280 MHz**

Item (Mark)	Freq (MHz)	Read Level (dBμV)	Antenna Factor (dB/m)	PRM Factor dB	Cable Loss (dB)	Result Level (dBμV/m)	Limit Line (dBμV/m)	Margin (dB)	Detector	Polarization
1	10560	39.89	38.55	33.13	11.26	56.57	68.20	-11.63	Peak	Horizontal
1	10560	31.02	38.55	33.13	11.26	47.70	54.00	-6.30	AV	Horizontal
1	10560	40.81	38.55	33.13	11.26	57.49	68.20	-10.71	Peak	Vertical
1	10560	28.15	38.55	33.13	11.26	44.83	54.00	-9.17	AV	Vertical

**802.11a Mode Channel 64 5320 MHz**

Item (Mark)	Freq (MHz)	Read Level (dBμV)	Antenna Factor (dB/m)	PRM Factor dB	Cable Loss (dB)	Result Level (dBμV/m)	Limit Line (dBμV/m)	Margin (dB)	Detector	Polarization
1	10640	40.15	38.55	33.13	11.26	56.83	68.20	-11.37	Peak	Horizontal
1	10640	31.37	38.55	33.13	11.26	48.05	54.00	-5.95	AV	Horizontal
1	10640	40.50	38.55	33.13	11.26	57.18	68.20	-11.02	Peak	Vertical
1	10640	28.25	38.55	33.13	11.26	44.93	54.00	-9.07	AV	Vertical

5500-5700MHz:

IEEE 802.11a (Worst Case)

## 802.11a Mode\_Channel 100 \_ 5500 MHz

Item (Mark)	Freq (MHz)	Read Level (dB $\mu$ V)	Antenna Factor (dB/m)	PRM Factor dB	Cable Loss (dB)	Result Level (dB $\mu$ V/m)	Limit Line (dB $\mu$ V/m)	Margin (dB)	Detector	Polarization
1	11000	40.09	38.55	33.13	11.26	56.77	68.20	-11.43	Peak	Horizontal
1	11000	30.06	38.55	33.13	11.26	46.74	54.00	-7.26	AV	Horizontal
1	11000	40.54	38.55	33.13	11.26	57.22	68.20	-10.98	Peak	Vertical
1	11000	28.32	38.55	33.13	11.26	45.00	54.00	-9.00	AV	Vertical

## 802.11a Mode\_Channel 120 \_ 5600 MHz

Item (Mark)	Freq (MHz)	Read Level (dB $\mu$ V)	Antenna Factor (dB/m)	PRM Factor dB	Cable Loss (dB)	Result Level (dB $\mu$ V/m)	Limit Line (dB $\mu$ V/m)	Margin (dB)	Detector	Polarization
1	11200	39.26	38.55	33.13	11.26	55.94	68.20	-12.26	Peak	Horizontal
1	11200	31.42	38.55	33.13	11.26	48.10	54.00	-5.90	AV	Horizontal
1	11200	41.48	38.55	33.13	11.26	58.16	68.20	-10.04	Peak	Vertical
1	11200	28.21	38.55	33.13	11.26	44.89	54.00	-9.11	AV	Vertical

## 802.11a Mode\_Channel 140 \_ 5700 MHz

Item (Mark)	Freq (MHz)	Read Level (dB $\mu$ V)	Antenna Factor (dB/m)	PRM Factor dB	Cable Loss (dB)	Result Level (dB $\mu$ V/m)	Limit Line (dB $\mu$ V/m)	Margin (dB)	Detector	Polarization
1	11400	39.99	38.55	33.13	11.26	56.67	68.20	-11.53	Peak	Horizontal
1	11400	31.30	38.55	33.13	11.26	47.98	54.00	-6.02	AV	Horizontal
1	11400	40.83	38.55	33.13	11.26	57.51	68.20	-10.69	Peak	Vertical
1	11400	28.54	38.55	33.13	11.26	45.22	54.00	-8.78	AV	Vertical



5725-5850MHz:

IEEE 802.11a (Worst Case)

## 802.11a Mode\_Channel 149\_ 5745 MHz

Item (Mark)	Freq (MHz)	Read Level (dB $\mu$ V)	Antenna Factor (dB/m)	PRM Factor dB	Cable Loss (dB)	Result Level (dB $\mu$ V/m)	Limit Line (dB $\mu$ V/m)	Margin (dB)	Detector	Polarization
1	11490	39.37	38.55	33.13	11.26	56.05	68.20	-12.15	Peak	Horizontal
1	11490	30.42	38.55	33.13	11.26	47.10	54.00	-6.90	AV	Horizontal
1	11490	41.29	38.55	33.13	11.26	57.97	68.20	-10.23	Peak	Vertical
1	11490	29.36	38.55	33.13	11.26	46.04	54.00	-7.96	AV	Vertical

## 802.11a Mode\_Channel 157\_ 5785 MHz

Item (Mark)	Freq (MHz)	Read Level (dB $\mu$ V)	Antenna Factor (dB/m)	PRM Factor dB	Cable Loss (dB)	Result Level (dB $\mu$ V/m)	Limit Line (dB $\mu$ V/m)	Margin (dB)	Detector	Polarization
1	11570	39.94	38.55	33.13	11.26	56.62	68.20	-11.58	Peak	Horizontal
1	11570	30.59	38.55	33.13	11.26	47.27	54.00	-6.73	AV	Horizontal
1	11570	41.56	38.55	33.13	11.26	58.24	68.20	-9.96	Peak	Vertical
1	11570	28.32	38.55	33.13	11.26	45.00	54.00	-9.00	AV	Vertical

## 802.11a Mode\_Channel 165\_ 5825 MHz

Item (Mark)	Freq (MHz)	Read Level (dB $\mu$ V)	Antenna Factor (dB/m)	PRM Factor dB	Cable Loss (dB)	Result Level (dB $\mu$ V/m)	Limit Line (dB $\mu$ V/m)	Margin (dB)	Detector	Polarization
1	11650	40.72	38.55	33.13	11.26	57.40	68.20	-10.80	Peak	Horizontal
1	11650	30.83	38.55	33.13	11.26	47.51	54.00	-6.49	AV	Horizontal
1	11650	40.43	38.55	33.13	11.26	57.11	68.20	-11.09	Peak	Vertical
1	11650	28.90	38.55	33.13	11.26	45.58	54.00	-8.42	AV	Vertical

**REMARKS:**

1. Result Level = Read Level + Antenna Factor + Cable loss - PRM Factor.
2. Margin = Result Level - Limit
3. The other emission levels were very low against the limit.
4. Detector AV is setting spectrum/receiver. RBW=1MHz/VBW=10Hz/Sweep time=Auto/Detector=Peak;

**NOTE: All the modes have been tested and recorded worst mode in the report at Version A mode.**

### 4.3. Duty Cycle

#### TEST CONFIGURATION

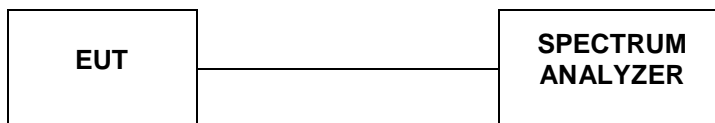

#### TEST PROCEDURE

According to KDB789033 D02 General U-NII Test Procedures New Rules v02r01 Duty Cycle (x),  
Transmission Duration (T):

- a. A diode detector and an oscilloscope that together have sufficiently short response time to permit accurate measurements of the on and off times of the transmitted signal
- b. The zero-span mode on a spectrum analyzer or EMI receiver, if the response time and spacing between bins on the sweep are sufficient to permit accurate measurements of the on and off times of the transmitted signal. Set the center frequency of the instrument to the center frequency of the transmission. Set  $RBW \geq EBW$  if possible; otherwise, set RBW to the largest available value. Set  $VBW \geq RBW$ . Set detector = peak or average. The zerospan measurement method shall not be used unless both RBW and VBW are  $> 50/T$ , where T is defined in section II.B.1.a), and the number of sweep points across duration T exceeds 100. (For example, if VBW and/or RBW are limited to 3 MHz, then the zero-span method of measuring duty cycle shall not be used if  $T \leq 16.7$  microseconds.)

#### TEST RESULTS

For reporting purpose only.

Please refer to Appendix D.3.

Please refer to Appendix E.3.

Please refer to Appendix F.3.

Please refer to Appendix G.3.

#### 4.4. Maximum Average Output Power

##### TEST CONFIGURATION

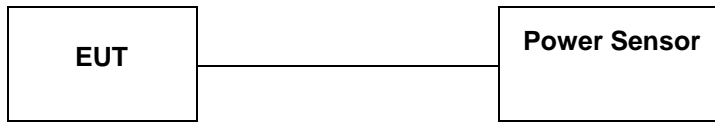

##### TEST PROCEDURE

According to KDB789033 D02 General U-NII Test Procedures New Rules v02r01 Measurement using a Power Meter (PM):

- a. Measurements may be performed using a wideband RF power meter with a thermocouple detector or equivalent if all of the conditions listed below are satisfied
  - 1. The EUT is configured to transmit continuously or to transmit with a constant duty cycle
  - 2. At all times when the EUT is transmitting, it must be transmitting at its maximum power control level.
  - 3. The integration period of the power meter exceeds the repetition period of the transmitted signal by at least a factor of five.
- b. If the transmitter does not transmit continuously, measure the duty cycle, x, of the transmitter output signal as described in section II.B
- c. Measure the average power of the transmitter. This measurement is an average over both the on and off periods of the transmitter.

Adjust the measurement in dBm by adding  $10 \log(1/x)$  where x is the duty cycle (e.g.,  $10 \log(1/0.25)$  if the duty cycle is 25 percent).

##### LIMIT

According to §15.407(a): The maximum output power should be not exceed follow:

Frequency Range (MHz)	Limit
5150-5250	Fixed: 1 Watt (30dBm) Mobile and portable: 250mW (24dBm)
5250-5350	250mW (24dBm)
5470-5725	250mW (24dBm)
5725-5850	1 Watt (30dBm)

Note: The maximum e.i.r.p at any elevation angle above 30 degrees as measured from the horizon must not exceed 125mW(21dBm)

##### TEST RESULTS

For reporting purpose only.

Please refer to Appendix D.4.

Please refer to Appendix E.4.

Please refer to Appendix F.4.

Please refer to Appendix G.4.

### 4.5. Power Spectral Density

#### TEST CONFIGURATION

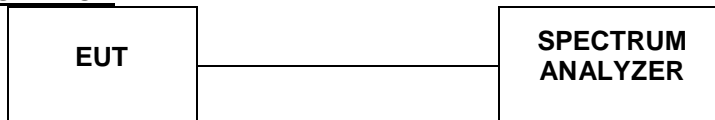

#### TEST PROCEDURE

According to KDB789033 D02 General U-NII Test Procedures New Rules v02r01: The rules requires “maximum power spectral density” measurements where the intent is to measure the maximum value of the time average of the power spectral density measured during a period of continuous transmission

- a. Create an average power spectrum for the EUT operating mode being tested by following the instructions in section II.E.2. for measuring maximum conducted output power using a spectrum analyzer or EMI receiver: select the appropriate test method (SA-1, SA-2, SA-3, or alternatives to each) and apply it up to, but not including, the step labeled, “Compute power...”. (This procedure is required even if the maximum conducted output power measurement was performed using a power meter, method PM.)
- b. Use the peak search function on the instrument to find the peak of the spectrum and record its value.
- c. Make the following adjustments to the peak value of the spectrum, if applicable:
  1. If Method SA-2 or SA-2 Alternative was used, add  $10 \log(1/x)$ , where x is the duty cycle, to the peak of the spectrum.
  2. ) If Method SA-3 Alternative was used and the linear mode was used in step II.E.2.g)(viii), add 1 dB to the final result to compensate for the difference between linear averaging and power averaging.
- d. The result is the Maximum PSD over 1 MHz reference bandwidth.
- e. For devices operating in the bands 5.15-5.25 GHz, 5.25-5.35 GHz, and 5.47-5.725 GHz, the above procedures make use of 1 MHz RBW to satisfy directly the 1 MHz reference bandwidth specified in § 15.407(a)(5). For devices operating in the band 5.725-5.85 GHz, the rules specify a measurement bandwidth of 500 kHz. Many spectrum analyzers do not have 500 kHz RBW, thus a narrower RBW may need to be used. The rules permit the use of a RBWs less than 1 MHz, or 500 kHz, “provided that the measured power is integrated over the full reference bandwidth” to show the total power over the specified measurement bandwidth (i.e., 1 MHz, or 500 kHz). If measurements are performed using a reduced resolution bandwidth (< 1 MHz, or < 500 kHz) and integrated over 1 MHz, or 500 KHz bandwidth, the following adjustments to the procedures apply:
  1. Set  $RBW \geq 1/T$ , where T is defined in section II.B.I.a).
  2. Set  $VBW \geq 3 RBW$ .
  3. If measurement bandwidth of Maximum PSD is specified in 500 kHz, add  $10\log(500kHz/RBW)$  to the measured result, whereas RBW (< 500 KHz) is the reduced resolution bandwidth of the spectrum analyzer set during measurement.
  4. If measurement bandwidth of Maximum PSD is specified in 1 MHz, add  $10\log(1MHz/RBW)$  to the measured result, whereas RBW (< 1 MHz) is the reduced resolution bandwidth of spectrum analyzer set during measurement.
  5. Care must be taken to ensure that the measurements are performed during a period of continuous transmission or are corrected upward for duty cycle.

Note: As a practical matter, it is recommended to use reduced RBW of 100 KHz for the sections 5.c) and 5.d) above, since RBW=100 KHz is available on nearly all spectrum analyzers.
- f. Adjust the measurement in dBm by adding  $10 \log(1/x)$  where x is the duty cycle (e.g.,  $10 \log(1/0.25)$  if the duty cycle is 25 percent).

#### LIMIT

According to §15.407(a): The maximum output power should be not exceed follow:

Frequency Range (MHz)	Limit
5150-5250	Other then Mobile and portable:17dBm/MHz Mobile and portable:11dBm/MHz
5250-5350	11dBm/MHz
5470-5725	11dBm/MHz
5725-5850	30dBm/500kHz

#### TEST RESULTS

For reporting purpose only.  
 Please refer to Appendix D.5.  
 Please refer to Appendix E.5.  
 Please refer to Appendix F.5.  
 Please refer to Appendix G.5.

## 4.6. 99% and 6dB Bandwidth

### TEST CONFIGURATION

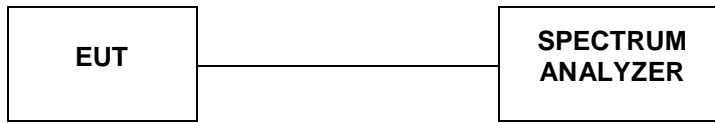

### TEST PROCEDURE

According to KDB789033 D02 General U-NII Test Procedures New Rules v02r01 for one of the following procedures may be used for section 15.407(e) specifies the minimum 6 dB emission bandwidth of at least 500 KHz for the band 5.715-5.85 GHz. The following procedure shall be used for measuring this bandwidth:

- a. Set RBW = 100 kHz.
- b. Set the video bandwidth (VBW)  $\geq 3 \times$  RBW
- c. Detector = Peak.
- d. Trace mode = max hold.
- e. Sweep = auto couple.
- f. Allow the trace to stabilize
- g. Measure the maximum width of the emission that is constrained by the frequencies associated with the two outermost amplitude points (upper and lower frequencies) that are attenuated by 6 dB relative to the maximum level measured in the fundamental emission.

Note: The automatic bandwidth measurement capability of a spectrum analyzer or EMI receiver may be employed if it implements the functionality described above.

### LIMIT

For Section 15.407(e) specifies the minimum 6 dB emission bandwidth of at least 500 KHz for the band 5.715-5.85 GHz

### TEST RESULTS

For reporting purpose only.

Please refer to Appendix G.1.

Please refer to Appendix G.2.

## 4.7. 99% and 26dBc Bandwidth

### TEST CONFIGURATION

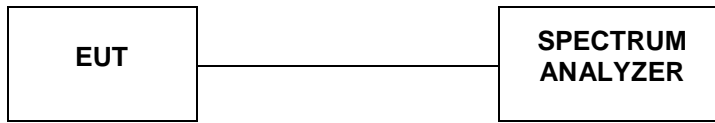

### TEST PROCEDURE

According to KDB789033 D02 General U-NII Test Procedures New Rules v02r01 for one of the following procedures may be used for Emission Bandwidth (EBW) measurement:

- a. Set RBW = 220 kHz/430 kHz /820 kHz (approximately 1% of the emission bandwidth).
- b. Set the video bandwidth (VBW) = 3\* RBW)
- c. Detector = Peak.
- d. Trace mode = max hold.
- e. Sweep = auto couple.
- f. Allow the trace to stabilize
- g. Measure the maximum width of the emission that is 26 dB down from the maximum of the emission. Compare this with the RBW setting of the analyzer. Readjust RBW and repeat measurement as needed until the RBW/EBW ratio is approximately 1%.

Note: The automatic bandwidth measurement capability of a spectrum analyzer or EMI receiver may be employed if it implements the functionality described above.

### LIMIT

No Limits for 26dBc Bandwith

### TEST RESULTS

For reporting purpose only.

Please refer to Appendix D.1.

Please refer to Appendix D.2.

Please refer to Appendix E.1.

Please refer to Appendix E.2.

Please refer to Appendix F.1.

Please refer to Appendix F.2.

### 4.8. Conducted Spurious Emissions and Band Edge Compliance

#### TEST CONFIGURATION

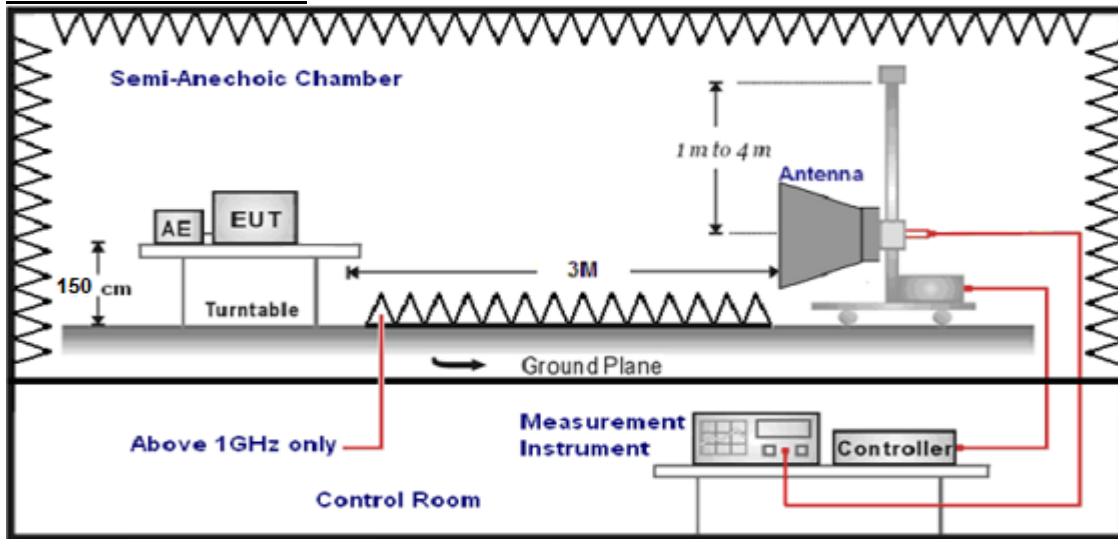

#### LIMIT

20dBc in any 100 kHz bandwidth outside the operating frequency band. In case the emission fall within the restricted band specified on 15.205(a), then the 15.209(a) limit in the table below has to be followed.

Frequency (MHz)	Distance (Meters)	Radiated (dBµV/m)	Radiated (µV/m)
0.009-0.49	3	$20\log(2400/F(KHz))+40\log(300/3)$	$2400/F(KHz)$
0.49-1.705	3	$20\log(24000/F(KHz))+40\log(30/3)$	$24000/F(KHz)$
1.705-30	3	$20\log(30)+40\log(30/3)$	30
30-88	3	40.0	100
88-216	3	43.5	150
216-960	3	46.0	200
Above 960	3	54.0	500

According to §15.407 (b): Except as shown in paragraph (b)(7) of this section, the maximum emissions outside of the frequency bands of operation shall be attenuated in accordance with the following limits

Frequency (MHz)	EIRP Limit (dBm)	Equivalent Field Strength at 3m (dBµV/m)
5150-5250	-27	68.2
5250-5350	-27	68.2
5470-5725	-27	68.2
5725-5850	-27 (beyond 10MHz of the band edge)	68.2
	-17 (within 10 MHz of band edge)	78.2

#### TEST PROCEDURE

- The EUT was placed on a turn table which is 1.5m above 1GHz.
- Maximum procedure was performed by raising the receiving antenna from 1m to 4m and rotating the turn table from 0° to 360° to acquire the highest emissions from EUT.
- And also, each emission was to be maximized by changing the polarization of receiving antenna both horizontal and vertical.
- Repeat above procedures until all frequency measurements have been completed..
- The distance between test antenna and EUT as following table states:

Test Frequency range	Test Antenna Type	Test Distance
1GHz-18GHz	Double Ridged Horn Antenna	3

- Setting test receiver/spectrum as following table states:

Test Frequency range	Test Receiver/Spectrum Setting	Detector
1GHz-18GHz	Peak Value: RBW=1MHz/VBW=3MHz, Sweep time=Auto Average Value: RBW=1MHz/VBW=10Hz, Sweep time=Auto	Peak

**Field Strength Calculation**

The field strength is calculated by adding the Antenna Factor and Cable Factor and subtracting the Amplifier Gain and Duty Cycle Correction Factor(if any) from the measured reading. The basic equation with a sample calculation is as follows:

$$FS = RA + AF + CL - AG$$

Where FS = Field Strength	CL = Cable Attenuation Factor (Cable Loss)
RA = Reading Amplitude	AG = Amplifier Gain
AF = Antenna Factor	

**TEST RESULTS**

Remark:For radiated bandedge We measured at both mode, recorded worst case in antenna 0's 802.11 ac20 mode;

**For Conducted at Restricted Band Measurement**

For reporting purpose only.

Please refer to Appendix D.8.

Please refer to Appendix E.8.

Please refer to Appendix F.8.

Please refer to Appendix G.8.

**For Conducted Band edge Measurement**

For reporting purpose only.

Please refer to Appendix D.6.

Please refer to Appendix E.6.

Please refer to Appendix F.6.

Please refer to Appendix G.6.

**For Conducted Spurious Emissions Measurement**

For reporting purpose only.

Please refer to Appendix D.7.

Please refer to Appendix E.7.

Please refer to Appendix F.7.

Please refer to Appendix G.7.



## 4.9. Frequency Stability

### Standard Applicable

According to FCC §15.407(g) “Manufacturers of U-NII devices are responsible for ensuring frequency stability such that an emission is maintained within the band of operation under all conditions of normal operation as specified in the user manual.”

According to FCC §2.1055(a) “The frequency stability shall be measured with variation of ambient temperature as follows:”

(1) From -30° to + 50° centigrade for all equipment except that specified in paragraphs (a) (2) and (3) of this section.

(2) From -20° to + 50° centigrade for equipment to be licensed for use in the Maritime Services under part 80 of this chapter, except for Class A, B, and S Emergency Position Indicating Radiobeacons (EPIRBS), and equipment to be licensed for use above 952 MHz at operational fixed stations in all services, stations in the Local Television Transmission Service and Point-to-Point Microwave Radio Service under part 21 of this chapter, equipment licensed for use aboard aircraft in the Aviation Services under part 87 of this chapter, and equipment authorized for use in the Family Radio Service under part 95 of this chapter.

(3) From 0° to + 50° centigrade for equipment to be licensed for use in the Radio Broadcast Services under part 73 of this chapter.

### Test Configuration

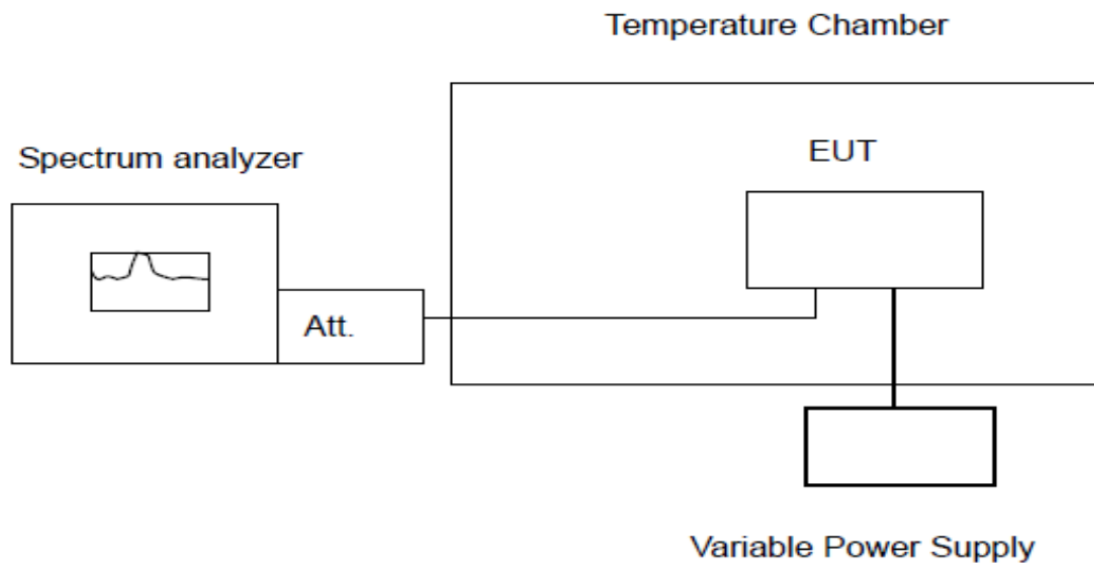

### Test Procedure

The equipment under test was connected to an external AC or DC power supply and input rated voltage. RF output was connected to a frequency counter or spectrum analyzer via feed through attenuators. The EUT was placed inside the temperature chamber. Set the spectrum analyzer RBW low enough to obtain the desired frequency resolution and measure EUT 20 degree operating frequency as reference frequency. Turn EUT off and set the chamber temperature to -30 degree. After the temperature stabilized for approximately 30 minutes recorded the frequency. Repeat step measure with 10 degree increased per stage until the highest temperature of +50 degree reached.

**Test Results**

PASS

Remark:

1. Measured all conditions and recorded worst case.

IEEE 802.11a Mode / 5180 – 5240 MHz / 5180 MHz

Environment Temperature (Degree)	Voltage (V)	Measured Frequency (MHz)	Limit Range (MHz)	Test Results
20	DC 3.5V	5171.555503	5150 – 5250	PASS
20	DC 4.3V	5171.521736	5150 – 5250	PASS
50	DC 3.87V	5171.517257	5150 – 5250	PASS
40	DC 3.87V	5171.643044	5150 – 5250	PASS
30	DC 3.87V	5171.608386	5150 – 5250	PASS
20	DC 3.87V	5171.631223	5150 – 5250	PASS
10	DC 3.87V	5171.590245	5150 – 5250	PASS
0	DC 3.87V	5171.625741	5150 – 5250	PASS
-10	DC 3.87V	5171.691551	5150 – 5250	PASS
-20	DC 3.87V	5171.599754	5150 – 5250	PASS
-30	DC 3.87V	5171.673429	5150 – 5250	PASS

IEEE 802.11a Mode / 5180 – 5240 MHz / 5240 MHz

Environment Temperature (Degree)	Voltage (V)	Measured Frequency (MHz)	Limit Range (MHz)	Test Results
20	DC 3.5V	5248.615359	5150 – 5250	PASS
20	DC 4.3V	5248.656863	5150 – 5250	PASS
50	DC 3.87V	5248.548680	5150 – 5250	PASS
40	DC 3.87V	5248.629531	5150 – 5250	PASS
30	DC 3.87V	5248.674476	5150 – 5250	PASS
20	DC 3.87V	5248.585701	5150 – 5250	PASS
10	DC 3.87V	5248.661680	5150 – 5250	PASS
0	DC 3.87V	5248.558076	5150 – 5250	PASS
-10	DC 3.87V	5248.514351	5150 – 5250	PASS
-20	DC 3.87V	5248.612452	5150 – 5250	PASS
-30	DC 3.87V	5248.644205	5150 – 5250	PASS

IEEE 802.11a Mode / 5260 – 5320 MHz / 5260 MHz

Environment Temperature (Degree)	Voltage (V)	Measured Frequency (MHz)	Limit Range (MHz)	Test Results
20	DC 3.5V	5251.631088	5250 – 5350	PASS
20	DC 4.3V	5251.554715	5250 – 5350	PASS
50	DC 3.87V	5251.665198	5250 – 5350	PASS
40	DC 3.87V	5251.600236	5250 – 5350	PASS
30	DC 3.87V	5251.533118	5250 – 5350	PASS
20	DC 3.87V	5251.573084	5250 – 5350	PASS
10	DC 3.87V	5251.607924	5250 – 5350	PASS
0	DC 3.87V	5251.600433	5250 – 5350	PASS
-10	DC 3.87V	5251.650211	5250 – 5350	PASS
-20	DC 3.87V	5251.678734	5250 – 5350	PASS
-30	DC 3.87V	5251.696337	5250 – 5350	PASS

IEEE 802.11a Mode / 5260 – 5320 MHz / 5320 MHz

Environment Temperature (Degree)	Voltage (V)	Measured Frequency (MHz)	Limit Range (MHz)	Test Results
20	DC 3.5V	5328.526440	5250 – 5350	PASS
20	DC 4.3V	5328.577423	5250 – 5350	PASS
50	DC 3.87V	5328.669784	5250 – 5350	PASS
40	DC 3.87V	5328.504411	5250 – 5350	PASS
30	DC 3.87V	5328.559460	5250 – 5350	PASS
20	DC 3.87V	5328.689245	5250 – 5350	PASS
10	DC 3.87V	5328.646149	5250 – 5350	PASS
0	DC 3.87V	5328.507825	5250 – 5350	PASS
-10	DC 3.87V	5328.680822	5250 – 5350	PASS
-20	DC 3.87V	5328.558327	5250 – 5350	PASS
-30	DC 3.87V	5328.533920	5250 – 5350	PASS

IEEE 802.11a Mode / 5500 – 5700 MHz / 5500 MHz

Environment Temperature (Degree)	Voltage (V)	Measured Frequency (MHz)	Limit Range (MHz)	Test Results
20	DC 3.5V	5491.536341	5470 – 5725	PASS
20	DC 4.3V	5491.518432	5470 – 5725	PASS
50	DC 3.87V	5491.502220	5470 – 5725	PASS
40	DC 3.87V	5491.651833	5470 – 5725	PASS
30	DC 3.87V	5491.585698	5470 – 5725	PASS
20	DC 3.87V	5491.617147	5470 – 5725	PASS
10	DC 3.87V	5491.521624	5470 – 5725	PASS
0	DC 3.87V	5491.506667	5470 – 5725	PASS
-10	DC 3.87V	5491.588041	5470 – 5725	PASS
-20	DC 3.87V	5491.565100	5470 – 5725	PASS
-30	DC 3.87V	5491.696507	5470 – 5725	PASS

IEEE 802.11a Mode / 5500 – 5700 MHz / 5700 MHz

Environment Temperature (Degree)	Voltage (V)	Measured Frequency (MHz)	Limit Range (MHz)	Test Results
20	DC 3.5V	5708.627973	5470 – 5725	PASS
20	DC 4.3V	5708.681008	5470 – 5725	PASS
50	DC 3.87V	5708.601586	5470 – 5725	PASS
40	DC 3.87V	5708.682071	5470 – 5725	PASS
30	DC 3.87V	5708.578099	5470 – 5725	PASS
20	DC 3.87V	5708.575997	5470 – 5725	PASS
10	DC 3.87V	5708.669394	5470 – 5725	PASS
0	DC 3.87V	5708.642602	5470 – 5725	PASS
-10	DC 3.87V	5708.519443	5470 – 5725	PASS
-20	DC 3.87V	5708.528512	5470 – 5725	PASS
-30	DC 3.87V	5708.511598	5470 – 5725	PASS

IEEE 802.11a Mode / 5745 – 5825 MHz / 5745 MHz

Environment Temperature (Degree)	Voltage (V)	Measured Frequency (MHz)	Limit Range (MHz)	Test Results
20	DC 3.5V	5736.683874	5725 – 5850	PASS
20	DC 4.3V	5736.692239	5725 – 5850	PASS
50	DC 3.87V	5736.613504	5725 – 5850	PASS
40	DC 3.87V	5736.573559	5725 – 5850	PASS
30	DC 3.87V	5736.601428	5725 – 5850	PASS
20	DC 3.87V	5736.508966	5725 – 5850	PASS
10	DC 3.87V	5736.549715	5725 – 5850	PASS
0	DC 3.87V	5736.648478	5725 – 5850	PASS
-10	DC 3.87V	5736.670013	5725 – 5850	PASS
-20	DC 3.87V	5736.569832	5725 – 5850	PASS
-30	DC 3.87V	5736.545485	5725 – 5850	PASS

IEEE 802.11a Mode / 5745 – 5825 MHz / 5825 MHz

Environment Temperature (Degree)	Voltage (V)	Measured Frequency (MHz)	Limit Range (MHz)	Test Results
20	DC 3.5V	5833.644014	5725 – 5850	PASS
20	DC 4.3V	5833.552177	5725 – 5850	PASS
50	DC 3.87V	5833.518604	5725 – 5850	PASS
40	DC 3.87V	5833.663842	5725 – 5850	PASS
30	DC 3.87V	5833.686534	5725 – 5850	PASS
20	DC 3.87V	5833.658820	5725 – 5850	PASS
10	DC 3.87V	5833.502323	5725 – 5850	PASS
0	DC 3.87V	5833.527945	5725 – 5850	PASS
-10	DC 3.87V	5833.579537	5725 – 5850	PASS
-20	DC 3.87V	5833.597667	5725 – 5850	PASS
-30	DC 3.87V	5833.511992	5725 – 5850	PASS

## 4.10. Antenna Requirement

### Standard Applicable

For intentional device, according to FCC 47 CFR Section 15.203, an intentional radiator shall be designed to ensure that no antenna other than that furnished by the responsible party shall be used with the device.

And according to FCC 47 CFR Section 15.407 (a), if transmitting antennas of directional gain greater than 6dBi are used, the power shall be reduced by the amount in dB that the directional gain of the antenna exceeds 6dBi.

### **Antenna Information**

The antenna is Internal Aantenna, through the buckle stretched out, The directional gains of antenna used for transmitting is 4.01dBi.

Reference to the Test Report: **CTA24050902601.**

**5. TEST SETUP PHOTOS OF THE EUT**

Reference to the test report No. CTA24050902601.

**6. EXTERNAL AND INTERNAL PHOTOS OF THE EUT**

Reference to the test report No. CTA24050902601.

.....**End of Report**.....