

Versions A

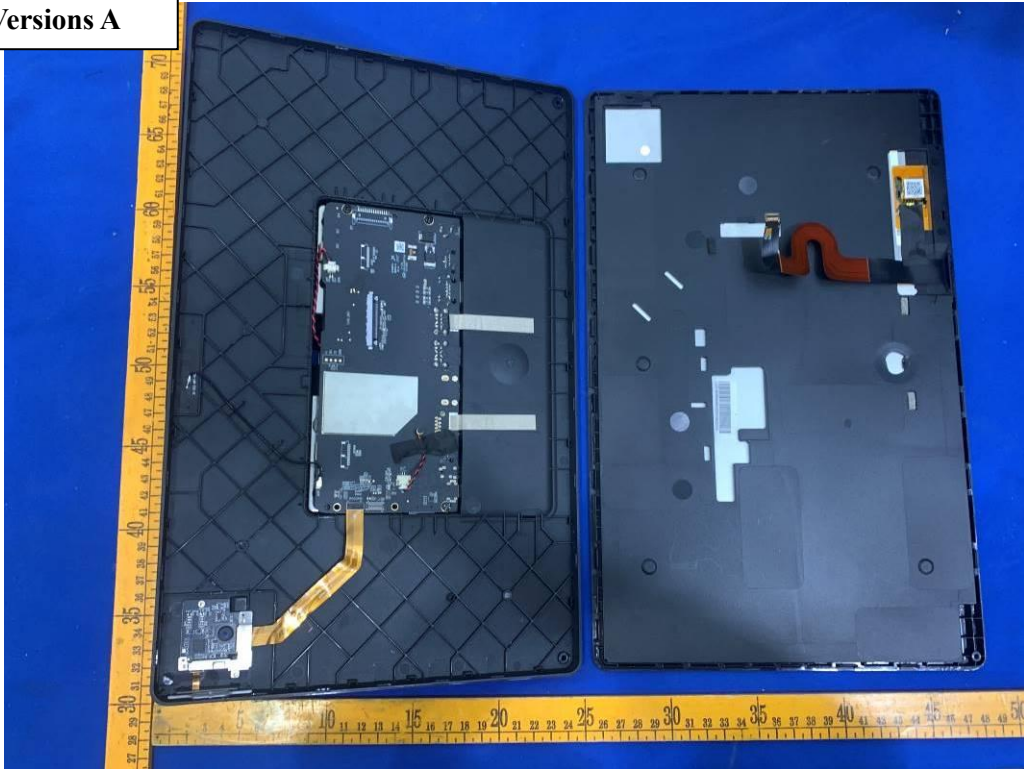

Fig. 1

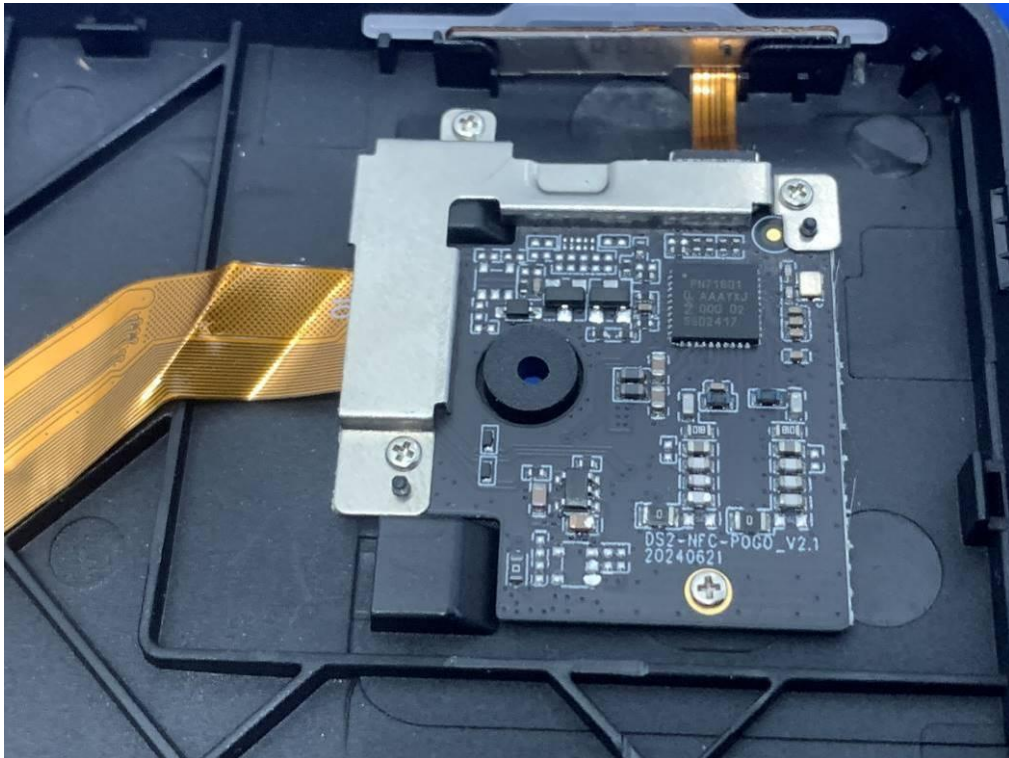

Fig. 2



Fig. 3

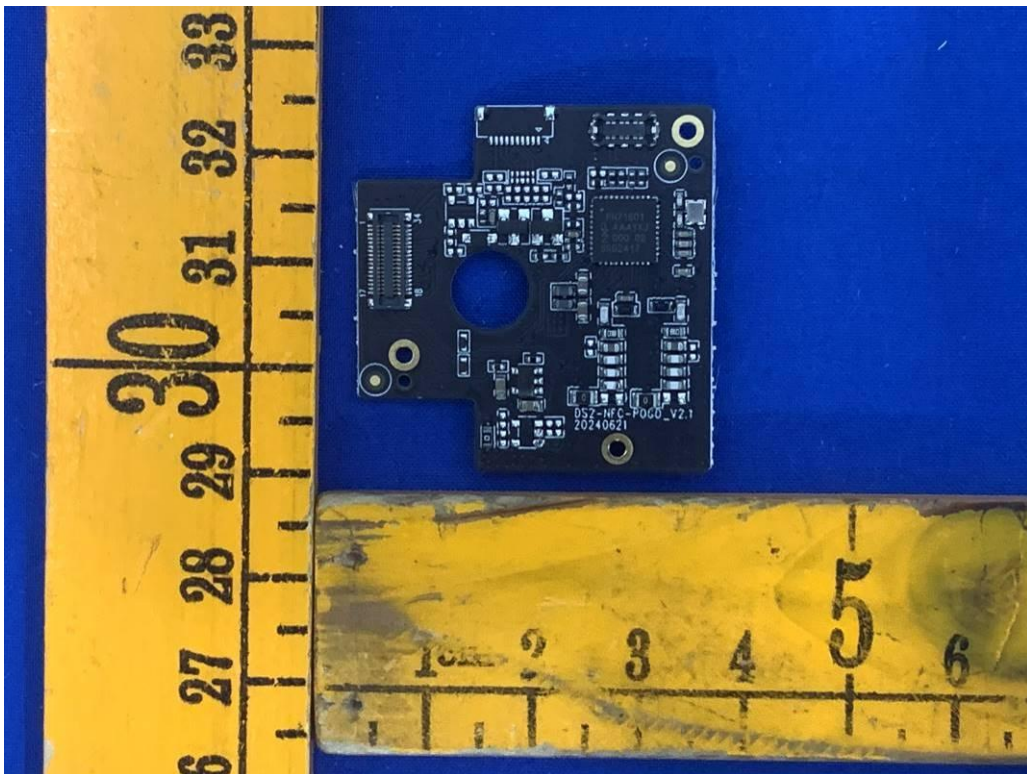

Fig. 4

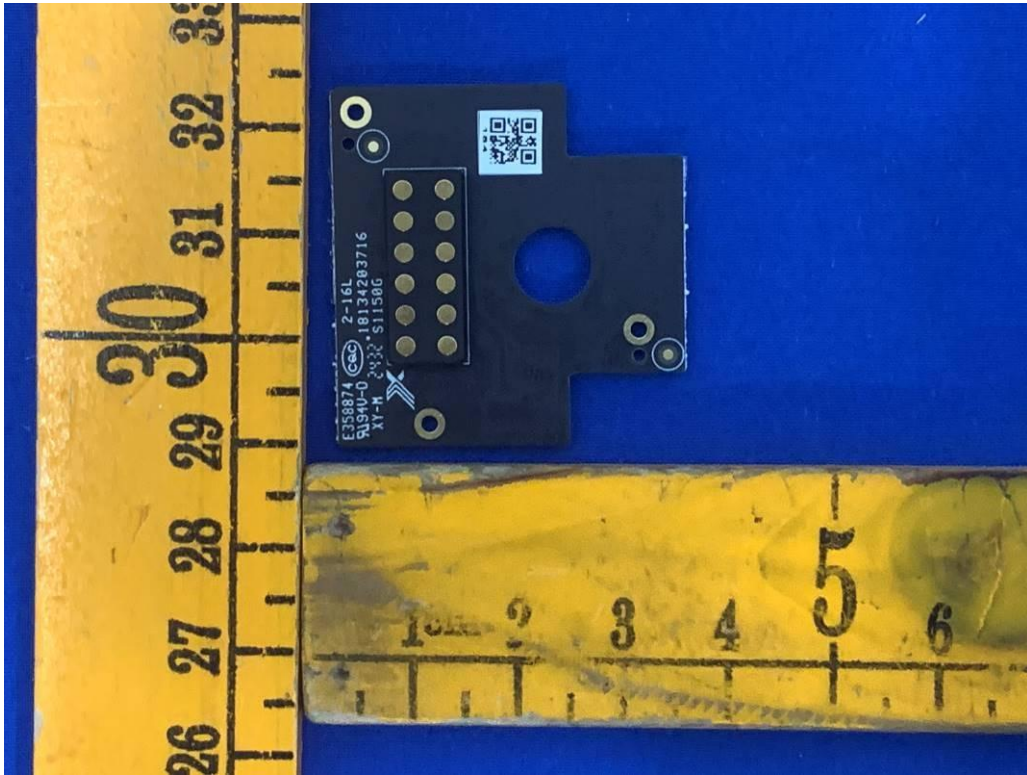

Fig. 5

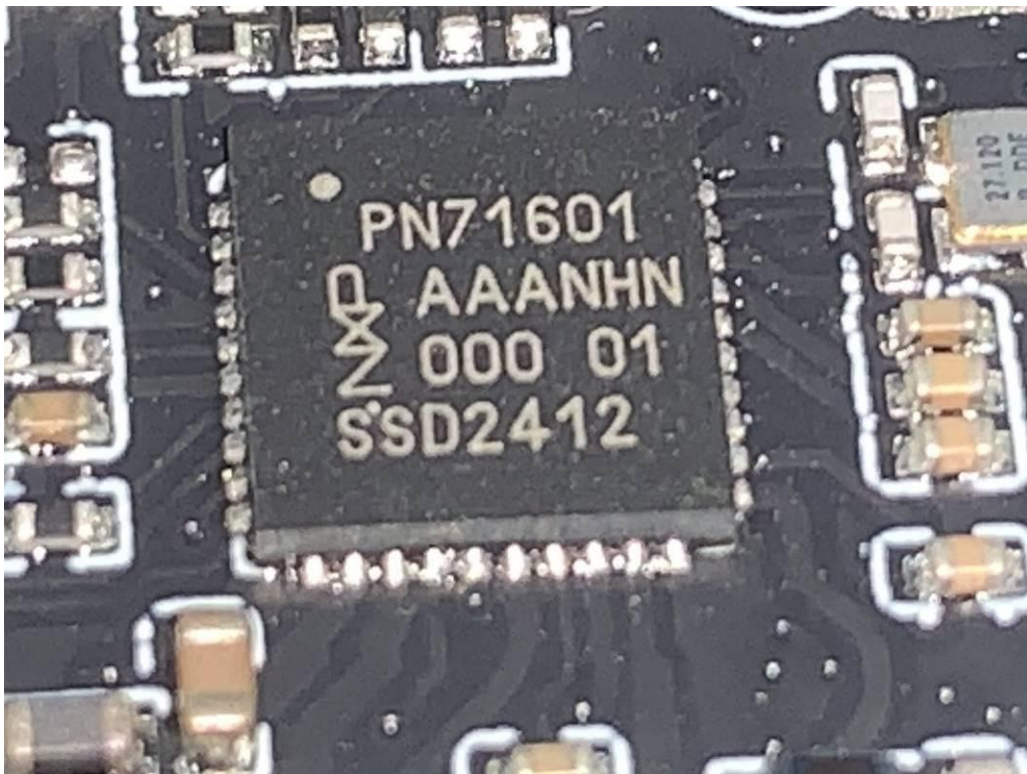

Fig. 6

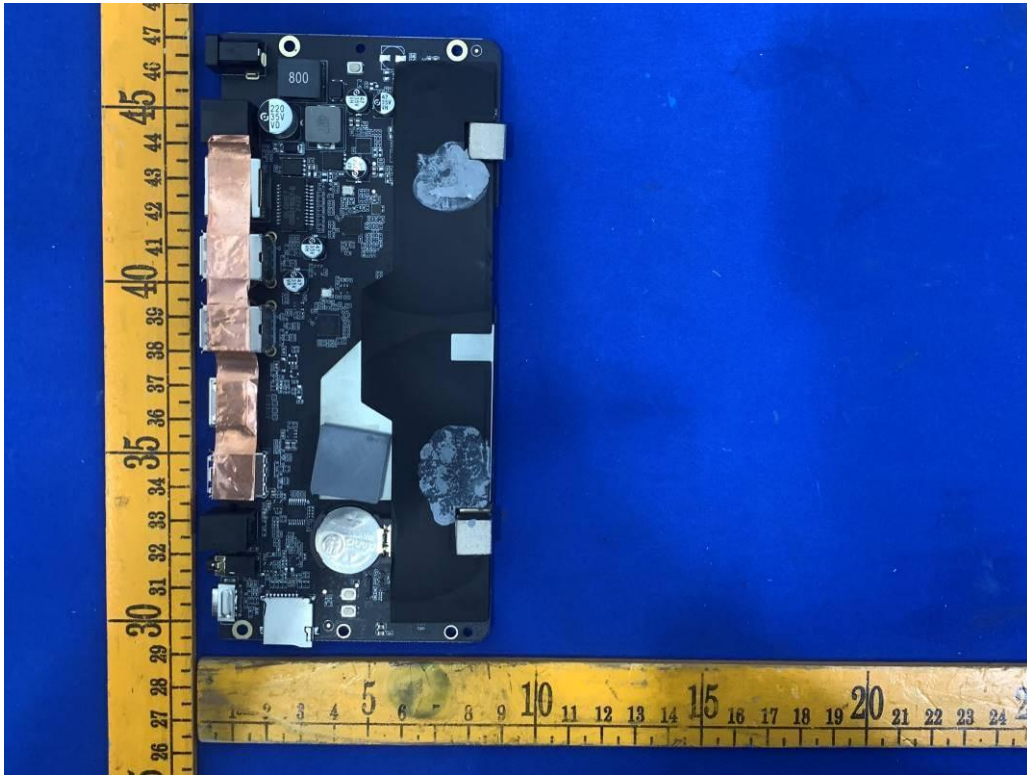

Fig. 7



Fig. 8

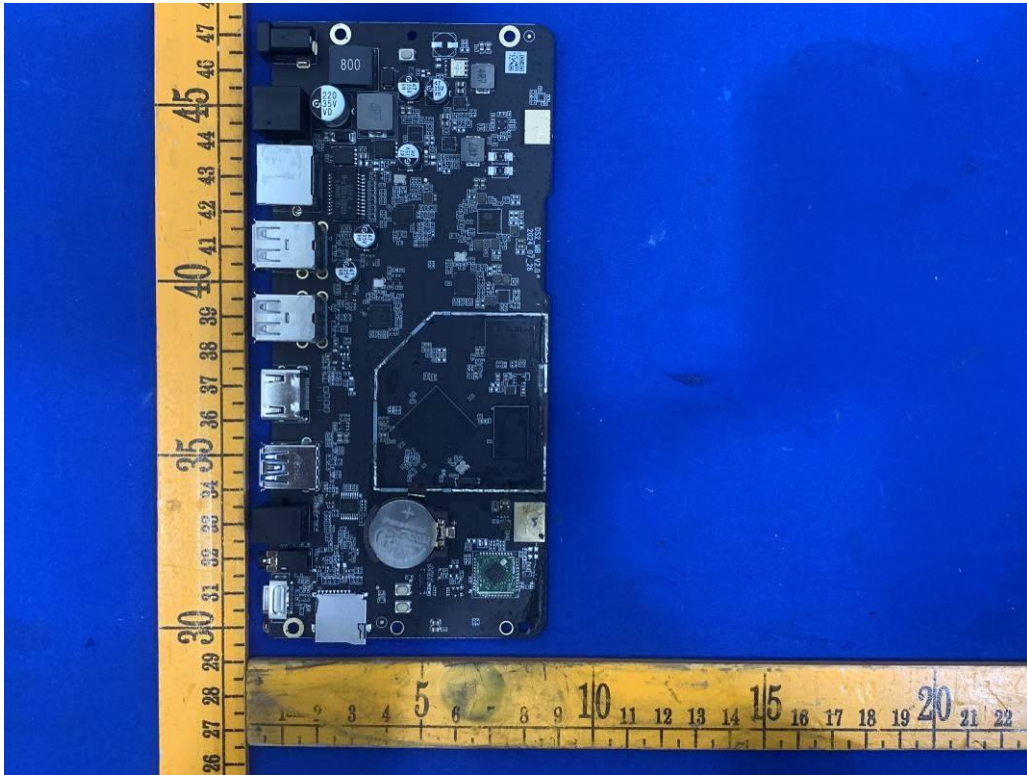

Fig. 9

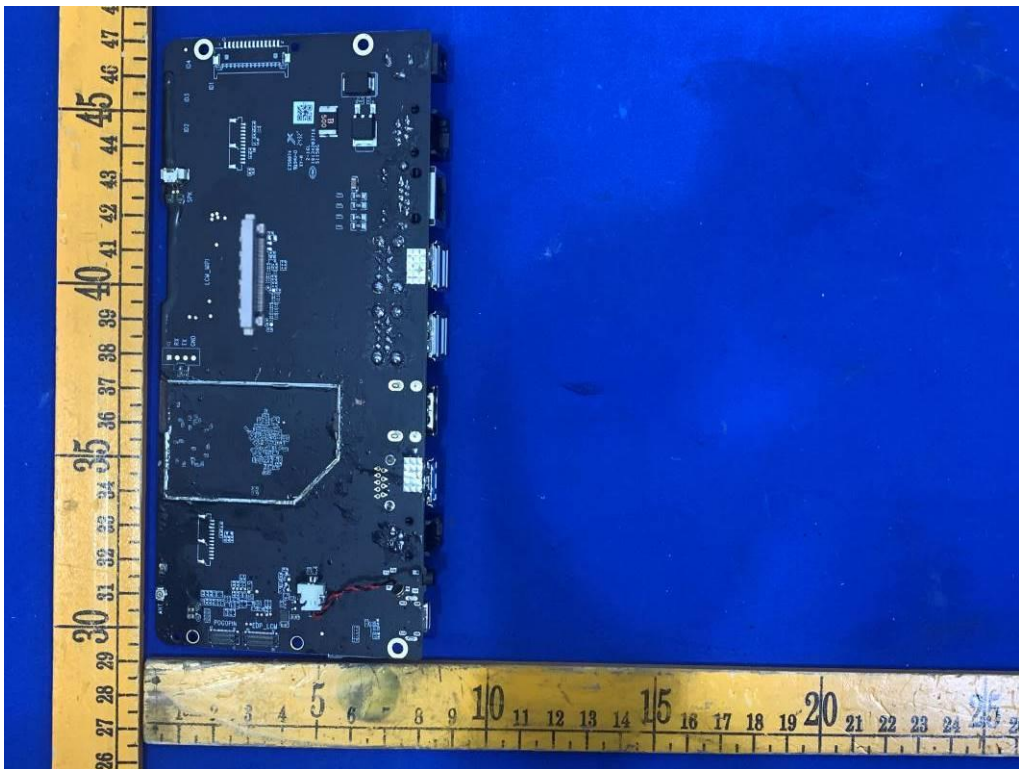

Fig. 10



Fig. 11

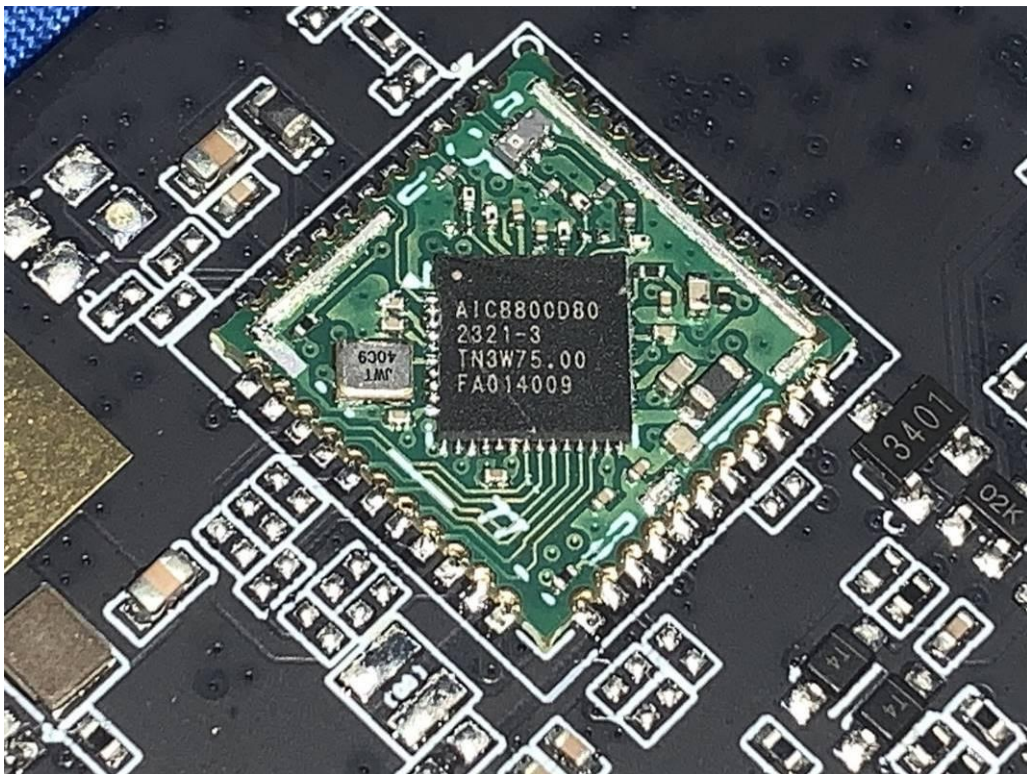

Fig. 12

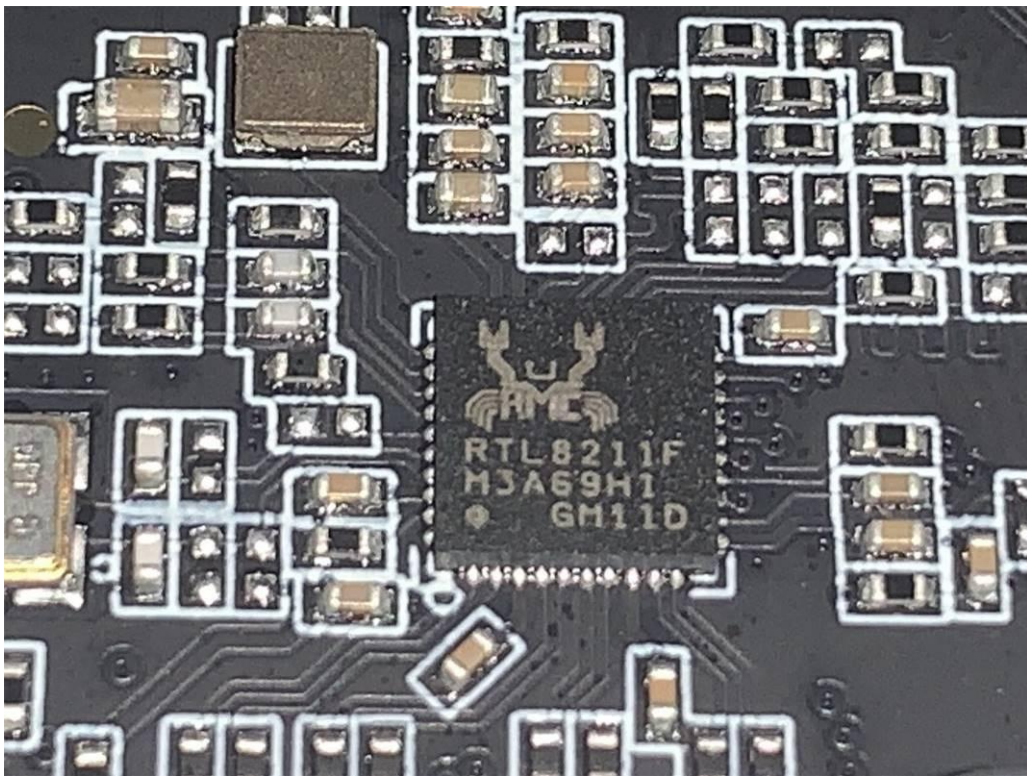

Fig. 13



Fig. 14

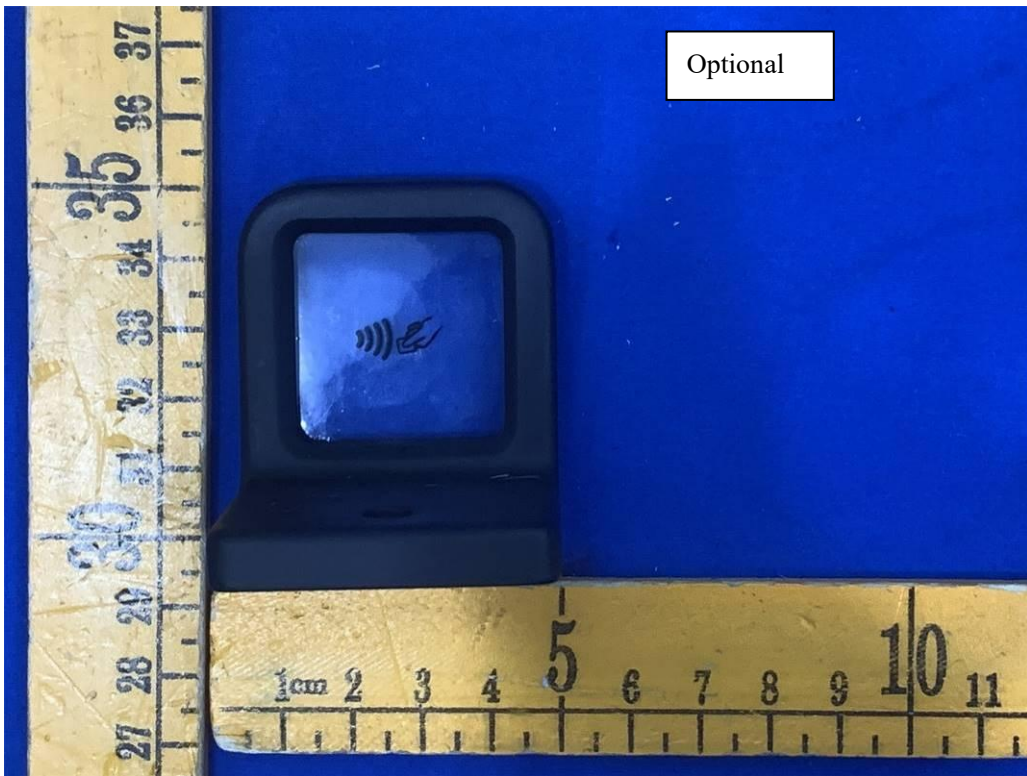

Fig. 15

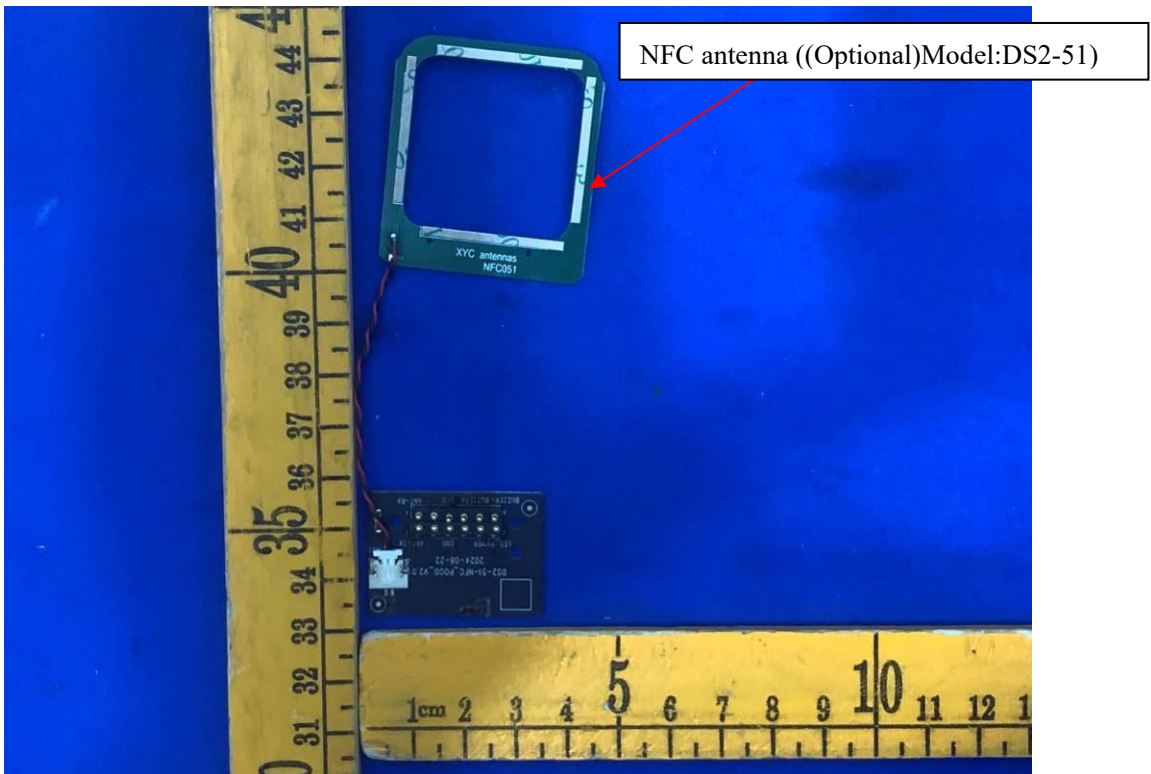

Fig. 16

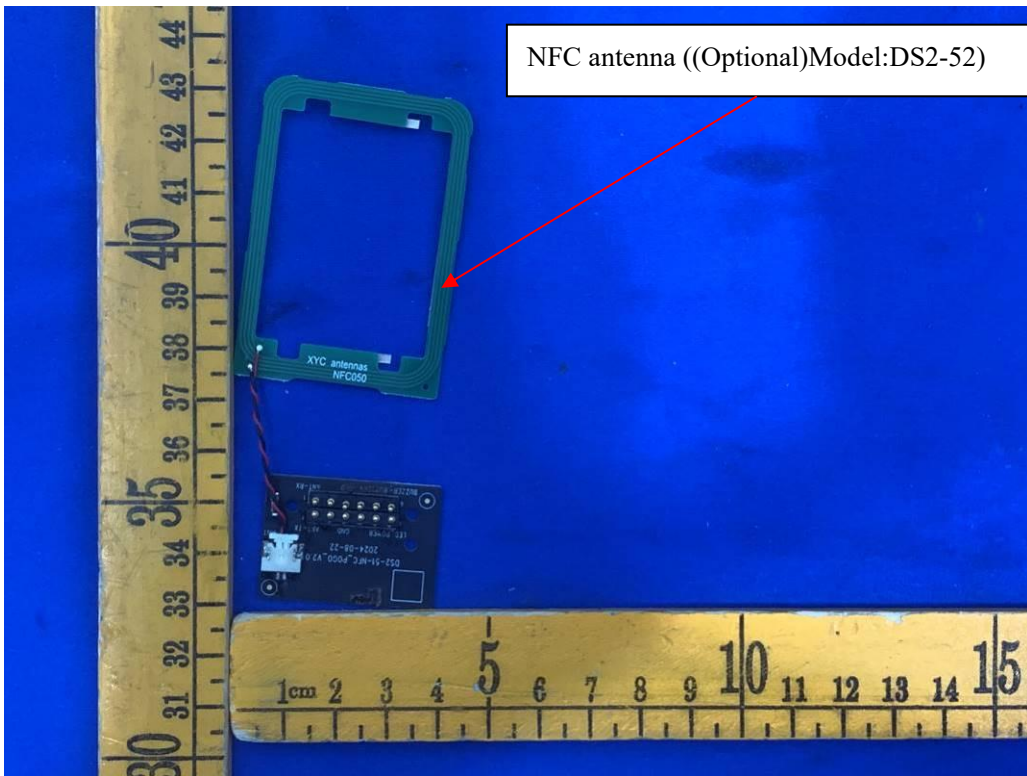

Fig. 17

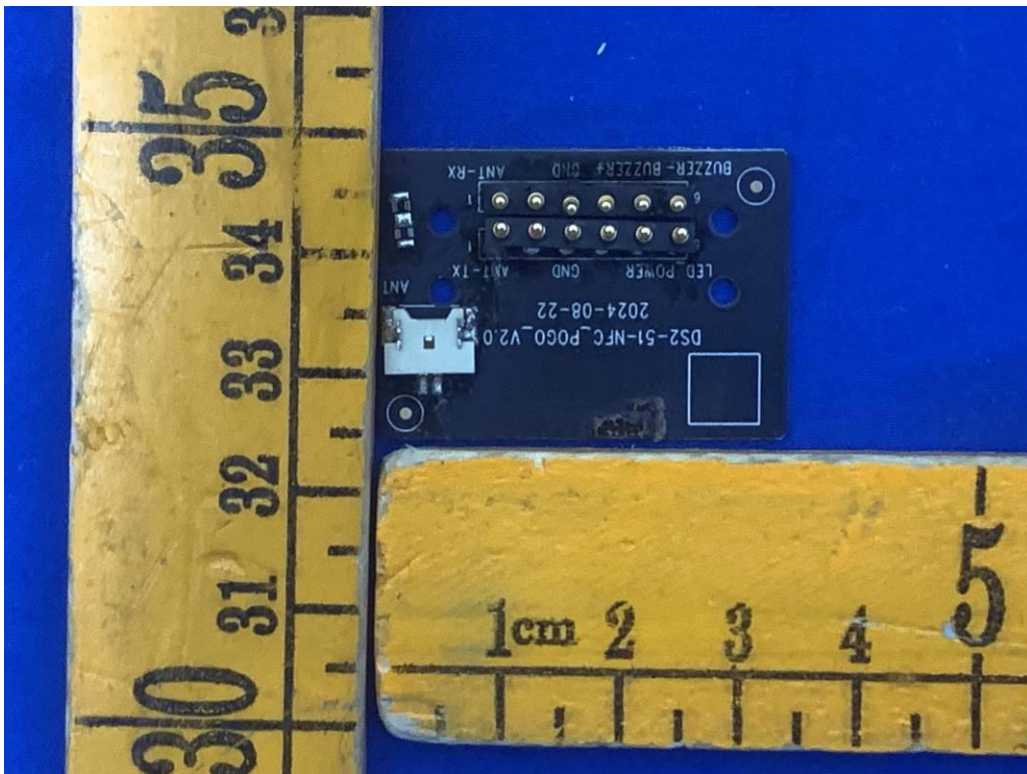

Fig. 18

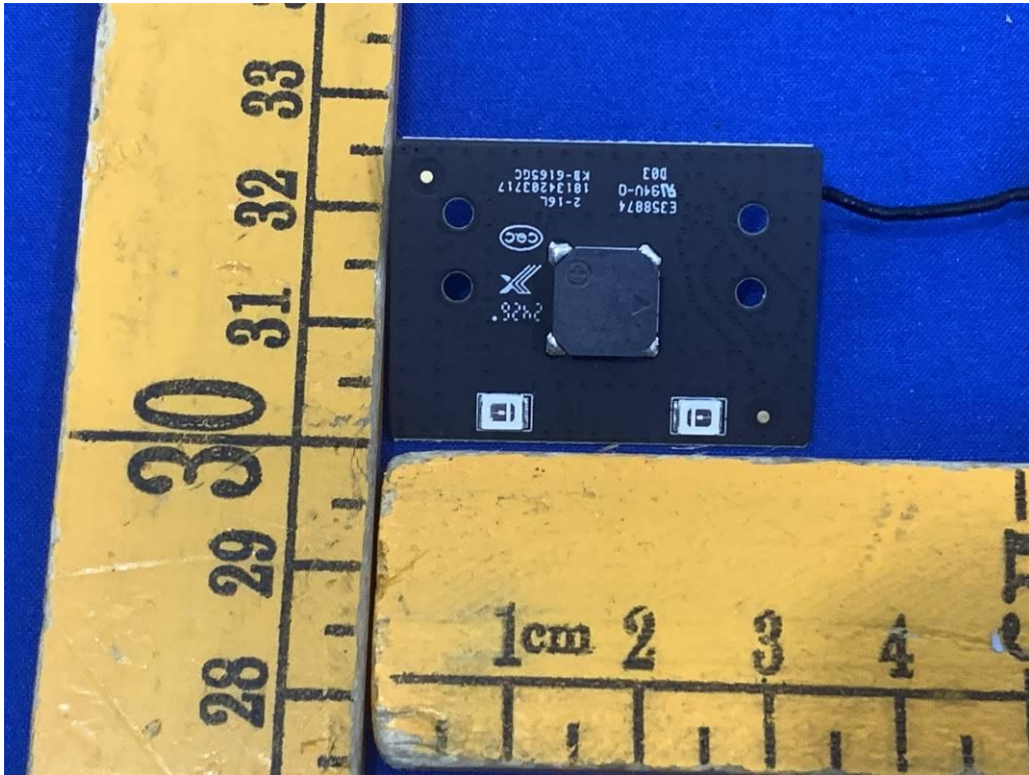

Fig. 19

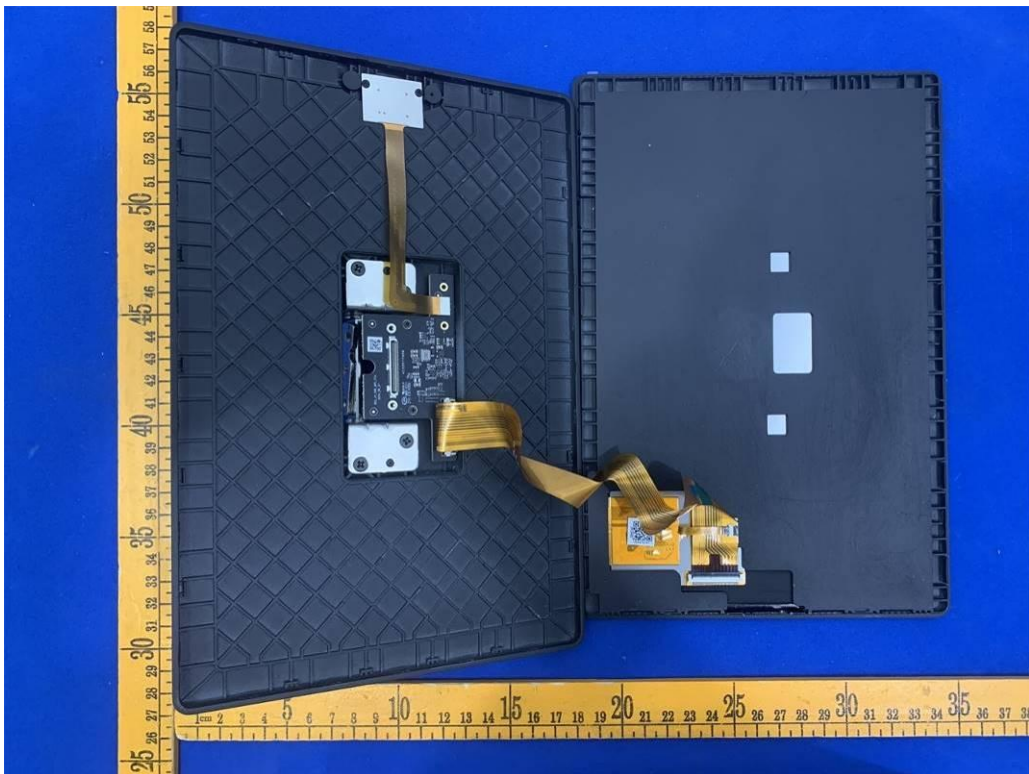

Fig. 20

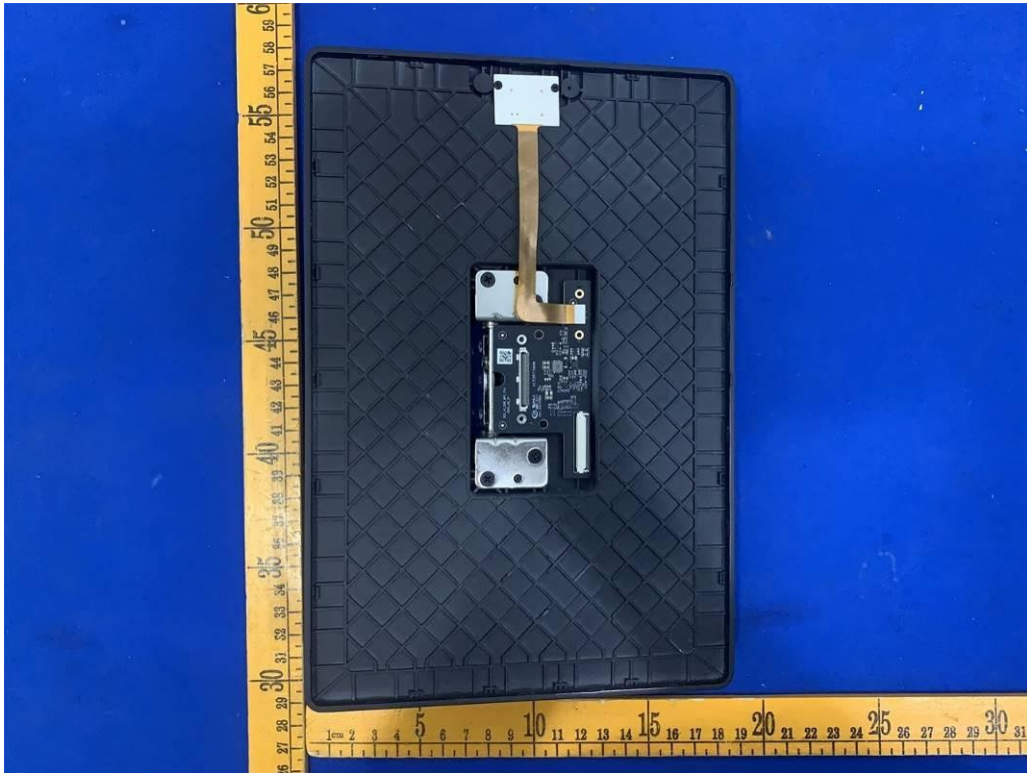

Fig. 21

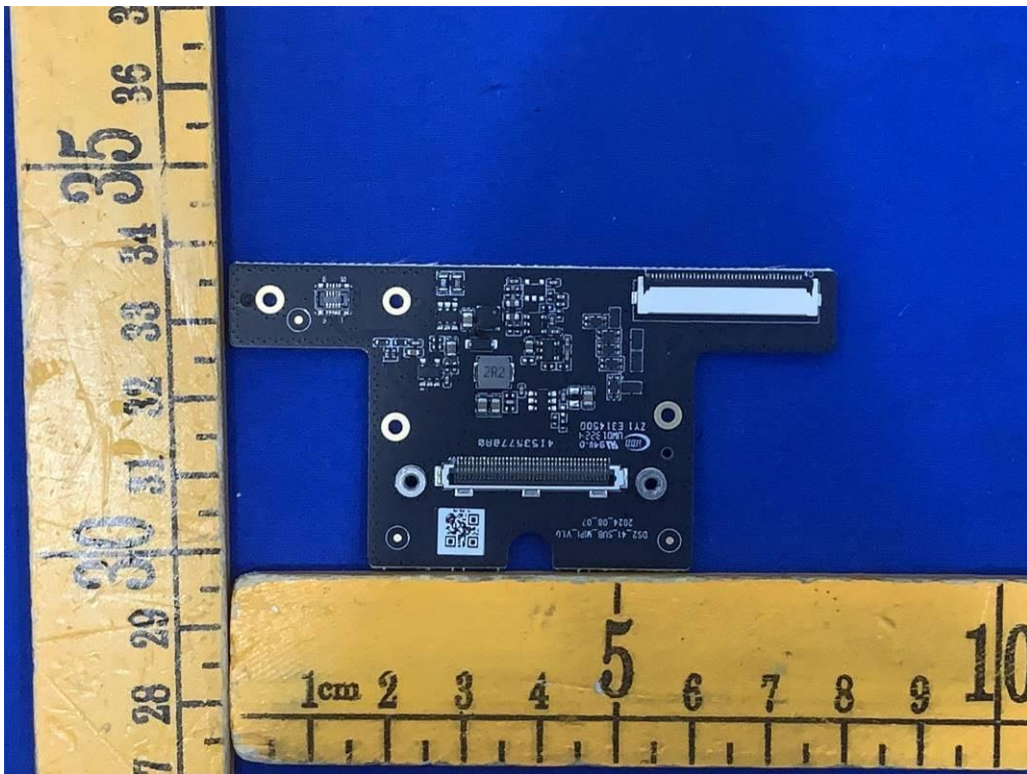

Fig. 22

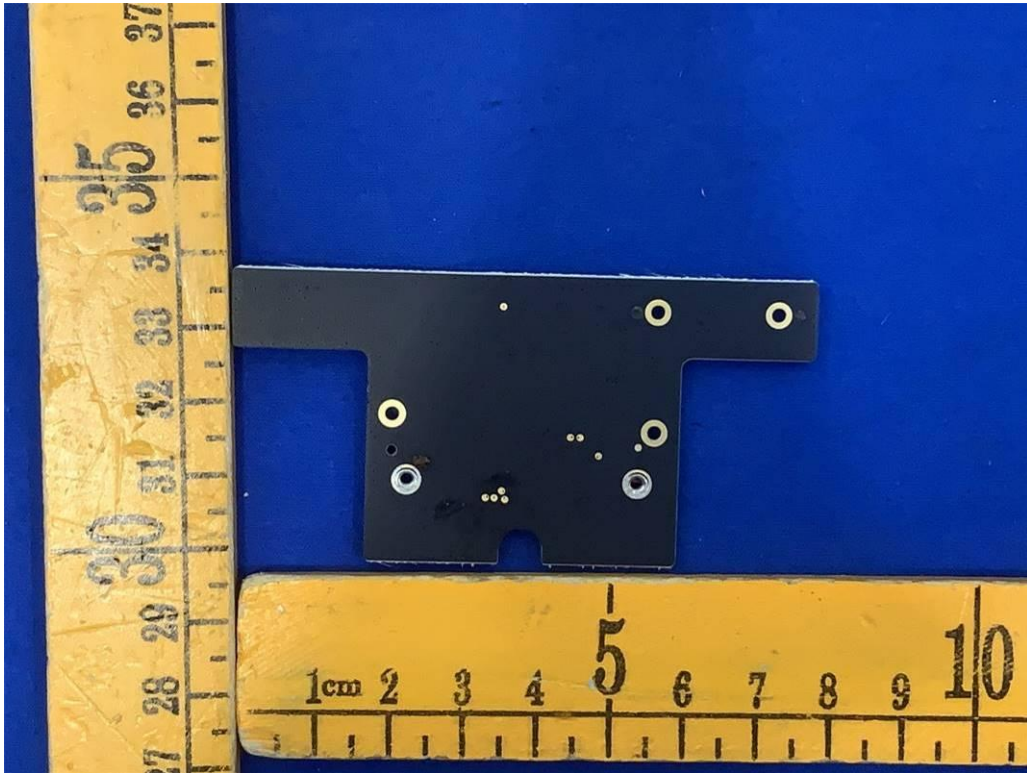

Fig. 23

Versions B

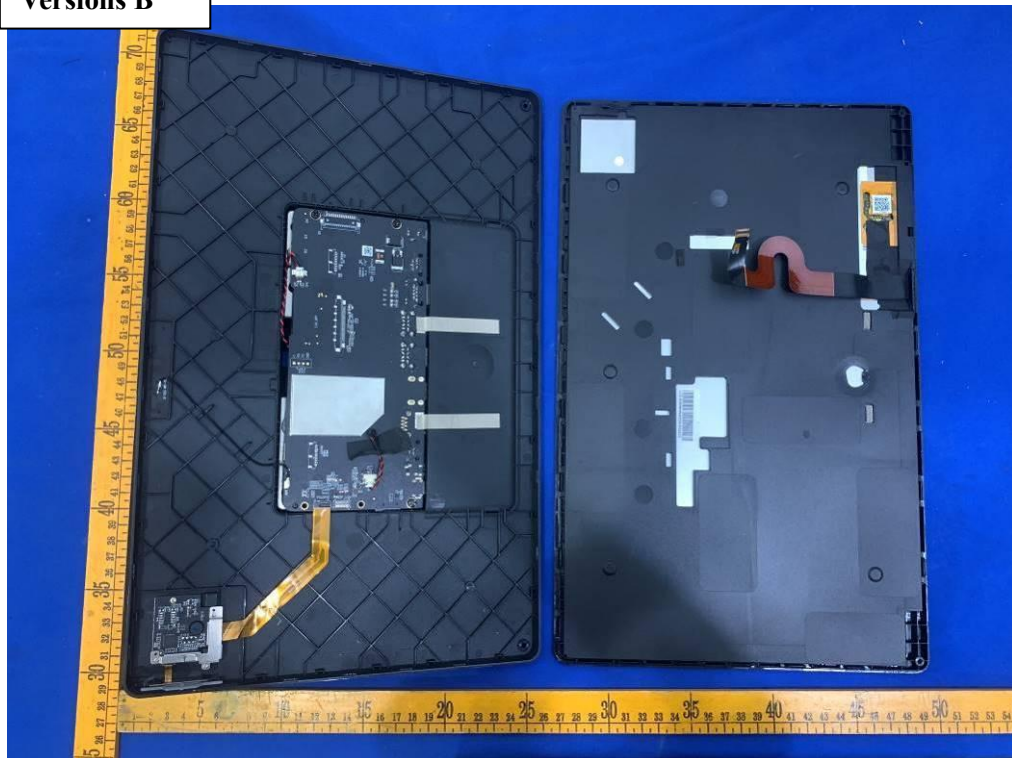

Fig. 24

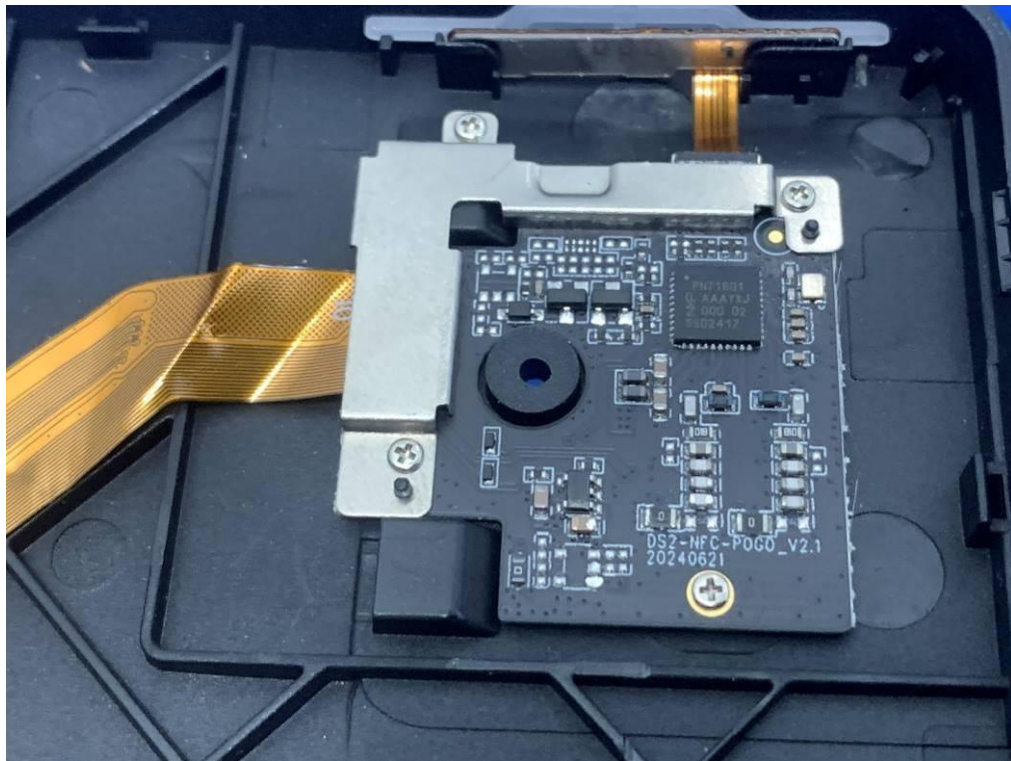

Fig. 25



Fig. 26

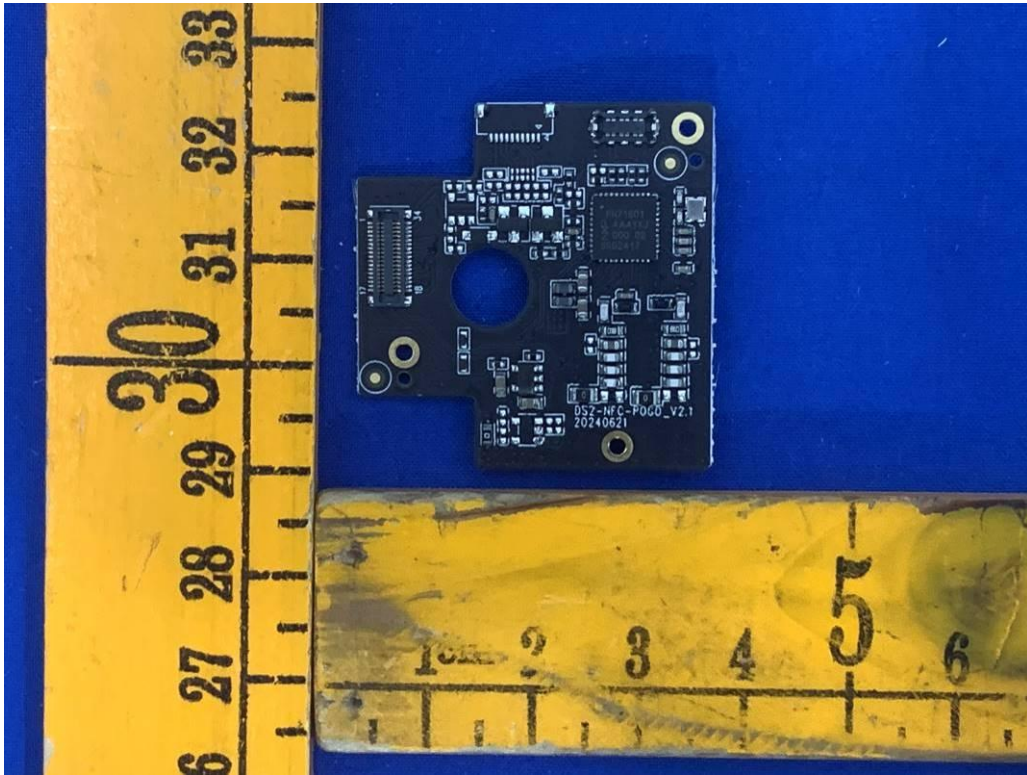

Fig. 27

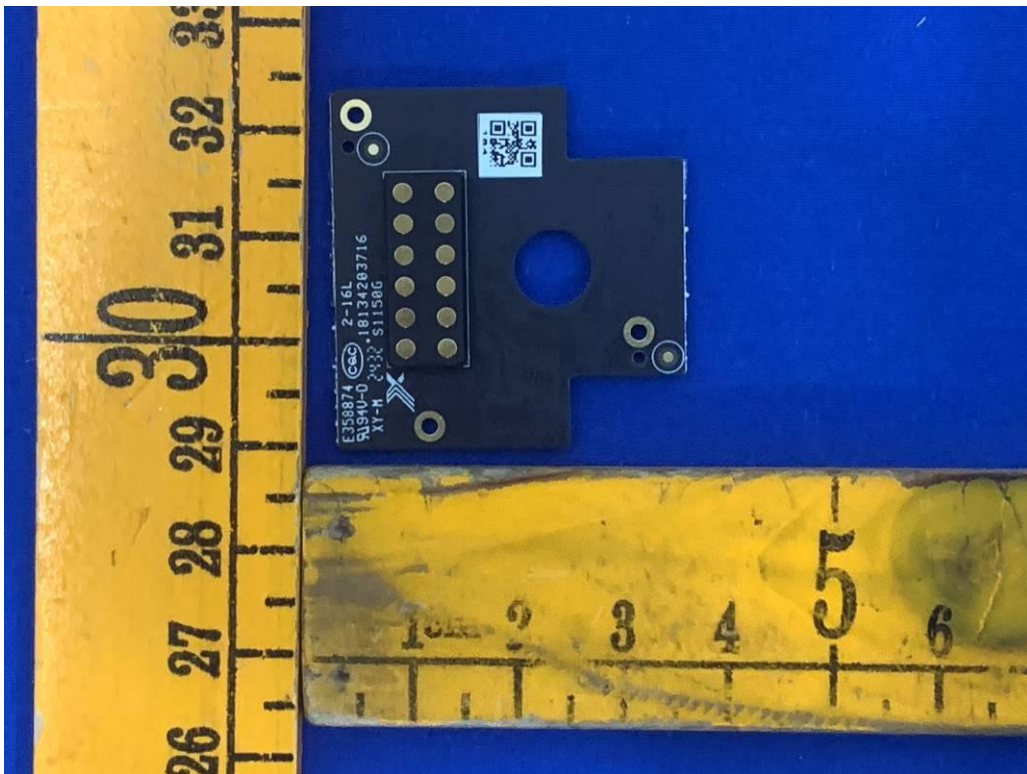

Fig. 28

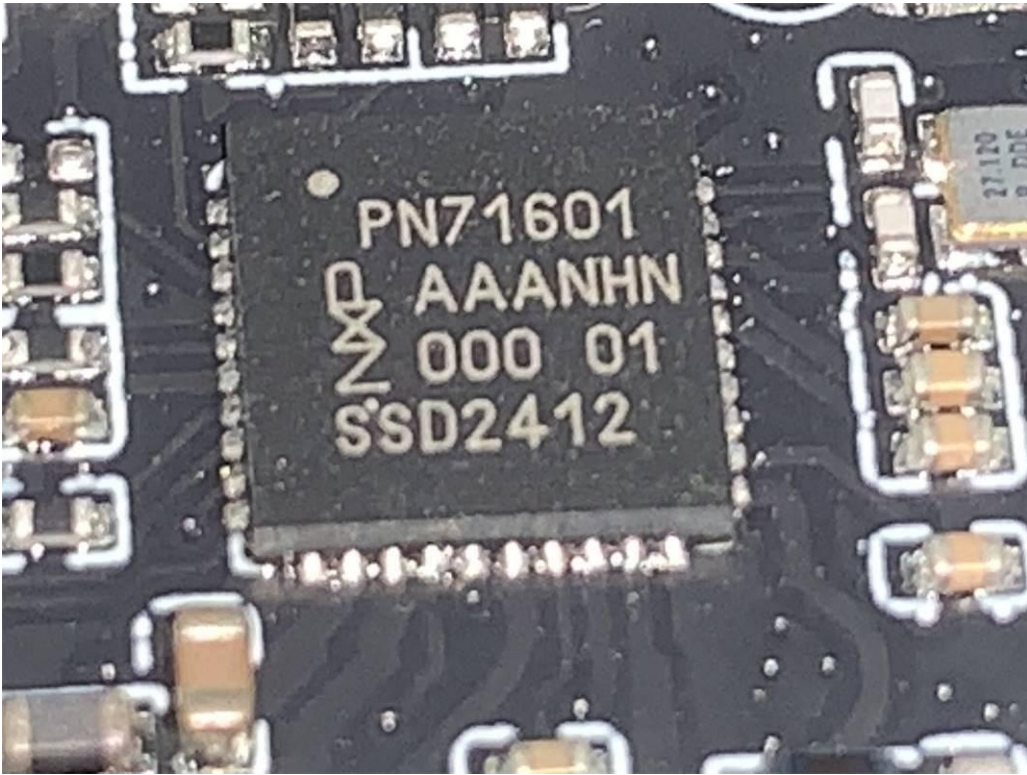

Fig. 29

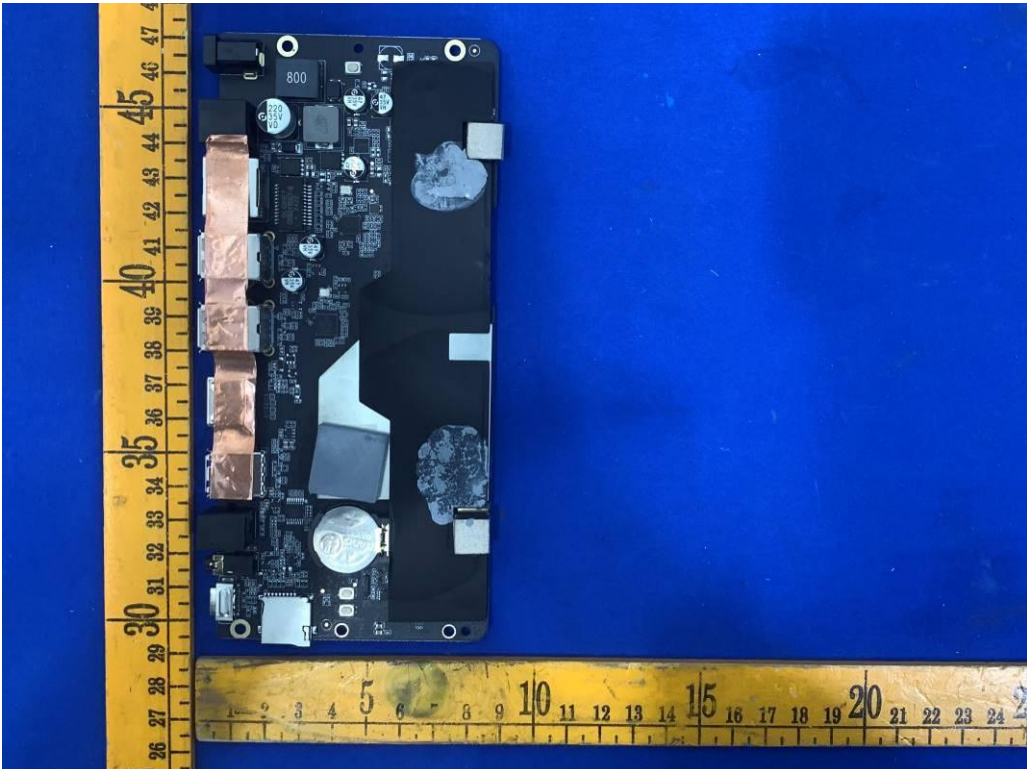

Fig. 30

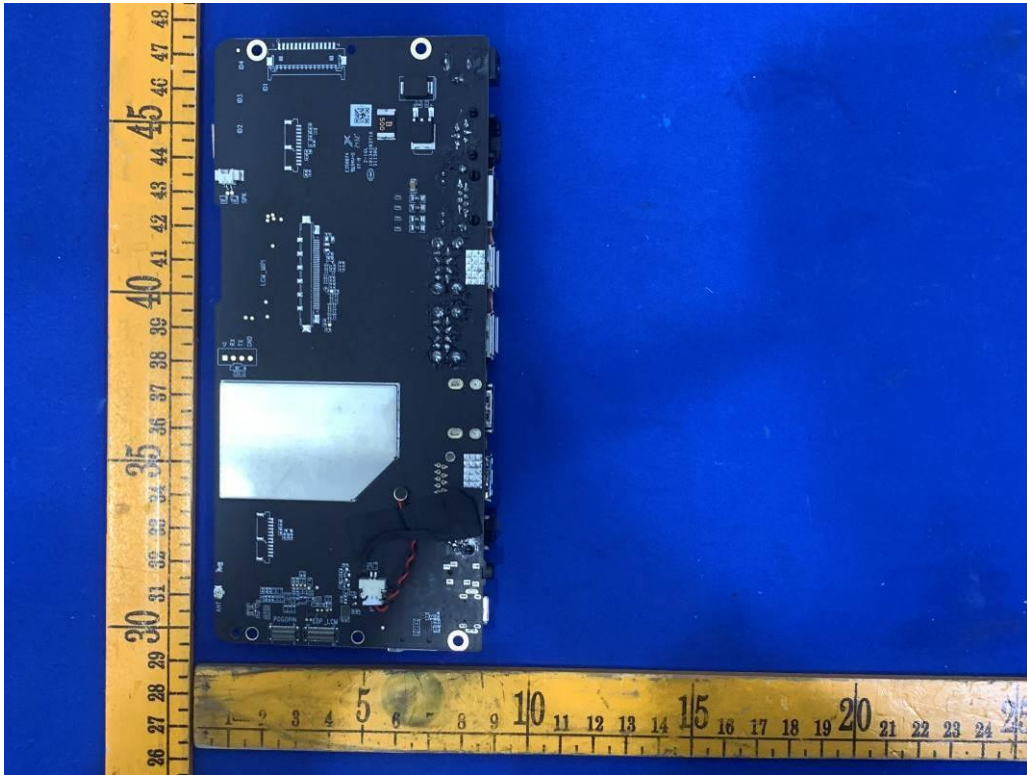

Fig. 31

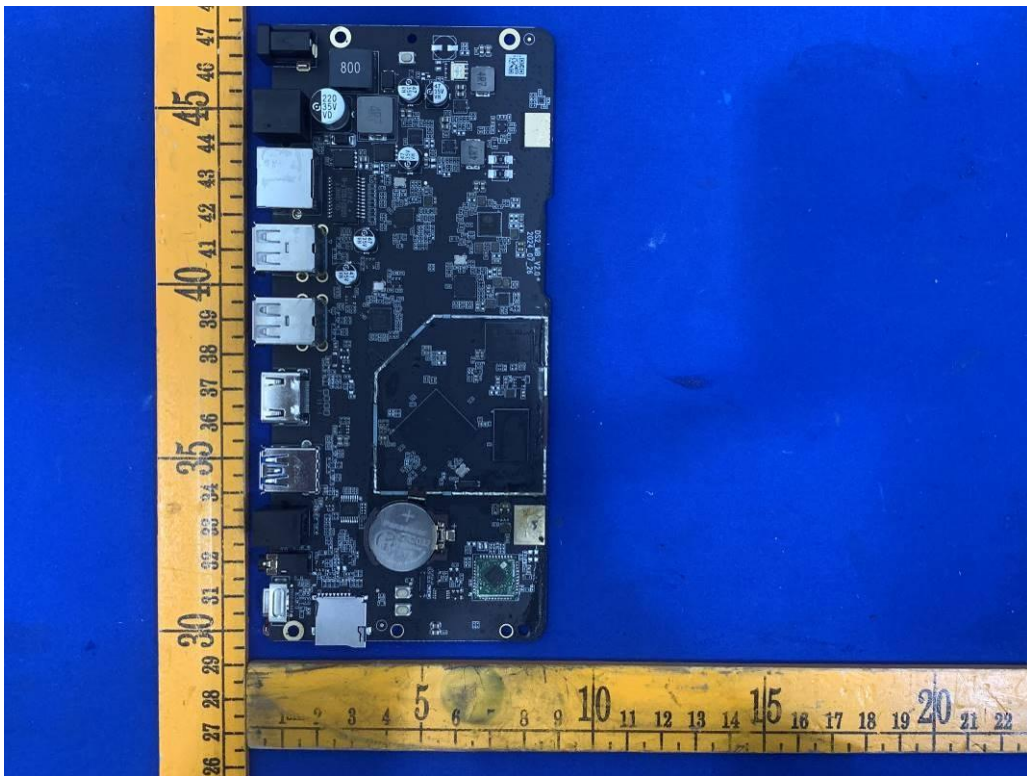

Fig. 32

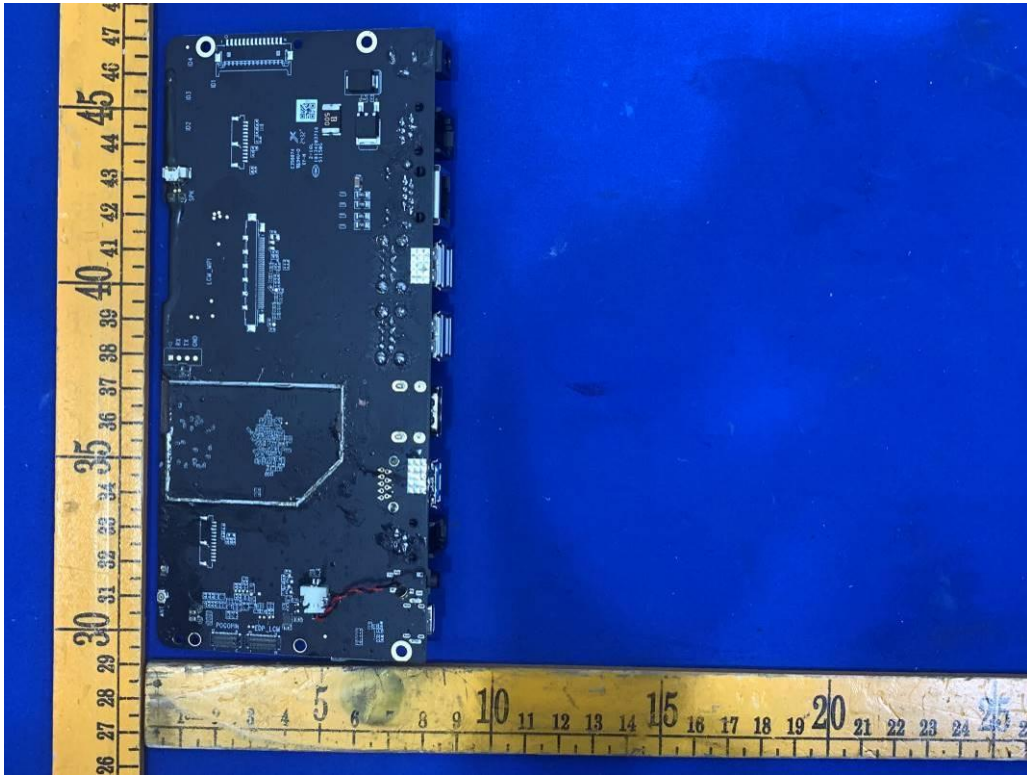

Fig. 33



Fig. 34

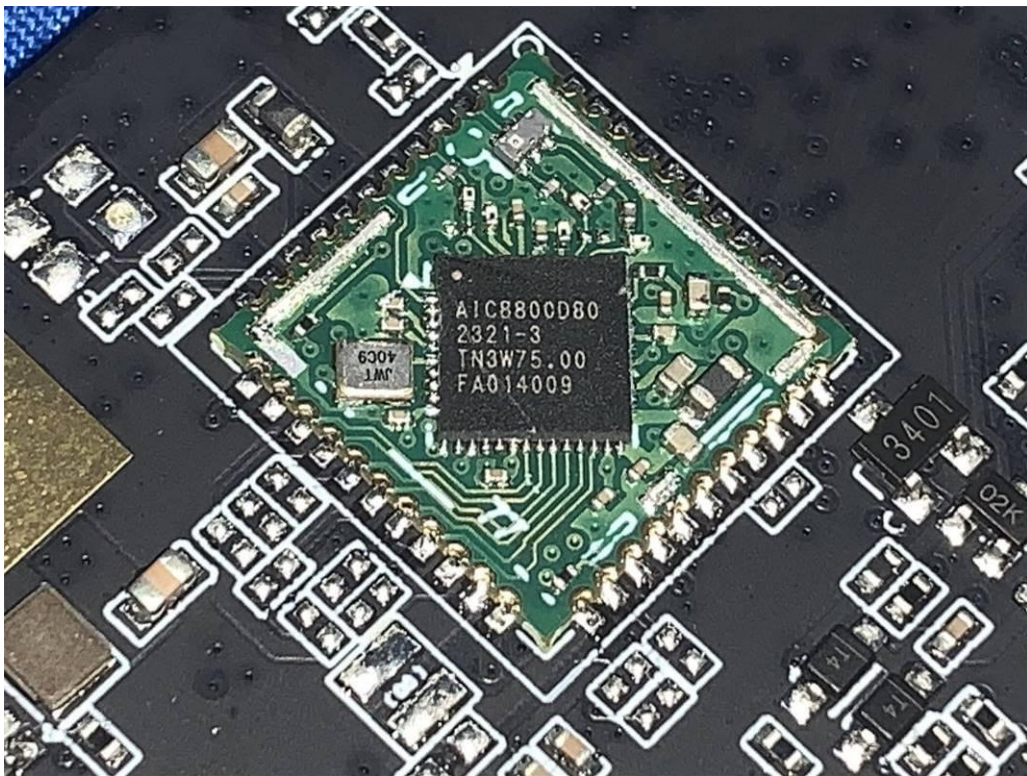

Fig. 35

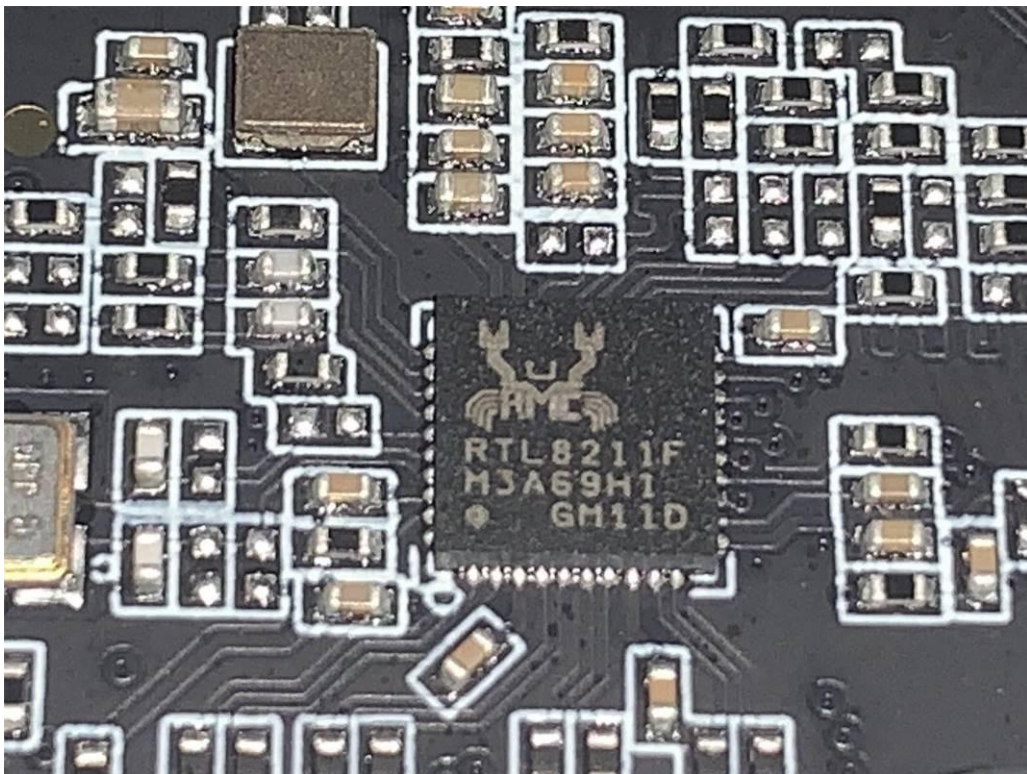

Fig. 36



Fig. 37

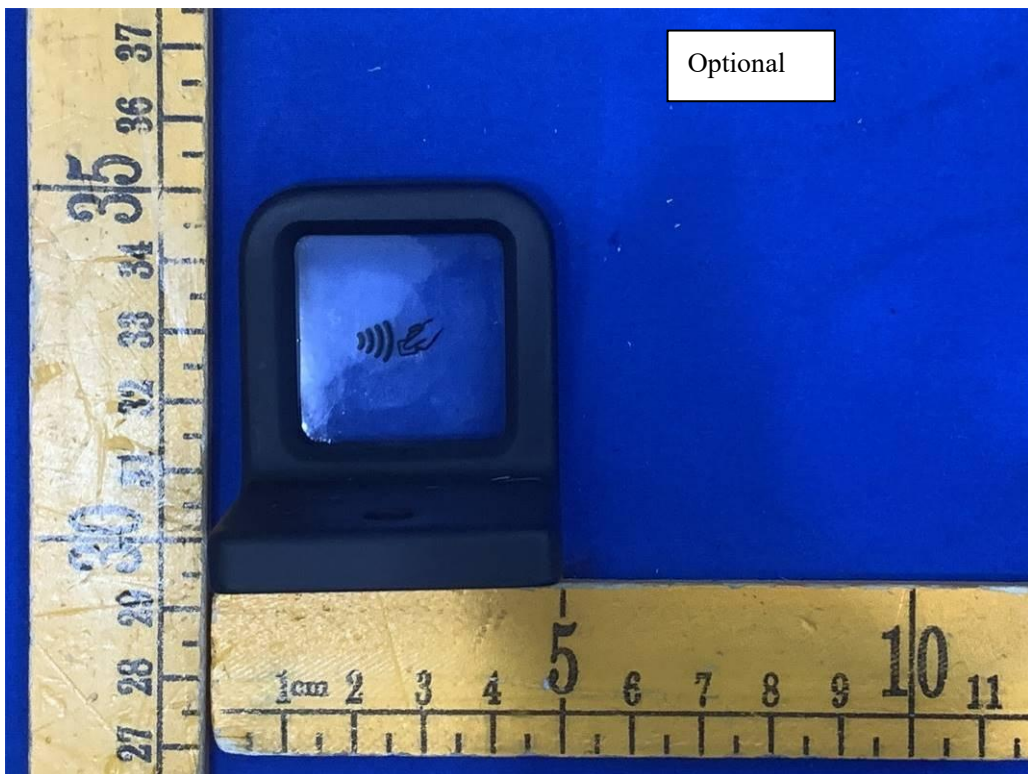

Fig. 38

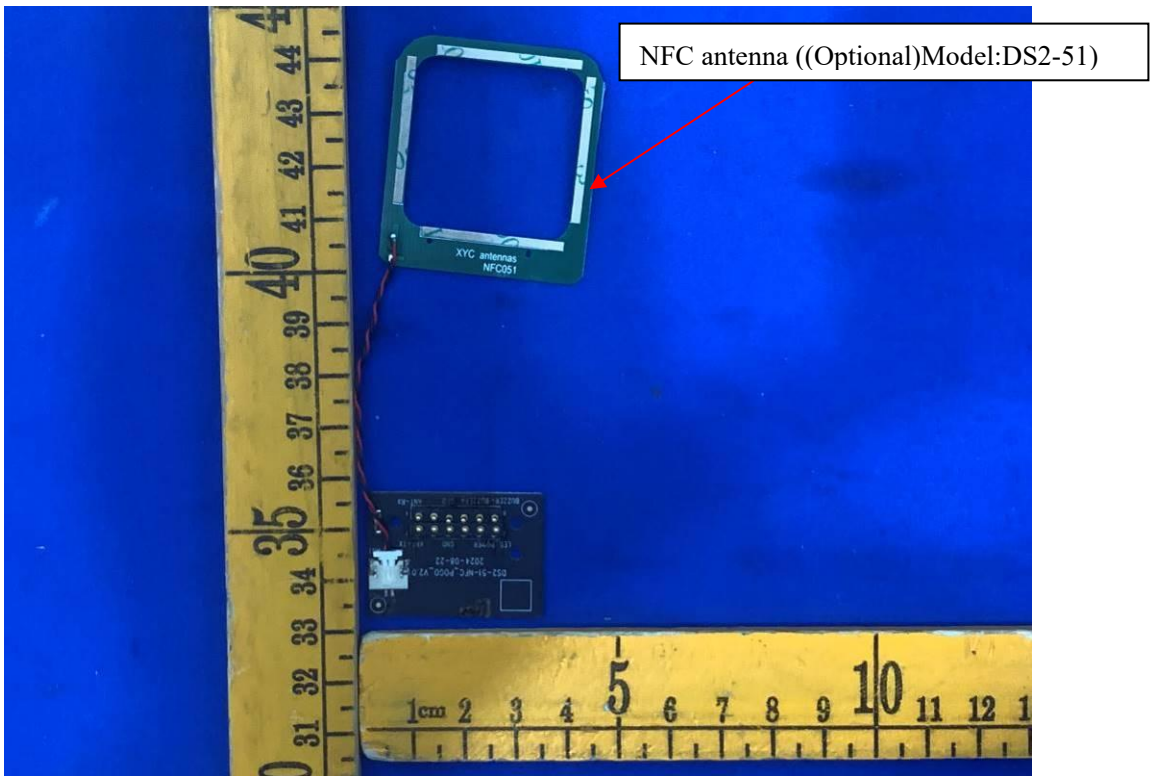

Fig. 39

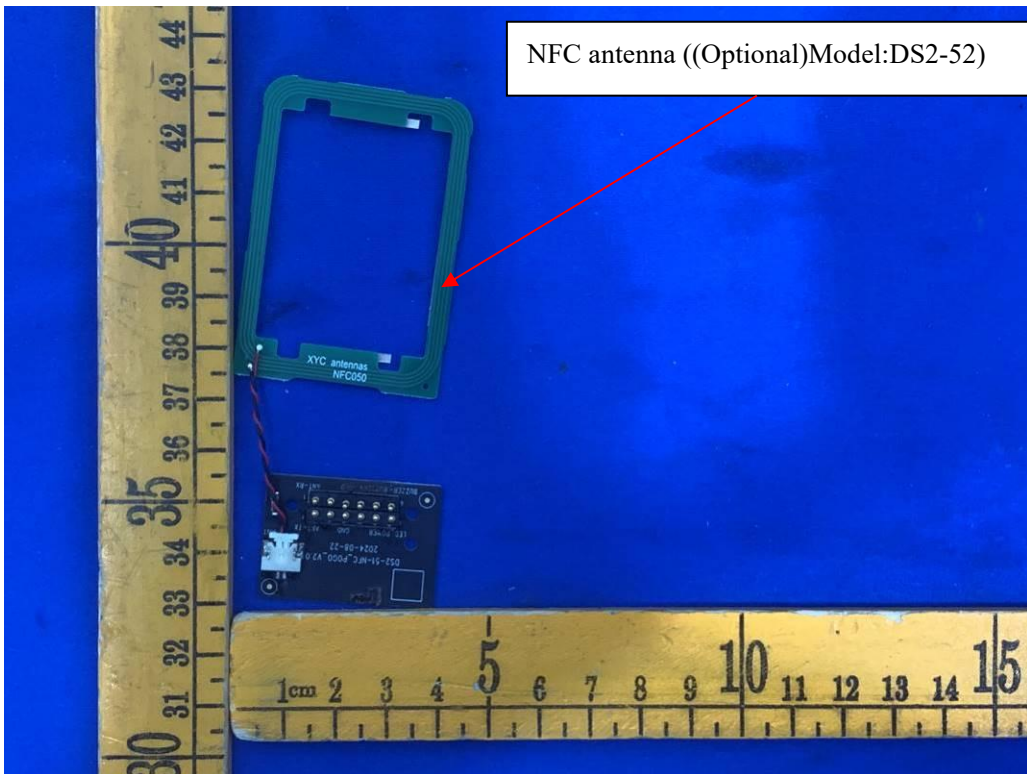

Fig. 40

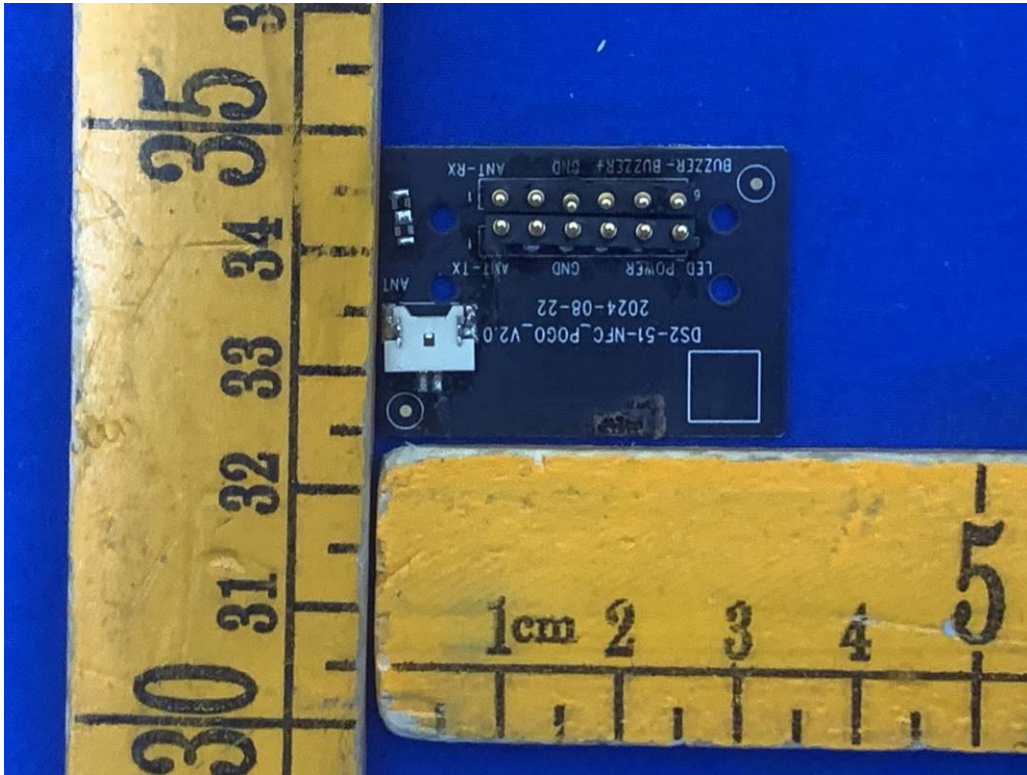

Fig. 41

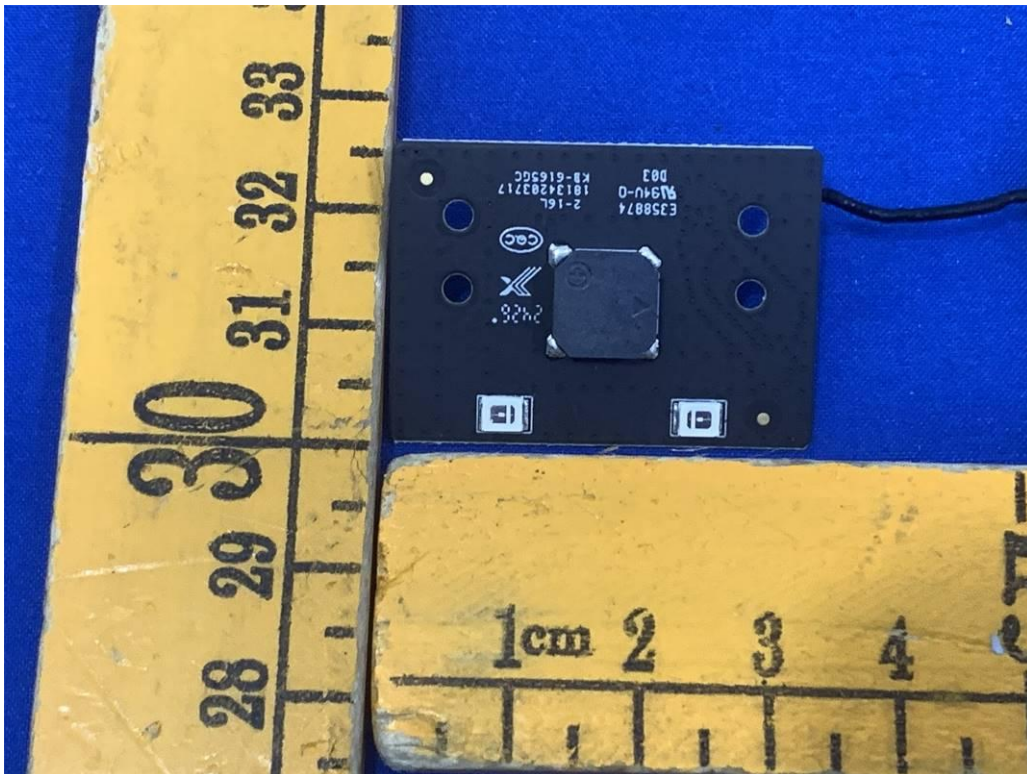

Fig. 42

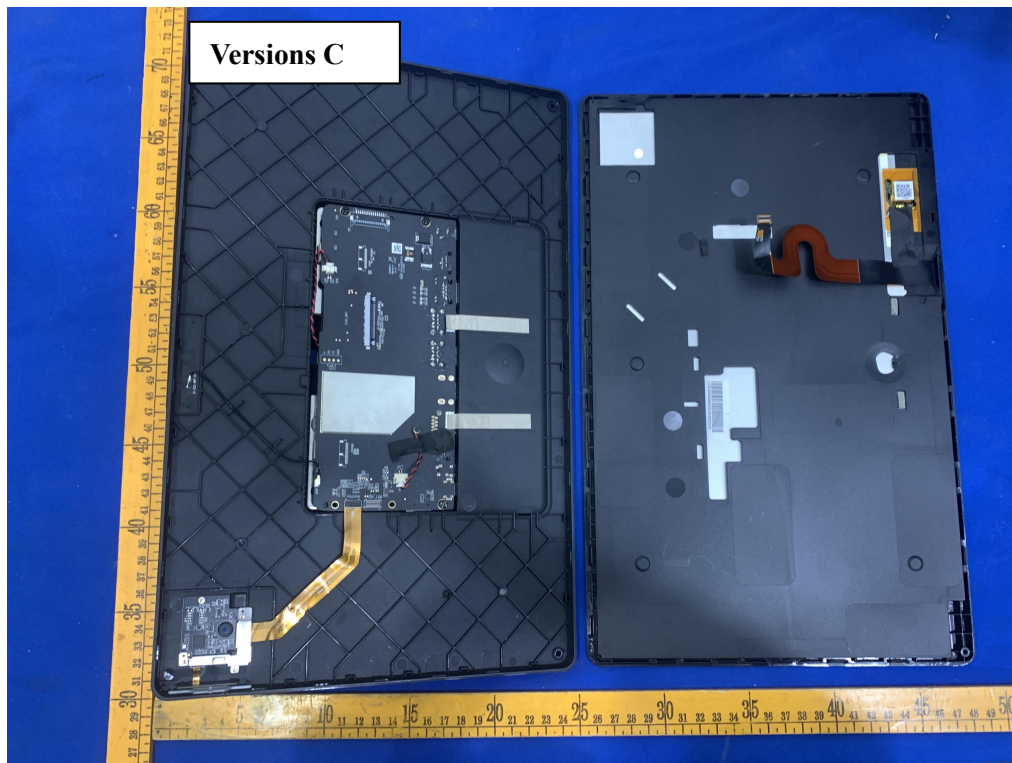

Fig. 43

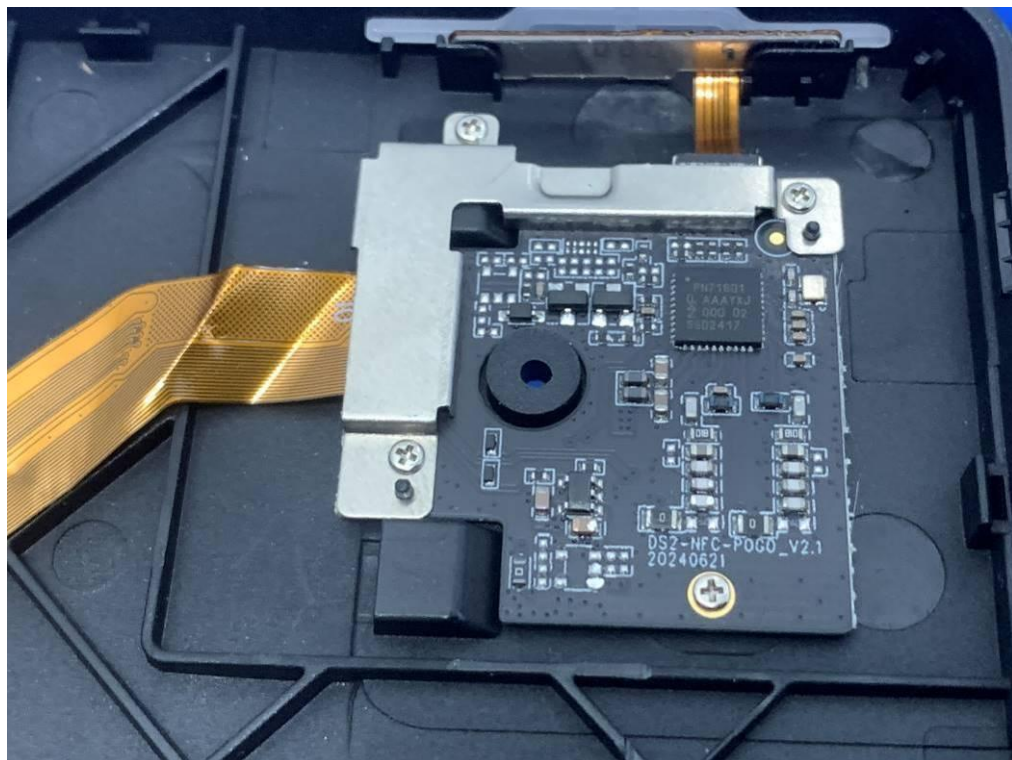

Fig. 44



Fig. 45

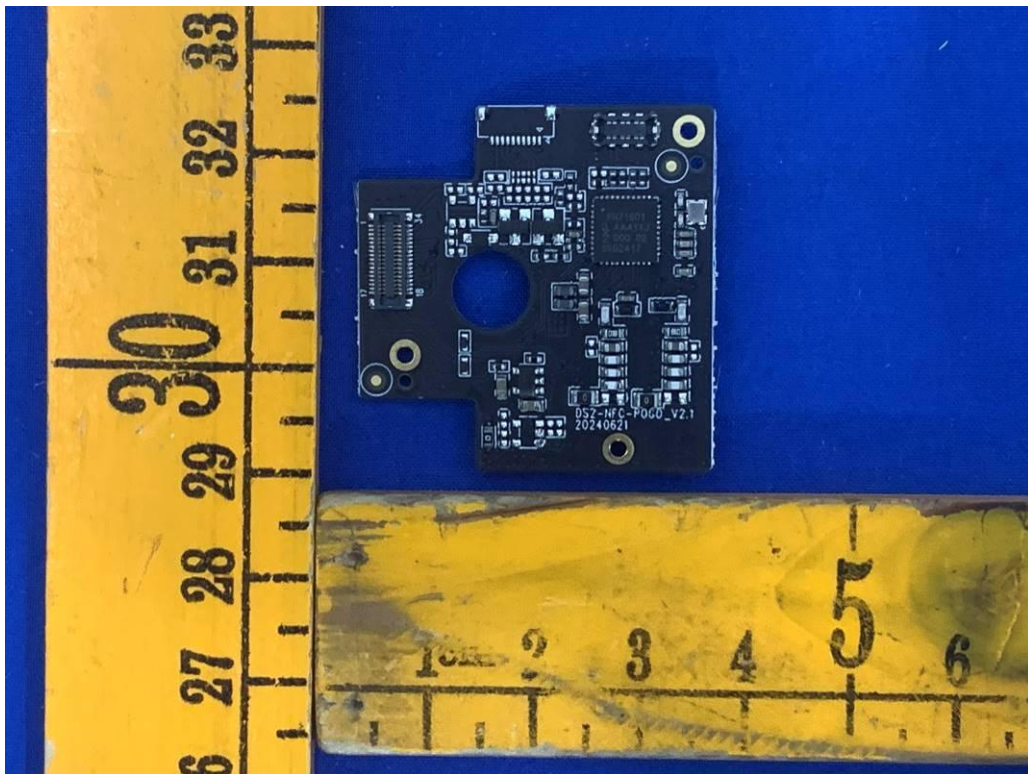

Fig. 46

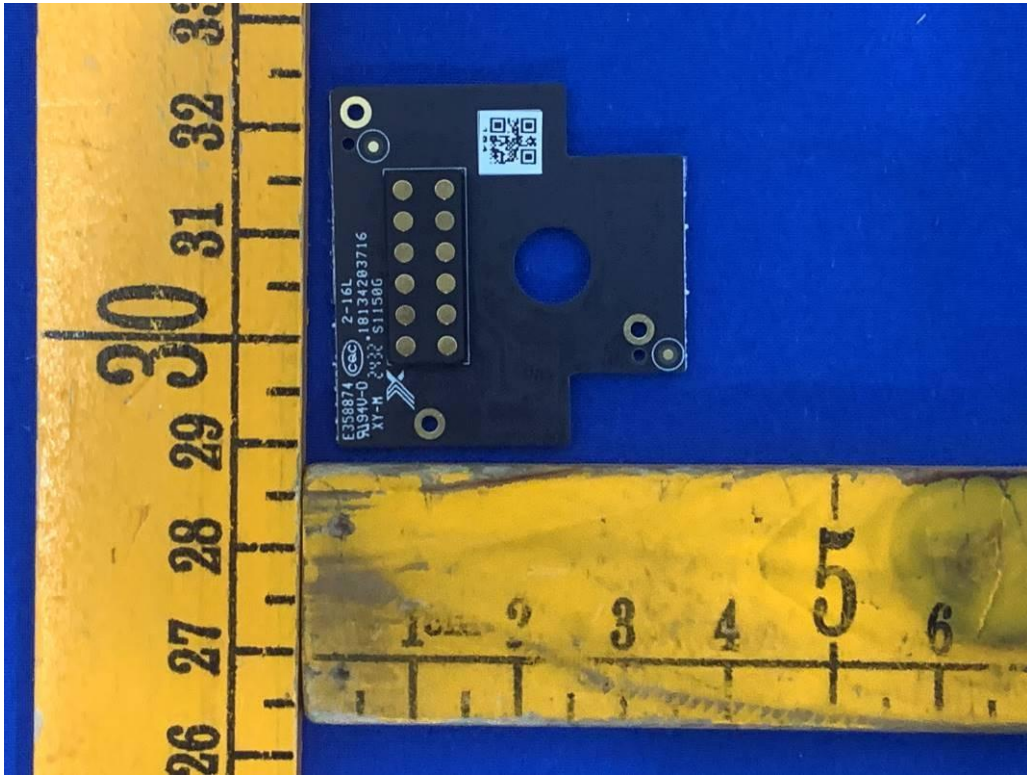

Fig. 47

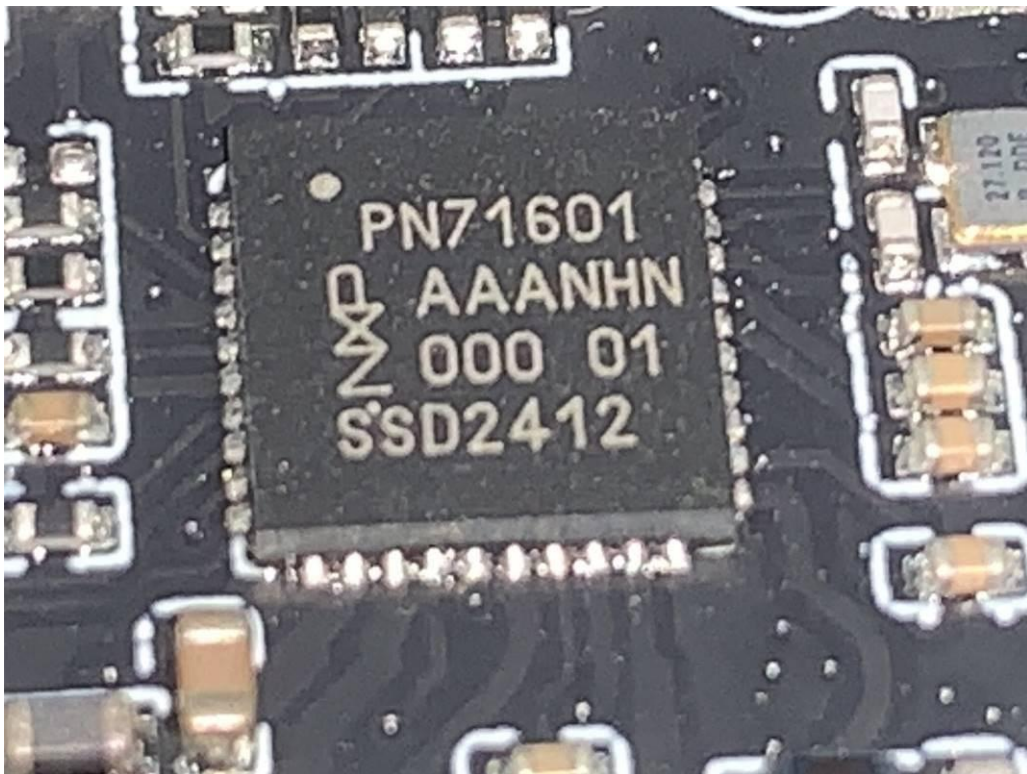

Fig. 48

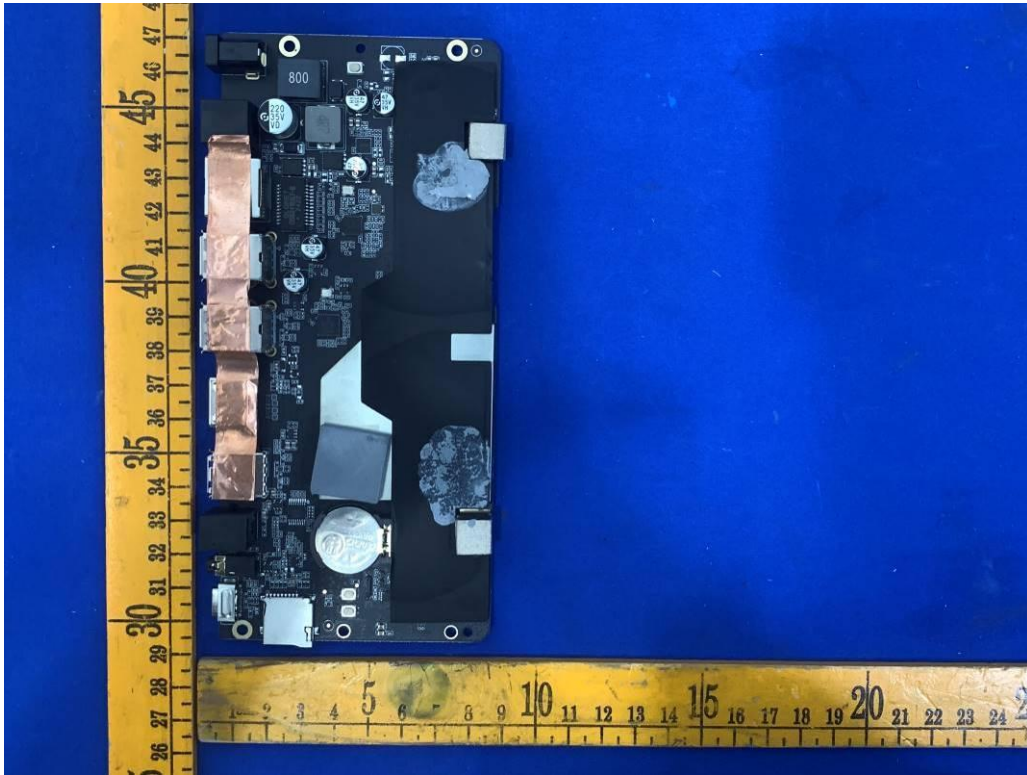

Fig. 49

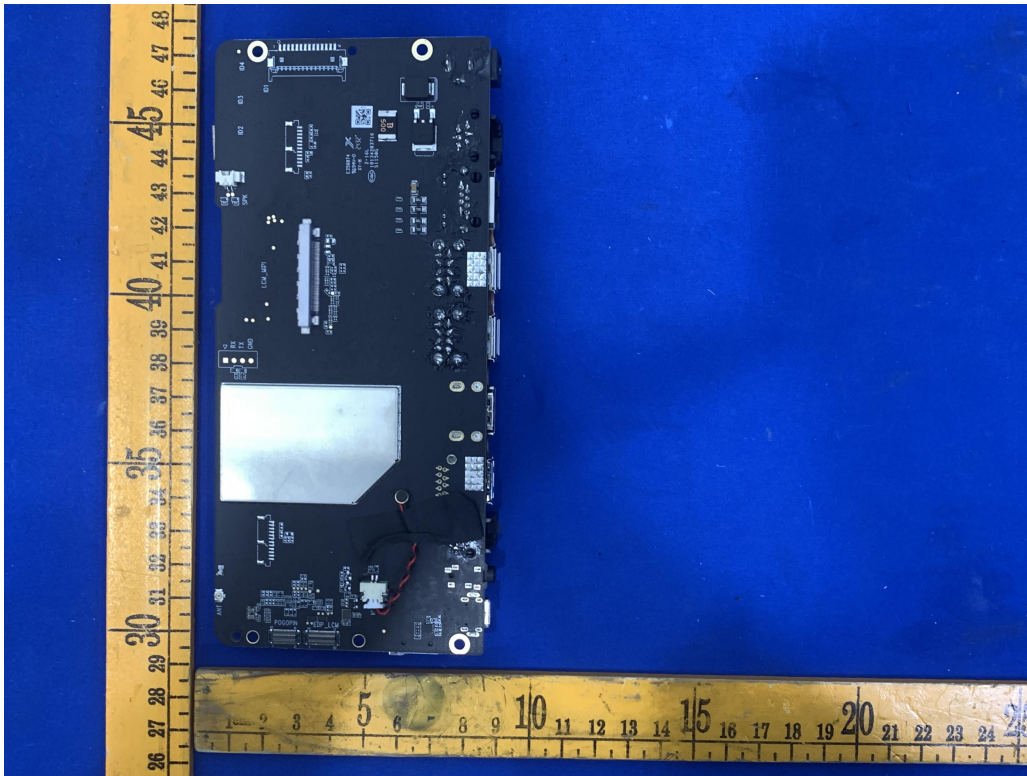

Fig. 50

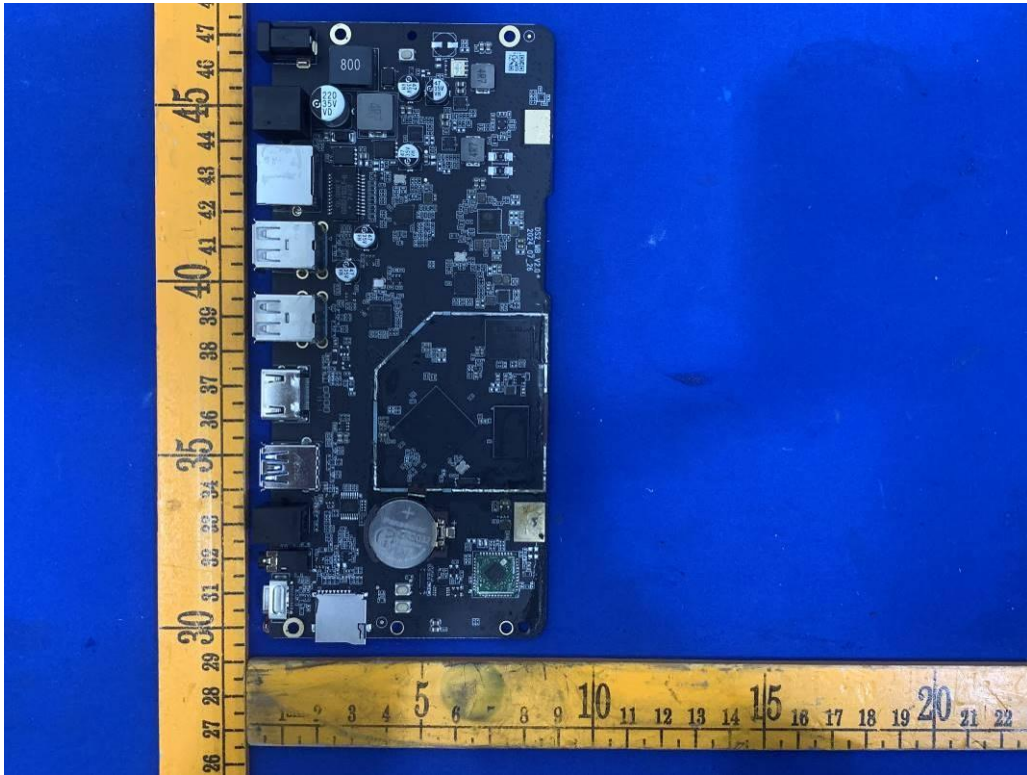

Fig. 51

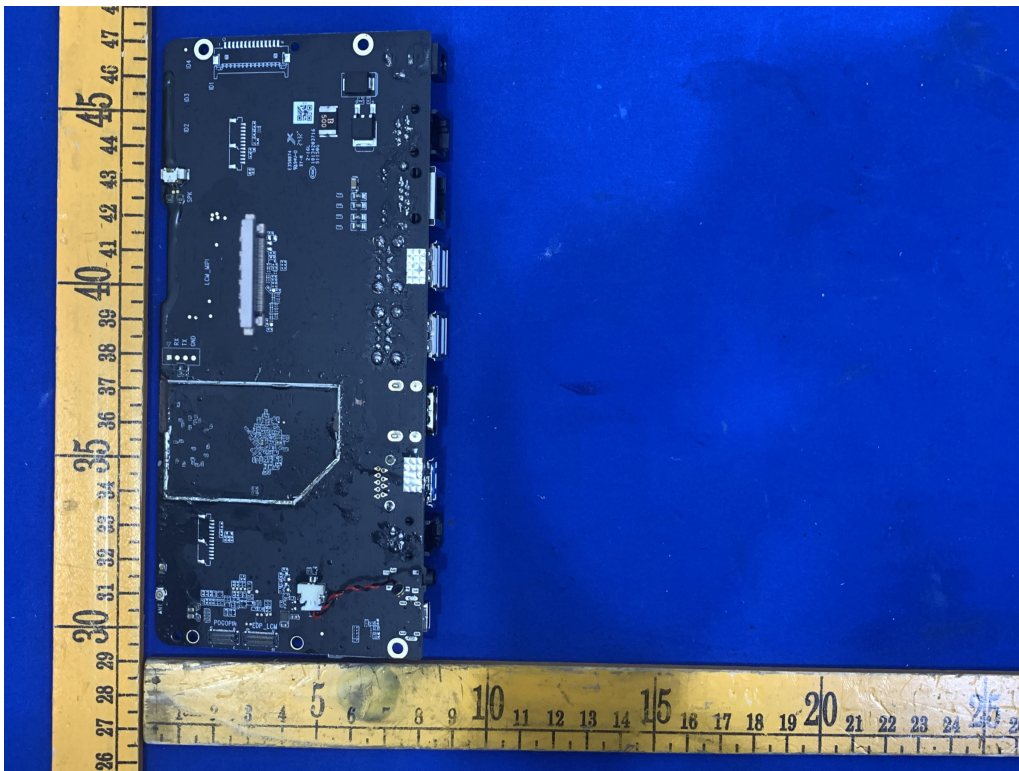

Fig. 52



Fig. 53

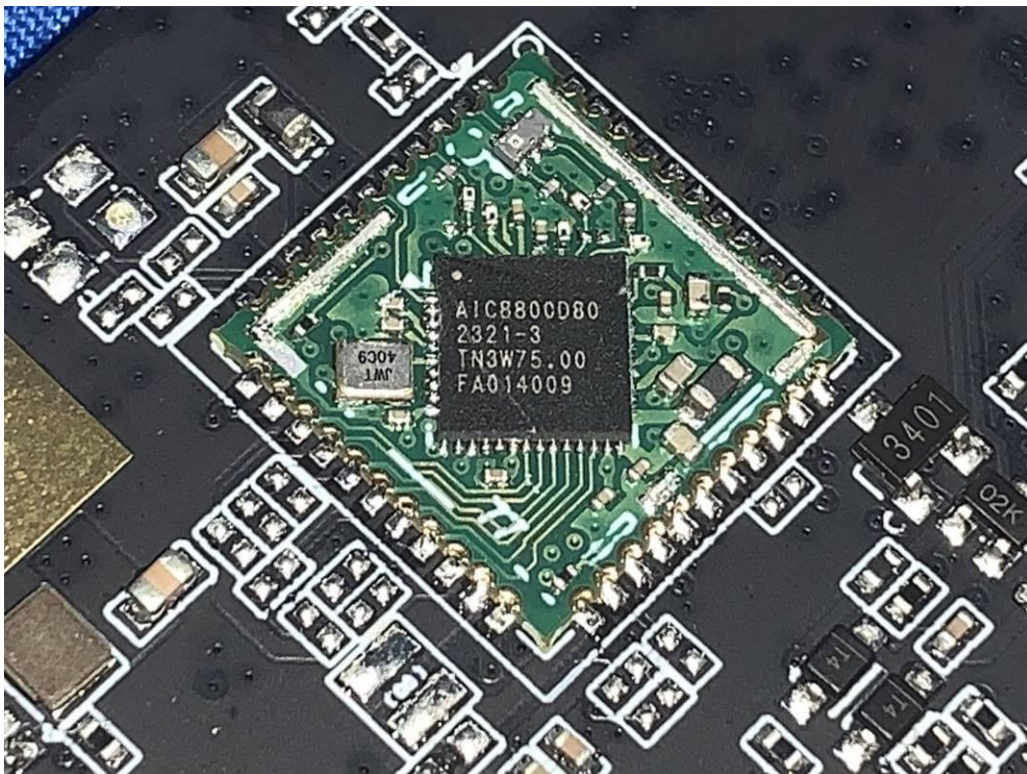

Fig. 54

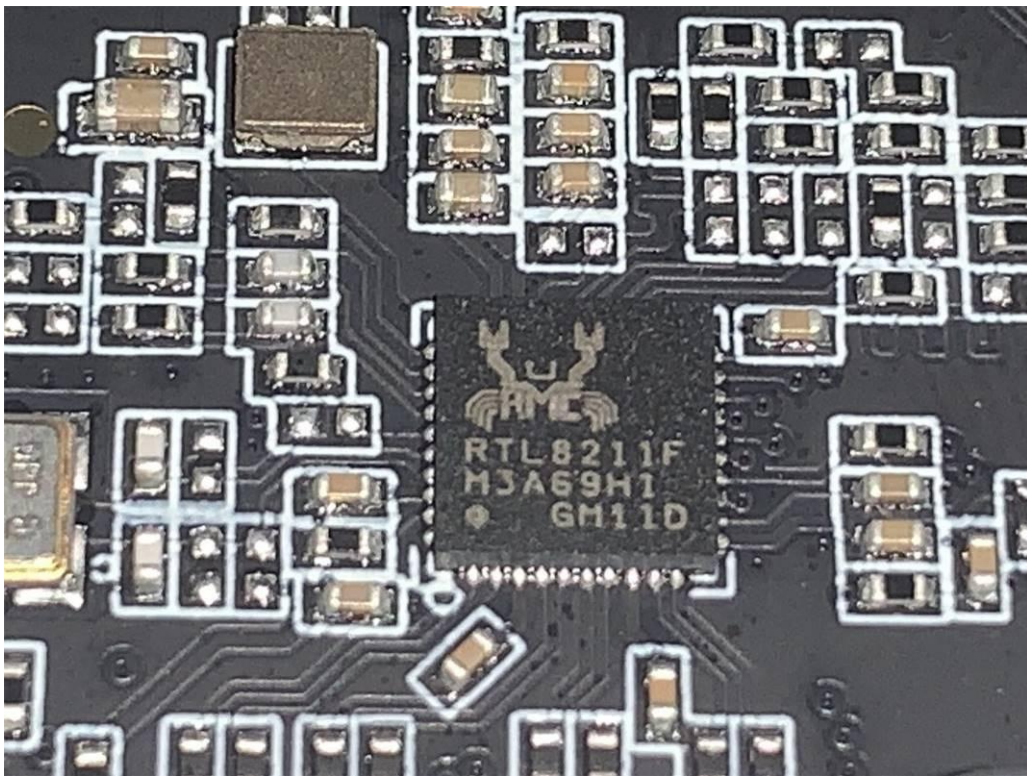

Fig. 55



Fig. 56

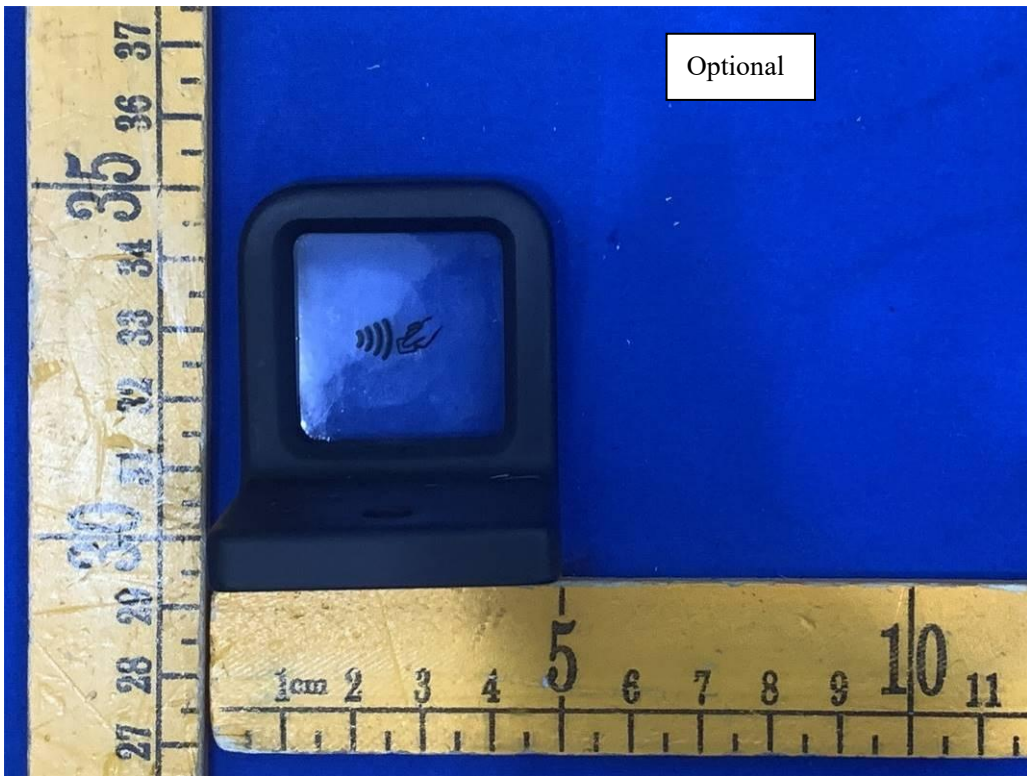

Fig. 57

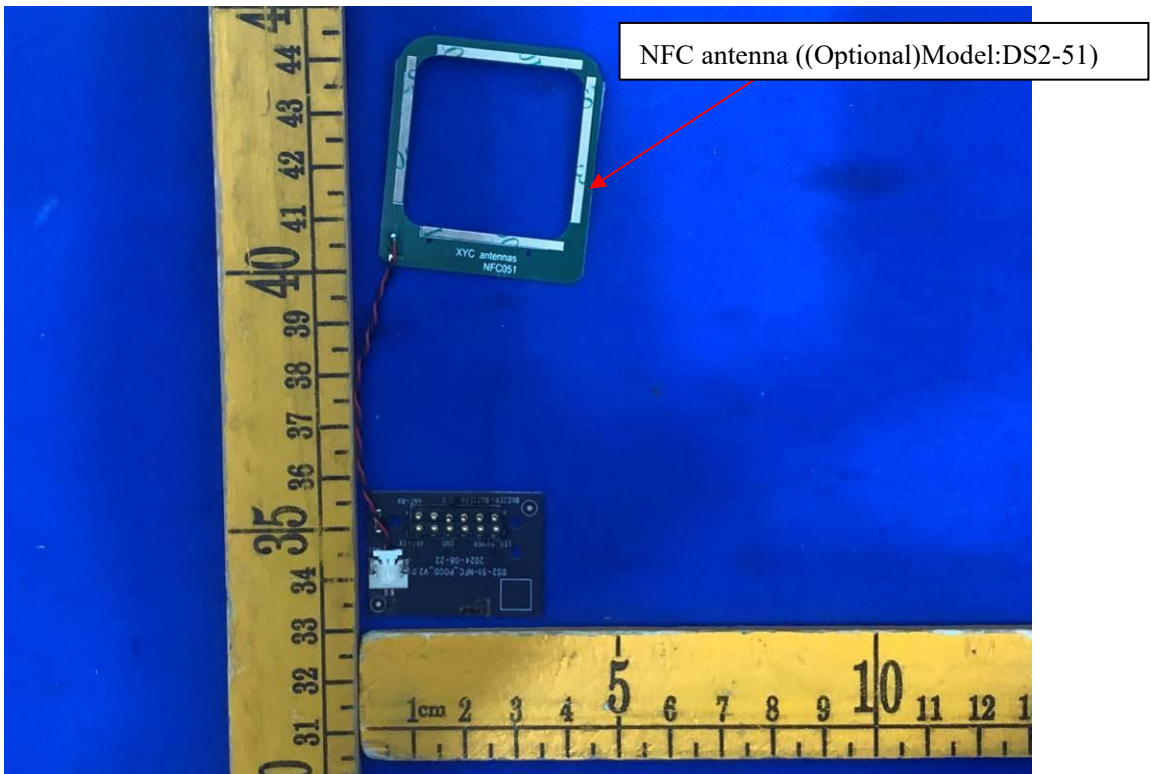

Fig. 58

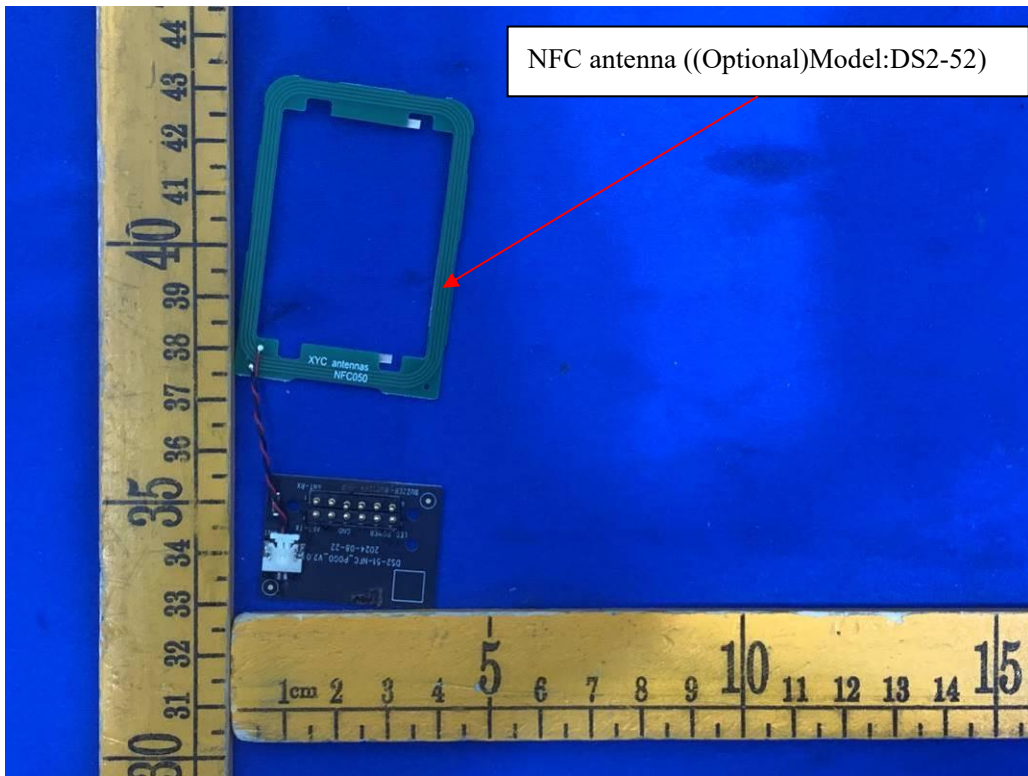

Fig. 59

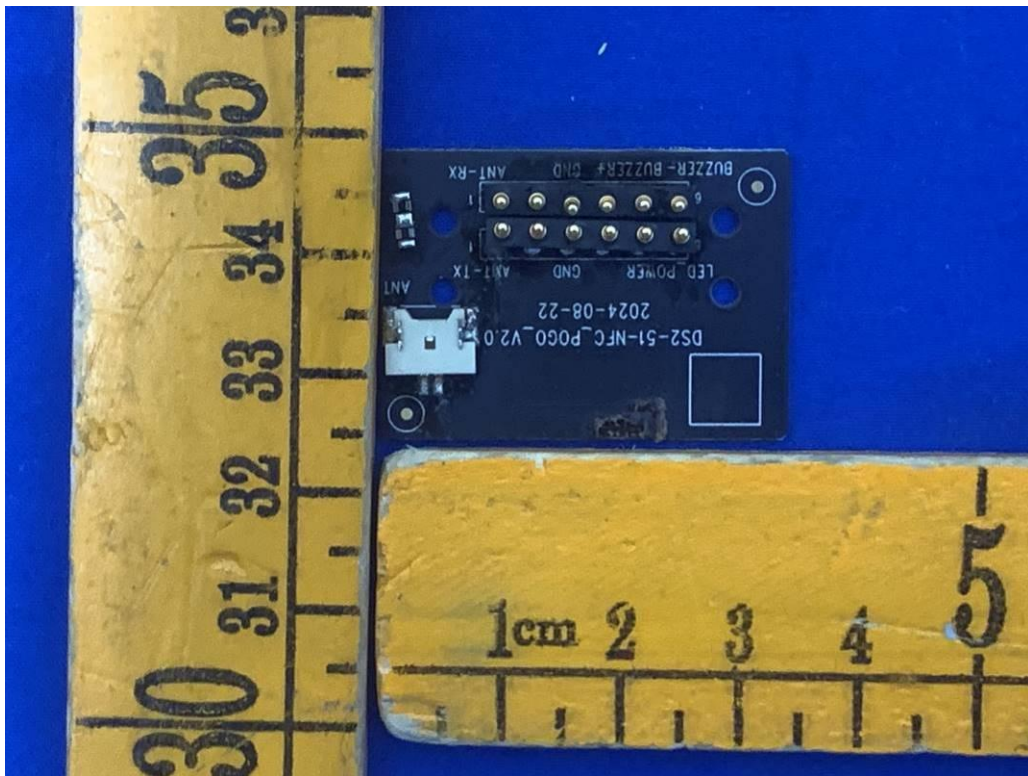

Fig. 60

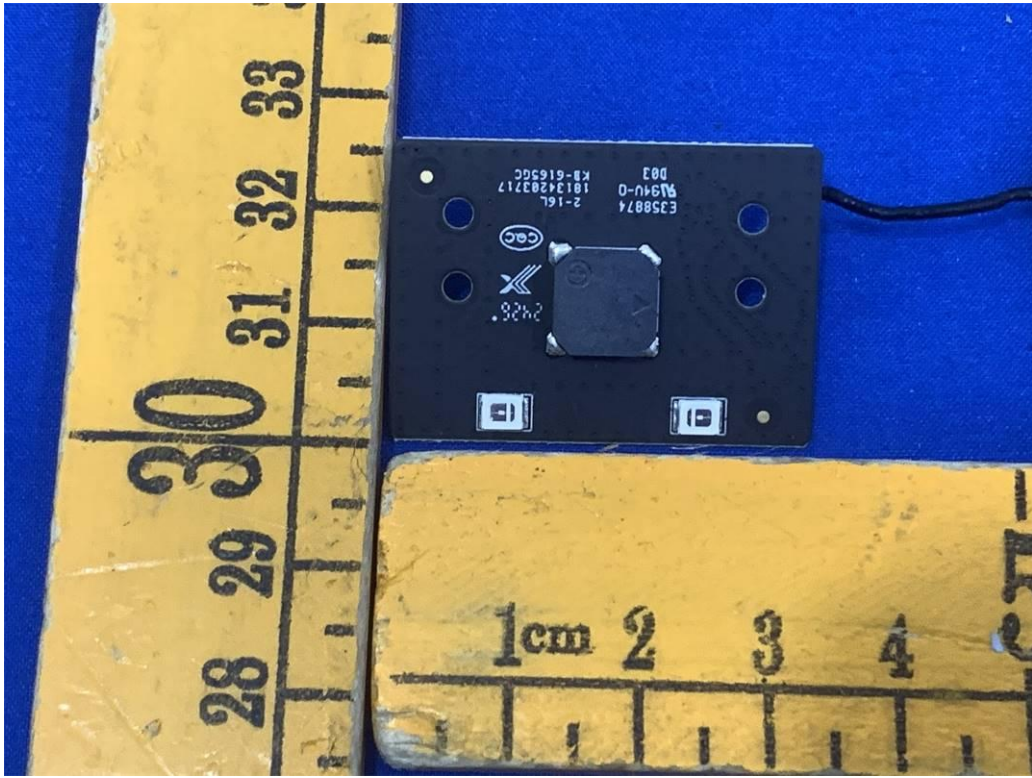

Fig. 61

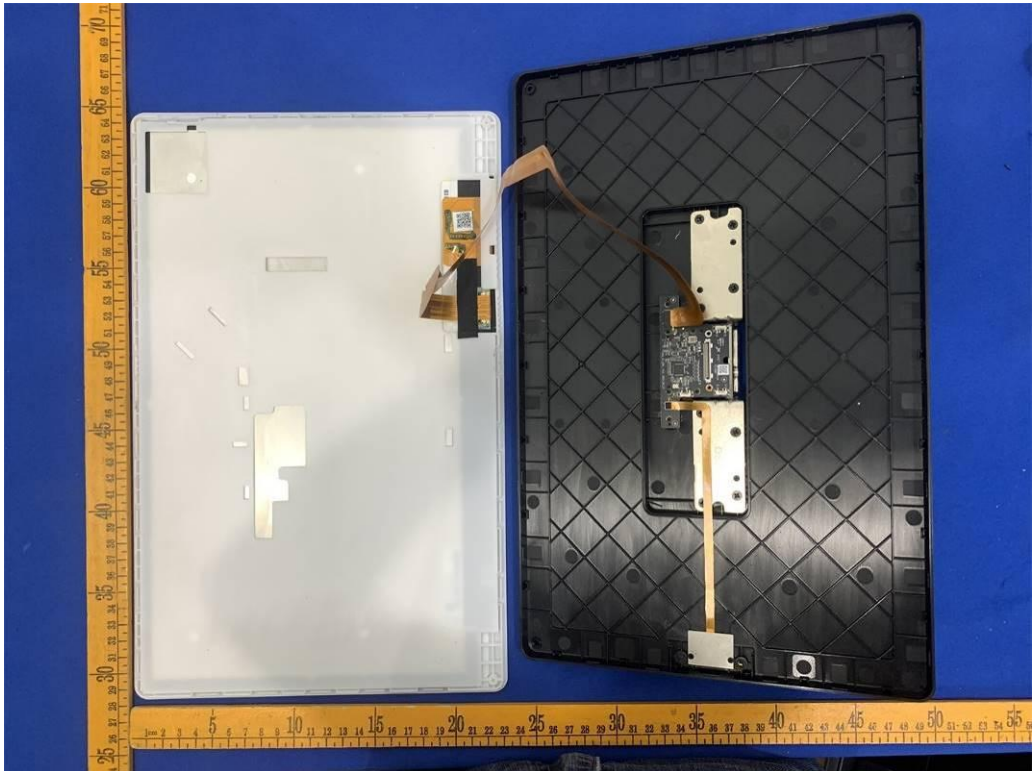

Fig. 62

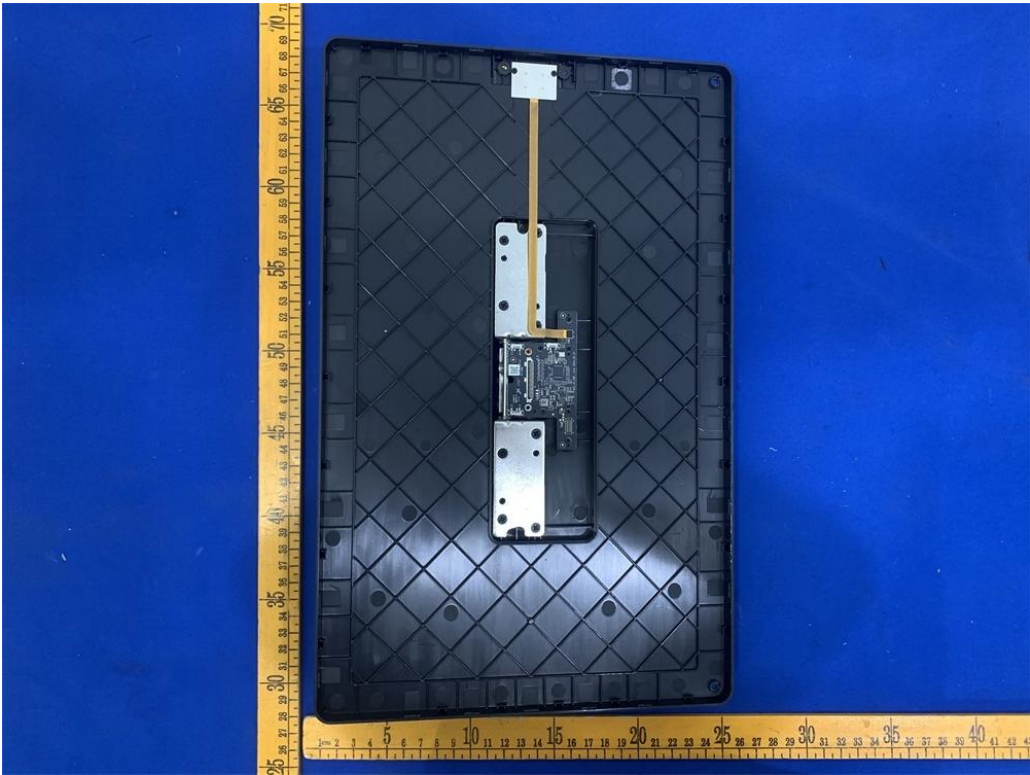

Fig. 63

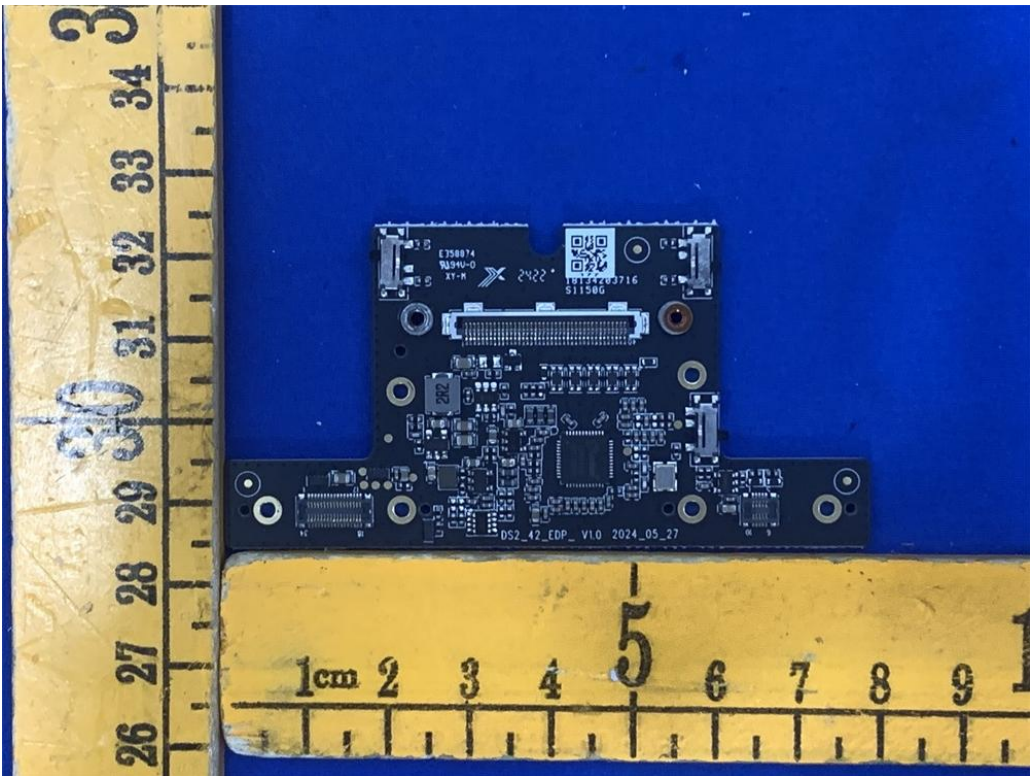

Fig. 64

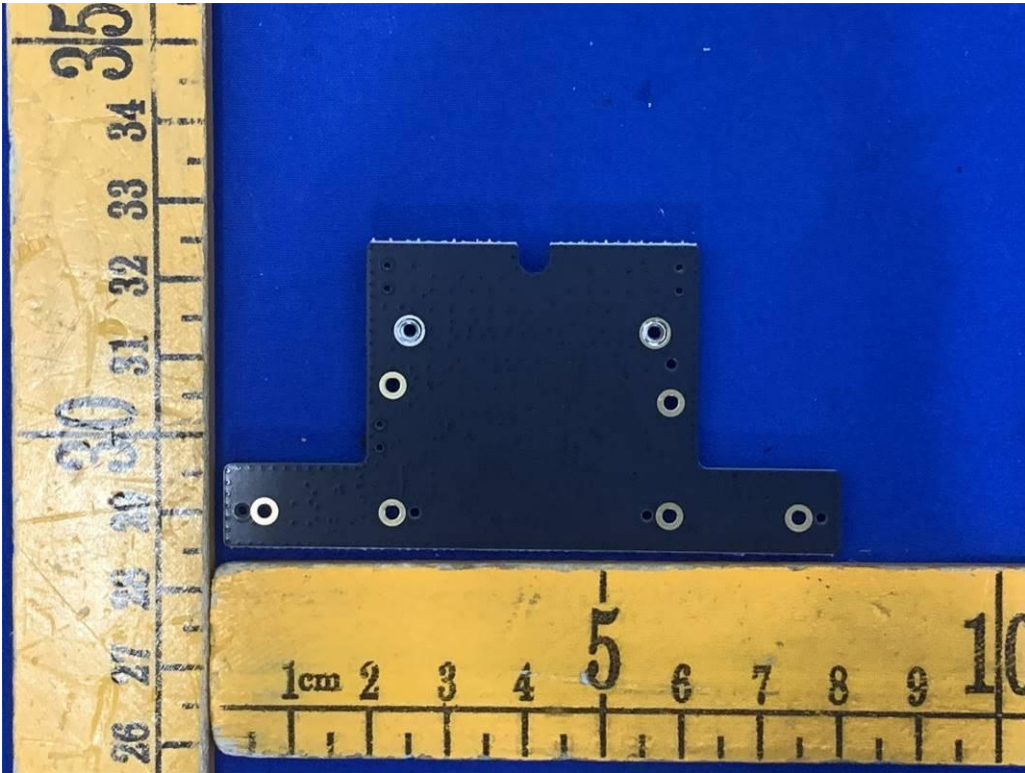

Fig. 65



Fig. 66

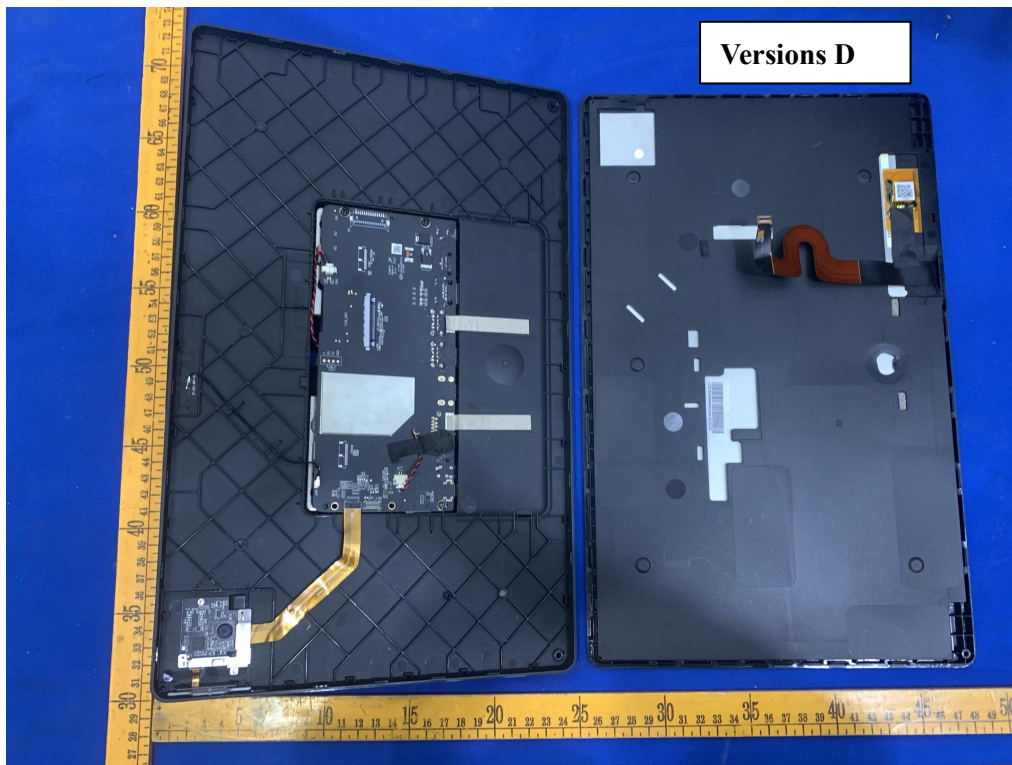

Fig. 67

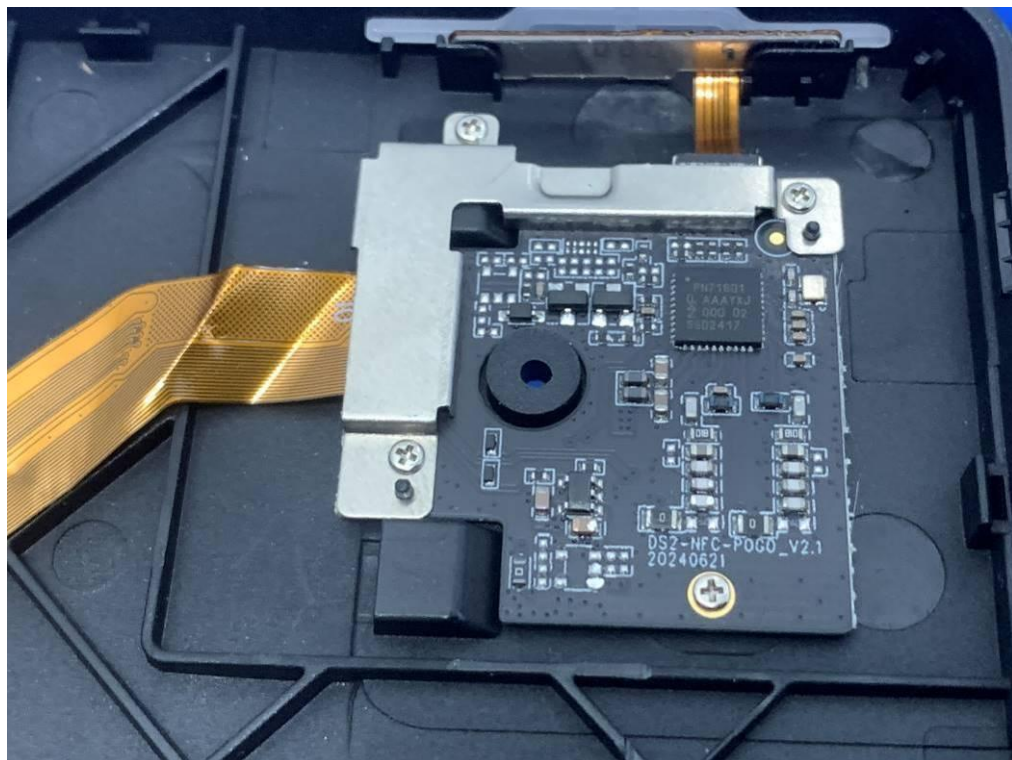

Fig. 68



Fig. 69

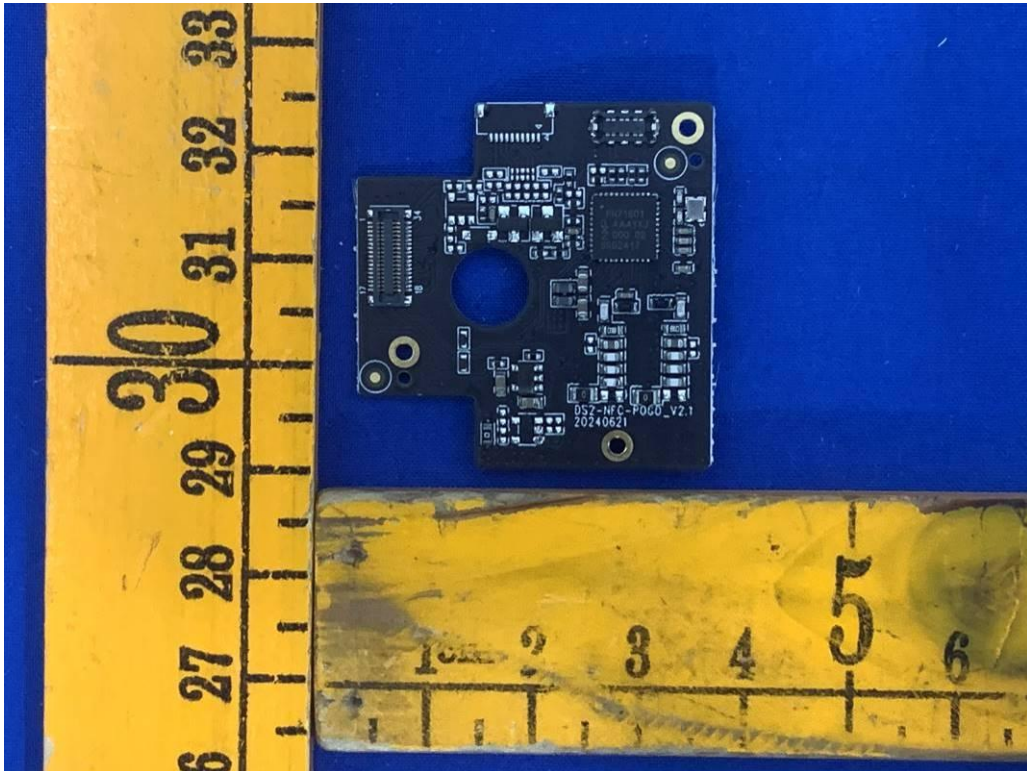

Fig. 70

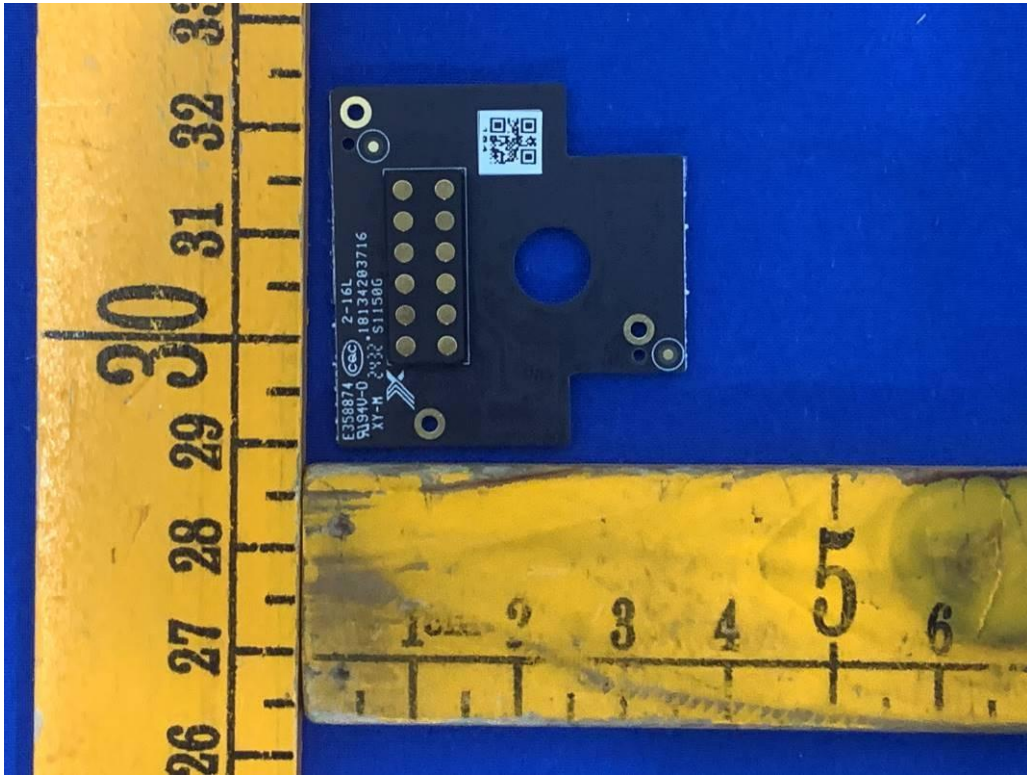

Fig. 71

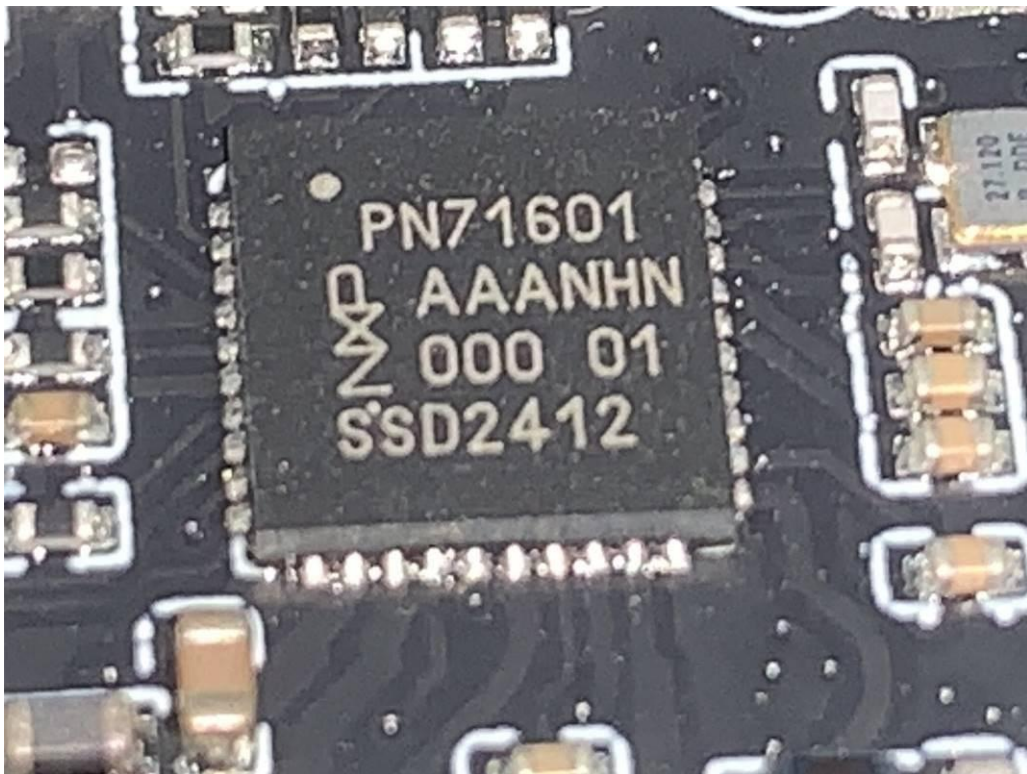

Fig. 72

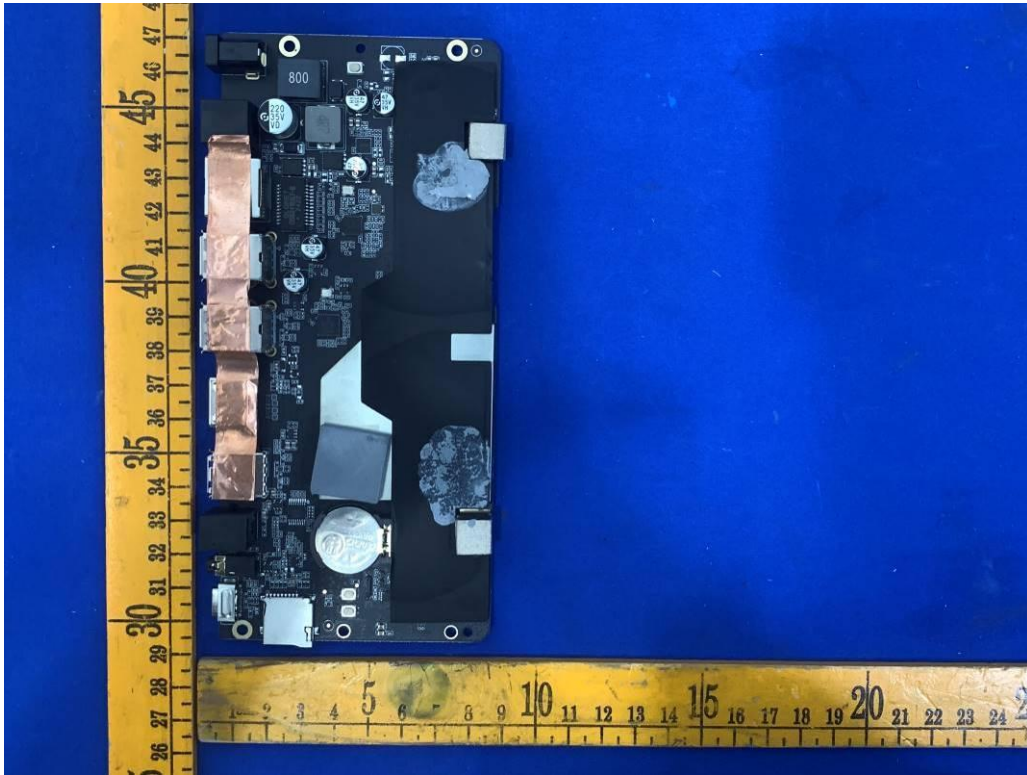

Fig. 73

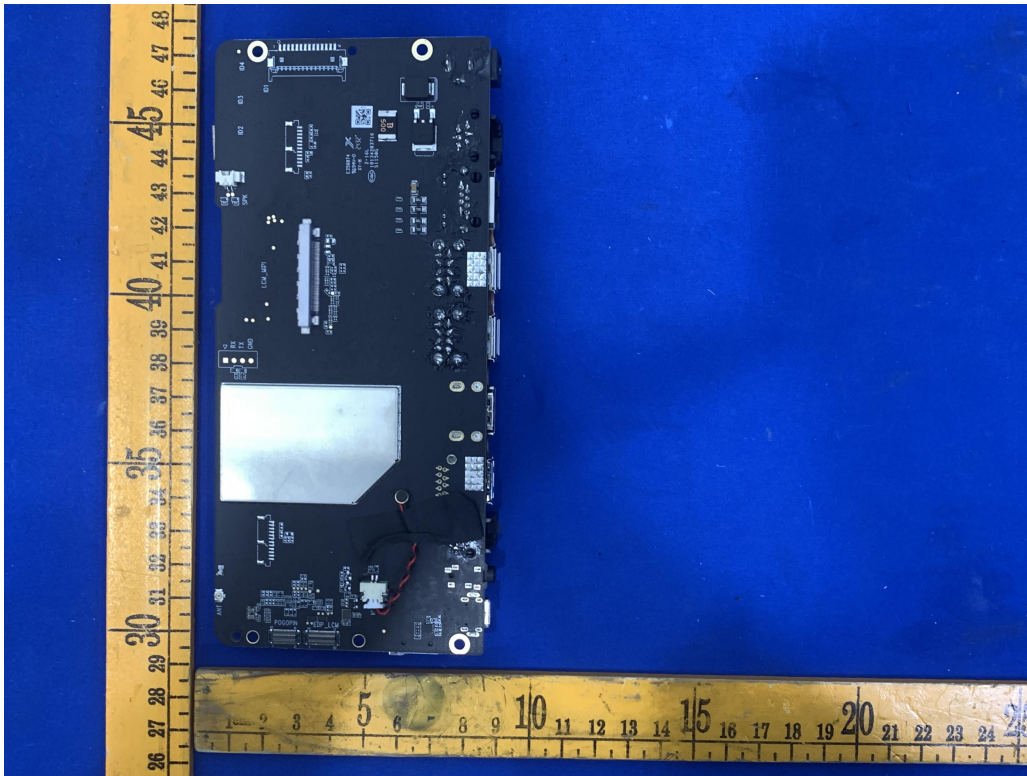

Fig. 74

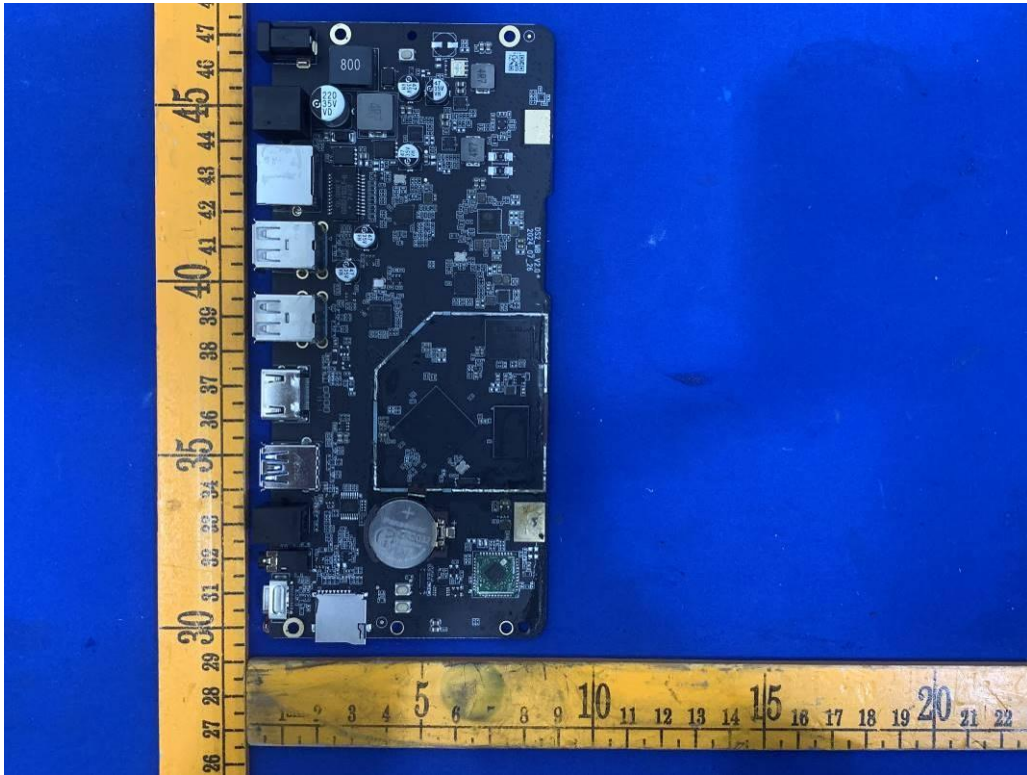

Fig. 75

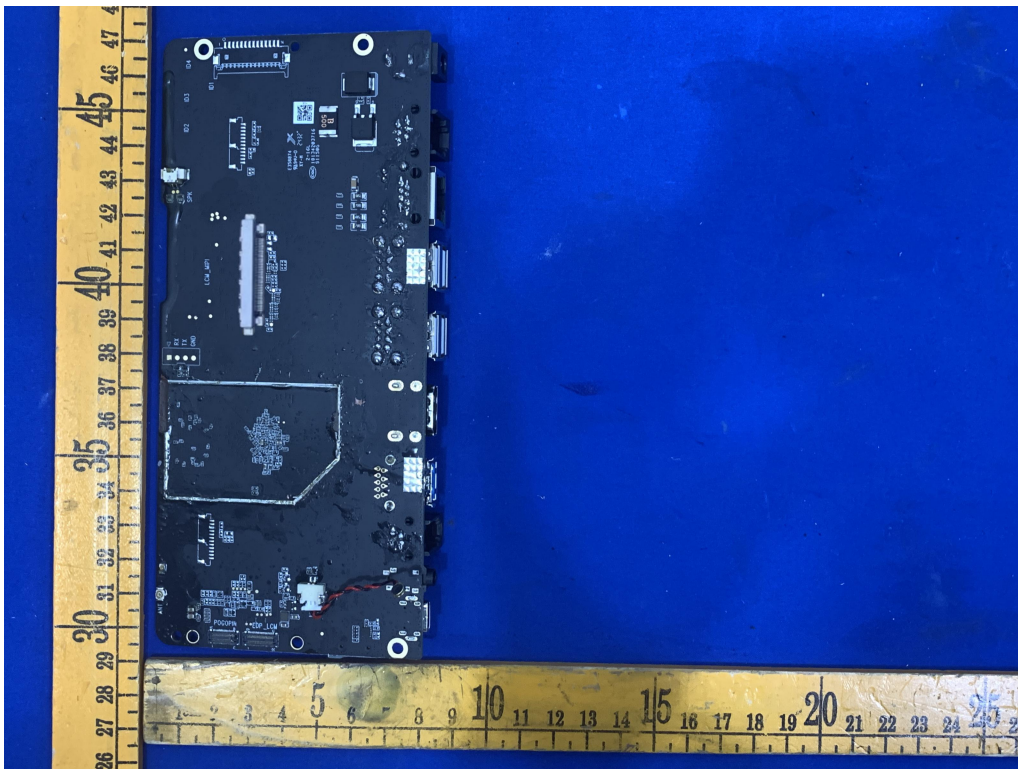

Fig. 76



Fig. 77

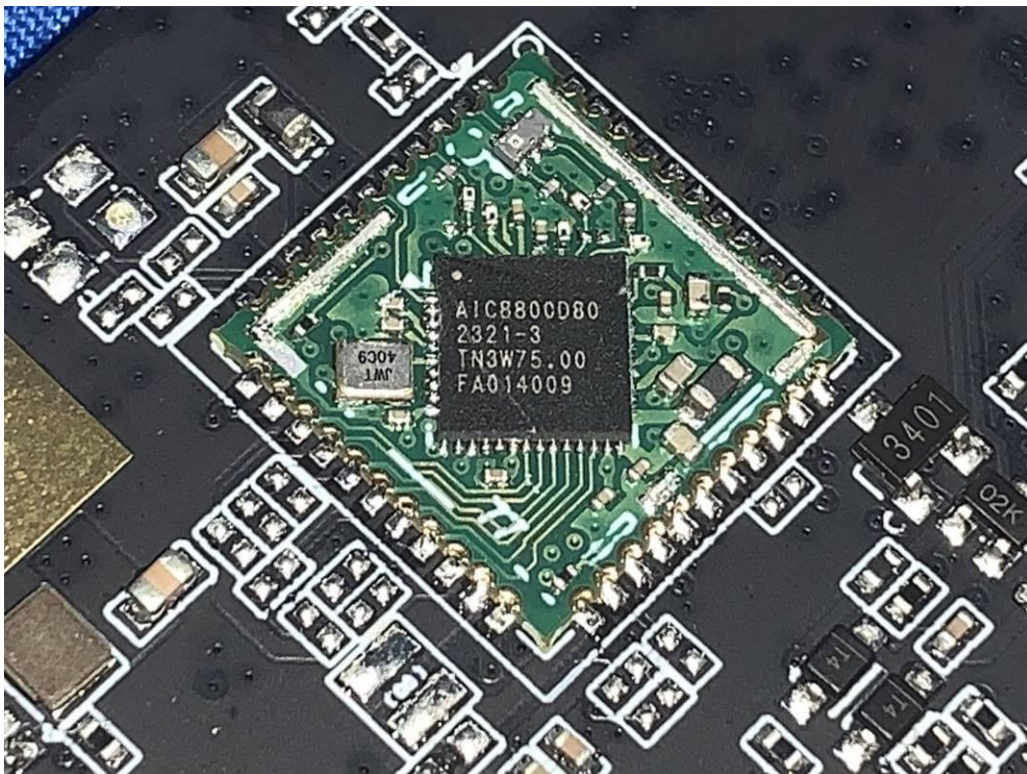

Fig. 78

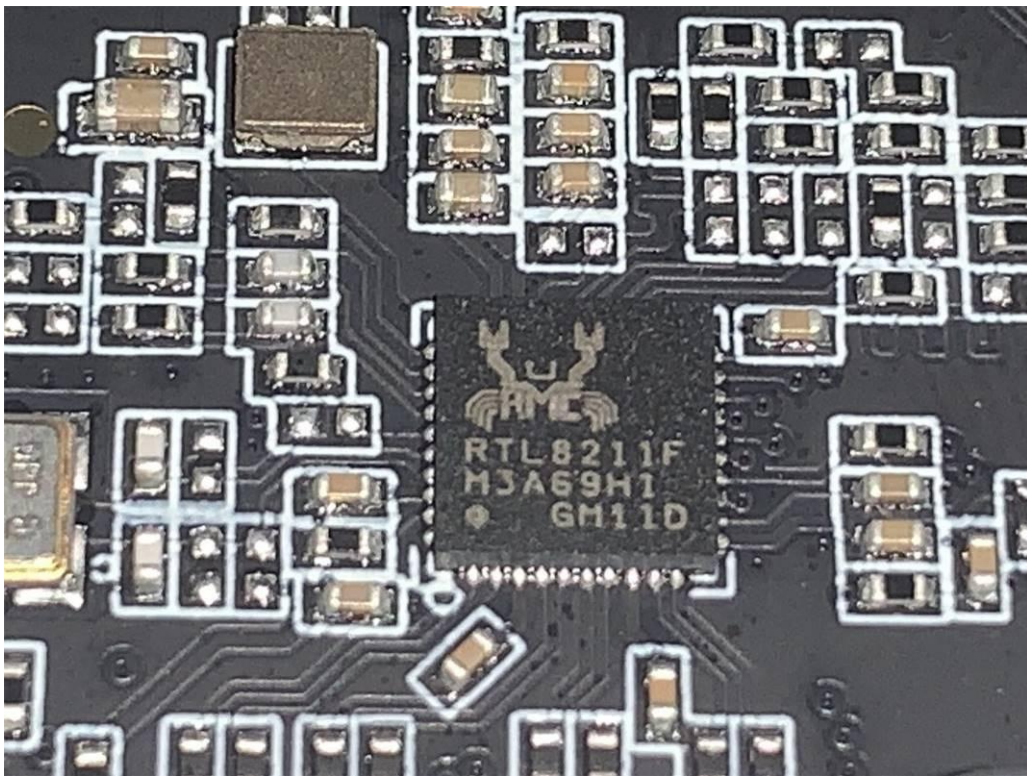

Fig. 79



Fig. 80

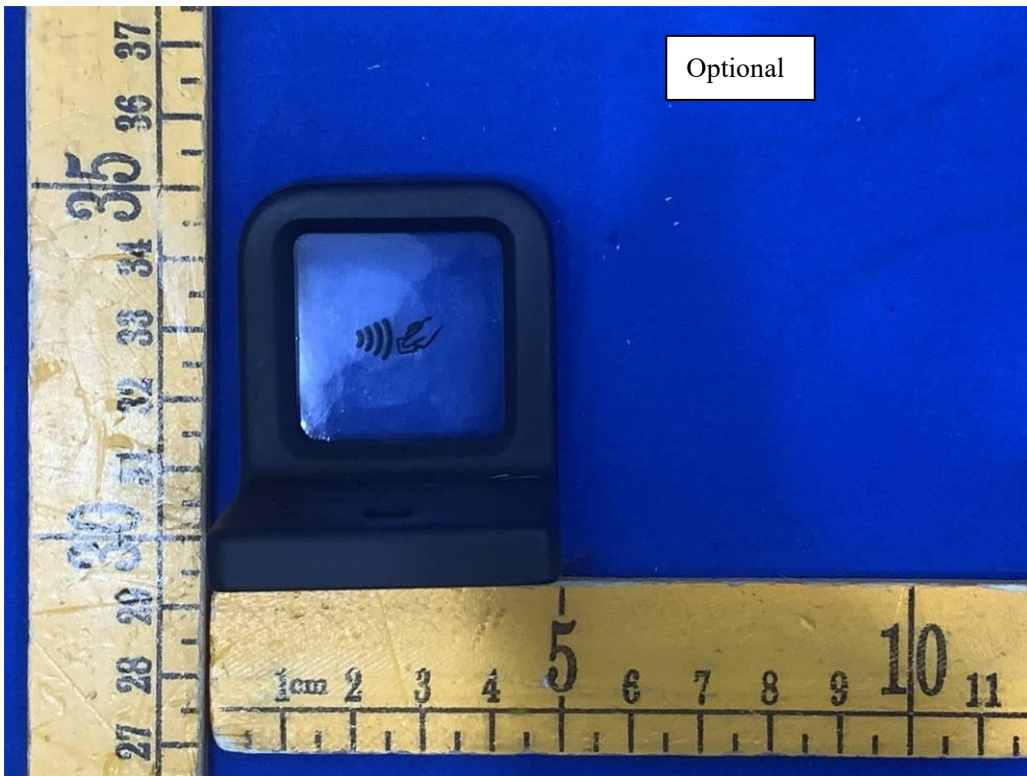

Fig. 81

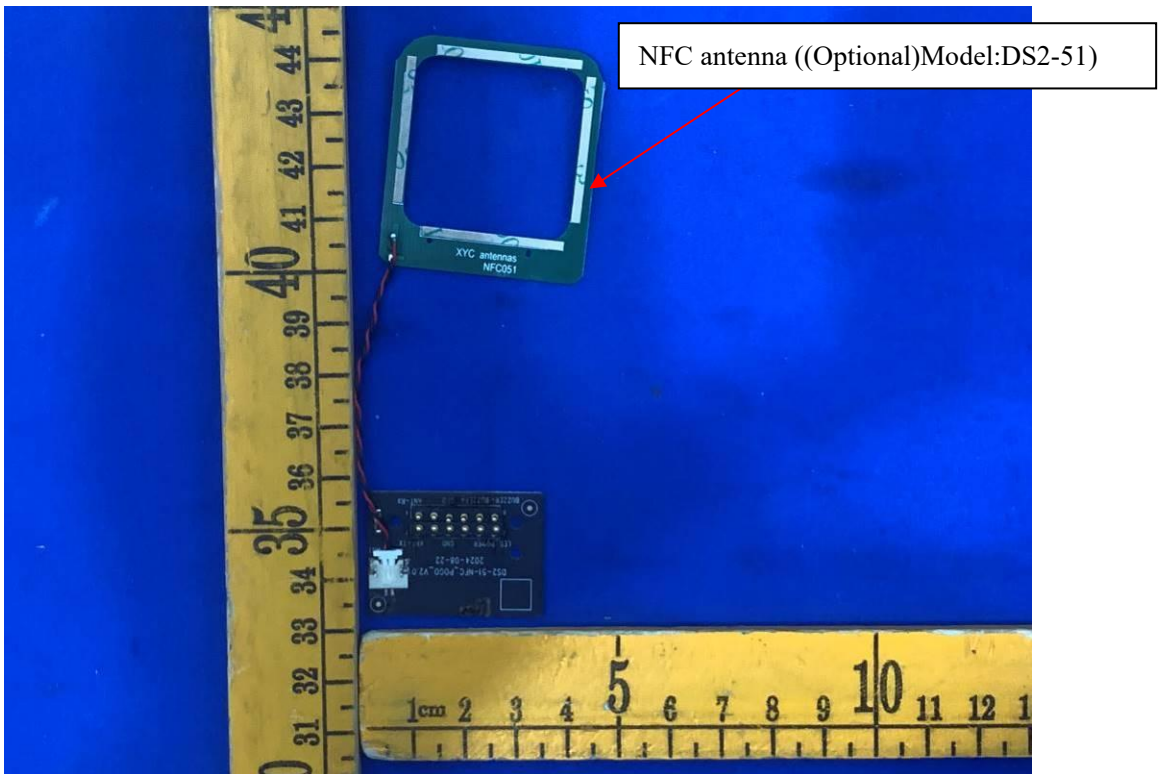

Fig. 82

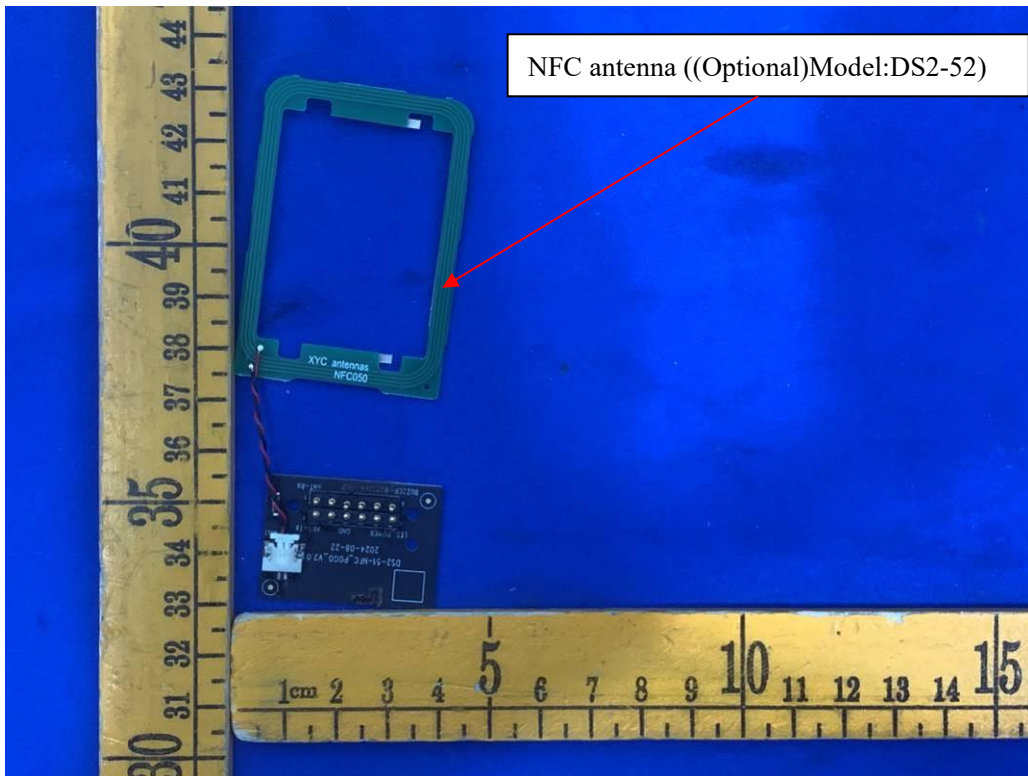

Fig. 83

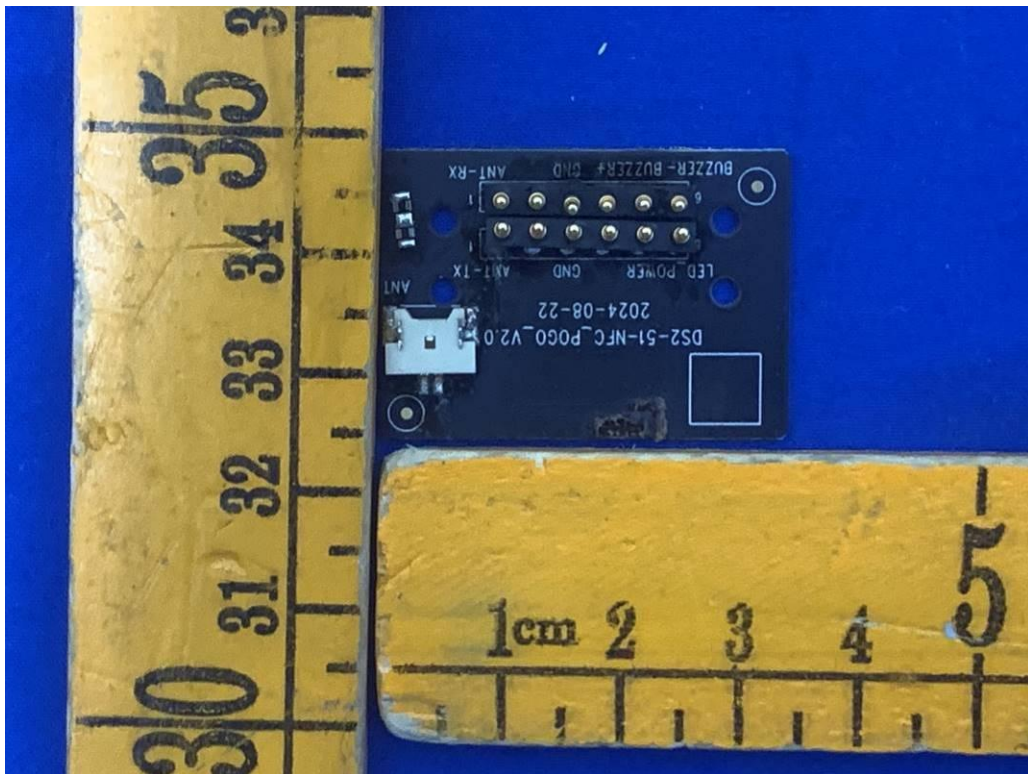

Fig. 84

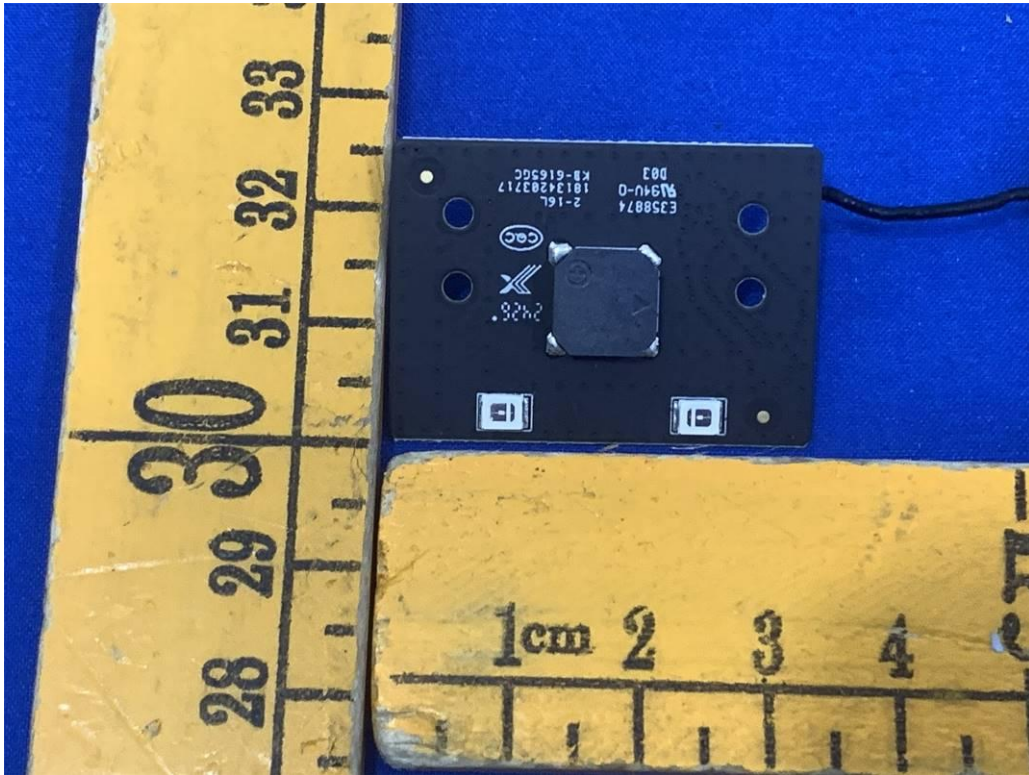

Fig. 85

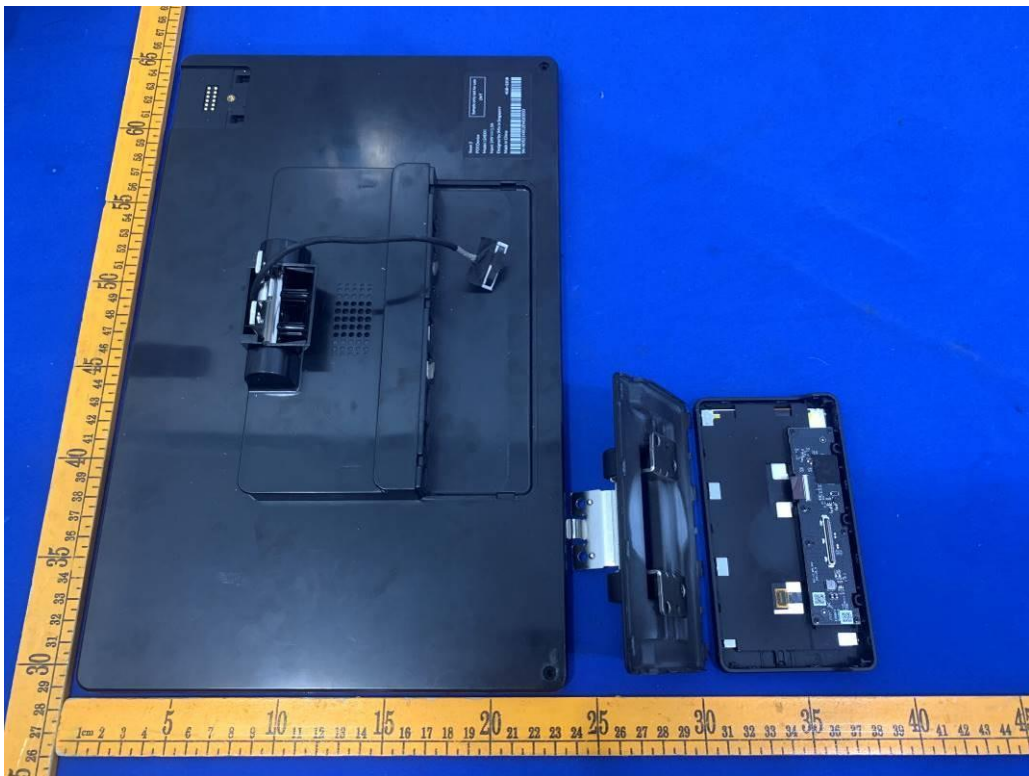

Fig. 86

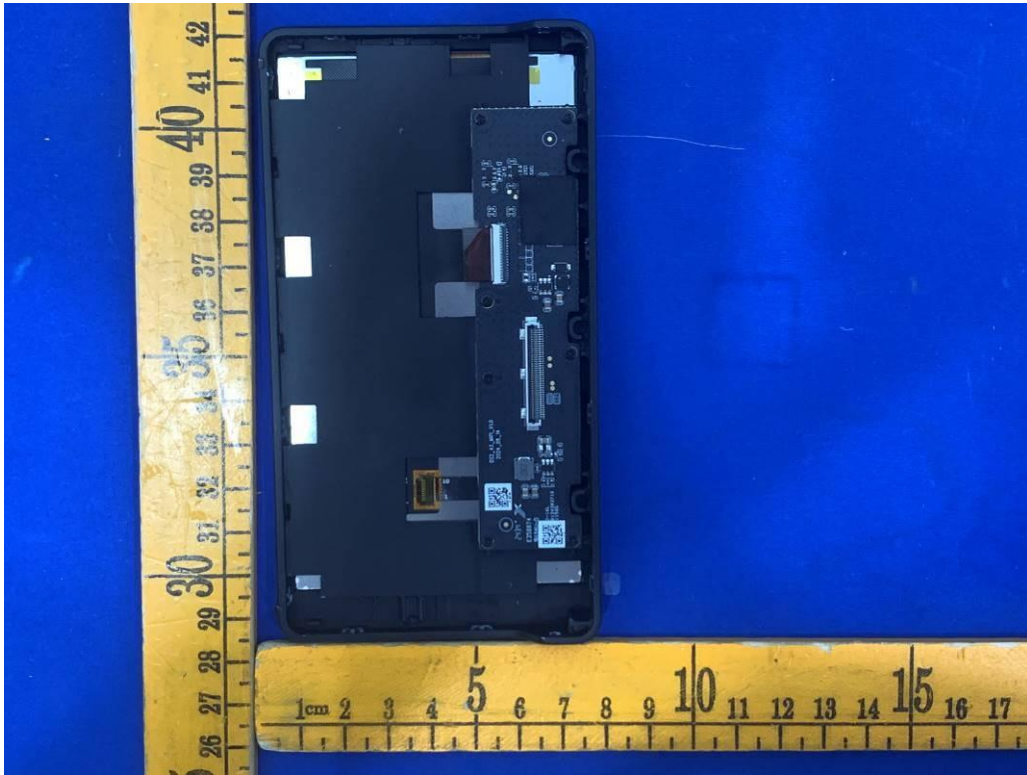

Fig. 87

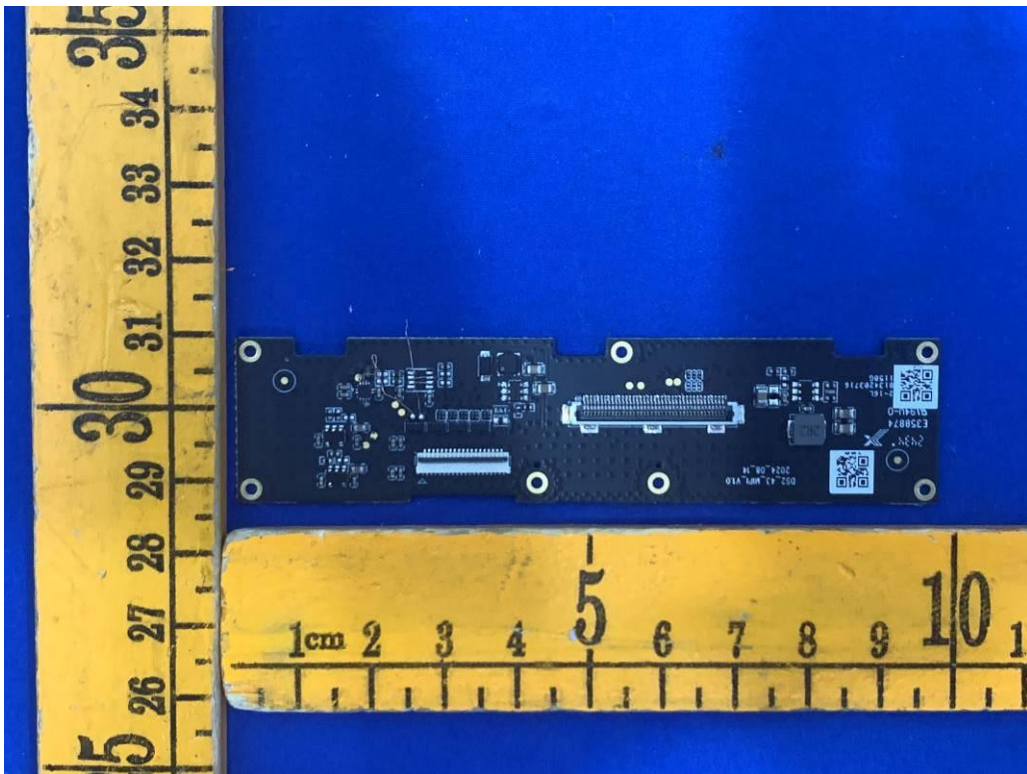

Fig. 88

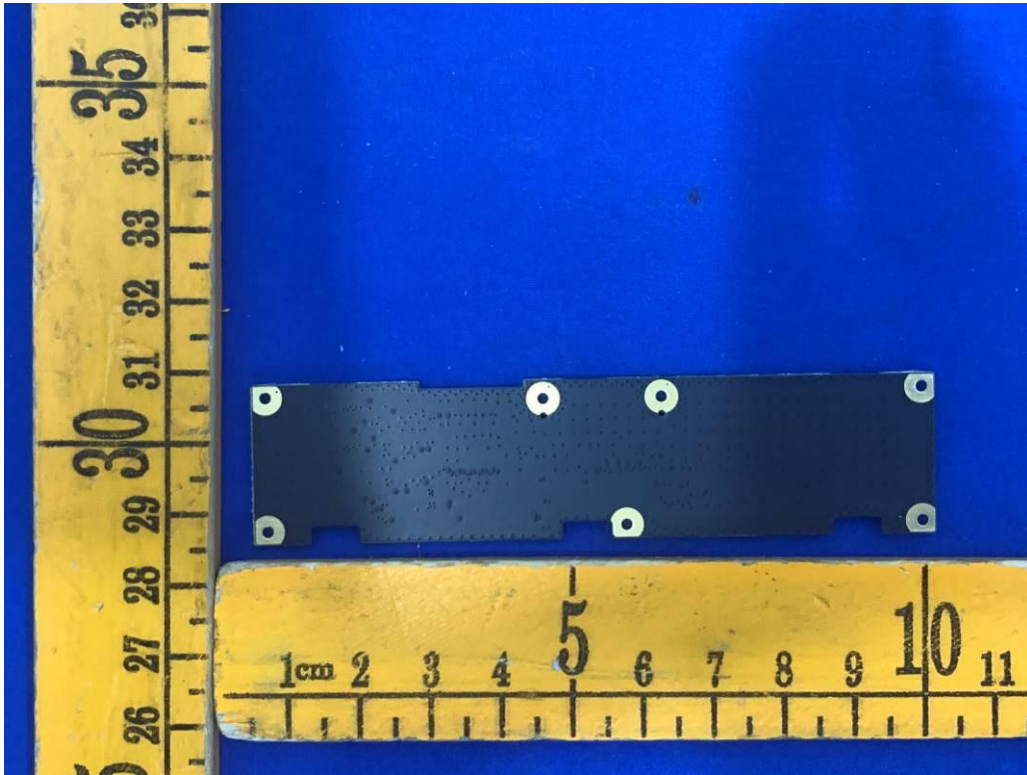

Fig. 89