

6.1. Internal photos of the EUT



Fig. 30

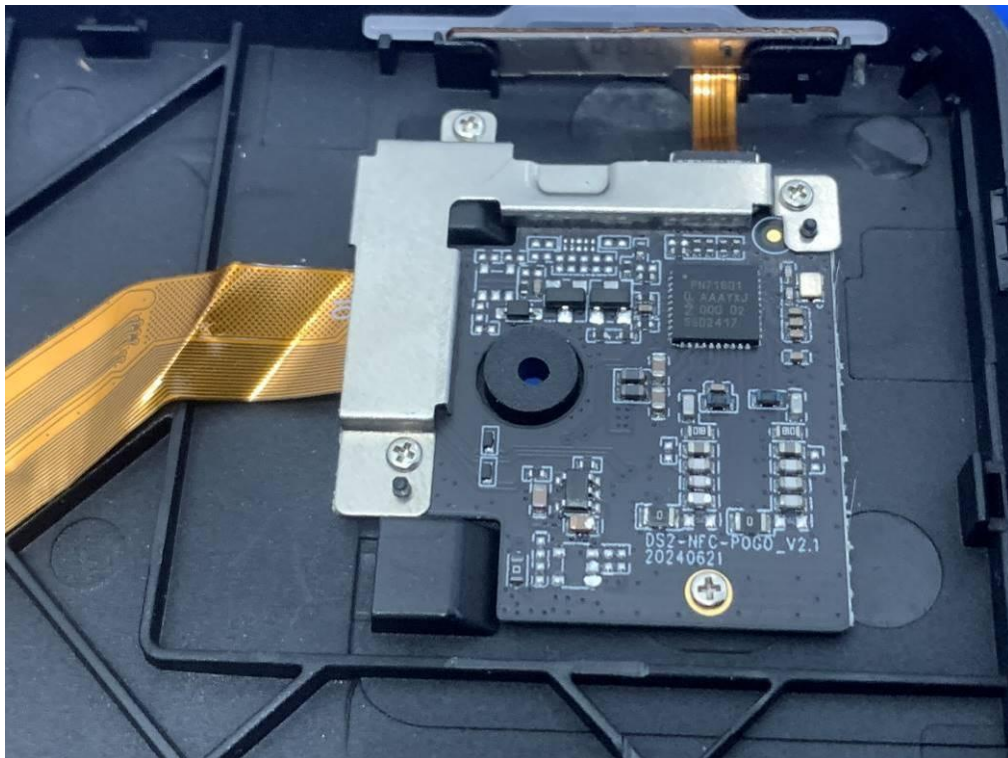

Fig. 31



Fig. 32

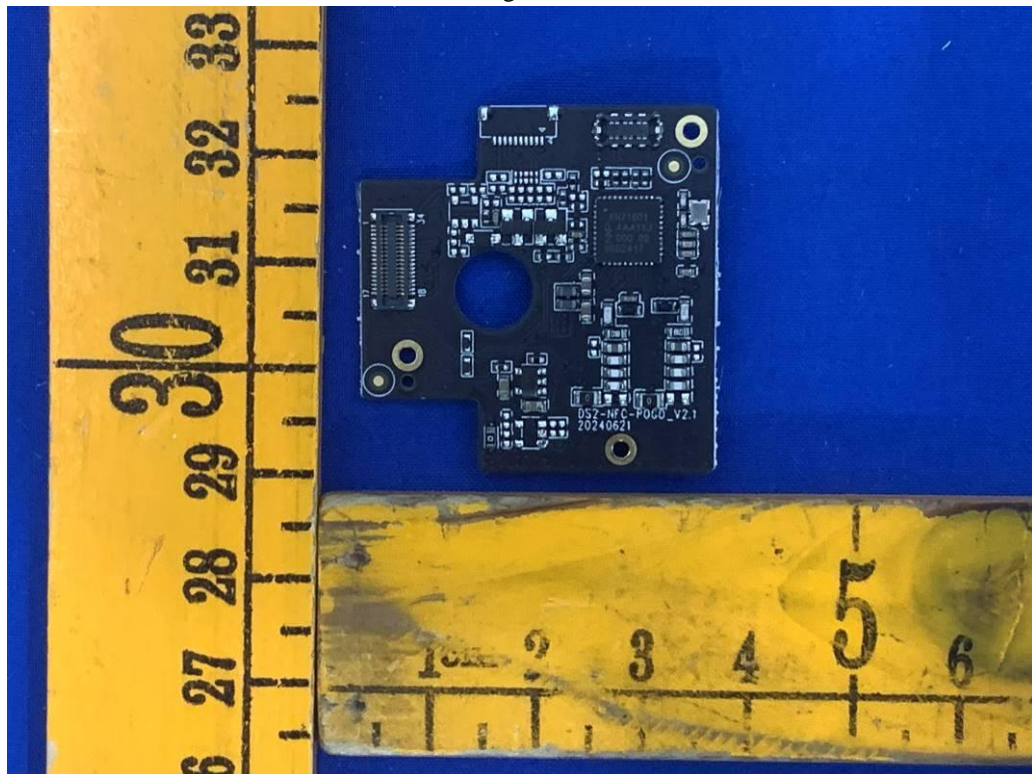

Fig. 33

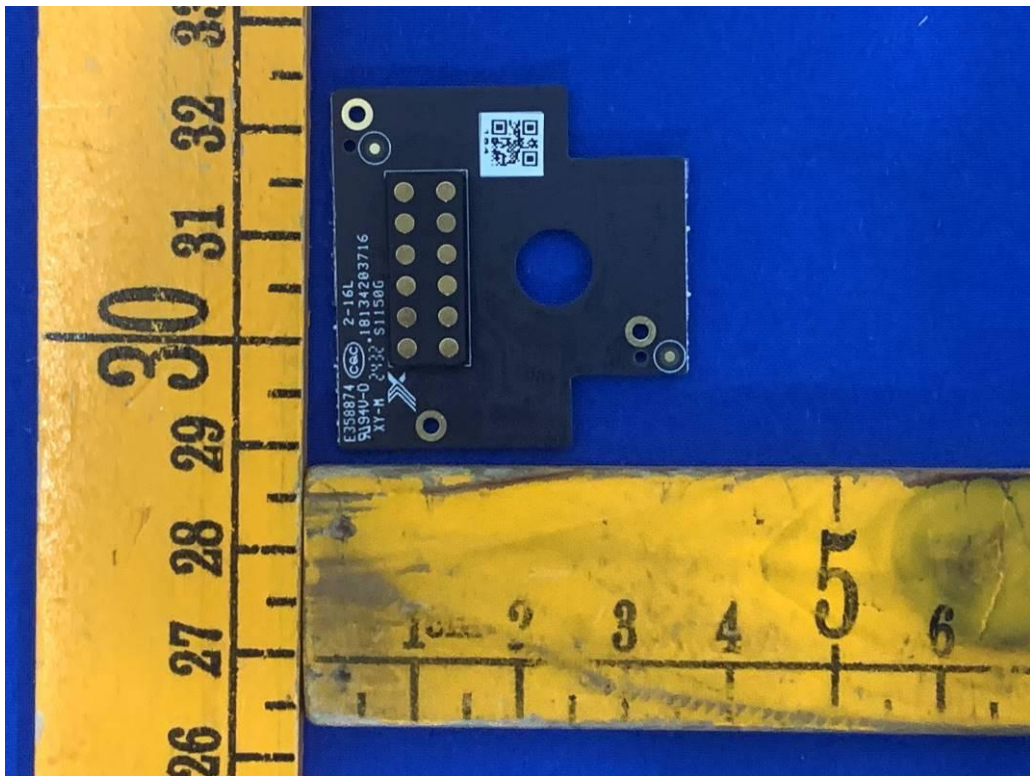

Fig. 34

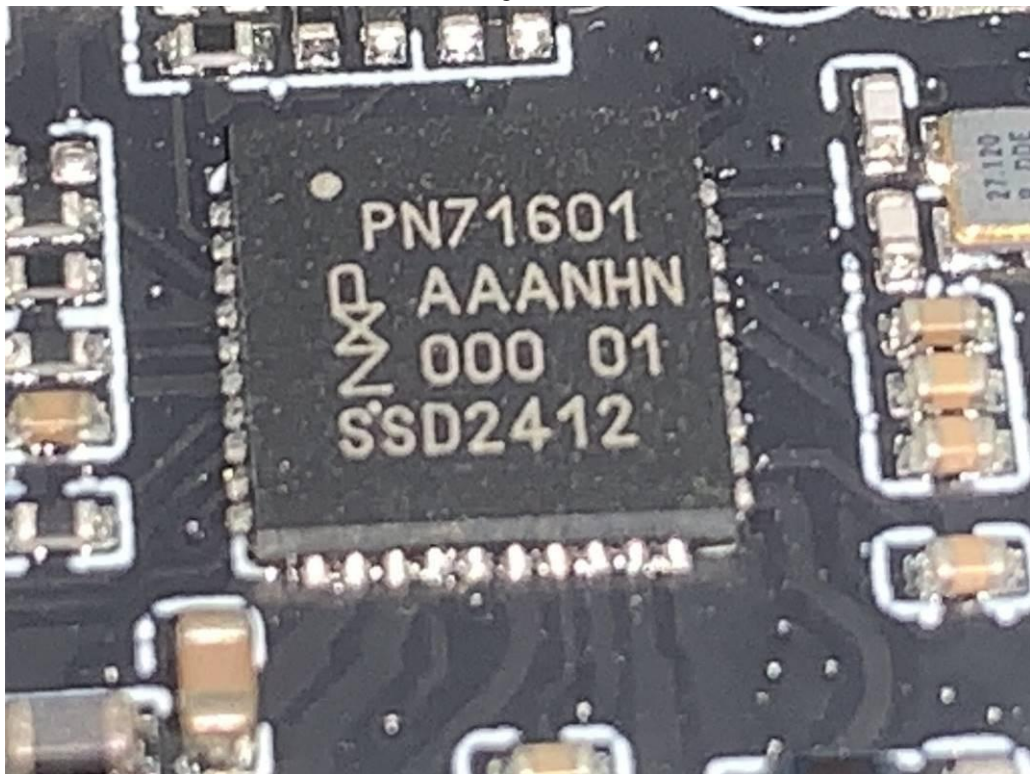

Fig. 35

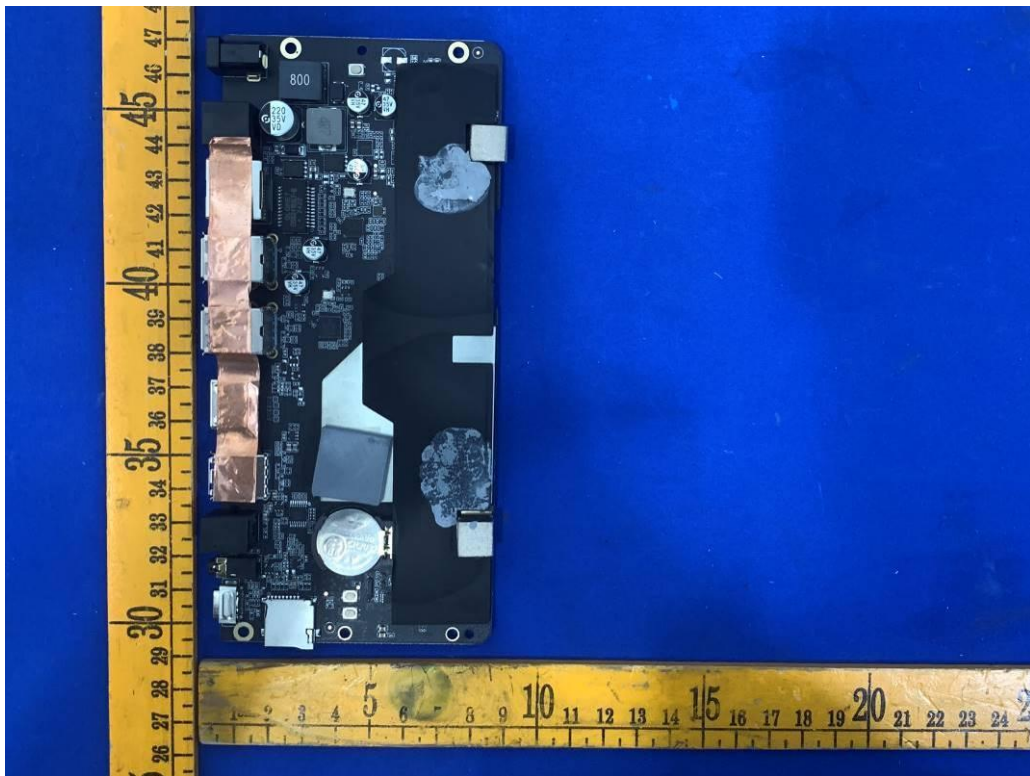

Fig. 36

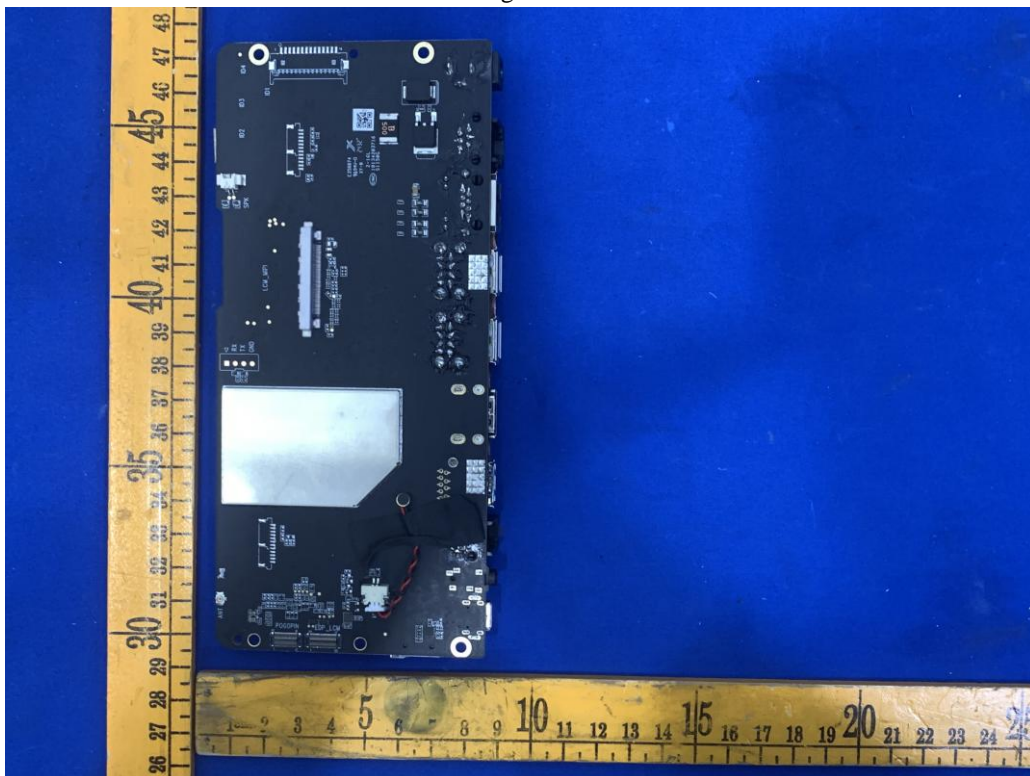

Fig. 37

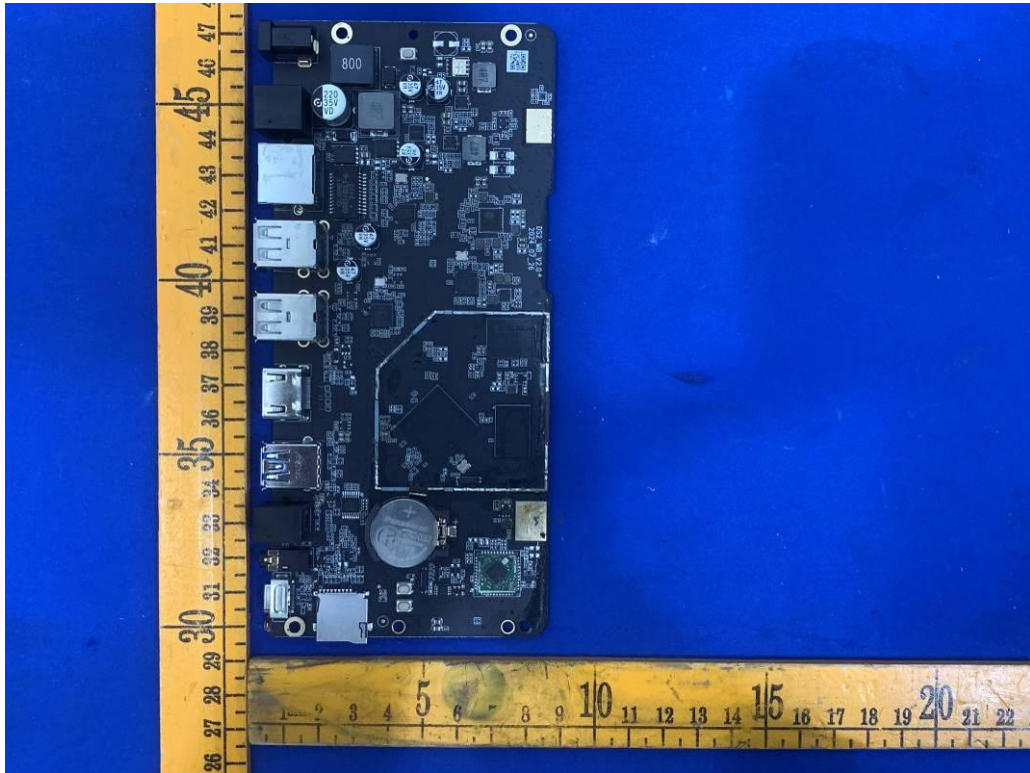

Fig. 38

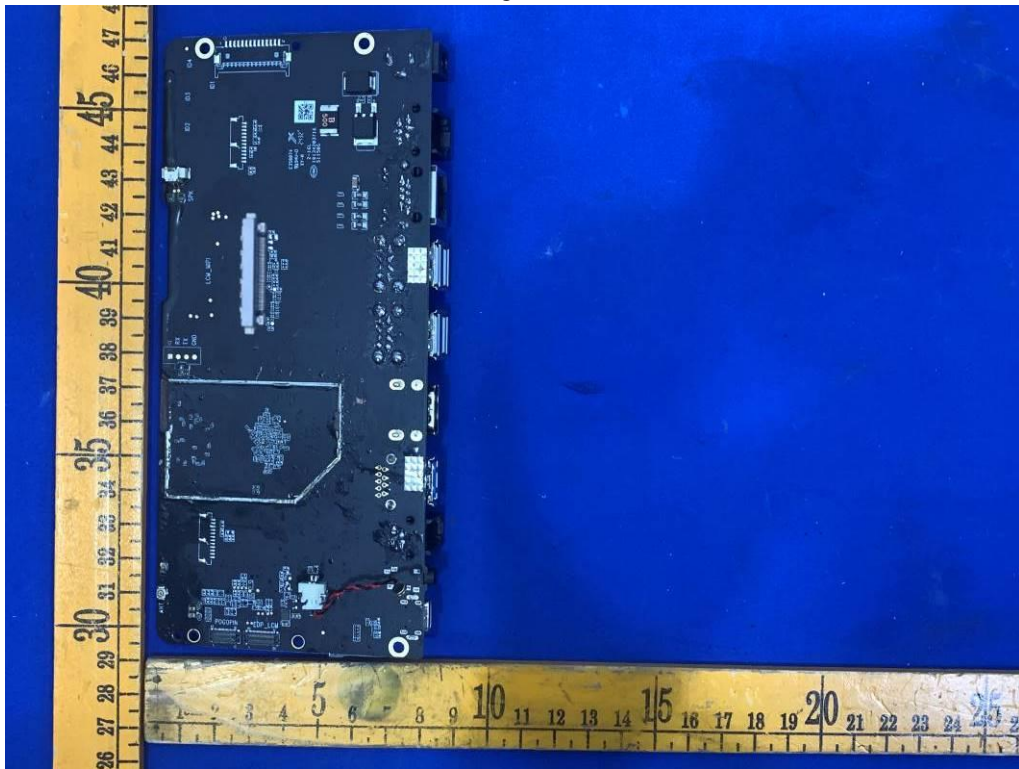

Fig. 39

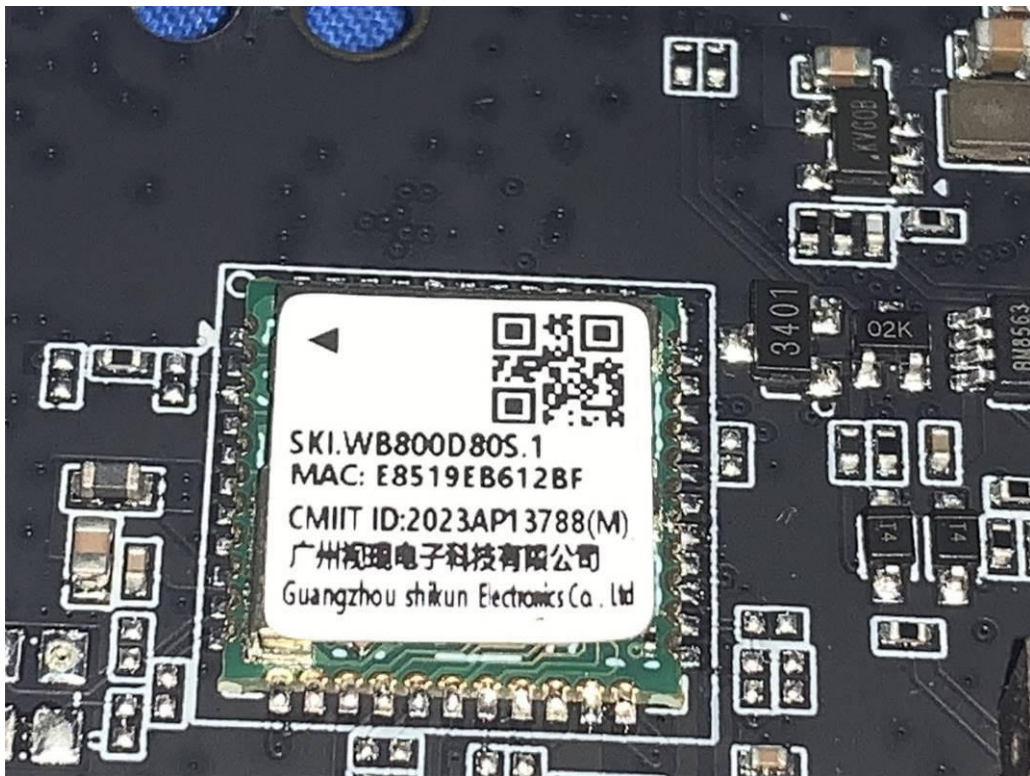

Fig. 40

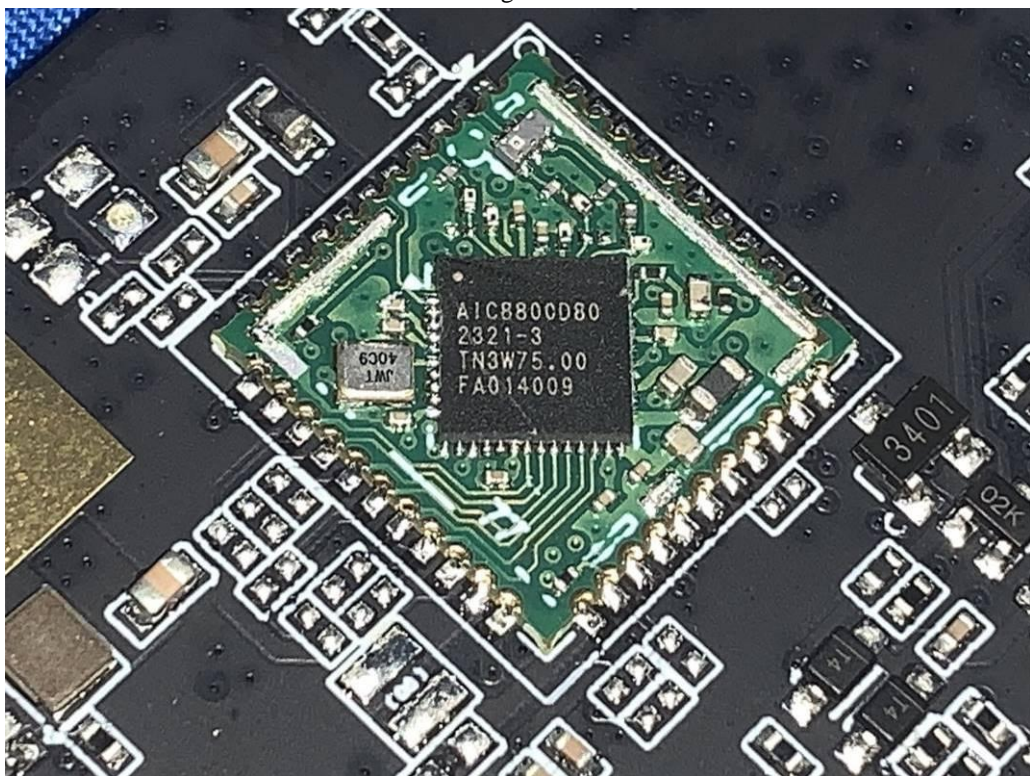

Fig. 41

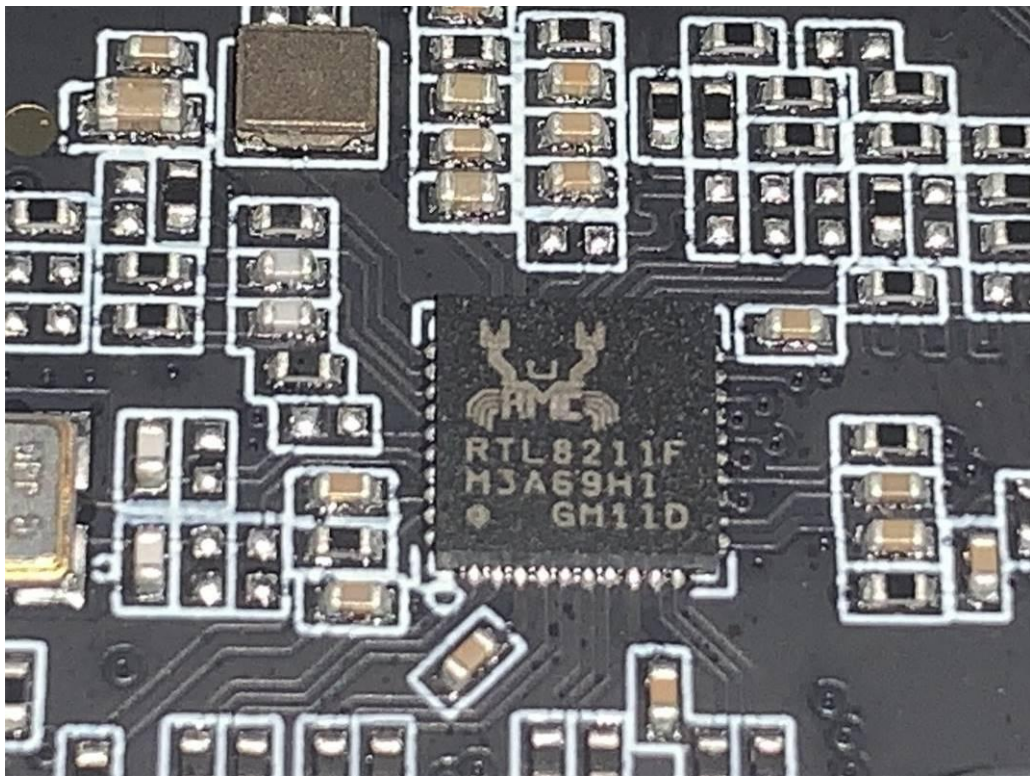

Fig. 42



Fig. 43

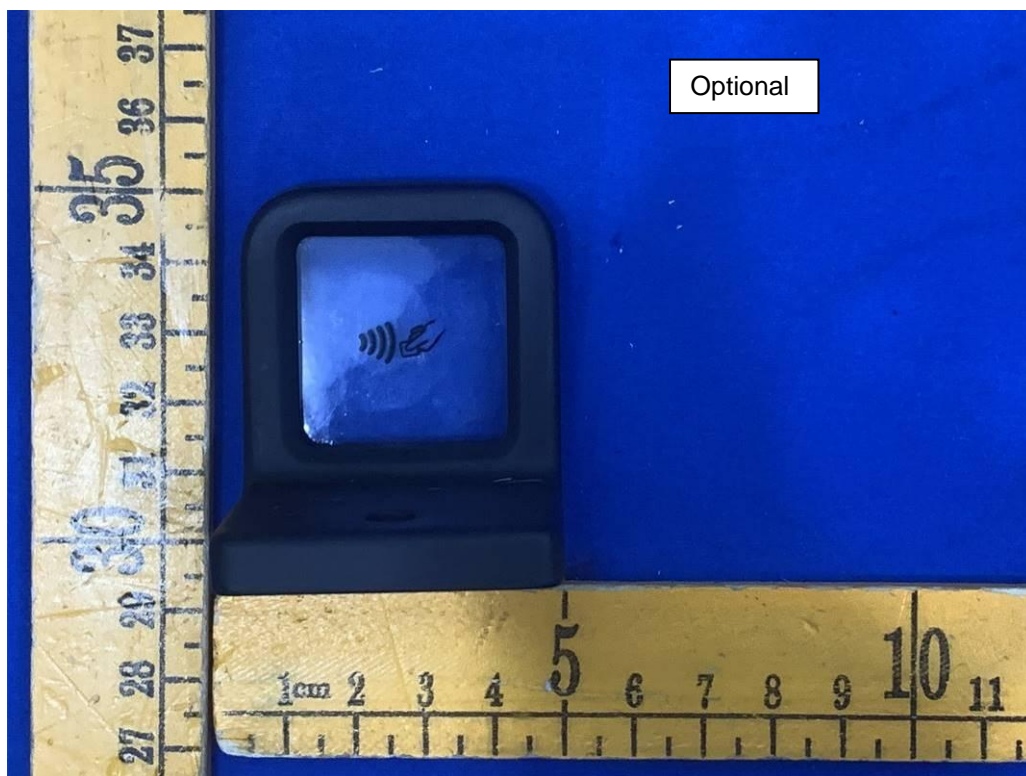

Fig. 44

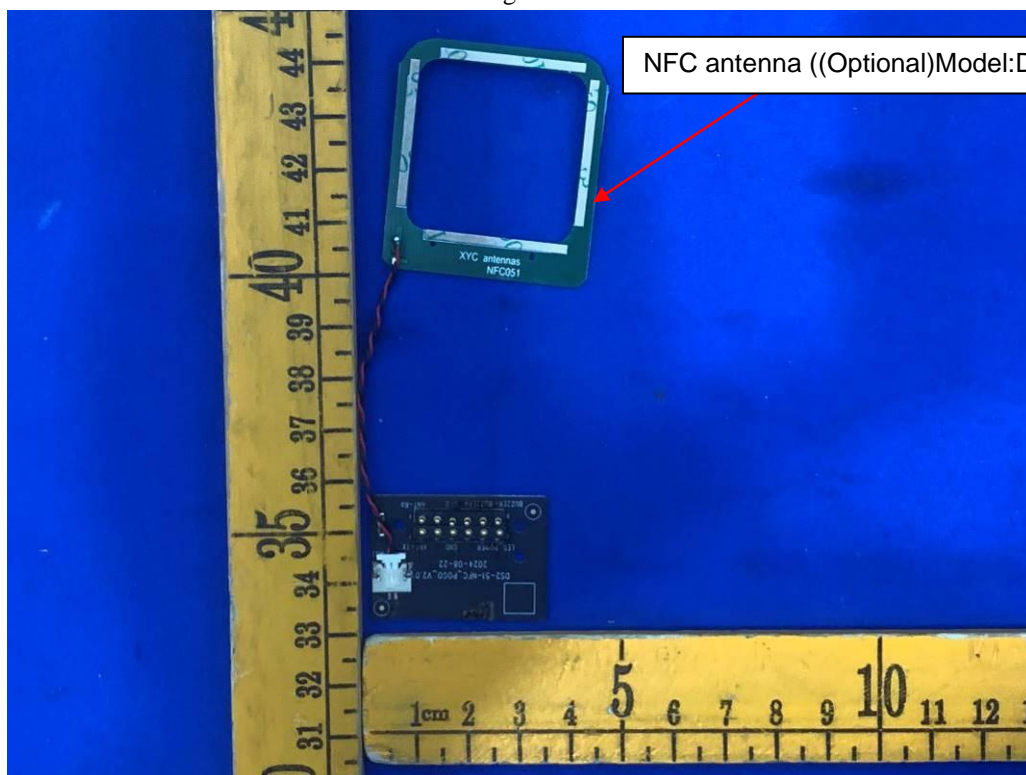

Fig. 45

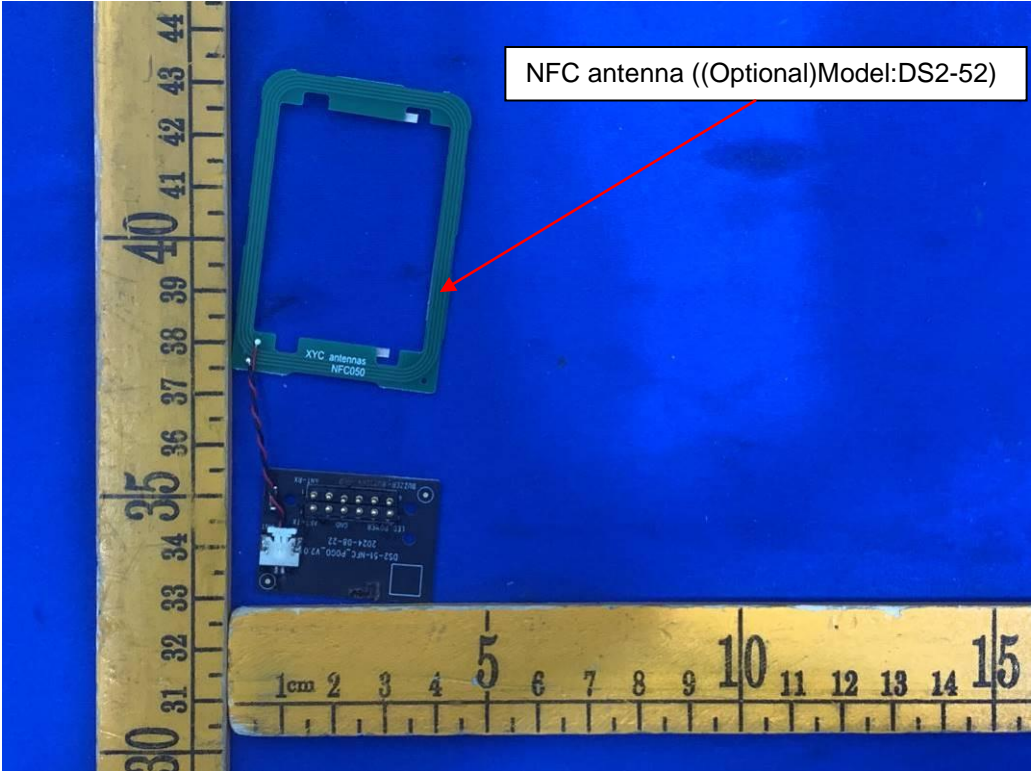

Fig. 46

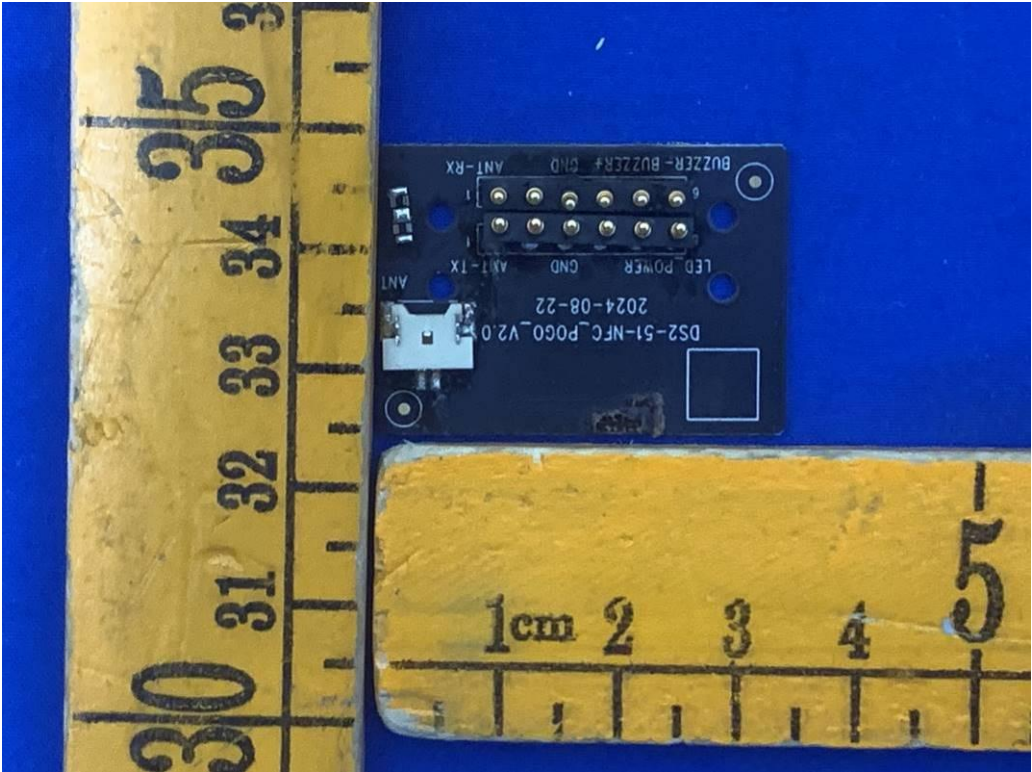

Fig. 47

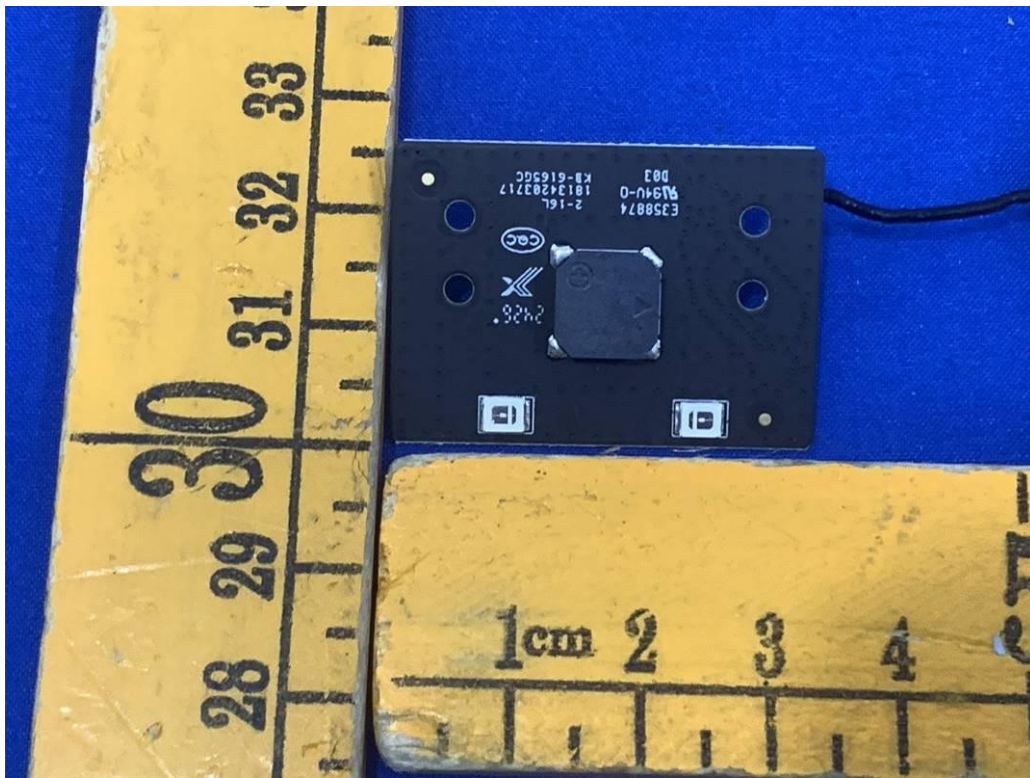

Fig. 48

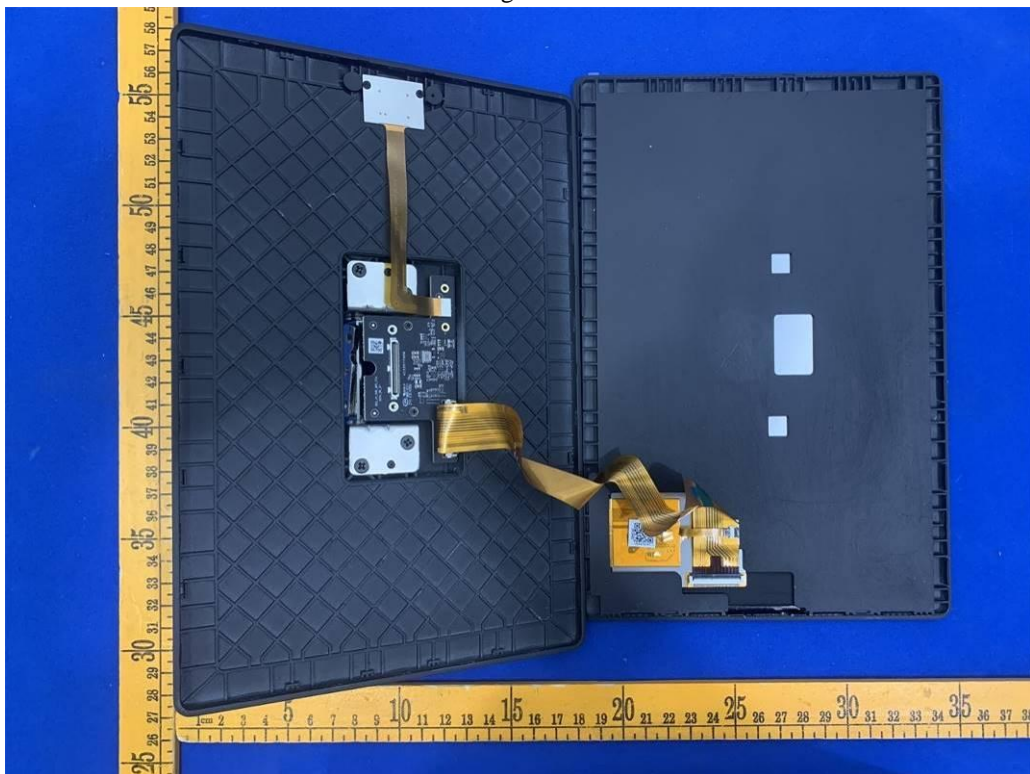

Fig. 49

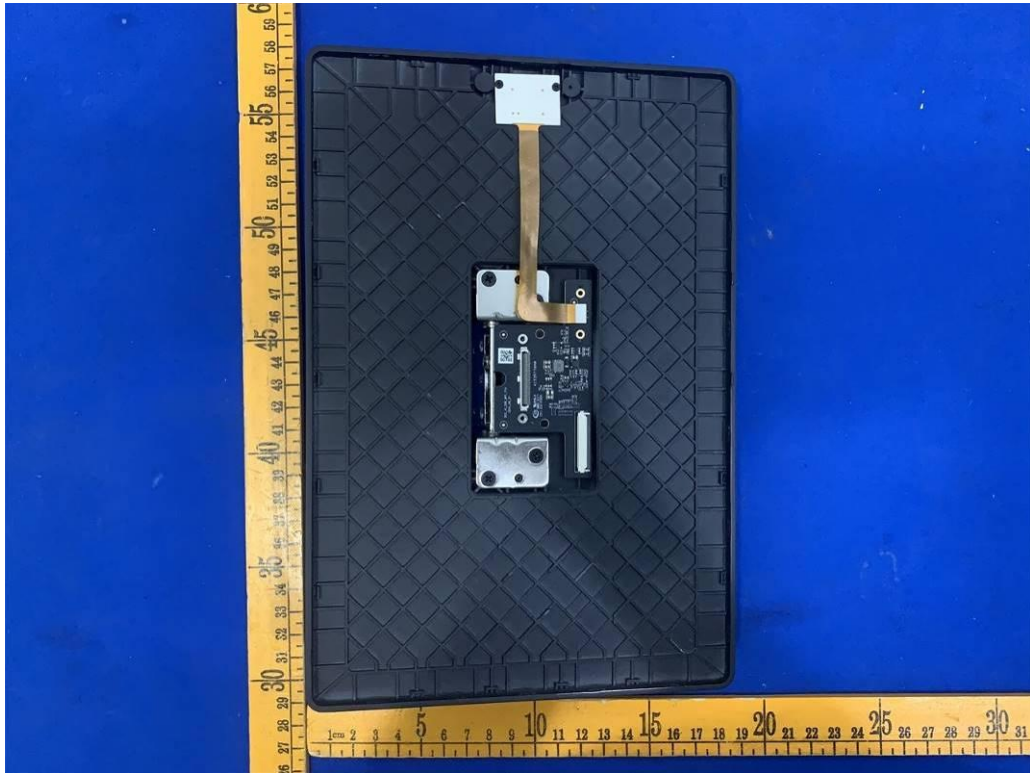

Fig. 50

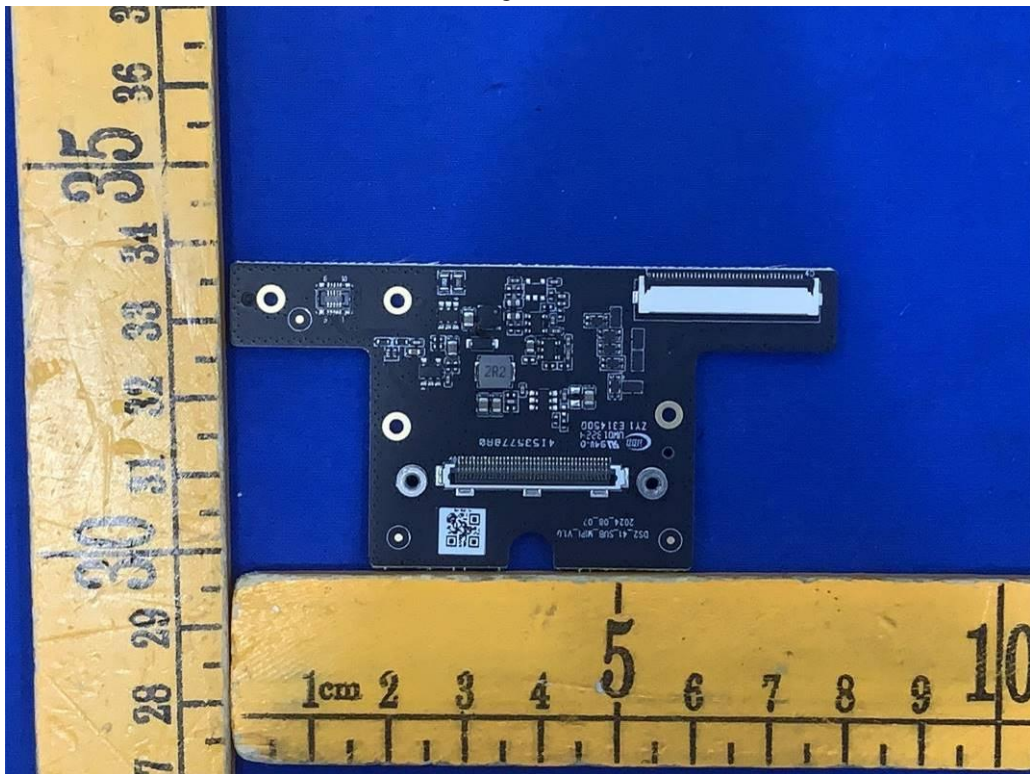

Fig. 51

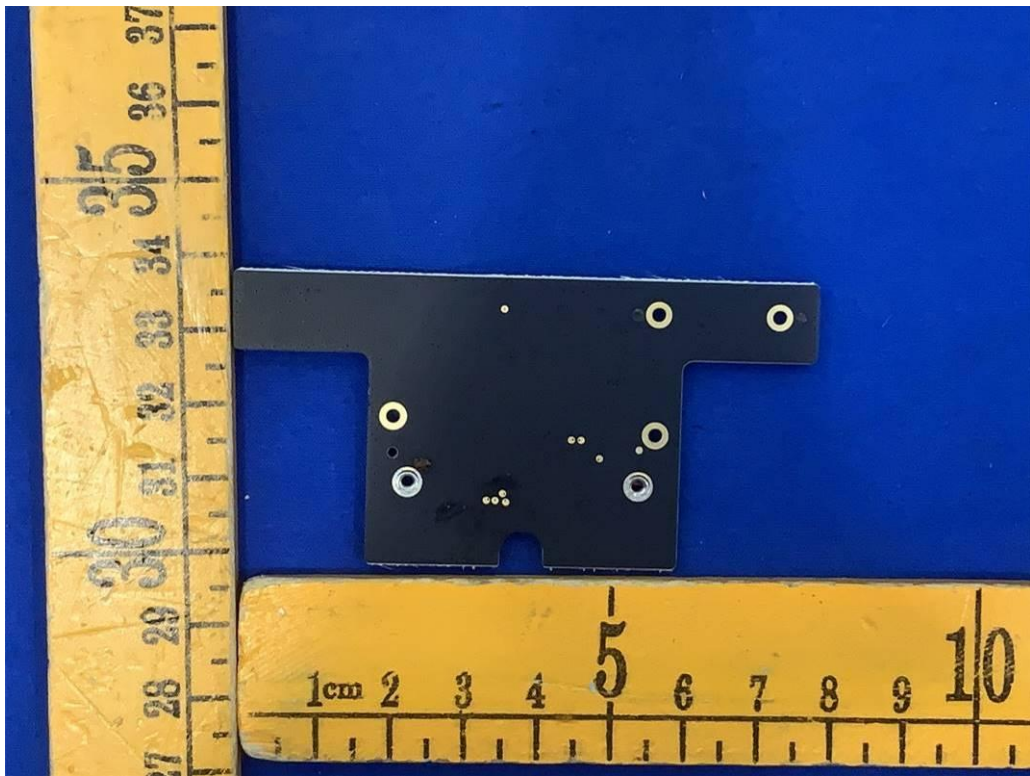

Fig. 52

Versions B

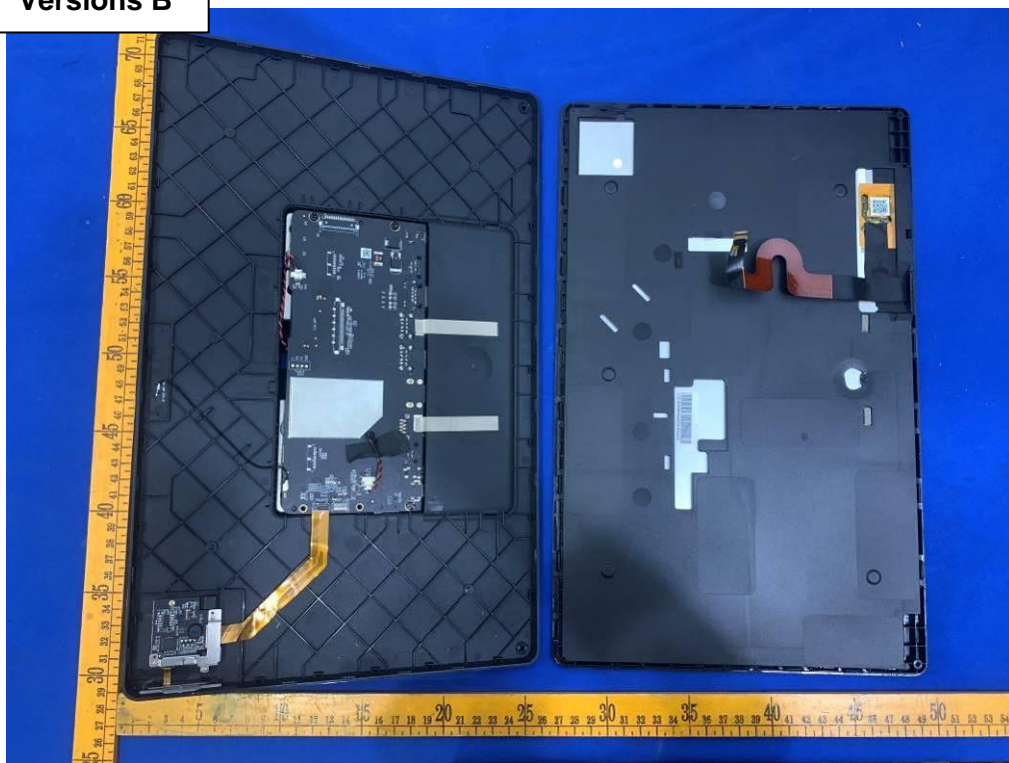

Fig. 53

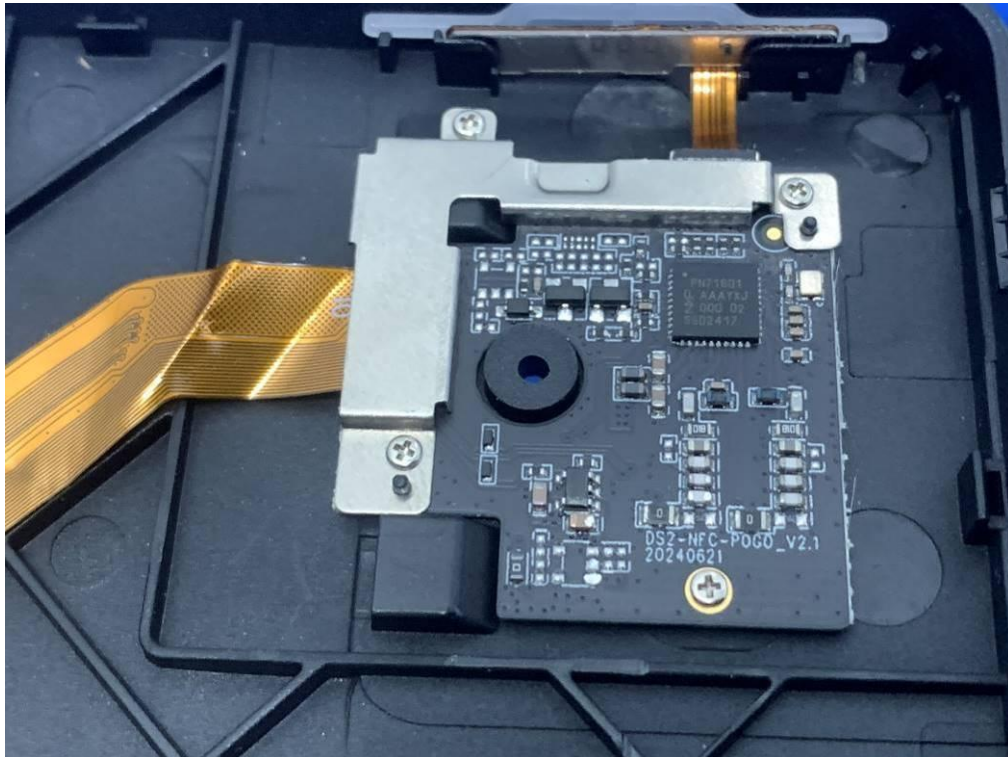

Fig. 54



Fig. 55

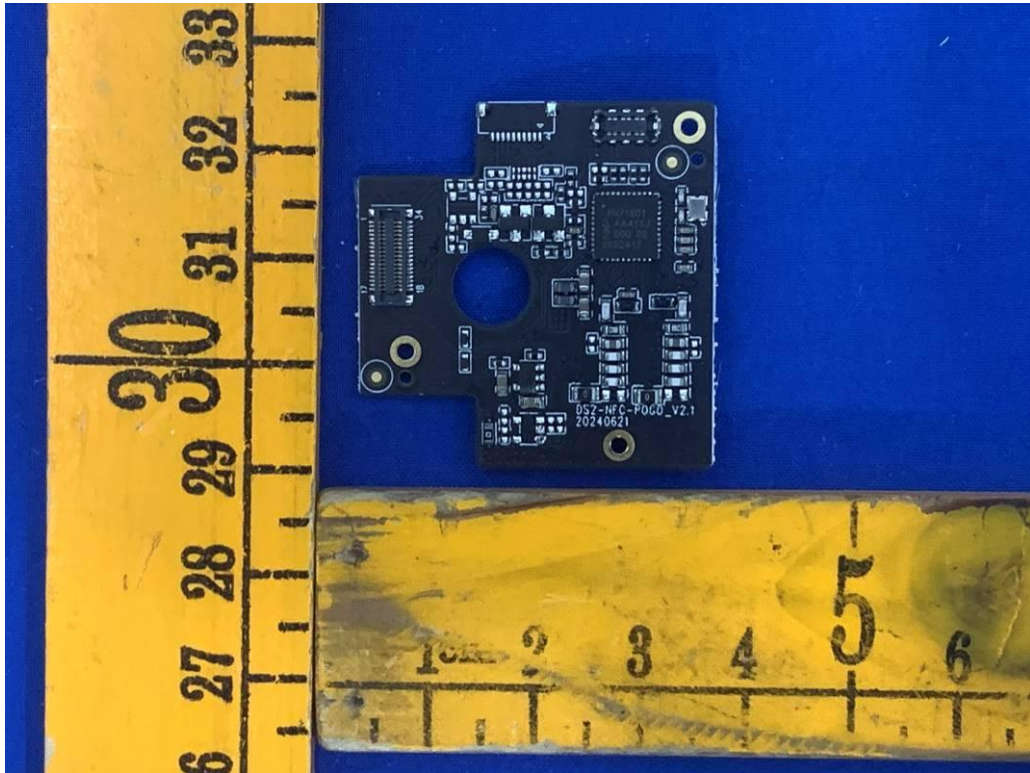

Fig. 56

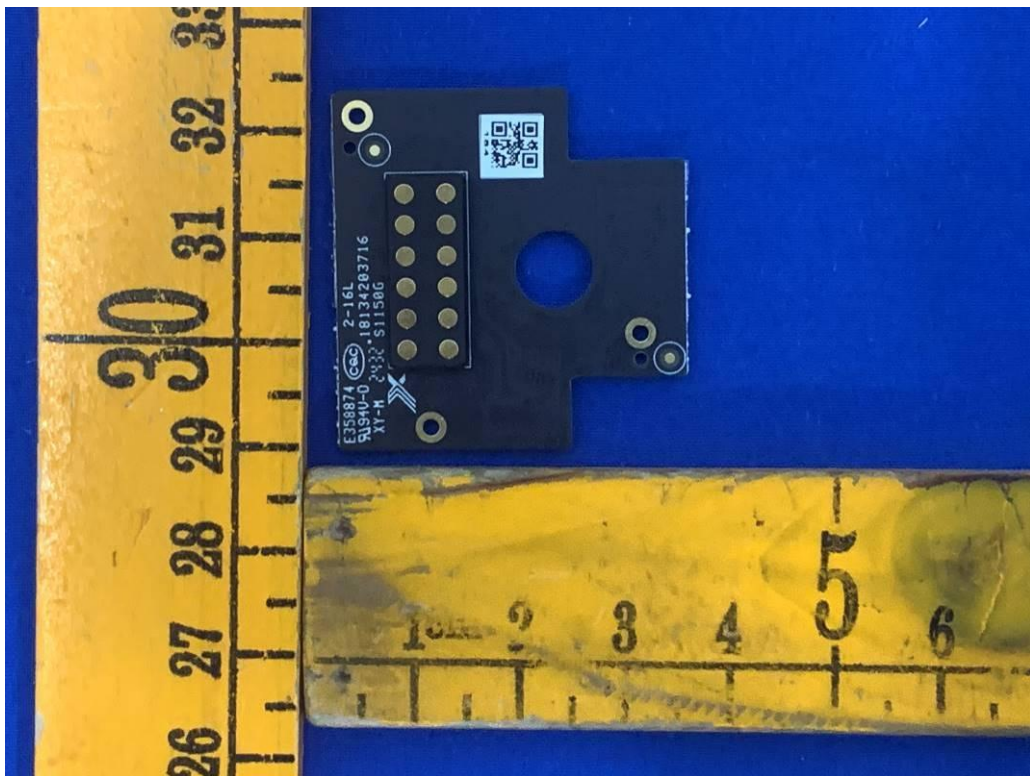

Fig. 57

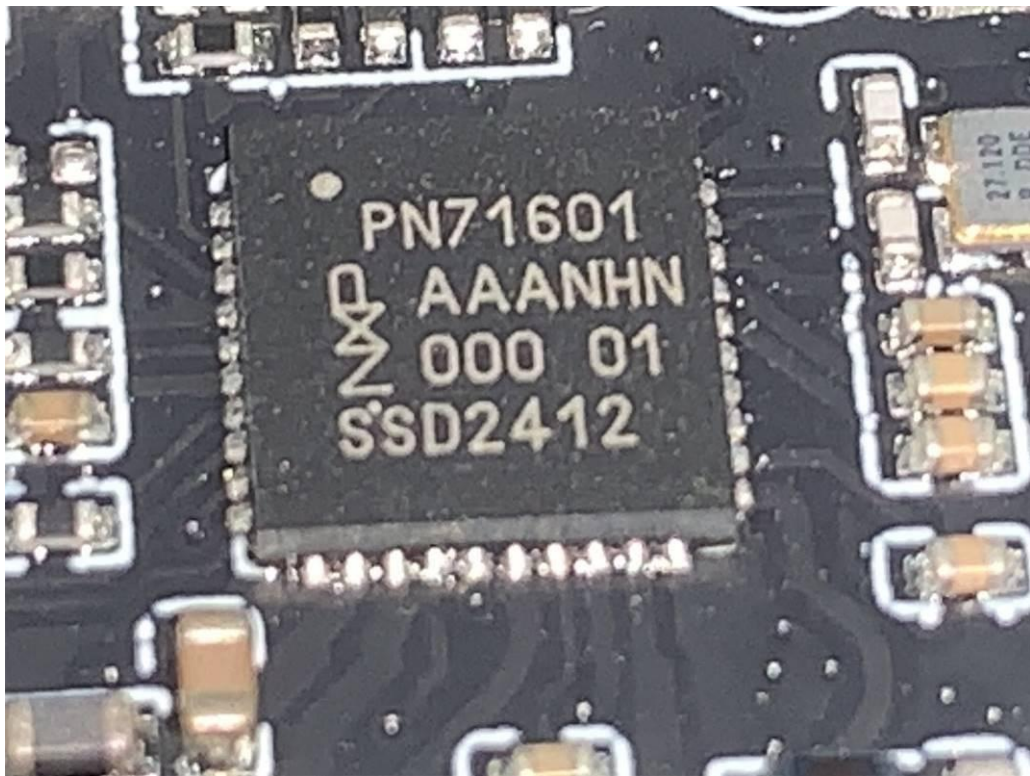

Fig. 58

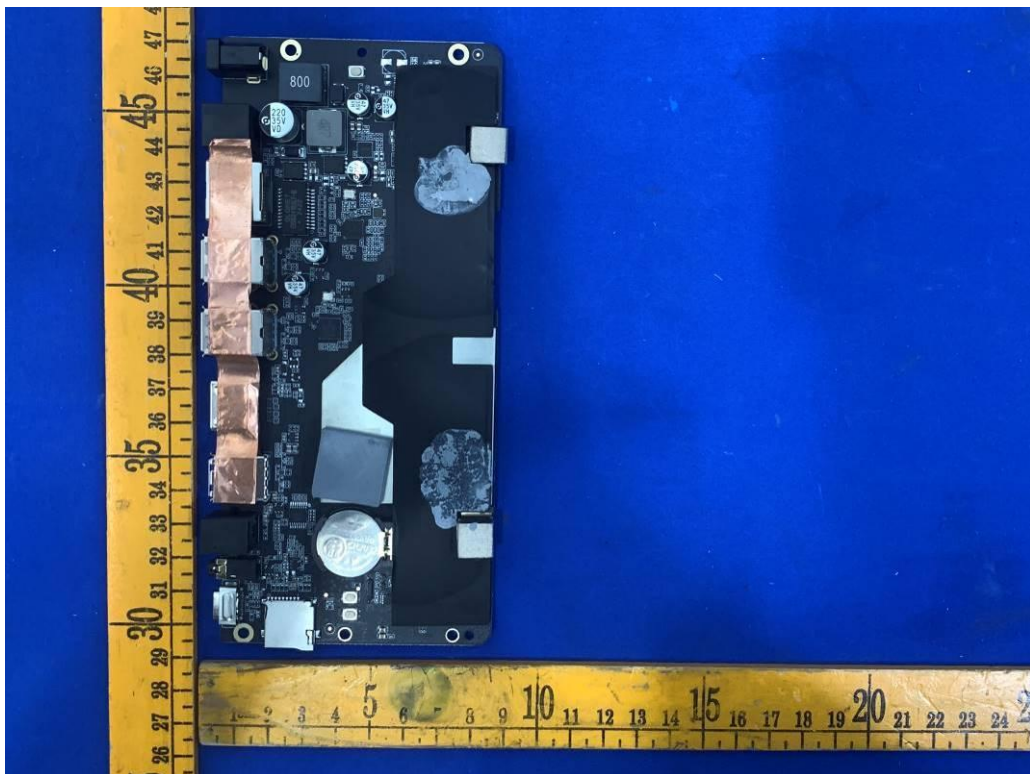

Fig. 59

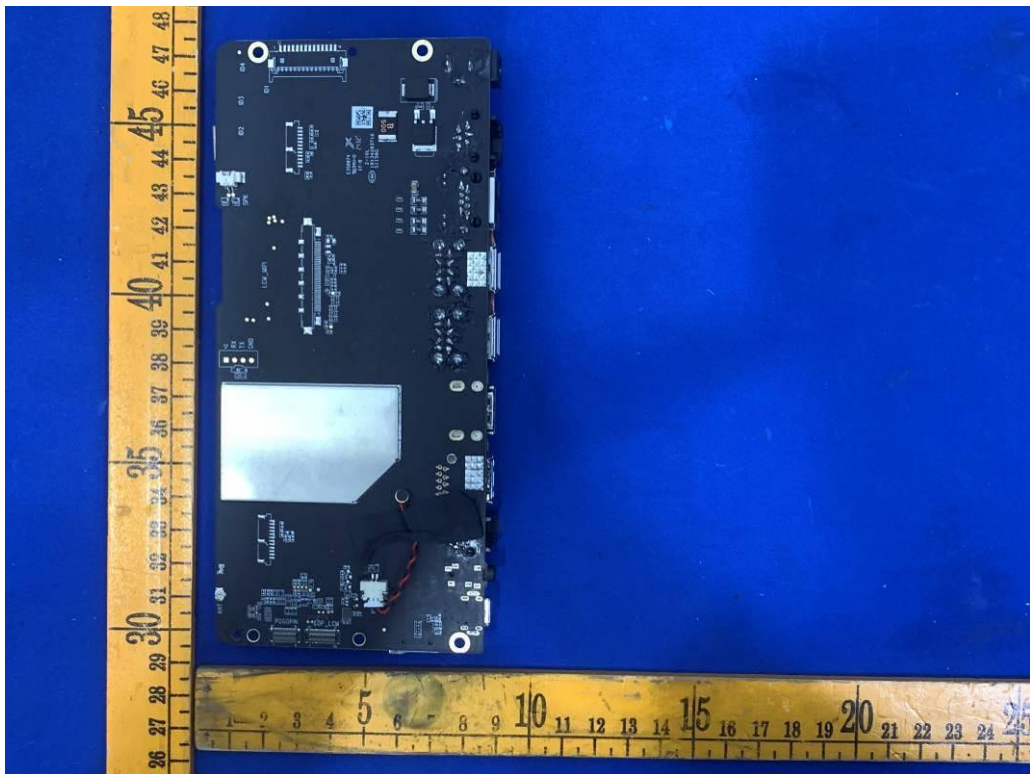

Fig. 60

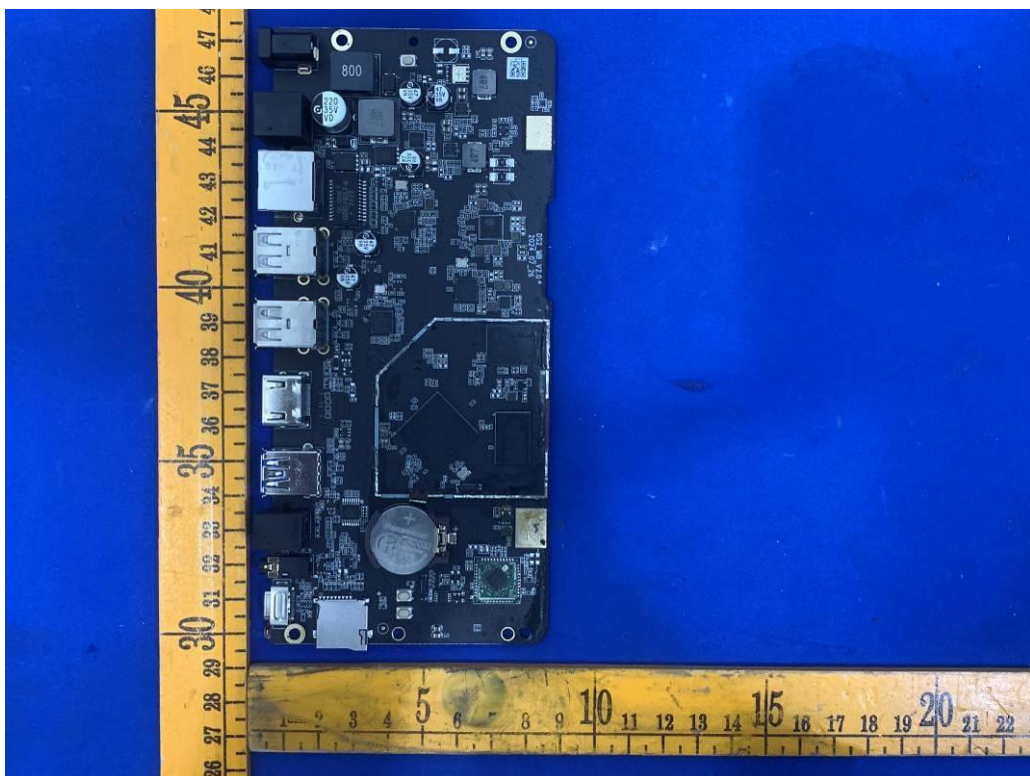

Fig. 61

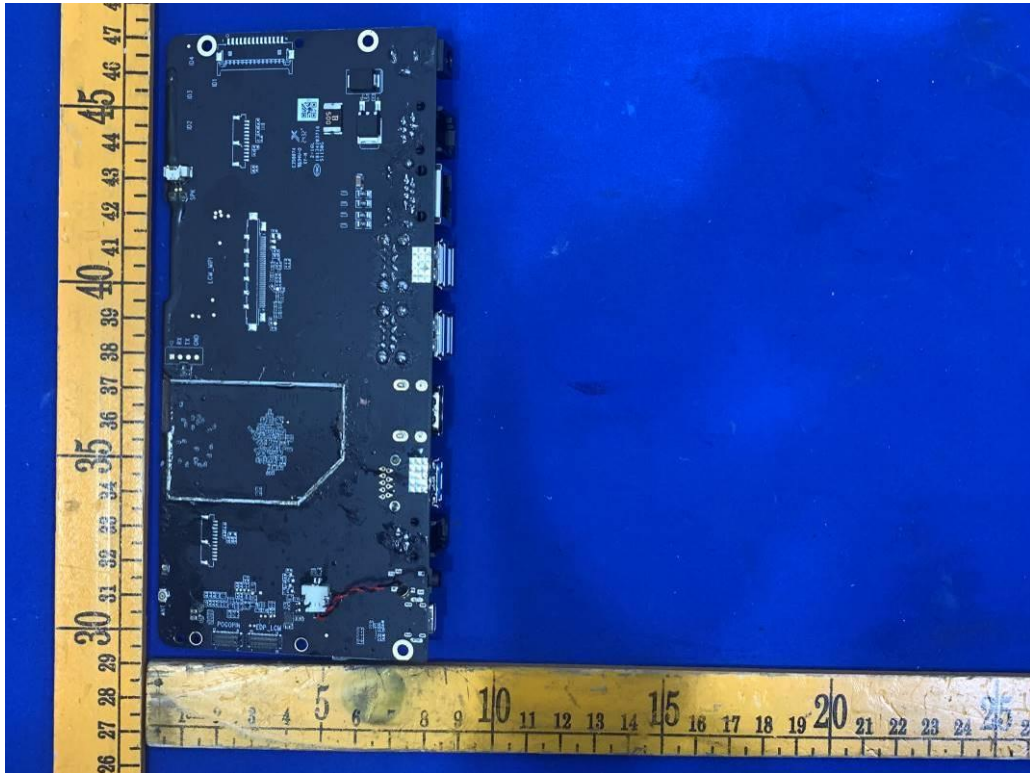

Fig. 62

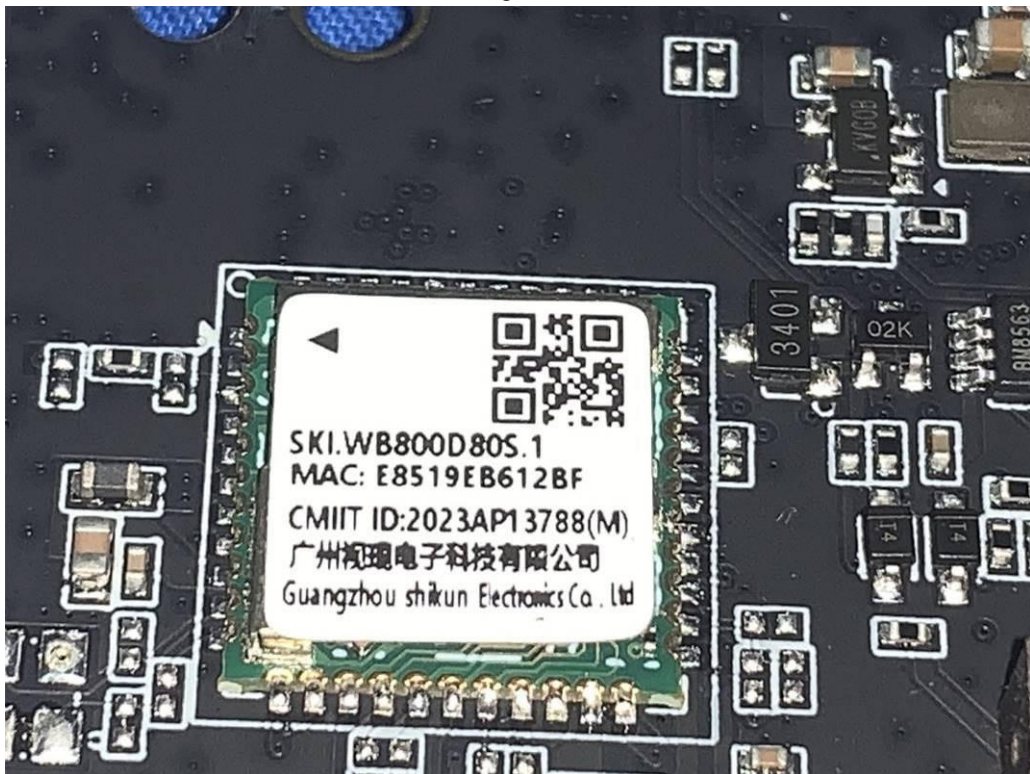

Fig. 63

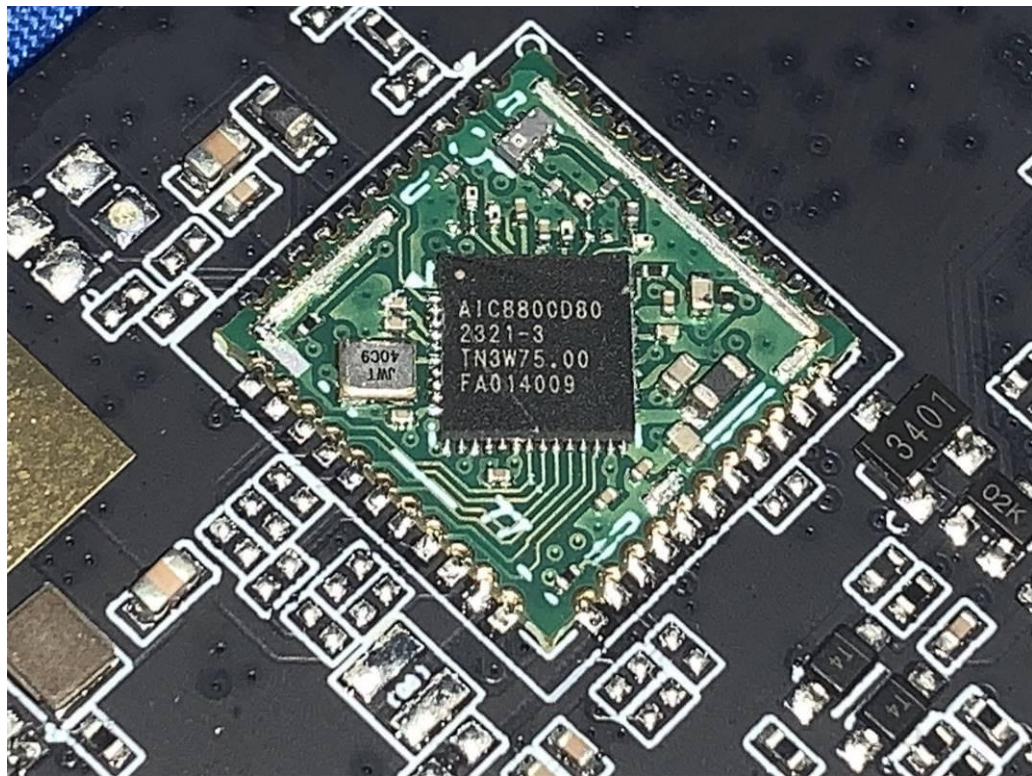

Fig. 64

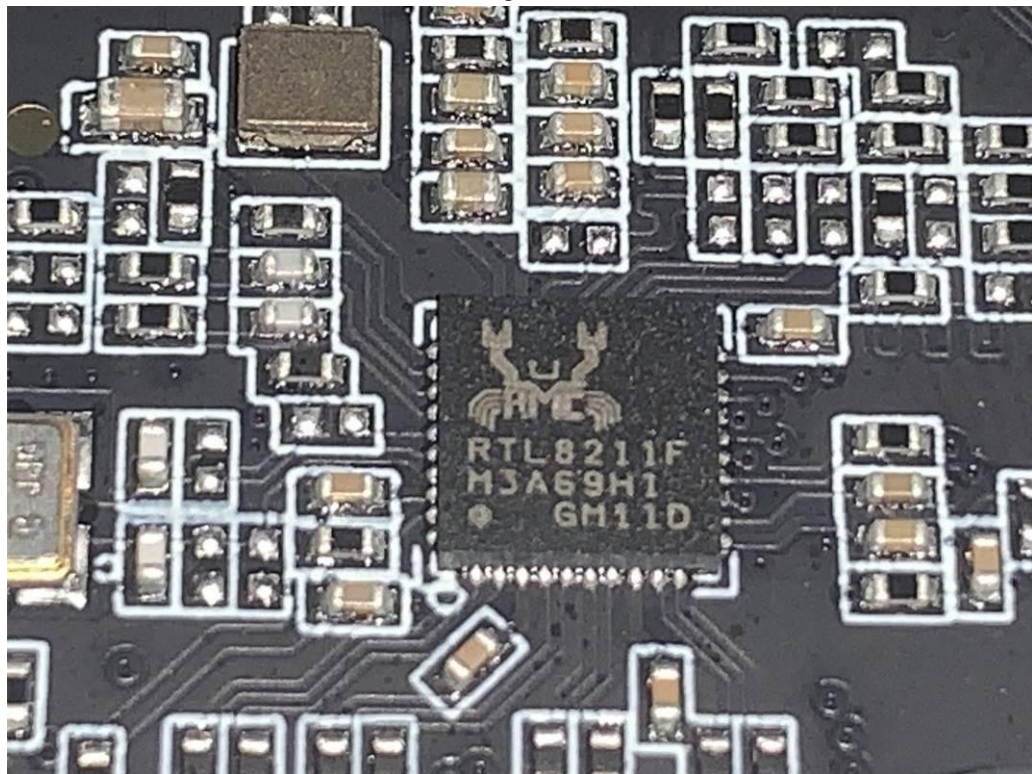

Fig. 65



Fig. 66

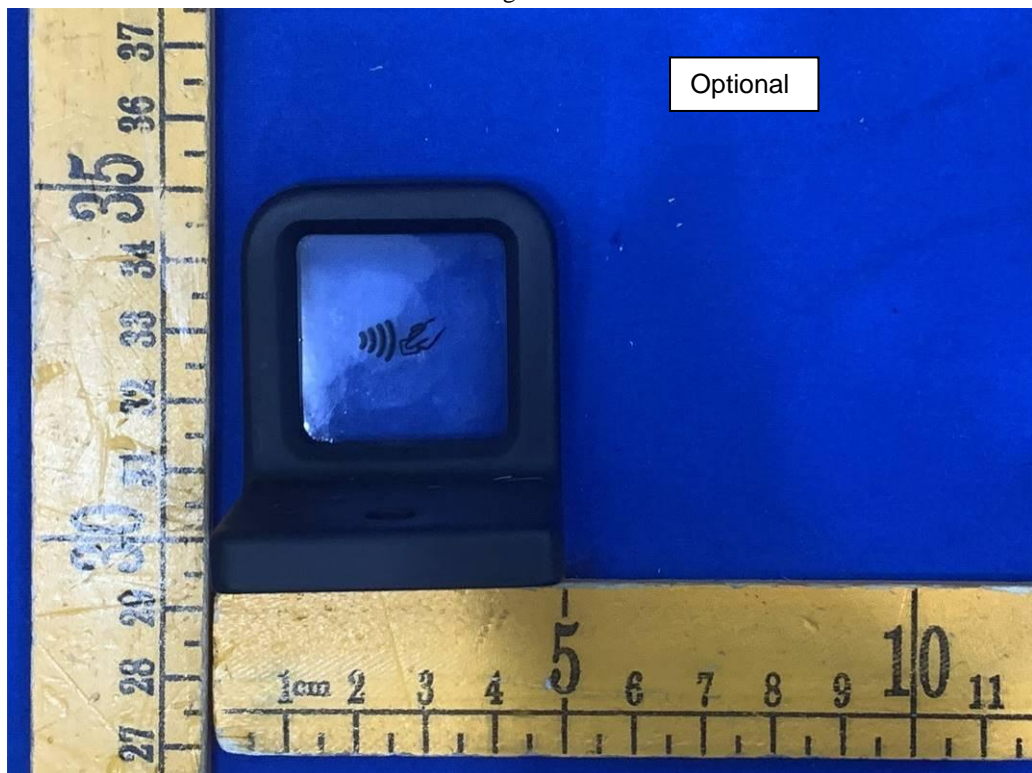

Fig. 67

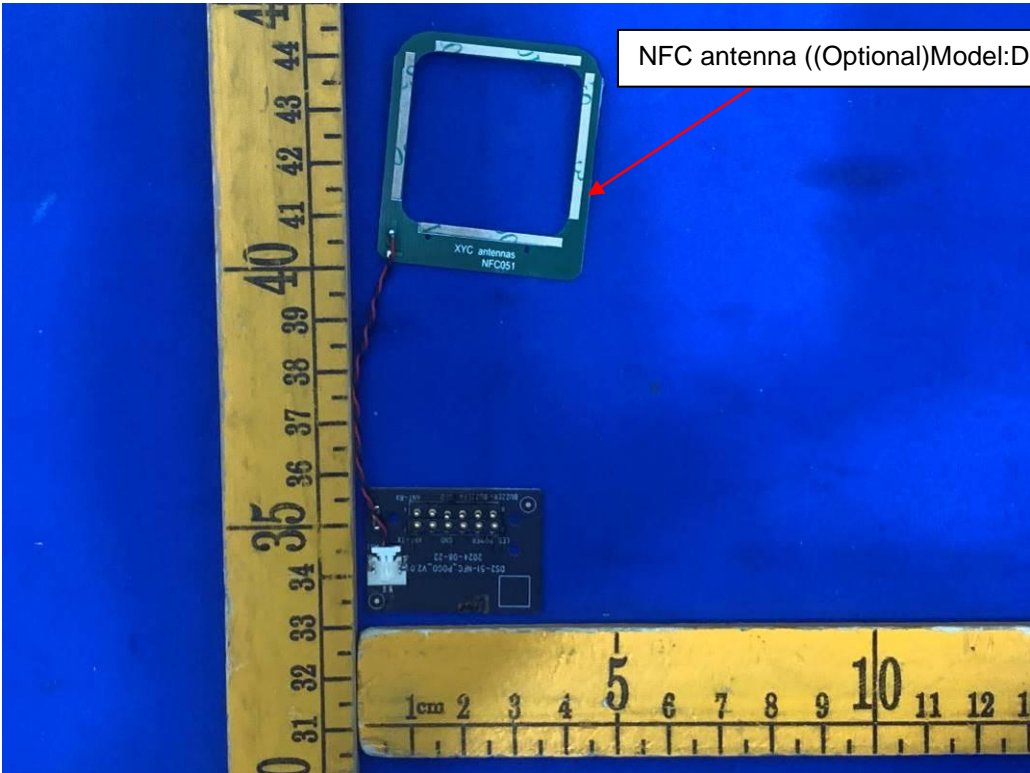

Fig. 68

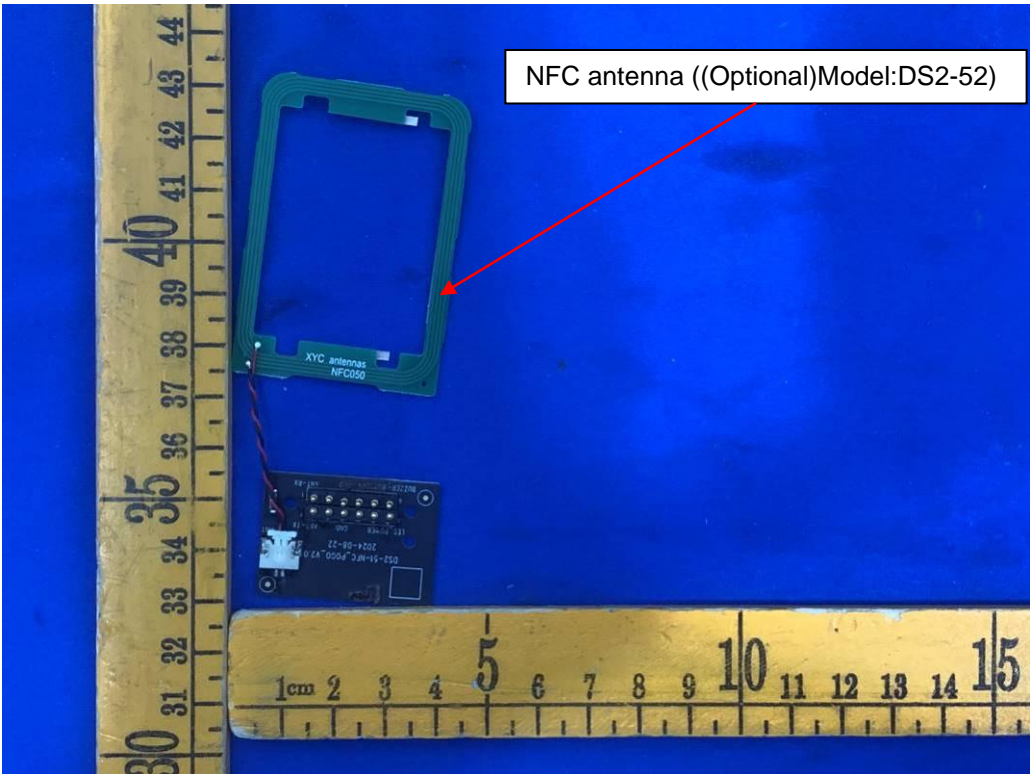

Fig. 69

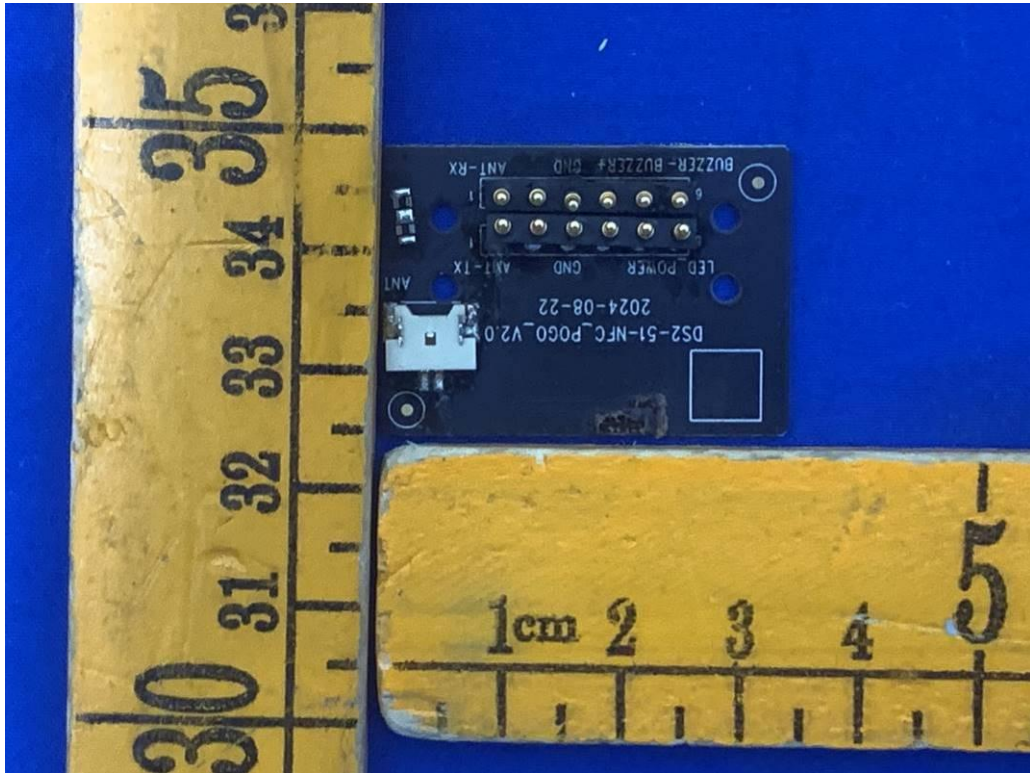

Fig. 70

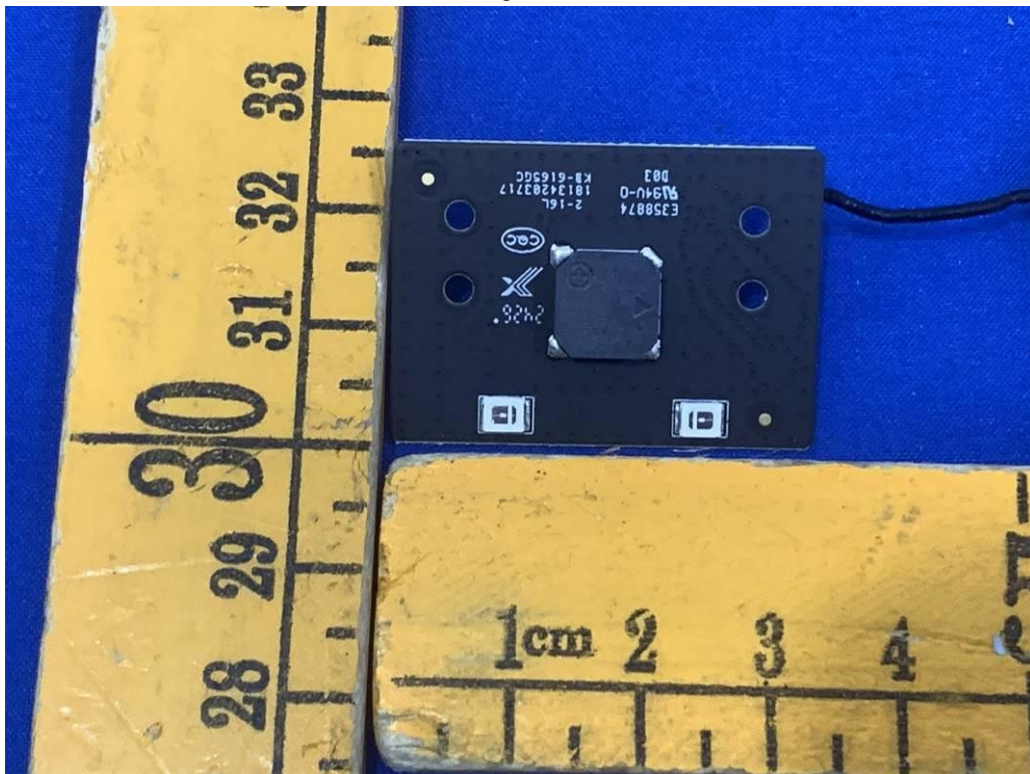

Fig. 71

Versions C

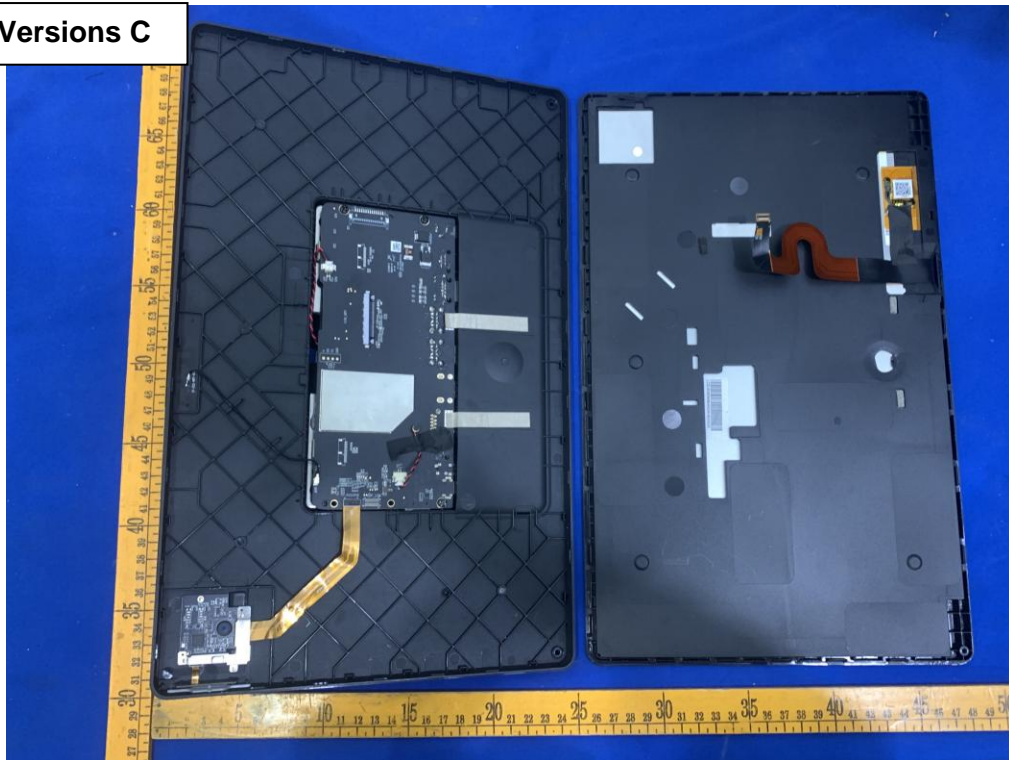

Fig. 72

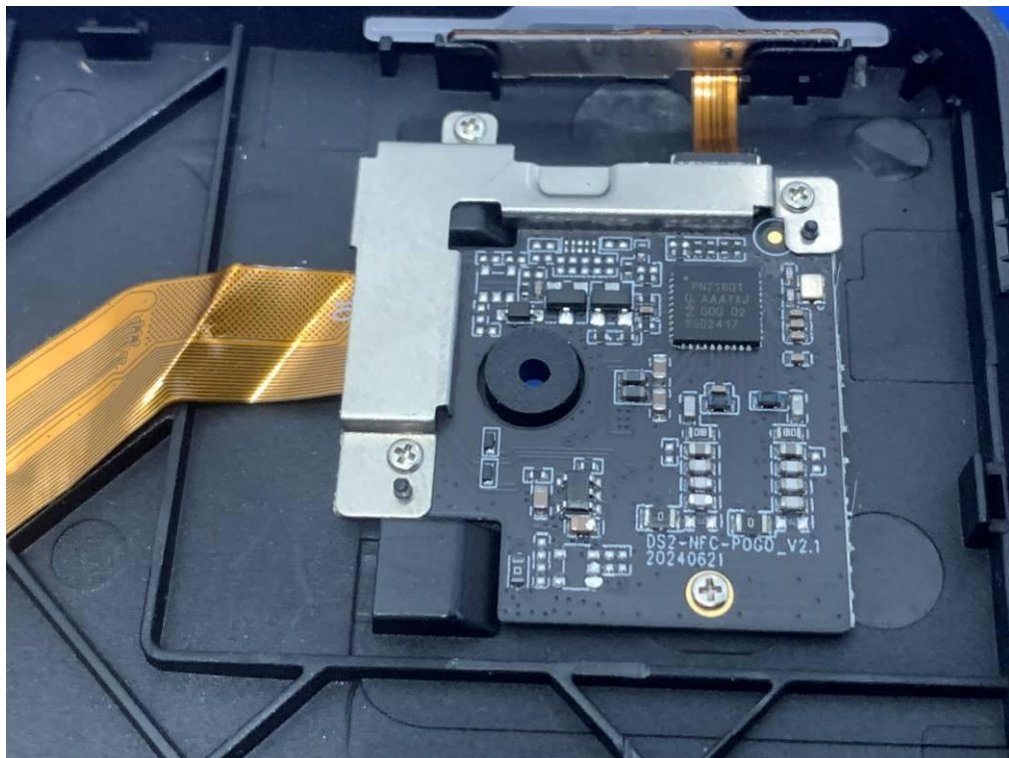

Fig. 73



Fig. 74

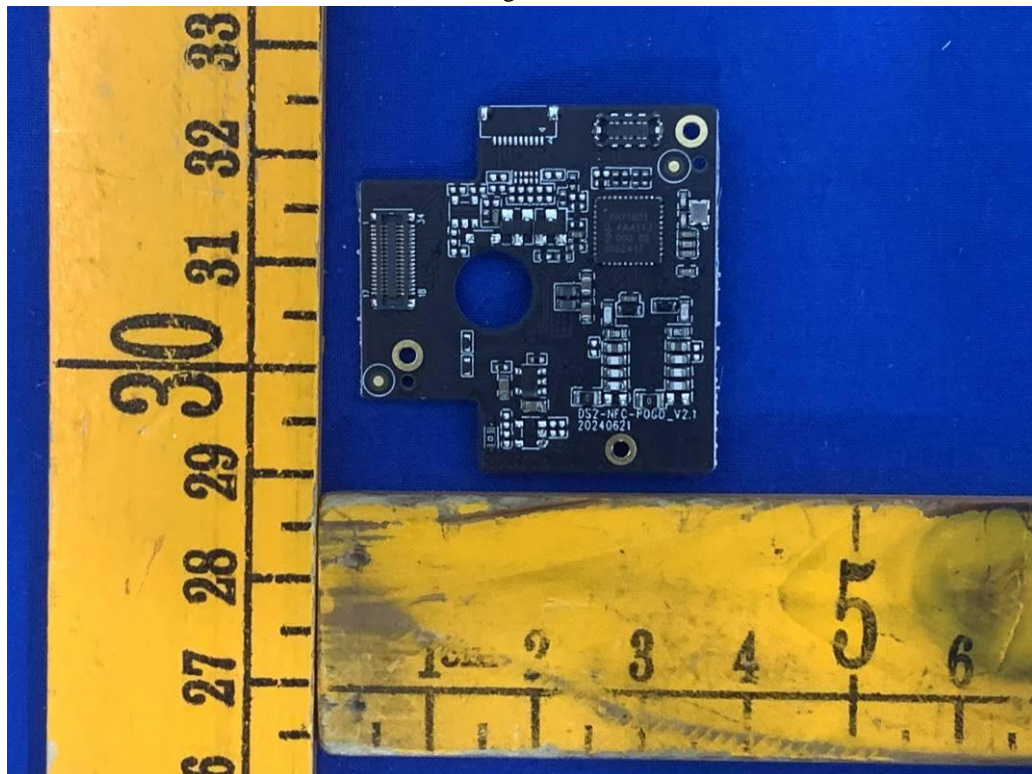

Fig. 75

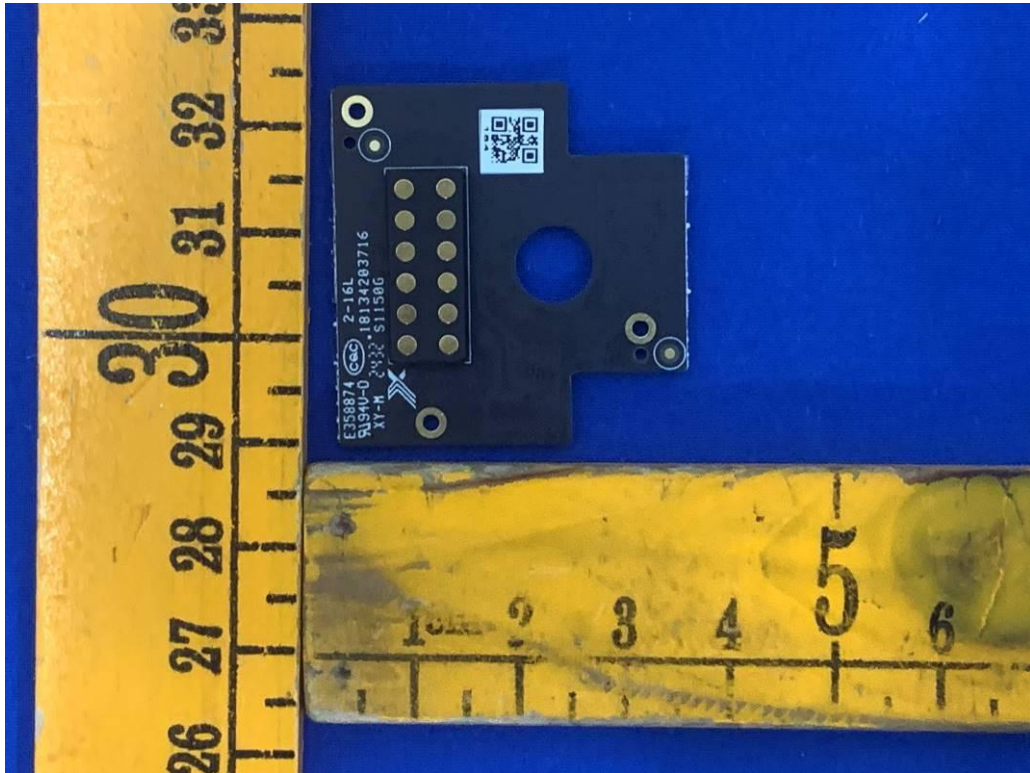

Fig. 76

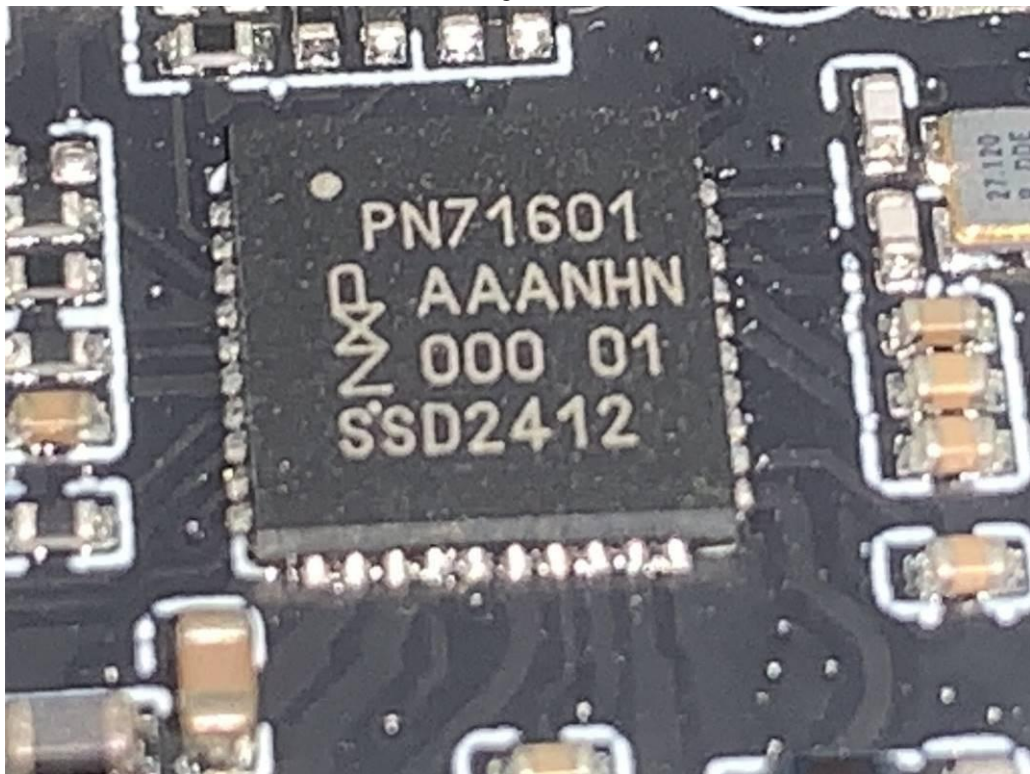

Fig. 77

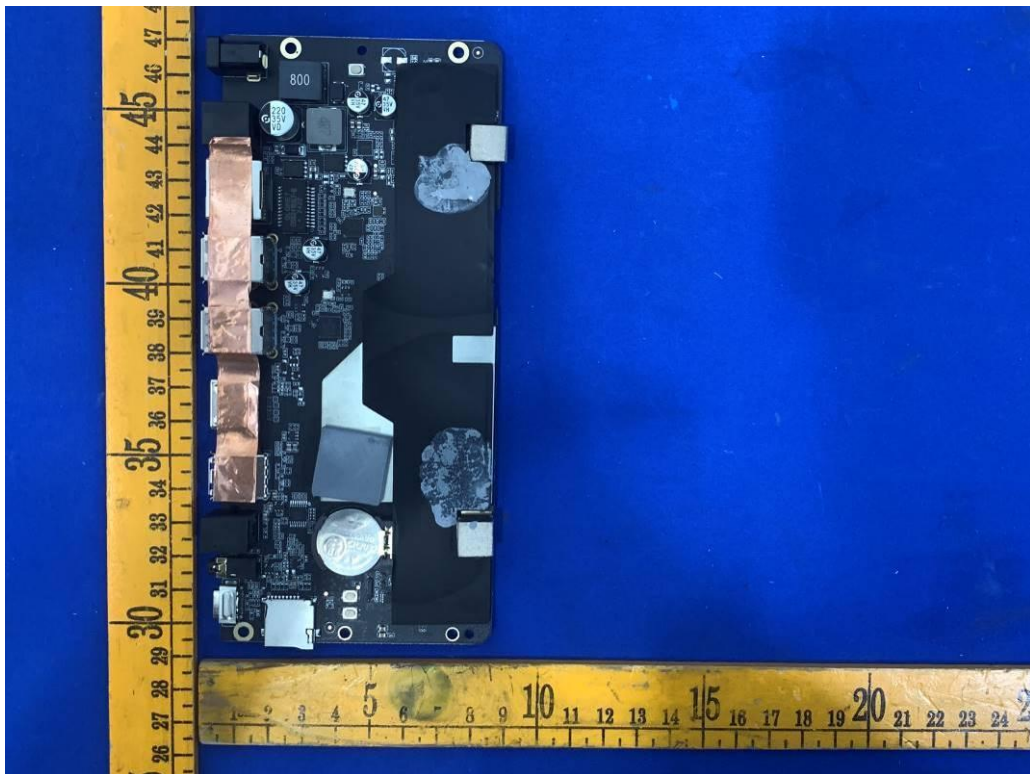

Fig. 78

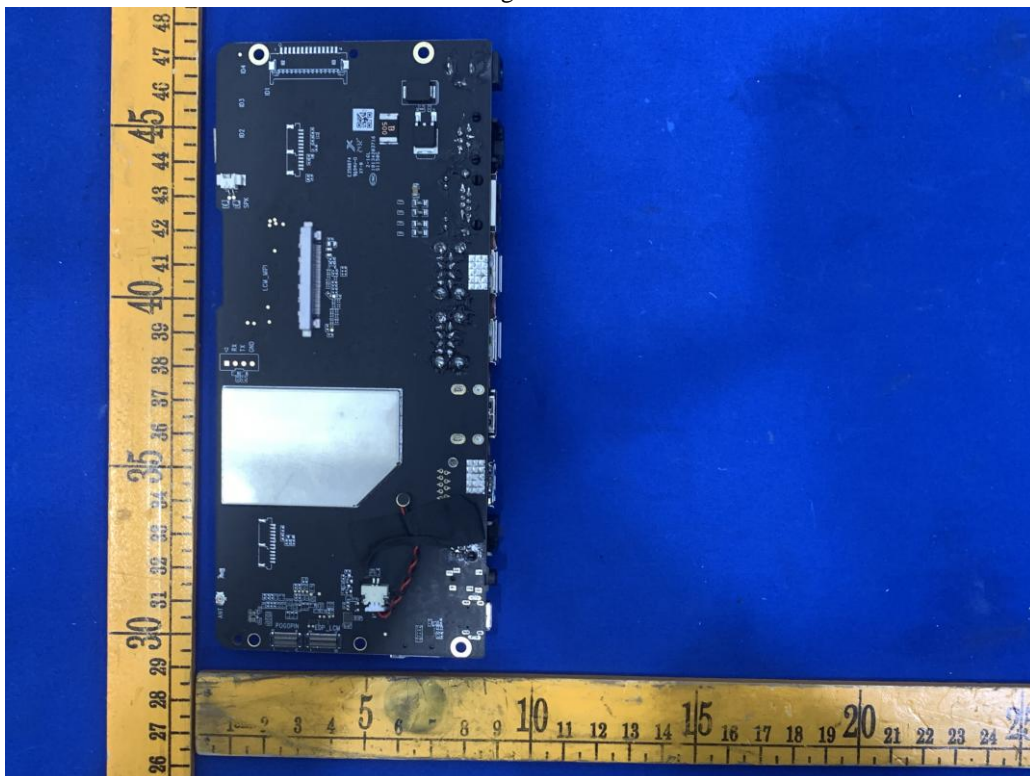

Fig. 79

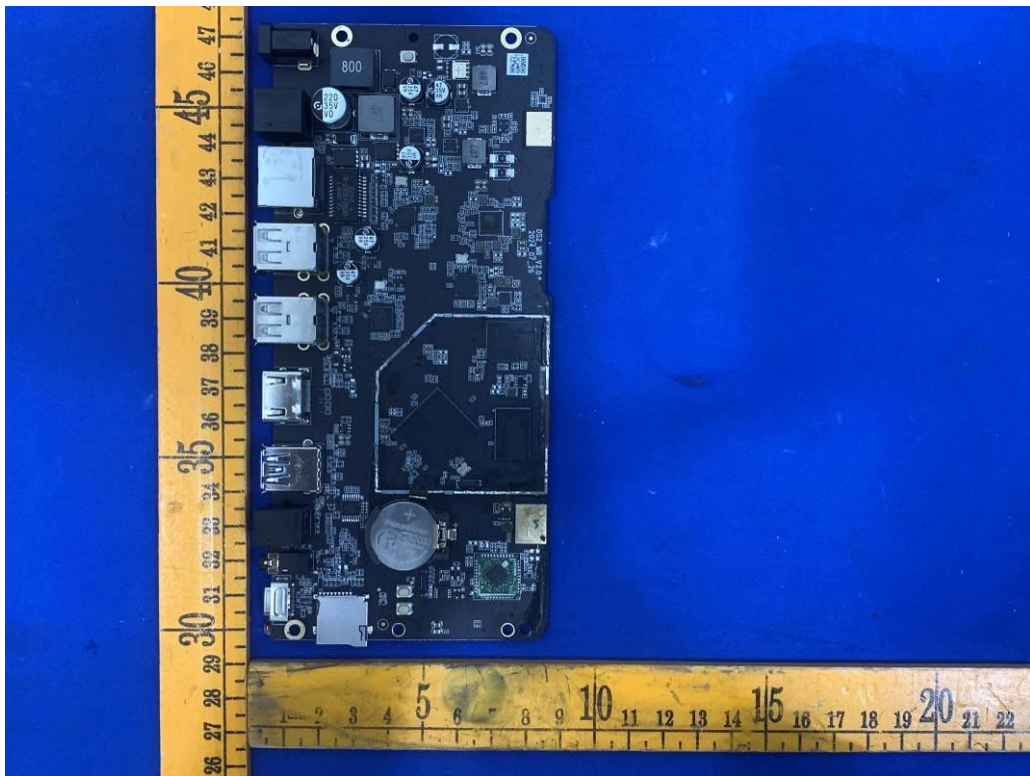

Fig. 80

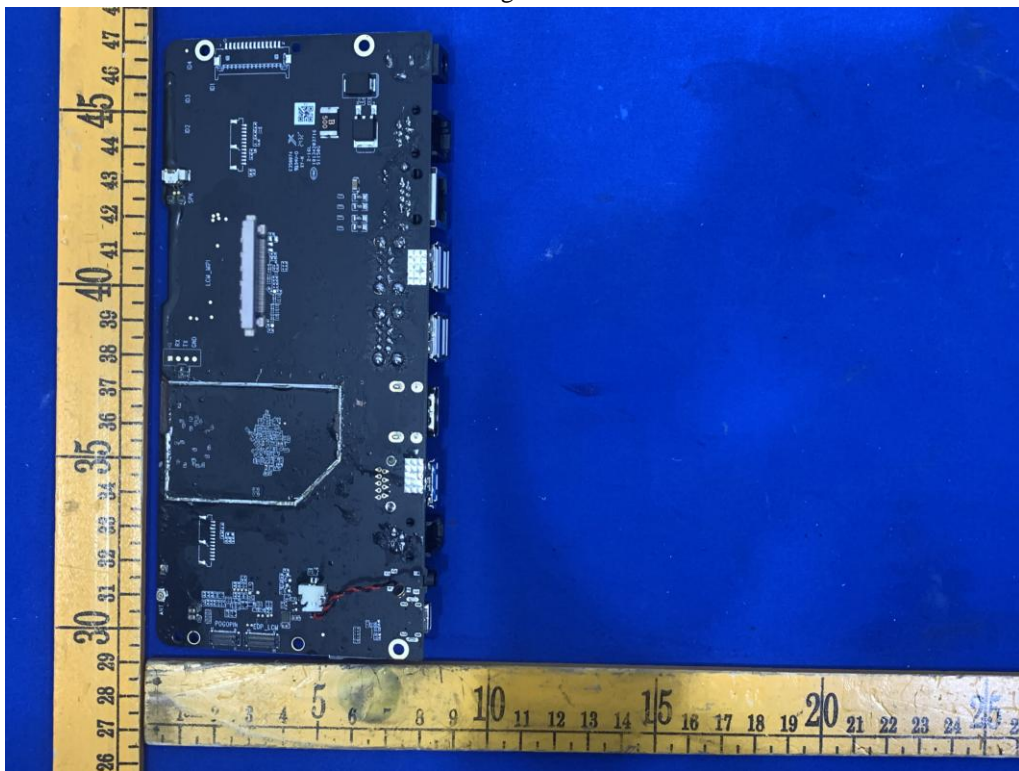

Fig. 81

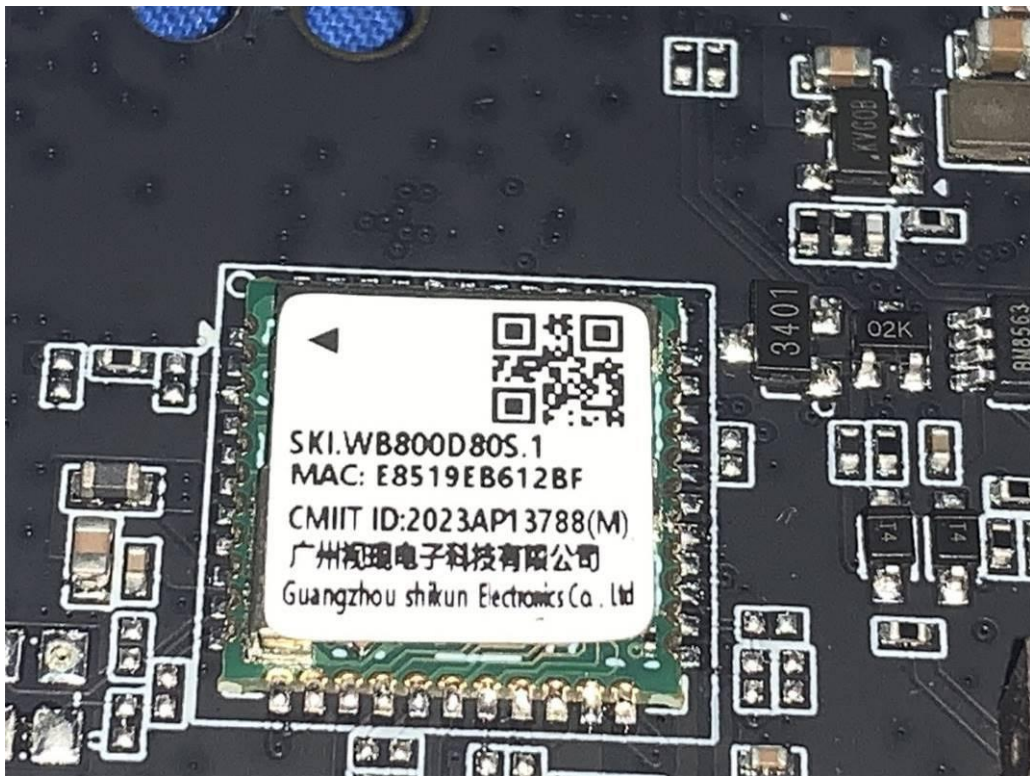

Fig. 82

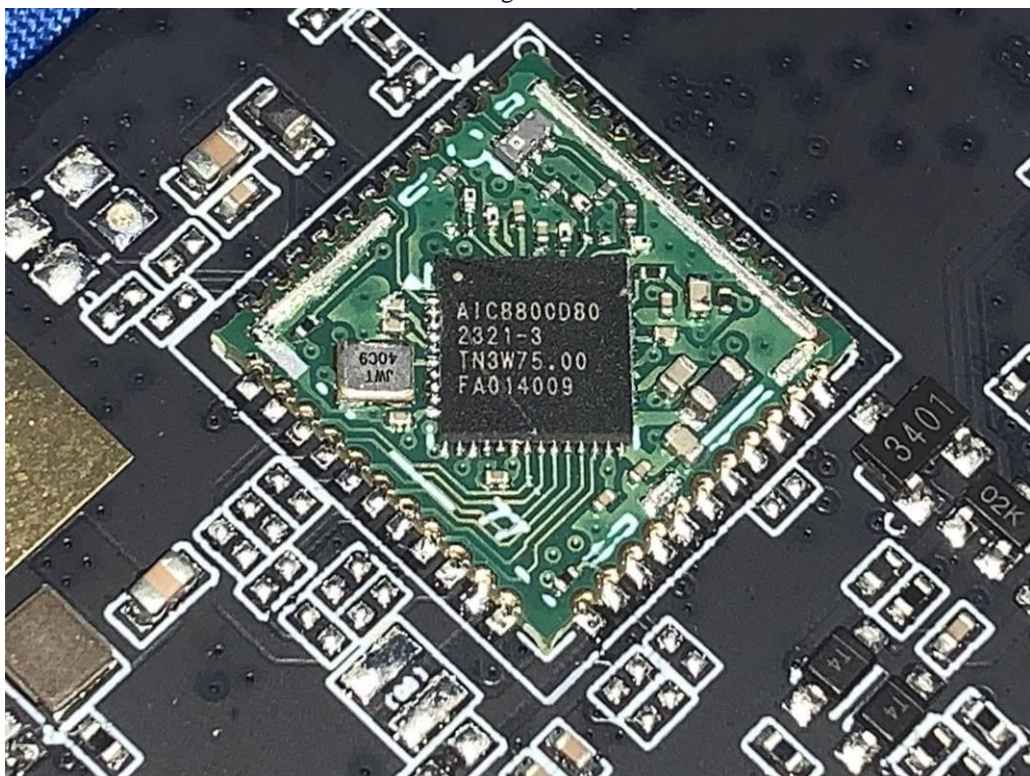

Fig. 83

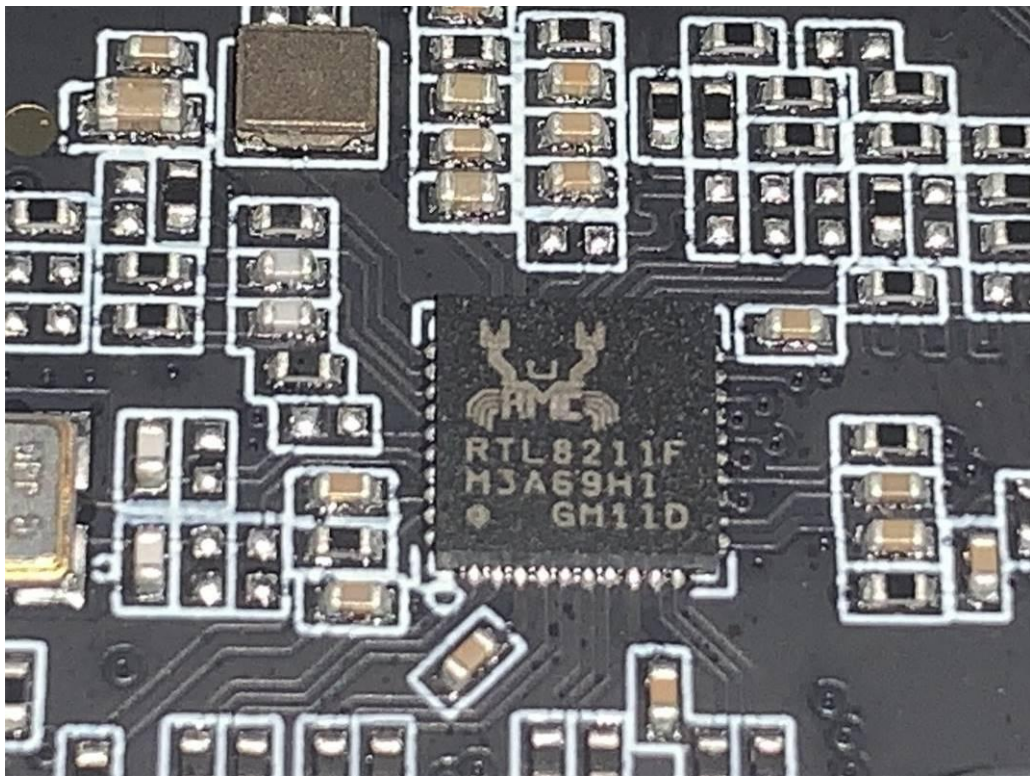

Fig. 84



Fig. 85

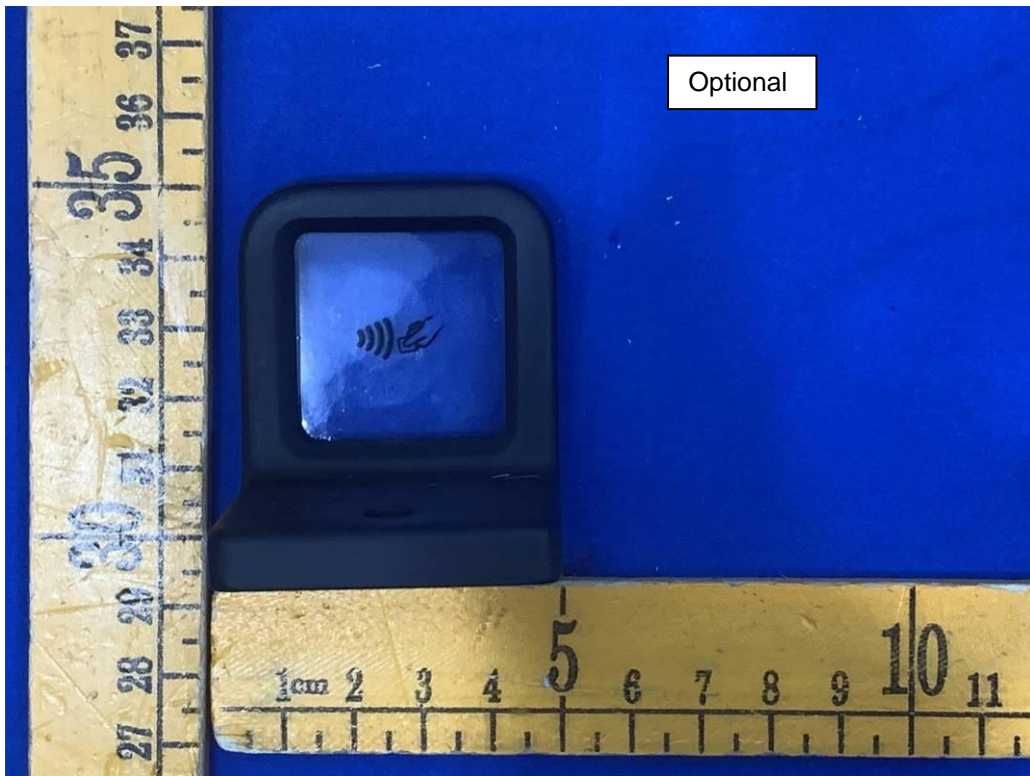

Fig. 86

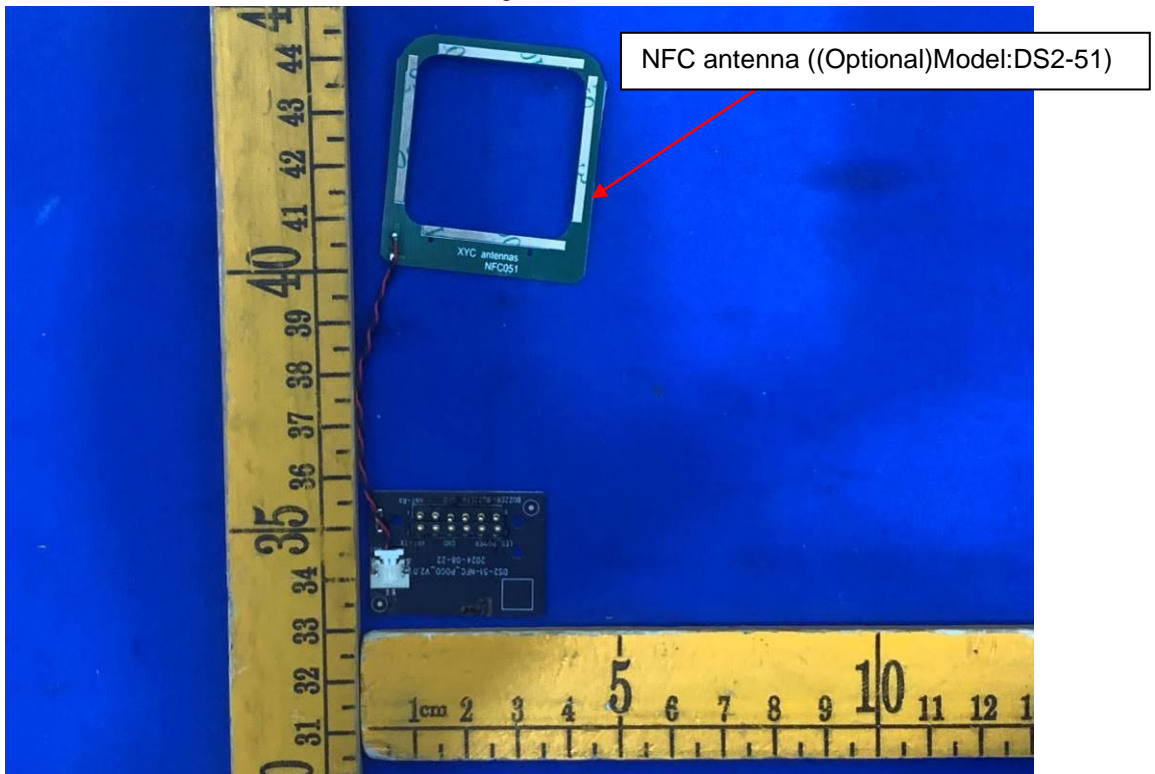

Fig. 87

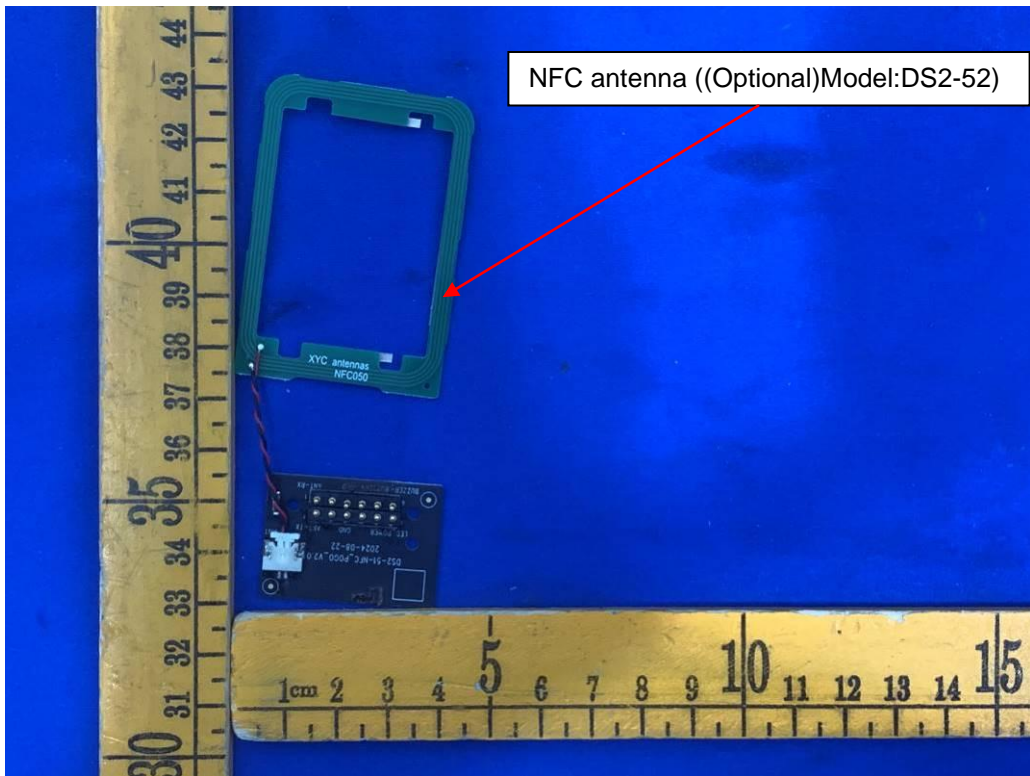

Fig. 88

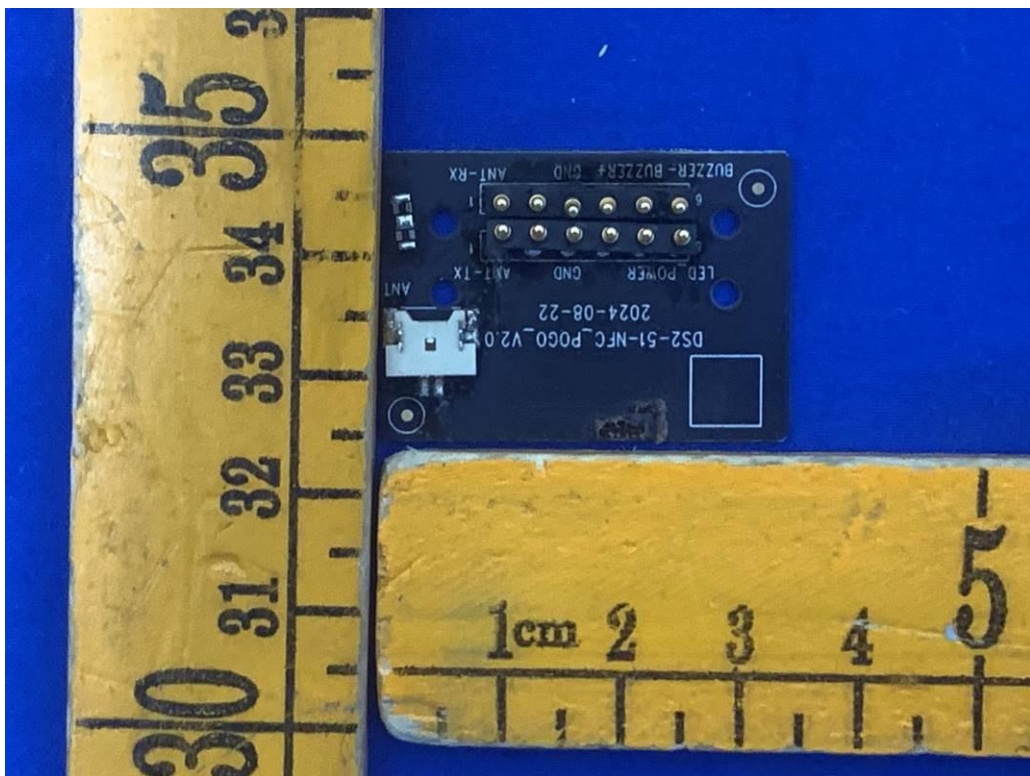

Fig. 89

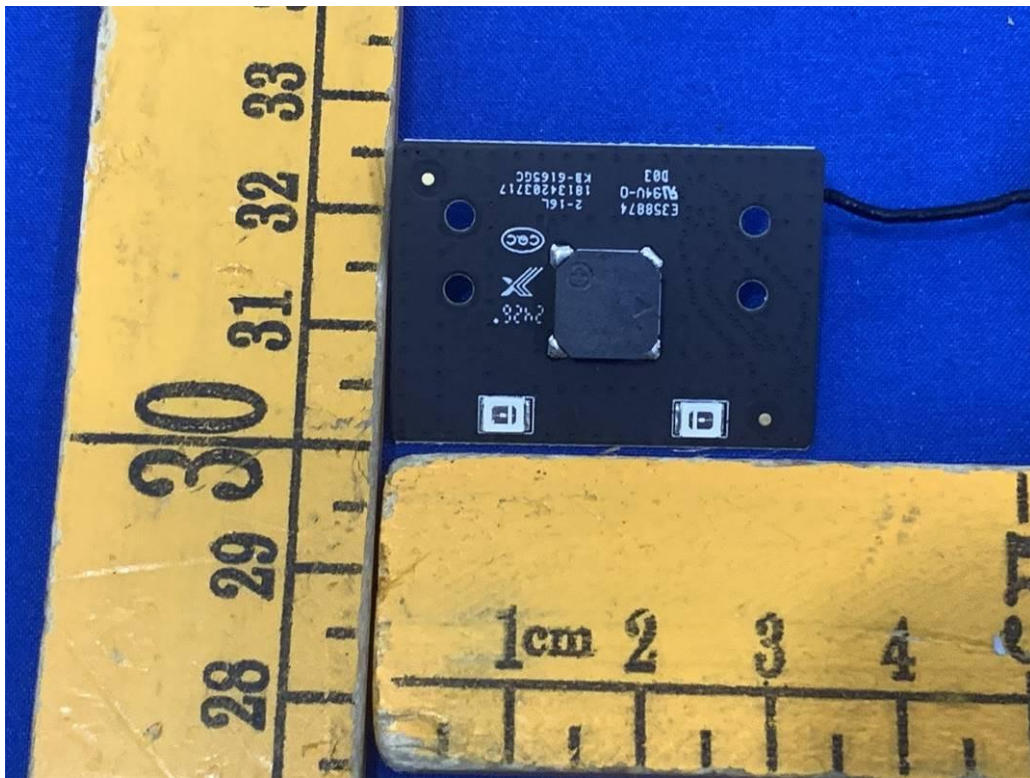

Fig. 90



Fig. 91

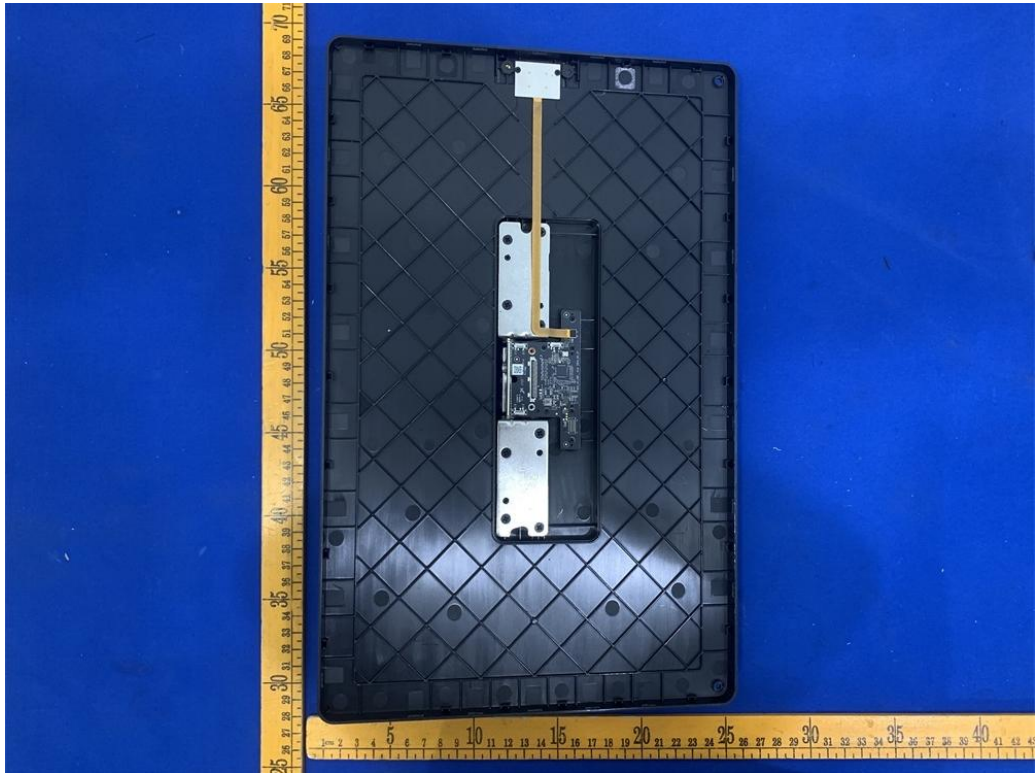

Fig. 92

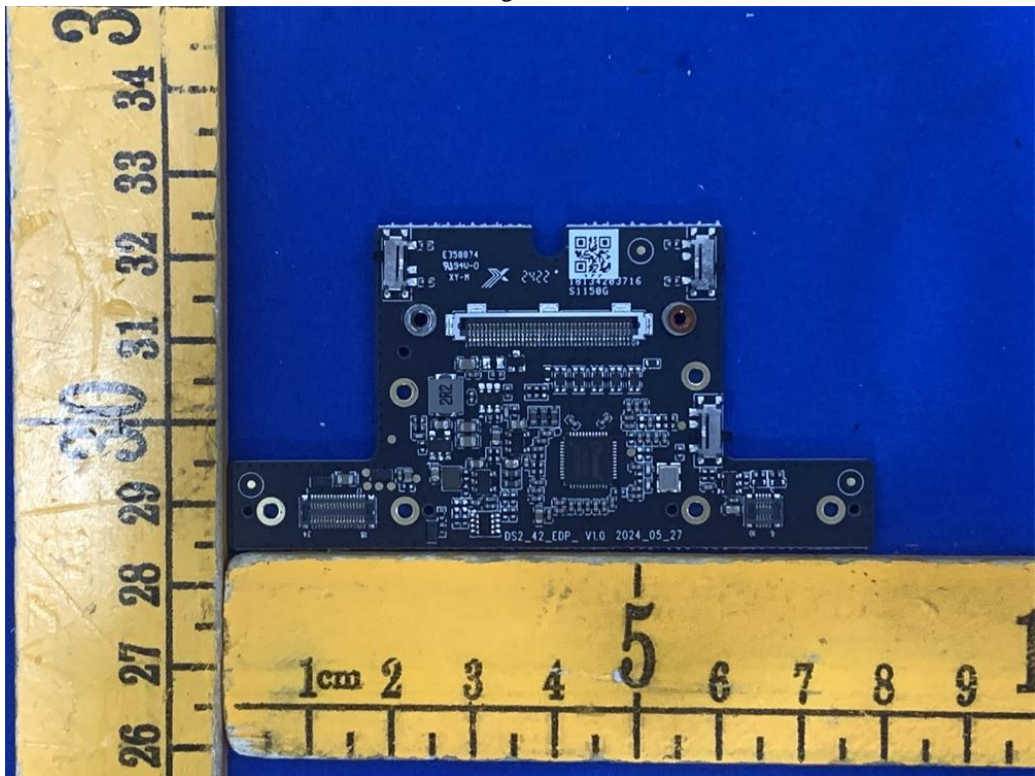

Fig. 93

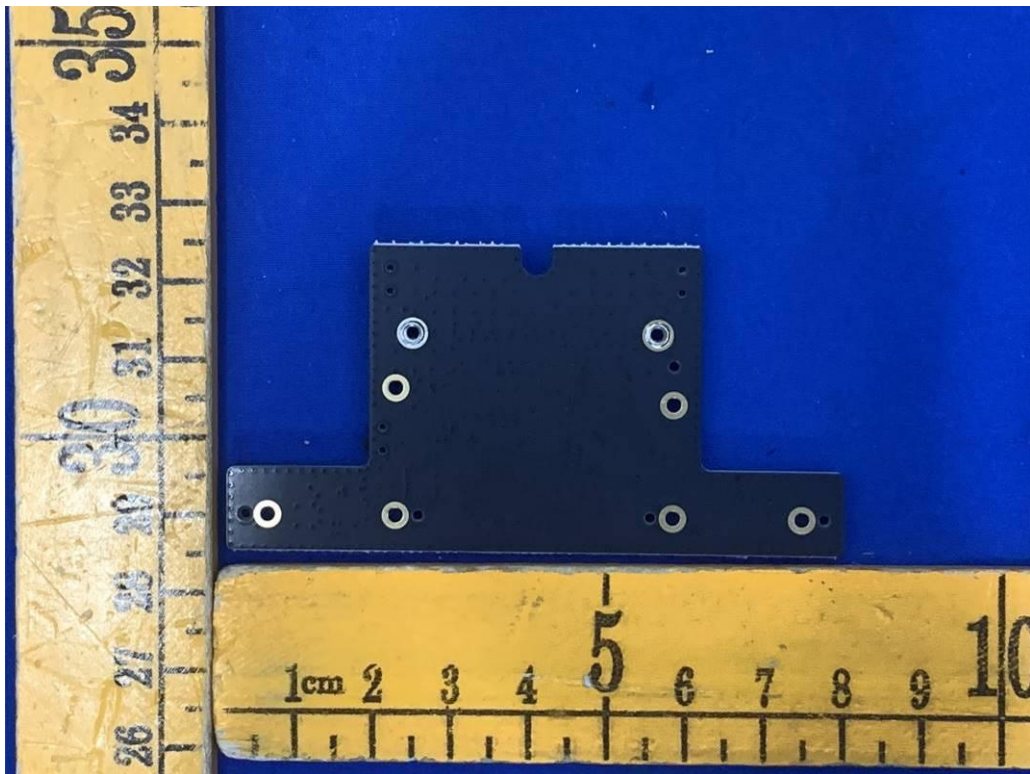

Fig. 94



Fig. 95

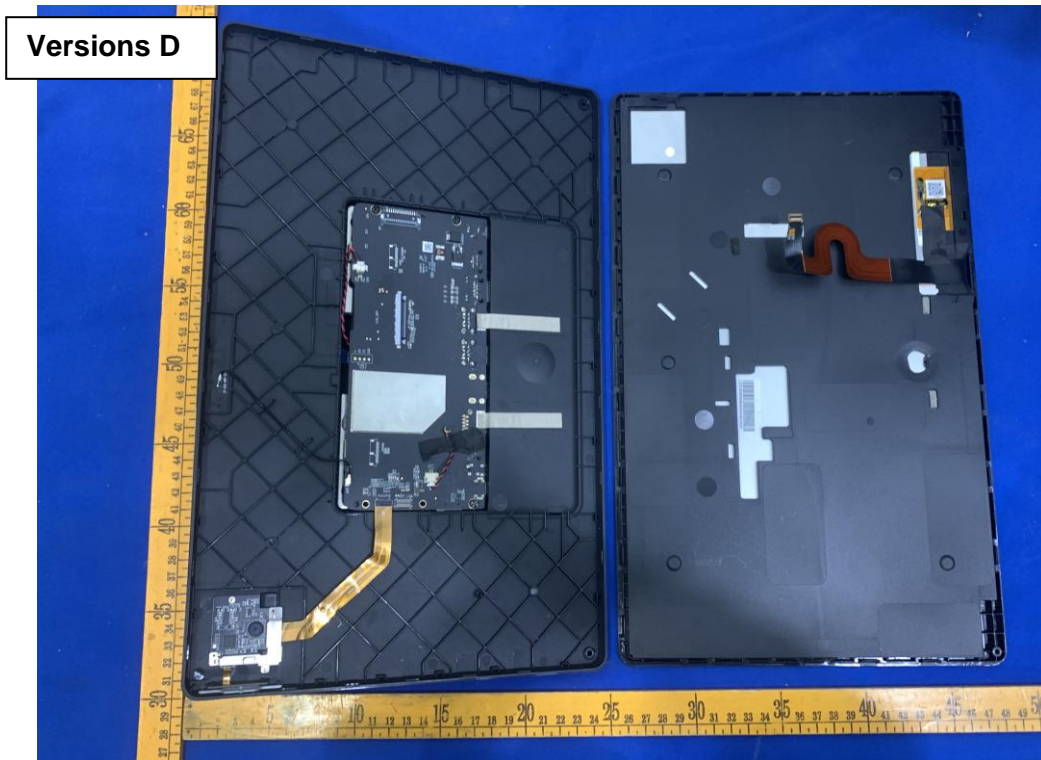

Fig. 96



Fig. 97



Fig. 98

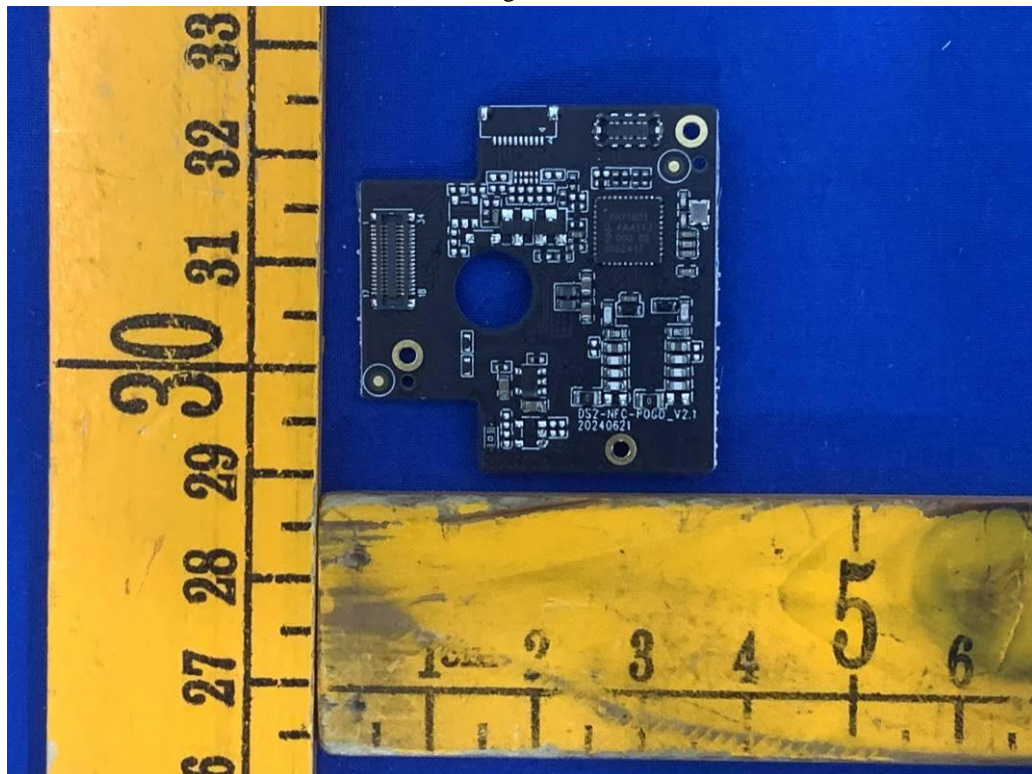

Fig. 99

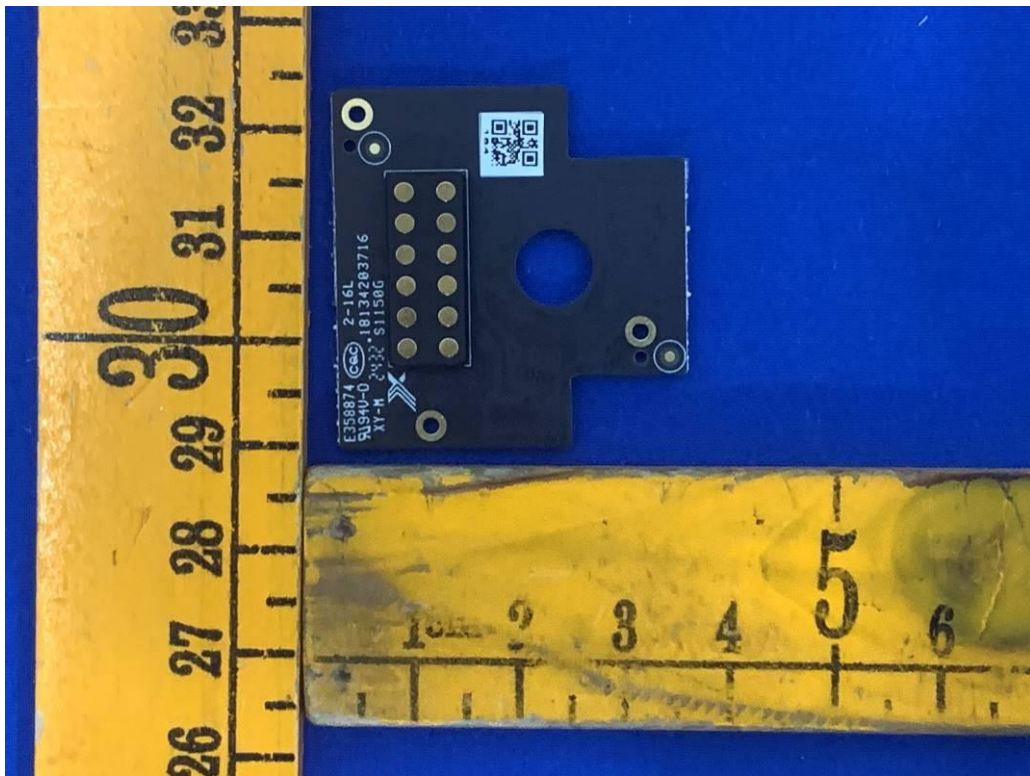

Fig. 100

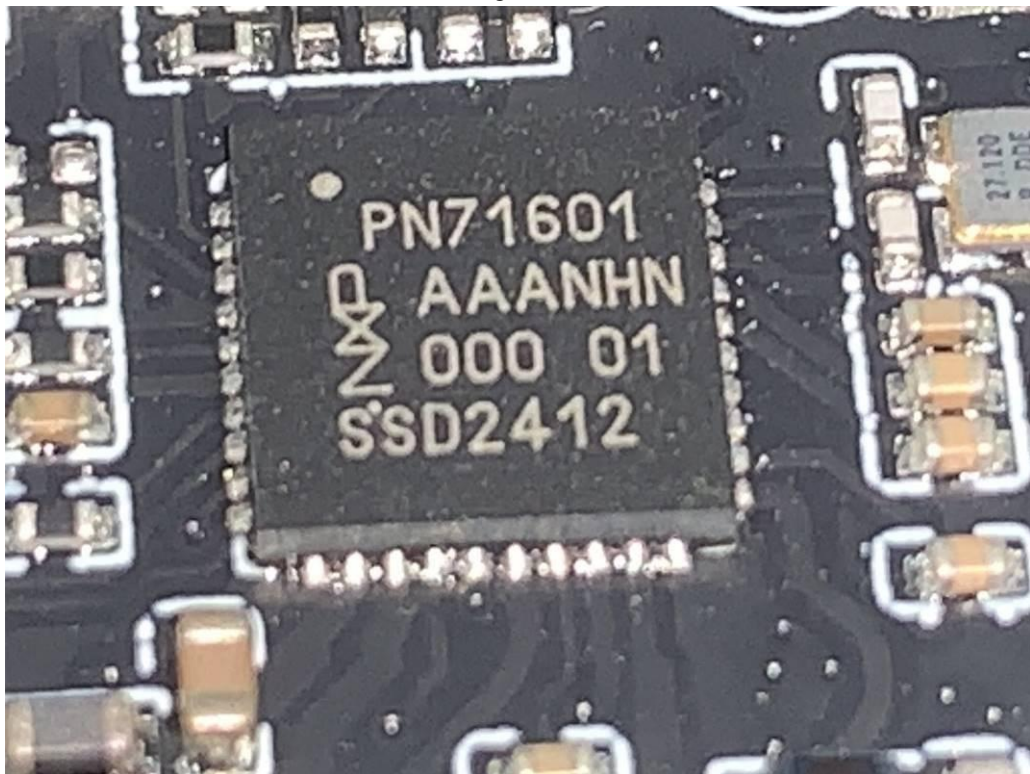

Fig. 101

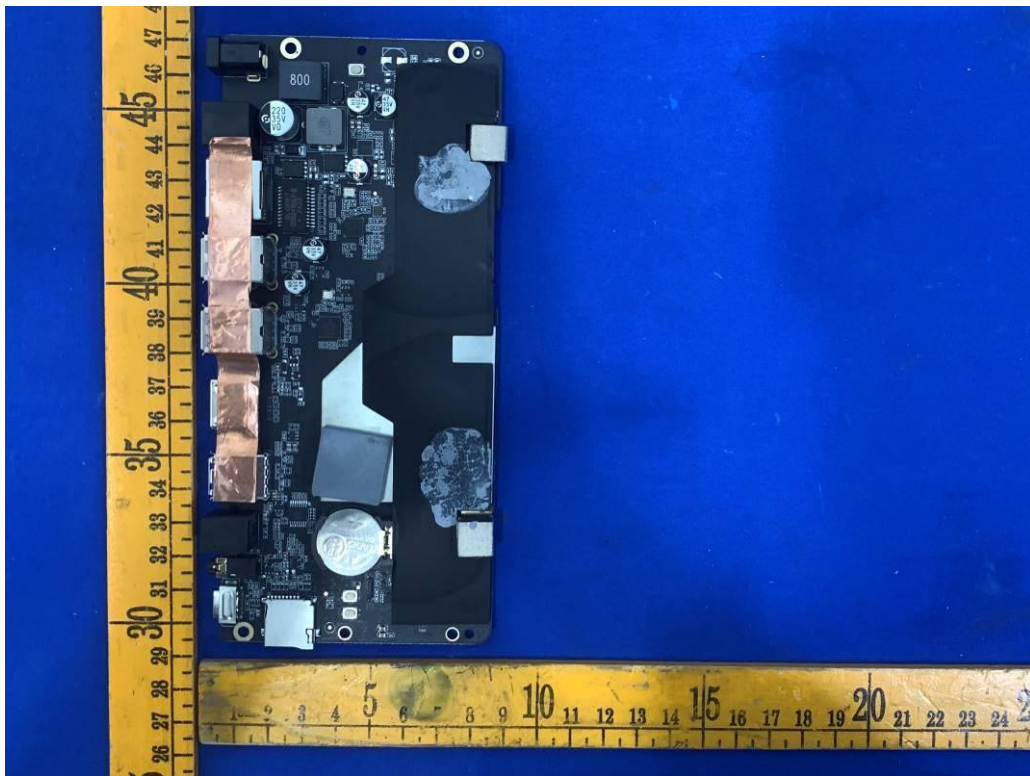

Fig. 102

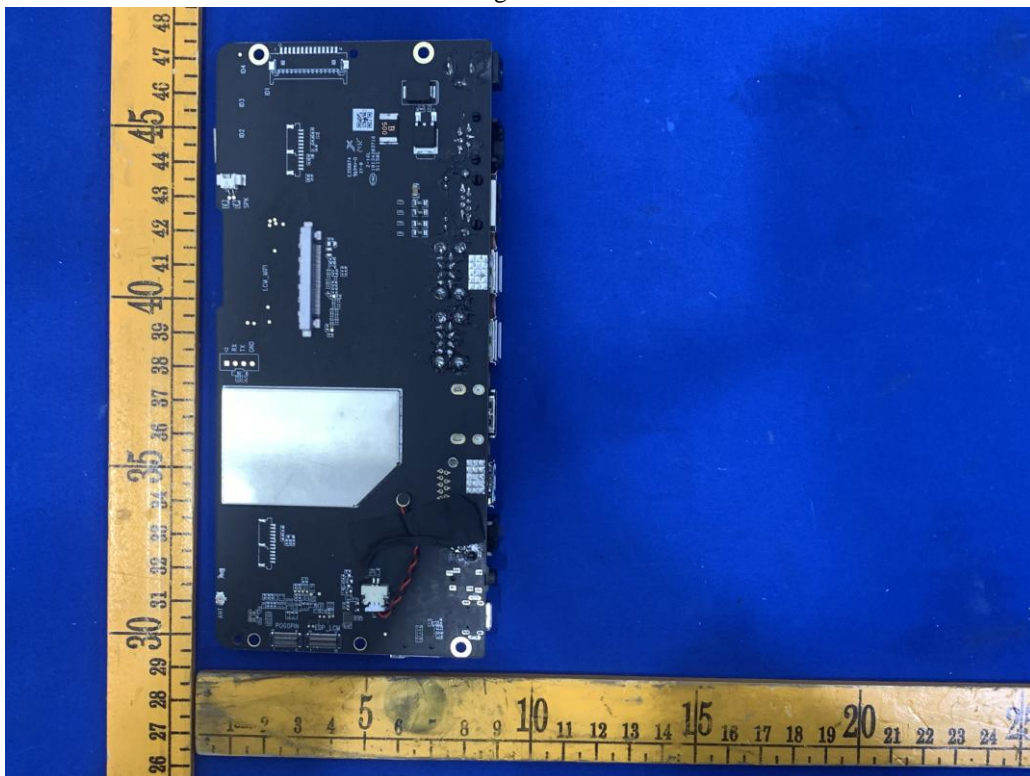

Fig. 103

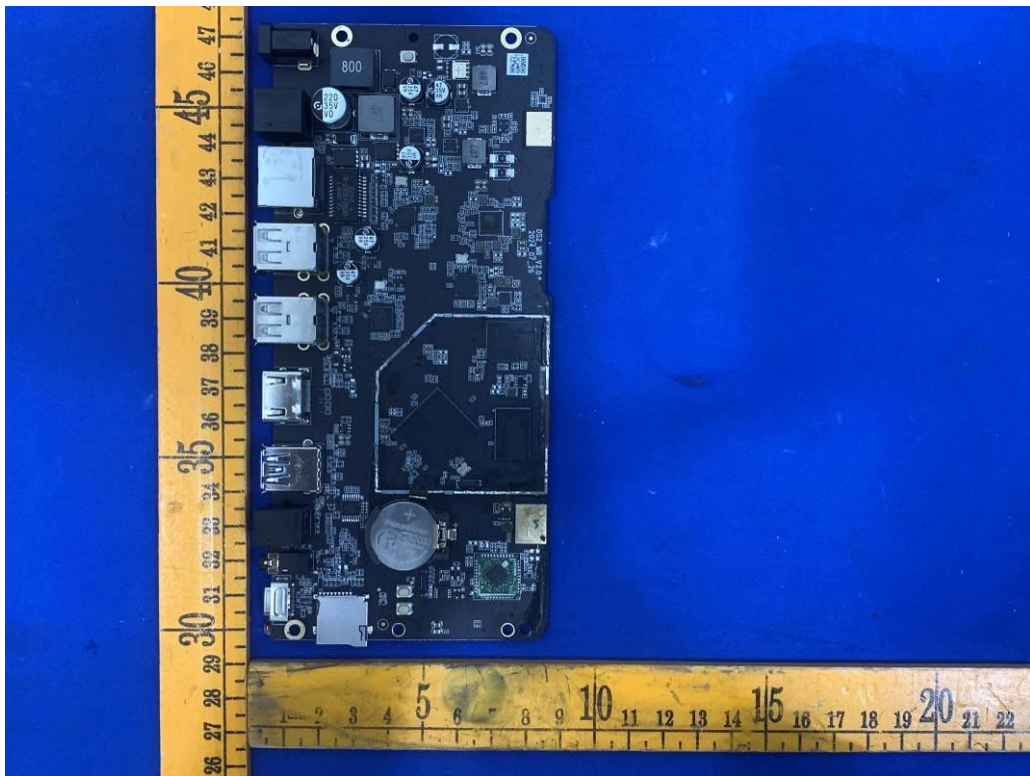

Fig. 104

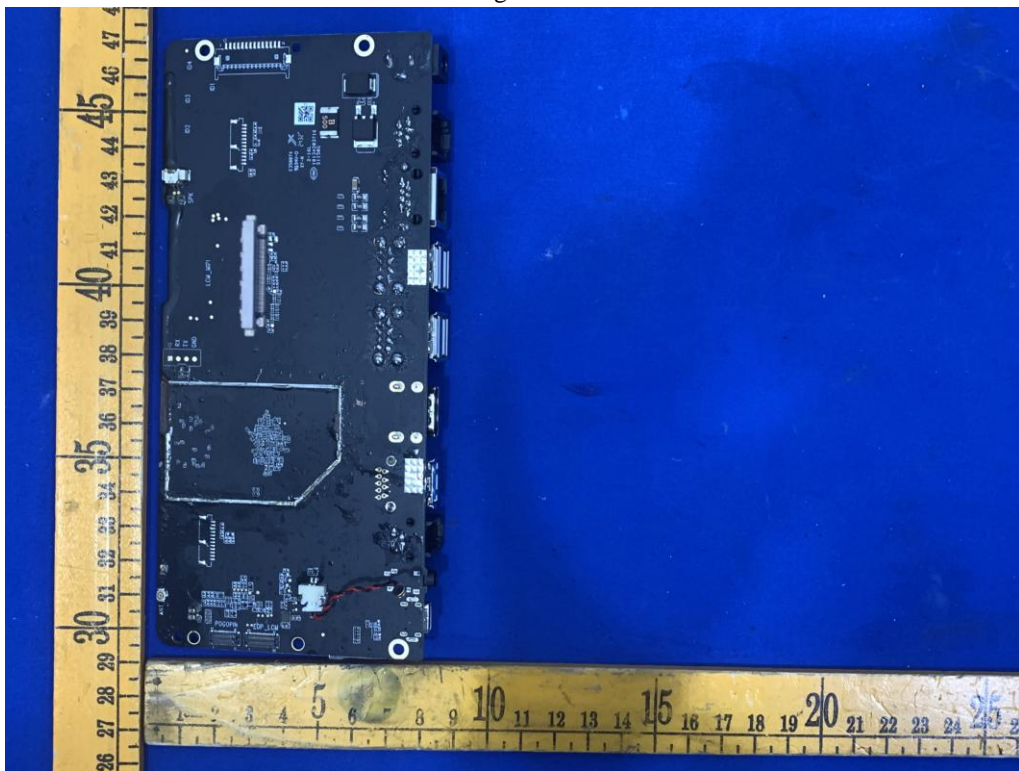

Fig. 105

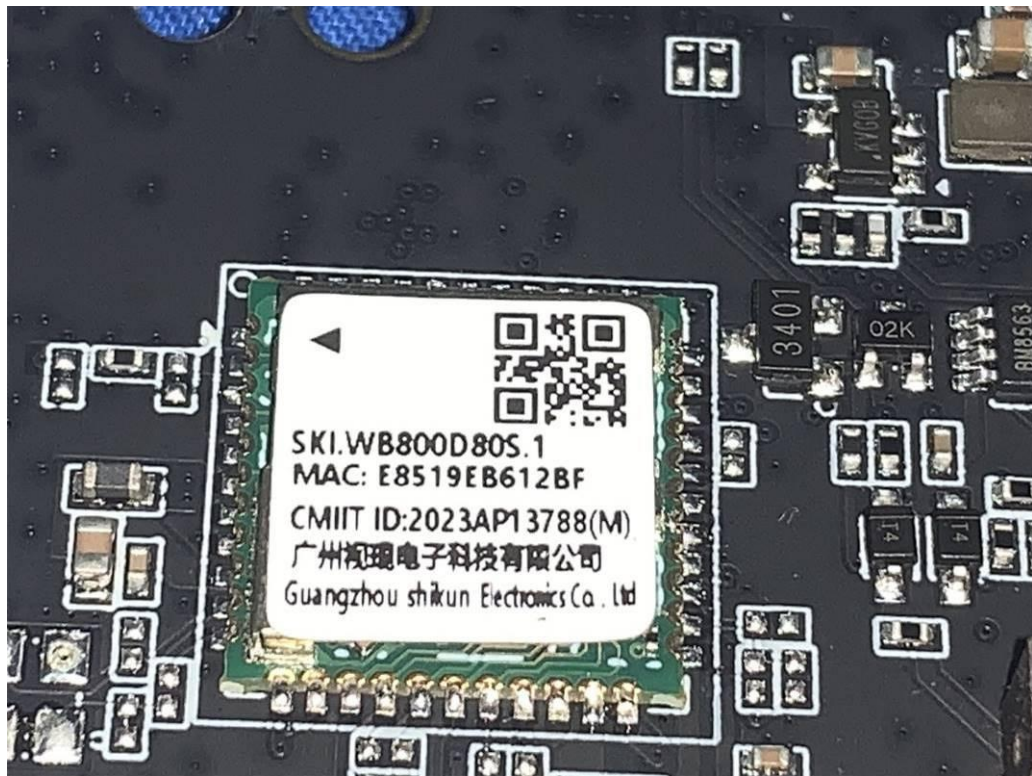

Fig. 106

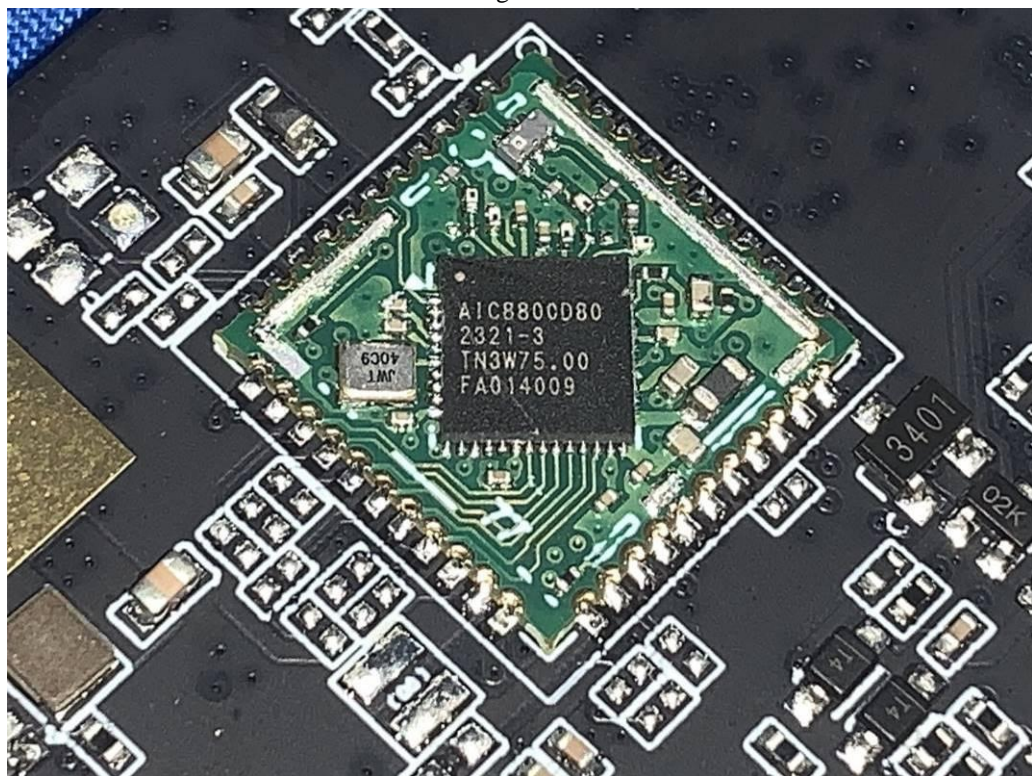

Fig. 107

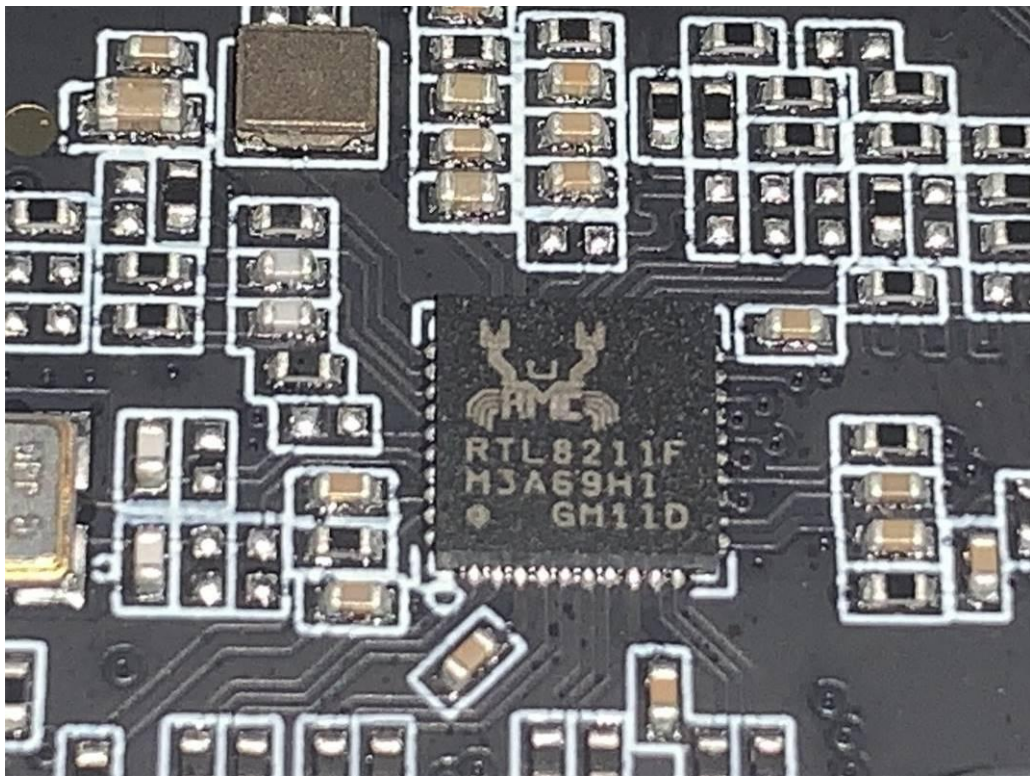

Fig. 108



Fig. 109

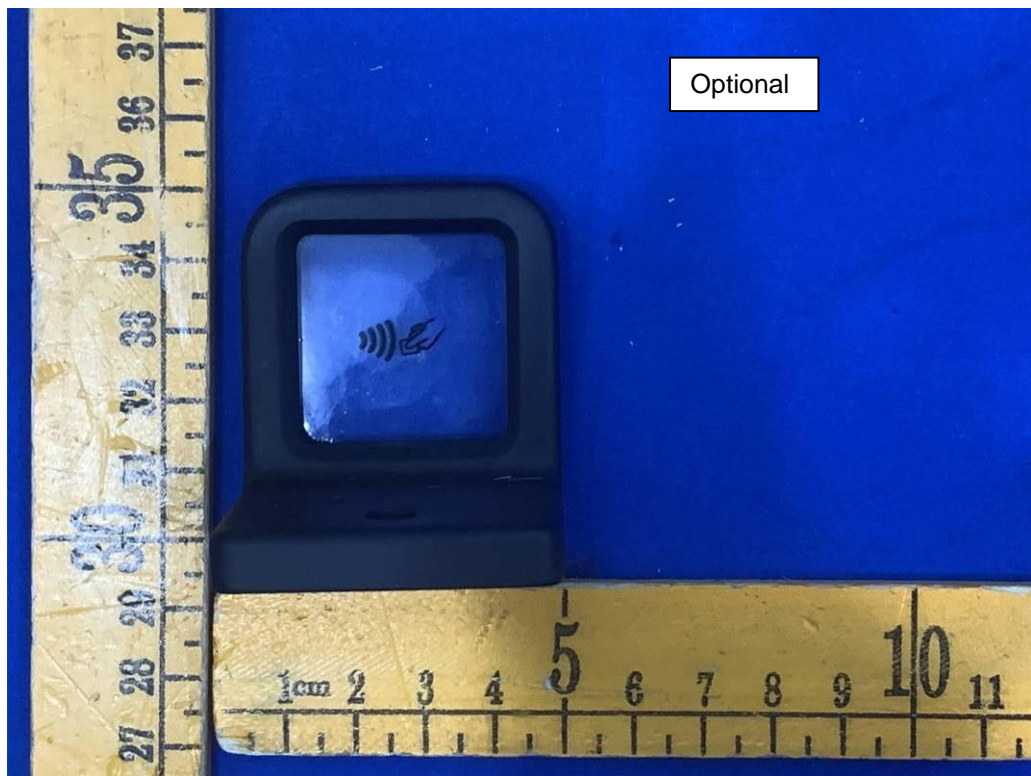

Fig. 110

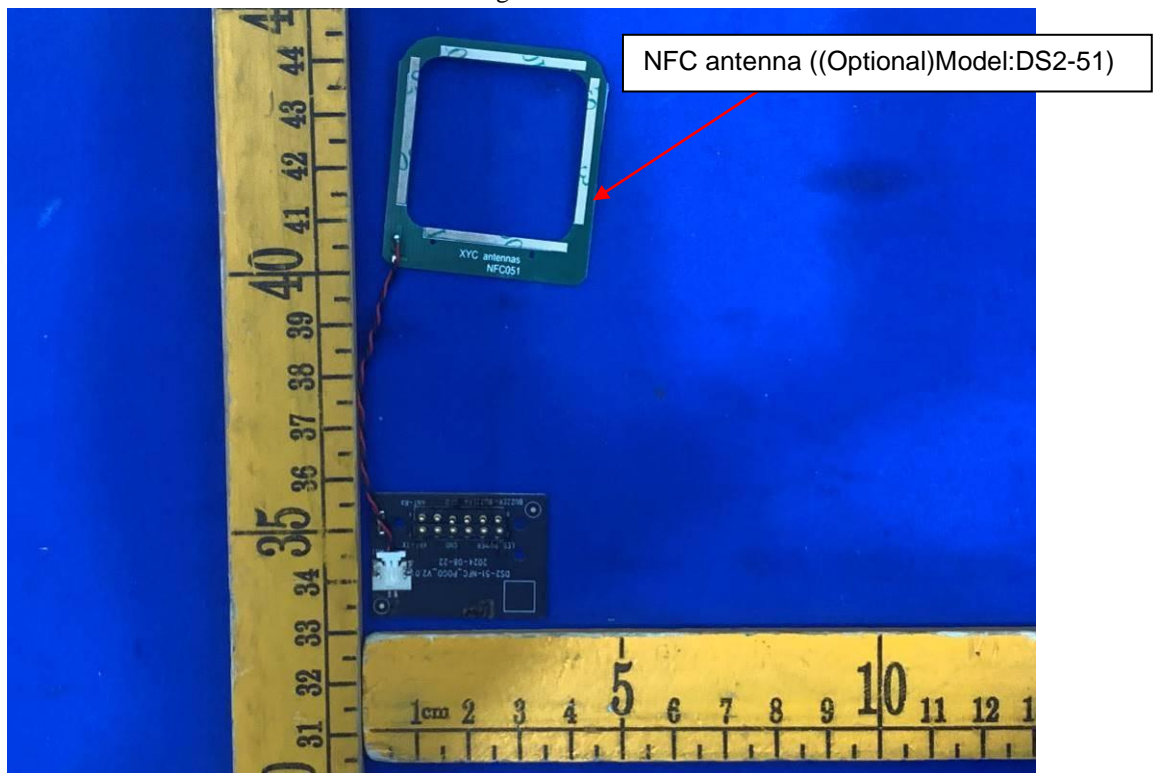

Fig. 111

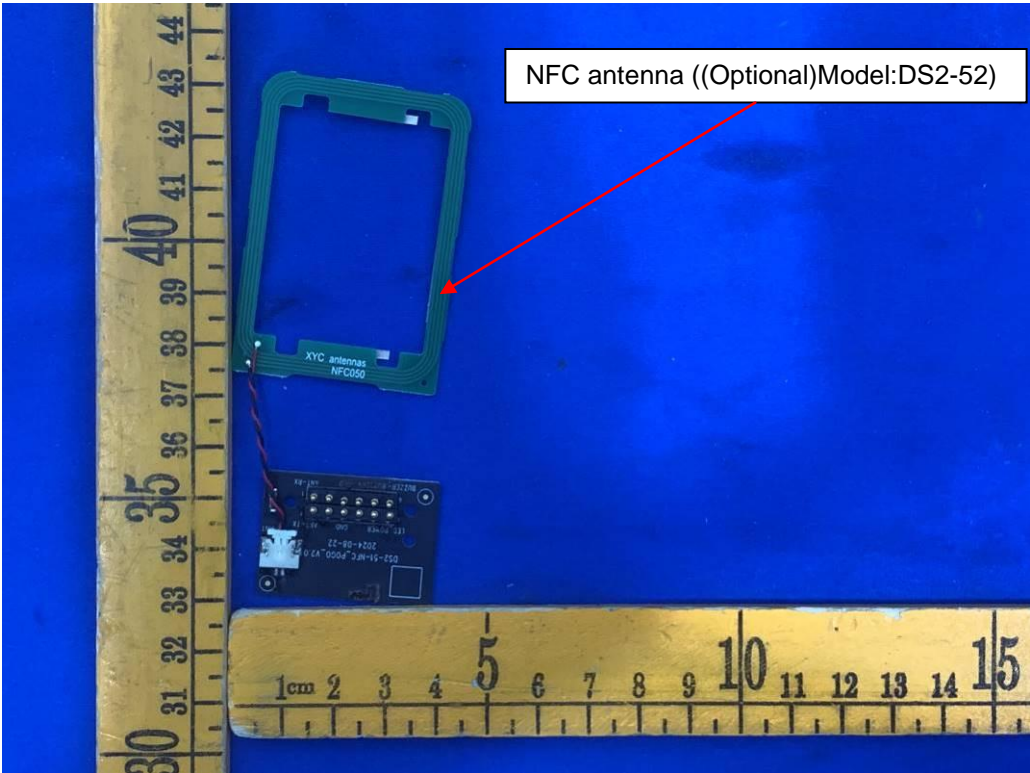

Fig. 112

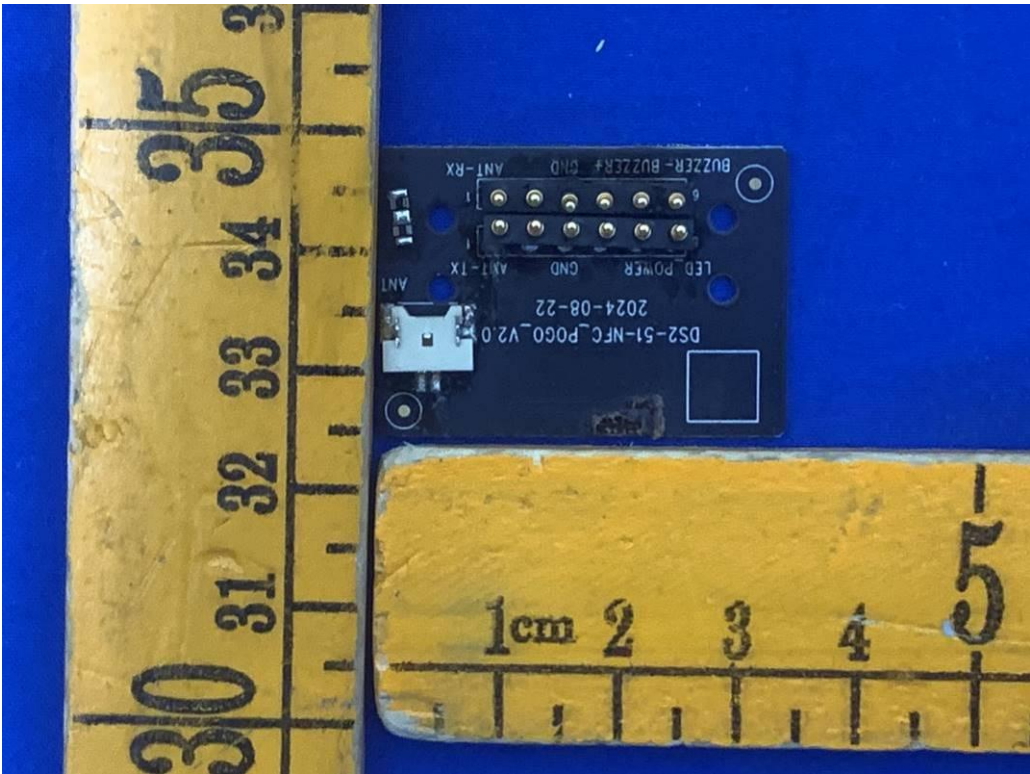

Fig. 113

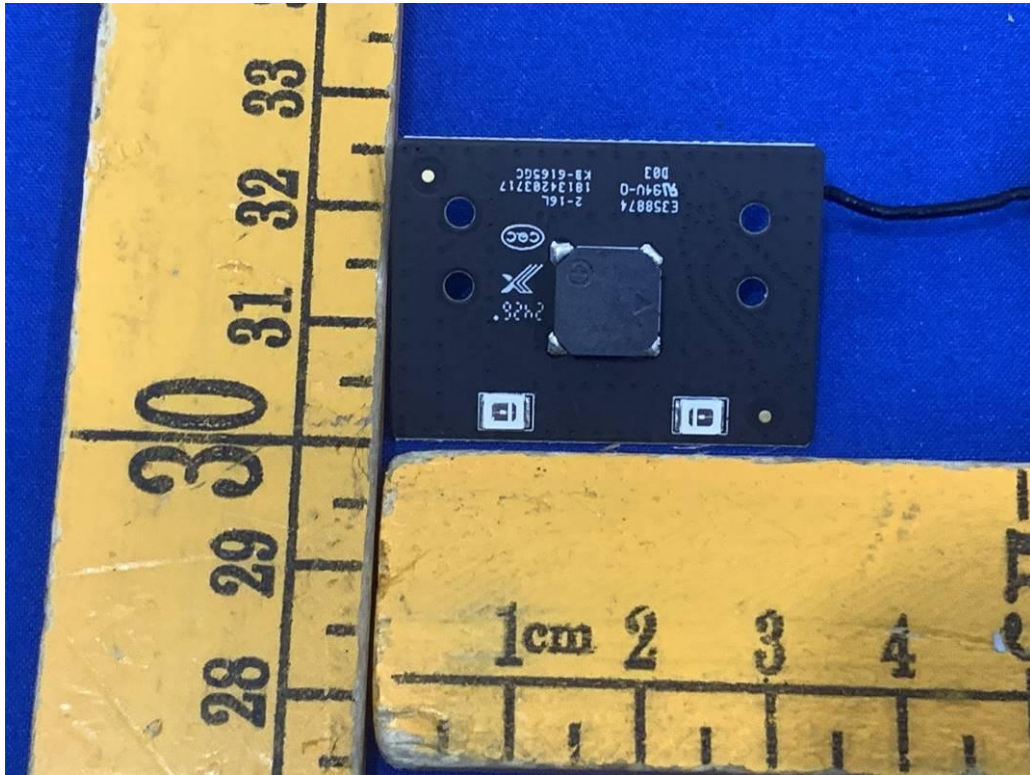

Fig. 114



Fig. 115

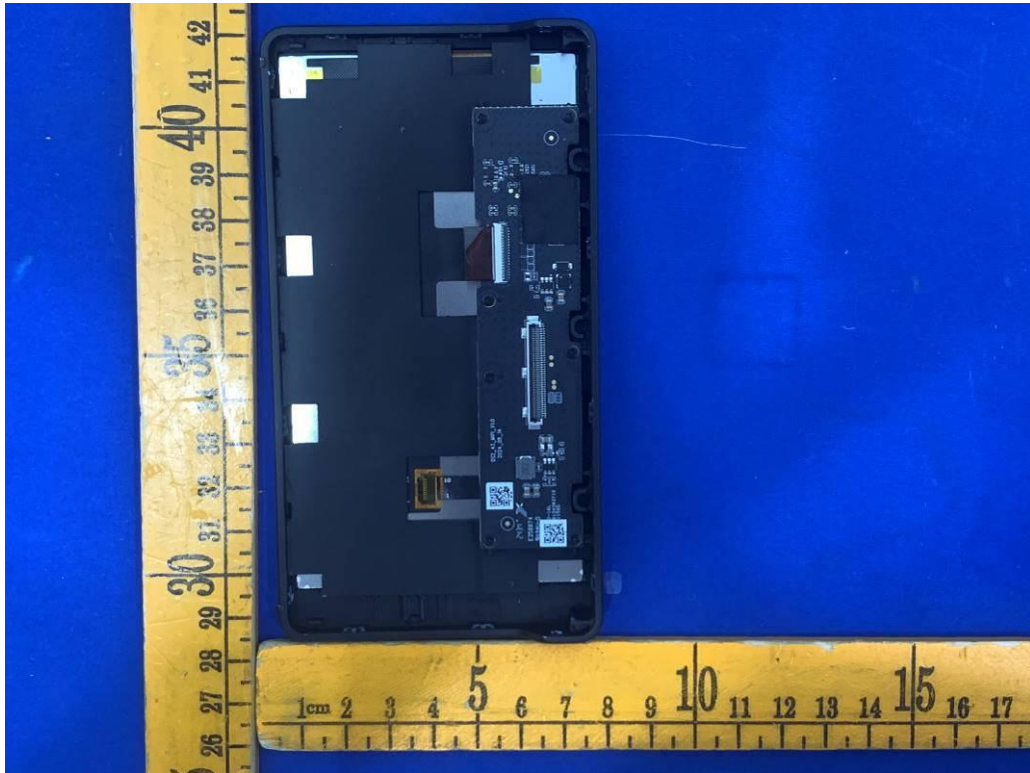

Fig. 116

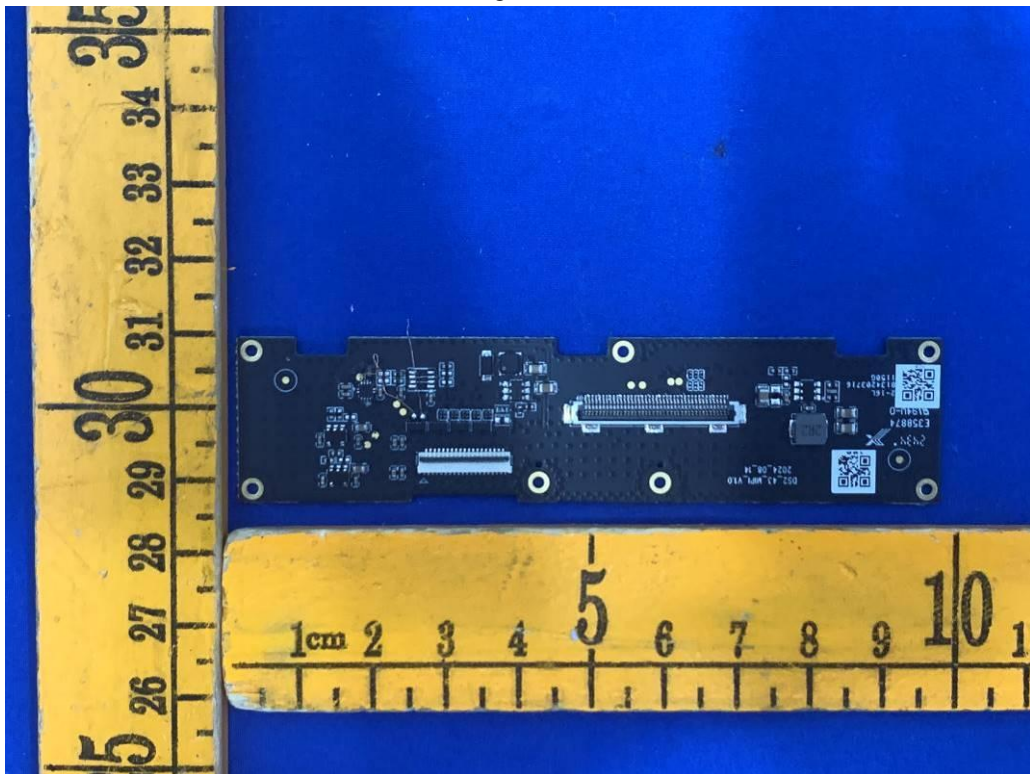

Fig. 117

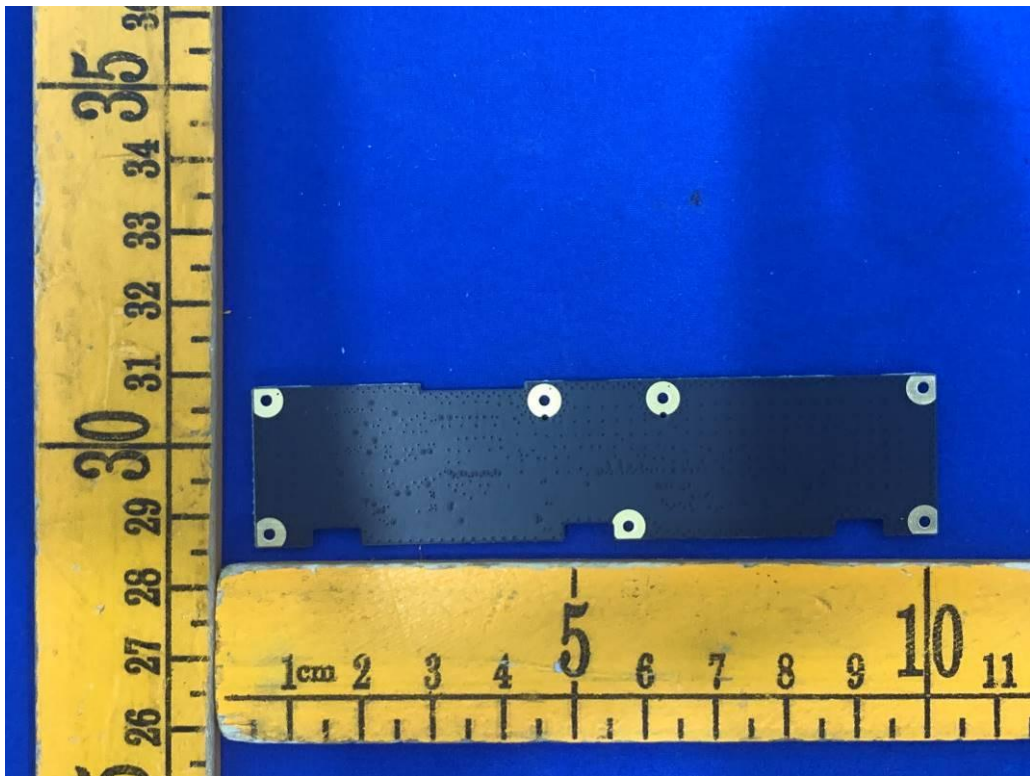

Fig. 118

.....End of Report.....